



8MS Three-phase Synchronous Motors

User's Manual

Version: **1.0 (Sept. 2004)**

Model No.: **MAMOT1-E**

We reserve the right to change the contents of this manual without warning. The information contained herein is believed to be accurate as of the date of publication; however, Bernecker + Rainer Industrie-Elektronik Ges.m.b.H. makes no warranty, expressed or implied, with regards to the products or the documentation contained within this book. In addition, Bernecker + Rainer Industrie-Elektronik Ges.m.b.H. shall not be liable in the event of incidental or consequential damages in connection with or resulting from the furnishing, performance, or use of these products. The software names, hardware names, and trademarks contained in this document are registered by the respective companies.



Chapter 1: General Information

Chapter 2: Technical Data

Chapter 3: Installation

Chapter 4: Wiring

Chapter 5: Standards and Certifications

Images





Table Index

Index

Model Number Index



Chapter 1: General Information	11
1. 8MS Three-phase Synchronous Motors	11
1.1 Feedback Systems Specified to Meet your Needs	12
1.2 Embedded Parameter Chip	13
1.3 Smooth Surface	13
1.4 Connection Technology	13
1.5 Custom Configurations	14
2. Safety Guidelines	15
2.1 General Information	15
2.2 Intended Use	16
2.3 Transport and Storage	16
2.4 Installation	16
2.5 Operation	17
2.5.1 Protection Against Coming into Contact with Electrical Parts	17
2.5.2 Protection from Dangerous Movements	18
2.5.3 Protection from Burns	19
2.6 Safety notices	19
Chapter 2: Technical Data	21
1. 8MS Three-phase Synchronous Motors	21
1.1 General Description	21
1.1.1 Cooling Types	22
1.1.2 Sizes	22
1.1.3 Lengths	23
1.2 Motor Encoder Systems	24
1.2.1 EnDat Encoder	24
1.2.2 Resolver	25
1.3 Motor Options	26
1.3.1 Rated Speed	26
1.3.2 Oil Seal	27
1.3.3 Holding Brake	27
1.3.4 Type of Motor Shaft	28
1.3.5 Load Capacity of the Shaft End and Bearing	29
1.3.6 Connection Direction	32
1.3.7 Determining the Order Code for Motor Options (ee)	33
1.4 Special Motor Options	34
1.4.1 "Reinforced A Side Bearing"	34
1.4.2 "24 VDC Fan", "24 VDC Fan + Reinforced A Side Bearing"	35
1.5 Order Key	36
1.5.1 Example Order 1	37
1.5.2 Example Order 2	37
1.6 General Motor Data	38
1.7 Terminology and Formula Symbols	40
1.7.1 Connection Direction, Bearing	40
1.7.2 Definitions for Maximum Shaft Load Diagrams	40
1.7.3 Formula Symbols	40

Table of contents

1.8 Motor Data Overview Cooling Type A	43
1.9 Motor Data 8MSA2	48
1.9.1 Technical Data	48
1.9.2 Speed-Torque Characteristic Curves with 400 VAC Supply Voltage	49
1.9.3 Dimensions	51
1.9.4 Maximum Shaft Load	52
1.10 Motor Data 8MSA3	53
1.10.1 Technical Data	53
1.10.2 Speed-Torque Characteristic Curves with 400 VAC Supply Voltage	54
1.10.3 Dimensions	56
1.10.4 Maximum Shaft Load	57
1.11 Motor Data 8MSA4	58
1.11.1 Technical Data	58
1.11.2 Speed-Torque Characteristic Curves with 400 VAC Supply Voltage	59
1.11.3 Dimensions	61
1.11.4 Maximum Shaft Load	62
1.12 Motor Data 8MSA5	63
1.12.1 Technical Data	63
1.12.2 Speed-Torque Characteristic Curves with 400 VAC Supply Voltage	64
1.12.3 Dimensions	67
1.12.4 Maximum Shaft Load	68
1.13 Motor Data 8MSA6	69
1.13.1 Technical Data	69
1.13.2 Speed-Torque Characteristic Curves with 400 VAC Supply Voltage	70
1.13.3 Dimensions	72
1.13.4 Maximum Shaft Load	73
1.14 Motor Data 8MSA7	74
1.14.1 Technical Data	74
1.14.2 Speed-Torque Characteristic Curves with 400 VAC Supply Voltage	75
1.14.3 Dimensions	77
1.14.4 Maximum Shaft Load	78
1.15 Motor Data 8MSA8	79
1.15.1 Technical Data	79
1.15.2 Speed-Torque Characteristic Curves with 400 VAC Supply Voltage	80
1.15.3 Dimensions	82
1.15.4 Maximum Shaft Load	83
1.16 Motor Data Overview for Cooling Type C	85
1.16.1 Fan Modules	88
1.17 Motor Data 8MSC4	89
1.17.1 Technical Data	89
1.17.2 Speed-Torque Characteristic Curves with 400 VAC Supply Voltage	90
1.17.3 Dimensions	92
1.17.4 Maximum Shaft Load	93
1.18 Motor Data 8MSC5	94
1.18.1 Technical Data	94
1.18.2 Speed-Torque Characteristic Curves with 400 VAC Supply Voltage	95
1.18.3 Dimensions	98

1.18.4 Maximum Shaft Load	99
1.19 Motor Data 8MSC6	100
1.19.1 Technical Data	100
1.19.2 Speed-Torque Characteristic Curves with 400 VAC Supply Voltage	101
1.19.3 Dimensions	103
1.19.4 Maximum Shaft Load	104
1.20 Motor Data 8MSC7	105
1.20.1 Technical Data	105
1.20.2 Speed-Torque Characteristic Curves with 400 VAC Supply Voltage	106
1.20.3 Dimensions	108
1.20.4 Maximum Shaft Load	109
2. Cables	110
2.1 General Information	110
2.1.1 Prefabricated Cables	110
2.2 Motor Cables	111
2.2.1 Order Data	111
2.2.2 Technical Data	113
2.3 EnDat Cable	115
2.3.1 Order Data	115
2.3.2 Technical Data	115
2.4 Resolver Cables	117
2.4.1 Order Data	117
2.4.2 Technical Data	117
3. Connectors	119
3.1 General Information	119
3.2 Motor Connectors	120
3.2.1 Order Data	120
3.2.2 Technical data for 8PM001.00-1 and 8PM002.00-1	121
3.2.3 Technical data for 8PM003.00-1	122
3.3 Encoder Connectors	123
3.3.1 Order Data	123
3.3.2 Technical data for EnDat connector 8PE001.00-1	124
3.3.3 Technical data for resolver connector 8PR001.00-1	125
Chapter 3: Installation	127
1. General Information	127
1.1 Mounting the Drive Elements	127
1.2 Connection Plug	128
2. Detailed Dimensions	129
2.1 Detailed Dimensions for "Top" Connection Direction	129
2.1.1 Motor Connection	129
2.1.2 Encoder Connection	129
2.2 Detailed Dimensions for "A Side", "B Side" Connection Directions	130
2.2.1 Motor Connection	130
2.2.2 Encoder Connection	130
2.3 Outer Dimensions of the Connectors	131

Chapter 4: Wiring	133
1. Pin assignments 8MS	133
1.1 Motor cable attachment	133
1.1.1 8MSA2...8MSA7	133
1.1.2 8MSA8	134
1.2 Encoder cable attachment	134
1.2.1 EnDat	134
1.2.2 Resolver	135
1.3 Fan Connection	135
1.3.1 Terminal Block Pin Assignments for 220 VAC Fan	136
1.3.2 Terminal Block Pin Assignments for 24 VDC Fan	136
2. Cables	137
2.1 Motor Cables	137
2.1.1 Motor Cable Construction	137
2.1.2 Pin assignments for 8CMxxx.12-1, 8CMxxx.12-3	138
2.1.3 Cable Schematic for 8CMxxx.12-1, 8CMxxx.12-3	138
2.1.4 Pin Assignments for 8CMxxx.12-5	139
2.1.5 Cable Schematic for 8CMxxx.12-5	139
2.2 EnDat Encoder Cables	140
2.2.1 EnDat Encoder Cable Construction	140
2.2.2 Pin Assignments	140
2.2.3 Cable Schematic	141
2.3 Resolver Cables	142
2.3.1 Resolver Cable Construction	142
2.3.2 Pin Assignments	142
2.3.3 Cable Schematic	143
 Chapter 5: Standards and Certifications	 145
1. Valid European Guidelines	145
2. Valid Standards for Servo Motors	145
3. International Certifications	146
4. Standards, Definitions for Safety Techniques	147

Chapter 1 • General Information

1. 8MS Three-phase Synchronous Motors

B&R 8MS three-phase synchronous motors have been specially developed for use in high-performance applications. They are now being used to produce consumer goods and products in the plastic, packaging, metal, food and beverage industries and then palletize them with material handling systems.

Complete solutions from one source, this requires the right components as well as the right configuration for the application environment. The large selection of available 8MS three-phase synchronous motors makes it possible to easily meet conditions such as reducing the variety of parts, guaranteeing ease of service and maintaining minimum requirements on space.



Figure 1: 8MS three-phase synchronous motors

An optimally configured drive rounds off a successful design. To meet this goal, specialists are available in B&R subsidiaries all over the world who are eager to share their know-how in the area of mechatronics.

B&R automation components, the economical combination of mechanics, electronics, technology and innovation.

1.1 Feedback Systems Specified to Meet your Needs

The 8MS three-phase synchronous motors are available with different encoder systems. As standard, they are equipped with EnDat encoders. Depending on the application, the customer can select between normal and high-resolution encoders. Both types are also available as multi-turn encoders. They allow operation without requiring homing procedures or additional measurement systems on the work piece. The absolute encoder functions without a battery and is therefore absolutely maintenance free.

The 8MS three-phase synchronous motors are also available with resolvers for machines with lower precision and speed requirements.

1.2 Embedded Parameter Chip

All relevant mechanical and electrical information and data is stored in the encoder used for the 8MS three-phase synchronous motors. This means that the user doesn't have to make settings on the servo drive in the field. As soon as the encoder is connected to the servo drive and the power is applied to the electronics, the motor is automatically identified. The motor sends the nominal and limit parameters to the servo drive. Then the drive automatically determines the current limits and current control parameters required for optimal control of the motor. The user only has to optimize the speed and position controller. The integrated start-up environment in B&R Automation Studio™ provides assistance.

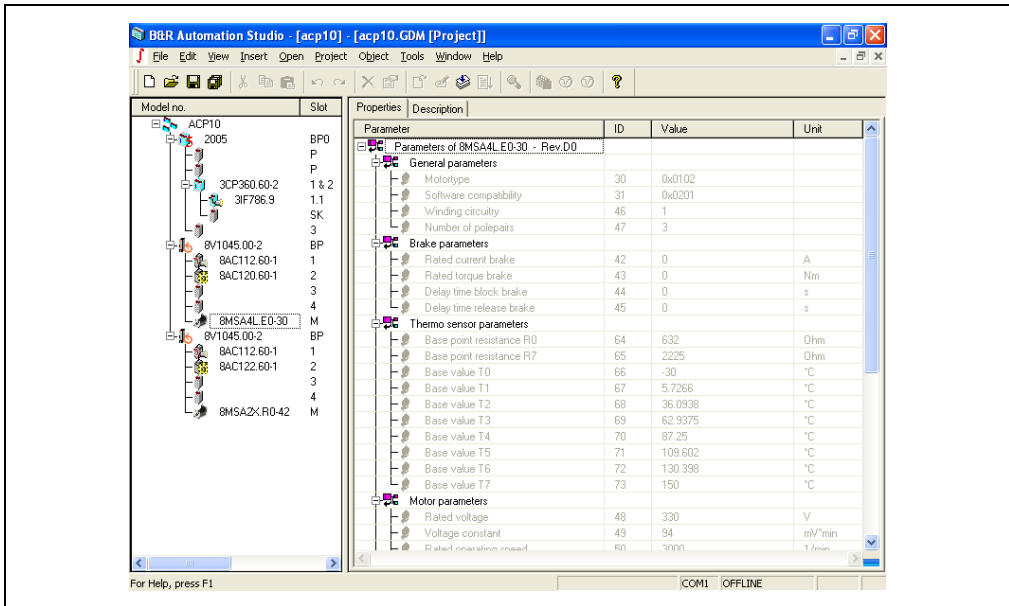

Figure 2: Start-up with B&R Automation Studio™

In addition to start-up assistance, routine service work is also made easier and motors can be exchanged without having to take extra time to set parameters.

1.3 Smooth Surface

The special construction of the surface of the 8MS three-phase synchronous motors allow them to be used in applications for the food and beverage branch. Depressions where liquid could collect were deliberately avoided.

1.4 Connection Technology

The uniform connection technology, the prefabricated cables and the embedded parameter chip described above allow plug and play operation of the power transmission system.

1.5 Custom Configurations

B&R has already developed successful projects where a custom drive configuration was required. An example is direct attachment of a pulley to the motor shaft. Using bearings that withstand the high radial forces required by the construction allows the motor and belt drive to be easily installed. High-alloy steel is used to keep the shaft diameter small for trouble free mounting of small belt disks (in spite of heavy loads).

An enthusiastic customer hit the nail on the head: "We are killing two birds with one stone by using this solution. Easier design, smaller installation dimensions, exemplary friendly service and all that with lower costs!".

2. Safety Guidelines

Information:

The following safety guidelines are valid for servo motors and servo drives with regard to uniform handling independent of the manual where they are listed.

2.1 General Information

B&R servo drives and servo motors have been designed, developed and manufactured for conventional use in industry. They were not designed, developed and manufactured for any use involving serious risks or hazards that without the implementation of exceptionally stringent safety precautions could lead to death, injury, serious physical damage or loss of any other kind. Such risks include in particular the use of these devices to monitor nuclear reactions in nuclear power plants, as well as flight control systems, flight safety, the control of mass transportation systems, medical life support systems, and the control of weapons systems.

Danger!

Servo drives and servo motors can have bare parts with voltages applied (e.g. terminals) or hot surfaces. Additional sources of danger result from moving machine parts. Improperly removing the required covers, inappropriate use, incorrect installation or incorrect operation can result in severe personal injury or damage to property.

All tasks, such as transport, installation, commissioning and service, are only allowed to be carried out by qualified personnel. Qualified personnel are persons familiar with transport, mounting, installation, commissioning and operation of the product and have the respective qualifications (e.g. IEC 60364). National accident prevention guidelines must be followed.

The safety guidelines, connection descriptions (type plate and documentation) and limit values listed in the technical data are to be read carefully before installation and commissioning and must be observed.

Danger!

Handling servo drives and servo motors incorrectly can cause severe personal injury or damage to property!

2.2 Intended Use

Servo drives are components designed to be installed in electrical systems or machines. They are not being used as intended unless the machine meets EG regulation 98/37/EG (machine regulation) as well as regulation 89/336/EWG (EMC regulation).

Servo drives are only allowed to be operated directly on grounded, three-phase industrial mains (TN, TT power mains). When using them in living areas, shops and small businesses, additional filtering measures must be implemented by the user.

Danger!

Servo drives are not allowed to be operated directly on IT and TN-S mains with a grounded phase conductor and protective ground conductor!

The technical data as well as the values for connection and environmental specifications can be found on the type plate and in the user's manual. The connection and environmental specifications must be met!

Danger!

Electronic devices are generally not fail-safe. If the servo drive fails, the user is responsible for making sure that the motor is placed in a secure state.

2.3 Transport and Storage

During transport and storage, devices must be protected from excessive stress (mechanical load, temperature, humidity, aggressive atmosphere).

Servo drives contain components sensitive to electrostatic charges which can be damaged by inappropriate handling. It is therefore necessary to provide the required safety precautions against electrostatic discharges during installation or removal of servo drives.

2.4 Installation

The installation must take place according to the user's manual using suitable equipment and tools.

The devices are only allowed to be installed without voltage applied and by qualified personnel. Before installation, voltage to the switching cabinet should be switched off and prevented from being switched on again.

The general safety regulations and national accident prevention guidelines (e.g. VBG 4) must be observed when working with high voltage systems.

Electrical installation must be carried out according to the relevant guidelines (e.g. line cross section, fuse, protective ground connection).

2.5 Operation

2.5.1 Protection Against Coming into Contact with Electrical Parts

Danger!

To operate servo drives, it is necessary that certain parts are carrying voltages over 42 VDC. A life-threatening electrical shock could occur if you touch these parts. This could result in death, severe injury or material damage.

Before turning on a servo drive, make sure that the housing is properly connected to ground (PE rail). The ground connection must be made, even when testing the servo drive or when operating it for a short time!

Before turning the device on, make sure that all voltage carrying parts are securely covered. During operation, all covers and switching cabinet doors must remain closed.

Control and high power contacts can have voltage applied, even when the motor is not turning. Touching the contacts when the device is switched on is not permitted.

Before working on servo drives, they must be disconnected from the power mains and prevented from being switched on again.

Danger!

After switching off the servo drive, wait until the DC bus discharge time of at least five minutes has passed. The voltage currently on the DC bus must be measured between -DC1 and +DC1 with a suitable measuring device before beginning work. This voltage must be less than 42 V DC to rule out danger. The Run LED going out does not indicate that voltage is not present on the device!

The servo drives are labeled with the following warning:

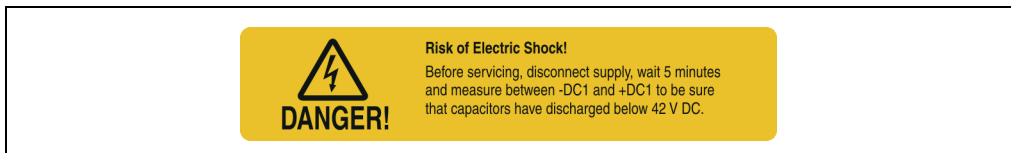

Figure 3: Warning on the servo drives

The connections for the signal voltages (5 to 30 V) found on the servo drives are isolated circuits. Therefore, the signal voltage connections and interfaces are only allowed to be connected to devices or electrical components with sufficient isolation according to IEC 60364-4-41 or EN 50178.

Never remove the electrical connections from the servo drive with voltage applied. In unfavorable conditions, arcs can occur causing personal injury and damage to contacts.

2.5.2 Protection from Dangerous Movements

Danger!

Incorrect control of motors can cause unwanted and dangerous movements! Such incorrect behavior can have various causes:

- **Incorrect installation or an error when handling the components**
- **Incorrect or incomplete wiring**
- **Defective devices (servo drive, motor, position encoder, cable, brake)**
- **Incorrect control (e.g. caused by software error)**

Some of these causes can be recognized and prevented by the servo drive using internal monitoring. However, it is generally possible for the motor shaft to move every time the device is switched on! Therefore protection of personnel and the machine can only be guaranteed using higher level safety precautions.

The movement area of machines must be protected to prevent accidental access. This type of protection can be obtained by using stabile mechanical protection such as protective covers, protective fences, protective gates or photocells.

Removing, bridging or bypassing these safety features and entering the movement area is prohibited.

A sufficient number of emergency stop switches are to be installed directly next to the machine. The emergency stop equipment must be checked before commissioning the machine.

Remove shaft keys on free running motors or prevent them from being catapulted.

The holding brake built into the motors cannot prevent hoists from allowing the load to sink.

2.5.3 Protection from Burns

The surfaces of servo drives and servo motors can become very hot during operation.

Therefore, the servo drives are labeled with the following warning:



Figure 4: "Hot surface" warning

Information:

A "hot surface" warning sticker is provided with the servo motors. It must be applied so that it can be seen at any time after the motor has been mounted.

2.6 Safety notices

The safety notices in this manual are organized as follows:

Safety Notices	Description
Danger!	Disregarding the safety regulations and guidelines can be life-threatening.
Warning!	Disregarding the safety regulations and guidelines can result in severe injury or major damage to material.
Caution!	Disregarding the safety regulations and guidelines can result in injury or damage to material.
Information:	Important information for preventing errors

Table 1: Description of the safety notices used in this manual

Chapter 2 • Technical Data

1. 8MS Three-phase Synchronous Motors

1.1 General Description

The three-phase synchronous motors from the 8MSA and 8MSC series are permanently excited, electronically commutated synchronous motors for applications that require excellent dynamic characteristics and positioning precision as well as compact size and reduced weight.

- NdFeB permanent magnets
- Sinusoidal commutation with EnDat encoder or resolver as feedback unit
- Three-phase winding with star connection
- Compact sizes result in low weight
- Minimum moment of inertia because of favorable rotor construction results in very good dynamic properties
- High overload capability/peak torque
- Low torque ripple
- High dynamic torque at high speeds
- Long life-span, all motor parts except for bearings are free of wear
- Direct diversion of lost power generated in the stator over the housing to the flange
- Preloaded, grooved ball bearings which are sealed on both sides and greased
- Complete motor system with stall torque ranging from 0.2 Nm to 115 Nm
- Connection using two circular plugs
- Controlled by ACOPOS servo drives

Warning!

8MS three-phase synchronous motors are not allowed to be connected directly to the power mains, they are only allowed to be operated in combination with ACOPOS servo drives!

Warning!

High temperatures can occur on the surface of the 8MS three-phase synchronous motors ($> 100\text{ }^{\circ}\text{C}$). If necessary, protection against accidental contact should be installed!

1.1.1 Cooling Types

The three-phase synchronous motors are available with different cooling types.

Cooling Type A

Three-phase synchronous motors with cooling type A are self-cooling and have a long, slim design. The motors must be installed on the cooling surface (= flange).

Caution!

Free convection on the motor housing must be guaranteed!

Cooling Type C

Three-phase synchronous motors with cooling type C are based on motors with cooling type A. They are separately cooled and the only difference is a fan module mounted in the area of the B-side bearing. The motors must be installed on the cooling surface (= flange).

Caution!

Make sure that the air inlet and outlet remain free and that heated air is not circulated back to the inlet area!

The built-in fan module increases the rated torque (M_N), rated current (I_N), stall torque (M_0) and stall current (I_0) by 30 % as compared to the respective motors with cooling type A.

1.1.2 Sizes

The three-phase synchronous motors are available in up to seven different sizes. They are different regarding dimensions (especially flange dimensions) and power rating.

The various sizes can be differentiated by a number in the model number. The larger the number, the larger the flange dimensions and power rating for the respective motor.

Overview

Cooling Type	Available Sizes						
	2	3	4	5	6	7	8
A	Yes	Yes	Yes	Yes	Yes	Yes	Yes
C	---	---	Yes	Yes	Yes	Yes	---

Table 2: Available sizes for each cooling type

1.1.3 Lengths

The three-phase synchronous motors are available in up to five different lengths. They have different power ratings with identical flange dimensions.

The various lengths can be differentiated by a letter in the model number.

Overview

Length		Available for Size						
Code	Description	2	3	4	5	6	7	8
S	Small rated torque	Yes	Yes	Yes	Yes	Yes	Yes	Yes
M	Medium rated torque	Yes	Yes	Yes	Yes	Yes	Yes	Yes
L	Large rated torque	Yes	Yes	Yes	Yes	Yes	Yes	Yes
X	Extra large rated torque	Yes	Yes	Yes	Yes	Yes	---	Yes
E	Exceptionally large rated torque	---	---	---	Yes	---	---	---

Table 3: Available lengths

1.2 Motor Encoder Systems

The 8MS three-phase synchronous motors are available with EnDat encoders and also with resolvers. The encoder system is listed as part of the model number in the form of a 2-digit code (dd).

1.2.1 EnDat Encoder

General Information

EnDat is a standard developed by Johannes Heidenhain GmbH (www.heidenhain.de), incorporating the advantages of absolute and incremental position measurement and also offers a read/write parameter memory in the encoder. With absolute position measurement (absolute position is read in serially), the homing procedure is usually not required. When necessary, a multi-turn encoder (4096 revolutions) should be installed. To save costs, a single-turn encoder and a reference switch can also be used. In this case, a homing procedure must be carried out.

The incremental process allows the short delay times necessary for position measurement on drives with exceptional dynamic properties. With the sinusoidal incremental signal and the fine resolution in the EnDat module, a very high positioning resolution is achieved in spite of the moderate signal frequencies used.

Technical Data

Different types of EnDat encoders can be used depending on the requirements:

Description	Order Code (dd)					
	E0 ¹⁾	E1 ¹⁾	E2 ¹⁾²⁾	E3 ¹⁾²⁾	E4 ³⁾	E5 ³⁾
Encoder Type	EnDat single-turn	EnDat multi-turn	EnDat single-turn	EnDat multi-turn	EnDat single-turn	EnDat multi-turn
Resolution	512 line		32 line		512 line	
Recognizable Revolutions	---	4096	---	4096	---	4096
Precision	±60"		±400"		±60"	
Frequency Limit	≥ 100 kHz (-3 dB)		≥ 6 kHz (-3 dB)		≥ 200 kHz (-3 dB)	
Manufacturer Internet Address	Dr. Johannes Heidenhain GmbH www.heidenhain.de					
Manufacturer's Product ID	ECN1313	EQN1325	ECl1317	EQI1329	ECN1113	EQN1125

Table 4: Technical data for EnDat encoders

- 1) Not available for size 2 motors.
- 2) Not available for size 8 motors.
- 3) Not available for size 2 motors.

1.2.2 Resolver

General Information

BRX type resolvers are used in the servo motors. These resolvers are fed with a single sinusoidal signal (reference signal) and deliver two sinusoidal signals as the result. The amplitude of these signals change with the angular position (sine or cosine form).

Technical Data

Description	Order Code (dd) R0
Precision	± 10 angular minutes
Non-linearity	±1 angular minute

Table 5: Technical data for the resolver

1.3 Motor Options

Depending on the cooling type, size and length, the 8MS three-phase synchronous motors can be delivered:

- with various rated speeds
- with or without oil seal
- with or without holding brake
- with a smooth shaft or a keyed shaft
- with up to three different connection directions

The respective combination of these motor options is listed in the form of a 2-digit code (ee) as part of the model number (see section 1.3.7 "Determining the Order Code for Motor Options (ee)" on Page 33).

1.3.1 Rated Speed

The 8MS three-phase synchronous motors can be delivered with up to four different rated speeds depending on the size and length. ¹⁾

Size	Available Rated Speeds n_N [min ⁻¹]																								
	2000					3000					4500					6000									
2	---					---					---					Yes					---				
3	---					Yes					---					Yes					---				
4	---					Yes					---					Yes					---				
5	---					Yes					Yes					---					---				
6	---					Yes					---					Yes					---				
7	---					Yes					---					Yes					---				
8	---	Yes	---	Yes	---	Yes	---	Yes	---	Yes	---	Yes	---	Yes	---	Yes	---	Yes	---						
Length	S	M	L	X	E	S	M	L	X	E	S	M	L	X	E	S	M	L	X	E					

Table 6: Rated speeds available according to size and length

1) Other windings/rated speeds are possible after arrangements have been made with B&R.

1.3.2 Oil Seal

All 8MS three-phase synchronous motors are available with an optional form A oil seal according to DIN 3760.

When equipped with an oil seal, the motors have IP65 protection according to IEC 60034-5.

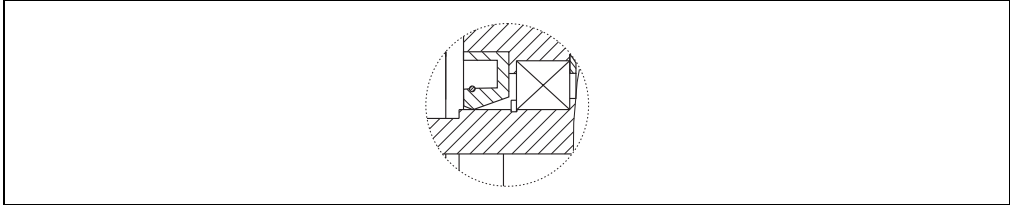

Figure 5: Detailed view of oil seal

Information:

The length of the motors is increased by the oil seal by a max. of 10 mm. Proper lubrication of the oil seal must be guaranteed throughout the entire lifespan of the motor.

1.3.3 Holding Brake

All 8MS three-phase synchronous motors can be delivered with a holding brake. It is installed directly behind the A flange on the motor and is used to hold the motor shaft when no power is applied to the servo motor.

Functionality

The holding brake is controlled by the ACOPOS servo drive. It uses permanent magnets that are demagnetized when 24 VDC is applied to a magnet winding. This releases the brake.

The brake is designed as a holding brake. It is not allowed to be used to for operational braking! If these conditions are met, the brake has a lifespan of approximately 5,000,000 cycles (opening and closing the brake again is one cycle).

Loaded braking during an emergency stop is allowed - but reduces the lifespan.

Information:

The required brake holding torque is determined based on the occurring load torque. If the load torque is not sufficiently known, it is recommended to assume a safety factor of 2.

Warning!

The holding brake is not intended for normal braking. The holding brake does not provide protection for personnel. The maximum motor torque far exceeds the holding torque.

Technical data for the standard holding brake

Description	Size of Motor						
	2	3	4	5	6	7	8
Holding Torque M_{Br} [Nm]	1,8	4	8	15	32		130
Installed Load P_{on} [W]	11	12	18	24	26		50
Highest Speed n_{max} [min^{-1}]	10000	10000	10000	10000	10000		8000
Installed Current I_{on} [A]	0,46	0,5	0,75	1	1,08		2,08
Installed Voltage U_{on} [V]	24 VDC +6 % / -10 %						
Activation Delay t_{on} [ms]	25	35	40	50	90		190
Release Delay t_{off} [ms]	6	7	7	10	22		65
Moment of Inertia J_{Br} [$kgcm^2$]	0,07	0,18	0,54	1,66	5,56		53
Weight m_{Br} [kg]	0,15	0,3	0,46	0,9	1,6		5,35

Table 7: Technical data for the standard holding brake

Warning!

If the holding barke is not used regularly for a long period of time, we recomend to periodically check the holding brake because the holding brake could fail in certain environmental conditions (e.g. humidity, oil vapor).

1.3.4 Type of Motor Shaft

All 8MS three-phase synchronous motor shafts comply to DIN 748. They can be delivered with a smoothed shaft end or a keyed shaft end.

Smooth Shaft

A smooth shaft end is used for a force-fit shaft-hub connection that guarantees a zero-play connection between shaft and hub as well as smooth operation.

Information:

For connection of pinion gears, belt disks or similar drive elements, please use suitable clamping sets, pressure sleeves or other fastening elements.

Drive elements must be protected against unintentional removal.

The end of the shaft has a threaded center hole which can be used to remove drive elements. ¹⁾

Keyed Shaft

The keyed shaft end can be used for a form-fit torque transfer with low demands on the shaft-hub connection and for handling torques with a constant direction.

The keyways for the three-phase synchronous motors conform to keyway form N1 according to DIN 6885-1. Form A shaft keys that conform to DIN 6885-1 are used. Balancing motors with keyways is done using the half-key convention according to DIN ISO 8821.

The end of the shaft has a threaded center hole which can be used to mount drive elements with shaft end disks. ¹⁾

Caution!

The shaft key can be deflected during heavy reverse operation. In extreme cases, this can cause the shaft end to break!

Smooth shaft ends should be used preferably.

1.3.5 Load Capacity of the Shaft End and Bearing

8MS three-phase synchronous motors are equipped with grooved ball bearings which are sealed on both sides and greased.

The radial and axial forces (F_r , F_a) that occur on the shaft end during operation and installation must be within the specifications listed below.

The bearing elements are not allowed to be subject to shocks or impacts! Incorrect handling will cause the lifespan of the bearings to be reduced or the bearing to be damaged.

¹⁾ Not for 8MSA2 motors.

Installation

The axial forces F_a permitted during the installation of gearboxes, pinion gears, couplings, etc. depend on the motor size and can be found in the following table:

Motor Size	Permitted Axial Force F_a [N]	
	Standard Bearing	Special Motor Option "Reinforced A Side Bearing"
2	200	---
3	200	---
4	350	700
5	500	800
6	500	800
7	500	---
8	700	1200

Table 8: Axial forces permitted during installation

Danger!

Because of the high axial forces on the motor shaft during installation, the bearings could be damaged and the operation of the motor holding brake could be so heavily influenced that it has no or only a reduced braking effect. Encoder errors could also occur.

Therefore, excessive pressure or shocks to the front shaft end or the rear housing cover should be avoided at all costs.

Loads caused by a hammer definitely exceed the permissible values!

Operation

Radial Force

The radial force F_r on the shaft end is made up of the installation forces (e.g. belt tension on pulleys) and operational forces (e.g. load torque on the pinion). The maximum radial force F_r depends on the shaft end type, bearing type, average speed, position where the radial force is applied and the desired lifespan of the bearings.

Warning!

Excessive radial force can cause premature wear on the bearings or, in extreme cases, can cause the shaft end to break.

Caution!

When installing drive elements on the motor shaft, avoid a hyperstatic arrangement of the motor shaft bearings. The tolerances that occur cause additional force on the motor shaft bearings.

This can significantly reduce the bearing's lifespan or damage the bearing!

Axial Force, Shift in Shaft Position caused by Axial Force

The axial force F_a on the shaft end is made up of the installation forces (e.g. stress caused by installation) and operational forces (e.g. thrust caused by slanted tooth pinions). The maximum axial force F_a depends on the bearing type and the desired lifespan of the bearings.

The fixed bearing is secured on the A flange with a retaining ring. The floating bearing is preloaded on the B flange with a spring in the direction of the A flange. Axial forces in the direction of the B flange can cause the spring bias to be overcome and the shaft is shifted by the amount of axial play in the bearing (approx. 0.1 - 0.2 mm). This shift can cause problems on motors with holding brakes or motors with EnDat encoders (E2 and E3). Therefore, **no** axial force is permitted in the direction of the B flange when using these motors.

Danger!

The shaft ends of motors with holding brakes are not allowed to have axial loads applied. Especially axial forces in the direction of the B flange should be prevented because these forces can cause the brake to fail!

Information:

The shaft ends of motors with EnDat encoders (E2 and E3) are not allowed to have axial loads applied. Especially axial forces in the direction of the B flange should be prevented because these forces can cause encoder errors!

Determining Permissible Values for F_r and F_a

Information to determine permissible values of F_r and F_a can be taken from the motor data for the respective three-phase synchronous motors (see section 1.9 "Motor Data 8MSA2" to section 1.20 "Motor Data 8MSC7"). Permissible values are based on a bearing lifespan of 20000 h (bearing lifespan calculation based on DIN ISO 281).

Warning!

Simultaneously loading the shaft end with the maximum values of F_r and F_a is not allowed! Contact B&R if this occurs.

1.3.6 Connection Direction

8MS three-phase synchronous motors can be delivered with up to three different connection directions depending on the cooling type and size.

Cooling Type A

Connection Direction	Available for Motor Size						
	2	3	4	5	6	7	8
Top	Yes	Yes	Yes	Yes	Yes	Yes	Yes
A Side	Yes	Yes	Yes	---	---	---	---
B Side	Yes	Yes	Yes	Yes	Yes	Yes	Yes

Table 9: Available connection directions

Cooling Type C

Generally, for motors with cooling type C, only the "top" connection direction is available.

1.3.7 Determining the Order Code for Motor Options (ee)

The respective code (ee) for the order key can be found in the following table:

Motor Options				Code for Order Key (ee) according to connection direction		
Rated Speed n_N [min ⁻¹]	Oil Seal	Holding Brake	Shaft End	A Side ¹⁾	B Side	Top
2000 ²⁾	No	No	Smooth	---	M2	P0
			Keyed	---	M3	P1
		Normal	Smooth	---	M4	P2
			Keyed	---	M5	P3
	Yes ³⁾	No	Smooth	---	M8	P6
			Keyed	---	M9	P7
		Normal	Smooth	---	N0	P8
			Keyed	---	N1	P9
3000	No	No	Smooth	30	B4	D2
			Keyed	31	B5	D3
		Normal	Smooth	32	B6	D4
			Keyed	33	B7	D5
	Yes ³⁾	No	Smooth	72	C0	D8
			Keyed	73	C1	D9
		Normal	Smooth	74	C2	E0
			Keyed	75	C3	E1
4500	No	No	Smooth	66	V4	X2
			Keyed	67	V5	X3
		Normal	Smooth	68	V6	X4
			Keyed	69	V7	X5
	Yes ³⁾	No	Smooth	A2	W0	X8
			Keyed	A3	W1	X9
		Normal	Smooth	A4	W2	Y0
			Keyed	A5	W3	Y1
6000 ⁴⁾	No	No	Smooth	42	I6	K4
			Keyed	43	I7	K5
		Normal	Smooth	44	I8	K6
			Keyed	45	I9	K7
	Yes ³⁾	No	Smooth	84	J2	L0
			Keyed	85	J3	L1
		Normal	Smooth	86	J4	L2
			Keyed	87	J5	L3

Table 10: Order key code (ee) for the motor options

- 1) The "A side" connection direction is only available for size 2, 3 and 4 motors.
- 2) A rated speed of 2000 min⁻¹ is only available for size 8 motors.
- 3) The oil seal extends the motor length by a maximum of 10 mm (also see dimension K_0 in the respective dimensions image).
- 4) The rated speed 6000 min⁻¹ is only available for size 2, 3 and 4 motors. Size 2 motors can only be delivered with a rated speed of 6000 min⁻¹.

1.4 Special Motor Options

8MS three-phase synchronous motors can be delivered with the following special motor options depending on the cooling type, size and length: ¹⁾

- "Reinforced A side bearing"
- "24 VDC fan"
- "24 VDC fan + reinforced A side bearing"

The respective special motor option is listed as part of the model number in the form of a 2-digit code (ff). If no special motor options are required, enter nothing or 00 for ff. ²⁾

1.4.1 "Reinforced A Side Bearing"

8MS three-phase synchronous motors with special motor option "reinforced A side bearing" can handle increased radial and axial forces (F_r , F_a) on the end of the shaft.

Information to determine permissible values of F_r and F_a can be taken from the motor data for the respective 8MS three-phase synchronous motors (see section 1.9 "Motor Data 8MSA2" to section 1.20 "Motor Data 8MSC7").

The following motor sizes are available with special motor option "reinforced A side bearing":

Special Motor Option	Code (ff)	Available for Motor Size						
		2	3	4	5	6	7	8
"Reinforced A side bearing"	0C	---	---	Yes	Yes	Yes	---	Yes

Table 11: Available motor sizes for special motor option "reinforced A side bearing"

Information:

Motors with special motor option "reinforced A side bearing" have increased values (in relation to motors with standard bearings) for the following dimensions:

- Flange dimensions
- Motor shaft dimensions
- Total length of the motor

The exact dimensions can be found in the motor data for the respective 8MS three-phase synchronous motors (see section 1.9 "Motor Data 8MSA2" to section 1.20 "Motor Data 8MSC7").

1) Other special options must be arranged with B&R.

2) 00 should only be entered if no special motor options are listed, but at the same time, a motor version is specified.

1.4.2 "24 VDC Fan", "24 VDC Fan + Reinforced A Side Bearing"

All 8MS three-phase synchronous motors with cooling type C can also be delivered with fans with an operating voltage of 24 VDC. The technical data for the 24 VDC fans can be found in the table 39 "Technical data for fans" on Page 88.

A combination of special motor options "24 VDC fan" and "reinforced A side bearing" is also possible.

1.5 Order Key

8MS **a** **b** **c** **.** **dd** **-** **ee** **ff** **-** **g**

Cooling type (see section 1.1.1 "Cooling Types" on Page 22)

- A Self-cooling (no separate surface cooling)
- C Separately cooled (surface cooling with independent fan module attached)

Size (see section 1.1.2 "Sizes" on Page 22)

Valid values: **2, 3, 4, 5, 6, 7, 8**

Length (see section 1.1.3 "Lengths" on Page 23)

- S Small rated torque
- M Medium rated torque
- L Large rated torque
- X Extra large rated torque
- E Exceptionally large rated torque

Encoder system (see section 1.2 "Motor Encoder Systems" on Page 24)

- E0 EnDat single-turn, 512 lines (ECN1313)
- E1 EnDat multi-turn, 512 lines (EQN1325), 4096 revolutions
- E2 EnDat single-turn, 32 lines, inductive (ECI1317) ¹⁾
- E3 EnDat multi-turn, 32 lines, inductive (EQI1329), 4096 revolutions ¹⁾
- E4 EnDat single-turn, 512 lines (ECN1113) ²⁾
- E5 EnDat multi-turn, 512 lines (EQN1125), 4096 revolutions ²⁾
- R0 Resolver

- 1) Option not available for size 8.
- 2) Option only available for size 2.

Motor Options (see section 1.3 "Motor Options" on Page 26)

Special Motor Option (see section 1.4 "Special Motor Options" on Page 34) ¹⁾

- 00 No special motor options ²⁾
- 0C Reinforced A side bearing
- 50 24 VDC fan ³⁾
- 5C 24 VDC fan + reinforced A side bearing ³⁾

- 1) Special options must be arranged with B&R. If no special motor options are required, enter nothing or 00 for ff.
- 2) Should only be entered if a motor version is specified at the same time (see also Example Order 2).
- 3) Special motor options only available for cooling type C.

Motor Version ¹⁾

- 1) If a motor version does not exist for the motor, nothing should be entered for g.

1.5.1 Example Order 1

A three-phase synchronous motor of type **8MSA4L** with a rated speed of 3000 min^{-1} was selected for an application. Because of the construction, the cables can only be connected on the top of the motor ("top" connection direction). The motor should also be equipped with a holding brake, a keyed shaft end and a 512 line EnDat single-turn encoder.

The code (dd) for the encoder system is **E0** (see table 4 "Technical data for EnDat encoders" on Page 24).

The code (ee) for the other options (rated speed, oil seal, holding brake, keyed shaft and connection direction) is **33** (see table 10 "Order key code (ee) for the motor options" on Page 33).

Therefore the model number for the motor required is: **8MSA4L.E0-33**

1.5.2 Example Order 2

A three-phase synchronous motor of type **8MSA5X** with a rated speed of 4500 min^{-1} was selected for an application. Because of the construction, the cables can only be connected on the back side of the motor ("B side" connection direction). The motor should also be equipped with a holding brake, a smooth shaft end, an oil seal and a 512 line EnDat multi-turn encoder.

The code (dd) for the encoder system is **E0** (see table 4 "Technical data for EnDat encoders" on Page 24).

The code (ee) for the other options (rated speed, oil seal, holding brake, keyed shaft and connection direction) is **W2** (see table 10 "Order key code (ee) for the motor options" on Page 33).

Therefore the model number for the motor required is: **8MSA5X.E1-W200-1** ¹⁾

1) This motor does not have any special motor options. 00 is entered in the product ID instead of the code for the special motor options (ff) because a motor version (-1) must be specified.

1.6 General Motor Data

Description	Cooling Type A	Cooling Type C
General Information		
C-UR-US Listed	Yes	
Electrical Characteristics		
Number of Poles	6 poles	
Mains Input Voltage on Servo Drive	3 x 400 VAC ... 3 x 480 VAC ± 10 %	
Connection Technology Motor Connector Encoder Connection	Circular connector from Intercontec Size 1 (8MSA8: Size 1.5) Size 1	
Thermal Characteristics		
Insulation Class according to IEC 60034-1	F	
Methods of Cooling according to IEC 60034-6 (IC code)	Self-cooling No separate surface cooling (IC4A0A0)	Separately cooled Surface cooling with independent cooling module attached (IC4A0A6)
Thermal Motor Protection according to IEC 60034-11	Maximum winding temperature is 140 °C (limited to 110 °C by the thermal motor protection in ACOPOS servo drive)	
Mechanical Characteristics		
Vibration Severity according to IEC 60034-14	Vibration severity grade R	
Roller Bearing, Dynamic Load Ratings and Rated Lifespan	Based on DIN ISO 281	
Eye Bolt according to DIN 580	For size 8	---
Shaft End according to DIN 748 ¹⁾	Form E	
Oil Seal according to DIN 3760	Form A	
Key and Keyway according to DIN 6885-1	Keyway form N1; key form A	
Balancing the Shaft according to DIN ISO 8821	Half-key arrangement	
Mounting Flange according to DIN 42948 ²⁾	Form A	
Shaft End Concentricity, Coaxial Properties and Mounting Flange Plane according to DIN 42955	Tolerance R	
Paint Description Color	Polyurethane paint with plastic effect CHEMOPUR P U 2082 RAL 9005 flat; shaft end and flange front metallic glossy	
Operational Conditions		
Rating Class, Operation Mode acc. to IEC 60034-1	S1 - continuous operation	
Environmental Temperature during Operation	-15° C to +40° C	
Reduction of the Rated Current and Stall Current at Temperatures above 40 °C	10 % per 10 °C	
Maximum Environmental Temperature during Operation	+55 °C ³⁾	
Relative Humidity during Operation	5 to 95%, non-condensing	
Reduction of the Rated Current and Stall Current at Installation Altitudes over 1000 m above Sea Level	10 % per 1000 m	

Table 12: General technical data

Description	Cooling Type A	Cooling Type C
Maximum Installation Altitude	2000 m ⁴⁾	
Maximum Flange Temperature	65 °C	
Protection Standards according to IEC 60034-5 (IP code) With Optional Oil Seal	IP64 IP65	IP64 (IP20 fan module) IP65 (IP20 fan module)
Construction and Mounting Arrangement Type according to IEC 60034-7 (IM code)	Horizontal (IM3001) Vertical, motor hangs on the machine (IM3011) Vertical, motor stands on the machine (IM3031)	
Storage and Transport Conditions		
Storage Temperature	-20 to +60° C	
Relative Humidity during Storage	Max. 90 %, non-condensing	
Transport Temperature	-20 to +60° C	
Relative Humidity during Transport	Max. 90 %, non-condensing	

Table 12: General technical data (Forts.)

- 1) Except sizes 2 and 7 as well as special motor option "reinforced A side bearing".
- 2) Centering diameter and hole pattern.
- 3) Continuous operation of the servo motors at environmental temperatures from +40 °C to max. +55 °C is possible, but results in a shorter lifespan.
- 4) Additional requirements are to be arranged with B&R.

1.7 Terminology and Formula Symbols

1.7.1 Connection Direction, Bearing

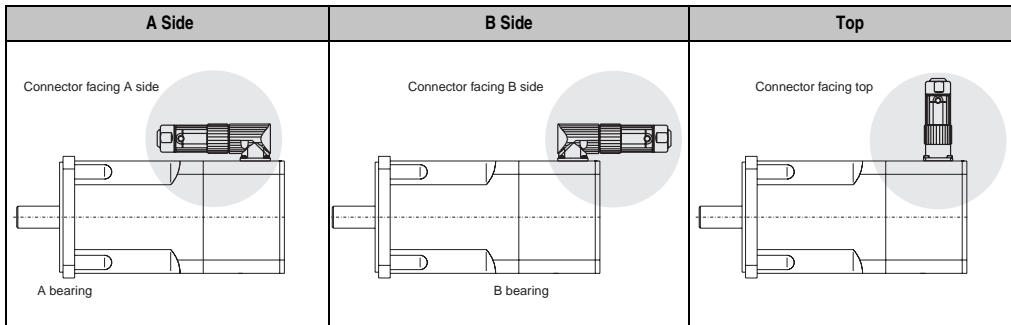

Table 13: Connection direction terminology, bearings

1.7.2 Definitions for Maximum Shaft Load Diagrams

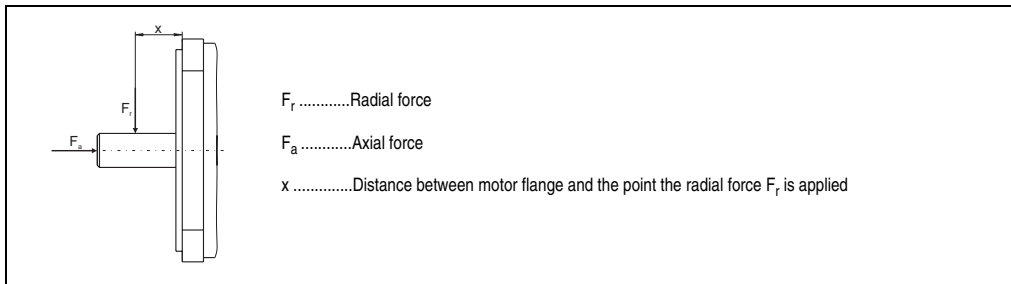

Figure 6: Definitions for diagrams of maximum shaft load

1.7.3 Formula Symbols

Term	Symbol	Unit	Description
Rated Speed	n_N	min^{-1}	Rated Speed of the Motor
Rated Torque	M_N	Nm	The rated torque is output by the motor ($n = n_N$) when the rated current is being drawn. This is possible for any length of time if the environmental conditions are correct.
Rated Power	P_N	kW	The rated power is output by the motor when $n = n_N$. This is possible for any length of time if the environmental conditions are correct.
Rated Current	I_N	A	The rated current is the effective value of the phase current (current in the motor supply line) for the generation of the rated torque at the rated speed. This is possible for any length of time if the environmental conditions are correct.

Table 14: Formula Symbols

Term	Symbol	Unit	Description
Stall Torque	M_0	Nm	The "stall torque" is output by the motor at the speed n_0 and when the "stall current" is being drawn. This is possible for any length of time if the environmental conditions are correct. The speed n_0 must be high enough so that the winding temperature in all windings is uniform and stationary ($n_0 = 50 \text{ min}^{-1}$ for B&R motors). The continuous torque is reduced while stationary.
Stall Current	I_0	A	The "stall current" is the effective value of the phase current (current in the motor supply line) for the generation of the "stall torque" at the speed n_0 . This is possible for any length of time if the environmental conditions are correct. The speed n_0 must be high enough so that the winding temperature in all windings is uniform and stationary ($n_0 = 50 \text{ min}^{-1}$ for B&R motors). The continuous current is reduced while stationary.
Peak Torque	M_{\max}	Nm	The peak torque is briefly output by the motor when the peak current is being drawn.
Peak Current	I_{\max}	A	The peak current is the effective value of the phase current (current in the motor supply line) for the generation of the peak torque. Only possible for a short time. The peak current is determined by the magnetic circuit. Exceeding this value for a short time can cause irreversible damage (demagnetize the magnet material).
Maximum Rotational Acceleration without Brake	a	rad/s^2	Maximum acceleration of the motor without load and without brake. Value for the dynamics of the motor (corresponds to M_{\max} / J).
Maximum Speed	n_{\max}	min^{-1}	Maximum motor speed. This is a mechanical condition (centrifugal force, bearing wear).
Average Speed	n_{aver}	min^{-1}	Average speed for one cycle
Torque Constant	K_T	Nm/A	The torque constant determines the torque created by the motor with 1 A_{rms} phase current. This value applies at a motor temperature of 20 °C. When the temperature increases, the torque constant is reduced (generally to 10 %). When the current increases, the torque constant is reduced (generally starting at twice the value of the rated current).
Voltage Constant	K_E	$\text{V}/1000\text{min}^{-1}$	The voltage constant determines the effective value (phase-phase) of the reverse voltage (EMF) induced by the motor with a speed of 1000 min^{-1} . This value applies at a motor temperature of 20°C. When the temperature increases, the voltage constant is reduced (generally to 5 %). When the current increases, the voltage constant is reduced (generally starting at twice the value of the rated current).
Stator Resistance	$R_{2\text{ph}}$	Ω	Resistance measured in ohms between two motor leads (phase-phase) at 20 °C winding temperature. On B&R motors, the windings use a star connection.
Stator Inductance	$L_{2\text{ph}}$	mH	Winding inductance measured between two motor leads. Stator inductance depends on the rotor position.
Electrical Time Constant	t_{el}	ms	Corresponds to 1/5 of the time needed for the stator current to stabilize with constant operating conditions.
Thermal Time Constant	t_{therm}	min	Corresponds to 1/5 of the time needed for the motor temperature to stabilize with constant operating conditions.
Moment of Inertia without Brake	J	kgcm^2	Moment of inertia for the motor without holding brake.
Weight without Brake	m	kg	Weight of the motor without holding brake.
Moment of Inertia of Brake	J_{Br}	kgcm^2	Moment of inertia for the built-in holding brake.
Weight of Brake	m_{Br}	kg	Weight of the built-in holding brake.
Brake Holding Torque	M_{Br}	Nm	Minimum torque required to hold the rotor when the brake is activated.

Table 14: Formula Symbols (Forts.)

Technical Data • Three-phase Synchronous Motors 8MS

Term	Symbol	Unit	Description
Installed Load	P_{in}	W	Installed load for the built-in holding brake.
Installed Current	I_{in}	A	Installed current for the built-in holding brake.
Installed Voltage	U_{in}	V	Operating voltage for the built-in holding brake.
Activation Delay	t_{on}	ms	Delay time required for the holding torque of the brake to be established after the operating voltage has been removed from the holding brake.
Release Delay	t_{off}	ms	Delay time required until the holding torque of the holding brake is reduced by 90% (the brake is released) after the operating voltage has been returned to the holding brake.

Table 14: Formula Symbols (Forts.)

1.8 Motor Data Overview Cooling Type A

The technical data listed in this section (K_E , K_T , I_N , I_0 , I_{max} , R_{2PH} , L_{2PH} , t_{el} , t_{therm} , m , J) has a theoretical tolerance range of $\pm 10\%$. This is also valid for the speed - torque characteristic curves represented in the following sections.

	8MSA2S.dd-eeff	8MSA2M.dd-eeff	8MSA2L.dd-eeff	8MSA2X.dd-eeff	8MSA3S.dd-eeff			8MSA3M.dd-eeff			8MSA3L.dd-eeff
Rated Speed n_N [min ⁻¹]	6000	6000	6000	6000	3000	4500	6000	3000	4500	6000	3000
Rated Torque M_N [Nm]	0.18	0.35	0.53	0.68	0.6	0.58	0.55	1.15	1.05	1	2.15
Rated Power P_N [kW]	0.11	0.22	0.33	0.43	0.19	0.27	0.35	0.36	0.49	0.63	0.68
Rated Current I_N [A]	0.43	0.62	0.86	1.05	0.64	0.75	0.83	0.95	1.16	1.4	1.62
Stall Torque M_0 [Nm]	0.2	0.4	0.6	0.8	0.65			1.3			2.5
Stalled Current I_0 [A]	0.44	0.67	0.93	1.15	0.65	0.79	0.91	1.01	1.33	1.67	1.8
Peak Torque M_{max} [Nm]	0.8	1.6	2.4	3.2	2.6			5.2			10
Peak Current I_{max} [A]	1.9	2.9	4	5	2.8	3.4	3.9	4.3	5.7	7.2	7.7
Maximum Rotational Acceleration without Brake a [rad/s ²]	133333	200000	218182	246154	66667			80000			83333
Maximum Speed n_{max} [min ⁻¹]	12000	12000	12000	12000	12000			12000			12000
Torque Constant K_T [Nm/A]	0.46	0.60	0.65	0.70	0.99	0.83	0.71	1.29	0.98	0.78	1.39
Voltage Constant K_E [V/1000 min ⁻¹]	27.5	36	39	42	60	50	43	78	59	47	84
Stator Resistance R_{2ph} [Ω]	99.5	50	32	24.5	75	50.3	37.6	34.5	20.3	12.7	15
Stator Inductance L_{2ph} [mH]	54	40	29	25	88	62	45	62	34.1	21.5	33.2
Electrical Time Constant t_{el} [ms]	0.54	0.8	0.91	1.02	1.17	1.23	1.2	1.8	1.7	1.69	2.21
Thermal Time Constant t_{therm} [min]	10	15	20	22	25			30			32
Moment of Inertia without Brake J [kgcm ²]	0.06	0.08	0.11	0.13	0.39			0.65			1.2
Weight without Brake m [kg]	0.9	1.06	1.21	1.36	1.75			2.25			3.2
Moment of Inertia for Brake J_{Br} [kgcm ²]	0.07	0.07	0.07	0.07	0.18			0.18			0.18
Weight of Brake m_{Br} [kg]	0.15	0.15	0.15	0.15	0.3			0.3			0.3
Holding Torque of the Brake M_{Br} [Nm]	1.8	1.8	1.8	1.8	4			4			4
Recommended Cable Cross Section for B&R Motor Cables [mm ²] ¹⁾	1.5	1.5	1.5	1.5	1.5			1.5	1.5		1.5
Recommended ACOPOS Servo Drive 8Vxxx.00-x ²⁾	1010	1010	1010	1016	1010			1010	1016		1022

Tabelle 15: Motor data overview for cooling type A

- 1) The B&R motor cables with this cable cross section are produced optimally (stripping length) for the recommended ACOPOS servo drives (see next line). B&R motor cables with other cable cross sections can also be used (within the specified terminal cross section range) and can be obtained from B&R in the desired design on request.
- 2) The recommended servo drive is defined for the stall current of the motor; if more than double the stall torque is required during the acceleration phase, the next larger servo drive should be selected. This recommendation is only a guideline, detailed inspection of the corresponding speed - torque characteristic curve can result in deviations of the servo drive size (one size larger or smaller).
The speed - torque characteristic curves shown in the following sections always refer to the smallest recommended servo drive for the motor length!

	8MSA3L.dd-eeff		8MSA3X.dd-eeff			8MSA4S.dd-eeff			8MSA4M.dd-eeff		
Rated Speed n_N [min^{-1}]	4500	6000	3000	4500	6000	3000	4500	6000	3000	4500	6000
Rated Torque M_N [Nm]	2	1.8	2.5	2.1	1.6	2.3	1.9	1.2	4.6	4.1	3
Rated Power P_N [kW]	0.94	1.13	0.79	0.99	1.01	0.72	0.90	0.75	1.45	1.93	1.88
Rated Current I_N [A]	2.2	2.3	1.82	2.1	2.1	1.85	2.25	1.75	3.75	4.4	4.25
Stall Torque M_0 [Nm]	2.5		3			2.6			5.3		
Stalled Current I_0 [A]	2.61	3.02	2.08	2.9	3.66	1.92	2.76	3.21	4.11	5.34	6.82
Peak Torque M_{max} [Nm]	10		12			10.4			21.2		
Peak Current I_{max} [A]	11.2	13	9	12.4	15.8	11.5	16.5	19.6	25.1	32.6	40.9
Maximum Rotational Acceleration without Brake a [rad/s^2]	83333		80000			54737			80000		
Maximum Speed n_{max} [min^{-1}]	12000		12000			12000			12000		
Torque Constant K_T [Nm/A]	0.96	0.83	1.44	1.04	0.82	1.36	0.94	0.81	1.29	0.99	0.78
Voltage Constant K_E [V/1000 min^{-1}]	58	50	87	63	49.5	82	57	49	78	60	47
Stator Resistance $R_{2\text{ph}}$ [Ω]	7	5.4	11.6	6	3.65	9.6	4.55	3.3	4.2	2.55	1.55
Stator Inductance $L_{2\text{ph}}$ [mH]	15.4	11.7	26.7	14.2	8.6	41.5	20.5	15	24	14.5	8.9
Electrical Time Constant t_{el} [ms]	2.2	2.17	2.3	2.37	2.36	4.32	4.51	4.55	5.71	5.69	5.74
Thermal Time Constant t_{therm} [min]	32		33			60			64		
Moment of Inertia without Brake J [kgcm ²]	1.2		1.5			1.9			2.65		
Weight without Brake m [kg]	3.2		3.65			4.5			5.6		
Moment of Inertia for Brake J_{Br} [kgcm ²]	0.18		0.18			0.54			0.54		
Weight of Brake m_{Br} [kg]	0.3		0.3			0.46			0.46		
Holding Torque of the Brake M_{Br} [Nm]	4		4			8			8		
Recommended Cable Cross Section for B&R Motor Cables [mm ²] ¹⁾	1.5		1.5	1.5		1.5			1.5		
Recommended ACOPOS Servo Drive 8Vxxx.00-x ²⁾	1045		1022	1045		1022	1045		1045	1090	

Table 15: Motor data overview for cooling type A (cont.)

- 1) The B&R motor cables with this cable cross section are produced optimally (stripping length) for the recommended ACOPOS servo drives (see next line). B&R motor cables with other cable cross sections can also be used (within the specified terminal cross section range) and can be obtained from B&R in the desired design on request.
- 2) The recommended servo drive is defined for the stall current of the motor; if more than double the stall torque is required during the acceleration phase, the next larger servo drive should be selected. This recommendation is only a guideline, detailed inspection of the corresponding speed - torque characteristic curve can result in deviations of the servo drive size (one size larger or smaller).
The speed - torque characteristic curves shown in the following sections always refer to the smallest recommended servo drive for the motor length!

	8MSA4L.dd-eeff			8MSA4X.dd-eeff			8MSA5S.dd-eeff-1		8MSA5M.dd-eeff-1		8MSA5L.dd-eeff-1
Rated Speed n_N [min ⁻¹]	3000	4500	6000	3000	4500	6000	3000	4500	3000	4500	3000
Rated Torque M_N [Nm]	6.4	5.6	4.5	8.5	7.5	6	5.7	5.2	8.8	7.2	11
Rated Power P_N [kW]	2.01	2.64	2.83	2.67	3.53	3.77	1.79	2.45	2.76	3.39	3.46
Rated Current I_N [A]	4.35	5.6	6	6	6.5	7.7	4	5.2	5.5	7.4	7.3
Stall Torque M_0 [Nm]	7.5			9.5			6.6		10.5		13.5
Stalled Current I_0 [A]	4.82	6.98	9.07	6.38	7.76	11.26	4.53	6.44	6.35	10.41	8.68
Peak Torque M_{max} [Nm]	30			38			19.8		31.5		40.5
Peak Current I_{max} [A]	29.4	41.9	55.3	38.3	46.6	67.6	22.6	32	31.6	52	43.2
Maximum Rotational Acceleration without Brake a [rad/s ²]	72289			62810			49500		50806		55479
Maximum Speed n_{max} [min ⁻¹]	12000			12000			9000		9000		9000
Torque Constant K_T [Nm/A]	1.56	1.08	0.83	1.49	1.22	0.84	1.46	1.03	1.65	1.01	1.56
Voltage Constant K_E [V/1000 min ⁻¹]	94	65	50	90	74	51	88	62	100	61	94
Stator Resistance R_{2ph} [Ω]	3	1.45	0.87	1.65	1.13	0.59	4.15	2.05	2.25	0.83	1.55
Stator Inductance L_{2ph} [mH]	19.2	9.2	5.6	11.7	7.9	4.1	27.8	13.8	20	7.4	14.6
Electrical Time Constant t_{el} [ms]	6.4	6.34	6.44	7.09	6.99	6.95	6.7	6.73	8.89	8.92	9.42
Thermal Time Constant t_{therm} [min]	66			68			45		50		55
Moment of Inertia without Brake J [kgcm ²]	4.15			6.05			4		6.2		7.3
Weight without Brake m [kg]	7.7			10.5			7.5		10		11.2

Moment of Inertia for Brake J_{Br} [kgcm ²]	0.54	0.54	1.66	1.66	1.66
Weight of Brake m_{Br} [kg]	0.46	0.46	0.9	0.9	0.9
Holding Torque of the Brake M_{Br} [Nm]	8	8	15	15	15

Recommended Cable Cross Section for B&R Motor Cables [mm ²] ¹⁾	1.5	1.5	4	1.5	1.5	4	1.5		
Recommended ACOPOS Servo Drive 8Vxxxx.00-x ²⁾	1045	1090	1090	1180	1045	1090	1090	1180	1090

Table 15: Motor data overview for cooling type A (cont.)

- 1) The B&R motor cables with this cable cross section are produced optimally (stripping length) for the recommended ACOPOS servo drives (see next line). B&R motor cables with other cable cross sections can also be used (within the specified terminal cross section range) and can be obtained from B&R in the desired design on request.
- 2) The recommended servo drive is defined for the stall current of the motor; if more than double the stall torque is required during the acceleration phase, the next larger servo drive should be selected. This recommendation is only a guideline, detailed inspection of the corresponding speed - torque characteristic curve can result in deviations of the servo drive size (one size larger or smaller).
The speed - torque characteristic curves shown in the following sections always refer to the smallest recommended servo drive for the motor length!

	8MSA5L.dd-eef1-1		8MSA5X.dd-eef1-1		8MSA5E.dd-eef1-1		8MSA6S.dd-eef1-1		8MSA6M.dd-eef1-1		8MSA6L.dd-eef1-1	
Rated Speed n_N [min ⁻¹]	4500	3000	4500	3000	4500	3000	4500	3000	4500	3000	4500	4500
Rated Torque M_N [Nm]	9	14.5	11	17.5	13.5	13	10	17	10	19	10	10
Rated Power P_N [kW]	4.24	4.56	5.18	5.50	6.36	4.08	4.71	5.34	4.71	5.97	4.71	4.71
Rated Current I_N [A]	8.9	8.6	10.9	10.5	14.6	8.2	9.1	10.6	9	12.3	9.2	9.2
Stall Torque M_0 [Nm]	13.5	17		22		13.5		19		22		22
Stalled Current I_0 [A]	12.96	9.88	16.31	12.79	21.81	8.16	11.66	11.49	15.95	13.71	18.73	18.73
Peak Torque M_{max} [Nm]	40.5	51		66		47.3		66.5		77		77
Peak Current I_{max} [A]	64.5	49.2	81.2	63.7	108.6	40	57	56	79	67.2	92	92
Maximum Rotational Acceleration without Brake a [rad/s ²]	55479	53684		56410		36107		35561		35814		35814
Maximum Speed n_{max} [min ⁻¹]	9000	9000		9000		6000		6000		6000		6000
Torque Constant K_T [Nm/A]	1.04	1.72	1.04	1.72	1.01	1.65	1.16	1.65	1.19	1.60	1.17	1.17
Voltage Constant K_E [V/1000 min ⁻¹]	63	104	63	104	61	100	70	100	72	97	71	71
Stator Resistance R_{2ph} [Ω]	0.68	1.26	0.46	0.95	0.33	1.1	0.56	0.61	0.32	0.46	0.25	0.25
Stator Inductance L_{2ph} [mH]	6.5	13.3	4.8	10.5	3.6	13.5	6.7	9	4.7	7.3	3.9	3.9
Electrical Time Constant t_{el} [ms]	9.56	10.56	10.43	11.05	10.91	12.27	11.96	14.75	14.69	15.87	15.6	15.6
Thermal Time Constant t_{therm} [min]	55	60		75		45		53		60		60
Moment of Inertia without Brake J [kgcm ²]	7.3	9.5		11.7		13.1		18.7		21.5		21.5
Weight without Brake m [kg]	11.2	13.7		16.2		13.9		18.2		20.3		20.3
Moment of Inertia for Brake J_{Br} [kgcm ²]	1.66	1.66		1.66		5.56		5.56		5.56		5.56
Weight of Brake m_{Br} [kg]	0.9	0.9		0.9		1.6		1.6		1.6		1.6
Holding Torque of the Brake M_{Br} [Nm]	15	15		15		32		32		32		32
Recommended Cable Cross Section for B&R Motor Cables [mm ²] ¹⁾	4	4		4		1.5	4	4		4		4
Recommended ACOPOS Servo Drive 8Vxxx.00-x ²⁾	1180	1180		1180	1320	1090	1180	1180		1180		1180

Table 15: Motor data overview for cooling type A (cont.)

- 1) The B&R motor cables with this cable cross section are produced optimally (stripping length) for the recommended ACOPOS servo drives (see next line). B&R motor cables with other cable cross sections can also be used (within the specified terminal cross section range) and can be obtained from B&R in the desired design on request.
- 2) The recommended servo drive is defined for the stall current of the motor; if more than double the stall torque is required during the acceleration phase, the next larger servo drive should be selected. This recommendation is only a guideline, detailed inspection of the corresponding speed - torque characteristic curve can result in deviations of the servo drive size (one size larger or smaller).
The speed - torque characteristic curves shown in the following sections always refer to the smallest recommended servo drive for the motor length!

	8MSA6X.dd-eeff-1		8MSA7S.dd-eeff		8MSA7M.dd-eeff		8MSA7L.dd-eeff	8MSA8S.dd-eeff	8MSA8M.dd-eeff	8MSA8L.dd-eeff	8MSA8X.dd-eeff
Rated Speed n_N [min ⁻¹]	3000	4500	3000	4500	3000	4500	3000	3000	3000	2000	2000
Rated Torque M_N [Nm]	24	6	20	14.5	23	15	26	30	50	70	85
Rated Power P_N [kW]	7.54	2.83	6.28	6.83	7.23	7.07	8.17	9.42	15.71	14.66	17.80
Rated Current I_N [A]	14.7	5.7	14.1	15.8	16.8	14.5	17.3	17.8	27.8	29.1	35.8
Stall Torque M_0 [Nm]	29		26		32		40	40	68	93	115
Stalled Current I_0 [A]	17.19	23.69	16.9	25.35	21.26	26.87	23.94	21.79	35.75	37.99	46.66
Peak Torque M_{max} [Nm]	101.5		78		96		120	120	204	279	345
Peak Current I_{max} [A]	84	116	65.9	98.9	82.9	104.8	93	85	139.4	148.2	182
Maximum Rotational Acceleration without Brake a [rad/s ²]	34407		11642		11852		11881	15769	17958	18283	18148
Maximum Speed n_{max} [min ⁻¹]	6000		6000		6000		4500	3600	3600	3600	3600
Torque Constant K_T [Nm/A]	1.69	1.22	1.54	1.03	1.51	1.19	1.67	1.84	1.90	2.45	2.46
Voltage Constant K_E [V/1000 min ⁻¹]	102	74	93	62	91	72	101	111	115	148	149
Stator Resistance R_{2ph} [Ω]	0.31	0.16	0.46	0.2	0.3	0.19	0.27	0.25	0.13	0.12	0.09
Stator Inductance L_{2ph} [mH]	5.6	3	5.1	2.2	3.7	2.2	3.4	5.7	3.3	3.7	2.8
Electrical Time Constant t_{el} [ms]	18.06	18.75	11.09	11	12.33	11.58	12.59	22.8	25.38	30.83	31.11
Thermal Time Constant t_{therm} [min]	70		60		67		70	47	65	79	90
Moment of Inertia without Brake J [kgcm ²]	29.5		67		81		101	76.1	113.6	152.6	190.1
Weight without Brake m [kg]	26.7		22.3		26.2		32	41	56	73	89
Moment of Inertia for Brake J_{Br} [kgcm ²]	5.56		5.56		5.56		5.56	53	53	53	53
Weight of Brake m_{Br} [kg]	1.6		1.6		1.6		1.6	5.35	5.35	5.35	5.35
Holding Torque of the Brake M_{Br} [Nm]	32		32		32		32	130	130	130	130
Recommended Cable Cross Section for B&R Motor Cables [mm ²] ¹⁾	4		4		4		4	4	4	10	10
Recommended ACOPOS Servo Drive 8Vxxx.00-x ²⁾	1180	1320	1180	1320	1320		1320	1320	1320	1640	1640

Table 15: Motor data overview for cooling type A (cont.)

- 1) The B&R motor cables with this cable cross section are produced optimally (stripping length) for the recommended ACOPOS servo drives (see next line). B&R motor cables with other cable cross sections can also be used (within the specified terminal cross section range) and can be obtained from B&R in the desired design on request.
- 2) The recommended servo drive is defined for the stall current of the motor; if more than double the stall torque is required during the acceleration phase, the next larger servo drive should be selected. This recommendation is only a guideline, detailed inspection of the corresponding speed - torque characteristic curve can result in deviations of the servo drive size (one size larger or smaller).
The speed - torque characteristic curves shown in the following sections always refer to the smallest recommended servo drive for the motor length!

1.9 Motor Data 8MSA2

1.9.1 Technical Data

	8MSA2S.dd-eeff	8MSA2M.dd-eeff	8MSA2L.dd-eeff	8MSA2X.dd-eeff
Rated Speed n_N [min^{-1}]	6000	6000	6000	6000
Rated Torque M_N [Nm]	0.18	0.35	0.53	0.68
Rated Power P_N [kW]	0.11	0.22	0.33	0.43
Rated Current I_N [A]	0.43	0.62	0.86	1.05
Stall Torque M_0 [Nm]	0.2	0.4	0.6	0.8
Stalled Current I_0 [A]	0.44	0.67	0.93	1.15
Peak Torque M_{max} [Nm]	0.8	1.6	2.4	3.2
Peak Current I_{max} [A]	1.9	2.9	4	5
Maximum Rotational Acceleration without Brake a [rad/s^2]	133333	200000	218182	246154
Maximum Speed n_{max} [min^{-1}]	12000	12000	12000	12000
Torque Constant K_T [Nm/A]	0.46	0.60	0.65	0.70
Voltage Constant K_E [V/1000 min^{-1}]	27.5	36	39	42
Stator Resistance $R_{2\text{ph}}$ [Ω]	99.5	50	32	24.5
Stator Inductance $L_{2\text{ph}}$ [mH]	54	40	29	25
Electrical Time Constant t_{el} [ms]	0.54	0.8	0.91	1.02
Thermal Time Constant t_{therm} [min]	10	15	20	22
Moment of Inertia without Brake J [kgcm^2]	0.06	0.08	0.11	0.13
Weight without Brake m [kg]	0.9	1.06	1.21	1.36
Moment of Inertia for Brake J_B [kgcm^2]	0.07	0.07	0.07	0.07
Weight of Brake m_B [kg]	0.15	0.15	0.15	0.15
Holding Torque of the Brake M_B [Nm]	1.8	1.8	1.8	1.8
Recommended Cable Cross Section for B&R Motor Cables [mm^2] ¹⁾	1.5	1.5	1.5	1.5
Recommended ACOPOS Servo Drive 8Vxxx.00-x ²⁾	1010	1010	1010	1016

Table 16: Technical data for 8MSA2

- 1) The B&R motor cables with this cable cross section are produced optimally (stripping length) for the recommended ACOPOS servo drives (see next line). B&R motor cables with other cable cross sections can also be used (within the specified terminal cross section range) and can be obtained from B&R in the desired design on request.
- 2) The recommended servo drive is defined for the stall current of the motor; if more than double the stall torque is required during the acceleration phase, the next larger servo drive should be selected. This recommendation is only a guideline, detailed inspection of the corresponding speed - torque characteristic curve can result in deviations of the servo drive size (one size larger or smaller).
The speed - torque characteristic curves shown in the following sections always refer to the smallest recommended servo drive for the motor length!

1.9.2 Speed-Torque Characteristic Curves with 400 VAC Supply Voltage

8MSA2S.dd-eeff

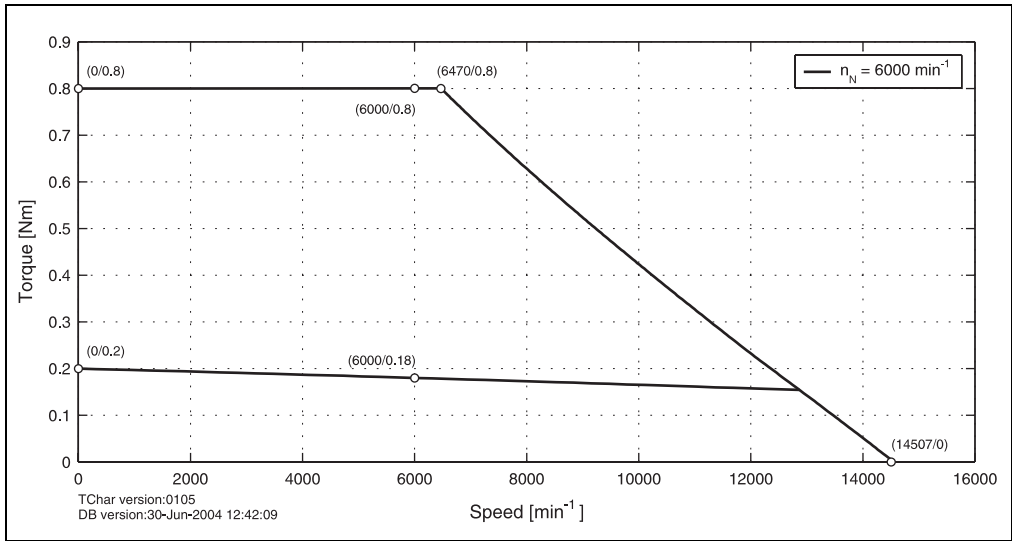

Figure 7: Speed - torque characteristic curve for 8MSA2S.dd-eeff

8MSA2M.dd-eeff

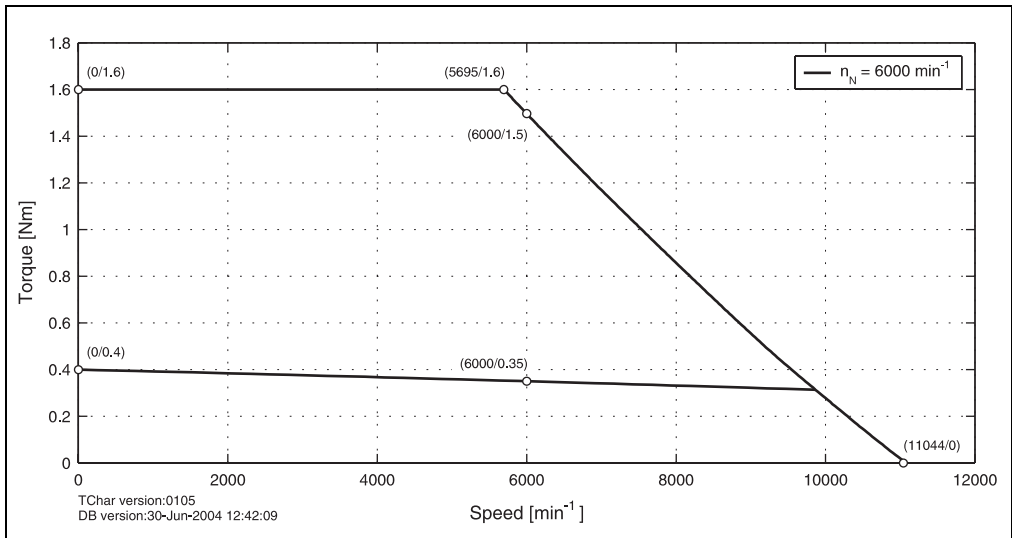

Figure 8: Speed - torque characteristic curve for 8MSA2M.dd-eeff

8MSA2L.dd-eeff

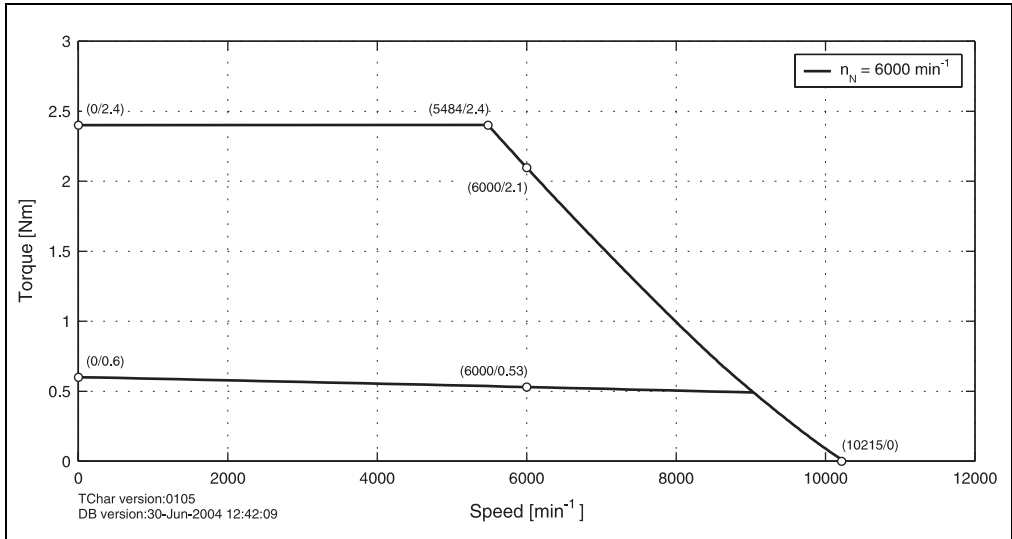

Figure 9: Speed - torque characteristic curve for 8MSA2L.dd-eeff

8MSA2X.dd-eeff

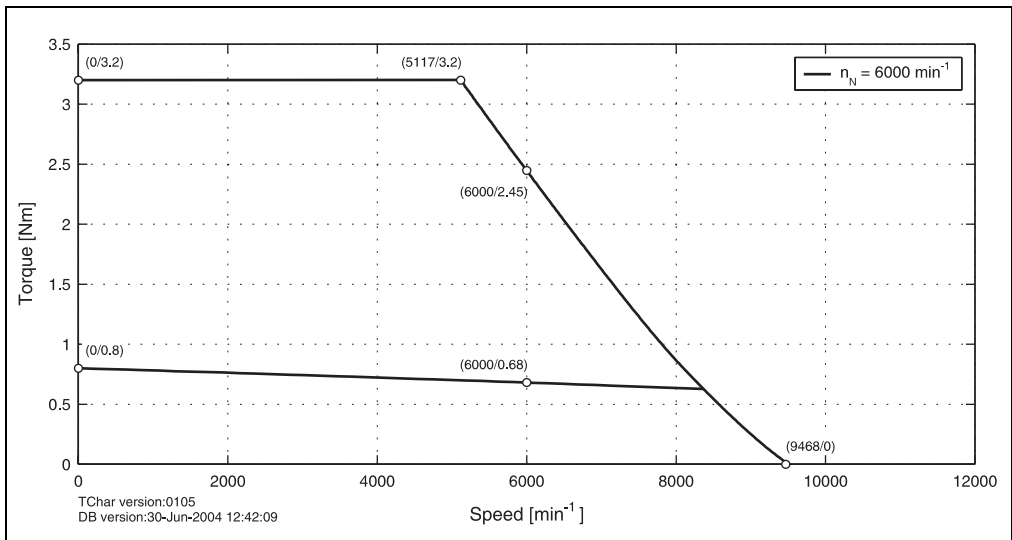
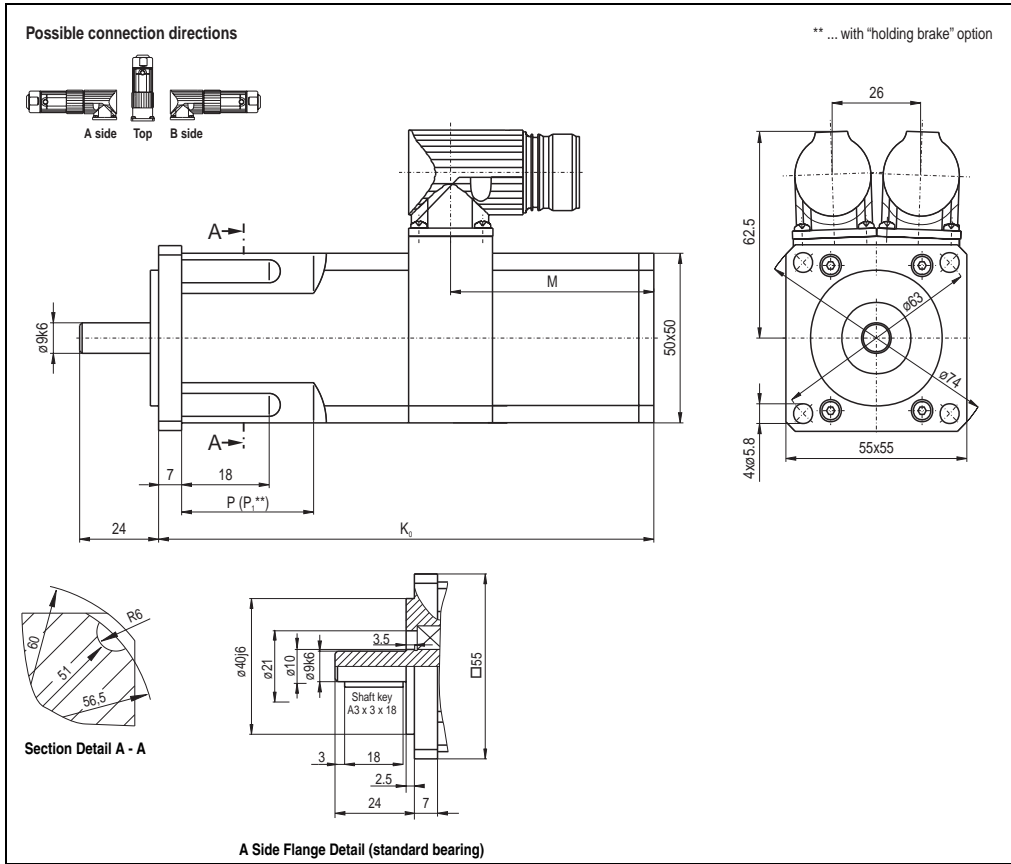

Figure 10: Speed - torque characteristic curve for 8MSA2X.dd-eeff

1.9.3 Dimensions



EnDat Feedback						Resolver Feedback						Extension of K_0 depending on the Motor Option [mm] ¹⁾			
Model Number	K_0	L	M	P	P_1	Model Number	K_0	L	M	P	P_1	Holding brake	Oil seal	Reinforced A side bearing	
8MSA2S.Ex-eeff	150.5	---	60.75	47	80	8MSA2S.R0-eeff	106	---	17	47	80	33	Approx. 10	---	
8MSA2M.Ex-eeff	165.5			62	95	8MSA2M.R0-eeff	121			62	95				
8MSA2L.Ex-eeff	180.5			77	110	8MSA2L.R0-eeff	136			77	110				
8MSA2X.Ex-eeff	195.5			92	125	8MSA2X.R0-eeff	151			92	125				

Table 17: 8MSA2 dimensions

1) If a combination of motor options is used (e.g. holding brake and oil seal), the sum of the extensions for the individual motor options must be added to K_0 .

1.9.4 Maximum Shaft Load

The values in the diagram below are based on a mechanical lifespan of the bearings of 20,000 operating hours.

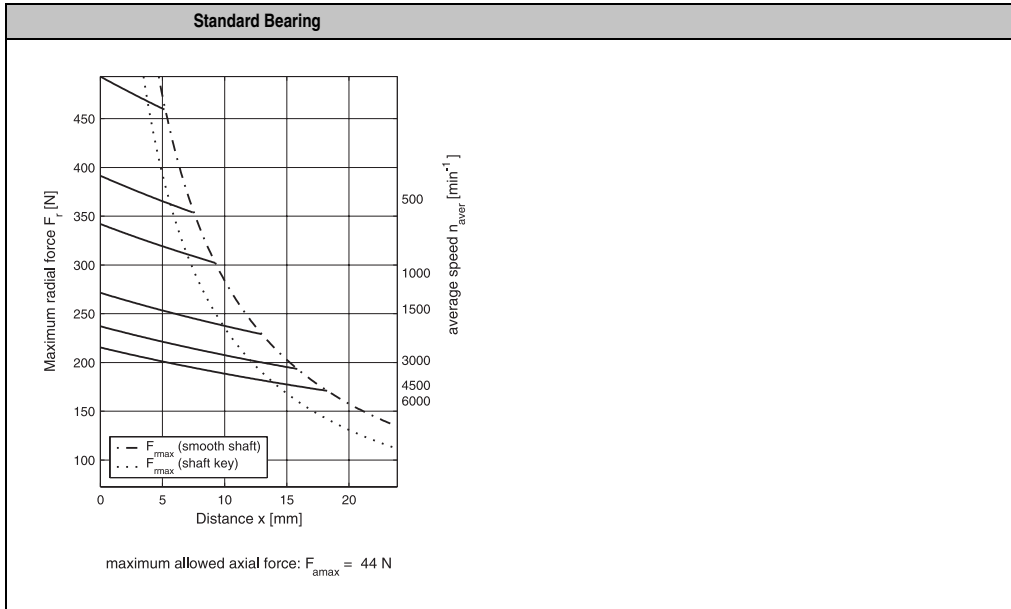

Table 18: Maximum shaft load for 8MSA2

1.10 Motor Data 8MSA3

1.10.1 Technical Data

	8MSA3S.dd-eeff			8MSA3M.dd-eeff			8MSA3L.dd-eeff			8MSA3X.dd-eeff		
	3000	4500	6000	3000	4500	6000	3000	4500	6000	3000	4500	6000
Rated Speed n_N [min ⁻¹]	3000	4500	6000	3000	4500	6000	3000	4500	6000	3000	4500	6000
Rated Torque M_N [Nm]	0.6	0.58	0.55	1.15	1.05	1	2.15	2	1.8	2.5	2.1	1.6
Rated Power P_N [kW]	0.19	0.27	0.35	0.36	0.49	0.63	0.68	0.94	1.13	0.79	0.99	1.01
Rated Current I_N [A]	0.64	0.75	0.83	0.95	1.16	1.4	1.62	2.2	2.3	1.82	2.1	2.1
Stall Torque M_0 [Nm]	0.65			1.3			2.5			3		
Stalled Current I_0 [A]	0.65	0.79	0.91	1.01	1.33	1.67	1.8	2.61	3.02	2.08	2.9	3.66
Peak Torque M_{max} [Nm]	2.6			5.2			10			12		
Peak Current I_{max} [A]	2.8	3.4	3.9	4.3	5.7	7.2	7.7	11.2	13	9	12.4	15.8
Maximum Rotational Acceleration without Brake a [rad/s ²]	66667			80000			83333			80000		
Maximum Speed n_{max} [min ⁻¹]	12000			12000			12000			12000		
Torque Constant K_T [Nm/A]	0.99	0.83	0.71	1.29	0.98	0.78	1.39	0.96	0.83	1.44	1.04	0.82
Voltage Constant K_E [V/1000 min ⁻¹]	60	50	43	78	59	47	84	58	50	87	63	49.5
Stator Resistance R_{2ph} [Ω]	75	50.3	37.6	34.5	20.3	12.7	15	7	5.4	11.6	6	3.65
Stator Inductance L_{2ph} [mH]	88	62	45	62	34.1	21.5	33.2	15.4	11.7	26.7	14.2	8.6
Electrical Time Constant t_{el} [ms]	1.17	1.23	1.2	1.8	1.7	1.69	2.21	2.2	2.17	2.3	2.37	2.36
Thermal Time Constant t_{therm} [min]	25			30			32			33		
Moment of Inertia without Brake J [kgcm ²]	0.39			0.65			1.2			1.5		
Weight without Brake m [kg]	1.75			2.25			3.2			3.65		
Moment of Inertia for Brake J_{Br} [kgcm ²]	0.18			0.18			0.18			0.18		
Weight of Brake m_{Br} [kg]	0.3			0.3			0.3			0.3		
Holding Torque of the Brake M_{Br} [Nm]	4			4			4			4		
Recommended Cable Cross Section for B&R Motor Cables [mm ²] ¹⁾	1.5			1.5	1.5		1.5	1.5		1.5	1.5	
Recommended ACOPOS Servo Drive 8Vxxx.00-x ²⁾	1010			1010	1016		1022	1045		1022	1045	

Table 19: Technical data for 8MSA3

- 1) The B&R motor cables with this cable cross section are produced optimally (stripping length) for the recommended ACOPOS servo drives (see next line). B&R motor cables with other cable cross sections can also be used (within the specified terminal cross section range) and can be obtained from B&R in the desired design on request.
- 2) The recommended servo drive is defined for the stall current of the motor; if more than double the stall torque is required during the acceleration phase, the next larger servo drive should be selected. This recommendation is only a guideline, detailed inspection of the corresponding speed - torque characteristic curve can result in deviations of the servo drive size (one size larger or smaller).
The speed - torque characteristic curves shown in the following sections always refer to the smallest recommended servo drive for the motor length!

1.10.2 Speed-Torque Characteristic Curves with 400 VAC Supply Voltage

8MSA3S.dd-eeff

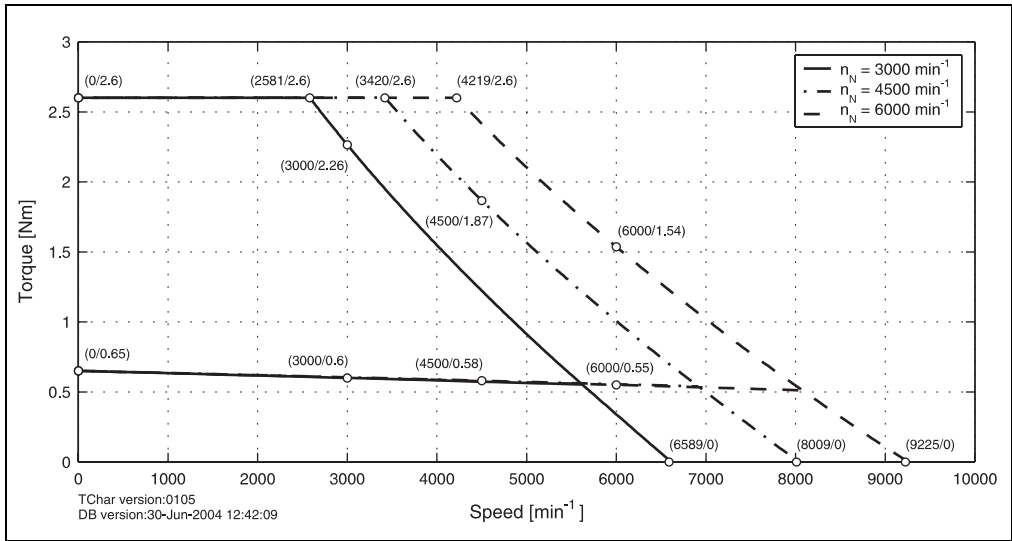

Figure 11: Speed - torque characteristic curve for 8MSA3S.dd-eeff

8MSA3M.dd-eeff

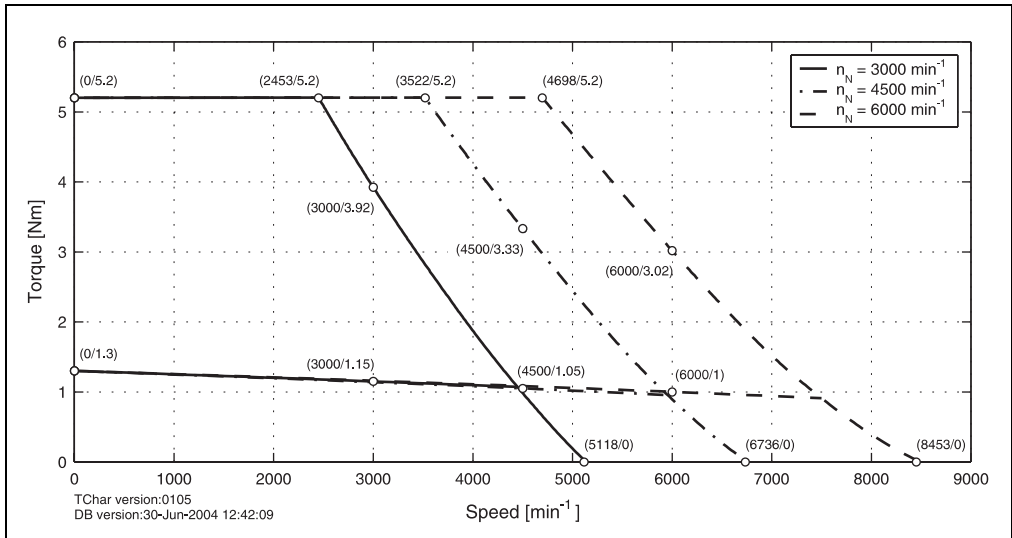

Figure 12: Speed - torque characteristic curve for 8MSA3M.dd-eeff

8MSA3L.dd-eeff

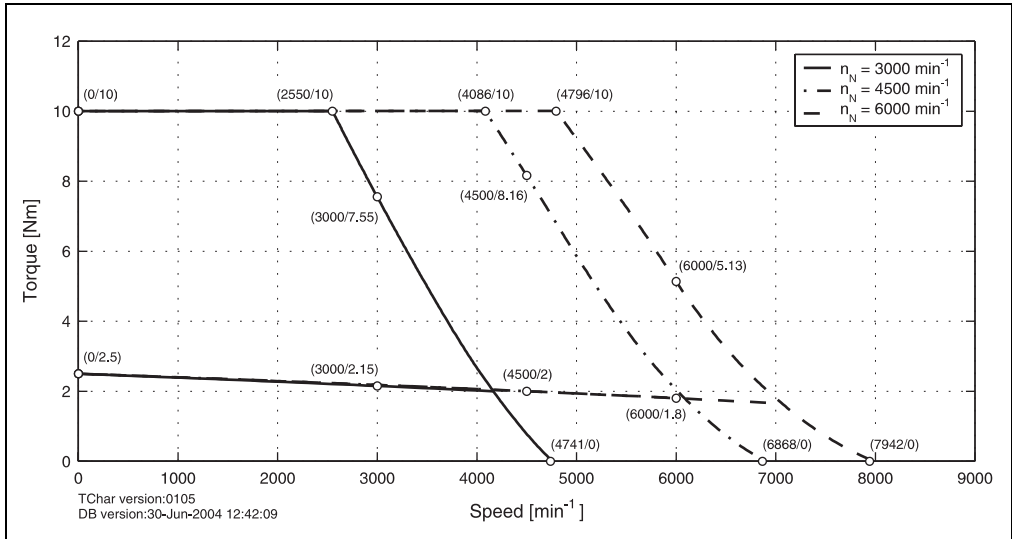

Figure 13: Speed - torque characteristic curve for 8MSA3L.dd-eeff

8MSA3X.dd-eeff

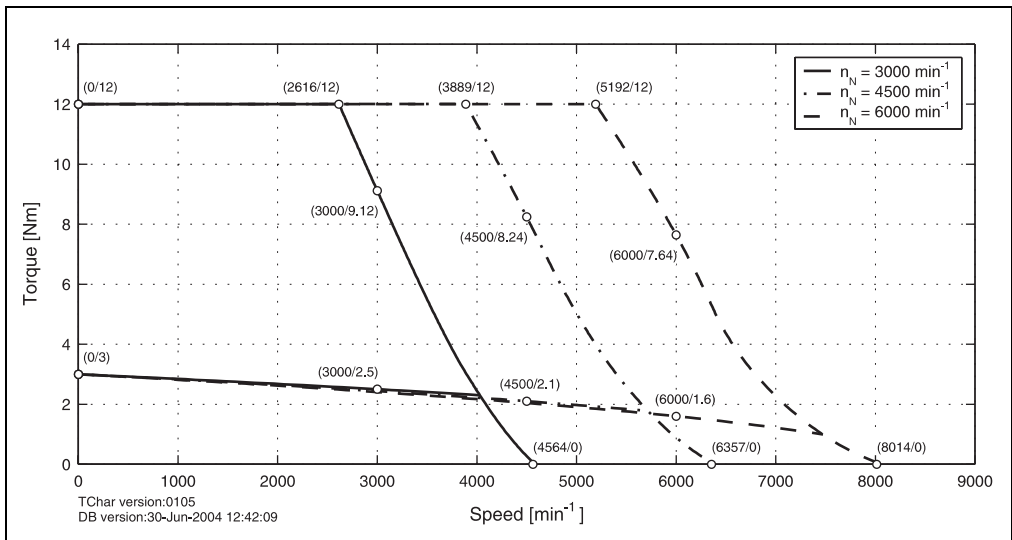
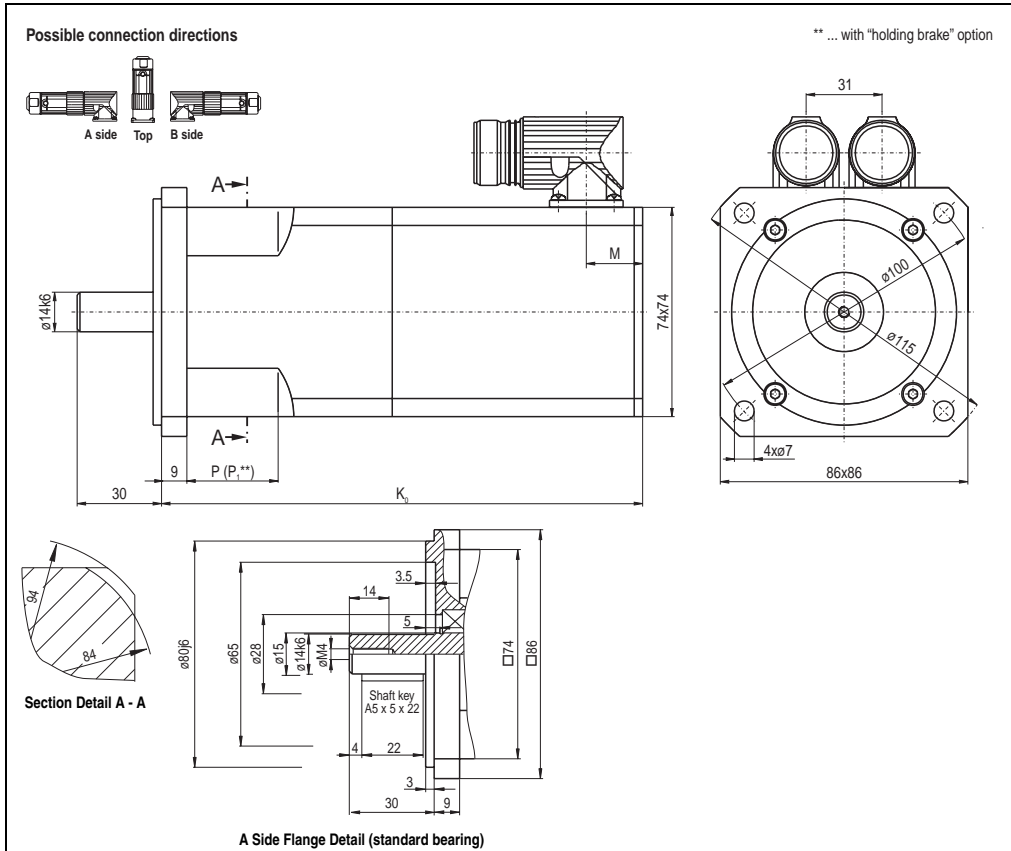

Figure 14: Speed - torque characteristic curve for 8MSA3X.dd-eeff

1.10.3 Dimensions



EnDat Feedback						Resolver Feedback						Extension of K_0 depending on the Motor Option [mm] ¹⁾			
Model Number	K_0	L	M	P	P_1	Model Number	K_0	L	M	P	P_1	Holding brake	Oil seal	Reinforced A side bearing	
8MSA3S.Ex-eeff	171	---	20	39	72	8MSA3S.R0-eeff	115	---	18	39	72	33	Approx. 10	---	
8MSA3M.Ex-eeff	189			57	90	8MSA3M.R0-eeff	133			57	90				
8MSA3L.Ex-eeff	225			93	126	8MSA3L.R0-eeff	169			93	126				
8MSA3X.Ex-eeff	243			111	144	8MSA3X.R0-eeff	187			111	144				

Table 20: 8MSA3 dimensions

1) If a combination of motor options is used (e.g. holding brake and oil seal), the sum of the extensions for the individual motor options must be added to K_0 .

1.10.4 Maximum Shaft Load

The values in the diagram below are based on a mechanical lifespan of the bearings of 20,000 operating hours.

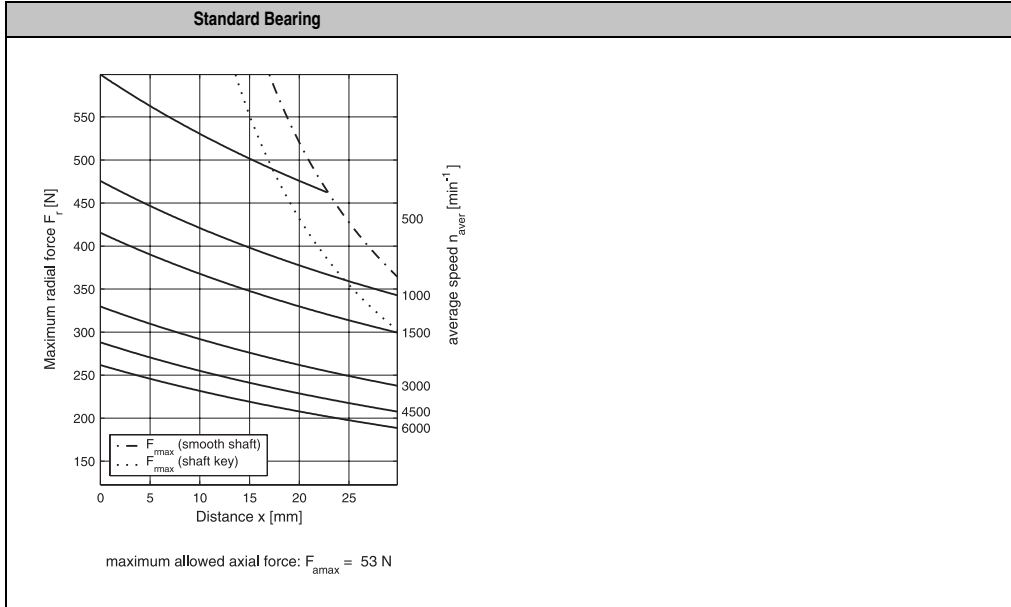

Table 21: Maximum shaft load for 8MSA3

1.11 Motor Data 8MSA4

1.11.1 Technical Data

	8MSA4S.dd-eeff			8MSA4M.dd-eeff			8MSA4L.dd-eeff			8MSA4X.dd-eeff		
Rated Speed n_N [min ⁻¹]	3000	4500	6000	3000	4500	6000	3000	4500	6000	3000	4500	6000
Rated Torque M_N [Nm]	2.3	1.9	1.2	4.6	4.1	3	6.4	5.6	4.5	8.5	7.5	6
Rated Power P_N [kW]	0.72	0.90	0.75	1.45	1.93	1.88	2.01	2.64	2.83	2.67	3.53	3.77
Rated Current I_N [A]	1.85	2.25	1.75	3.75	4.4	4.25	4.35	5.6	6	6	6.5	7.7
Stall Torque M_0 [Nm]	2.6			5.3			7.5			9.5		
Stalled Current I_0 [A]	1.92	2.76	3.21	4.11	5.34	6.82	4.82	6.98	9.07	6.38	7.76	11.26
Peak Torque M_{max} [Nm]	10.4			21.2			30			38		
Peak Current I_{max} [A]	11.5	16.5	19.6	25.1	32.6	40.9	29.4	41.9	55.3	38.3	46.6	67.6
Maximum Rotational Acceleration without Brake a [rad/s ²]	54737			80000			72289			62810		
Maximum Speed n_{max} [min ⁻¹]	12000			12000			12000			12000		
Torque Constant K_T [Nm/A]	1.36	0.94	0.81	1.29	0.99	0.78	1.56	1.08	0.83	1.49	1.22	0.84
Voltage Constant K_E [V/1000 min ⁻¹]	82	57	49	78	60	47	94	65	50	90	74	51
Stator Resistance R_{2ph} [Ω]	9.6	4.55	3.3	4.2	2.55	1.55	3	1.45	0.87	1.65	1.13	0.59
Stator Inductance L_{2ph} [mH]	41.5	20.5	15	24	14.5	8.9	19.2	9.2	5.6	11.7	7.9	4.1
Electrical Time Constant t_{el} [ms]	4.32	4.51	4.55	5.71	5.69	5.74	6.4	6.34	6.44	7.09	6.99	6.95
Thermal Time Constant t_{therm} [min]	60			64			66			68		
Moment of Inertia without Brake J [kgcm ²]	1.9			2.65			4.15			6.05		
Weight without Brake m [kg]	4.5			5.6			7.7			10.5		
Moment of Inertia for Brake J_{Br} [kgcm ²]	0.54			0.54			0.54			0.54		
Weight of Brake m_{Br} [kg]	0.46			0.46			0.46			0.46		
Holding Torque of the Brake M_{Br} [Nm]	8			8			8			8		
Recommended Cable Cross Section for B&R Motor Cables [mm ²] ¹⁾	1.5			1.5			1.5			1.5	4	
Recommended ACOPOS Servo Drive 8Vxxx.00-x ²⁾	1022	1045		1045	1090		1045	1090		1090	1180	

Table 22: Technical data for 8MSA4

- 1) The B&R motor cables with this cable cross section are produced optimally (stripping length) for the recommended ACOPOS servo drives (see next line). B&R motor cables with other cable cross sections can also be used (within the specified terminal cross section range) and can be obtained from B&R in the desired design on request.
- 2) The recommended servo drive is defined for the stall current of the motor; if more than double the stall torque is required during the acceleration phase, the next larger servo drive should be selected. This recommendation is only a guideline, detailed inspection of the corresponding speed - torque characteristic curve can result in deviations of the servo drive size (one size larger or smaller).
The speed - torque characteristic curves shown in the following sections always refer to the smallest recommended servo drive for the motor length!

1.11.2 Speed-Torque Characteristic Curves with 400 VAC Supply Voltage

8MSA4S.dd-eeff

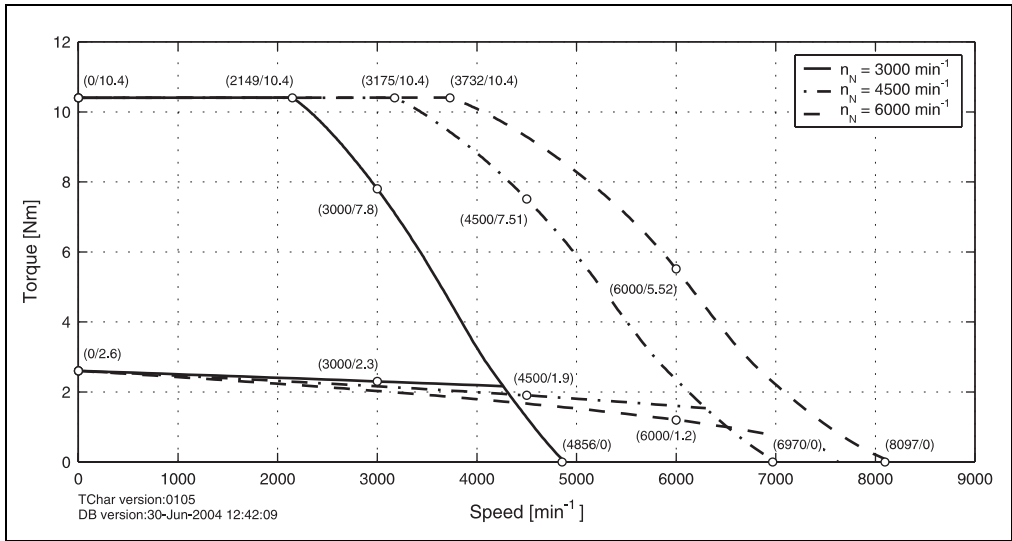

Figure 15: Speed - torque characteristic curve for 8MSA4S.dd-eeff

8MSA4M.dd-eeff

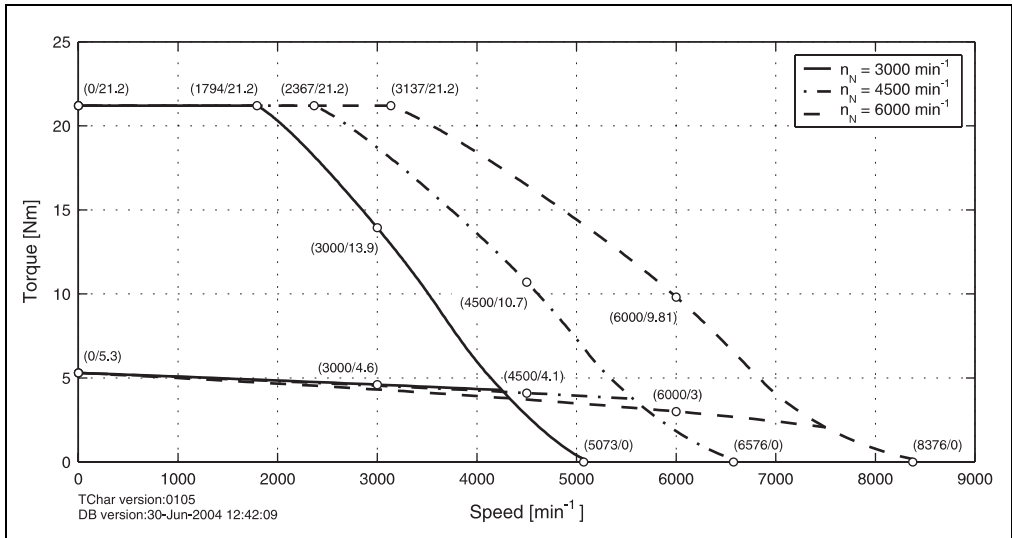

Figure 16: Speed - torque characteristic curve for 8MSA4M.dd-eeff

8MSA4L.dd-eeff

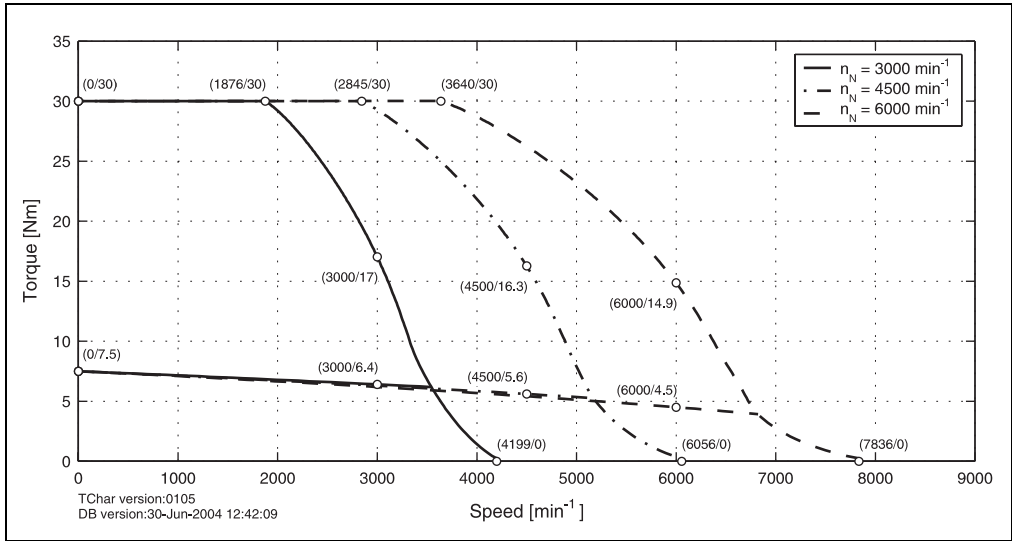

Figure 17: Speed - torque characteristic curve for 8MSA4L.dd-eeff

8MSA4X.dd-eeff

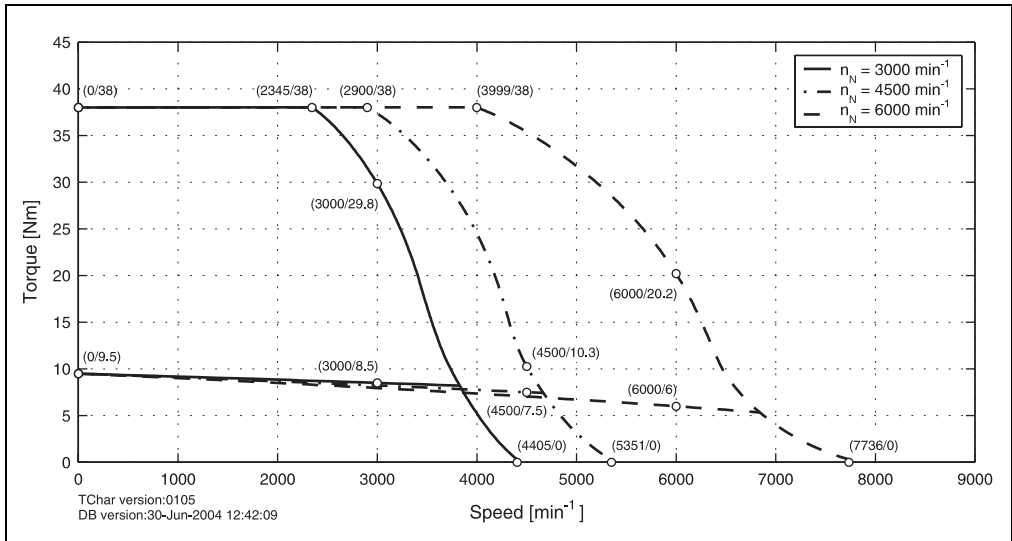
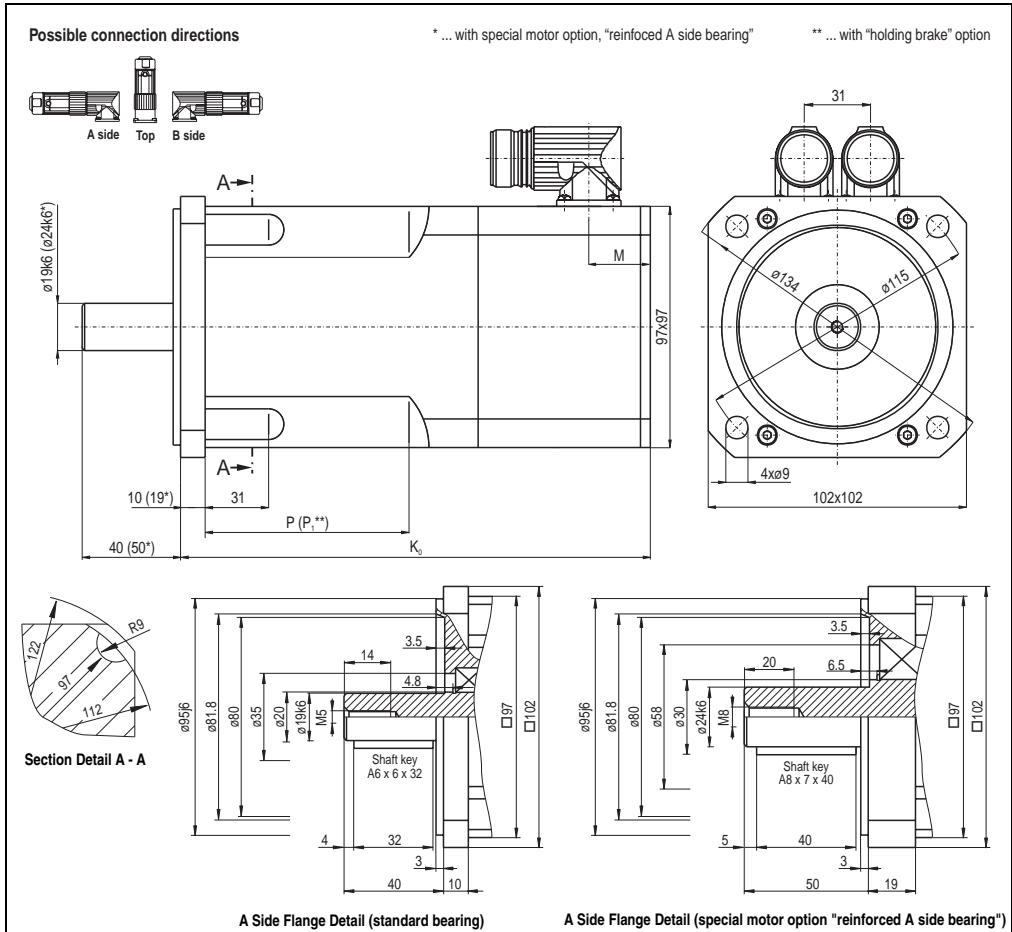

Figure 18: Speed - torque characteristic curve for 8MSA4X.dd-eeff

1.1.1.3 Dimensions



EnDat Feedback						Resolver Feedback						Extension of K_0 depending on the Motor Option [mm] ¹⁾		
Model Number	K_0	L	M	P	P_1	Model Number	K_0	L	M	P	P_1	Holding brake	Oil seal	Reinforced A side bearing
8MSA4S.Ex-eeff	191	---	23	84	116	8MSA4S.R0-eeff	155	---	19	84	116	32	Approx. 10	28 (33) ²⁾
8MSA4M.Ex-eeff	221			114	146	8MSA4M.R0-eeff	185			114	146			
8MSA4L.Ex-eeff	266			159	191	8MSA4L.R0-eeff	230			159	191			
8MSA4X.Ex-eeff	321.5			214.5	246.5	8MSA4X.R0-eeff	285.5			214.5	246.5			

Table 23: 8MSA4 dimensions

- 1) If a combination of motor options is used (e.g. holding brake and oil seal), the sum of the extensions for the individual motor options must be added to K_0 .
- 2) The value in parentheses is only valid with a combination of the "reinforced A side bearing" special motor option and the "holding brake" option.

1.11.4 Maximum Shaft Load

The values in the diagrams below are based on a mechanical lifespan of the bearings of 20,000 operating hours.

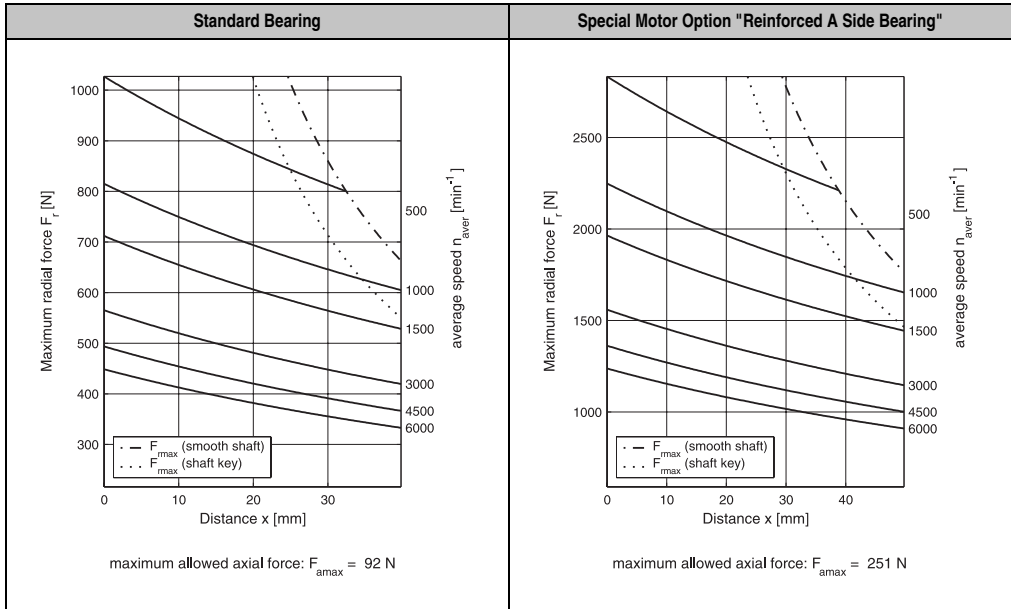

Table 24: Maximum shaft load for 8MSA4

1.12 Motor Data 8MSA5

1.12.1 Technical Data

	8MSA5S.dd-eeff-1		8MSA5M.dd-eeff-1		8MSA5L.dd-eeff.-1		8MSA5X.dd-eeff-1		8MSA5E.dd-eeff-1	
	3000	4500	3000	4500	3000	4500	3000	4500	3000	4500
Rated Speed n_N [min ⁻¹]	3000	4500	3000	4500	3000	4500	3000	4500	3000	4500
Rated Torque M_N [Nm]	5.7	5.2	8.8	7.2	11	9	14.5	11	17.5	13.5
Rated Power P_N [kW]	1.79	2.45	2.76	3.39	3.46	4.24	4.56	5.18	5.50	6.36
Rated Current I_N [A]	4	5.2	5.5	7.4	7.3	8.9	8.6	10.9	10.5	14.6
Stall Torque M_0 [Nm]	6.6		10.5		13.5		17		22	
Stalled Current I_0 [A]	4.53	6.44	6.35	10.41	8.68	12.96	9.88	16.31	12.79	21.81
Peak Torque M_{max} [Nm]	19.8		31.5		40.5		51		66	
Peak Current I_{max} [A]	22.6	32	31.6	52	43.2	64.5	49.2	81.2	63.7	108.6
Maximum Rotational Acceleration without Brake a [rad/s ²]	49500		50806		55479		53684		56410	
Maximum Speed n_{max} [min ⁻¹]	9000		9000		9000		9000		9000	
Torque Constant K_T [Nm/A]	1.46	1.03	1.65	1.01	1.56	1.04	1.72	1.04	1.72	1.01
Voltage Constant K_E [V/1000 min ⁻¹]	88	62	100	61	94	63	104	63	104	61
Stator Resistance R_{2ph} [Ω]	4.15	2.05	2.25	0.83	1.55	0.68	1.26	0.46	0.95	0.33
Stator Inductance L_{2ph} [mH]	27.8	13.8	20	7.4	14.6	6.5	13.3	4.8	10.5	3.6
Electrical Time Constant t_{el} [ms]	6.7	6.73	8.89	8.92	9.42	9.56	10.56	10.43	11.05	10.91
Thermal Time Constant t_{therm} [min]	45		50		55		60		75	
Moment of Inertia without Brake J [kgcm ²]	4		6.2		7.3		9.5		11.7	
Weight without Brake m [kg]	7.5		10		11.2		13.7		16.2	
Moment of Inertia for Brake J_{Br} [kgcm ²]	1.66		1.66		1.66		1.66		1.66	
Weight of Brake m_{Br} [kg]	0.9		0.9		0.9		0.9		0.9	
Holding Torque of the Brake M_{Br} [Nm]	15		15		15		15		15	
Recommended Cable Cross Section for B&R Motor Cables [mm ²] ¹⁾	1.5		1.5	4	1.5	4	4		4	
Recommended ACOPOS Servo Drive 8Vxxx.00-x ²⁾	1045	1090	1090	1180	1090	1180	1180		1180	1320

Table 25: Technical data for 8MSA5

- 1) The B&R motor cables with this cable cross section are produced optimally (stripping length) for the recommended ACOPOS servo drives (see next line). B&R motor cables with other cable cross sections can also be used (within the specified terminal cross section range) and can be obtained from B&R in the desired design on request.
- 2) The recommended servo drive is defined for the stall current of the motor; if more than double the stall torque is required during the acceleration phase, the next larger servo drive should be selected. This recommendation is only a guideline, detailed inspection of the corresponding speed - torque characteristic curve can result in deviations of the servo drive size (one size larger or smaller).
The speed - torque characteristic curves shown in the following sections always refer to the smallest recommended servo drive for the motor length!

1.1.2.2 Speed-Torque Characteristic Curves with 400 VAC Supply Voltage

8MSA5S.dd-eeff-1

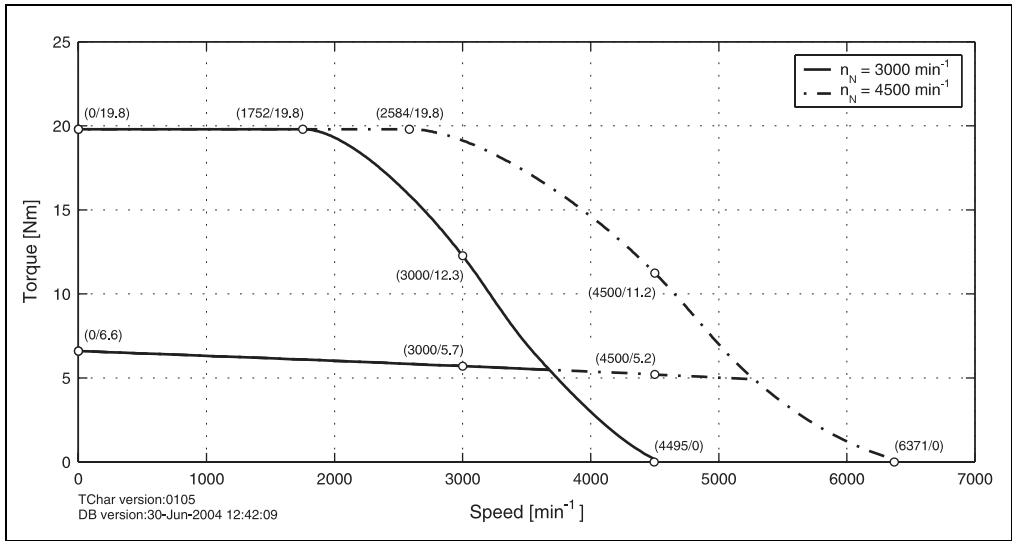

Figure 19: Speed - torque characteristic curve for 8MSA5S.dd-eeff-1

8MSA5M.dd-eeff-1

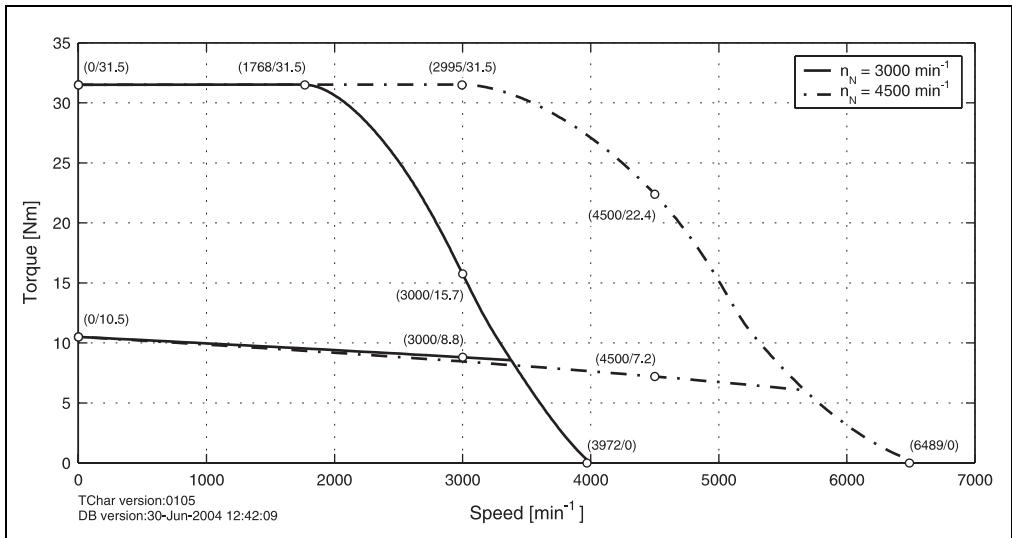

Figure 20: Speed - torque characteristic curve for 8MSA5M.dd-eeff-1

8MSA5L.dd-eeff-1

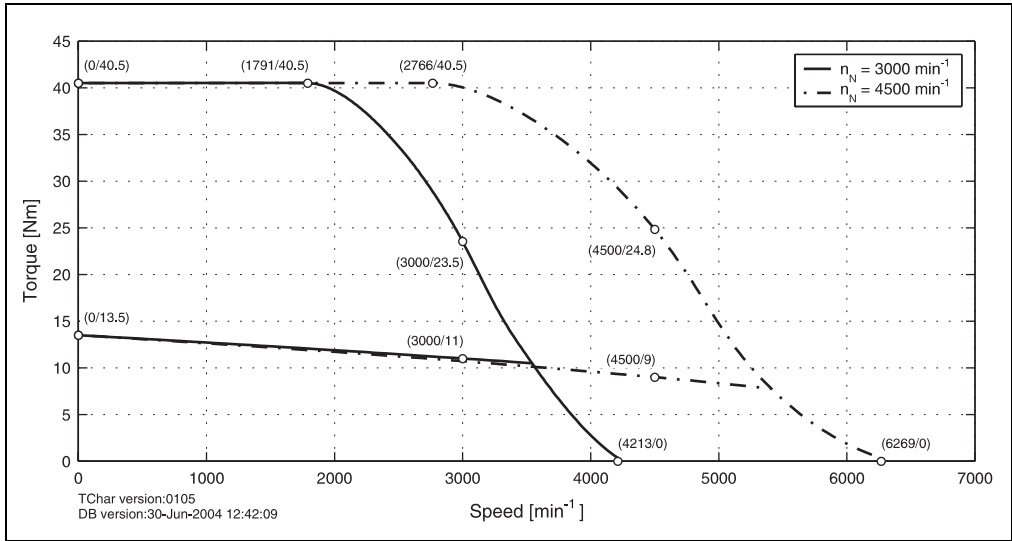

Figure 21: Speed - torque characteristic curve for 8MSA5L.dd-eeff-1

8MSA5X.dd-eeff-1

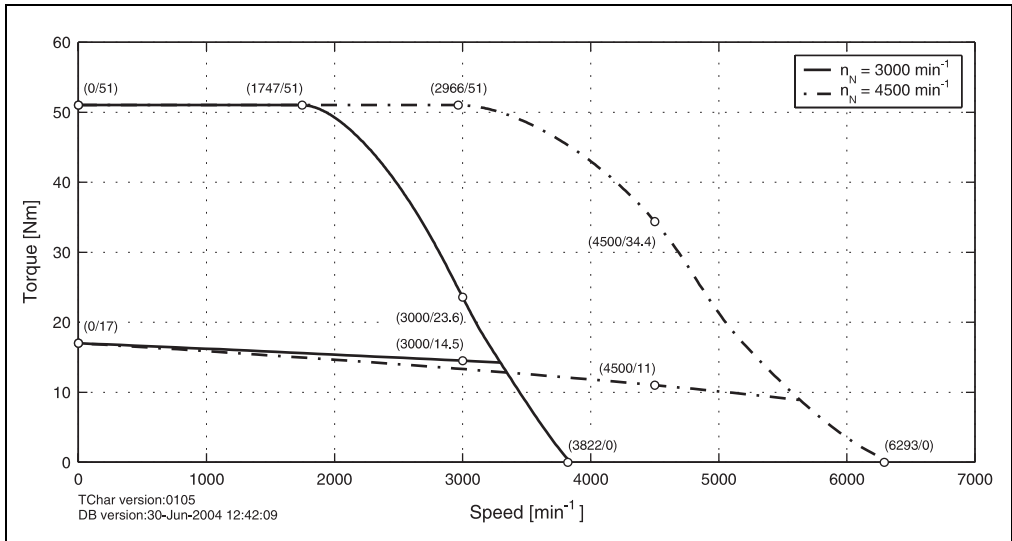

Figure 22: Speed - torque characteristic curve for 8MSA5X.dd-eeff-1

8MSA5E.dd-eeff-1

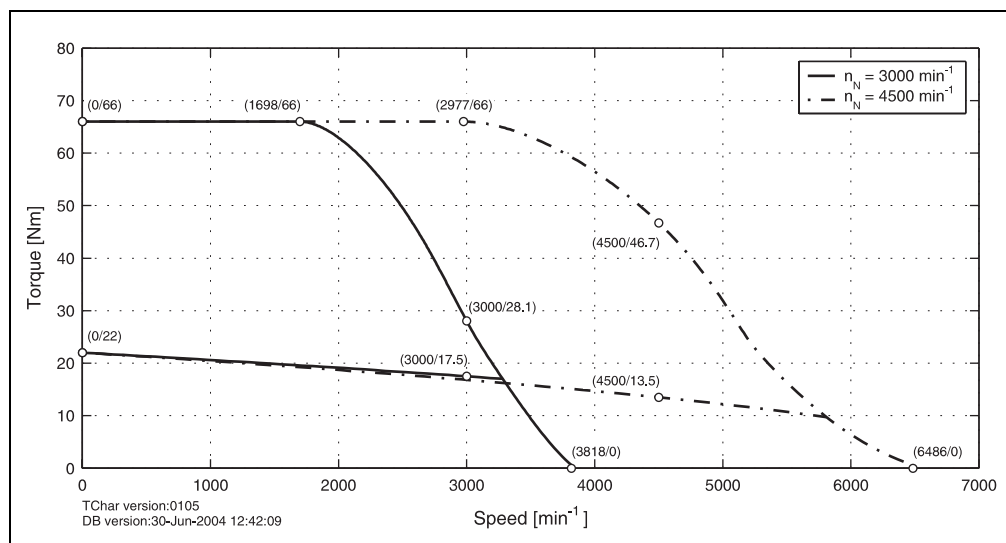
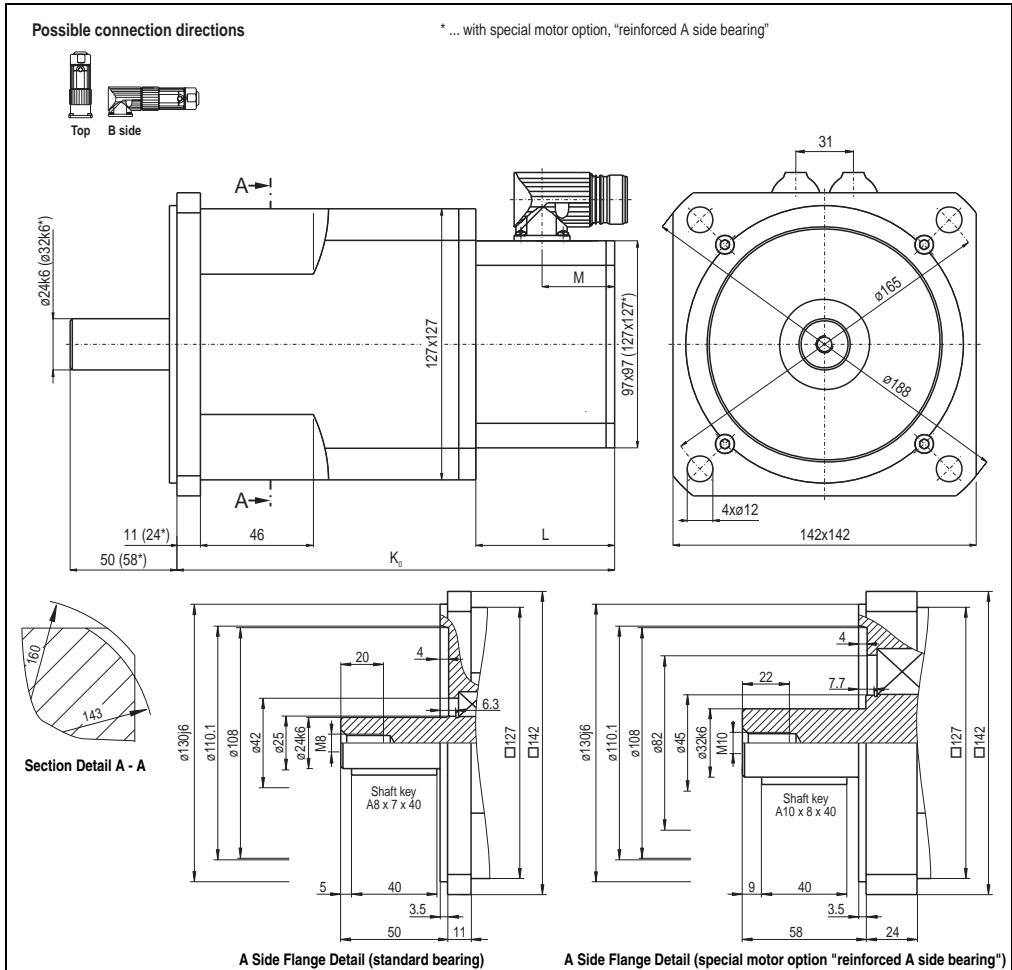

Figure 23: Speed - torque characteristic curve for 8MSA5E.dd-eeff-1

1.12.3 Dimensions



EnDat Feedback				Resolver Feedback				Extension of K_0 depending on the Motor Option [mm] ¹⁾		
Model Number	K_0	L	M	Model Number	K_0	L	M	Holding brake	Oil seal	Reinforced A side bearing
8MSA5S.Ex-eeff-1	205	65	26	8MSA5S.R0-eeff-1	186	46	20	43	Approx. 10	50 (53) ²⁾
8MSA5M.Ex-eeff-1	239			8MSA5M.R0-eeff-1	220					
8MSA5L.Ex-eeff-1	256			8MSA5L.R0-eeff-1	237					
8MSA5X.Ex-eeff-1	290			8MSA5X.R0-eeff-1	271					
8MSA5E.Ex-eeff-1	324			8MSA5E.R0-eeff-1	305					

Table 26: 8MSA5 dimensions

- 1) If a combination of motor options is used (e.g. holding brake and oil seal), the sum of the extensions for the individual motor options must be added to K_0 .
- 2) The value in parentheses is only valid with both the "reinforced A side bearing" special motor option and the "holding brake" option.

1.12.4 Maximum Shaft Load

The values in the diagrams below are based on a mechanical lifespan of the bearings of 20,000 operating hours.

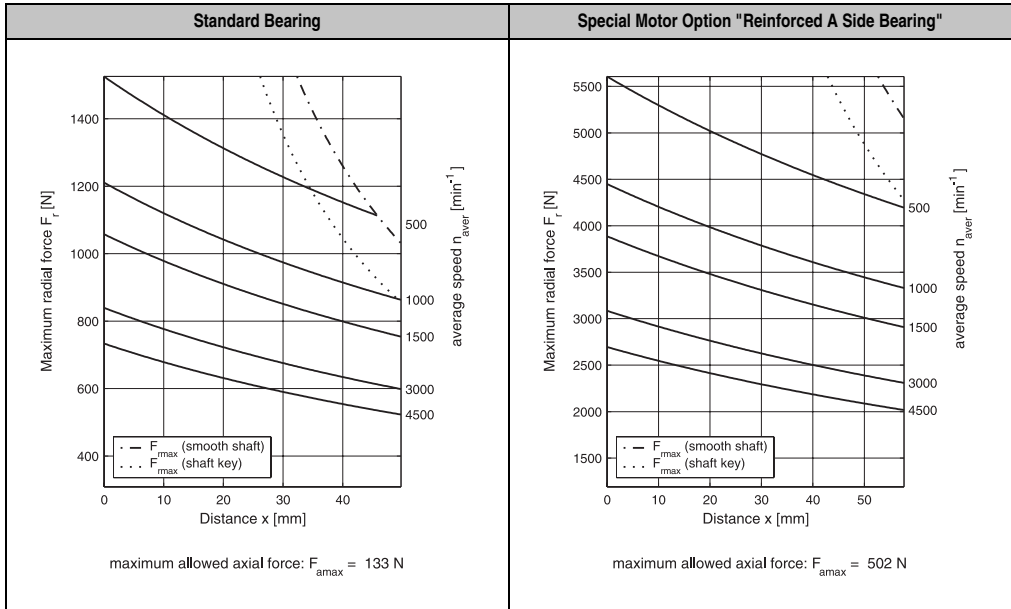

Table 27: Maximum shaft load for 8MSA5

1.13 Motor Data 8MSA6

1.13.1 Technical Data

	8MSA6S.dd-eeff-1		8MSA6M.dd-eeff-1		8MSA6L.dd-eeff-1		8MSA6X.dd-eeff-1	
	3000	4500	3000	4500	3000	4500	3000	4500
Rated Speed n_N [min ⁻¹]	3000	4500	3000	4500	3000	4500	3000	4500
Rated Torque M_N [Nm]	13	10	17	10	19	10	24	6
Rated Power P_N [kW]	4.08	4.71	5.34	4.71	5.97	4.71	7.54	2.83
Rated Current I_N [A]	8.2	9.1	10.6	9	12.3	9.2	14.7	5.7
Stall Torque M_0 [Nm]	13.5		19		22		29	
Stalled Current I_0 [A]	8.16	11.66	11.49	15.95	13.71	18.73	17.19	23.69
Peak Torque M_{max} [Nm]	47.3		66.5		77		101.5	
Peak Current I_{max} [A]	40	57	56	79	67.2	92	84	116
Maximum Rotational Acceleration without Brake a [rad/s ²]	36107		35561		35814		34407	
Maximum Speed n_{max} [min ⁻¹]	6000		6000		6000		6000	
Torque Constant K_T [Nm/A]	1.65	1.16	1.65	1.19	1.60	1.17	1.69	1.22
Voltage Constant K_E [V/1000 min ⁻¹]	100	70	100	72	97	71	102	74
Stator Resistance R_{2ph} [Ω]	1.1	0.56	0.61	0.32	0.46	0.25	0.31	0.16
Stator Inductance L_{2ph} [mH]	13.5	6.7	9	4.7	7.3	3.9	5.6	3
Electrical Time Constant t_{el} [ms]	12.27	11.96	14.75	14.69	15.87	15.6	18.06	18.75
Thermal Time Constant t_{therm} [min]	45		53		60		70	
Moment of Inertia without Brake J [kgcm ²]	13.1		18.7		21.5		29.5	
Weight without Brake m [kg]	13.9		18.2		20.3		26.7	
Moment of Inertia for Brake J_{Br} [kgcm ²]	5.56		5.56		5.56		5.56	
Weight of Brake m_{Br} [kg]	1.6		1.6		1.6		1.6	
Holding Torque of the Brake M_{Br} [Nm]	32		32		32		32	
Recommended Cable Cross Section for B&R Motor Cables [mm ²] ¹⁾	1.5	4	4	4	4	4	4	4
Recommended ACOPOS Servo Drive 8Vxxx.00-x ²⁾	1090	1180	1180	1180	1180	1180	1180	1320

Table 28: Technical data for 8MSA6

- 1) The B&R motor cables with this cable cross section are produced optimally (stripping length) for the recommended ACOPOS servo drives (see next line). B&R motor cables with other cable cross sections can also be used (within the specified terminal cross section range) and can be obtained from B&R in the desired design on request.
- 2) The recommended servo drive is defined for the stall current of the motor; if more than double the stall torque is required during the acceleration phase, the next larger servo drive should be selected. This recommendation is only a guideline, detailed inspection of the corresponding speed - torque characteristic curve can result in deviations of the servo drive size (one size larger or smaller).
The speed - torque characteristic curves shown in the following sections always refer to the smallest recommended servo drive for the motor length!

1.13.2 Speed-Torque Characteristic Curves with 400 VAC Supply Voltage

8MSA6S.dd-eeff-1

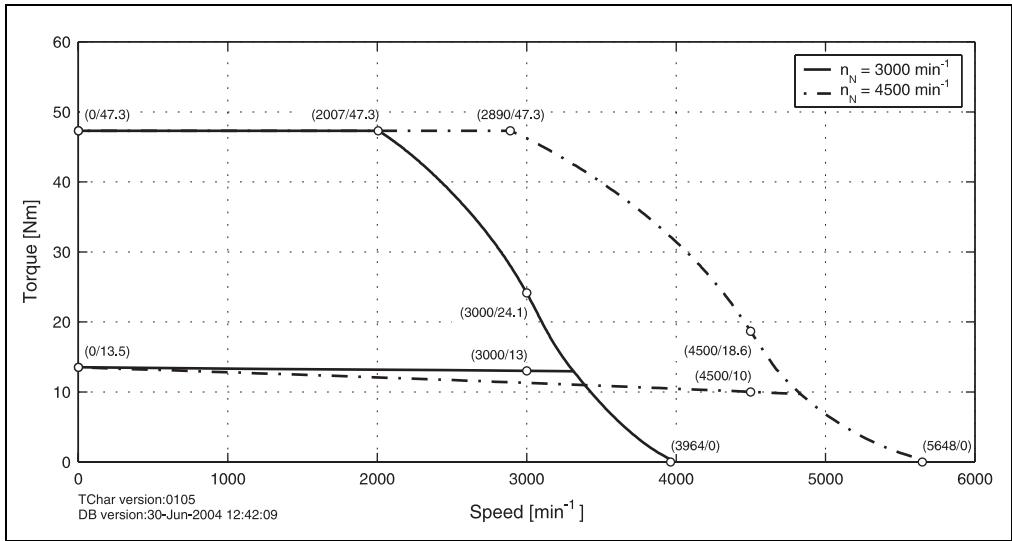

Figure 24: Speed - torque characteristic curve for 8MSA6S.dd-eeff-1

8MSA6M.dd-eeff-1

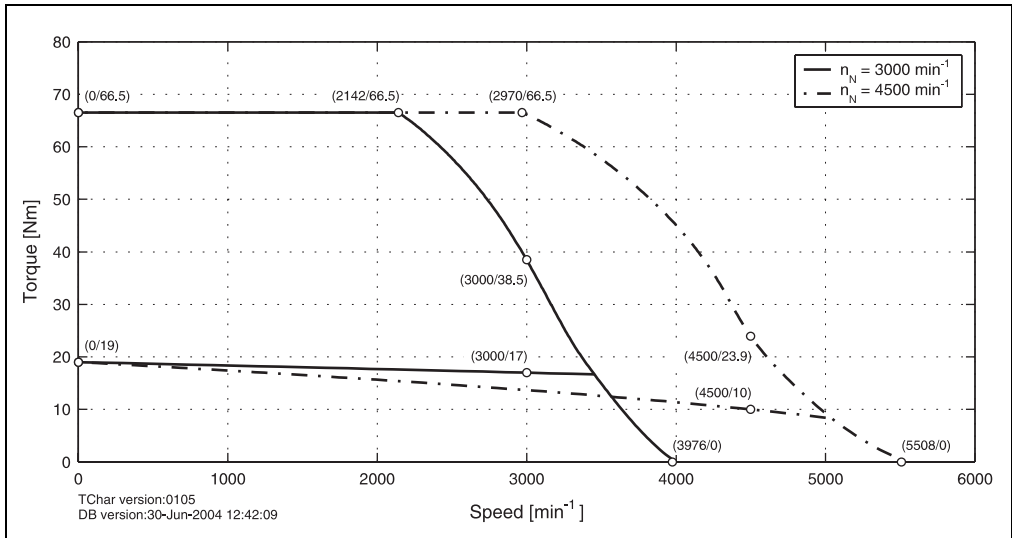

Figure 25: Speed - torque characteristic curve for 8MSA6M.dd-eeff-1

8MSA6L.dd-eeff-1

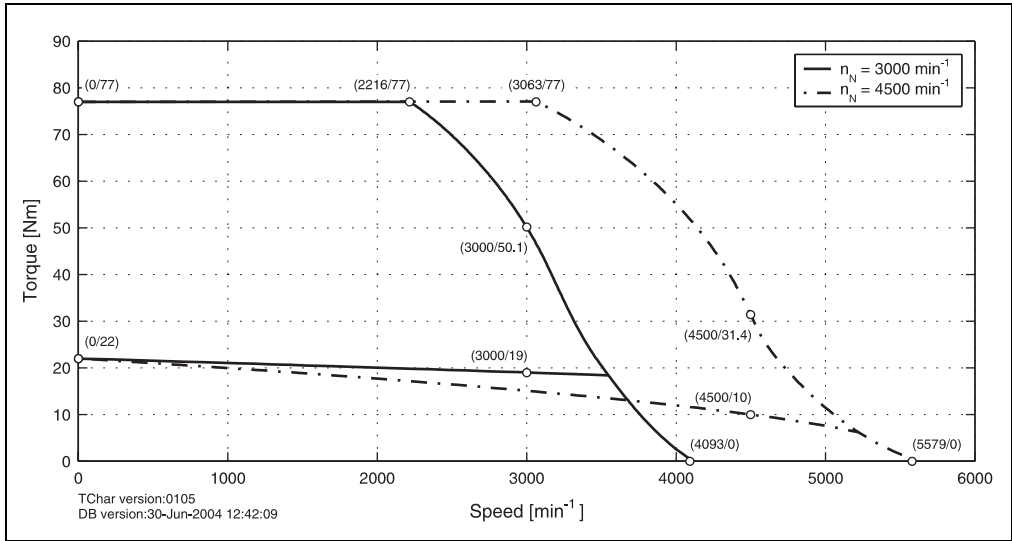

Figure 26: Speed - torque characteristic curve for 8MSA6L.dd-eeff-1

8MSA6X.dd-eeff-1

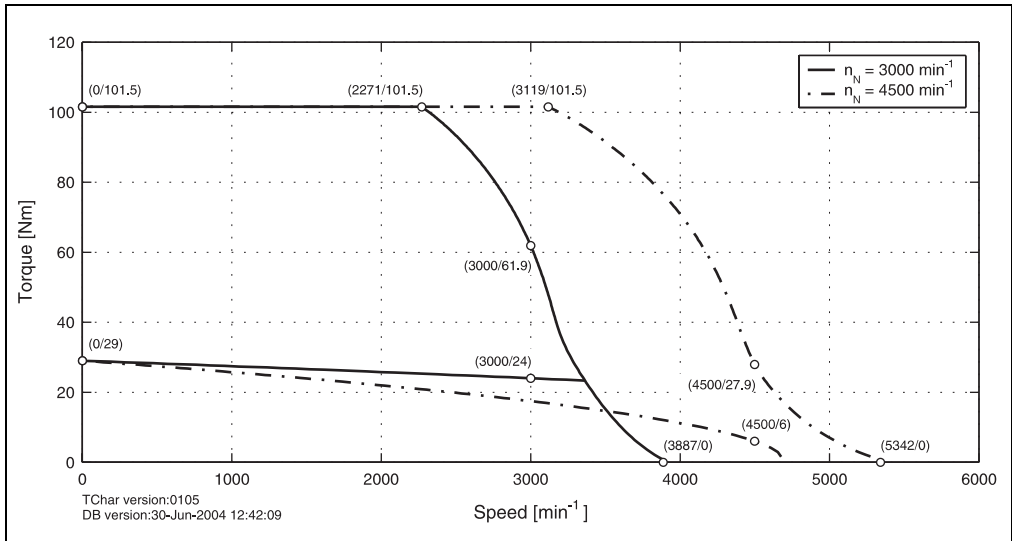
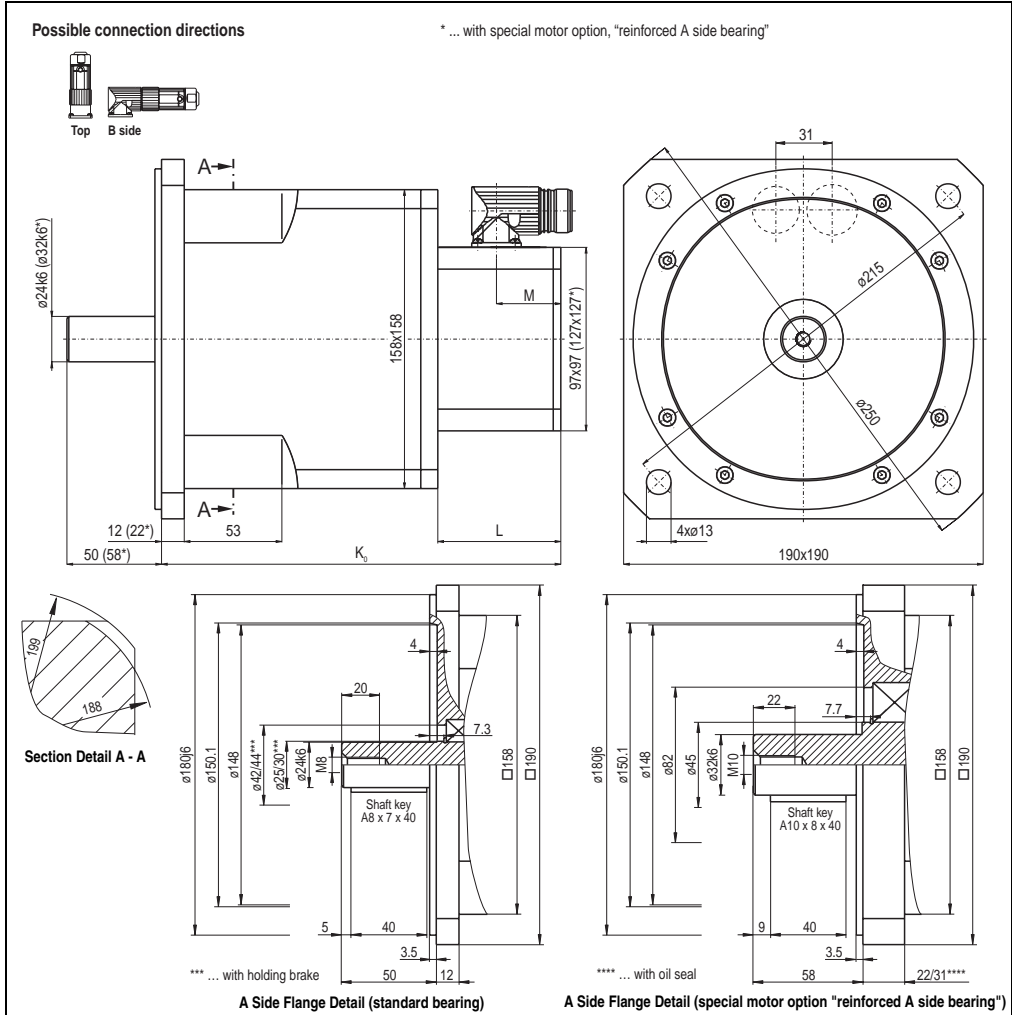

Figure 27: Speed - torque characteristic curve for 8MSA6X.dd-eeff-1

1.1.3.3 Dimensions



EnDat Feedback				Resolver Feedback				Extension of K_0 depending on the Motor Option [mm] ¹⁾		
Model Number	K_0	L	M	Model Number	K_0	L	M	Holding brake	Oil seal	Reinforced A side bearing
8MSA6S.Ex-eeff-1	221	65	26	8MSA6S.R0-eeff-1	202	46	20	53	Approx. 10	41 (60) ²⁾
8MSA6M.Ex-eeff-1	255			8MSA6M.R0-eeff-1	236					
8MSA6L.Ex-eeff-1	272			8MSA6L.R0-eeff-1	253					
8MSA6X.Ex-eeff-1	330			8MSA6X.R0-eeff-1	311			46		34 (53) ²⁾

Table 29: 8MSA6 dimensions

- 1) If a combination of motor options is used (e.g. holding brake and oil seal), the sum of the extensions for the individual motor options must be added to K_0 .
- 2) The value in parentheses is only valid for motors with resolver feedback.

1.13.4 Maximum Shaft Load

The values in the diagrams below are based on a mechanical lifespan of the bearings of 20,000 operating hours.

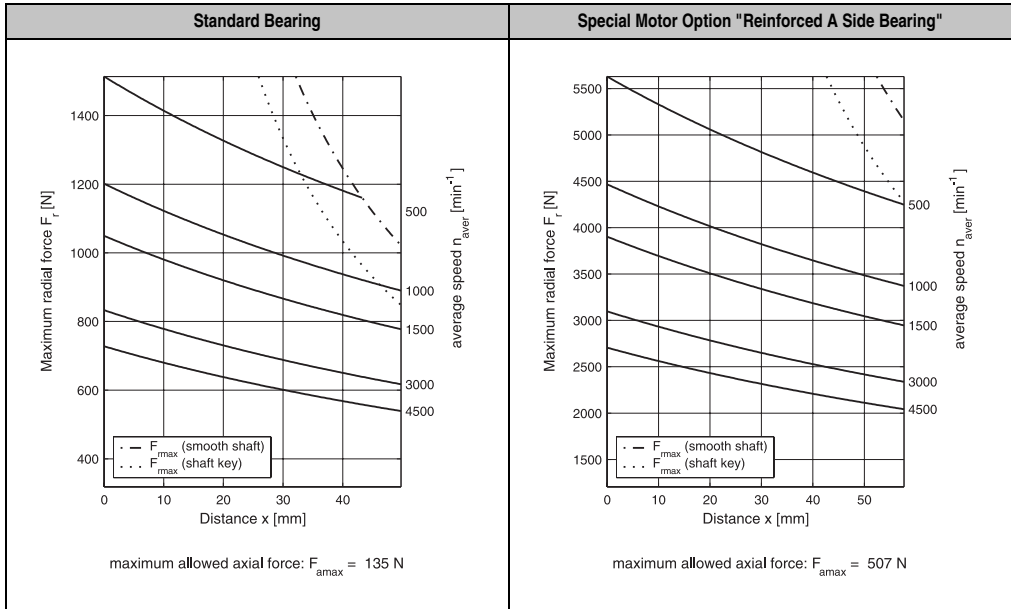

Table 30: Maximum shaft load for 8MSA6

1.14 Motor Data 8MSA7

1.14.1 Technical Data

	8MSA7S.dd-eeff		8MSA7M.dd-eeff		8MSA7L.dd-eeff
Rated Speed n_N [min ⁻¹]	3000	4500	3000	4500	3000
Rated Torque M_N [Nm]	20	14.5	23	15	26
Rated Power P_N [kW]	6.28	6.83	7.23	7.07	8.17
Rated Current I_N [A]	14.1	15.8	16.8	14.5	17.3
Stall Torque M_0 [Nm]	26		32		40
Stalled Current I_0 [A]	16.9	25.35	21.26	26.87	23.94
Peak Torque M_{max} [Nm]	78		96		120
Peak Current I_{max} [A]	65.9	98.9	82.9	104.8	93
Maximum Rotational Acceleration without Brake a [rad/s ²]	11642		11852		11881
Maximum Speed n_{max} [min ⁻¹]	6000		6000		4500
Torque Constant K_T [Nm/A]	1.54	1.03	1.51	1.19	1.67
Voltage Constant K_E [V/1000 min ⁻¹]	93	62	91	72	101
Stator Resistance R_{2ph} [Ω]	0.46	0.2	0.3	0.19	0.27
Stator Inductance L_{2ph} [mH]	5.1	2.2	3.7	2.2	3.4
Electrical Time Constant t_{el} [ms]	11.09	11	12.33	11.58	12.59
Thermal Time Constant t_{therm} [min]	60		67		70
Moment of Inertia without Brake J [kgcm ²]	67		81		101
Weight without Brake m [kg]	22.3		26.2		32
Moment of Inertia for Brake J_{Br} [kgcm ²]	5.56		5.56		5.56
Weight of Brake m_{Br} [kg]	1.6		1.6		1.6
Holding Torque of the Brake M_{Br} [Nm]	32		32		32
Recommended Cable Cross Section for B&R Motor Cables [mm ²] ¹⁾	4		4		4
Recommended ACOPOS Servo Drive 8Vxxx.00-x ²⁾	1180	1320	1320		1320

Table 31: Technical data for 8MSA7

- 1) The B&R motor cables with this cable cross section are produced optimally (stripping length) for the recommended ACOPOS servo drives (see next line). B&R motor cables with other cable cross sections can also be used (within the specified terminal cross section range) and can be obtained from B&R in the desired design on request.
- 2) The recommended servo drive is defined for the stall current of the motor; if more than double the stall torque is required during the acceleration phase, the next larger servo drive should be selected. This recommendation is only a guideline, detailed inspection of the corresponding speed - torque characteristic curve can result in deviations of the servo drive size (one size larger or smaller).
The speed - torque characteristic curves shown in the following sections always refer to the smallest recommended servo drive for the motor length!

1.14.2 Speed-Torque Characteristic Curves with 400 VAC Supply Voltage

8MSA7S.dd-eeff

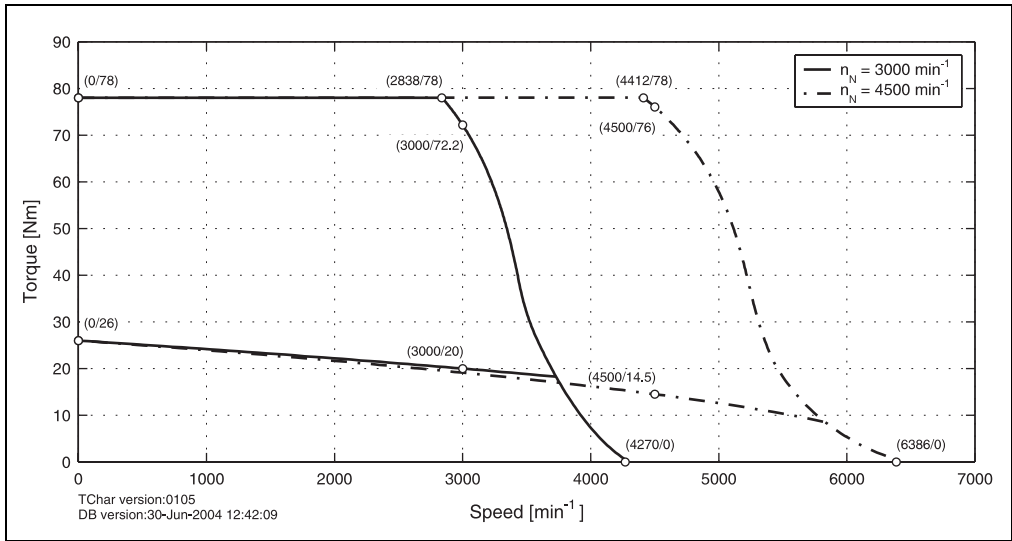

Figure 28: Speed - torque characteristic curve for 8MSA7S.dd-eeff

8MSA7M.dd-eeff

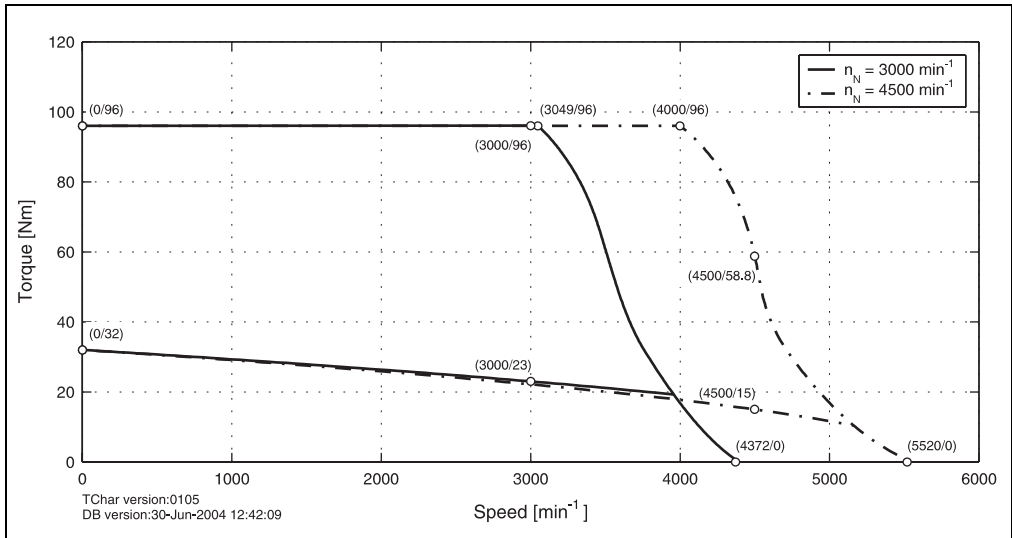

Figure 29: Speed - torque characteristic curve for 8MSA7M.dd-eeff

8MSA7L.dd-eeff

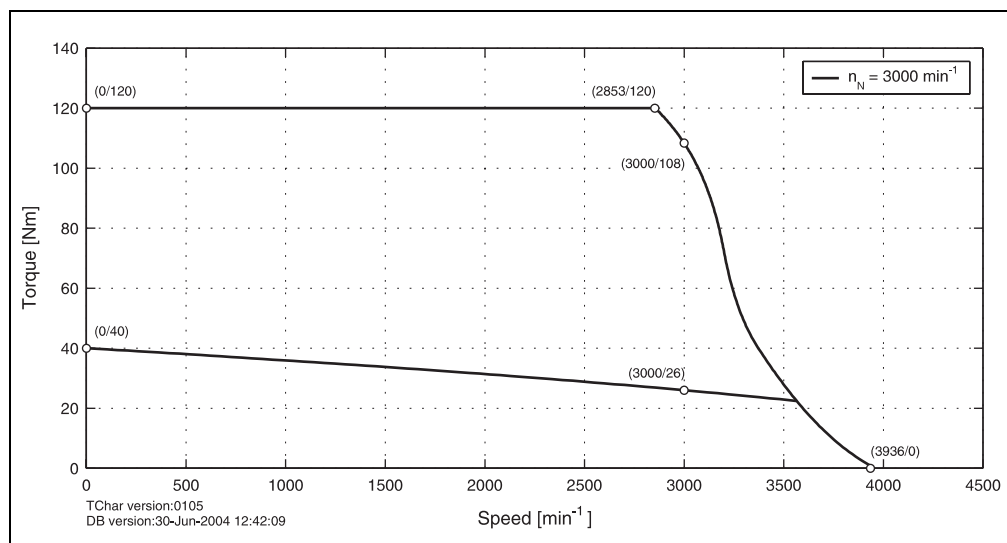
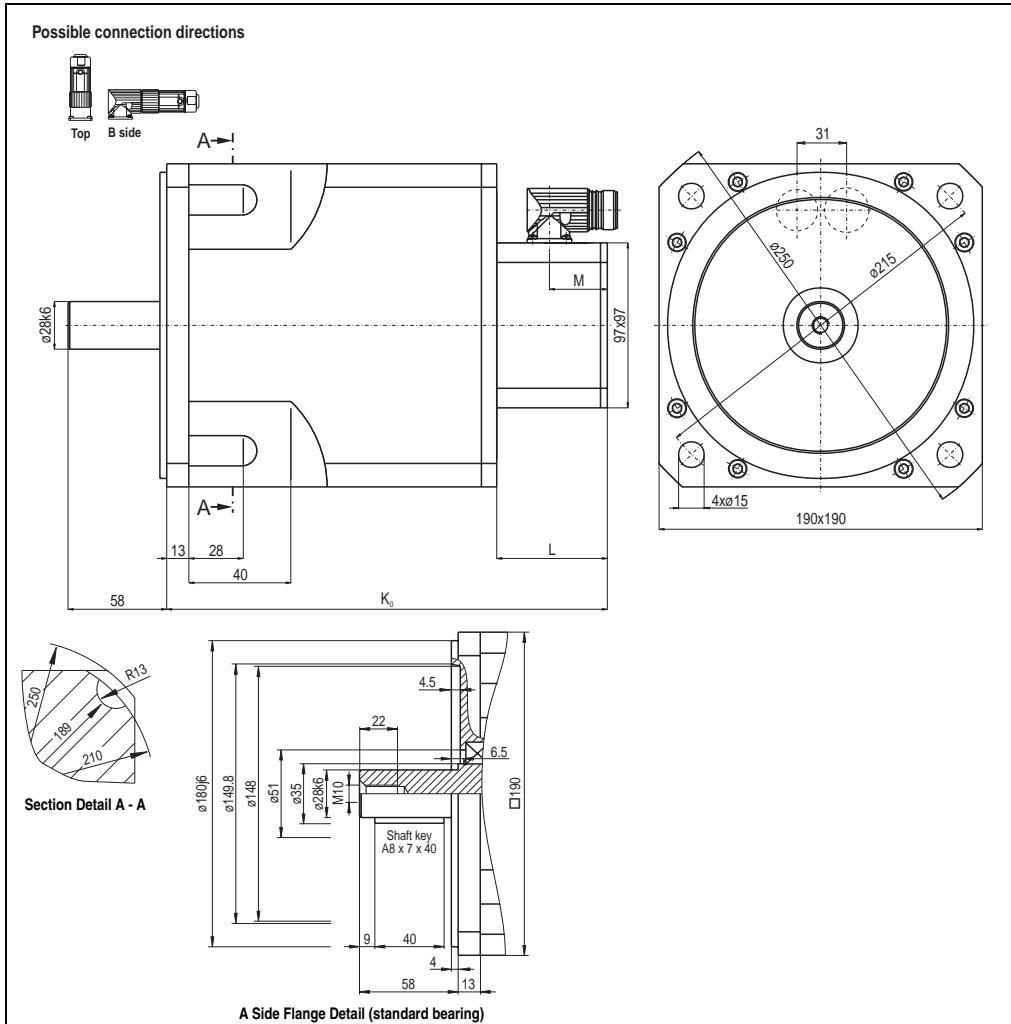

Figure 30: Speed - torque characteristic curve for 8MSA7L.dd-eeff

1.14.3 Dimensions



Chapter 2
Technical Data

EnDat Feedback				Resolver Feedback				Extension of K_0 depending on the Motor Option [mm] ¹⁾			
Model Number	K_0	L	M	Model Number	K_0	L	M	Holding brake	Oil seal	Reinforced A side bearing	
8MSA7S.Ex-eeff	259	65	26	8MSA7S.R0-eeff	240	46	20	44	Approx. 10	---	
8MSA7M.Ex-eeff	282			8MSA7M.R0-eeff	263						
8MSA7L.Ex-eeff	316.5			8MSA7L.R0-eeff	297.5						

Table 32: 8MSA7 dimensions

1) If a combination of motor options is used (e.g. holding brake and oil seal), the sum of the extensions for the individual motor options must be added to K_0 .

1.14.4 Maximum Shaft Load

The values in the diagrams below are based on a mechanical lifespan of the bearings of 20,000 operating hours.

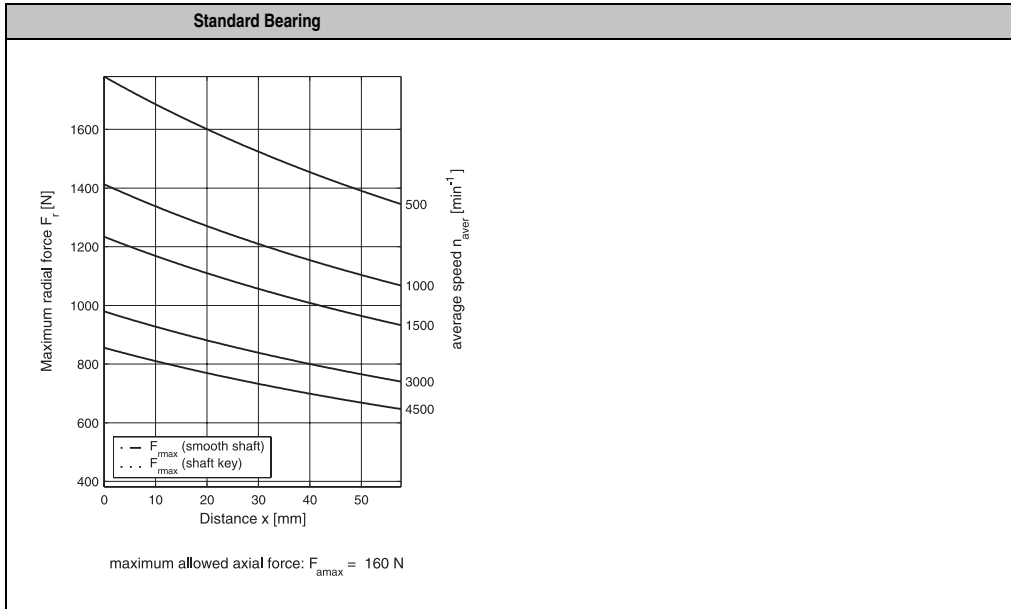

Table 33: Maximum shaft load for 8MSA4

1.15 Motor Data 8MSA8

1.15.1 Technical Data

	8MSA8S.dd-eeff	8MSA8M.dd-eeff	8MSA8L.dd-eeff	8MSA8X.dd-eeff
Rated Speed n_N [min^{-1}]	3000	3000	2000	2000
Rated Torque M_N [Nm]	30	50	70	85
Rated Power P_N [kW]	9.42	15.71	14.66	17.80
Rated Current I_N [A]	17.8	27.8	29.1	35.8
Stall Torque M_0 [Nm]	40	68	93	115
Stalled Current I_0 [A]	21.79	35.75	37.99	46.66
Peak Torque M_{max} [Nm]	120	204	279	345
Peak Current I_{max} [A]	85	139.4	148.2	182
Maximum Rotational Acceleration without Brake a [rad/s^2]	15769	17958	18283	18148
Maximum Speed n_{max} [min^{-1}]	3600	3600	3600	3600
Torque Constant K_T [Nm/A]	1.84	1.90	2.45	2.46
Voltage Constant K_E [V/1000 min^{-1}]	111	115	148	149
Stator Resistance $R_{2\text{ph}}$ [Ω]	0.25	0.13	0.12	0.09
Stator Inductance $L_{2\text{ph}}$ [mH]	5.7	3.3	3.7	2.8
Electrical Time Constant t_{el} [ms]	22.8	25.38	30.83	31.11
Thermal Time Constant t_{therm} [min]	47	65	79	90
Moment of Inertia without Brake J [kgcm^2]	76.1	113.6	152.6	190.1
Weight without Brake m [kg]	41	56	73	89
Moment of Inertia for Brake J_{Br} [kgcm^2]	53	53	53	53
Weight of Brake m_{Br} [kg]	5.35	5.35	5.35	5.35
Holding Torque of the Brake M_{Br} [Nm]	130	130	130	130
Recommended Cable Cross Section for B&R Motor Cables [mm^2] ¹⁾	4	4	10	10
Recommended ACOPOS Servo Drive 8Vxxx.00-x ²⁾	1320	1320	1640	1640

Table 34: Technical data for 8MSA8

- 1) The B&R motor cables with this cable cross section are produced optimally (stripping length) for the recommended ACOPOS servo drives (see next line). B&R motor cables with other cable cross sections can also be used (within the specified terminal cross section range) and can be obtained from B&R in the desired design on request.
- 2) The recommended servo drive is defined for the stall current of the motor; if more than double the stall torque is required during the acceleration phase, the next larger servo drive should be selected. This recommendation is only a guideline, detailed inspection of the corresponding speed - torque characteristic curve can result in deviations of the servo drive size (one size larger or smaller).
The speed - torque characteristic curves shown in the following sections always refer to the smallest recommended servo drive for the motor length!

1.15.2 Speed-Torque Characteristic Curves with 400 VAC Supply Voltage

8MSA8S.dd-eeff

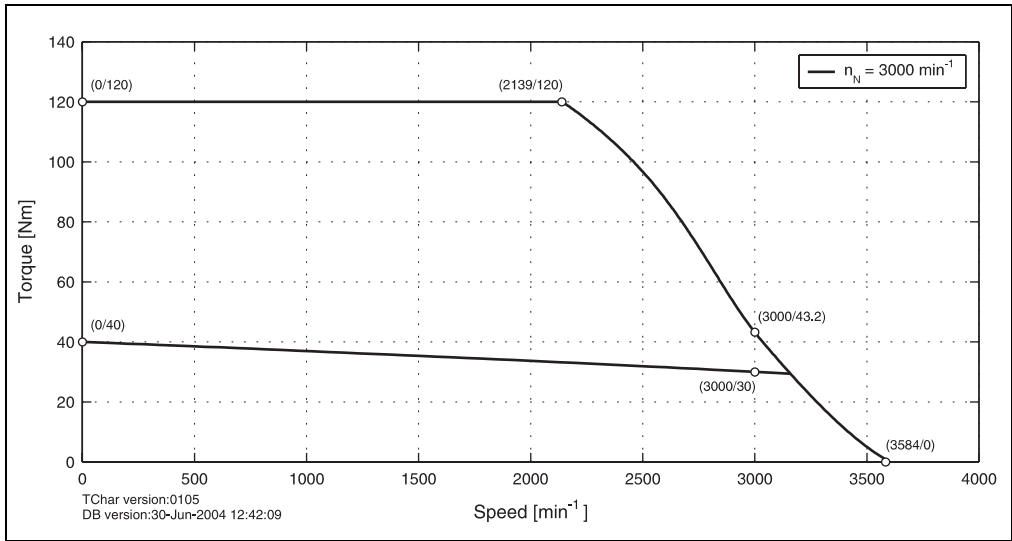

Figure 31: Speed - torque characteristic curve for 8MSA8S.dd-eeff

8MSA8M.dd-eeff

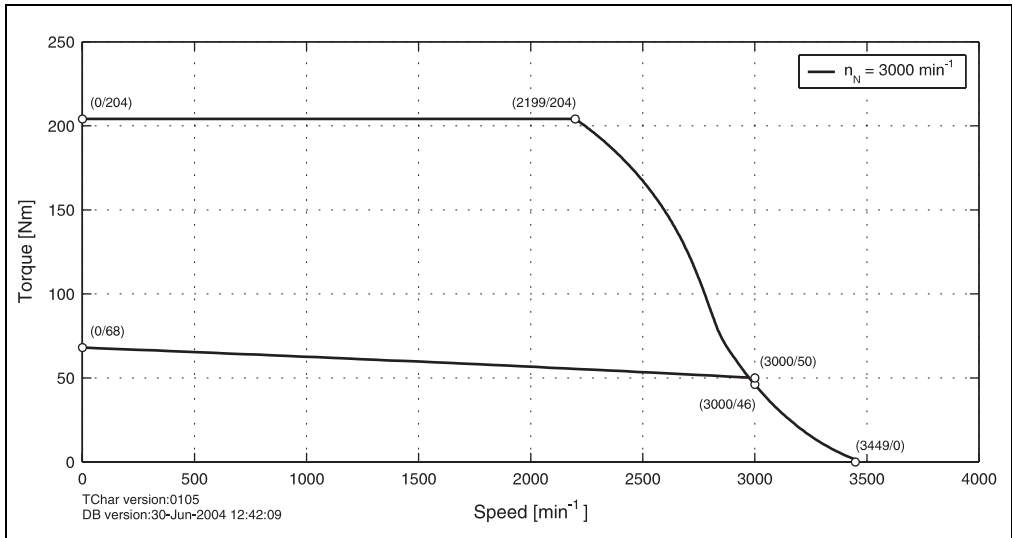

Figure 32: Speed - torque characteristic curve for 8MSA8M.dd-eeff

8MSA8L.dd-eeff

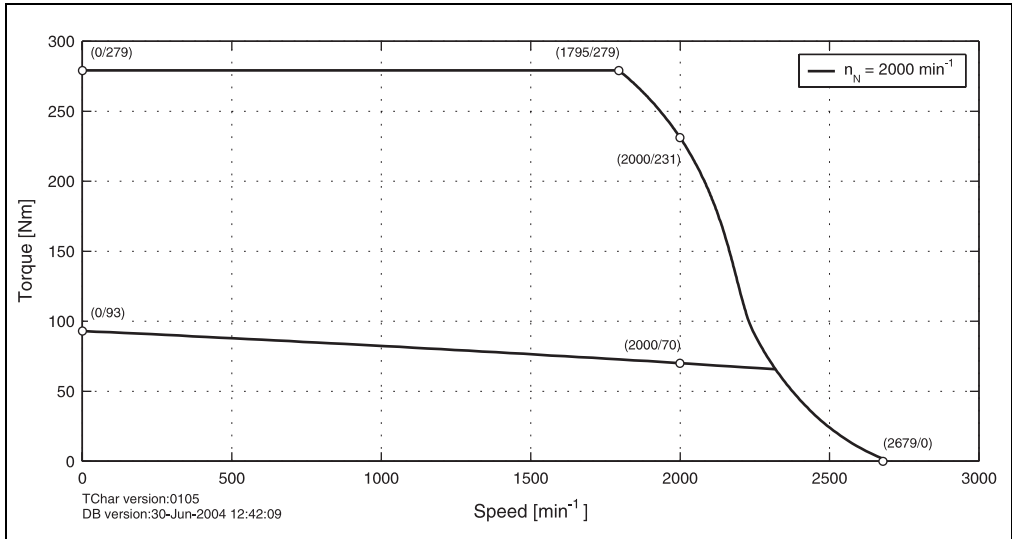

Figure 33: Speed - torque characteristic curve for 8MSA8L.dd-eeff

8MSA8X.dd-eeff

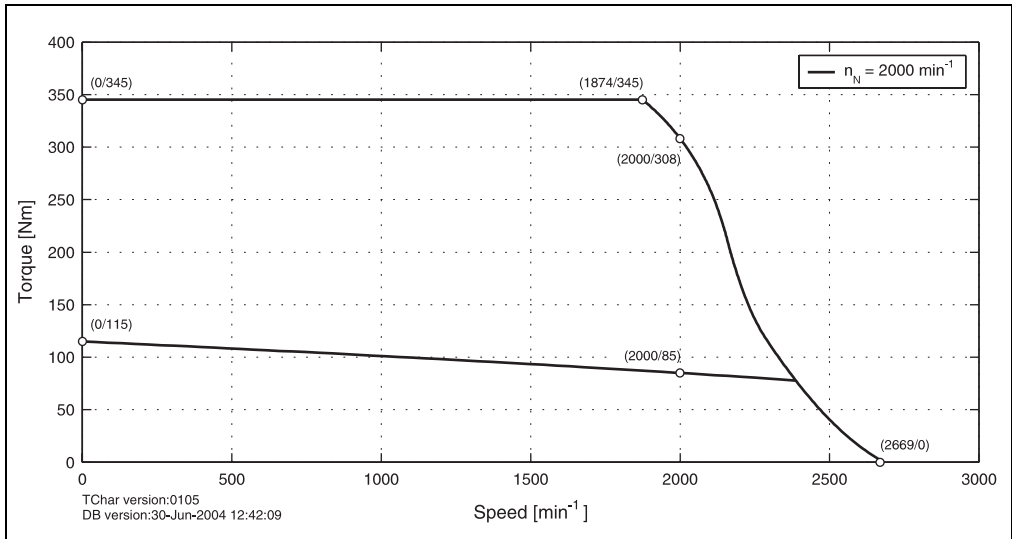
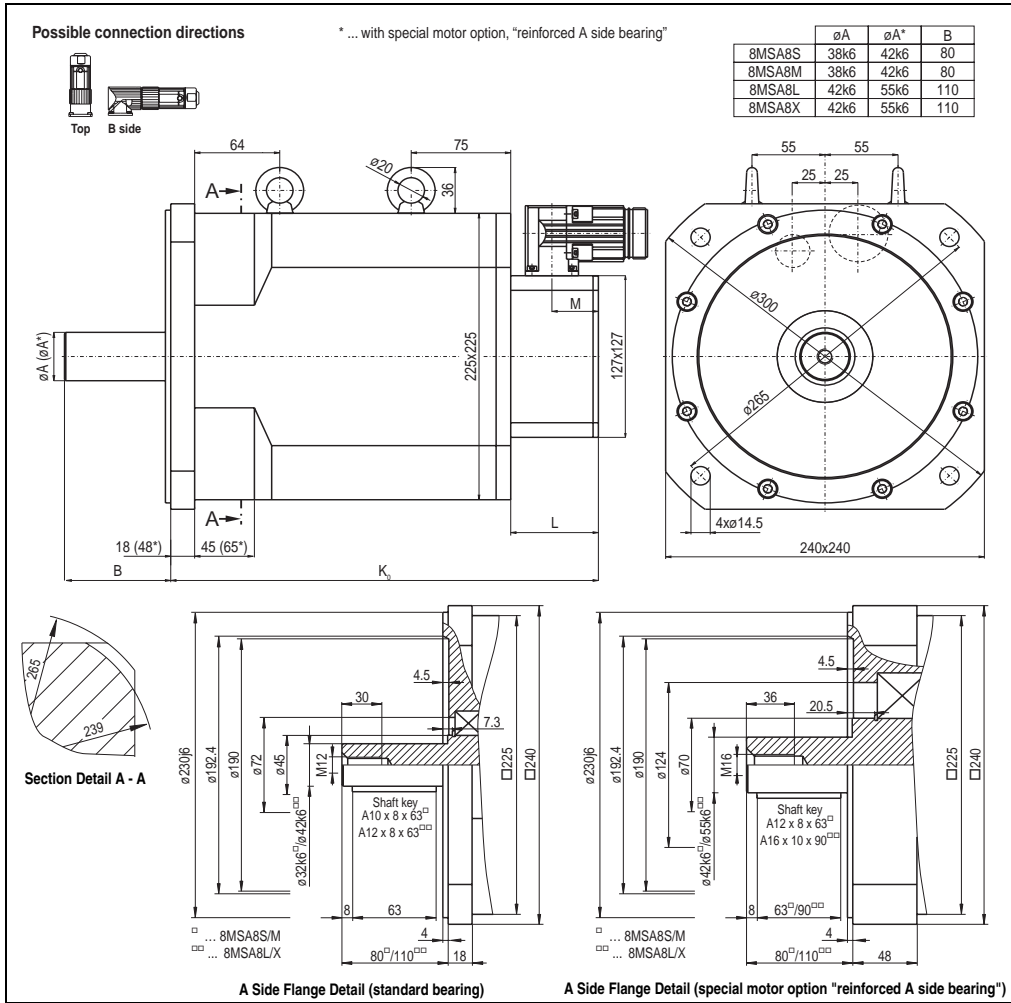

Figure 34: Speed - torque characteristic curve for 8MSA8X.dd-eeff

1.15.3 Dimensions



EnDat Feedback				Resolver Feedback				Extension of K ₀ depending on the Motor Option [mm] ¹⁾		
Model Number	K ₀	L	M	Model Number	K ₀	L	M	Holding brake	Oil seal	Reinforced A side bearing
8MSA8S.Ex-eeff	322	66	35	8MSA8S.R0-eeff	311	55	30	68	Approx. 10	45
8MSA8M.Ex-eeff	390			8MSA8M.R0-eeff	379					
8MSA8L.Ex-eeff	458			8MSA8L.R0-eeff	447					
8MSA8X.Ex-eeff	526			8MSA8X.R0-eeff	515					

Table 35: 8MSA8 dimensions

1) If a combination of motor options is used (e.g. holding brake and oil seal), the sum of the extensions for the individual motor options must be added to K₀.

1.15.4 Maximum Shaft Load

The values in the diagrams below are based on a mechanical lifespan of the bearings of 20,000 operating hours.

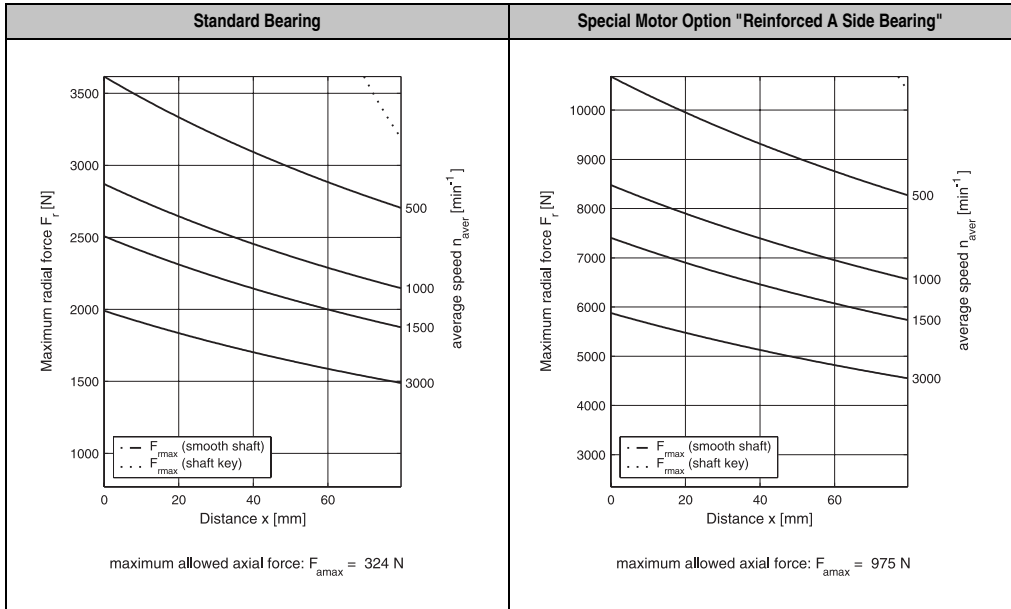

Table 36: Maximum shaft load for 8MSA8

1.16 Motor Data Overview for Cooling Type C

The technical data listed in this section (K_E , K_T , I_N , I_0 , I_{max} , R_{2PH} , L_{2PH} , t_{el} , t_{therm} , m , J) has a theoretical tolerance range of $\pm 10\%$. This is also valid for the speed - torque characteristic curves represented in the following sections.

	8MSC4S.dd-eef			8MSC4M.dd-eef			8MSC4L.dd-eef			8MSC4X.dd-eef		
	3000	4500	6000	3000	4500	6000	3000	4500	6000	3000	4500	6000
Rated Speed n_N [min ⁻¹]	3000	4500	6000	3000	4500	6000	3000	4500	6000	3000	4500	6000
Rated Torque M_N [Nm]	2.99	2.47	1.56	5.98	5.33	3.9	8.32	7.28	5.85	11.05	9.75	7.8
Rated Power P_N [kW]	0.94	1.16	0.98	1.88	2.51	2.45	2.61	3.43	3.68	3.47	4.59	4.90
Rated Current I_N [A]	2.41	2.93	2.28	4.88	5.72	5.53	5.66	7.28	7.8	7.8	8.45	10.01
Stall Torque M_0 [Nm]	3.38			6.89			9.75			12.35		
Stalled Current I_0 [A]	2.5	3.59	4.17	5.34	6.94	8.87	6.27	9.07	11.79	8.29	10.09	14.64
Peak Torque M_{max} [Nm]	10.4			21.2			30			38		
Peak Current I_{max} [A]	11.5	16.5	19.6	25.1	32.6	40.9	29.4	41.9	55.3	38.3	46.6	67.6
Maximum Rotational Acceleration without Brake a [rad/s ²]	54737			80000			72289			62810		
Maximum Speed n_{max} [min ⁻¹]	12000			12000			12000			12000		
Torque Constant K_T [Nm/A]	1.36	0.94	0.81	1.29	0.99	0.78	1.56	1.08	0.83	1.49	1.22	0.84
Voltage Constant K_E [V/1000 min ⁻¹]	82	57	49	78	60	47	94	65	50	90	74	51
Stator Resistance R_{2ph} [Ω]	9.6	4.55	3.3	4.2	2.55	1.55	3	1.45	0.87	1.65	1.13	0.59
Stator Inductance L_{2ph} [mH]	41.5	20.5	15	24	14.5	8.9	19.2	9.2	5.6	11.7	7.9	4.1
Electrical Time Constant t_{el} [ms]	4.32	4.51	4.55	5.71	5.69	5.74	6.4	6.34	6.44	7.09	6.99	6.95
Thermal Time Constant t_{therm} [min]	60			64			66			68		
Moment of Inertia without Brake J [kgcm ²]	1.9			2.65			4.15			6.05		
Weight without Brake m [kg]	4.5			5.6			7.7			10.5		
Moment of Inertia for Brake J_B [kgcm ²]	0.54			0.54			0.54			0.54		
Weight of Brake m_B [kg]	0.46			0.46			0.46			0.46		
Holding Torque of the Brake M_B [Nm]	8			8			8			8		
Recommended Cable Cross Section for B&R Motor Cables [mm ²] ¹⁾	1.5			1.5			1.5			4		
Recommended ACOPOS Servo Drive 8Vxxx.00-x ²⁾	1045			1090			1090			1180		

Tabelle 37: Motor data overview for cooling type C

- 1) The B&R motor cables with this cable cross section are produced optimally (stripping length) for the recommended ACOPOS servo drives (see next line). B&R motor cables with other cable cross sections can also be used (within the specified terminal cross section range) and can be obtained from B&R in the desired design on request.
- 2) The recommended servo drive is defined for the stall current of the motor; if more than double the stall torque is required during the acceleration phase, the next larger servo drive should be selected. This recommendation is only a guideline, detailed inspection of the corresponding speed - torque characteristic curve can result in deviations of the servo drive size (one size larger or smaller).
The speed - torque characteristic curves shown in the following sections always refer to the smallest recommended servo drive for the motor length!

	8MSC5S.dd-eeff-2		8MSC5M.dd-eeff-2		8MSC5L.dd-eeff-2		8MSC5X.dd-eeff-2		8MSC5E.dd-eeff-2		8MSC6S.dd-eeff-2	
Rated Speed n_N [min ⁻¹]	3000	4500	3000	4500	3000	4500	3000	4500	3000	4500	3000	4500
Rated Torque M_N [Nm]	7.41	6.76	11.44	9.36	14.3	11.7	18.85	14.3	22.75	17.55	16.9	13
Rated Power P_N [kW]	2.33	3.19	3.59	4.41	4.49	5.51	5.92	6.74	7.15	8.27	5.31	6.13
Rated Current I_N [A]	5.2	6.76	7.15	9.62	9.49	11.57	11.18	14.17	13.65	18.98	10.66	11.83
Stall Torque M_0 [Nm]	8.58		13.65		17.55		22.1		28.6		17.55	
Stalled Current I_0 [A]	5.89	8.37	8.26	13.53	11.28	16.85	12.84	21.2	16.63	28.35	10.61	15.16
Peak Torque M_{max} [Nm]	19.8		31.5		40.5		51		66		47.3	
Peak Current I_{max} [A]	22.6	32	31.6	52	43.2	64.5	49.2	81.2	63.7	108.6	40	57
Maximum Rotational Acceleration without Brake a [rad/s ²]	49500		50806		55479		53684		56410		36107	
Maximum Speed n_{max} [min ⁻¹]	9000		9000		9000		9000		9000		6000	
Torque Constant K_T [Nm/A]	1.46	1.03	1.65	1.01	1.56	1.04	1.72	1.04	1.72	1.01	1.65	1.16
Voltage Constant K_E [V/1000 min ⁻¹]	88	62	100	61	94	63	104	63	104	61	100	70
Stator Resistance R_{2ph} [Ω]	4.15	2.05	2.25	0.83	1.55	0.68	1.26	0.46	0.95	0.33	1.1	0.56
Stator Inductance L_{2ph} [mH]	27.8	13.8	20	7.4	14.6	6.5	13.3	4.8	10.5	3.6	13.5	6.7
Electrical Time Constant t_{el} [ms]	6.7	6.73	8.89	8.92	9.42	9.56	10.56	10.43	11.05	10.91	12.27	11.96
Thermal Time Constant t_{therm} [min]	45		50		55		60		75		45	
Moment of Inertia without Brake J [kgcm ²]	4		6.2		7.3		9.5		11.7		13.1	
Weight without Brake m [kg]	7.5		10		11.2		13.7		16.2		13.9	
Moment of Inertia for Brake J_{Br} [kgcm ²]	1.66		1.66		1.66		1.66		1.66		5.56	
Weight of Brake m_{Br} [kg]	0.9		0.9		0.9		0.9		0.9		1.6	
Holding Torque of the Brake M_{Br} [Nm]	15		15		15		15		15		32	
Recommended Cable Cross Section for B&R Motor Cables [mm ²] ¹⁾	1.5		1.5		4		4		4		4	
Recommended ACOPOS Servo Drive 8Vxxx.00-x ²⁾	1090		1090		1180		1180		1180		1320	

Table 37: Motor data overview for cooling type C (cont.)

- 1) The B&R motor cables with this cable cross section are produced optimally (stripping length) for the recommended ACOPOS servo drives (see next line). B&R motor cables with other cable cross sections can also be used (within the specified terminal cross section range) and can be obtained from B&R in the desired design on request.
- 2) The recommended servo drive is defined for the stall current of the motor; if more than double the stall torque is required during the acceleration phase, the next larger servo drive should be selected. This recommendation is only a guideline, detailed inspection of the corresponding speed - torque characteristic curve can result in deviations of the servo drive size (one size larger or smaller).
The speed - torque characteristic curves shown in the following sections always refer to the smallest recommended servo drive for the motor length!

	8MSC6M.dd-eeff-2		8MSC6L.dd-eeff-2		8MSC6X.dd-eeff-2		8MSC7S.dd-eeff-1	8MSC7M.dd-eeff-1	8MSC7L.dd-eeff-1
Rated Speed n_N [min ⁻¹]	3000	4500	3000	4500	3000	4500	3000	3000	3000
Rated Torque M_N [Nm]	22.1	13	24.7	13	31.2	7.8	26	29.9	33.8
Rated Power P_N [kW]	6.94	6.13	7.76	6.13	9.80	3.68	8.17	9.39	10.62
Rated Current I_N [A]	13.78	11.7	15.99	11.96	19.11	7.41	18.33	21.84	22.49
Stall Torque M_0 [Nm]	24.7		28.6		37.7		33.8	41.6	52
Stalled Current I_0 [A]	14.94	20.74	17.82	24.35	22.35	30.8	21.97	27.64	31.12
Peak Torque M_{max} [Nm]	66.5		77		101.5		78	96	120
Peak Current I_{max} [A]	56	79	67.2	92	84	116	65.9	82.9	93
Maximum Rotational Acceleration without Brake a [rad/s ²]	35561		35814		34407		11642	11852	11881
Maximum Speed n_{max} [min ⁻¹]	6000		6000		6000		6000	6000	4500
Torque Constant K_T [Nm/A]	1.65	1.19	1.60	1.17	1.69	1.22	1.54	1.51	1.67
Voltage Constant K_E [V/1000 min ⁻¹]	100	72	97	71	102	74	93	91	101
Stator Resistance R_{2ph} [Ω]	0.61	0.32	0.46	0.25	0.31	0.16	0.46	0.3	0.27
Stator Inductance L_{2ph} [mH]	9	4.7	7.3	3.9	5.6	3	5.1	3.7	3.4
Electrical Time Constant t_{el} [ms]	14.75	14.69	15.87	15.6	18.06	18.75	11.09	12.33	12.59
Thermal Time Constant t_{therm} [min]	53		60		70		60	67	70
Moment of Inertia without Brake J [kgcm ²]	18.7		21.5		29.5		67	81	101
Weight without Brake m [kg]	18.2		20.3		26.7		22.3	26.2	32
Moment of Inertia for Brake J_{Br} [kgcm ²]	5.56		5.56		5.56		5.56	5.56	5.56
Weight of Brake m_{Br} [kg]	1.6		1.6		1.6		1.6	1.6	1.6
Holding Torque of the Brake M_{Br} [Nm]	32		32		32		32	32	32
Recommended Cable Cross Section for B&R Motor Cables [mm ²] ¹⁾	4		4		4		4	4	4
Recommended ACOPOS Servo Drive 8Vxxx.00-x ²⁾	1180		1180	1320	1320		1320	1320	1320

Table 37: Motor data overview for cooling type C (cont.)

- 1) The B&R motor cables with this cable cross section are produced optimally (stripping length) for the recommended ACOPOS servo drives (see next line). B&R motor cables with other cable cross sections can also be used (within the specified terminal cross section range) and can be obtained from B&R in the desired design on request.
- 2) The recommended servo drive is defined for the stall current of the motor; if more than double the stall torque is required during the acceleration phase, the next larger servo drive should be selected. This recommendation is only a guideline, detailed inspection of the corresponding speed - torque characteristic curve can result in deviations of the servo drive size (one size larger or smaller).
The speed - torque characteristic curves shown in the following sections always refer to the smallest recommended servo drive for the motor length!

1.16.1 Fan Modules

Overview

The fan modules used are size-dependant and available for two different operating voltages .

Fans	For Motor			
	8MSC4	8MSC5	8MSC6	8MSC7
Manufacturer Internet Address	Papst www.papst.de			
Manufacturer's Product ID 220 VAC Operating Voltage 24 VDC Operating Voltage ¹⁾	4650Z 4184NGX		5958 5214NM	

Tabelle 38: Overview of fan modules

1) Fans with 24VDC operating voltage are special motor options.

Technical Data

Manufacturer's Product ID	220 VAC Fan		24 VDC Fan ¹⁾	
	4650Z	5958	4184NGX	5214NM
General Information				
C-UL-US Listed	Yes			
Fan Type	AC fan with external rotor shaded-pole motor	AC fan with internal rotor shaded-pole motor	DC fan with electronically commutated external rotor motor	
Rotor Bearings	Sintec sleeve bearings	Ball bearings	Sintec sleeve bearings	Ball bearings
Protection	IP20			
Power mains connection				
Rated Voltage	230 VAC +6 % / -10 %		24 VDC +25 % / -50 %	24 VDC +16 % / -50 %
Nominal Frequency	50 Hz		---	
Power Consumption	19 W	18 W	3.5 W	4.6 W
Overload Protection	Yes (impedance protection)		Protected against blocking and overloading by PTC resistor; partially impedance protected	Electronic protection against reverse polarity, blocking and overloading
Mechanical Characteristics				
Temperature Range	-10 ... +50 °C	-30 ... +60 °C	-10 ... +75 °C	-20 ... +75 °C
Operating Noise	40 dB(A)	44 dB(A)	44 dB(A)	43 dB(A)
Lifespan				
At 40° C	37500 h	40000 h	85000 h	62500 h
At Maximum Temperature	30000 h	25000 h	37500 h	27500 h

Tabelle 39: Technical data for fans

1) Fans with 24VDC operating voltage are special motor options.

1.17 Motor Data 8MSC4

1.17.1 Technical Data

	8MSC4S.dd-eeff			8MSC4M.dd-eeff			8MSC4L.dd-eeff			8MSC4X.dd-eeff		
Rated Speed n_N [min ⁻¹]	3000	4500	6000	3000	4500	6000	3000	4500	6000	3000	4500	6000
Rated Torque M_N [Nm]	2.99	2.47	1.56	5.98	5.33	3.9	8.32	7.28	5.85	11.05	9.75	7.8
Rated Power P_N [kW]	0.94	1.16	0.98	1.88	2.51	2.45	2.61	3.43	3.68	3.47	4.59	4.90
Rated Current I_N [A]	2.41	2.93	2.28	4.88	5.72	5.53	5.66	7.28	7.8	7.8	8.45	10.01
Stall Torque M_0 [Nm]	3.38			6.89			9.75			12.35		
Stalled Current I_0 [A]	2.5	3.59	4.17	5.34	6.94	8.87	6.27	9.07	11.79	8.29	10.09	14.64
Peak Torque M_{max} [Nm]	10.4			21.2			30			38		
Peak Current I_{max} [A]	11.5	16.5	19.6	25.1	32.6	40.9	29.4	41.9	55.3	38.3	46.6	67.6
Maximum Rotational Acceleration without Brake a [rad/s ²]	54737			80000			72289			62810		
Maximum Speed n_{max} [min ⁻¹]	12000			12000			12000			12000		
Torque Constant K_T [Nm/A]	1.36	0.94	0.81	1.29	0.99	0.78	1.56	1.08	0.83	1.49	1.22	0.84
Voltage Constant K_E [V/1000 min ⁻¹]	82	57	49	78	60	47	94	65	50	90	74	51
Stator Resistance R_{2ph} [Ω]	9.6	4.55	3.3	4.2	2.55	1.55	3	1.45	0.87	1.65	1.13	0.59
Stator Inductance L_{2ph} [mH]	41.5	20.5	15	24	14.5	8.9	19.2	9.2	5.6	11.7	7.9	4.1
Electrical Time Constant t_{el} [ms]	4.32	4.51	4.55	5.71	5.69	5.74	6.4	6.34	6.44	7.09	6.99	6.95
Thermal Time Constant t_{therm} [min]	60			64			66			68		
Moment of Inertia without Brake J [kgcm ²]	1.9			2.65			4.15			6.05		
Weight without Brake m [kg]	4.5			5.6			7.7			10.5		
Moment of Inertia for Brake J_{Br} [kgcm ²]	0.54			0.54			0.54			0.54		
Weight of Brake m_{Br} [kg]	0.46			0.46			0.46			0.46		
Holding Torque of the Brake M_{Br} [Nm]	8			8			8			8		
Recommended Cable Cross Section for B&R Motor Cables [mm ²] ¹⁾	1.5			1.5			1.5		4	1.5		4
Recommended ACOPOS Servo Drive 8Vxxx.00-x ²⁾	1045			1090			1090		1180	1090		1180

Table 40: Technical data for 8MSC4

- 1) The B&R motor cables with this cable cross section are produced optimally (stripping length) for the recommended ACOPOS servo drives (see next line). B&R motor cables with other cable cross sections can also be used (within the specified terminal cross section range) and can be obtained from B&R in the desired design on request.
- 2) The recommended servo drive is defined for the stall current of the motor; if more than double the stall torque is required during the acceleration phase, the next larger servo drive should be selected. This recommendation is only a guideline, detailed inspection of the corresponding speed - torque characteristic curve can result in deviations of the servo drive size (one size larger or smaller).
The speed - torque characteristic curves shown in the following sections always refer to the smallest recommended servo drive for the motor length!

1.17.2 Speed-Torque Characteristic Curves with 400 VAC Supply Voltage

8MSC4S.dd-eeff

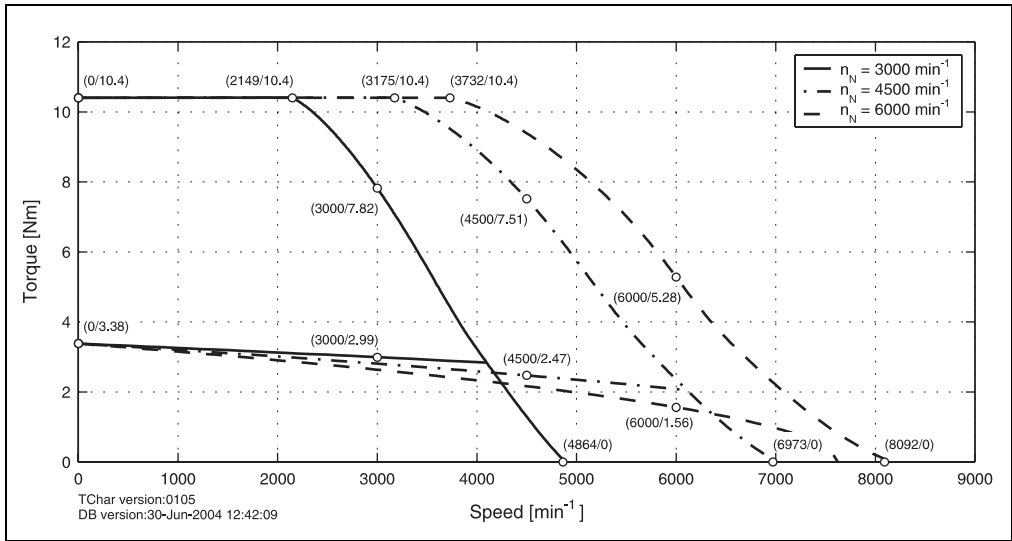

Figure 35: Speed - torque characteristic curve for 8MSC4S.dd-eeff

8MSC4M.dd-eeff

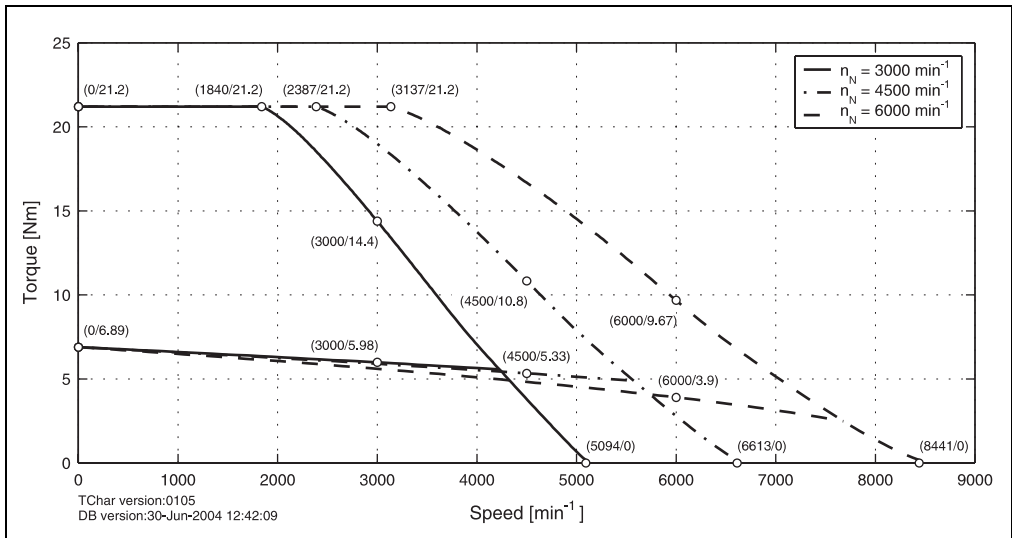

Figure 36: Speed - torque characteristic curve for 8MSC4M.dd-eeff

8MSC4L.dd-eeff

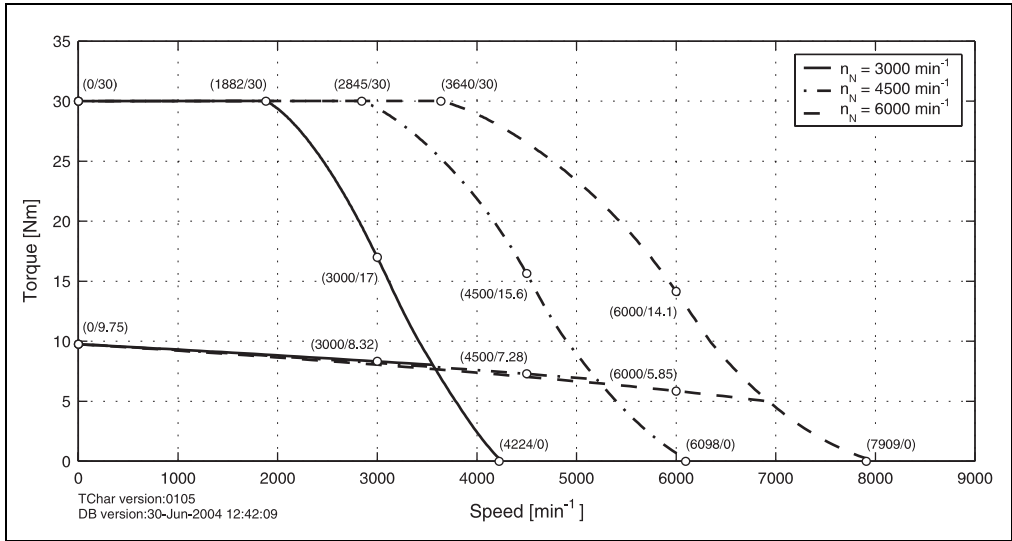

Figure 37: Speed - torque characteristic curve for 8MSC4L.dd-eeff

8MSC4X.dd-eeff

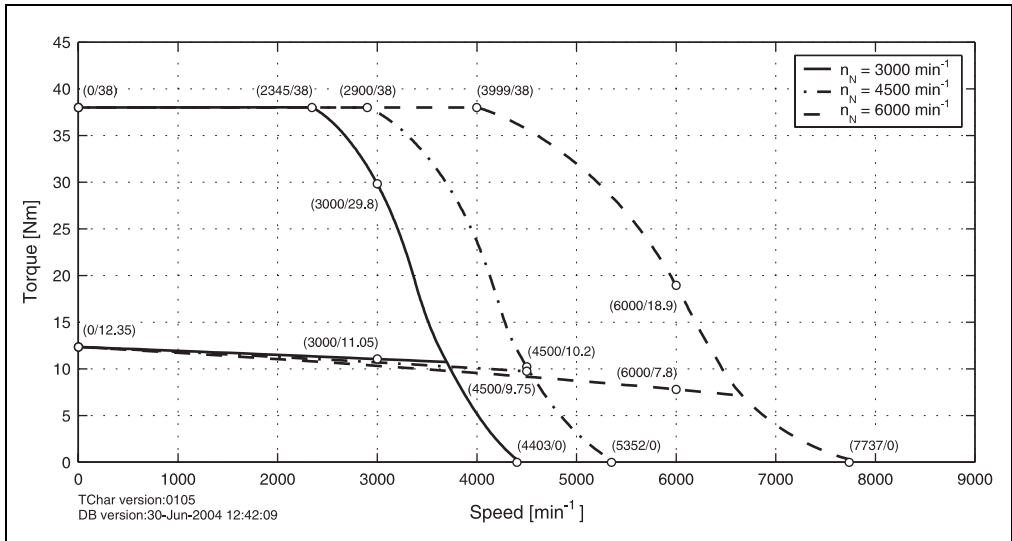
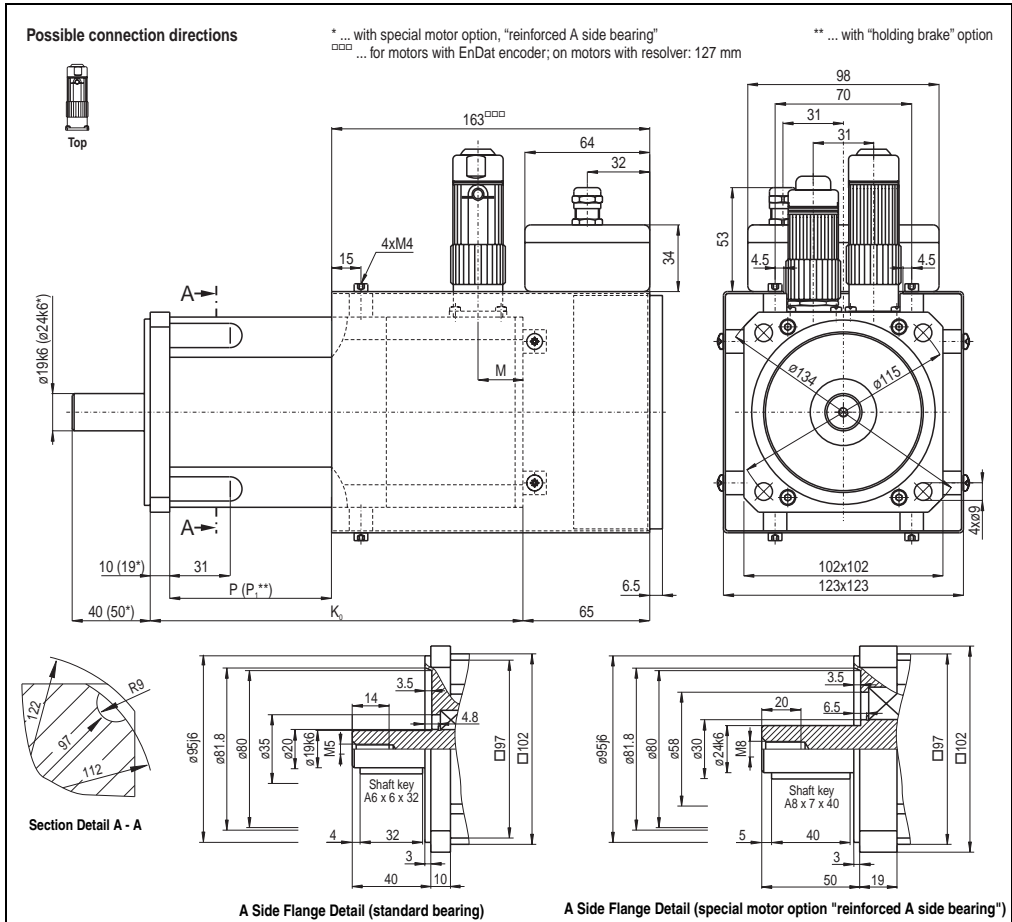

Figure 38: Speed - torque characteristic curve for 8MSC4X.dd-eeff

1.17.3 Dimensions



EnDat Feedback						Resolver Feedback						Extension of K_0 depending on the Motor Option [mm] ¹⁾		
Model Number	K_0	L	M	P	P_1	Model Number	K_0	L	M	P	P_1	Holding brake	Oil seal	Reinforced A side bearing
8MSC4S.Ex-eeff	191	---	23	84	116	8MSC4S.R0-eeff	155	---	19	84	116	32	Approx. 10	28 (33) ²⁾
8MSC4M.Ex-eeff	221			114	146	8MSC4M.R0-eeff	185			114	146			
8MSC4L.Ex-eeff	266			159	191	8MSC4L.R0-eeff	230			159	191			
8MSC4X.Ex-eeff	321.5			214.5	246.5	8MSC4X.R0-eeff	285.5			214.5	246.5			

Table 41: 8MSC4 dimensions

- 1) If a combination of motor options is used (e.g. holding brake and oil seal), the sum of the extensions for the individual motor options must be added to K_0 .
- 2) The value in parentheses is only valid with a combination of the "reinforced A side bearing" special motor option and the "holding brake" option.

1.17.4 Maximum Shaft Load

The values in the diagrams below are based on a mechanical lifespan of the bearings of 20,000 operating hours.

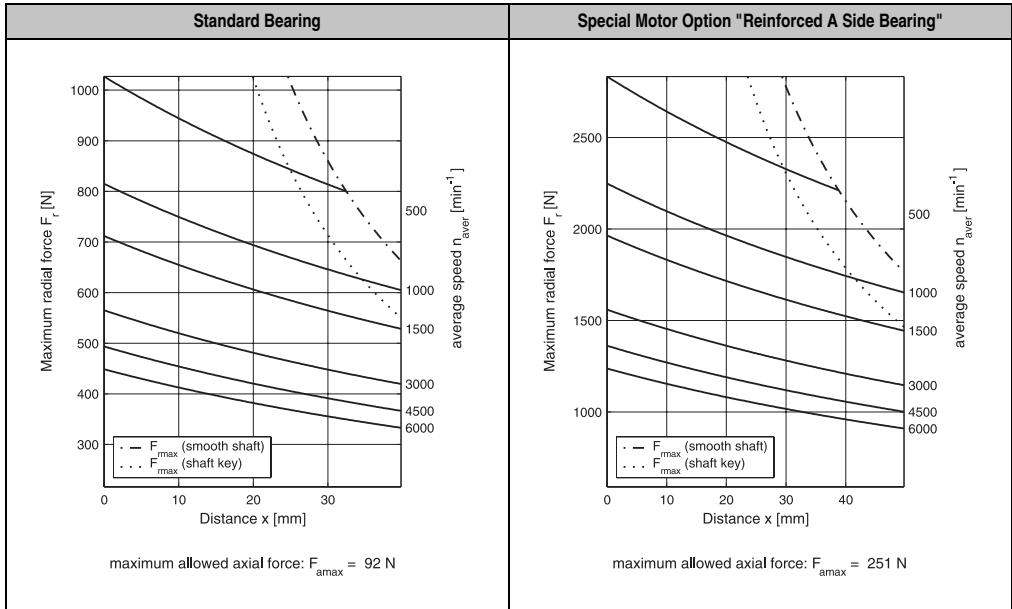

Table 42: Maximum shaft load for 8MSC4

1.18 Motor Data 8MSC5

1.18.1 Technical Data

	8MSC5S.dd-eeff-2		8MSC5M.dd-eeff-2		8MSC5L.dd-eeff.-2		8MSC5X.dd-eeff-2		8MSC5E.dd-eeff-2	
Rated Speed n_N [min ⁻¹]	3000	4500	3000	4500	3000	4500	3000	4500	3000	4500
Rated Torque M_N [Nm]	7.41	6.76	11.44	9.36	14.3	11.7	18.85	14.3	22.75	17.55
Rated Power P_N [kW]	2.33	3.19	3.59	4.41	4.49	5.51	5.92	6.74	7.15	8.27
Rated Current I_N [A]	5.2	6.76	7.15	9.62	9.49	11.57	11.18	14.17	13.65	18.98
Stall Torque M_0 [Nm]	8.58		13.65		17.55		22.1		28.6	
Stalled Current I_0 [A]	5.89	8.37	8.26	13.53	11.28	16.85	12.84	21.2	16.63	28.35
Peak Torque M_{max} [Nm]	19.8		31.5		40.5		51		66	
Peak Current I_{max} [A]	22.6	32	31.6	52	43.2	64.5	49.2	81.2	63.7	108.6
Maximum Rotational Acceleration without Brake a [rad/s ²]	49500		50806		55479		53684		56410	
Maximum Speed n_{max} [min ⁻¹]	9000		9000		9000		9000		9000	
Torque Constant K_T [Nm/A]	1.46	1.03	1.65	1.01	1.56	1.04	1.72	1.04	1.72	1.01
Voltage Constant K_E [V/1000 min ⁻¹]	88	62	100	61	94	63	104	63	104	61
Stator Resistance R_{2ph} [Ω]	4.15	2.05	2.25	0.83	1.55	0.68	1.26	0.46	0.95	0.33
Stator Inductance L_{2ph} [mH]	27.8	13.8	20	7.4	14.6	6.5	13.3	4.8	10.5	3.6
Electrical Time Constant t_{el} [ms]	6.7	6.73	8.89	8.92	9.42	9.56	10.56	10.43	11.05	10.91
Thermal Time Constant t_{therm} [min]	45		50		55		60		75	
Moment of Inertia without Brake J [kgcm ²]	4		6.2		7.3		9.5		11.7	
Weight without Brake m [kg]	7.5		10		11.2		13.7		16.2	
Moment of Inertia for Brake J_{Br} [kgcm ²]	1.66		1.66		1.66		1.66		1.66	
Weight of Brake m_{Br} [kg]	0.9		0.9		0.9		0.9		0.9	
Holding Torque of the Brake M_{Br} [Nm]	15		15		15		15		15	
Recommended Cable Cross Section for B&R Motor Cables [mm ²] ¹⁾	1.5		1.5	4	4		4		4	
Recommended ACOPOS Servo Drive 8Vxxx.00-x ²⁾	1090		1090	1180	1180		1180	1320	1180	1320

Table 43: Technical data for 8MSC5

- 1) The B&R motor cables with this cable cross section are produced optimally (stripping length) for the recommended ACOPOS servo drives (see next line). B&R motor cables with other cable cross sections can also be used (within the specified terminal cross section range) and can be obtained from B&R in the desired design on request.
- 2) The recommended servo drive is defined for the stall current of the motor; if more than double the stall torque is required during the acceleration phase, the next larger servo drive should be selected. This recommendation is only a guideline, detailed inspection of the corresponding speed - torque characteristic curve can result in deviations of the servo drive size (one size larger or smaller).
The speed - torque characteristic curves shown in the following sections always refer to the smallest recommended servo drive for the motor length!

1.18.2 Speed-Torque Characteristic Curves with 400 VAC Supply Voltage

8MSC5S.dd-eeff-2

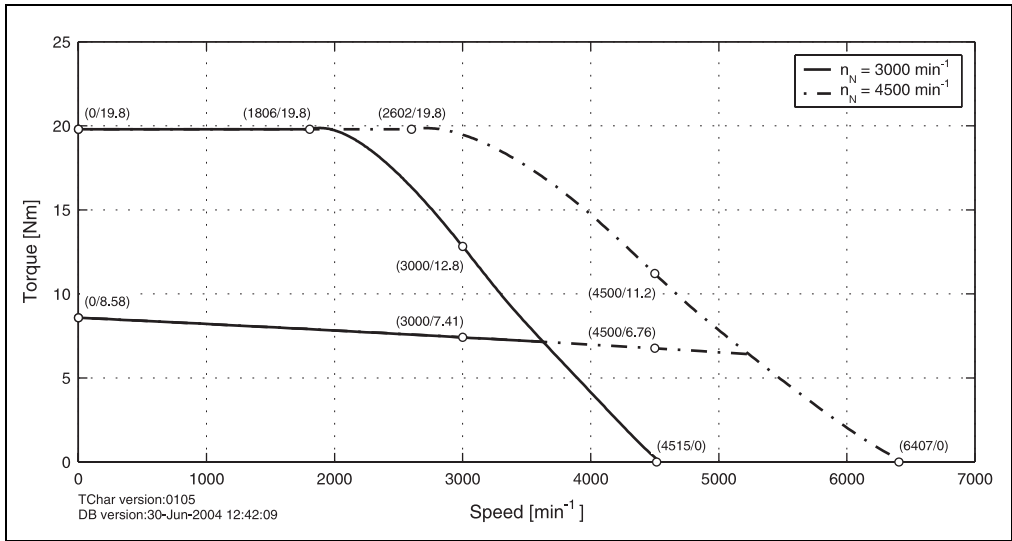

Figure 39: Speed - torque characteristic curve for 8MSC5S.dd-eeff-2

8MSC5M.dd-eeff-2

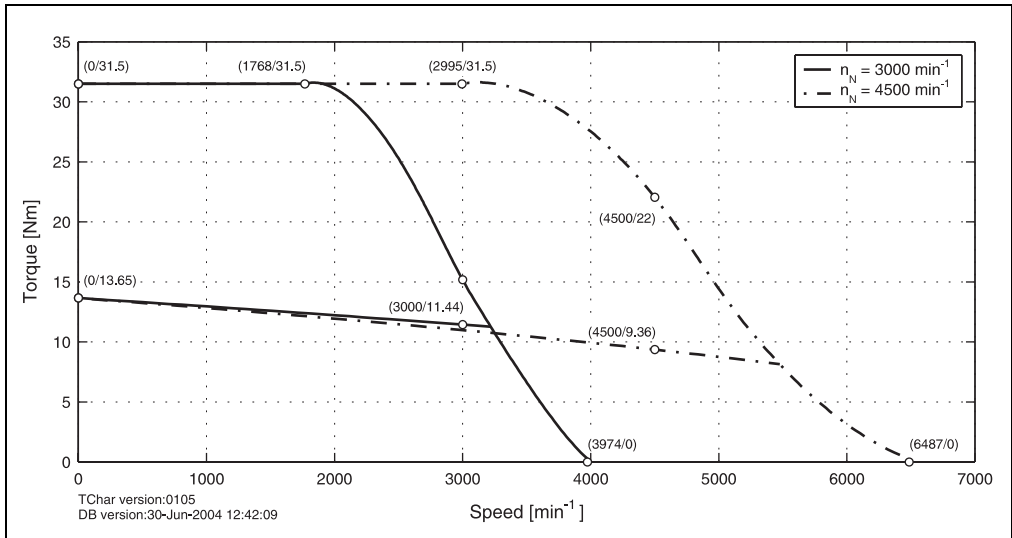

Figure 40: Speed - torque characteristic curve for 8MSC5M.dd-eeff-2

8MSC5L.dd-eeff-2

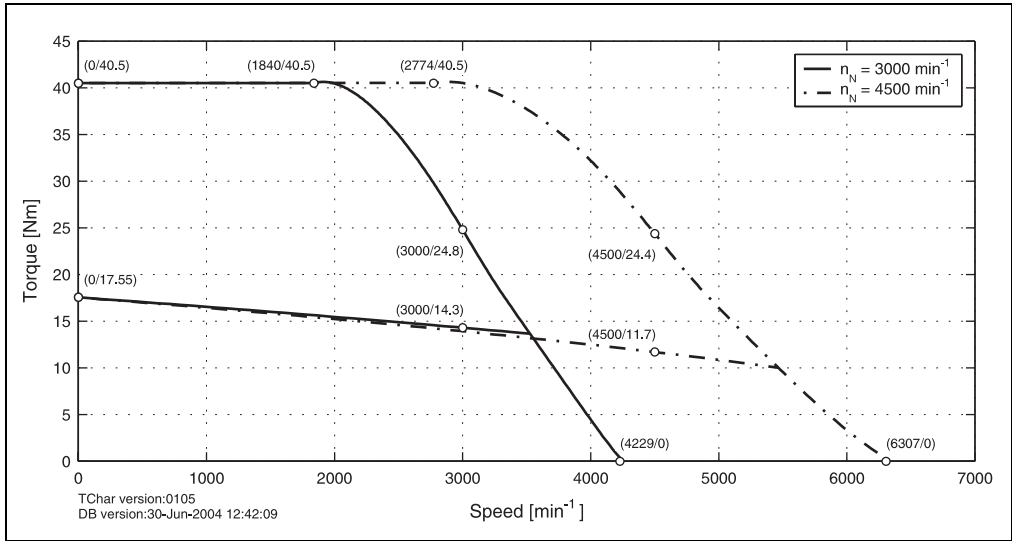

Figure 41: Speed - torque characteristic curve for 8MSC5L.dd-eeff-2

8MSC5X.dd-eeff-2

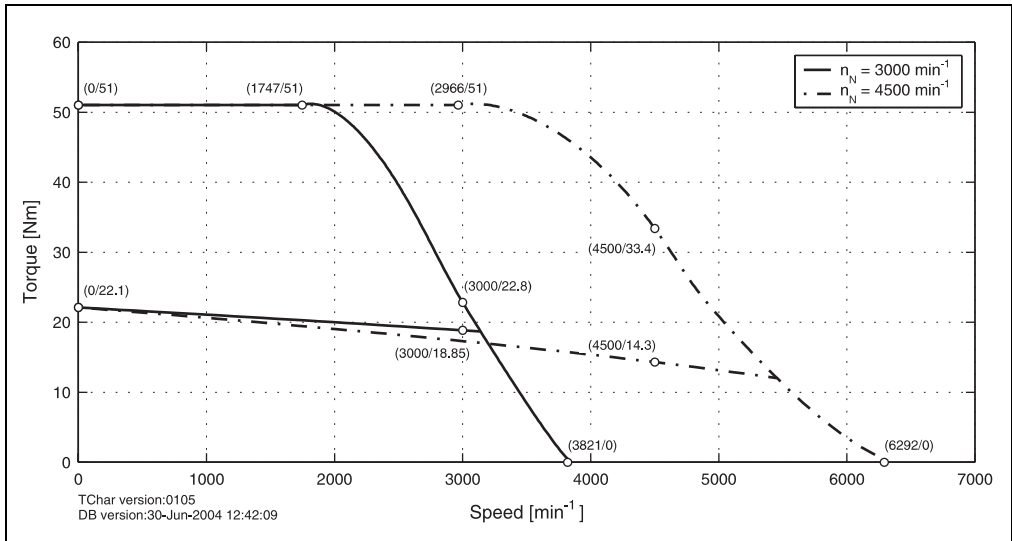

Figure 42: Speed - torque characteristic curve for 8MSC5X.dd-eeff-2

8MSC5E.dd-eeff-2

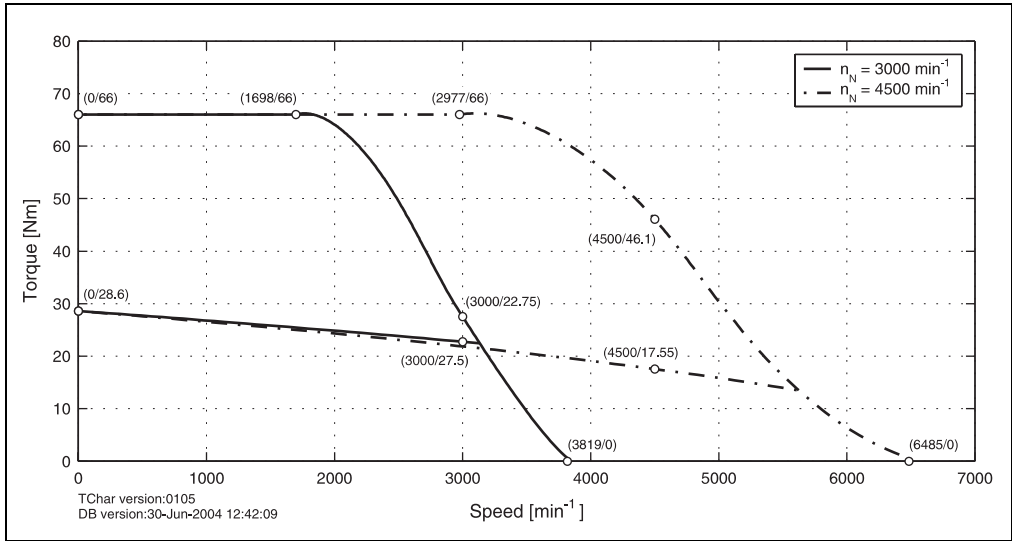
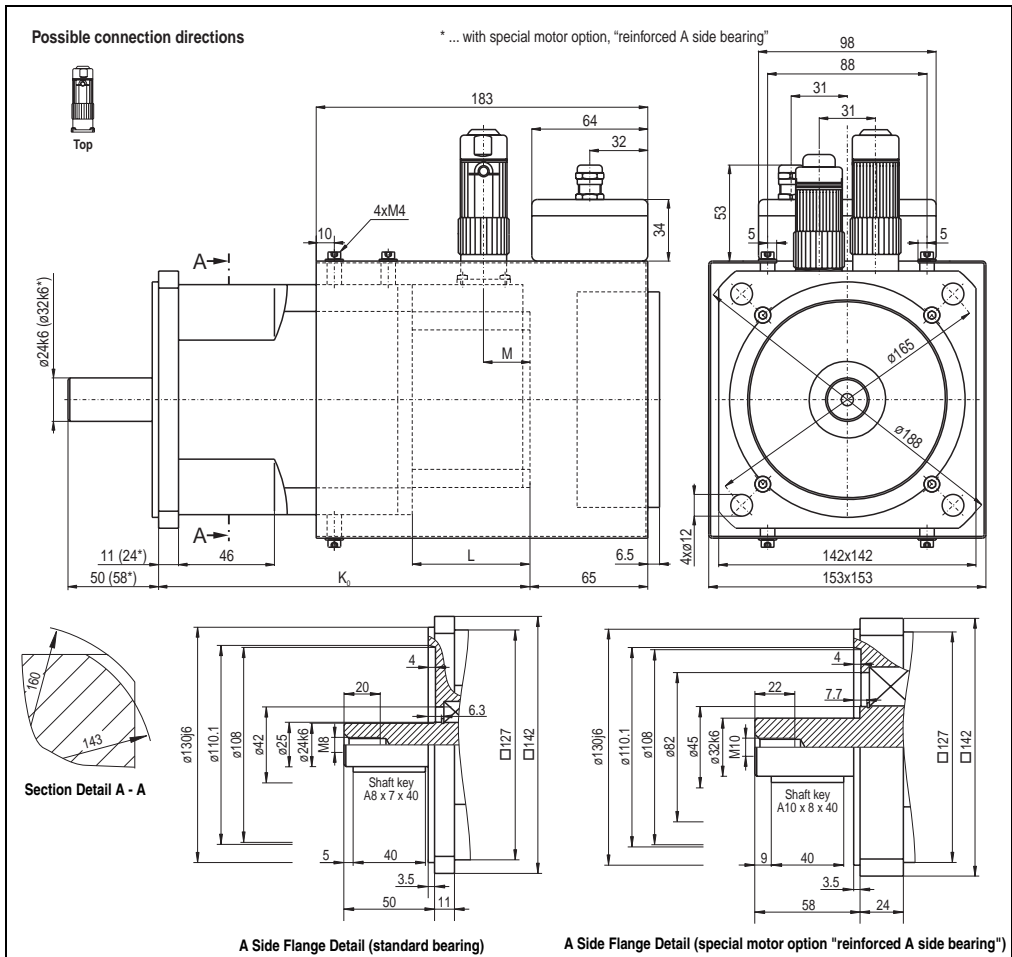

Figure 43: Speed - torque characteristic curve for 8MSC5E.dd-eeff-2

1.18.3 Dimensions



EnDat Feedback				Resolver Feedback				Extension of K_0 depending on the Motor Option [mm] ¹⁾			
Model Number	K_0	L	M	Model Number	K_0	L	M	Holding brake	Oil seal	Reinforced A side bearing	
8MSC5S.Ex-eeff-2	205	65	26	8MSC5S.R0-eeff-2	186	46	20	43	Approx. 10	50 (53) ²⁾	
8MSC5M.Ex-eeff-2	239			8MSC5M.R0-eeff-2	220						
8MSC5L.Ex-eeff-2	256			8MSC5L.R0-eeff-2	237						
8MSC5X.Ex-eeff-2	290			8MSC5X.R0-eeff-2	271						
8MSC5E.Ex-eeff-2	324			8MSC5E.R0-eeff-2	305						

Table 44: 8MSC5 dimensions

- 1) If a combination of motor options is used (e.g. holding brake and oil seal), the sum of the extensions for the individual motor options must be added to K_0 .
- 2) The value in parentheses is only valid with both the "reinforced A side bearing" special motor option and the "holding brake" option.

1.18.4 Maximum Shaft Load

The values in the diagrams below are based on a mechanical lifespan of the bearings of 20,000 operating hours.

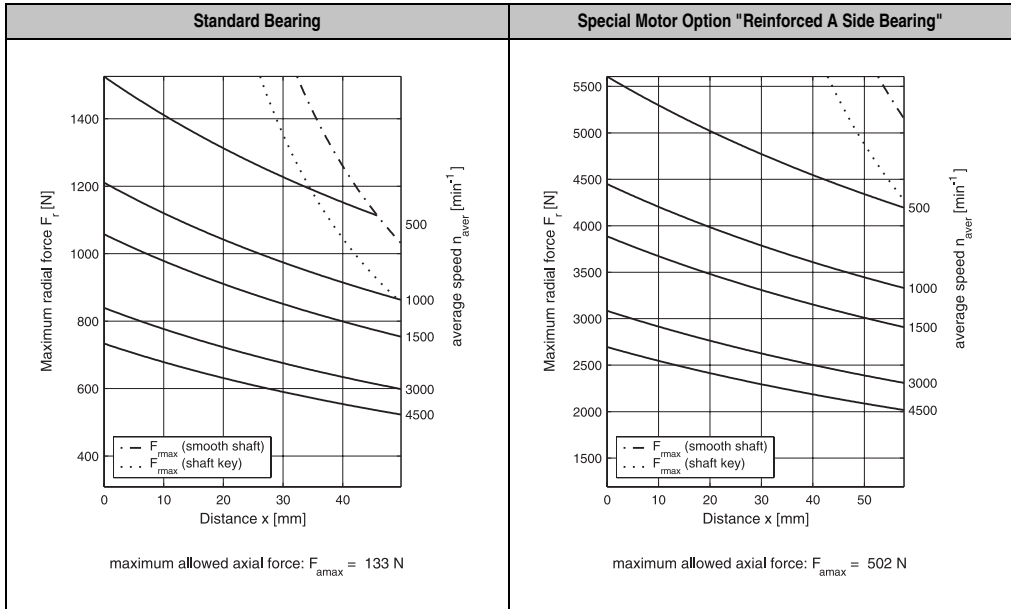

Table 45: Maximum shaft load for 8MSC5

1.19 Motor Data 8MSC6

1.19.1 Technical Data

	8MSC6S.dd-eeff-2		8MSC6M.dd-eeff-2		8MSC6L.dd-eeff-2		8MSC6X.dd-eeff-2	
	3000	4500	3000	4500	3000	4500	3000	4500
Rated Speed n_N [min ⁻¹]	3000	4500	3000	4500	3000	4500	3000	4500
Rated Torque M_N [Nm]	16.9	13	22.1	13	24.7	13	31.2	7.8
Rated Power P_N [kW]	5.31	6.13	6.94	6.13	7.76	6.13	9.80	3.68
Rated Current I_N [A]	10.66	11.83	13.78	11.7	15.99	11.96	19.11	7.41
Stall Torque M_0 [Nm]	17.55		24.7		28.6		37.7	
Stalled Current I_0 [A]	10.61	15.16	14.94	20.74	17.82	24.35	22.35	30.8
Peak Torque M_{max} [Nm]	47.3		66.5		77		101.5	
Peak Current I_{max} [A]	40	57	56	79	67.2	92	84	116
Maximum Rotational Acceleration without Brake a [rad/s ²]	36107		35561		35814		34407	
Maximum Speed n_{max} [min ⁻¹]	6000		6000		6000		6000	
Torque Constant K_T [Nm/A]	1.65	1.16	1.65	1.19	1.60	1.17	1.69	1.22
Voltage Constant K_E [V/1000 min ⁻¹]	100	70	100	72	97	71	102	74
Stator Resistance R_{2ph} [Ω]	1.1	0.56	0.61	0.32	0.46	0.25	0.31	0.16
Stator Inductance L_{2ph} [mH]	13.5	6.7	9	4.7	7.3	3.9	5.6	3
Electrical Time Constant t_{el} [ms]	12.27	11.96	14.75	14.69	15.87	15.6	18.06	18.75
Thermal Time Constant t_{therm} [min]	45		53		60		70	
Moment of Inertia without Brake J [kgcm ²]	13.1		18.7		21.5		29.5	
Weight without Brake m [kg]	13.9		18.2		20.3		26.7	
Moment of Inertia for Brake J_B [kgcm ²]	5.56		5.56		5.56		5.56	
Weight of Brake m_B [kg]	1.6		1.6		1.6		1.6	
Holding Torque of the Brake M_B [Nm]	32		32		32		32	
Recommended Cable Cross Section for B&R Motor Cables [mm ²] ¹⁾	4		4		4		4	
Recommended ACOPOS Servo Drive 8Vxxx.00-x ²⁾	1180		1180		1180	1320	1320	

Table 46: Technical data for 8MSC6

- 1) The B&R motor cables with this cable cross section are produced optimally (stripping length) for the recommended ACOPOS servo drives (see next line). B&R motor cables with other cable cross sections can also be used (within the specified terminal cross section range) and can be obtained from B&R in the desired design on request.
- 2) The recommended servo drive is defined for the stall current of the motor; if more than double the stall torque is required during the acceleration phase, the next larger servo drive should be selected. This recommendation is only a guideline, detailed inspection of the corresponding speed - torque characteristic curve can result in deviations of the servo drive size (one size larger or smaller).
The speed - torque characteristic curves shown in the following sections always refer to the smallest recommended servo drive for the motor length!

1.19.2 Speed-Torque Characteristic Curves with 400 VAC Supply Voltage

8MSC6S.dd-eeff-2

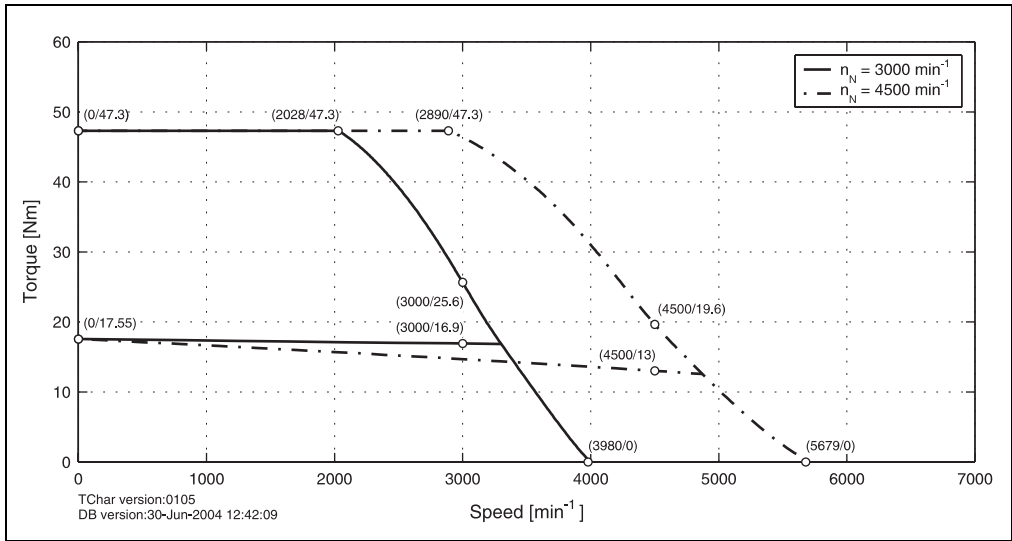

Figure 44: Speed - torque characteristic curve for 8MSC6S.dd-eeff-2

8MSC6M.dd-eeff-2

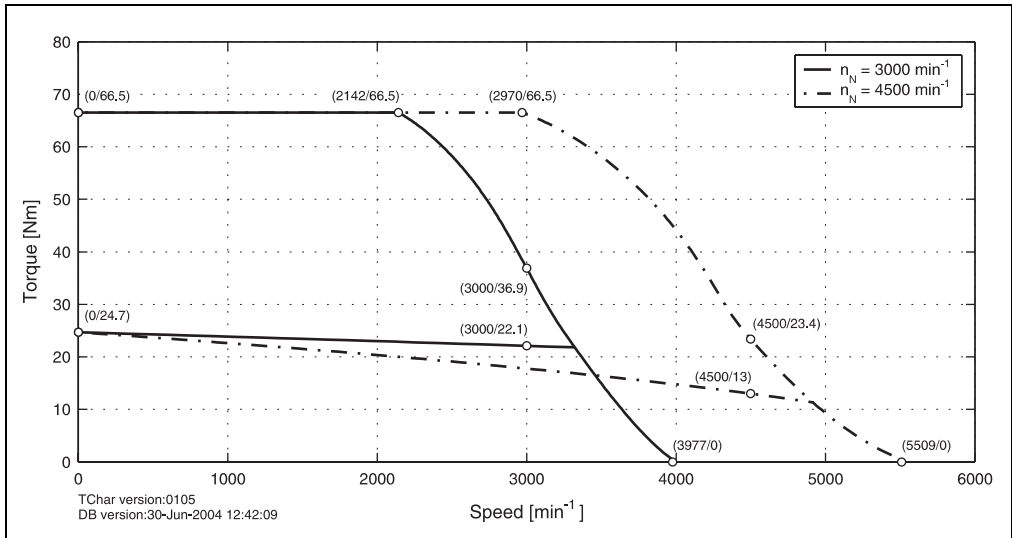

Figure 45: Speed - torque characteristic curve for 8MSC6M.dd-eeff-2

8MSC6L.dd-eeff-2

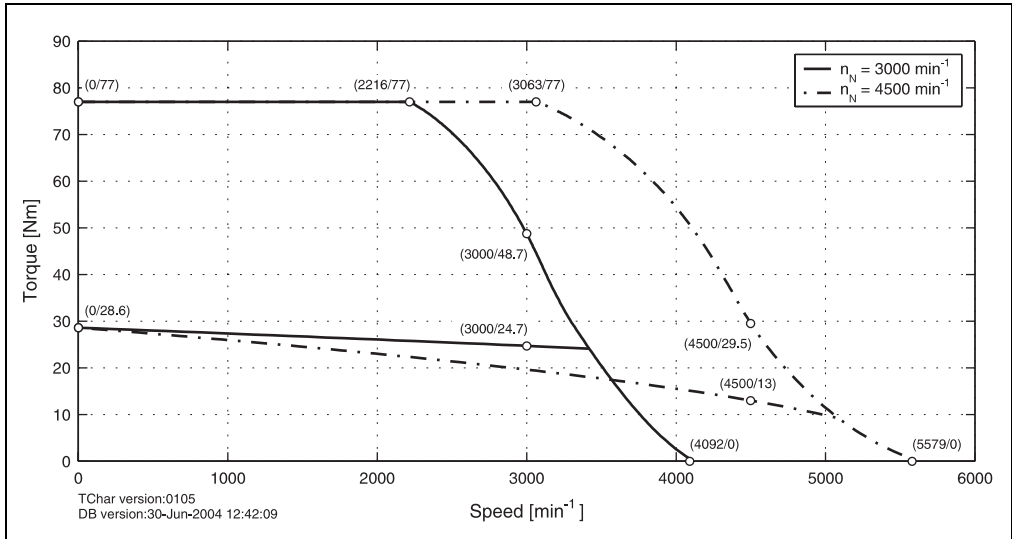

Figure 46: Speed - torque characteristic curve for 8MSC6L.dd-eeff-2

8MSC6X.dd-eeff-2

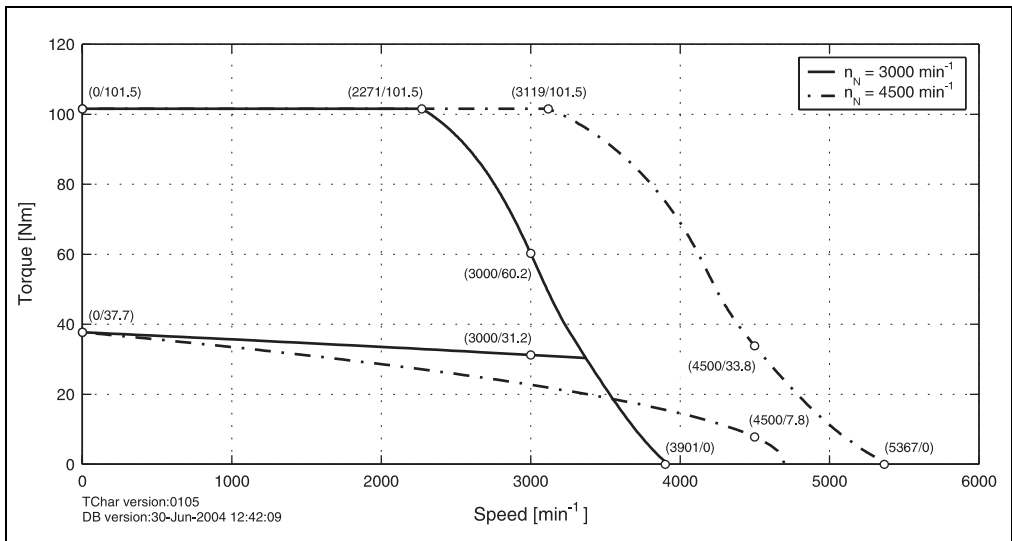
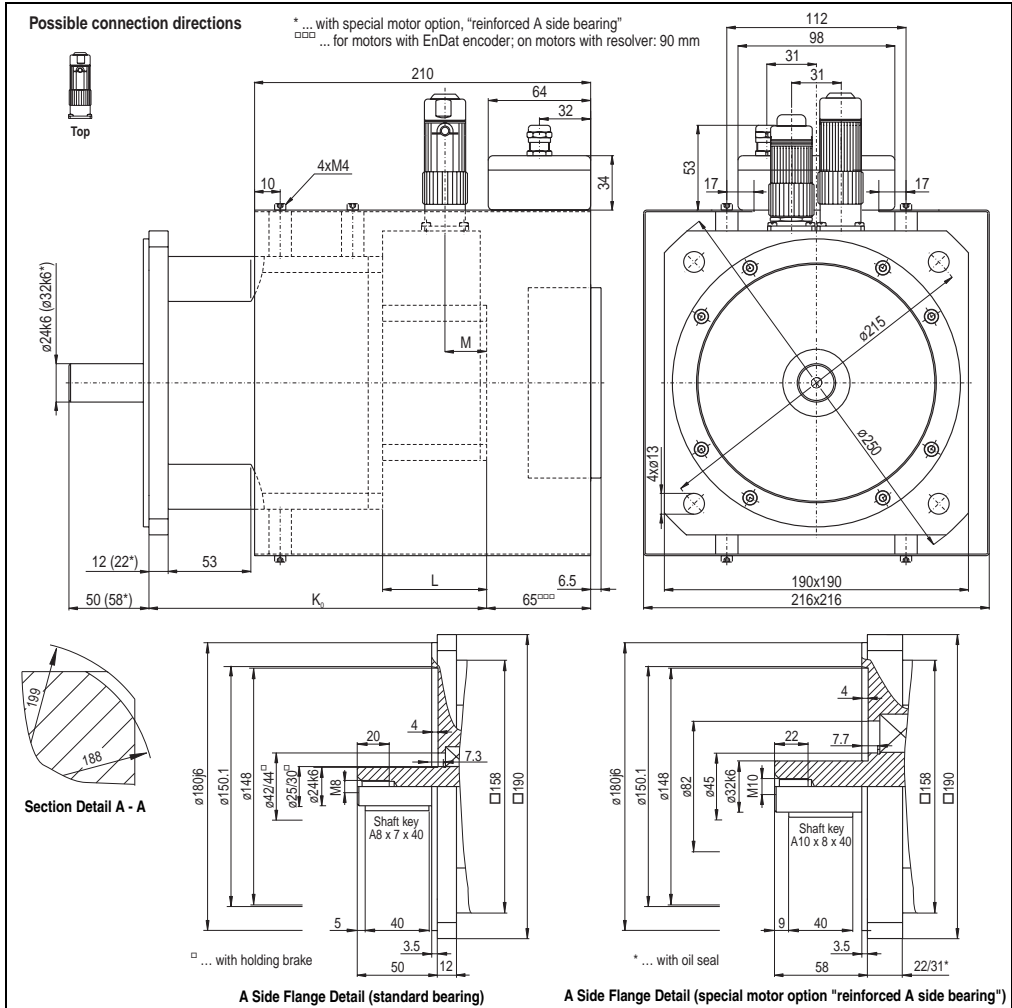

Figure 47: Speed - torque characteristic curve for 8MSC6X.dd-eeff-2

1.19.3 Dimensions



Chapter 2
Technical Data

EnDat Feedback				Resolver Feedback				Extension of K ₀ depending on the Motor Option [mm] ¹⁾		
Model Number	K ₀	L	M	Model Number	K ₀	L	M	Holding brake	Oil seal	Reinforced A side bearing
8MSC6S.Ex-e-eff-2	221	65	26	8MSC6S.R0-e-eff-2	202	46	20	53	Approx. 10	41 (60) ²⁾
8MSC6M.Ex-e-eff-2	255			8MSC6M.R0-e-eff-2	236					
8MSC6L.Ex-e-eff-2	272			8MSC6L.R0-e-eff-2	253					
8MSC6X.Ex-e-eff-2	330			8MSC6X.R0-e-eff-2	311					
								46		34 (53) ²⁾

Table 47: 8MSC6 dimensions

- 1) If a combination of motor options is used (e.g. holding brake and oil seal), the sum of the extensions for the individual motor options must be added to K₀.
- 2) The value in parentheses is only valid for motors with resolver feedback.

1.19.4 Maximum Shaft Load

The values in the diagrams below are based on a mechanical lifespan of the bearings of 20,000 operating hours.

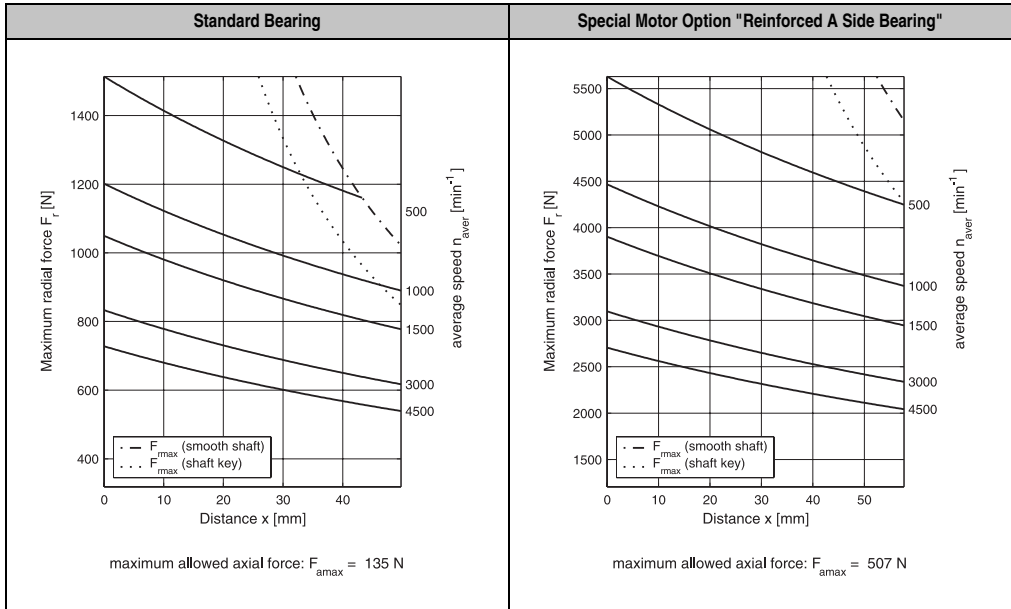

Table 48: Maximum shaft load for 8MSC6

1.20 Motor Data 8MSC7

1.20.1 Technical Data

	8MSC7S.dd-eeff-1	8MSC7M.dd-eeff-1	8MSC7L.dd-eeff-1
Rated Speed n_N [min ⁻¹]	3000	3000	3000
Rated Torque M_N [Nm]	26	29.9	33.8
Rated Power P_N [kW]	8.17	9.39	10.62
Rated Current I_N [A]	18.33	21.84	22.49
Stall Torque M_0 [Nm]	33.8	41.6	52
Stalled Current I_0 [A]	21.97	27.64	31.12
Peak Torque M_{max} [Nm]	78	96	120
Peak Current I_{max} [A]	65.9	82.9	93
Maximum Rotational Acceleration without Brake a [rad/s ²]	11642	11852	11881
Maximum Speed n_{max} [min ⁻¹]	6000	6000	4500
Torque Constant K_T [Nm/A]	1.54	1.51	1.67
Voltage Constant K_E [V/1000 min ⁻¹]	93	91	101
Stator Resistance R_{2ph} [Ω]	0.46	0.3	0.27
Stator Inductance L_{2ph} [mH]	5.1	3.7	3.4
Electrical Time Constant t_{el} [ms]	11.09	12.33	12.59
Thermal Time Constant t_{therm} [min]	60	67	70
Moment of Inertia without Brake J [kgcm ²]	67	81	101
Weight without Brake m [kg]	22.3	26.2	32
Moment of Inertia for Brake J_{Br} [kgcm ²]	5.56	5.56	5.56
Weight of Brake m_{Br} [kg]	1.6	1.6	1.6
Holding Torque of the Brake M_{Br} [Nm]	32	32	32
Recommended Cable Cross Section for B&R Motor Cables [mm ² ¹⁾	4	4	4
Recommended ACOPOS Servo Drive 8Vxxx.00-x ²⁾	1320	1320	1320

Table 49: Technical data for 8MSC7

- 1) The B&R motor cables with this cable cross section are produced optimally (stripping length) for the recommended ACOPOS servo drives (see next line). B&R motor cables with other cable cross sections can also be used (within the specified terminal cross section range) and can be obtained from B&R in the desired design on request.
- 2) The recommended servo drive is defined for the stall current of the motor; if more than double the stall torque is required during the acceleration phase, the next larger servo drive should be selected. This recommendation is only a guideline, detailed inspection of the corresponding speed - torque characteristic curve can result in deviations of the servo drive size (one size larger or smaller).
The speed - torque characteristic curves shown in the following sections always refer to the smallest recommended servo drive for the motor length!

1.20.2 Speed-Torque Characteristic Curves with 400 VAC Supply Voltage

8MSC7S.dd-eeff-1

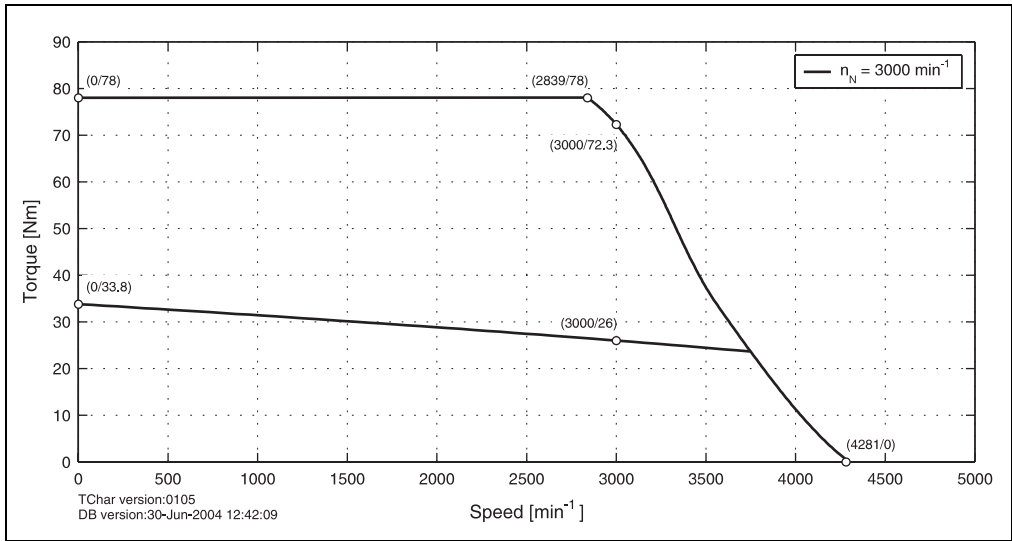

Figure 48: Speed - torque characteristic curve for 8MSC7S.dd-eeff-1

8MSC7M.dd-eeff-1

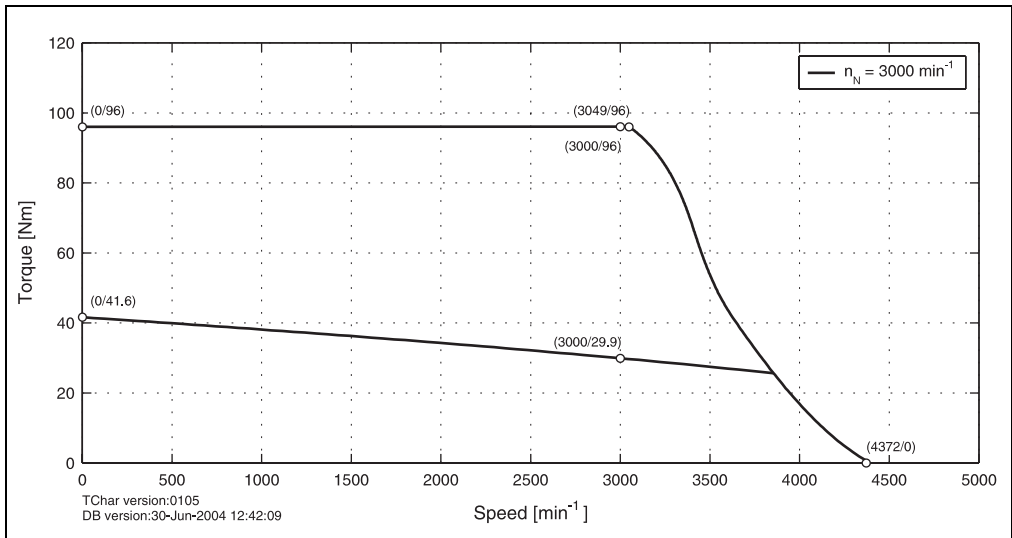

Figure 49: Speed - torque characteristic curve for 8MSC7M.dd-eeff-1

8MSC7L.dd-eeff-1

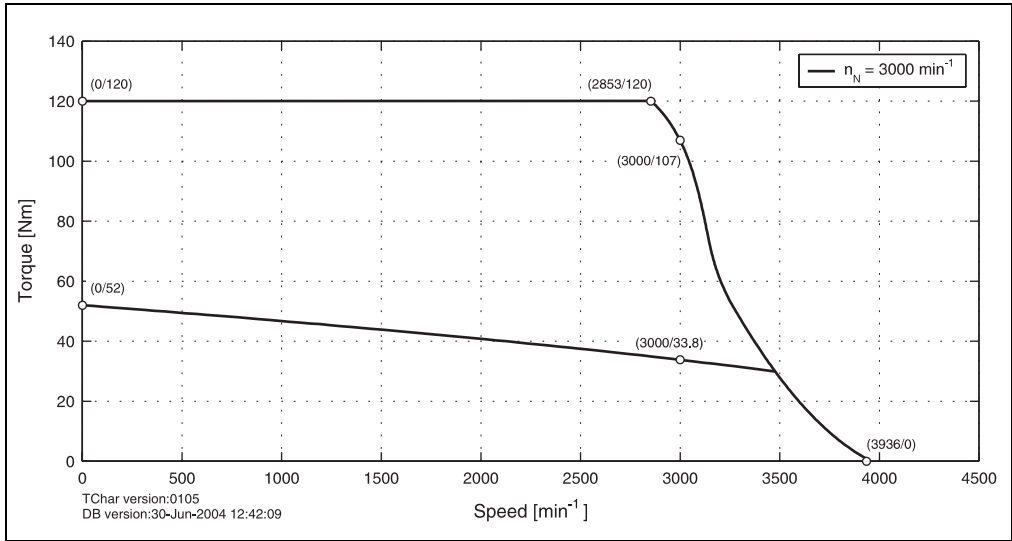
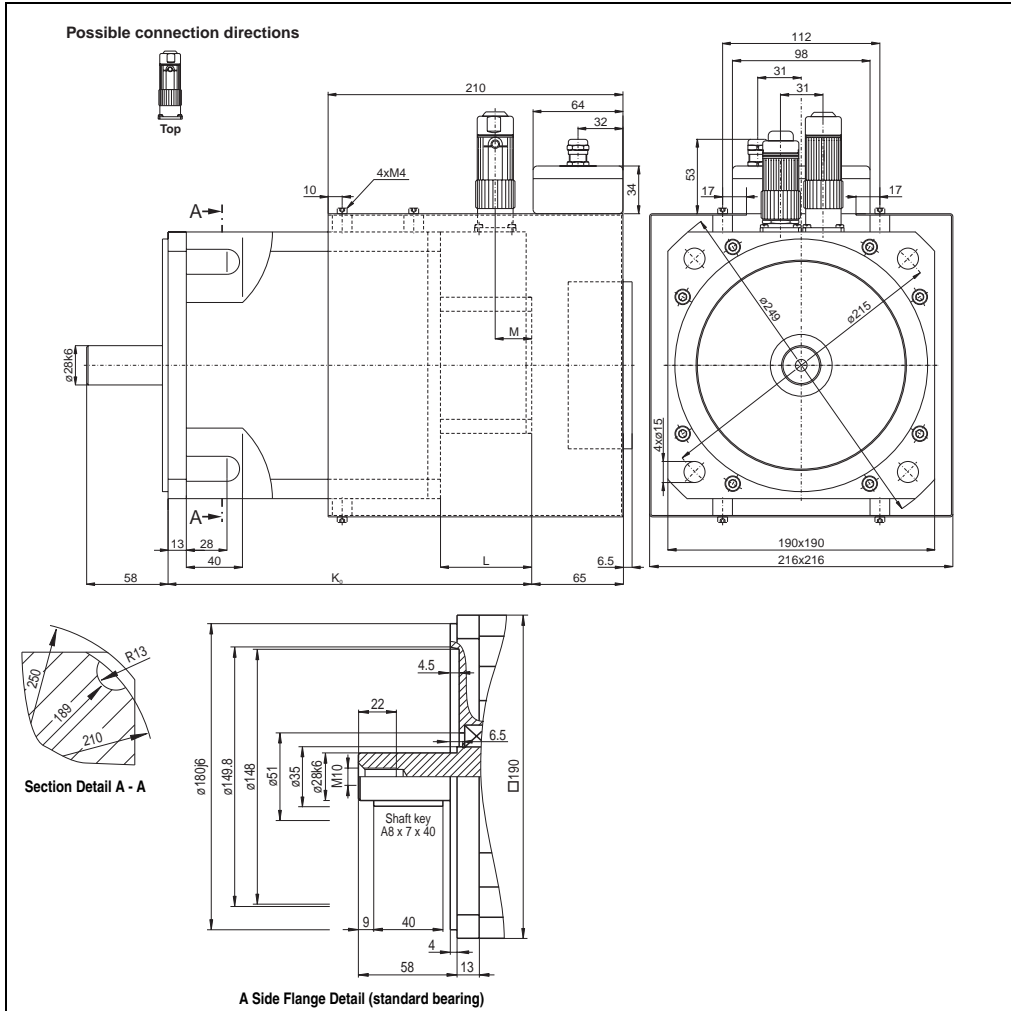

Figure 50: Speed - torque characteristic curve for 8MSC7L.dd-eeff-1

1.20.3 Dimensions



EnDat Feedback				Resolver Feedback				Extension of K ₀ depending on the Motor Option [mm] ¹⁾			
Model Number	K ₀	L	M	Model Number	K ₀	L	M	Holding brake	Oil seal	Reinforced A side bearing	
8MSC7S.Ex-eeff-1	259	65	26	8MSC7S.R0-eeff-1	240	46	20	44	Approx. 10	---	
8MSC7M.Ex-eeff-1	282			8MSC7M.R0-eeff-1	263						
8MSC7L.Ex-eeff-1	316.5			8MSC7L.R0-eeff-1	297.5						

Table 50: 8MSC7 dimensions

1) If a combination of motor options is used (e.g. holding brake and oil seal), the sum of the extensions for the individual motor options must be added to K₀.

1.20.4 Maximum Shaft Load

The values in the diagrams below are based on a mechanical lifespan of the bearings of 20,000 operating hours.

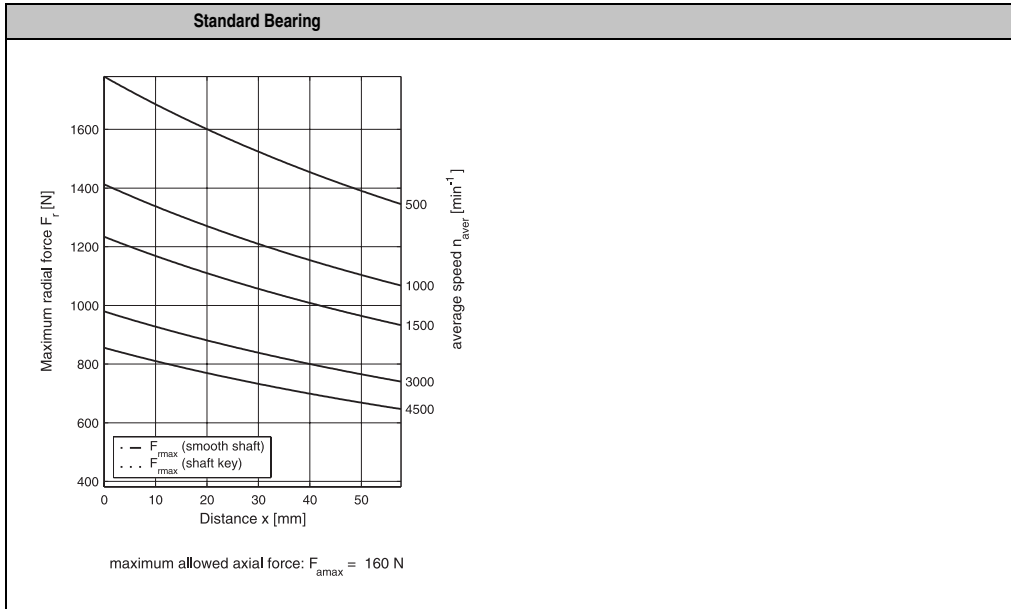

Table 51: Maximum shaft load for 8MSC7

2. Cables

2.1 General Information

B&R offers the cables for ACOPOS servo drives in six different lengths. All cables can be used for drag chain installations. ¹⁾

To prevent disturbances to encoder signals, the holding brake and temperature sensor wires are in the motor cable and not in the EnDat or resolver cable.

2.1.1 Prefabricated Cables

Using B&R cables guarantees that the EMC limits are not exceeded. The cables are prefabricated in the EU and are therefore subject to the strictest quality standards.

Information:

If other cables are used, make sure that they have the same wave parameters and the same design as the respective B&R cable. If deviations exist, additional measures are necessary to ensure that EMC guidelines are met.

¹⁾ Custom fabrication of motor cables is available on request. For custom fabrication of motor cables, the plug size must be matched to the motor used!

2.2 Motor Cables

2.2.1 Order Data

Model Number	Short Description	Image
Motor Cables 1.5 mm² 1)		
8CM005.12-1	Motor cable, length 5m, 4 x 1.5mm ² + 2 x 2 x 0.75mm ² , Motor connector 8pin Intercontec socket, can be used in cable drag chains, UL/CSA listed	
8CM007.12-1	Motor cable, length 7m, 4 x 1.5mm ² + 2 x 2 x 0.75mm ² , Motor connector 8pin Intercontec socket, can be used in cable drag chains, UL/CSA listed	
8CM010.12-1	Motor cable, length 10m, 4 x 1.5mm ² + 2 x 2 x 0.75mm ² , Motor connector 8pin Intercontec socket, can be used in cable drag chains, UL/CSA listed	
8CM015.12-1	Motor cable, length 15m, 4 x 1.5mm ² + 2 x 2 x 0.75mm ² , Motor connector 8pin Intercontec socket, can be used in cable drag chains, UL/CSA listed	
8CM020.12-1	Motor cable, length 20m, 4 x 1.5mm ² + 2 x 2 x 0.75mm ² , Motor connector 8pin Intercontec socket, can be used in cable drag chains, UL/CSA listed	
8CM025.12-1	Motor cable, length 25m, 4 x 1.5mm ² + 2 x 2 x 0.75mm ² , Motor connector 8pin Intercontec socket, can be used in cable drag chains, UL/CSA listed	
Motor Cables 4 mm² 2)		
8CM005.12-3	Motor cable, length 5m, 4 x 4mm ² + 2 x 2 x 1mm ² , Motor connector 8pin Intercontec socket, can be used in cable drag chains, UL/CSA listed	
8CM007.12-3	Motor cable, length 7m, 4 x 4mm ² + 2 x 2 x 1mm ² , Motor connector 8pin Intercontec socket, can be used in cable drag chains, UL/CSA listed	
8CM010.12-3	Motor cable, length 10m, 4 x 4mm ² + 2 x 2 x 1mm ² , Motor connector 8pin Intercontec socket, can be used in cable drag chains, UL/CSA listed	
8CM015.12-3	Motor cable, length 15m, 4 x 4mm ² + 2 x 2 x 1mm ² , Motor connector 8pin Intercontec socket, can be used in cable drag chains, UL/CSA listed	
8CM020.12-3	Motor cable, length 20m, 4 x 4mm ² + 2 x 2 x 1mm ² , Motor connector 8pin Intercontec socket, can be used in cable drag chains, UL/CSA listed	
8CM025.12-3	Motor cable, length 25m, 4 x 4mm ² + 2 x 2 x 1mm ² , Motor connector 8pin Intercontec socket, can be used in cable drag chains, UL/CSA listed	
Motor Cables 10 mm² 3)		
8CM005.12-5	Motor cable, length 5m, 4 x 10mm ² + 2 x 2 x 1.5mm ² , Motor connector 8pin Intercontec socket, can be used in cable drag chains, UL/CSA listed	
8CM007.12-5	Motor cable, length 7m, 4 x 10mm ² + 2 x 2 x 1.5mm ² , Motor connector 8pin Intercontec socket, can be used in cable drag chains, UL/CSA listed	
8CM010.12-5	Motor cable, length 10m, 4 x 10mm ² + 2 x 2 x 1.5mm ² , Motor connector 8pin Intercontec socket, can be used in cable drag chains, UL/CSA listed	
8CM015.12-5	Motor cable, length 15m, 4 x 10mm ² + 2 x 2 x 1.5mm ² , Motor connector 8pin Intercontec socket, can be used in cable drag chains, UL/CSA listed	
8CM020.12-5	Motor cable, length 20m, 4 x 10mm ² + 2 x 2 x 1.5mm ² , Motor connector 8pin Intercontec socket, can be used in cable drag chains, UL/CSA listed	
8CM025.12-5	Motor cable, length 25m, 4 x 10mm ² + 2 x 2 x 1.5mm ² , Motor connector 8pin Intercontec socket, can be used in cable drag chains, UL/CSA listed	

Table 52: Order data for motor cables

Technical Data • Cables

Model Number	Short Description	Image
	Motor Cables 35 mm²	
8CM005.12-8	Motor cable, length 5m, 4 x 35mm ² + 2 x 2 x 1.5mm ² , can be used in cable drag chains, UL/CSA listed	
8CM007.12-8	Motor cable, length 7m, 4 x 35mm ² + 2 x 2 x 1.5mm ² , can be used in cable drag chains, UL/CSA listed	
8CM010.12-8	Motor cable, length 10m, 4 x 35mm ² + 2 x 2 x 1.5mm ² , can be used in cable drag chains, UL/CSA listed	
8CM015.12-8	Motor cable, length 15m, 4 x 35mm ² + 2 x 2 x 1.5mm ² , can be used in cable drag chains, UL/CSA listed	
8CM020.12-8	Motor cable, length 20m, 4 x 35mm ² + 2 x 2 x 1.5mm ² , can be used in cable drag chains, UL/CSA listed	
8CM025.12-8	Motor cable, length 25m, 4 x 35mm ² + 2 x 2 x 1.5mm ² , can be used in cable drag chains, UL/CSA listed	

Table 52: Order data for motor cables (Forts.)

- 1) Standard fabrication; designed for use with ACOPOS servo drives 8V1022.00-x, 8V1045.00-x and 8V1090.00-x and motor sizes 2 to 7.
- 2) Standard fabrication; designed for use with ACOPOS servo drives 8V1180.00-x and 8V1320.00-x and motor sizes 2 to 7.
- 3) Standard fabrication; designed for use with ACOPOS servo drives 8V1640.00-x and 8V128M.00-x and motor size 8.

2.2.2 Technical Data

1.5 and 4 mm² motor cables

Product ID	Motor Cables 1.5 mm ²	Motor Cables 4 mm ²
General Information		
Cable Cross Section	4 x 1.5 mm ² + 2 x 2 x 0.75 mm ²	4 x 4 mm ² + 2 x 2 x 1 mm ²
Durability	Oil resistant according to VDE 0472 part 803, as well as standard hydraulic oil	
Certification	UL AWM Style 20669, 90 °C, 600 V, E63216 and CSA AWM I/II A/B, 90°C, 600 V, FT1 LL46064	
Conductor		
Power Lines	1.5 mm ² , tinned Cu wire	4 mm ² , tinned Cu wire
Wire Insulation	Special thermoplastic material	
Wire Colors	Black, brown, blue, yellow/green	
Signal Lines	0,75 mm ² , tinned Cu wire	1 mm ² , tinned Cu wire
Wire Insulation	Special thermoplastic material	
Wire Colors	White, white/red, white/blue, white/green	
Cable Structure		
Power Lines		
Stranding	No	
Shielding	No	
Signal Lines		
Stranding	White with white/red and white/blue with white/green	
Shielding	Separate shielding for pairs, tinned Cu mesh, optical coverage > 85 % and foil banding	
Cable Stranding	With filler elements and foil banding	
Cable Shielding	Tinned Cu mesh, optical coverage > 85% and wrapped in isolating fabric	
Outer Sheathing		
Material	PUR	
Color	Orange, similar to RAL 2003 flat	
Labeling	BERNECKER + RAINER 4x1.5+2x2x0.75 FLEX	BERNECKER + RAINER 4x4.0+2x2x1.5 FLEX
Electrical Characteristics		
Conductor Resistance		
Power Lines	≤ 14 Ω/km	≤ 5.2 Ω/km
Signal Lines	≤ 29 Ω/km	≤ 14 Ω/km
Insulation Resistance	> 200 MΩ per km	
Isolation Voltage		
Wire/Wire	3 kV	
Wire/Shield	1 kV	
Operating Voltage	Max. 600 V	
Mechanical Characteristics		
Temperature Range		
Moving	-10° C to +70° C	
Static	-20° C to +90° C	
Outer Diameter	12.8 mm ± 0,4 mm	15.8 mm ± 0.5 mm
Flex Radius	> 96 mm	> 118.5 mm
Speed	≤ 4 m/s	
Acceleration	< 60 m/s ²	
Flex Cycles	≥ 3,000,000	
Weight	0.26 kg/m	0.45 kg/m

Table 53: Technical data for motor cables 1.5 and 4 mm²

10 and 35 mm² motor cables

Product ID	Motor Cables 10 mm ²	Motor Cables 35 mm ²
General Information		
Cable Cross Section	4 x 10 mm ² + 2 x 2 x 1.5 mm ²	4 x 35 mm ² + 2 x 2 x 1.5 mm ²
Durability	Oil resistant according to VDE 0472 part 803, as well as standard hydraulic oil	
Certification	UL AWM Style 20669, 90 °C, 600 V, E63216 and CSA AWM I/II A/B, 90°C, 600 V, FT1 LL46064	
Conductor		
Power Lines	10 mm ² , tinned Cu wire	35 mm ² , tinned Cu wire
Wire Insulation	Special thermoplastic material	
Wire Colors	Black, brown, blue, yellow/green	
Signal Lines	1.5 mm ² , tinned Cu wire	
Wire Insulation	Special thermoplastic material	
Wire Colors	White, white/red, white/blue, white/green	
Cable Structure		
Power Lines		
Stranding	No	
Shielding	No	
Signal Lines		
Stranding	White with white/red and white/blue with white/green	
Shielding	Separate shielding for pairs, tinned Cu mesh, optical coverage > 85 % and foil banding	
Cable Stranding	With filler elements and foil banding	
Cable Shielding	Tinned Cu mesh, optical coverage > 85% and wrapped in isolating fabric	
Outer Sheathing		
Material	PUR	
Color	Orange, similar to RAL 2003 flat	
Labeling	BERNECKER + RAINER 4x10.0+2x2x1.5 FLEX	BERNECKER + RAINER 4x35.0+2x2x1.5 FLEX
Electrical Characteristics		
Conductor Resistance		
Power Lines	≤ 2.1 Ω/km	≤ 0.6 Ω/km
Signal Lines	≤ 14 Ω/km	≤ 14 Ω/km
Insulation Resistance	> 200 MΩ per km	
Isolation Voltage		
Wire/Wire	3 kV	
Wire/Shield	1 kV	
Operating Voltage	Max. 600 V	
Mechanical Characteristics		
Temperature Range		
Moving	-10° C to +70° C	
Static	-20° C to +90° C	
Outer Diameter	20.1 mm ± 0.7 mm	32.5 mm ± 1 mm
Flex Radius	> 150.8 mm	> 243.8 mm
speed	≤ 4 m/s	
acceleration	< 60 m/s ²	
Flex Cycles	≥ 3,000,000	
Weight	0.77 kg/m	2.2 kg/m

 Table 54: Technical data for motor cables 10 and 35 mm²

2.3 EnDat Cable

2.3.1 Order Data

Model Number	Model Number	Image
8CE005.12-1	EnDat cable, length 5m, 10 x 0.14mm ² + 2 x 0.5mm ² , EnDat connector 17-pin Intercontec socket, servo connector 15-pin DSUB plug, can be used in cable drag chains, UL/CSA listed	
8CE007.12-1	EnDat cable, length 7m, 10 x 0.14mm ² + 2 x 0.5mm ² , EnDat connector 17-pin Intercontec socket, servo connector 15-pin DSUB plug, can be used in cable drag chains, UL/CSA listed	
8CE010.12-1	EnDat cable, length 10m, 10 x 0.14mm ² + 2 x 0.5mm ² , EnDat connector 17-pin Intercontec socket, servo connector 15-pin DSUB plug, can be used in cable drag chains, UL/CSA listed	
8CE015.12-1	EnDat cable, length 15m, 10 x 0.14mm ² + 2 x 0.5mm ² , EnDat connector 17-pin Intercontec socket, servo connector 15-pin DSUB plug, can be used in cable drag chains, UL/CSA listed	
8CE020.12-1	EnDat cable, length 20m, 10 x 0.14mm ² + 2 x 0.5mm ² , EnDat connector 17-pin Intercontec socket, servo connector 15-pin DSUB plug, can be used in cable drag chains, UL/CSA listed	
8CE025.12-1	EnDat cable, length 25m, 10 x 0.14mm ² + 2 x 0.5mm ² , EnDat connector 17-pin Intercontec socket, servo connector 15-pin DSUB plug, can be used in cable drag chains, UL/CSA listed	

Table 55: Order data for EnDat cables

2.3.2 Technical Data

Product ID	EnDat Cables
General Information	
Cable Cross Section	10 x 0.14 mm ² + 2 x 0.50 mm ²
Durability	Oil resistant according to VDE 0472 part 803, as well as standard hydraulic oil
Certification	UL AWM Style 20963, 80°C, 30 V, E63216 and CSA AWM I/II A/B, 90°C, 30 V, FT1 LL46064
Conductor	
Signal Lines Wire Insulation Wire Colors	0.14 mm ² , tinned Cu wire Special thermoplastic material Blue, brown, yellow, gray, green, pink, red, black, violet, white
Supply Lines Wire Insulation Wire Colors	0.5 mm ² , tinned Cu wire Special thermoplastic material White/green, white/red
Cable Structure	
Signal Lines Stranding Shielding	Green with brown, gray with yellow, white with violet, black with red, pink with blue No
Supply Lines Stranding Shielding	White/red with white/green and filler elements No
Cable Stranding	With foil banding

Table 56: Technical data for EnDat cables

Technical Data • Cables

Product ID	EnDat Cables
Cable Shielding	Cu mesh, optical coverage > 85% and wrapped in isolating fabric
Outer Sheathing Material Color Labeling	PUR RAL 6018 BERNECKER + RAINER 10x0.14+2x0.50 FLEX
Electrical Characteristics	
Conductor Resistance Signal Lines Supply Lines	≤ 140 Ω/km ≤ 40 Ω/km
Insulation Resistance	> 200 MΩ per km
Isolation Voltage Wire/Wire Wire/Shield	1.5 kV 0.8 kV
Operating Voltage	Max. 30 V
Mechanical Characteristics	
Temperature Range Moving Static	-10° C to +70° C -20° C to +90° C
Outer Diameter	7.3 mm ± 0.25 mm
Flex Radius	> 55 mm
Speed	≤ 4 m/s
Acceleration	< 60 m/s ²
Flex Cycles	≥ 3,000,000
Weight	0.08 kg/m

Table 56: Technical data for EnDat cables (Forts.)

2.4 Resolver Cables

2.4.1 Order Data

Model Number	Short Description	Image
8CR005.12-1	Resolver cable, length 5m, 3 x 2 x 24 AWG/19, resolver plug 12-pin Intercontec socket, servo plug 9-pin DSUB plug, can be used in cable drag chains, UL/CSA listed	
8CR007.12-1	Resolver cable, length 7m, 3 x 2 x 24 AWG/19, resolver plug 12-pin Intercontec socket, servo plug 9-pin DSUB plug, can be used in cable drag chains, UL/CSA listed	
8CR010.12-1	Resolver cable, length 10m, 3 x 2 x 24 AWG/19, resolver plug 12-pin Intercontec socket, servo plug 9-pin DSUB plug, can be used in cable drag chains, UL/CSA listed	
8CR015.12-1	Resolver cable, length 15m, 3 x 2 x 24 AWG/19, resolver plug 12-pin Intercontec socket, servo plug 9-pin DSUB plug, can be used in cable drag chains, UL/CSA listed	
8CR020.12-1	Resolver cable, length 20m, 3 x 2 x 24 AWG/19, resolver plug 12-pin Intercontec socket, servo plug 9-pin DSUB plug, can be used in cable drag chains, UL/CSA listed	
8CR025.12-1	Resolver cable, length 25m, 3 x 2 x 24 AWG/19, resolver plug 12-pin Intercontec socket, servo plug 9-pin DSUB plug, can be used in cable drag chains, UL/CSA listed	

Table 57: Order data for resolver cables

2.4.2 Technical Data

Product ID	Resolver Cables
General Information	
Cable Cross Section	3 x 2 x 24 AWG/19
Durability	Oil resistant according to VDE 0472 part 803, as well as standard hydraulic oil
Certification	UL AWM Style 20671, 90°C, 30 V, E63216 and CSA AWM, 90°C, 30 V, I/II A/B FT1 LL46064
Conductor	
Signal Lines Wire Insulation Wire Colors	24 AWG/19, tinned Cu wire Special thermoplastic material White, brown, green, yellow, gray, pink
Cable Structure	
Signal Lines Stranding Shielding	White with brown, green with yellow, gray with pink No
Cable Stranding	The 3 pairs together covered by foil banding
Cable Shielding	Cu mesh, optical coverage ≥ 90% and wrapped in isolating fabric
Outer Sheathing Material Color Labeling	PUR RAL 6018 BERNECKER + RAINER 3x2x24 AWG FLEX

Table 58: Technical data for resolver cables

Technical Data • Cables

Product ID	Resolver Cables
Electrical Characteristics	
Conductor Resistance 24 AWG	$\leq 86 \Omega/\text{km}$
Insulation Resistance	$> 200 \text{ M}\Omega$ per km
Isolation Voltage Wire/Wire Wire/Shield	1.5 kV 0.8 kV
Operating Voltage	Max. 30 V
Mechanical Characteristics	
Temperature Range Moving Static	-10° C to +80° C -40° C to +90° C
Outer Diameter	6.5 mm \pm 0.2 mm
Flex Radius	≥ 50 mm
Speed	≤ 4 m/s
Acceleration	< 60 m/s ²
Flex Cycles	$\geq 3,000,000$
Weight	0.07 kg/m

Table 58: Technical data for resolver cables (Forts.)

3. Connectors

3.1 General Information

B&R offers five different motor/encoder connectors for 8MS three-phase synchronous motors. All connectors have IP67 protection. The metallic housing provides a protective ground connection on the housing according to VDE 0627. All plastic used in the connector is UL94/V0 listed. High quality, gold plated cage connector contacts guarantee a high level of contact security even when reinserted many times.

Information:

Using B&R connectors guarantees that the EMC limits for the connection are not exceeded. Make sure that connectors are put together correctly including a proper shield connection.

3.2 Motor Connectors

3.2.1 Order Data



Model Number	Short Description	Image
Cable Diameter 9 - 17 mm		
8PM001.00-1	Motor connector 8-pin Intercontec socket, crimp range 4 x 0.5-2.5mm ² + 4 x 0.06-1.0mm ² , for cable ø 9-14mm, IP67, UL/CSA listed	
8PM002.00-1	Motor connector 8-pin Intercontec socket, crimp range 4 x 2.5-4.0mm ² + 4 x 0.06-1.0mm ² , for cable ø 14-17mm, IP67, UL/CSA listed	
Cable Diameter 17 - 26 mm		
8PM003.00-1	Motor connector 8-pin Intercontec socket, crimp range 4 x 1.5-10mm ² + 4 x 0.5-2.5mm ² , for cable ø 17-26mm, IP67, UL/CSA listed	

Table 59: Order data for motor connectors

3.2.2 Technical data for 8PM001.00-1 and 8PM002.00-1

Product ID	8PM001.00-1	8PM002.00-1
General Information		
Connector Size	Size 1	
Contacts	8 (4 power and 4 signal contacts)	
Degree of Pollution	3	
Installation Altitude	Up to 2,000 m	
Insulator	PA 6.6 / PBT, UL94/V0 listed	
Contacts	Gold plated brass	
Protective Ground Connection on Housing	According to VDE 0627	
Protection according to DIN 40050	IP67 when connected	
Certifications	UL/CSA	
Electrical Characteristics		
Overvoltage Category	3	
Power Contacts Rated Current rated voltage Isolation Voltage (L-L) Contact Resistance	30 A 630 VAC / VDC 6000 V < 3 mΩ	
Signal Contacts Rated Current rated voltage Isolation Voltage (L-L) Contact Resistance	10 A 250 VAC / VDC 2500 V < 5 mΩ	
Mechanical Characteristics		
Temperature Range	-20° C to +130° C	
Housing Material	Zinc die cast / brass, nickel plated	
Gaskets	FPM / HNBR	
Mating Cycles	> 50	
Crimp Range	4 x 0.5 - 2.5 mm ² + 4 x 0.06 - 1 mm ²	4 x 2.5 - 4 mm ² + 4 x 0.06 - 1 mm ²
Cable ø	9.5 - 14.5 mm	14 - 17 mm
Manufacturer Information		
Manufacturer Internet Address	INTERCONTEC www.intercontec.biz	
Manufacturer's Product ID	BSTA 108 FR 19 58 0036 000	BSTA 108 FR 35 59 0036 000

Table 60: Technical data for motor connectors 8PM001.00-1 and 8PM002.00-1

3.2.3 Technical data for 8PM003.00-1

Product ID	8PM003.00-1
General Information	
Connector Size	Size 1.5
Contacts	8 (4 power and 4 signal contacts)
Degree of Pollution	3
Installation Altitude	Up to 2,000 m
Insulator	PA 6.6 / PBT, UL94/V0 listed
Contacts	Gold plated brass
Protective Ground Connection on Housing	According to VDE 0627
Protection according to DIN 40050	IP67 when connected
Certifications	UL/CSA
Electrical Characteristics	
Oversvoltage Category	3
Power Contacts Rated Current rated voltage Isolation Voltage (L-L) Contact Resistance	75 A 630 VAC / VDC 6000 V < 1 mΩ
Signal Contacts Rated Current rated voltage Isolation Voltage (L-L) Contact Resistance	30 A 630 VAC / VDC 4000 V < 3 mΩ
Mechanical Characteristics	
Temperature Range	-20° C to +130° C
Housing Material	Magnesium die cast / aluminum, nickel plated
Gaskets	FPM / HNBR
Mating Cycles	> 50
Crimp Range	4 x 1.5 - 10 mm ² + 4 x 0.5 - 2.5 mm ²
Cable ø	17 - 26 mm
Manufacturer Information	
Manufacturer Internet Address	INTERCONTEC www.intercontec.biz
Manufacturer's Product ID	CSTA 264 FR 48 25 0001 000

Table 61: Technical data for motor connector 8PM003.00-1

3.3 Encoder Connectors

3.3.1 Order Data



Model Number	Short Description	Image
EnDat Connector		
8PE001.00-1	EnDat connector 17 pin Intercontec socket, crimp range 17 x 0.06-1.0mm ² , for cable ø 9-12mm, IP67, UL/CSA listed	 <p>17 x</p>
Resolver Connector		
8PR001.00-1	Resolver connector 12 pin Intercontec socket, crimp range 12 x 0.06-1.0mm ² , for cable ø 5.5-10.5mm, IP67, UL/CSA listed	 <p>12 x</p>

Table 62: Order data for encoder connectors

3.3.2 Technical data for EnDat connector 8PE001.00-1

Product ID	8PE001.00-1
General Information	
Connector Size	Size 1
Contacts	17 signal contacts
Degree of Pollution	3
Installation Altitude	Up to 2,000 m
Insulator	PA 6.6 / PBT, UL94/V0 listed
Contacts	Gold plated brass
Protective Ground Connection on Housing	According to VDE 0627
Protection according to DIN 40050	IP67 when connected
Certifications	UL/CSA
Electrical Characteristics	
Oversvoltage Category	3
Signal Contacts	
Rated Current	9 A
Rated Voltage	125 V
Isolation Voltage (L-L)	2500 V
Contact Resistance	< 5 mΩ
Mechanical Characteristics	
Temperature Range	-20°C to +130° C
Housing Material	Zinc die cast / brass, nickel plated
Gaskets	FPM / HNBR
Mating Cycles	> 50
Crimp Range	17 x 0.06 - 1 mm ²
Cable ø	5.5 - 10.5 mm
Manufacturer Information	
Manufacturer	INTERCONTEC
Internet Address	www.intercontec.biz
Manufacturer's Product ID	ASTA 035 FR 11 10 0035 000

Table 63: Technical data for EnDat connector 8PE001.00-1

3.3.3 Technical data for resolver connector 8PR001.00-1

Product ID	8PR001.00-1
General Information	
Connector Size	Size 1
Contacts	12 signal contacts
Degree of Pollution	3
Installation Altitude	Up to 2,000 m
Insulator	PA 6.6 / PBT, UL94/V0 listed
Contacts	Gold plated brass
Protective Ground Connection on Housing	According to VDE 0627
Protection according to DIN 40050	IP67 when connected
Certifications	UL/CSA
Electrical Characteristics	
Overvoltage Category	3
Signal Contacts	
Rated Current	9 A
Rated Voltage	160 V
Isolation Voltage (L-L)	2500 V
Contact Resistance	< 5 mΩ
Mechanical Characteristics	
Temperature Range	-20° C to +130° C
Housing Material	Zinc die cast / brass, nickel plated
Gaskets	FPM / HNBR
Mating Cycles	> 50
Crimp Range	12 x 0.06 - 1 mm ²
Cable ø	5.5 - 10.5 mm
Manufacturer Information	
Manufacturer	INTERCONTEC
Internet Address	www.intercontec.biz
Manufacturer's Product ID	ASTA 021 FR 11 10 0035 000

Table 64: Technical data for resolver connector 8PR001.00-1

Chapter 3 • Installation

1. General Information

Warning!

8MS three-phase synchronous motors are not allowed to be connected directly to the power mains, they are only allowed to be operated in combination with ACOPOS servo drives!

8MS three-phase synchronous motors must be installed on the cooling surface (= flange).

Caution!

Free convection on the motor housing must be guaranteed!

Caution!

For motors with cooling type C, make sure that the air inlet and outlet remain free and that heated air is not circulated back to the inlet area for the fan!

As specified in DIN 580, eye bolts are available on the upper and lower sides for lifting size 8 motors.

1.1 Mounting the Drive Elements

Information:

For connection of pinion gears, belt disks or similar drive elements, please use suitable clamping sets, pressure sleeves or other fastening elements.

Drive elements must be protected against unintentional removal.

Caution!

The bearing elements are not allowed to be subject to shocks or impacts! Incorrect handling will cause the lifespan of the bearings to be reduced or the bearing to be damaged.

The axial forces F_a permitted during the installation of gearboxes, pinion gears, couplings, etc. depend on the motor size and can be found in the following table:

Motor Size	Permitted Axial Force F_a [N]	
	Standard Bearing	Special Motor Option "Reinforced A Side Bearing"
2	200	---
3	200	---
4	350	700
5	500	800
6	500	800
7	500	---
8	700	1200

Table 65: Axial forces permitted during installation

Caution!

When installing drive elements on the motor shaft, avoid a hyperstatic arrangement of the motor shaft bearings. The tolerances that occur cause additional force on the motor shaft bearings.

This can significantly reduce the bearing's lifespan or damage the bearing!

The end of the shaft has a threaded center hole which can be used to remove drive elements. ¹⁾

1.2 Connection Plug

Caution!

The plug must be connected and fastened correctly.

Incorrectly connecting the plug and tightening the union nuts can cause problems and damage the servo motor or ACOPOS servo drive!

¹⁾ Not for 8MSA2 motors.

2. Detailed Dimensions

2.1 Detailed Dimensions for "Top" Connection Direction

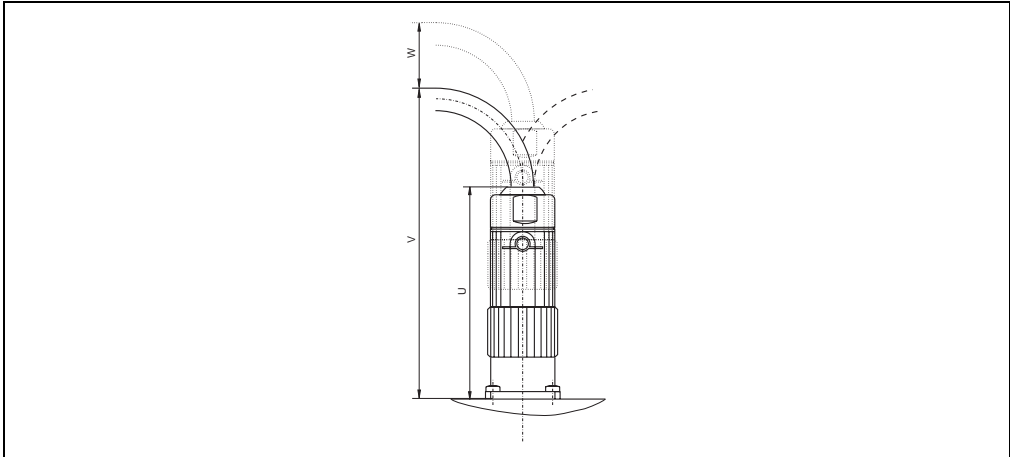

Figure 51: "Top" connection direction

2.1.1 Motor Connection

	Motor Size						
	2	3	4	5	6	7	8
U [mm]	87						142
V [mm]	87 + min. flex radius of the connection cable ¹⁾						142 + min. flex radius of the connection cable ¹⁾
W [mm] ²⁾	Min. 18						Min. 20

Table 66: Detailed dimensions for "Top" motor connection direction

- 1) For B&R cables, the min. flex radius can be taken from chapter 2 "Cables".
- 2) This minimum distance must be met to ensure proper connection and removal of the connection cable.

2.1.2 Encoder Connection

	Motor Size						
	2	3	4	5	6	7	8
U [mm]	68						
V [mm]	68 + min. flex radius of the connection cable ¹⁾						
W [mm] ²⁾	Min. 17						

Table 67: Detailed dimensions for "Top" encoder connection direction

- 1) For B&R cables, the min. flex radius can be taken from chapter 2 "Cables".
- 2) This minimum distance must be met to ensure proper connection and removal of the connection cable.

2.2 Detailed Dimensions for "A Side", "B Side" Connection Directions¹⁾

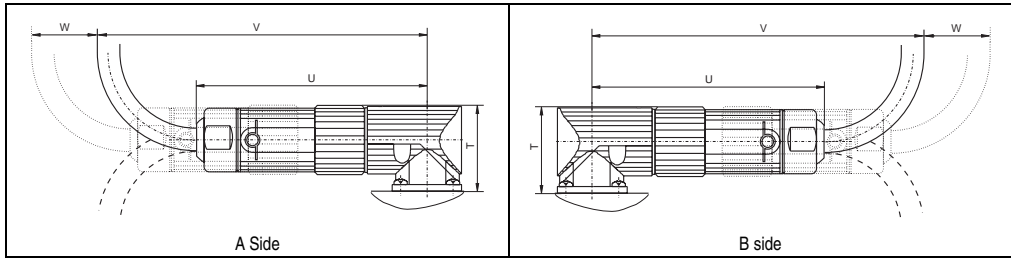

Figure 52: "A Side", "B Side" connection directions

2.2.1 Motor Connection

	Motor Size						
	2	3	4	5 ¹⁾	6 ¹⁾	7 ¹⁾	8 ¹⁾
T [mm]	32						55
U [mm]	95						152
V [mm]	95 + min. flex radius of the connection cable ²⁾						152 + min. flex radius of the connection cable ²⁾
W [mm] ³⁾	Min. 18						Min. 20

Table 68: Detailed dimensions for "A Side", "B Side" motor connection directions

- 1) Only "B side" connection direction available.
- 2) For B&R cables, the min. flex radius can be taken from chapter 2 "Cables".
- 3) This minimum distance must be met to ensure proper connection and removal of the connection cable.

2.2.2 Encoder Connection

	Motor Size						
	2	3	4	5 ¹⁾	6 ¹⁾	7 ¹⁾	8 ¹⁾
T [mm]	32						
U [mm]	86						
V [mm]	86 + min. flex radius of the connection cable ²⁾						
W [mm] ³⁾	Min. 17						

Table 69: Detailed dimensions for "A Side", "B Side" encoder connection directions

- 1) Only "B side" connection direction available.
- 2) For B&R cables, the min. flex radius can be taken from chapter 2 "Cables".
- 3) This minimum distance must be met to ensure proper connection and removal of the connection cable.

1) Not available for motors with cooling type C.

2.3 Outer Dimensions of the Connectors

Motor Connectors		Encoder Connectors
Size 1 (8PM001.00-1, 8PM002.00-1)	Size 1.5 (8PM003.00-1)	Size 1 (8PE001.00-1, 8PR001.00-1)
 <p>69</p> <p>28</p> <p>Not for 8MSA8</p>	 <p>97</p> <p>45,8</p> <p>Only for 8MSA8</p>	 <p>60</p> <p>26</p> <p>For all motors</p>

Table 70: Outer dimensions of the connectors

Chapter 4 • Wiring

1. Pin assignments 8MS

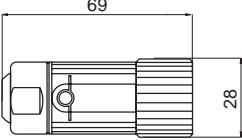
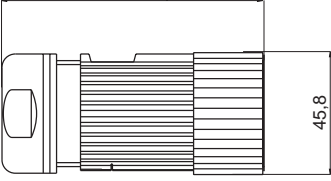
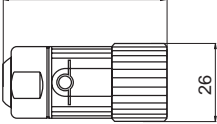
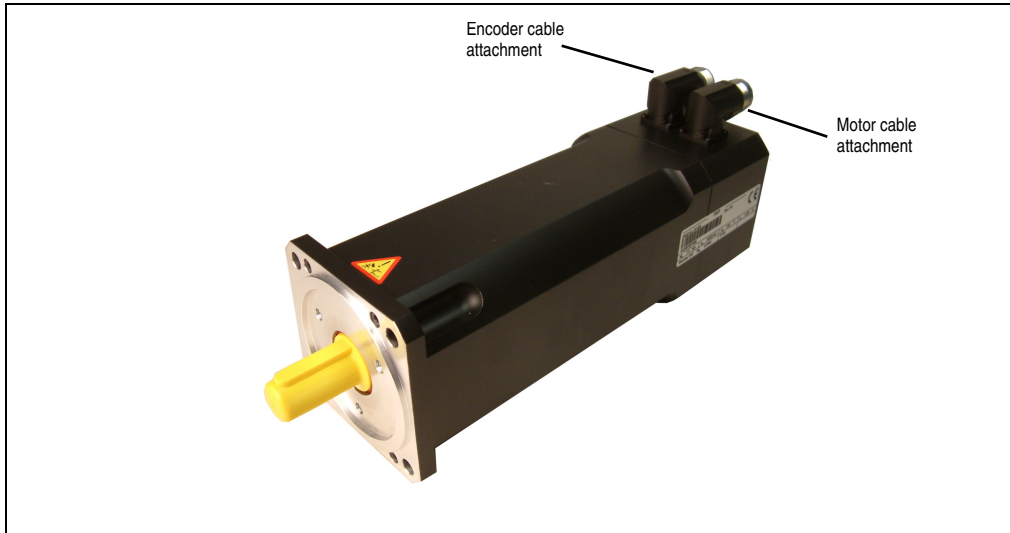

Figure 53: Overview

1.1 Motor cable attachment

1.1.1 8MSA2...8MSA7

Size 1	Pin	Description	Function
	1	U	Motor connection U
	4	V	Motor connection V
	3	W	Motor connection W
	2	PE	Protective ground conductor
	A	T+	Temperature +
	B	T-	Temperature -
	C	B+	Brake +
	D	B-	Brake -

Table 71: Pin assignments for motor cable attachment size 1

1.1.2 8MSA8

Size 1.5	Pin	Description	Function
	U	U	Motor connection U
	V	V	Motor connection V
	W	W	Motor connection W
	⏏	PE	Protective ground conductor
	1	T+	Temperature +
	2	T-	Temperature -
	+	B+	Brake +
	-	B-	Brake -

Table 72: Pin assignments for motor cable attachment size 1.5

1.2 Encoder cable attachment

1.2.1 EnDat

EnDat	Pin	Description	Function
	1	Sense +5V	Sense input +5 V
	2	---	---
	3	---	---
	4	Sense COM	Sense input 0 V
	5	---	---
	6	---	---
	7	+5V out / 0.25A	Encoder supply +5 V
	8	T	Clock output
	9	T\	Clock output inverted
	10	COM (1, 3 - 9, 11, 13 - 15)	Encoder supply 0 V
	11	---	---
	12	B	Channel B
	13	B\	Channel B inverted
	14	D	Data input
	15	A	Channel A
	16	A\	Channel A inverted
	17	D\	Data inverted

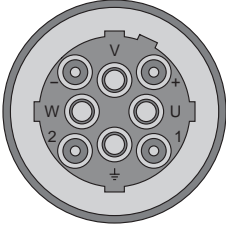
Table 73: Pin assignments for EnDat encoder cable attachment

1.2.2 Resolver

Resolver	Pin	Description	Function
	1	---	---
	2	---	---
	3	Cos	Cosine input
	4	Sin	Sine input
	5	Ref	Reference output
	6	---	---
	7	Cos\	Cosine input inverted
	8	Sin\	Sine input inverted
	9	Ref \	Reference output inverted
	10	---	---
	11	---	---
	12	---	---

Table 74: Pin assignments for resolver encoder cable attachment

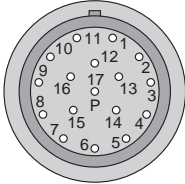
1.3 Fan Connection

The fan connection is made using a terminal block in a terminal box on the fan housing next to the motor and encoder connection.



Figure 54: Terminal box for the fan power connection

To guarantee stress relief for the connection cable, the high-strength cable gland on the terminal box cover must be installed correctly.

1.3.1 Terminal Block Pin Assignments for 220 VAC Fan

Image	Pin	Description	Function
	1	L1	Fan connection 220 VAC
	2	N	Fan connection 220 VAC
	3	PE	Protective ground conductor
	4	---	---

Table 75: Terminal block pin assignments for 220 VAC fan

1.3.2 Terminal Block Pin Assignments for 24 VDC Fan ¹⁾

Image	Pin	Description	Function
	1	---	---
	2	---	---
	3	+24 V	Fan connection +24 VDC
	4	GND	Fan connection 0 V

Table 76: Terminal block pin assignments for 24 VDC fan

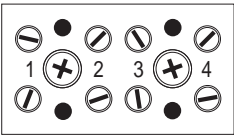
1) Fans with 24VDC operating voltage are special motor options.

2. Cables

2.1 Motor Cables

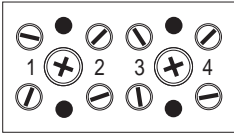
2.1.1 Motor Cable Construction

Pos.	Pieces	Description	Note
1	1	Motor lines	4 x 1.5 mm ² + 2 x 2 x 0.75 mm ² 4 x 4 mm ² + 2 x 2 x 1 mm ² 4 x 10 mm ² + 2 x 2 x 1.5 mm ² 4 x 35 mm ² + 2 x 2 x 1.5 mm ² (not prefabricated)
2	1	Circular connector	BSTA 108 FR 19 58 0036 000 (for 8CMxxx.12-1) BSTA 108 FR 35 59 0036 000 (for 8CMxxx.12-3) CSTA 264 FR 48 25 0001 000 (for 8CMxxx.12-5)
3	1	Heat shrink tubing	
4	8	Wire tip sleeve	

Table 77: Motor cable construction

2.1.2 Pin assignments for 8CMxxx.12-1, 8CMxxx.12-3

Circular connector	Pin	Description	Function
	1	U	Motor connection U
	4	V	Motor connection V
	3	W	Motor connection W
	2	PE	Protective ground conductor
	A	T+	Temperature +
	B	T-	Temperature -
	C	B+	Brake +
	D	B-	Brake -

Table 78: Pin assignments for motor cable 8CMxxx.12-1, 8CMxxx.12-3

2.1.3 Cable Schematic for 8CMxxx.12-1, 8CMxxx.12-3

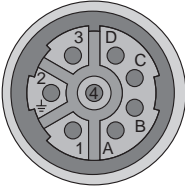
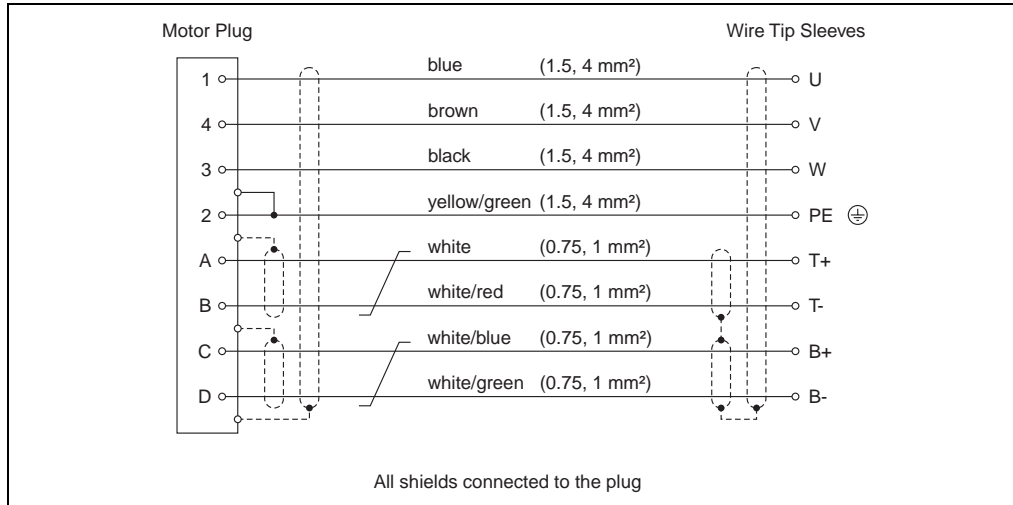

Figure 55: Cable schematic for motor cables 8CMxxx.12-1, 8CMxxx.12-3

2.1.4 Pin Assignments for 8CMxxx.12-5

Circular connector	Pin	Description	Function
	U	U	Motor connection U
	V	V	Motor connection V
	W	W	Motor connection W
	⏏	PE	Protective ground conductor
	1	T+	Temperature +
	2	T-	Temperature -
	+	B+	Brake +
	-	B-	Brake -

Table 79: Pin assignments for motor cables 8CMxxx.12-5

2.1.5 Cable Schematic for 8CMxxx.12-5

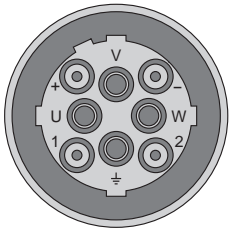
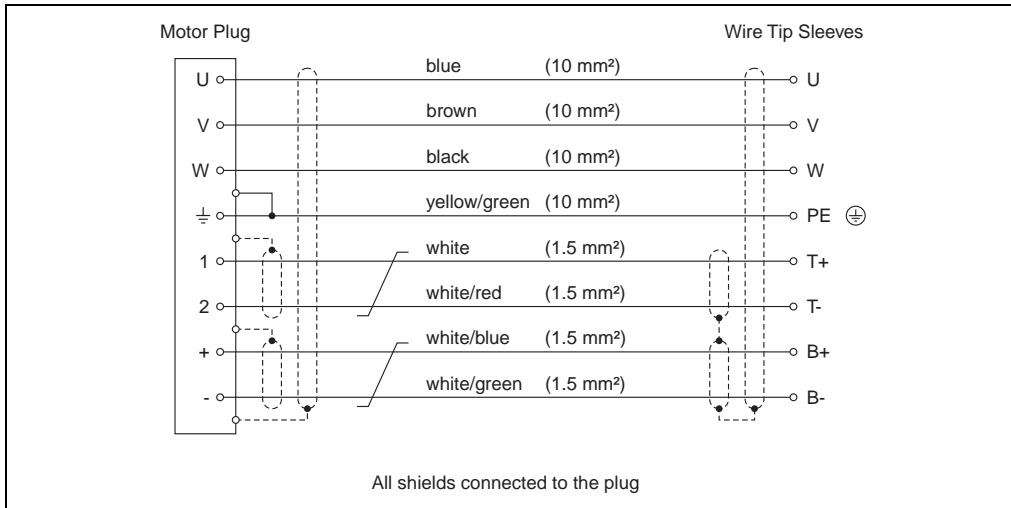
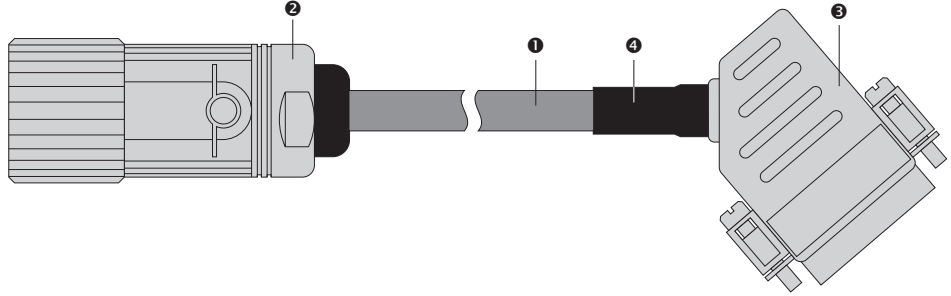

Figure 56: Cable schematic for motor cables 8CMxxx.12-5

2.2 EnDat Encoder Cables

2.2.1 EnDat Encoder Cable Construction



Pos.	Pieces	Description	Note
1	1	Encoder cable	10 x 0.14 mm ² + 2 x 0.50 mm ²
2	1	Circular connector, 17 pin socket	ASTA 035 FR 11 10 0035 000
3	1	DSUB housing 45°, metal plated, 15-pin plug	
4	1	Heat shrink tubing	

Table 80: EnDat encoder cable construction

2.2.2 Pin Assignments

Circular connector	Pin	Description	Function	Pin	DSUB plug
	15	A	Channel A	1	
	10	COM (1, 3 - 9, 11, 13 - 15)	Encoder supply 0 V	2	
	12	B	Channel B	3	
	7	+5V out / 0.25A	Encoder supply +5 V	4	
	14	D	Data input	5	
	8	T	Clock output	8	
	16	A\	Channel A inverted	9	
	4	Sense COM	Sense input 0 V	10	
	13	B\	Channel B inverted	11	
	1	Sense +5V	Sense input +5 V	12	
	17	D\	Data inverted	13	
	9	T\	Clock output inverted	15	

Table 81: Pin assignments for EnDat encoder cables

2.2.3 Cable Schematic

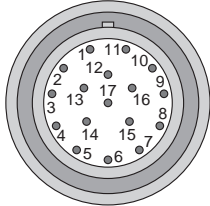
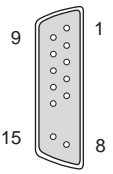
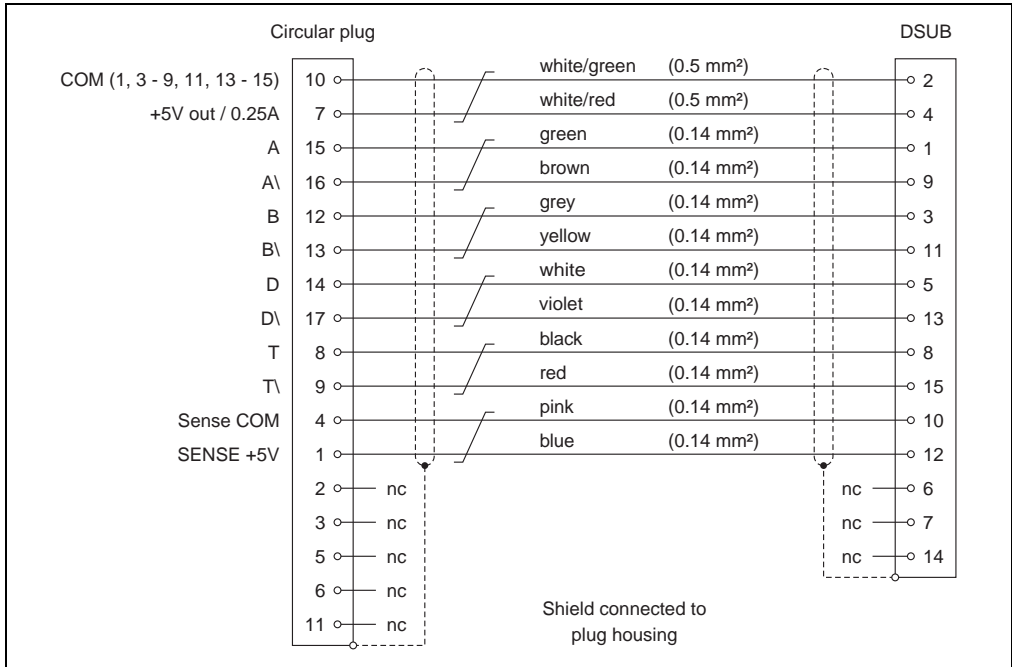
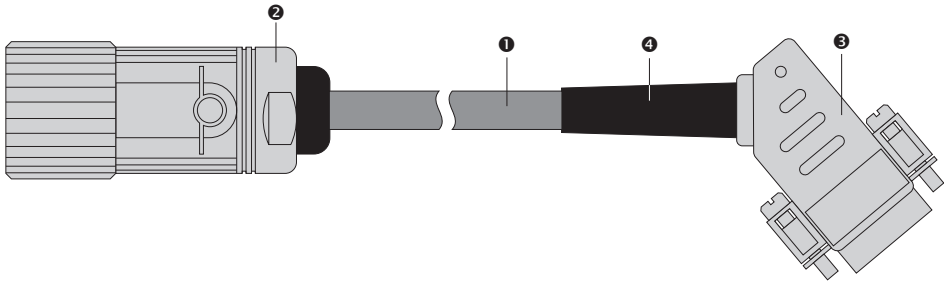

Figure 57: Cable schematic for EnDat encoder cables

2.3 Resolver Cables

2.3.1 Resolver Cable Construction



Pos.	Pieces	Description	Note
1	1	Encoder cable	3 x 2 x 24 AWG/19
2	1	Circular connector, 12 pin socket	ASTA 021 FR 11 10 0035 000
3	1	DSUB housing 45°, metal plated, 9 pin plug	
4	1	Kink protection	

Table 82: Resolver cable construction

2.3.2 Pin Assignments

Circular connector	Pin	Description	Function	Pin	DSUB plug
	1	---			
	2	---			
	3	Cos	Cosine input	3	
	4	Sin	Sine input	4	
	5	Ref	Reference output	5	
	6	---			
	7	Cos\	Cosine input inverted	7	
	8	Sin\	Sine input inverted	8	
	9	Ref \	Reference output inverted	9	
	10	---			
	11	---			
	12	---			

Table 83: Pin assignments for resolver cable

2.3.3 Cable Schematic

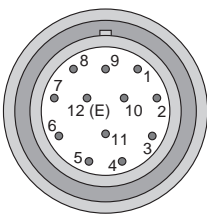
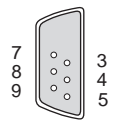
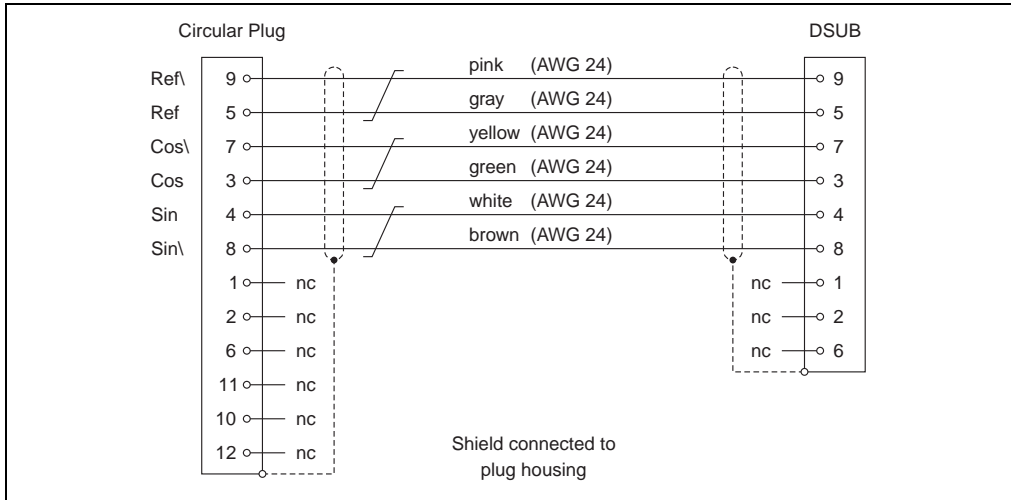

Figure 58: Cable schematic for resolver cables

Chapter 5 • Standards and Certifications

1. Valid European Guidelines

- EMC guidelines 89/336/EWG
- Low-voltage guidelines 73/23/EWG
- Machine guidelines 98/37/EG

2. Valid Standards for Servo Motors

Standard	Description
EN 60034-1	Rotating electrical machines <ul style="list-style-type: none"> • Part 1: measurement and operational behavior
EN 60034-5	Rotating electrical machines <ul style="list-style-type: none"> • Part 5: Degrees of protection provided by the integral design of rotating electrical machines (IP code)
EN 60034-6	Rotating electrical machines <ul style="list-style-type: none"> • Part 6: Methods of cooling (IC code)
EN 60034-7	Rotating electrical machines <ul style="list-style-type: none"> • Part 7: Classification of types of construction, mounting arrangements and terminal box position (IM code)
IEC 60034-11	Rotating electrical machines <ul style="list-style-type: none"> • Part 11: Built-in thermal protection
EN 60034-14	Rotating electrical machines <ul style="list-style-type: none"> • Part 14: Mechanical vibration of certain machines with shaft heights 56 mm and higher; measurement, evaluation and limits of vibration
DIN ISO 281	Rolling Bearing, Dynamic Load Ratings and Rating Life
DIN 580	Lifting eye bolts
DIN 748	Cylindrical shaft ends for electrical machines
DIN 3760	Rotary oil seals
DIN 6885-1	Drive type fastenings without taper action; keys, keyways, deep pattern
DIN ISO 8821	Mechanical vibration; convention for balancing shaft/fittings and key type
DIN 42948	Mounting flanges for electrical machines
DIN 42955	Concentricity of the shaft end, coaxial mounting flanges for rotary electrical machines; tolerances, tests
UL 1004	Standard for Electric Motors

Table 84: Valid standards for servo motors

3. International Certifications

B&R products and services comply with the applicable standards. They are international standards from organizations such as ISO, IEC and CENELEC, as well as national standards from organizations such as UL, CSA, FCC, VDE, ÖVE, etc. We give special consideration to the reliability of our products in an industrial environment.



Certifications	
<p>USA and Canada</p> 	<p>All 8MS three-phase synchronous motors are tested and listed by Underwriters Laboratories. This mark is valid for the USA and Canada and eases certification of your machines and systems in these areas.</p>
<p>Europe</p> 	<p>All harmonized EN standards for the valid guidelines are met.</p>

Table 85: International Certifications

4. Standards, Definitions for Safety Techniques

Stop Functions according to IEC 60204-1/11.98 (electrical equipment for machines, part 1: general requirements)

The following three stop function categories exist:

Category	Description
0	Stop by immediately switching off the power to the machine drive elements (i.e. uncontrolled stop).
1	A controlled stop, the power to the machine drive elements remains on until the stop procedure is completed. The power is switched off after the stop is complete.
2	A controlled stop, the power to the machine drive elements is not switched off.

Table 86: Overview of stop function categories

The necessary stop functions must be determined based on a risk evaluation for the machine. Stop functions in category 0 and category 1 must be able to function regardless of the operating mode. A category 0 stop must have priority. Stop functions must have priority over assigned start functions. Resetting the stop function is not allowed to cause a dangerous state.

Emergency stops according to IEC 60204-1/11.98 (electrical equipment for machines, part 1: general requirements)

The following requirements are valid for emergency stops in addition to the requirements for the stop functions:

- It must have priority over all other functions and operations in all operating modes.
- The power to the machine drive elements which can cause a dangerous state must be switched off as quickly as possible without creating other dangers.
- Resetting is not allowed to cause a restart.

Emergency stops must be category 0 or category 1 stop functions. The necessary stop function must be determined based on a risk evaluation for the machine.

For emergency stop function in stop category 0, only hard wired, electromechanical equipment can be used. Additionally, the function is not allowed to depend on electronic switching logic (hardware or software) or the transfer of commands via a communication network or data connection. ¹⁾

When using a category 1 stop function for the emergency stop function, it must be guaranteed that the power to the machine drive elements is completely switched off. These elements must be switched off using electromechanical equipment. ¹⁾

¹⁾ In accordance to the national foreword for the valid German version of IEC 60204-1/11.98, it is determined that electronic equipment (and also especially for emergency stop systems) can be used regardless of the stop category, if e.g. it provides the same safety using the standards EN 954-1 and/or IEC 61508 as required by IEC 60204-1.

Safety category according to EN 954-1/03.97 (safety of machines - safety related parts of control systems, part 1: general design principles) ¹⁾

The safety related parts of control systems must meet one or more of the requirements for five defined safety categories. The safety categories define the required behavior of safety related controller parts regarding their resistance to errors.

Safety Category (according to EN 954-1)	Safety Integrity Level - SIL (according to IEC 61508-2)	Short Description	System Behavior
B	---	Safety related parts must be designed and built so that they can meet the expected operational requirements. (No specific safety measures are implemented.)	Caution! An error can cause the safety function to fail.
1	1	Safety related parts must be designed and built so that only reliable components and safety principles are used. (e.g. preventing short circuits by using sufficient distances, reducing the probability of errors by over-dimensioning components, defining the failure route - closed-circuit current principle, etc.)	Caution! An error can cause the safety function to fail.
2	1	Safety related parts must be designed so that their safety functions are checked in suitable intervals by the machine controller. (e.g. automatic or manual check during start-up)	Caution! An error between checks can cause the safety function to fail. If the safety function fails, it will be recognized during the check.
3	2	Safety related parts must be designed so that individual errors do not cause the safety function to fail. Individual errors should - if possible - be recognized the next time (or before) the safety function is required.	Caution! The safety function remains active when an error occurs. Some, but not all errors are recognized. A buildup of errors can cause the safety function to fail.
4	3	Safety related parts must be designed so that individual errors do not cause the safety function to fail. Individual errors must be recognized the next time (or before) the safety function is required. If this type of recognition is not possible, a buildup of errors is not allowed to cause the safety function to fail.	Information: The safety function remains active when an error occurs. Errors are recognized in time to prevent the safety function from failing.

Table 87: Safety category overview

1) To prevent confusing EN 951-1 categories with IEC 60204-1 stop categories, the term "safety categories" was used in the text shown above for EN 954-1 categories.

Selecting the suitable safety category must be done separately for each ACOPOS servo drive (or for each shaft) based on a risk evaluation. This risk evaluation is a part of the total risk evaluation for the machine.

The following risk graph (according to EN 954-1, Appendix B) provides a simplified procedure for risk evaluation:

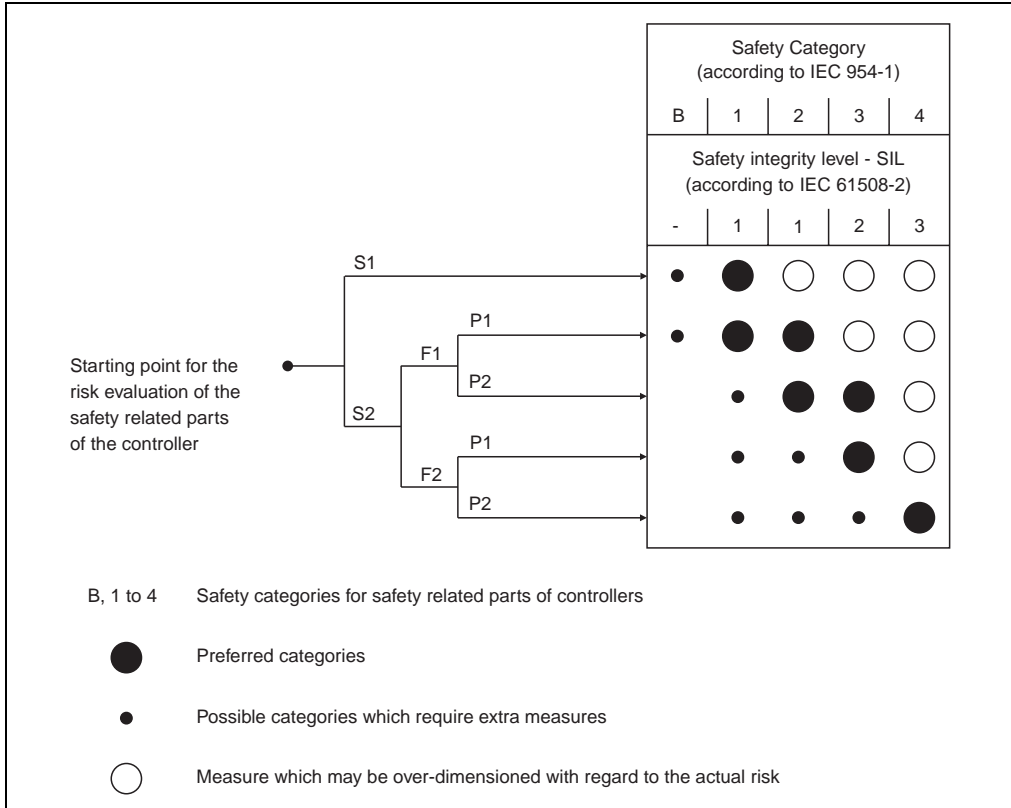

Figure 59: Risk graph according to EN 954-1, Appendix B

Begin at the starting point shown and follow the parameters S, F and P to the safety category to be used.

Parameter S ... Seriousness of injury	
S1	Light (usually reversible) injury.
S2	Serious (usually irreversible) injury.
Parameter F ... Frequency and/or duration of the danger exposure	
F1	Seldom to slightly more frequent and/or short exposure duration.
F2	Frequent to continuous and/or long exposure duration.

Table 88: Parameters S, F and P lead you to the safety category to be used

Parameter S ... Seriousness of injury	
Parameter P ... Possibility to prevent danger	
P1	Possible under some conditions.
P2	Nearly impossible.

Table 88: Parameters S, F and P lead you to the safety category to be used (Forts.)

Restart inhibit according to EN 1037/04.96 (Safety of machinery - prevention of unexpected start-up)

Keeping a machine in an idle state when people are working in the danger zone is one of the most important requirements for safe operation of machines.

Starting refers to the transition of a machine or its parts from an idle state to moving state. Any start is unexpected if it is caused by:

- A start command sent because of a controller failure or because of external influences on the controller.
- A start command sent because of incorrect operation of a start element or another part of the machine.
- Restoration of power supply after an interruption.
- External/internal influences on parts of the machine.

To prevent unexpected starting of machines or parts of machines, power should be removed and dissipated. If this is not practical (e.g. frequent, short work in danger zone), other measures must be taken:

- Measures to prevent random start commands.
- Measures to prevent that random start commands cause unexpected starting.
- Measures to automatically stop dangerous parts of the machine before a dangerous situation can be caused by unexpected starting.

Figure 1:	8MS three-phase synchronous motors	11
Figure 2:	Start-up with B&R Automation Studio™	13
Figure 3:	Warning on the servo drives	17
Figure 4:	"Hot surface" warning	19
Figure 5:	Detailed view of oil seal	27
Figure 6:	Definitions for diagrams of maximum shaft load	40
Figure 7:	Speed - torque characteristic curve for 8MSA2S.dd-eeff	49
Figure 8:	Speed - torque characteristic curve for 8MSA2M.dd-eeff	49
Figure 9:	Speed - torque characteristic curve for 8MSA2L.dd-eeff	50
Figure 10:	Speed - torque characteristic curve for 8MSA2X.dd-eeff	50
Figure 11:	Speed - torque characteristic curve for 8MSA3S.dd-eeff	54
Figure 12:	Speed - torque characteristic curve for 8MSA3M.dd-eeff	54
Figure 13:	Speed - torque characteristic curve for 8MSA3L.dd-eeff	55
Figure 14:	Speed - torque characteristic curve for 8MSA3X.dd-eeff	55
Figure 15:	Speed - torque characteristic curve for 8MSA4S.dd-eeff	59
Figure 16:	Speed - torque characteristic curve for 8MSA4M.dd-eeff	59
Figure 17:	Speed - torque characteristic curve for 8MSA4L.dd-eeff	60
Figure 18:	Speed - torque characteristic curve for 8MSA4X.dd-eeff	60
Figure 19:	Speed - torque characteristic curve for 8MSA5S.dd-eeff-1	64
Figure 20:	Speed - torque characteristic curve for 8MSA5M.dd-eeff-1	64
Figure 21:	Speed - torque characteristic curve for 8MSA5L.dd-eeff-1	65
Figure 22:	Speed - torque characteristic curve for 8MSA5X.dd-eeff-1	65
Figure 23:	Speed - torque characteristic curve for 8MSA5E.dd-eeff-1	66
Figure 24:	Speed - torque characteristic curve for 8MSA6S.dd-eeff-1	70
Figure 25:	Speed - torque characteristic curve for 8MSA6M.dd-eeff-1	70
Figure 26:	Speed - torque characteristic curve for 8MSA6L.dd-eeff-1	71
Figure 27:	Speed - torque characteristic curve for 8MSA6X.dd-eeff-1	71
Figure 28:	Speed - torque characteristic curve for 8MSA7S.dd-eeff	75
Figure 29:	Speed - torque characteristic curve for 8MSA7M.dd-eeff	75
Figure 30:	Speed - torque characteristic curve for 8MSA7L.dd-eeff	76
Figure 31:	Speed - torque characteristic curve for 8MSA8S.dd-eeff	80
Figure 32:	Speed - torque characteristic curve for 8MSA8M.dd-eeff	80
Figure 33:	Speed - torque characteristic curve for 8MSA8L.dd-eeff	81
Figure 34:	Speed - torque characteristic curve for 8MSA8X.dd-eeff	81
Figure 35:	Speed - torque characteristic curve for 8MSC4S.dd-eeff	90
Figure 36:	Speed - torque characteristic curve for 8MSC4M.dd-eeff	90
Figure 37:	Speed - torque characteristic curve for 8MSC4L.dd-eeff	91
Figure 38:	Speed - torque characteristic curve for 8MSC4X.dd-eeff	91
Figure 39:	Speed - torque characteristic curve for 8MSC5S.dd-eeff-2	95
Figure 40:	Speed - torque characteristic curve for 8MSC5M.dd-eeff-2	95
Figure 41:	Speed - torque characteristic curve for 8MSC5L.dd-eeff-2	96
Figure 42:	Speed - torque characteristic curve for 8MSC5X.dd-eeff-2	96
Figure 43:	Speed - torque characteristic curve for 8MSC5E.dd-eeff-2	97
Figure 44:	Speed - torque characteristic curve for 8MSC6S.dd-eeff-2	101
Figure 45:	Speed - torque characteristic curve for 8MSC6M.dd-eeff-2	101
Figure 46:	Speed - torque characteristic curve for 8MSC6L.dd-eeff-2	102
Figure 47:	Speed - torque characteristic curve for 8MSC6X.dd-eeff-2	102

Images

Figure 48:	Speed - torque characteristic curve for 8MSC7S.dd-eeff-1.....	106
Figure 49:	Speed - torque characteristic curve for 8MSC7M.dd-eeff-1	106
Figure 50:	Speed - torque characteristic curve for 8MSC7L.dd-eeff-1	107
Figure 51:	"Top" connection direction.....	129
Figure 52:	"A Side", "B Side" connection directions	130
Figure 53:	Overview	133
Figure 54:	Terminal box for the fan power connection	135
Figure 55:	Cable schematic for motor cables 8CMxxx.12-1, 8CMxxx.12-3.....	138
Figure 56:	Cable schematic for motor cables 8CMxxx.12-5.....	139
Figure 57:	Cable schematic for EnDat encoder cables	141
Figure 58:	Cable schematic for resolver cables	143
Figure 59:	Risk graph according to EN 954-1, Appendix B.....	149

Table 1:	Description of the safety notices used in this manual	19
Table 2:	Available sizes for each cooling type	23
Table 3:	Available lengths	23
Table 4:	Technical data for EnDat encoders	24
Table 5:	Technical data for the resolver	25
Table 6:	Rated speeds available according to size and length	26
Table 7:	Technical data for the standard holding brake	28
Table 8:	Axial forces permitted during installation	30
Table 9:	Available connection directions	32
Table 10:	Order key code (ee) for the motor options	33
Table 11:	Available motor sizes for special motor option "reinforced A side bearing"	34
Table 12:	General technical data	38
Table 13:	Connection direction terminology, bearings	40
Table 14:	Formula Symbols	40
Table 15:	Motor data overview for cooling type A	43
Table 16:	Motor data overview for cooling type A (cont.)	44
Table 17:	Motor data overview for cooling type A (cont.)	45
Table 18:	Motor data overview for cooling type A (cont.)	46
Table 19:	Motor data overview for cooling type A (cont.)	47
Table 20:	Technical data for 8MSA2	48
Table 21:	8MSA2 dimensions	51
Table 22:	Maximum shaft load for 8MSA2	52
Table 23:	Technical data for 8MSA3	53
Table 24:	8MSA3 dimensions	56
Table 25:	Maximum shaft load for 8MSA3	57
Table 26:	Technical data for 8MSA4	58
Table 27:	8MSA4 dimensions	61
Table 28:	Maximum shaft load for 8MSA4	62
Table 29:	Technical data for 8MSA5	63
Table 30:	8MSA5 dimensions	67
Table 31:	Maximum shaft load for 8MSA5	68
Table 32:	Technical data for 8MSA6	69
Table 33:	8MSA6 dimensions	72
Table 34:	Maximum shaft load for 8MSA6	73
Table 35:	Technical data for 8MSA7	74
Table 36:	8MSA7 dimensions	77
Table 37:	Maximum shaft load for 8MSA4	78
Table 38:	Technical data for 8MSA8	79
Table 39:	8MSA8 dimensions	82
Table 40:	Maximum shaft load for 8MSA8	83
Table 41:	Motor data overview for cooling type C	85
Table 42:	Motor data overview for cooling type C (cont.)	86
Table 43:	Motor data overview for cooling type C (cont.)	87
Table 44:	Overview of fan modules	88
Table 45:	Technical data for fans	88
Table 46:	Technical data for 8MSC4	89
Table 47:	8MSC4 dimensions	92

Table Index

Table 48:	Maximum shaft load for 8MSC4.....	93
Table 49:	Technical data for 8MSC5.....	94
Table 50:	8MSC5 dimensions	98
Table 51:	Maximum shaft load for 8MSC5.....	99
Table 52:	Technical data for 8MSC6.....	100
Table 53:	8MSC6 dimensions	103
Table 54:	Maximum shaft load for 8MSC6.....	104
Table 55:	Technical data for 8MSC7.....	105
Table 56:	8MSC7 dimensions	108
Table 57:	Maximum shaft load for 8MSC7.....	109
Table 58:	Order data for motor cables	111
Table 59:	Technical data for motor cables 1.5 and 4 mm ²	113
Table 60:	Technical data for motor cables 10 and 35 mm ²	114
Table 61:	Order data for EnDat cables	115
Table 62:	Technical data for EnDat cables	115
Table 63:	Order data for resolver cables.....	117
Table 64:	Technical data for resolver cables	117
Table 65:	Order data for motor connectors	120
Table 66:	Technical data for motor connectors 8PM001.00-1 and 8PM002.00-1	121
Table 67:	Technical data for motor connector 8PM003.00-1	122
Table 68:	Order data for encoder connectors	123
Table 69:	Technical data for EnDat connector 8PE001.00-1	124
Table 70:	Technical data for resolver connector 8PR001.00-1	125
Table 71:	Axial forces permitted during installation.....	128
Table 72:	Detailed dimensions for "Top" motor connection direction.....	129
Table 73:	Detailed dimensions for "Top" encoder connection direction.....	129
Table 74:	Detailed dimensions for "A Side", "B Side" motor connection directions	130
Table 75:	Detailed dimensions for "A Side", "B Side" encoder connection directions.....	130
Table 76:	Outer dimensions of the connectors	131
Table 77:	Pin assignments for motor cable attachment size 1.....	133
Table 78:	Pin assignments for motor cable attachment size 1.5.....	134
Table 79:	Pin assignments for EnDat encoder cable attachment	134
Table 80:	Pin assignments for resolver encoder cable attachment	135
Table 81:	Terminal block pin assignments for 220 VAC fan	136
Table 82:	Terminal block pin assignments for 24 VDC fan	136
Table 83:	Motor cable construction	137
Table 84:	Pin assignments for motor cable 8CMxxx.12-1, 8CMxxx.12-3.....	138
Table 85:	Pin assignments for motor cables 8CMxxx.12-5.....	139
Table 86:	EnDat encoder cable construction	140
Table 87:	Pin assignments for EnDat encoder cables	140
Table 88:	Resolver cable construction	142
Table 89:	Pin assignments for resolver cable	142
Table 90:	Valid standards for servo motors	145
Table 91:	International Certifications.....	146
Table 92:	Overview of stop function categories	147
Table 93:	Safety category overview.....	148
Table 94:	Parameters S, F and P lead you to the safety category to be used.....	149

Numerics

8MS Three-phase Synchronous Motors	21
8MSA2	48
8MSA3	53
8MSA4	58
8MSA5	63
8MSA6	69
8MSA7	74
8MSA8	79
8MSC4	89
8MSC5	94
8MSC6	100
8MSC7	105

A

A Side	
see Connection Directions	
A Side Bearing	
See Terminology	
Axial Force	31

B

B Side	
see Connection Directions	
B Side Bearing	
See Terminology	
Brake	
see Holding Brake	

C

Cables	
Encoder Cables	
EnDat	115, 140
Resolver	117, 142
General Information	110
Motor Cables	111, 137
Certifications	146
Connection Direction	
A Side	40
also see Detailed Dimensions	
B Side	40
Top	40

Connector	
see Connectors	
Connectors	
Encoder Connectors	
EnDat	123, 140
Resolver	123, 142
General Information	119
Motor Connectors	120, 138
Outer Dimensions	131

D

Danger Warning	15
Detailed Dimensions	
A Side Connection Direction	130
B Side Connection Direction	130
Encoder Connectors	131
Motor Connectors	131
Top Connection Direction	129

Dimensions

Motors	
8MSA2	51
8MSA3	56
8MSA4	61
8MSA5	67
8MSA6	72
8MSA8	82
8MSC4	92
8MSC5	98
8MSC6	103
8MSC7	108

E

Encoder Cables	
EnDat	115, 140
Resolver	117, 142
Encoder Connectors	
EnDat	123, 140
Resolver	123, 142
EnDat Cables	
Cable Schematic	141
Order Data	115
Pin Assignments	140
Structure	140
Technical Data	115

Index

EnDat Connector		8MSC4	93
Order Data	123	8MSC5	99
Pin Assignments	140	8MSC6	104
Technical Data	124	8MSC7	109
F		Motor Cables	
Fan Modules		Cable Schematic	138, 139
Overview	88	Order Data	111
Fans		Pin Assignments	138, 139
Connection	135	Structure	137
Pin Assignments		Technical Data	113
220 VAC Operating Voltage	136	Motor Characteristic Curves	
24 VDC Operating Voltage	136	8MSA2	49
Formula Symbols	40	8MSA3	54
		8MSA4	59
G		8MSA5	64
Guidelines	145	8MSA6	70
		8MSA7	75
H		8MSA8	80
Holding Brake		8MSC4	90
Functionality	27	8MSC5	95
Lifespan (cycles)	27	8MSC6	101
Technical Data	28	8MSC7	106
I		Motor Connectors	
Installation	16, 127	Order Data	120
		Pin Assignments	138, 139
L		Technical Data	121, 122
Lengths		Motor Data	
see Motors		see Technical Data	
M		Motor Data, General	38
Maximum Shaft Load		Motors	
8MSA2	52	Cooling Types	22
8MSA3	57	Danger Warning	15
8MSA4	62	Dimensions	
8MSA5	68	see Dimensions	
8MSA6	73	Encoder Systems	24
8MSA7	78	Example Order	37
8MSA8	83	Holding Brake	27
		Installation	16
		Lengths	23
		Motor Data	
		Cooling Type A	43
		Cooling Type C	85
		Order Key	36
		Safety guidelines	15
		Sizes	22
		Storage	16
		Terminology	40

Transport	16	S	Safety Categories	148
O			Safety guidelines	15
Oil Seal			Secure restart inhibit	147
see Options for Standard Motors			Servo Motors	
Options for Standard Motors			See Motors	
Connection Direction	32		Shaft End	
Determining the Order Code	33		also see Options for Standard Motors	
Holding Brake	27		Design	28
Oil Seal	27		Keyed	29
Rated Speed	26		Load Capacity	29
Shaft End	28		Smooth Shaft End	28
Order Data			Shaft Key	28
Motors			Sizes	
Example Order	37		see Motors	
Order Key	36		Speed - Torque Characteristic Curves	
			see Motor Characteristics Curves	
P			Standards	
Pin assignments			Servo Motors	145
Cable and Plug	137		Storage	16
R			T	
Radial Force	30		Technical Data	
Rated Speed			Fan Modules	22
see Options for Standard Motors			Motors	
Resolver Cables			8MSA2	48
Cable Schematic	143		8MSA3	53
Order Data	117		8MSA4	58
Pin Assignments	142		8MSA5	63
Structure	142		8MSA6	69
Technical Data	117		8MSA7	74
Resolver Connector			8MSA8	79
Order Data	123		8MSC4	89
Pin Assignments	142		8MSC5	94
Technical Data	125		8MSC6	100
Restart inhibit	147		8MSC7	105
Risk Evaluation	149		Terminology	40
			Transport	16

8

8CE005.12-1.....	115	8CM020.12-8.....	112
8CE007.12-1.....	115	8CM025.12-1.....	111
8CE010.12-1.....	115	8CM025.12-3.....	111
8CE015.12-1.....	115	8CM025.12-5.....	111
8CE020.12-1.....	115	8CM025.12-8.....	112
8CE025.12-1.....	115	8CR005.12-1.....	117
8CM005.12-1.....	111	8CR007.12-1.....	117
8CM005.12-3.....	111	8CR010.12-1.....	117
8CM005.12-5.....	111	8CR015.12-1.....	117
8CM005.12-8.....	112	8CR020.12-1.....	117
8CM007.12-1.....	111	8CR025.12-1.....	117
8CM007.12-3.....	111	8MSA2.....	48
8CM007.12-5.....	111	8MSA3.....	53
8CM007.12-8.....	112	8MSA4.....	58
8CM010.12-1.....	111	8MSA5.....	63
8CM010.12-3.....	111	8MSA6.....	69
8CM010.12-5.....	111	8MSA7.....	74
8CM010.12-8.....	112	8MSA8.....	79
8CM015.12-1.....	111	8MSC4.....	89
8CM015.12-3.....	111	8MSC5.....	94
8CM015.12-5.....	111	8MSC6.....	100
8CM015.12-8.....	112	8MSC7.....	105
8CM020.12-1.....	111	8PE001.00-1.....	123
8CM020.12-3.....	111	8PM001.00-1.....	120
8CM020.12-5.....	111	8PM002.00-1.....	120
		8PM003.00-1.....	120
		8PR001.00-1.....	123

MAMOT1-E