

SIEMENS

SIMATIC PC

Panel PC IL 77

Operating Instructions

Preface

Safety notes and general information

1

Description

2

Planning deployment

3

Installation

4

Connection

5

Commissioning

6

Operation and configuration

7

Operation

8

Integration in TIA

9

Maintenance and servicing

10

Alarm, error and system messages

11

Troubleshooting and FAQs

12

Technical data

13

Detailed descriptions

14

Appendix A

A

Safety Guidelines

This manual contains notices which you should observe to ensure your own personal safety as well as to avoid property damage. The notices referring to your personal safety are highlighted in the manual by a safety alert symbol, notices referring to property damage only have no safety alert symbol.



Danger

indicates an imminently hazardous situation which, if not avoided, will result in death or serious injury.



Warning

indicates a potentially hazardous situation which, if not avoided, could result in death or serious injury.



Caution

used with the safety alert symbol indicates a potentially hazardous situation which, if not avoided, may result in minor or moderate injury.

Caution

used without safety alert symbol indicates a potentially hazardous situation which, if not avoided, may result in property damage.

Notice

used without the safety alert symbol indicates a potential situation which, if not avoided, may result in an undesirable result or state.

When several danger levels apply, the notices of the highest level (lower number) are always displayed. If a notice refers to personal damages with the safety alert symbol, then another notice may be added warning of property damage.

Qualified Personnel

The device/system may only be set up and operated in conjunction with this documentation. Only qualified personnel should be allowed to install and work on the equipment. Qualified persons are defined as persons who are authorized to commission, to earth, and to tag circuits, equipment and systems in accordance with established safety practices and standards.

Intended Use

Please note the following:



Warning

This device and its components may only be used for the applications described in the catalog or technical description, and only in connection with devices or components from other manufacturers approved or recommended by Siemens.

This product can only function correctly and safely if it is transported, stored, set up and installed correctly, and operated and maintained as recommended.

Trademarks

All designations marked with ® are registered trademarks of Siemens AG. Other designations in this documentation might be trademarks which, if used by third parties for their purposes, might infringe upon the rights of the proprietors.

(A)

가

Copyright Siemens AG, 2004. All rights reserved

Reproduction, transmission or use of this document or its contents is not permitted without express written authority. Offenders will be liable for damages. All rights, including rights created by patent grant or registration of a utility model or design, are reserved.

Disclaimer of Liability

We have checked the contents of this manual for agreement with the hardware and software described. Since deviations cannot be precluded entirely, we cannot guarantee full agreement. However, the data in the manual are reviewed regularly, and any necessary corrections will be included in subsequent editions. Suggestions for improvement are welcomed.

Siemens AG
Automation and Drives Group
P.O. Box 4848, D-90327 Nuremberg (Germany)

© Siemens AG 2004
Technical data subject to change

Preface

Preface

Purpose of this manual

This manual provides information based on the requirements defined by DIN 8418 regarding mechanical engineering documentation. This information relates to the device, its place of use, transport, storage, installation, use and maintenance.

This manual is intended for the following target groups:

- Users
- Commissioning engineers
- Service technicians
- Maintenance technicians

Please read carefully the section "Safety information and general notes".

Basic knowledge required

A solid background in personal computers and Microsoft operating systems is required to understand this manual. General knowledge in the field automation control engineering is recommended.

Scope of the manual

This manual applies to devices with the order numbers 6AG71....

Placement in the information landscape

The documentation for the Panel PC includes the following sections:

- SIMATIC Panel PC 670 V2, QuickStart,
SIMATIC Panel PC 870 V2, QuickStart
SIMATIC Panel PC IL77, QuickStart with the following information:
 - Commissioning
 - Legal information
- SIMATIC Panel PC IL 77, Operating Instructions
- SIMATIC Panel PC 670 V2 Operating Instructions for Control Unit,
SIMATIC Panel PC 870 V2, Operating Instructions for the Control Unit with the following information:
 - Operation
 - Error diagnostics
 - Hardware

Referred to as "operating instructions for the control unit" in the following.

- SIMATIC Panel PC 670 V2 Operating Instructions for Computer Unit,
SIMATIC Panel PC 870 V2, Operating Instructions for the Computer Unit with the following information:
 - Expansion options
 - Configuration
 - Error diagnostics
 - Hardware

Referred to as "operating instructions for the computer unit" in the following.

The documentation is supplied with the Panel PC in electronic form as a PDF file on the "Documentation & Drivers" CD. QuickStart for the Panel PC IL 77 is also supplied in printed form. The documentation is available in German, English, French, Italian and Spanish.

Additional information about the Windows operating system is available in the Internet at the Microsoft homepage, "<http://www.Microsoft.com>".

Online availability

The following links will bring you directly to the technical documentation collection for SIMATIC products and systems in the languages German, English, French, Italian and Spanish.

- SIMATIC Guide Technische Dokumentation in Deutsch:
["http://www.ad.siemens.de/simatic/portal/html_00/techdoku.htm"](http://www.ad.siemens.de/simatic/portal/html_00/techdoku.htm)
- SIMATIC guide to technical documentation in English:
["http://www.ad.siemens.de/simatic/portal/html_76/techdoku.htm"](http://www.ad.siemens.de/simatic/portal/html_76/techdoku.htm)

Conventions

The following text notation will facilitate reading this manual:

Notation	Scope
"File"	<ul style="list-style-type: none"> Terminology that occurs in the user interface, e.g., dialog names, tabs, buttons, menu commands. Inputs required, e.g., limit values, tag values. Path information
"File > Edit"	Operational sequences, e.g., menu commands/shortcut menu commands.
<F1>, <Shift>+<F1>	Keys and key combinations

The term "Panel PC IL77", "control unit" and "computer unit" is uniformly referred to as the "device" in these operating instructions. The full term is only used when a concrete reference is necessary.

Note

A note is important information about the product, handling the product or a reference to specific sections of the documentation that require special consideration.

Registered trademarks

All names labeled with ® symbol are registered trademarks of Siemens AG. Other names used in this documentation may be trademarks, the use of which by third parties for their own purposes could violate the rights of the owner.

HMI®
SIMATIC®
SIMATIC HMI®
SIMATIC ProTool®
SIMATIC WinCC®
SIMATIC WinCC flexible®
Panel PC IL77®
Panel PC 670®
Panel PC 870®

Further support

Representatives and offices

If you have any further questions relating to the products described in this manual, please contact your local representative at the SIEMENS branch nearest you.

Your local representative can be found under:

["http://www.siemens.com/automation/partner"](http://www.siemens.com/automation/partner)

Training center

We offer relevant courses to simplify your introduction to the world of automation systems. Please contact your regional training center, or the central training center in D-90327 Nuremberg.

Phone: +49 (911) 895-3200

Internet: ["http://www.siemens.com/simatic"](http://www.siemens.com/simatic)

Service & Support on the Internet

Service & Support offers comprehensive information on SIMATIC products online at ["http://www.siemens.com/automation/service&support"](http://www.siemens.com/automation/service&support):

- The newsletter keeps you up-to-date with information relating to your products.
- Our Service & Support search engine provides you with abundant documentation.
- A bulletin board where users and experts exchange their knowledge worldwide.
- Current product information, FAQs and downloads.
- Your local contact for Automation & Drives.
- Information about on-site services, repairs, spare parts and much more is available on our "Services" pages.

A&D Technical Support and Authorization

Available 24 hours worldwide:

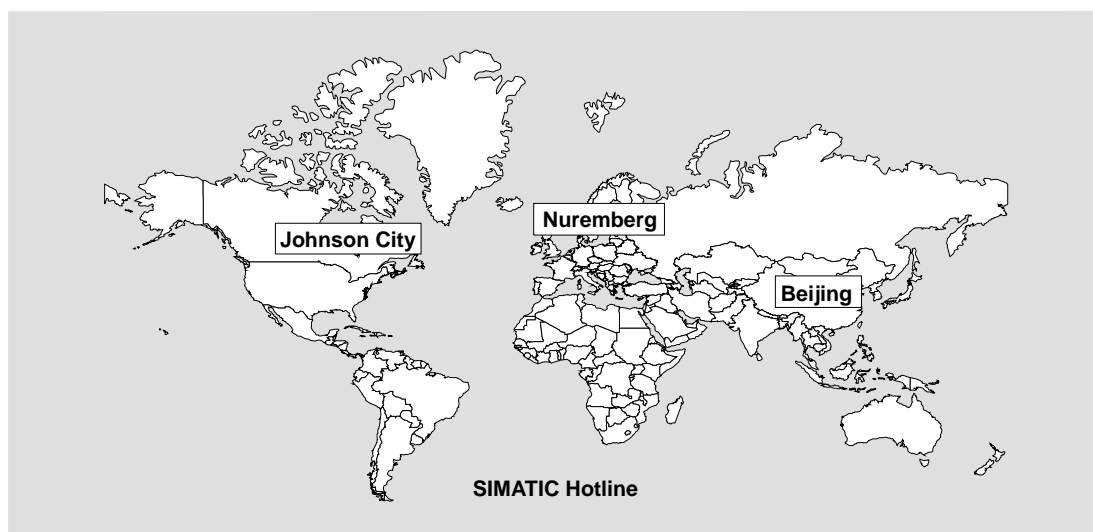

Worldwide (Nuremberg)

Technical Support (Free Contact)

Local time:
Mon.–Fri. 08:00 a.m. to 5:00 p.m.
Telephone:
+49 (0) 180 5050-222
Fax:
+49 (0) 180 5050-223
E-Mail:
adsupport@siemens.com
GMT: +1:00

Worldwide (Nuremberg)

Technical Support (fee-based, only with Automation Value Card)

Local time:
0:00 to 24:00, 365 days
Telephone:
+49 (911) 895-7777
Fax:
+49 (911) 895-7001
E-mail: –
GMT: +1:00

Europe/Africa (Nuremberg)

Authorization

Local time:
Mon.–Fri. 07:00 a.m. to 5:00 p.m.
Telephone:
+49 (911) 895-7200
Fax:
+49 (911) 895-7201
E-Mail:
adauthorisierung@siemens.com
GMT: +1:00

America (Johnson City)

Technical Support and Authorization

Local time:
Mon.–Fri. 8:00 a.m. to 7:00 p.m.
Telephone:
+1 423 461-2522
Fax:
+1 423 461-2289
E-Mail:
simatic.hotline@sea.siemens.com
GMT: –5:00

Asia/Pacific (Beijing)

Technical Support and Authorization

Local time:
Mon.–Fri. 8:30 a.m. to 5:30 p.m.
Telephone:
+86 (10) 64 75 75 75
Fax:
+86 (10) 64 74 74 74
E-mail:
adsupport.asia@siemens.com
GMT: +8:00

Information is available in German and English.

Table of contents

	Preface	i
1	Safety notes and general information	1-1
1.1	Safety notes	1-1
1.2	General Notes	1-3
2	Description.....	2-1
2.1	Application features	2-1
2.2	Design	2-2
2.3	Technical features.....	2-3
3	Planning deployment	3-1
3.1	Overview	3-1
3.2	Unpacking and checking the delivery unit	3-2
3.3	Noting the identification information.....	3-3
3.4	Guidelines for Handling Electrostatic Sensitive Devices (EMC).....	3-3
3.5	Mounting positions and fastening	3-4
3.5.1	Mounting notes	3-4
3.5.2	Approved mounting position	3-5
3.5.3	Type of fixation.....	3-5
3.5.4	Degree of protection	3-6
3.6	Installation cut-out.....	3-6
3.6.1	Selecting and creating the installation cut-out	3-6
3.6.2	Dimensions	3-7
4	Installation	4-1
4.1	Securing with clamps	4-1
4.2	Securing with screws	4-1
4.3	Dimensions	4-2
5	Connection	5-1
5.1	Overview	5-1
5.2	Ports.....	5-2
5.2.1	Front ports.....	5-2
5.2.2	Rear ports	5-3
5.3	Equipotential bonding	5-4
5.4	Connecting equipotential bonding.....	5-5
5.5	Connecting peripherals	5-5
5.5.1	Overview	5-5
5.5.2	Connecting a monitor	5-5

5.5.3	USB	5-6
5.6	Connecting the power supply	5-7
5.7	AC uninterruptible power supply	5-9
6	Commissioning	6-1
6.1	Overview	6-1
6.2	Switching on the device	6-2
6.3	Setting up the Microsoft Windows operating system	6-2
6.4	Installing drivers and applications	6-3
6.5	Windows 2000	6-6
7	Operation and configuration	7-1
7.1	Normal operation	7-1
7.1.1	Switching the device on and off	7-1
7.1.2	BIOS settings	7-2
7.2	Additional drivers and applications	7-3
7.2.1	Overview	7-3
7.2.2	Configuring the touch screen	7-3
7.2.3	KeyTools	7-4
7.2.4	SystemGuard	7-5
7.2.5	TouchInput	7-6
7.2.6	CheckLanguageID	7-6
7.2.7	Multilingual setting for the operating system	7-7
8	Operation	8-1
8.1	Operator controls	8-1
8.2	Operator controls on key panels	8-2
8.2.1	Overview	8-2
8.2.2	Keyboard	8-3
8.2.3	Labelling function keys and softkeys	8-8
8.2.4	Integrated mouse	8-9
8.3	Operator controls for touch screen panels	8-9
8.3.1	Overview	8-9
8.3.2	Touch screen	8-10
8.4	CD-ROM drive	8-11
8.5	Transferring authorizations	8-11
9	Integration in TIA	9-1
9.1	Industrial communications	9-1
9.2	PROFIBUS/MPI interface and WinAC card	9-1
10	Maintenance and servicing	10-1
10.1	Maintenance	10-1
10.2	Installing and removing hardware components	10-1
10.2.1	Repairs	10-1
10.2.2	Opening the device	10-2
10.2.3	View of internal components when device is open	10-6
10.2.4	Installing / removing memory modules	10-7
10.2.5	PCI / WinAC cards	10-8
10.2.6	Drives	10-12

10.2.7	Changing processors and heat sinks.....	10-16
10.2.8	Replacing the backup battery	10-18
10.2.9	Installing / removing the power supply module.....	10-19
10.2.10	Separating the control unit and computer unit.....	10-21
10.2.11	Connecting an external monitor.....	10-25
10.3	Installing software	10-26
10.3.1	Overview	10-26
10.3.2	Supplied software CDs	10-27
10.3.3	Restoring the software to factory state using the Restore CD.....	10-28
10.3.4	Operating system not installed.....	10-29
10.3.5	Installing individual drivers	10-29
10.4	Servicing and spare parts	10-30
11	Alarm, error and system messages	11-1
11.1	BIOS error messages	11-1
11.2	Motherboard error messages.....	11-2
12	Troubleshooting and FAQs.....	12-1
12.1	General problems	12-1
12.2	Problems with third-party modules	12-2
12.3	SystemGuard errors.....	12-3
13	Technical data	13-1
13.1	Specifications.....	13-1
13.1.1	EMC requirements	13-1
13.1.2	General specifications.....	13-2
13.1.3	Ambient and environmental conditions.....	13-4
13.2	Dimensional drawing of the device	13-5
13.3	Keyboard table	13-5
14	Detailed descriptions	14-1
14.1	Overview of the Panel PC IL 77 motherboard	14-1
14.2	Riser card.....	14-1
14.3	System resources	14-2
14.3.1	Currently allocated system resources.....	14-2
14.3.2	Interrupt assignment	14-2
14.4	BIOS Setup	14-3
14.4.1	Overview	14-3
14.4.2	Starting BIOS Setup.....	14-3
14.4.3	BIOS Setup default settings.....	14-4
A.1	Certificates and guidelines.....	A-1
A.2	Abbreviations	A-6
A.3	Glossary	A-7
	Index	

Tables

Table 10-1	Switch settings for the various control units.....	10-24
------------	--	-------

Safety notes and general information

1.1 Safety notes



Warning**Emergencies**

If the device malfunctions, remove the power cable immediately and contact your nearest customer service representative. Malfunctions can occur when the operator controls or power cable are damaged or when liquids or foreign objects penetrate the device.



Caution

Please follow the safety instructions on the back of the cover page in this documentation. You should not expand your device unless you have read the relevant safety instructions.

This device is compliant with the relevant safety measures to IEC, EN, VDE, UL, and CSA. If you have questions about the admissibility of the installation in the designated environment, please contact your service representative.

Repairs

Only authorized personnel are permitted to repair the device.



Warning

Unauthorized opening and improper repairs on the device may result in substantial damage to equipment or endanger the user.

System expansions

Install only system expansion devices designed for this computer. If you install other expansion devices, you may damage the system or violate the safety requirements and regulations on RF suppression. Contact your technical support team or where you purchased your PC to find out which system expansion devices may safely be installed.

Caution

The warranty becomes void if you damage your device by installing or replacing system expansions.

Battery

This device is equipped with a backup battery. Batteries may only be exchanged by qualified personnel.



Caution

There is the risk of an explosion if the battery is not exchanged as directed. Replace only with the same type or with an equivalent type recommended by the manufacturer. Dispose of used batteries in accordance with local regulations.



Warning

Risk of explosion and release of harmful substances!

Therefore, do not throw Lithium batteries into an open fire, do not solder or open the cell body, do not short-circuit or reverse polarity, do not heat up above 100° C, dispose as regulated and protected against direct exposure to sunlight, humidity and dewing.

Guidelines for Handling Electrostatic Sensitive Devices (ESD)

Modules containing electrostatically sensitive devices (ESDs) can be identified by the following label:



Strictly follow the guidelines mentioned below when handling modules which are sensitive to ESD:

- Always discharge your body before handling modules which are sensitive to ESD (for example, by touching a grounded object).
- All devices and tools must be free of static charge.
- Always pull the power plug and disconnect the battery before you install or remove modules which are sensitive to ESD.
- Handle modules ESD-sensitive modules only at their edges.
- Do not touch any wiring posts or conductors on a module with ESD.

Electrical Connection



Warning

Unplug the device before every intervention and after disconnecting it from the power supply.

Avoid contact with network lines and data transmission lines during thunderstorms, and do not connect any lines during this time.

High frequency radiation

Caution

Unintentional operating situation

High frequency radiation, e.g. from cell phones, can cause unintentional operating situations under some circumstances. For more details, consult the technical data in the "EMC Requirements" chapter.

Handling and disposal of lithium batteries



Warning

Danger of explosion and the release of harmful substances!

Do not throw lithium batteries into fire, do not solder onto the cell body, do not open, do not short circuit, do not reverse pole, do not heat above 100 °C, dispose of according to regulations, and protect from direct sunlight, moisture and condensation.

Replace lithium batteries with the same brand or a brand recommended by the manufacturer.

Dispose of used lithium batteries individually as hazardous waste in accordance with the local regulations.

1.2 General Notes

Overview

Caution

The device is approved for operation in closed rooms only. The guarantee is void if this stipulation is ignored.

Avoid extreme environmental operating conditions. Protect your device against dust, moisture and heat. For additional information, refer to the specifications.

Do not place the device in direct sunlight.

Transport

Unpack the device at the its installation location. Transport the device only in the original packaging. Do not transport the device when it is mounted.

Notice

Adhere to these stipulations each time the device is transported, otherwise the guarantee is void.

Caution

Condensation

When transporting the device in low temperatures, ensure that no moisture gets on or in the device. This also applies if the device is subjected to extreme changes in temperature.

Commissioning

Allow the device to slowly adjust to room temperature before commissioning the device. Do not place the device near heat radiation. If moisture condensation occurs, wait at least about 12 hours before you switch on the device.

Vibration

CD/DVD drives are sensitive to vibration. Prohibited vibration during operation may result in loss of data or damage to the drive or data medium.

Before transporting the device, wait at least 20 seconds to allow the drive to stop completely.

Updates

Regularly check if hotfixes for your device are available at the Internet site of Siemens AG.

Processor and CD-ROM drive

Caution

Danger of overheating the processor!

Do not activate the "Silent mode" option in the BIOS Setup.

Notice

A CD-ROM drive should only be operated in a mechanically undisturbed environment without vibrations and shock.

Resistance to chemicals

Caution

Adhere to the notes regarding chemical resistance. This information is available in the internet at "<http://www.ad.siemens.de>" under the heading "Products & Solutions." Click on "Service & Support" under "Services" and look for the article-ID "16532108" on the "Product Support" page. The desired article about chemical resistance will be displayed.

Sources of light

Notice

Position the screen so that it is not subject to direct sunlight or other strong sources of light.

Faulty pixels in the display

At present, the manufacturing process of modern displays does not guarantee that all pixels of the display will be perfect. A small number of faulty pixels in the display, is therefore unavoidable. This does not present a functional problem as long as the faulty pixels are not bunched in one location.

For additional information, refer to the specifications.

TFT-LC display

A permanent picture with bright images can lead to a burn-in effect on the TFT LCD.

If a screen saver is activated, please observe the following:

- The liquid crystals in screen savers which actuate active black when the backlighting is on, e.g. flying stars "starfield simulation," renew themselves. Pay attention to the length of time the backlighting is activated.
- The following applies to screen savers which turn off the the backlighting: Each time the backlighting is turned on, its life is reduced by 50 minutes.

Consider the following carefully:

- Use of a screen saver
- Switch off the backlighting regularly
- Permanent display of the customer application

Description

2.1 Application features

Introduction

The Panel PC IL provides a high standard of quality based on the protection type of the control unit, high-level EMC and CE certification for industrial application.

The device is designed for 24 hour operation. Further information is available in the section "Ambient and Environmental Conditions of the "Specifications" chapter.

The Panel PC IL is scalable beginning with the processor type and the memory modules all the way to the operating system.

Ports

- The integrated Ethernet port ensures communication with the office world and the management layer.
- PC peripherals can be connected via the integrated USB ports at the rear and front of the device.
- Connection to the process is made with communication cards and PC expansion modules in the available PC slots.

2.2 Design

The device serves as a base for PC-based HMI devices, the Panel PCs. In comparison to Panel PC 670 and Panel PC 870, Panel PC IL77 meets the basic requirements for industrial compatibility and provides high performance at low cost.

The device consists of the control unit with a key or touch panel and the computer unit. The control unit is screwed to the back of the computer unit.



Figure 2-1 Panel PC IL 77

- 1 Control unit
- 2 Computer unit

2.3 Technical features

General features	
Processor	- Intel® Pentium 4 2.4 GHz - Intel® Celeron 2.0 GHz
Chipset	Intel 865G
RAM	256 MB = 2 X 128 MB SDRAM 512 MB = 2 X 256 MB SDRAM 4 slots, 4 GB maximum
Slots Expansion	3x PCI 175 mm length top slot can be used for WinAC Slot module
Device variants The device is available with different control units which are distinguished by the size of the display and by a membrane keyboard or touch screen.	<p>Keyboard variants</p> <ul style="list-style-type: none"> • 12"/15" TFT technology • Color display with backlighting • Membrane keyboard with alphanumeric keys, numeric keys, cursor keys and control keys • Function keys and softkeys • Integrated mouse • Softkeys, <Shift> and <ACK> keys. • Front-mounted USB 2.0 port for connecting external peripheral devices <p>Touch screen variants</p> <ul style="list-style-type: none"> • 12"/15"/19" TFT technology • Color display with backlighting • Front-mounted USB 2.0 port for connecting external I/O modules
Graphics	Monitor VGA (865G Chipsatz) 12": 800 x 600, 60 Hz 15": 1024 x 768, 60 Hz 19": 1280 x 1024, 60 Hz
Power supply	120/230 V AC, 350 W; variable voltage with short-term buffering against power failure at maximum 16 ms in accordance with NAMUR:
Drives optional	CD-ROM drive
Hard disks	? 30 GB HDD small, 1x 2.5"
Operating system, optional	Preinstalled, also factory installed on the Restore CD - Windows 2000 Professional MUI* - Windows XP Professional MUI* *MUI: Multi-lingual user interface; German, English, French, Italian, Spanish, Japanese, Korean, Chinese simplified and Chinese traditional

2.3 Technical features

Ports	
Installed via expansion cards: PROFIBUS / MPI	CP 5611 compatible
Ethernet	LAN 10/100/1000 Mbps
USB	4x USB 2.0 high current, external 2x USB 2.0 high current available, internal via male connector
Serial ports	COM1 V.24
Parallel ports	LPT1
Keyboard	PS/2
Mouse	PS/2

Accessories not supplied with the device package	
SIMATIC PC Image Creator SW	Software tool for local data backup
Film for protecting the touch screen panel against dirt and scratches for the 12" touch screen variant for the 15" touch screen variant for the 19" touch screen variant	6AV7671-2BA00-0AA0 6AV7671-4BA00-0AA0
Labeling strips for 12" keyboard variant for 15" keyboard variant	The labeling strips and printing templates can be obtained from the Internet address mentioned in the preface.

Planning deployment

3.1 Overview

Introduction

This section describes the first steps after unpackaging, the permitted mounting positions and the fixation. This section describes the necessary considerations for EMC.

Field of application

The Panel PC is an industry-standard PC platform for demanding tasks in the field of PC-based automation. The Panel PC is designed for on-site use on the machine, installed for example in:

- Switchgear cabinets
- Swivel arms (booms)

Note

In the following, the term "switchgear cabinet" also refers to rack, mounting rack, switchboard, operator panel and console. The term "device" represents the Panel PC and its variants.

The device is released for the following operating systems:

Releases for Panel PC IL 77

- Windows 2000 Professional Multi-Language, German, English, French, Italian, Spanish, Japanese, Korean, Chinese simplified and Chinese traditional
- Windows XP Professional Multi-Language, German, English, French, Italian, Spanish, Japanese, Korean, Chinese simplified and Chinese traditional

3.2 Unpacking and checking the delivery unit

Procedure

1. Upon delivery, check the packaging for damage incurred during transport.
2. If any transport damage is present at the time of delivery, lodge a complaint at the shipping company in charge. Have the shipper confirm the transport damage immediately.
3. Unpack the device.

Caution

Do not lay the device on its back. This may damage optical drives.

4. Keep the packaging material in case you have to transport the unit again.
-

Notice

The packaging protects the device during transport and storage. Therefore, never dispose of the original packaging material!

5. Please keep the enclosed documentation in a safe place. You will need the documentation when you start up the device for the first time.
 6. Check the package contents for completeness and any visible transport damage. Check for completeness using the enclosed "Contents of Delivery" list.
 7. Notify the delivery service in charge immediately if the packages contents are incomplete or damaged.
-



Warning

Make sure that a damaged unit is not installed nor put into operation.

8. Note the identification information as described in the "QuickStart" document.

3.3 Noting the identification information

Procedure

1. Write down the Microsoft Windows Product Key of the Certificate of Authenticity COA in the table at the end of this section. The product key can be found at the back of the device. You will need the product key during the reinstallation of the operating system.
2. Write down the manufacturer's number SVP and the order number , e.g. "6AG71...", in the table. If repairs are necessary, the device can be identified by the service center on the basis of the SVP number and order number.

Both numbers can be found on the rating label attached to the side of the device where the power unit is located.

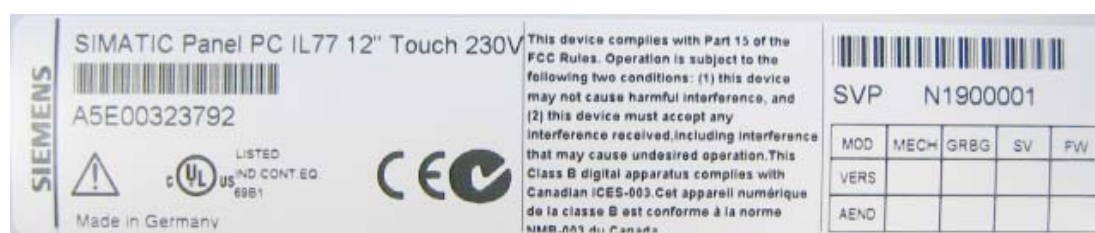

Figure 3-1 Rating label of the device, for example

3. Write down the Ethernet address of the device: The Ethernet address is located in the "Main" menu of the BIOS setup, "Hardware Options > Ethernet Address."

Identification	Number
1	Microsoft Windows Product Key
2	SVP number
3	Order No.
10	Ethernet address

3.4 Guidelines for Handling Electrostatic Sensitive Devices (EMC)

Electromagnetic Compatibility

The device fulfills the requirements of the EMC law of the Federal Republic of Germany as well as the EMC Guidelines of the Single European Market.

The device is designed as a built-in model with front-sided Protection Class IP 65. Ensure compliance with the EN 61000-4-2 standard by installing the device in grounded metal cabinets, e.g. MC cabinets, Siemens catalog NV21.

Note

Please refer to the appendix for for more information concerning the EMC requirements.

Installing the device according to EMC guidelines

Principles of interference-free operation:

- Installing the controls according to EMC guidelines
- Using interference immune cable

Note

The instructions "Guidelines for the assembly of interference immune programmable logic controllers" with the article ID 1064706 and the manual "PROFIBUS networks" with the article ID 1971286, which also applies to the installation of the device, is located on the "Documentation and Drivers" CD.

3.5 Mounting positions and fastening

3.5.1 Mounting notes

Before installing the device, read the following general notes relating to installation.



Warning

Danger, high voltage

Isolate the power supply to the switchgear cabinet before opening it. Make sure that the power to the switchgear cabinet cannot be turned on accidentally.

Caution

The device is approved for operation in closed rooms only.

- Ensure that the protective contact socket of the building installation is easily accessible and that there is a central power disconnecter in switchgear cabinet installations.
- Position the screen in an ergonomic position favorable to the user. Choose a suitable installation height.
- Position the screen so that it is not subject to direct sunlight or other strong sources of light.
- CD/DVD drives are susceptible to shocks. Shocks during operation can lead to the loss of data or damage to the drive or data carrier. Burners and CD/DVD are not suitable for continuous operation.
- Applies to devices which are installed in swivel arm housings: Avoid rapid or jerky movements of the swivel arm during operation. The ensuing forces could lead to possible irreversible damage of the hard disk.
- Provide adequate volume in the switchgear cabinet for air circulation and heat transport. Keep at least 10 cm distance between the device and switchgear cabinet.
- Do not allow the maximum air intake temperature to exceed 45 °C. Decisive is the temperature measured at a distance of 10 cm from an air intake. The maximum air intake temperature must be accounted for especially when sizing closed switchgear cabinets.
- Position the device so that the air vents of the housing are not covered up following installation.
- Ensure there is enough free space in the switchgear cabinet to allow the sheet metal cover to be removed. You will otherwise have to remove the device from the switchgear cabinet or boom when replacing memory or the battery.

- Also provide enough free space to add on to the device.
- Equip the switchgear cabinet with struts for stabilizing the installation cut-out. Install struts where necessary.
- Avoid extreme environmental operating conditions. Protect your device against dust, moisture and heat.
- Install the device in such a way that it poses no danger, e.g. by falling over.
- During assembly, please comply with the approved installation positions.

Notice

The device must be mounted in a fireproof cabinet to fulfill the requirements for UL508 certification.

To fulfill the requirements for EN 60950, the device must be mounted in a permitted position.

For additional information, refer to the dimension diagrams in the appendix.

3.5.2 Approved mounting position

Approval

Only certain mounting positions are approved for the device.

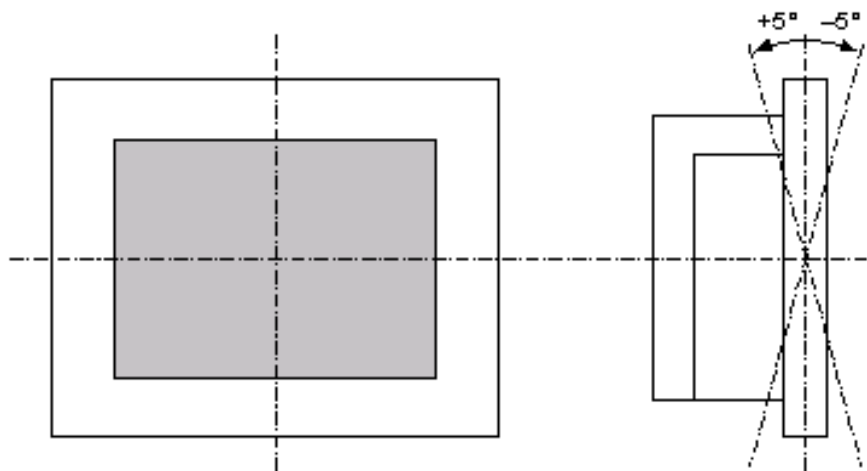

Figure 3-2 Permitted mounting positions

The device can be mounted in a vertical position with deviations between $+5^\circ$ and -5° in the given directions.

3.5.3 Type of fixation

The computer unit is secured in the installation cut-out either with clamps or screws.

Notice

Securing with screws is not possible with the 12" touch screen variant. For more information, please refer to the chapter "Description."

Select the method of attachment suitable to your requirements for the degree of protection.

3.5.4 Degree of protection

Principle

In general: The degree of protection depends on the method of attachment.

Caution

The IP65 degree of protection is only guaranteed with a plate thickness of ≥ 2 mm. Note that the deviation of the installed front panel from the horizontal in relation to the outer dimensions of the device should not exceed 0.5 mm. 120 μm is the maximum permitted surface roughness R_z in the area of the seal.

Do not allow the maximum air intake temperature to exceed 6 mm.

Degree of protection IP65

This degree of protection is provided for a clamp mounting together with an encircling seal.

IP54 degree of protection

This degree of protection is provided for screw mounting.

3.6 Installation cut-out

3.6.1 Selecting and creating the installation cut-out

Requirements

The degree of protection suitable to the field of application and thereby the method of attachment have been selected.

Procedure

1. Please follow the installation guidelines.
2. Select a location suitable for installation, taking into account the installation guidelines and the chosen installation position.
3. On the basis of the dimension diagrams, check whether the required screw and pressure points on the backside and the hatched seal area are easily accessible after the completion of the installation cut-out. Otherwise the installation cut-out is useless.
4. Complete the installation cut-out according to the dimension diagrams.

3.6.2 Dimensions

The following illustrations show the dimensions for the installation cut-out.

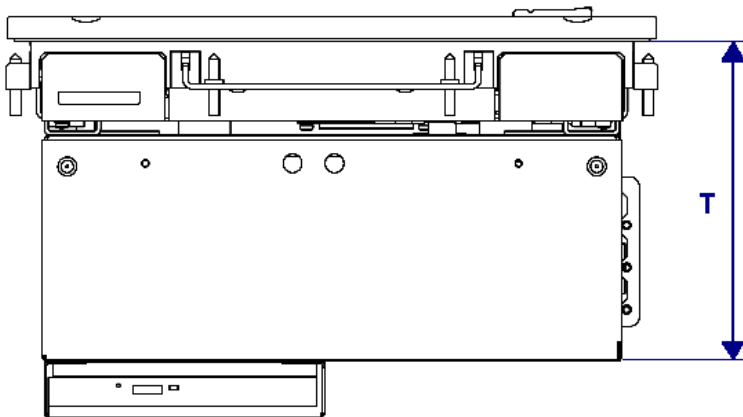
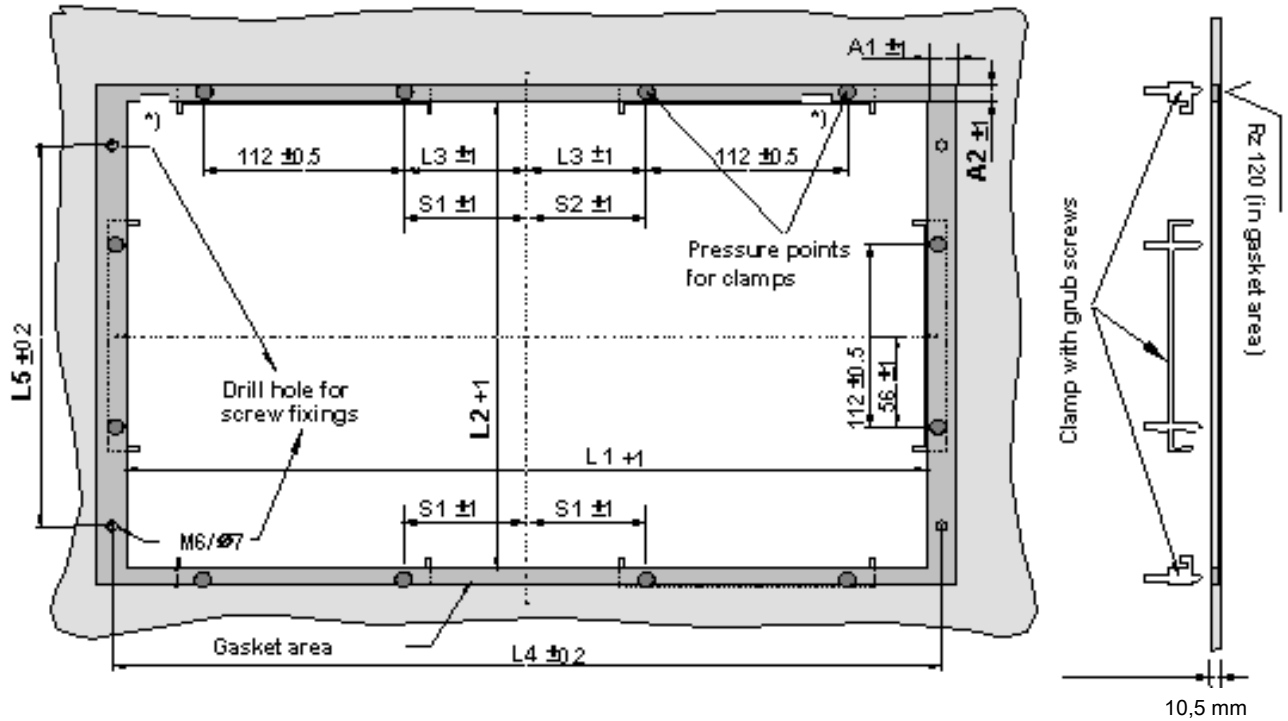

Drill holes for the screws and pressure points for the clamp screws

Control units	L1 ¹⁾	L2 ¹⁾	T ¹⁾	L3	L4 ²⁾	L5 ¹⁾	A1	A2	S1	S2
With key panels										
12" TFT	450	290	137	78	465	235	16	10	—	—
15" TFT	450	321	162	51	465	279	16	17	—	—
With touch screen panels										
12" TFT	368	290	152	—	—	—	16	10	35	19
15" TFT	450	290	155	81	465	235	16	10	—	—
19" TFT in mm	449	380		46	465	235	17	10	—	—

1) Mounting dimensions of the control unit without CD-ROM drive

2) Drill holes with 6 mm diameter each

Installation

4.1 Securing with clamps

Range of validity

Skip this step if you have selected "screw mounting."

Requirements

- The installation cut-out has been made.
- Clamp from the options. Clamp and grub screws are included in the contents of delivery.



Figure 4-1 Clamp assembly

Procedure

1. Please follow the installation guidelines.
2. Working from the front, insert the HMI device into the installation cut-out.
3. Secure the control unit in the installation cut-out from behind with the clamp, as shown for the installation cut-out in the dimension diagrams. Tighten the grub screw to a torque of 0.4-0.5 Nm.

4.2 Securing with screws

Range of validity

Skip this step if you have selected "clamp mounting."

Notice

You cannot use screws to secure the device with the 12" touch screen variant. For more information, please refer to the chapter "Description."

Requirements

The installation cut-out has been made.

Procedure

1. Please follow the mounting guidelines.
2. Drill suitable holes at the prepared installation cut-out in accordance with the specifications for L4 and L5, as shown in the installation cut-out in the dimension diagrams.
3. Carefully drill the respective holes in the control unit at the designated location (1) from the rear.

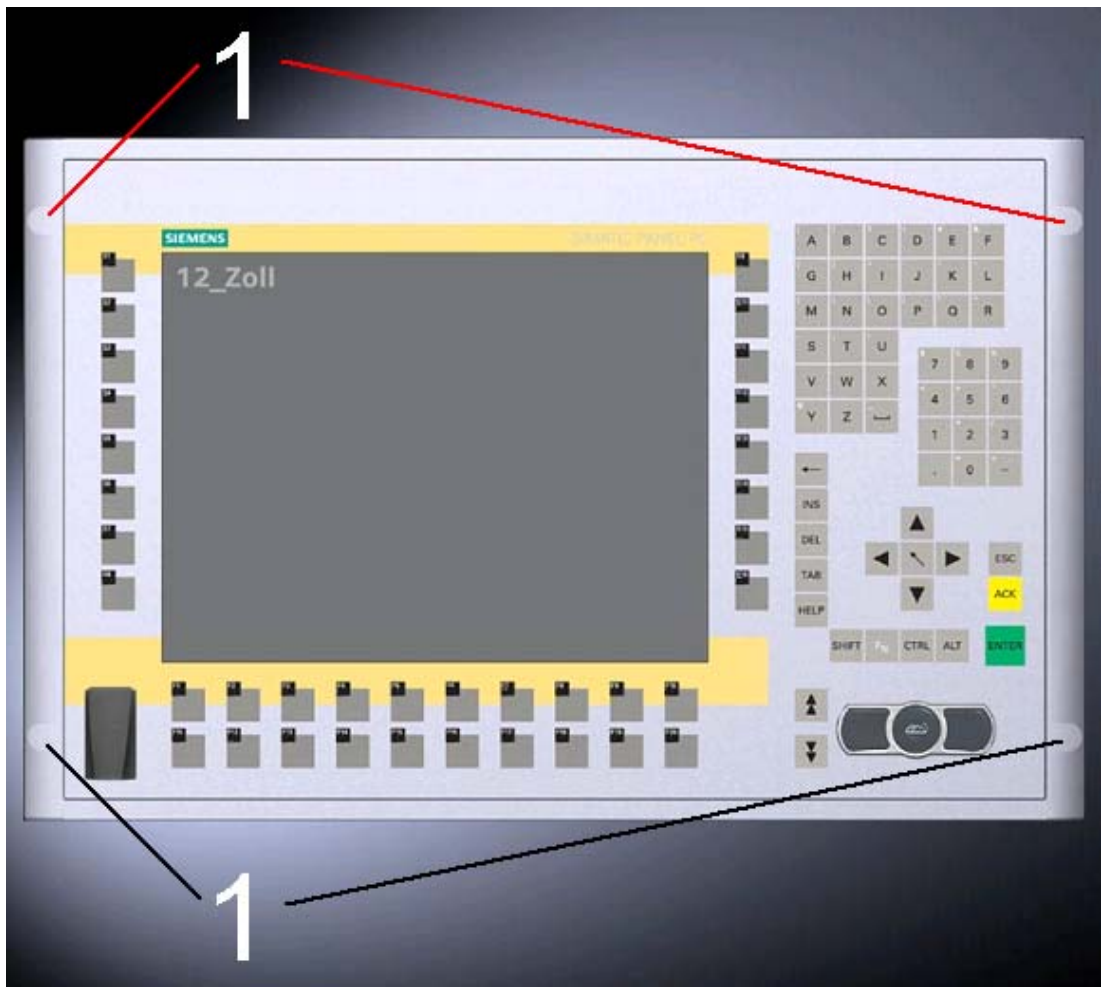

Figure 4-2 Designated location for holes on the control unit

4. Working from the front, insert the HMI device into the installation cut-out.
5. Secure the control unit by inserting suitable screws through the holes and attaching nuts.

4.3 Dimensions

The mounting depth increases by 28 mm when a CD-ROM drive is installed in the device. Refer to the dimension diagrams in the "Specifications" section for the exact measurements.

Connection

5.1 Overview

Introduction

Once you have mounted the device, connect it.



Warning

Do not touch power lines or data transmission lines during electrical storms and do not connect any cables.

Unplug the power cable from the socket to be sure the electricity is disconnected.

Caution

Connection sequence

Follow the described sequence when connecting the device to avoid damaging it.

Commissioning

Allow the device to adjust to the room temperature before connecting the device. Do not place the device near heat radiation. If moisture condensation occurs, wait at least about 12 hours before you switch on the device.

Risk of data loss!

Do not disconnect the power supply when the device is in operation. Disconnect the power only after the device has been correctly shut down.

Requirements

- The device has been installed in conformity with EMC guidelines.
- The device has been installed according to the information provided in these operation instructions.

Procedure

1. Connect the equipotential bonding.
2. Connect peripherals:
 - Connect an external monitor if desired.
 - Connect the PS/2 mouse.
 - Connect a serial mouse if desired.
 - Connect the PS/2 keyboard.
 - Connect a USB device such as a USB mouse if desired.
 - Connect a printer.
3. Connect the power supply.

5.2 Ports

5.2.1 Front ports

Introduction

The USB port is located under the sealed cover on the front next to the control elements and displays. The USB port can be used to connect peripherals such as an external keyboard or an external mouse. The front USB port supports USB standard 2.0.

Caution

Wait at least 10 seconds between the unplugging and replugging of USB devices. This also applies in particular to touch control in control units with touch screen panels.

Notice

When the sealed cover over the USB port is removed in order to connect a USB component, the degree of protection for the device is no longer guaranteed.

When using standard USB peripherals, please bear in mind that their EMC immunity level is frequently designed for office applications only. These device are suitable for commissioning and servicing. However, only industry-standard devices are allowed for industrial operation.

The USB peripherals are developed and marketed by individual vendors. The respective manufacturers offer support for the peripherals. Moreover, the terms of liability of the individual vendors or suppliers apply here.

5.2.2 Rear ports

Interfaces

Arrangement of the Ports			
	Pos	Name	Description
	(1)	KEYBOARD	Connection for a PS/2 keyboard
	(2)	Mouse	Connection for a PS/2 mouse
	(3)	USB 2.0	Connector for USB devices
	(4)	COM 1	Serial port, 9-pin Cannon plug
	(5)	LPT 1	Parallel port, 25-pin Cannon socket
	(6)	VGA	VGA connection
	(7)	USB 2.0	Connector for USB devices
	(8)	ETHERNET	RJ 45 Ethernet connection 10/100/1000 Mbps

Power supply

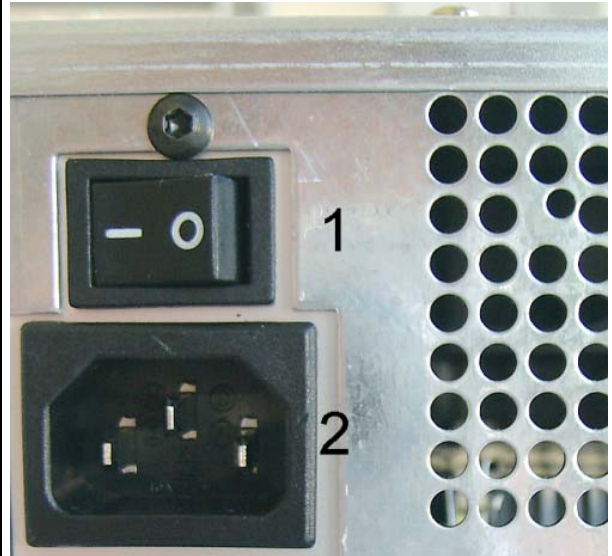
Position of the IEC power connector	Description
	IEC power connector (2) for the AC power supply to the device. The maximum permitted power range is 120 V AC to 230 V AC.

5.3 Equipotential bonding

Differences in potential

Differences in potential arise between separated system parts, which in some cases leads to high equalization currents. When cable shields are applied on both sides and are grounded at different system parts, for example.

Causes of potential differences are different network feed-ins, for example.

Equipotential bonding requirements

Reduce the differences in potential by laying the equipotential bonding cables in such a way that the affected electronic components function perfectly. Please comply with the following guidelines when setting up equipotential bonding:

- The lower the impedance of the equipotential bonding cable, the greater the effectiveness of the equipotential bonding.
- When two system parts are connected by means of a shielded signal cable, and their shields are both connected to the ground or protective conductor, the following must be observed: The impedance of the additional equipotential bonding cable amounts to 10 % of the shield impedance, at the most.
- Make sure that the diameter of the equipotential bonding cable is proportional to the maximum equalization current. Equipotential bonding cables with a 16 mm diameter have proven themselves in practice. 2.
- Use equipotential bonding cables made of copper or galvanized steel. Connect the cables extensively with the ground or protective conductor. Protect the ground or protective conductor from corrosion.
- Lay the equipotential bonding cable in such a way that the area between the equipotential bonding cable and signal cables is as small as possible.

5.4 Connecting equipotential bonding

Introduction

A low-impedance earth connection ensures that interference signals generated by external power supply cables, signal cables or cables to the I/O modules are safely discharged to earth.

Procedure

1. Connect the equipotential bonding cable to the equipotential bonding screw on the underside of the device. The equipotential bonding screw is label with the following symbol:



2. Connect the equipotential bonding connection of the device to a central earthable point of the control cabinet. Ensure that the conductor cross-section is not less than 5 mm².

5.5 Connecting peripherals

5.5.1 Overview

When connecting the device for the first time, connect a PS/2 keyboard and PS/2 mouse. Connect any required USB components such as a USB hub.

Caution

Disconnect the device from mains before connecting peripherals. This does not apply to connecting and disconnecting USB devices.

Connect only I/O modules approved for industrial applications according to EN 61000-6-2:2001. Using shielded cables and metal connectors for peripherals. Otherwise, the specified norms and specifications declared by Siemens AG are no longer valid. Fix the plugs of the interface cables to the PC housing with screws. This improves the electrical shielding.

Mouse

Connect a PS/2 or USB mouse.

5.5.2 Connecting a monitor

The front panel is activated as the display by default when the operating system starts. An external monitor connected to the VGA port is therefore deactivated.

Learn how to activate an external monitor by reading the section "Installing and Removing Hardware Components" in the "Service and Maintenance" chapter.

5.5.3 USB

Introduction

Readily available USB peripherals can be easily and flexibly connected via the USB port. You can connect a USB keyboard and a USB mouse, for example. If a USB keyboard features a USB port (USB hub) itself, you can connect other USB peripherals, such as a mouse, directly to the keyboard.

USB port

There are several types of USB peripherals:

- Low power devices: maximum 100 mA power consumption, e.g. mouse and keyboard
- High power devices: maximum 500 mA power consumption, e.g. hard disk and floppy drive

Note

The general USB specifications apply to the USB ports on the computer unit.

Applies to Windows 2000 and Windows XP: The USB port on the front panel has been approved for a maximum of one additional USB HUB.

Using USB peripherals

Notice

When installing a USB device for the first time, ensure you have the required device driver. Before removing an intelligent USB device, deactivate the device in the operating system using the dialog "Unplug or Eject Hardware". For additional information, refer to the documentation of the operating system.

Connect USB devices

Caution

Wait at least 10 seconds before disconnected and reconnecting USB devices. This also applies to touch-screen front panels, especially touch panels.

Notice

When using standard USB peripherals, please bear in mind that their EMC immunity level is frequently designed for office applications only. These device may be used for commissioning and servicing. However, only industry-standard devices are allowed for industrial operation.

The USB peripherals are developed and marketed by individual vendors. The respective manufacturers offer support for the peripherals. Moreover, the terms of liability of the individual vendors or suppliers apply here. More information about connecting USB devices is available in the "Commissioning" chapter.

Procedure

1. Insert the USB cable into the USB port. The device is automatically detected by the Plug & Play operating system. The operating system may prompt you to install a driver when necessary.

5.6 Connecting the power supply

Principle

The device can be optionally operated on 120 or 230 V. The device features an automatic voltage switch and a power switch.

Caution

Do not touch power lines or data transmission lines during electrical storms and do not connect any cables.

Unplug the power cable from the socket to be sure the electricity is disconnected.

The device features a safety-certified power cable. Connect the device only to a grounded outlet with a ground contact. Operate the device only on grounded power lines and not on impedance earthing lines such as IT networks.

Do not exceed the nominal voltage for the device with the local power voltage.



Warning

Select an adequately large cable diameter so that the device is not damaged by the cable during a short circuit.

Localized information**Outside of the USA and Canada, 230 V AC power supply:**

If you do not use the safety-certified power cable, use a flexible cable with the following characteristics:

- At least 18 AWG conductor cross-section
 - Grounded safety plug 15 A, 250 V
-

Notice

Ensure that the cable set conforms to the respective national safety regulations and is appropriately labeled.

For USA and Canada:

A CSA or UL-listed power supply cable must be used in the United States and Canada USA.

Notice

Ensures that the plug conforms to the NEMA 5-15 regulation.

120V power supply

Use a flexible cable with the following characteristics:

- UL approval
- CSA label
- Type STJ with three conductors
- At least 18 AWG conductor cross-section
- Maximum 4.5 m length
- Parallel grounded safety plug 15 A, min. 125 V

230V power supply

Use a flexible cable with the following characteristics:

- UL approval
- CSA label
- Type STJ with three conductors
- At least 18 AWG conductor cross-section
- Maximum 4.5 m length
- Parallel grounded safety plug 15 A, min. 250 V

Procedure

1. Insert the supplied power cable into the AC/DC power socket of the device.
2. Fasten the power plug with the locking device supplied in the package. This will prevent unintentional detachment of the IEC power connector on the device.

5.7 AC uninterruptible power supply

Introduction

This chapter describes the considerations involved in using an AC uninterruptible power supply (UPS) for Panel PC.

Due to legal regulations related to reducing reactive-power absorption in public and private electrical networks, all AC voltage supplies in PANEL PCs feature a Power Factor Correction (PFC) circuit. Technically, there is passive PFC and active PFC. The Panel PC 670 V1, for example, features passive PFC.

Active PFC

All Panel PC 870, Panel PC 670 as of version V2 and Panel PC IL as of version 77 feature active PFC. Active PFC requires almost perfect sinusoidal input voltage.

Caution

UPS AC power supplies with non-sinusoidal wave form damage the power unit of PANEL PCs with active PFC.

Ensure that the AC UPS can provide a sinusoidal output voltage in normal and buffer mode when using a PANEL PC with active PFC.

Selection criteria for an uninterruptible power supply

Uninterruptible power supplies with sinusoidal output voltage in normal and battery mode are classified as "VFI-SS-..." or "VI-SS-...".

USP characteristics are described and classified in the standards EN 50091-3 and IEC 62040-3.

Note

More information is available in the internet at "<http://www.ad.siemens.de>" under the heading "Products & Solutions." Click on "Service & Support" under "Services" and search for the article ID "17241008" on the "Product Support" page. At the end of the article there is a link to the document, "UPS Classification Based On Operational Performance".

Commissioning

6.1 Overview

Checklist

Before starting up the device for the first time, go through the following checklist:

- Have you taken into account the proper ambient and environmental conditions for the device and the connected I/O modules, as described in the technical information?
- Have you learned how to connect the equipotential bonding?
- Have you learned how to connect the power supply?
- Read over this information in the respective "Connecting" chapter of the operating instructions. Please follow all guidelines.

Caution

Condensation

When transporting the device in low temperatures, ensure that no moisture gets on or in the device. This also applies if the device is subjected to extreme changes in temperature. Wait 12 hours before switching the device on.

Allow the device to slowly adjust to room temperature before commissioning the device. Do not subject the device to direct heat radiation from devices such as heaters.

I/O modules

Connect the I/O modules using shielded cable and metal plugs. Otherwise, the specified norms and specifications declared by Siemens AG are no longer valid. Fix the plugs of the interface cables to the PC housing with screws. This improves the electrical shielding.

Start up

Do not switch off the device during the start up. Otherwise parts of the software which are necessary for trouble-free operation will be lost.

Use the standard settings in the BIOS as described in the "Detailed Descriptions" chapter of the operating instructions under the section "BIOS Setup", "BIOS Setup Default Settings." Otherwise the operating system will not be installed properly.

Prerequisite

- A PS/2 mouse is connected.
- A PS/2 keyboard is connected.

Procedure

1. Switching on the device
2. Install Microsoft Windows operating system.
3. Install drivers and applications.

6.2 Switching on the device

Procedure

1. Plug the power plug of the supplied power supply cable in the AC/DC power supply connector of the device.
2. Screw-mount the power plug lock (1).



Figure 6-1 Interlock the power plug

3. Interlock the power plug as shown
4. Plug the power supply cable into a socket with a grounded protective conductor.
5. Switch on the power switch of the device.

The device starts up and boots.

Self test

After connection to the power supply, the device performs a self test. During the self test, the message "Press <F2> to enter SETUP" appears briefly.

When the self test is finished, the operating system will be loaded.

6.3 Setting up the Microsoft Windows operating system

Introduction

The setup wizard appears immediately following the startup of the device. The wizard is used to set the parameters of the operating system.

Note

The dialogs of the setup wizards differ slightly in some places for the Windows 2000 and Windows XP operating systems.

In order to change to the next dialog, click on the ">>" button. In order to change the entry in the previous dialog, click on the "<<" button.

Procedure

1. Accept the Microsoft licensing agreement.
2. Perform the regional settings of the operating system.
3. Enter the company names and user names.
4. If his PC name is already in use as you attempt to connect the device to a network: Enter a new PC name for identification.

The operating system will restart automatically.

The system settings will be updated and the desktop will be set up. The setup of the operating system is complete.

6.4 Installing drivers and applications

Introduction

After the device is restarted, different dialogs appear on the screen. Drivers and applications can be installed from these dialogs.

Additional hardware and software components

You can install and configure additional hardware and software components such as a network. For additional information, refer to the documentation of the hardware and software.

Note

The directory "c:\i386" contains special Windows components for subsequent installation.

Energy-saving mode

The "Suspend Timeout" option is disabled by default in the "Power" menu of the BIOS Setup.

Caution

Do not activate the "Suspend Timeout" option! The safe operation of the automatic plant or system is otherwise no longer guaranteed.

The "Suspend Timeout" BIOS option is not an authorized function.

Procedure

1. In the "Panel Wizard" dialog, click on the type of panel that corresponds to your device.



Figure 6-2 Panel Wizard, selection of the panel type

2. In the "Panel Wizard Touch" dialog, click on the screen size that corresponds to your device. The screen resolution will be set for your device.



Figure 6-3 Panel Wizard Touch, selection of the screen size

The next step only applies to control units with touch screen panels.

Once the screen size is selected, the wizard will search for new hardware, the touch controller. The Panel Wizard closes and the Touch-Base-9-point touch calibration appears. Carry out the following steps carefully.

3. Briefly touch the touch screen at every cross hair.

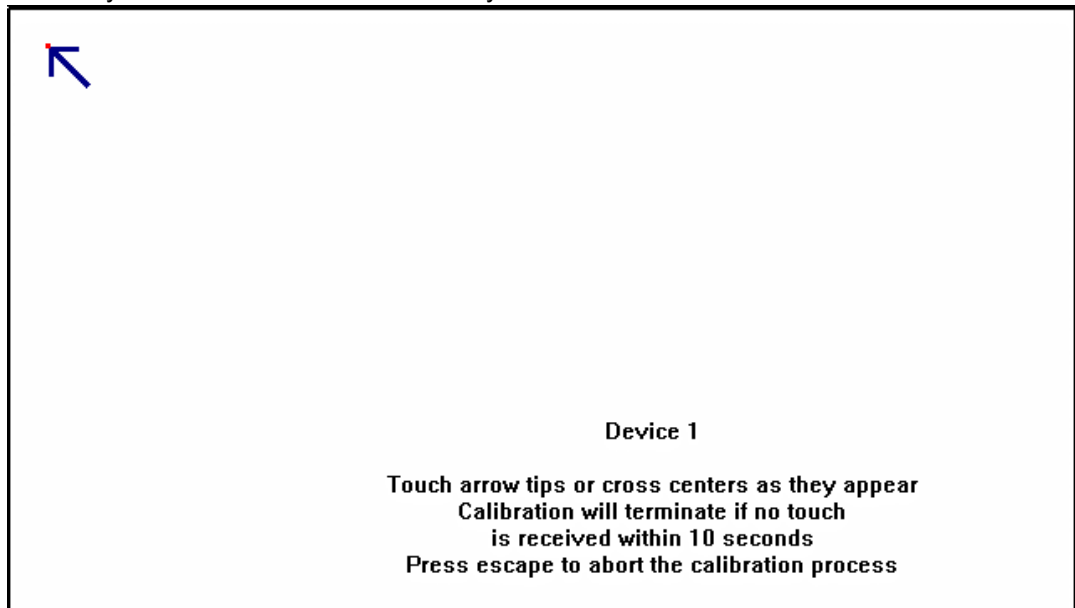

Figure 6-4 Touch screen calibration

4. The following only applies to control units with key panels: Exit the operating system session and restart the device. Otherwise the "Security features" from "KeyTools" or "KeyHook" will not be activated.



Warning

Use "KeyTools" as described in the "Additional Drivers and Applications" section of the "Operation and Configuration" chapter in the operating instructions.

The following applies when the "Security features" of "KeyTools" is deactivated:

When the additional function keys F13 and S16 are used, or when using your own key code table, serious malfunctions of the user software can occur because the key codes behind the function keys can also be activated by activating keys other than the configured ones.

-
5. No administrator password is assigned in the factory state. When the logon dialog appears the next time the device starts up, therefore, leave the field empty and close the dialog with the "OK" button.

Notice

Then configure an administrator password for security.

The installation of the drivers and applications is complete. Further information is available in the "Operation and Configuration" chapter of the operating instructions under the section, "Additional Drivers and Applications."

Notice

After starting up your device, find out more about the particulars of the operating system in the chapter "Start-up" in the device's operating instructions under the section, "Microsoft Windows Operating Systems". Further information is available in the chapter "Service and Maintenance" under the section, "Installing Software."

6.5 Windows 2000

Service pack

After a new installation of Windows 2000, install at least Service Pack 4. Service Pack 4 is supplied in the product package.

Note

If you are using SIMATIC WinCC or SIMATIC WinCC flexible, pay heed to the operating system releases. For additional information, refer to the SIMATIC WinCC and SIMATIC WinCC flexible documentation.

Automatic updates

The "Automatic Updates" function is installed with Service Pack 3 or later for Windows 2000.

Start

Start menu command "Settings > Control panel > Automatic Updates"

You can deactivate this function in the dialog "Automatic Updates" "Keep my computer up to date. With this setting enabled,

Updates will then no longer be performed automatically on the device via the Internet.

Notice

When the check box is activated, updates will be installed automatically on the device via the Internet even when they have not been released by Siemens AG.

Operation and configuration

7.1 Normal operation

7.1.1 Switching the device on and off

Switching on the device

Requirements

- The I/O modules, e.g. mouse and keyboard, have been connected.

Caution

Using shielded cables and metal connectors for peripherals. Otherwise, the specified norms and specifications declared by Siemens AG are no longer valid. Secure the plugs of the interface cables to the PC housing with screws. This improves the electrical shielding.

Follow the guidelines in the "Ports" section of the chapter "Connecting."

- The operating system and the service packs have been installed and set up on the hard disk of the device. For additional information, please refer to the chapter "Starting up" in the computer unit operating instructions.
- The pre-installed drivers and applications have been set up appropriately. For more information, please refer to the chapter "Additional drivers and applications."
- The proper ambient and environmental conditions according to the specifications for the device and the connected I/O modules have been observed.

Procedure



Warning

Danger of incorrect operations!

The following applies to external input devices or combinations of external input devices and control units with key panels: Ambiguous key codes can cause serious malfunctions of the application program.

Always activate the "Security features" of "KeyTools." Please follow the relevant safety guidelines in the chapter "Additional drivers and applications."

Caution

If moisture condensation occurs, wait at least about 12 hours before you switch on the device.

1. Connect the device to the power mains.
2. Plug the power supply cable of the device into a socket with a grounded protective conductor.
3. Switch on the power switch of the device.

The device is now in operation and booting.

Caution

Danger of data loss!

Do not switch off the power supply when the device is in operation. Disconnect the power only after the device has been correctly shut down.

After switching on the power supply, the device performs a self test. During the self test, the message "Press <F2> to enter SETUP" appears briefly.

When the self test is finished, the operating system will be loaded and the desktop will be displayed.

The booting process has been completed successfully.

Switch off the device

Shut down the operating system correctly before switching off the device.

Caution

Wait for the display to go dark.

Then switch off the power switch of the device.



Warning

Always pull out the power cable to isolate the device from the mains.

7.1.2 BIOS settings

A USB keyboard is not fully available before Windows starts up. There are not restrictions to using a USB keyboard when editing the BIOS. To be able to select a boot menu before Windows starts, however, connect a PS/2 keyboard.

7.2 Additional drivers and applications

7.2.1 Overview

The necessary drivers and applications are contained in the supplied "Documentation & Drivers" CD.

Caution

Do not turn off the device during the installation of drivers and applications. Otherwise parts of the software which are necessary for trouble-free operation will be lost.

Note

The supplied drivers and applications have been tested for the system and released for this device. No warranty can be provided for other software.

Press the "Help" button to obtain information concerning the buttons of a dialog.

7.2.2 Configuring the touch screen

Start

- Start menu "Start", command "Programs > UPDD > Settings"

Function

The modification of touch pre-settings simplifies operation under Windows.

If the touch screen does not react as expected when touched, repeat the calibration. To do this, first activate the 9 point calibration and then calibrate the touch screen.

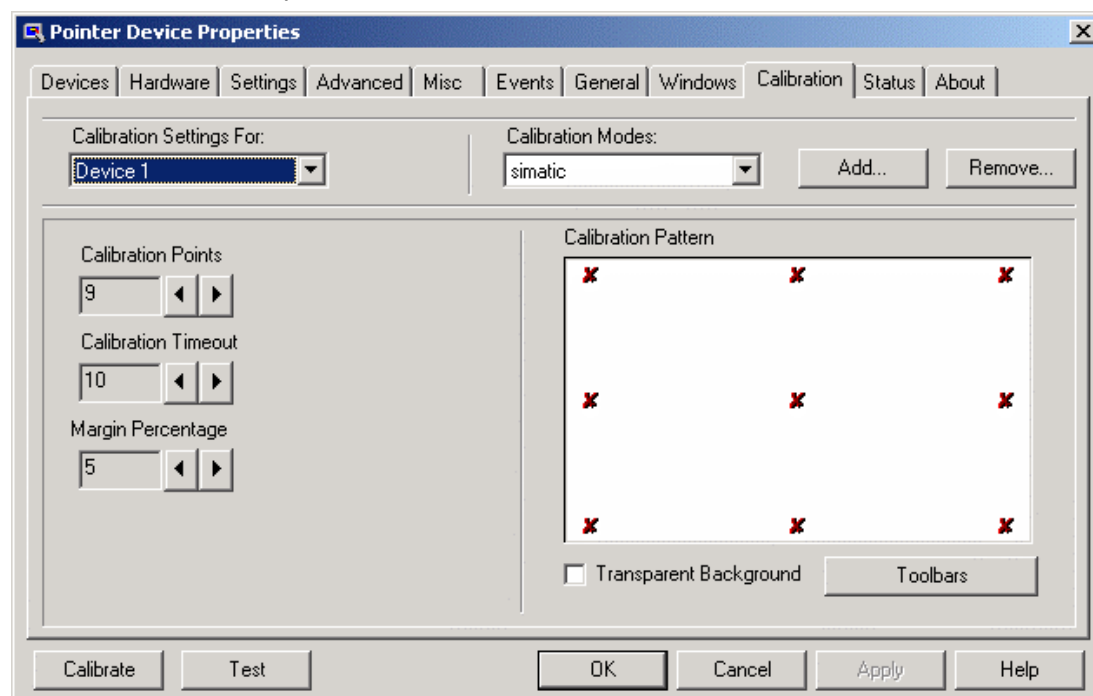

Figure 7-1 Touch defaults, tab "Calibration"

Note

For further information press the "Help" button.

Special features



Warning

Inadvertent operation

If you touch the touch screen while configuring it or if the screen saver is active, the SIMATIC process visualization software, e.g. ProTool/Pro, will carry out the functions which happen to be behind it.

Caution

Only touch one point on the touch screen and not several points at one time. You may otherwise trigger unintended reactions.

Do not touch the screen in the following situations:

- When the device is booting until the boot process is completed
 - When plugging or unplugging USB components
 - While Scandisk is running
-

7.2.3 KeyTools

Range of validity

The following applies to Windows 98, Windows NT, Windows 2000 and Windows XP.

Start

Start menu "Start", command "Settings > Control panel > SIMATIC Key Tools"

Function

SIMATIC Key Tools is a selection of applications for the Panel PC for adapting the key codes sent from the key panel of the control unit. A description of the "KeyTools" is located in the "Help" menu, and more information is located in the menu "Info > About."

"KeyTools" consists of the following tools:

- "Keycode table", previously "KeyPad": Loading and editing of key code tables
- "WinCC hotkey function", previously "KeyHook": WinCC hotkey function activation und deactivation.
- "Security features": prevents two function keys from being activated simultaneously. This prevents incorrect operations and undefined states of the application program.



Warning

For security purposes, always implement "Security features" and never deactivate "Security features." If the user deactivates "Security features" nonetheless, make sure that no malfunctions are triggered in the application program.

Serious malfunctions of the application program cannot be ruled out in external input devices or combinations of external input devices and control devices with key panels. The "Security features" are ineffective in such cases.

7.2.4 SystemGuard

Start

"SystemGuard" icon in the message field. SystemGuard is activated automatically after the device is started.

Function

SystemGuard displays temperatures, fan speeds and currents that are measured by the Silent Fan controller. You can set parameters to optimize the noise level of the device.

Notice

SystemGuard is a freeware tool for which Siemens AG offers no technical support. Please read the notes in the SystemGuard documentation. The documentation is available in the Internet at "<http://www.fujitsu-siemens.de>". Enter "SystemGuard" as a search key.

Example

In the "Temperatures" tab you can see the current temperature of the CPU for the first and a second processor and the internal temperature of the device. The motherboard's on-board sensor supplies this information. An optional AUX sensor is also available.

This shows the current temperature. The current temperature and range are displayed graphically.

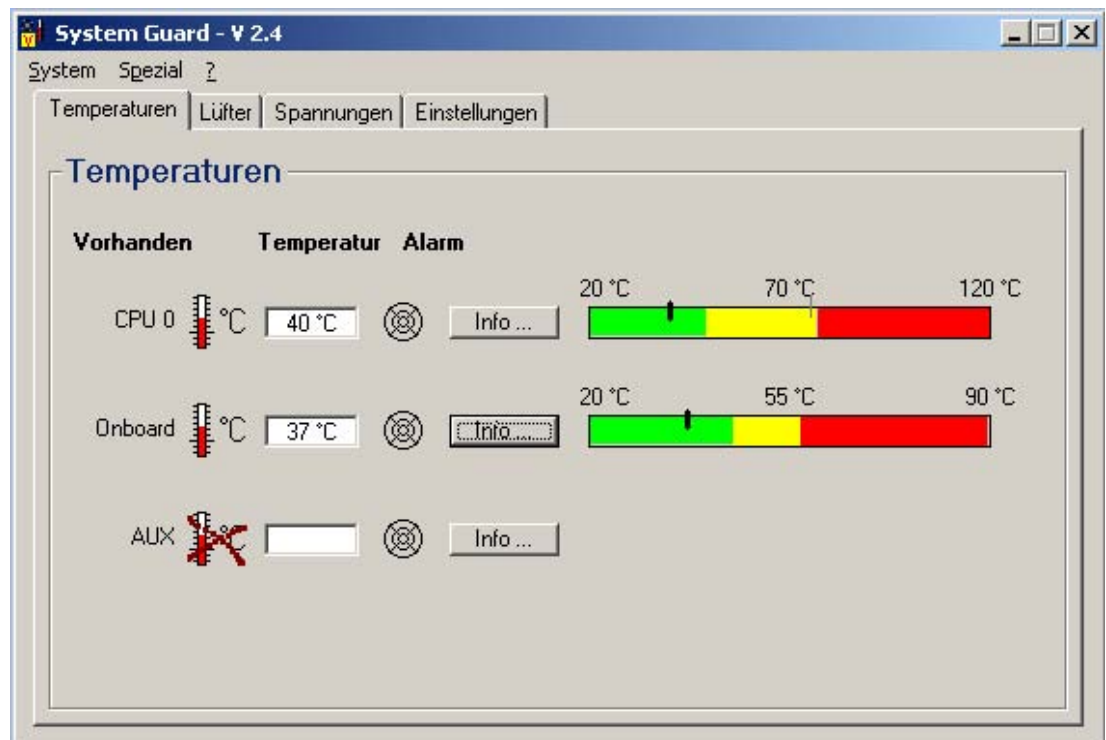

Figure 7-2 SystemGuard

7.2.5 TouchInput

Start

"TouchInput" symbol on the desktop.

Function

TouchInput provides a screen keyboard. On the screen keyboard, the characters are entered directly on the touch screen or with the mouse.



Figure 7-3 TouchInput

7.2.6 CheckLanguageID

Area of validity

The following applies to Windows 2000 Multi-Language and Windows XP Multi-Language.

Start

c:\drivers\checklang\checklangid.exe

Function

"CheckLanguageID" displays the currently installed languages.

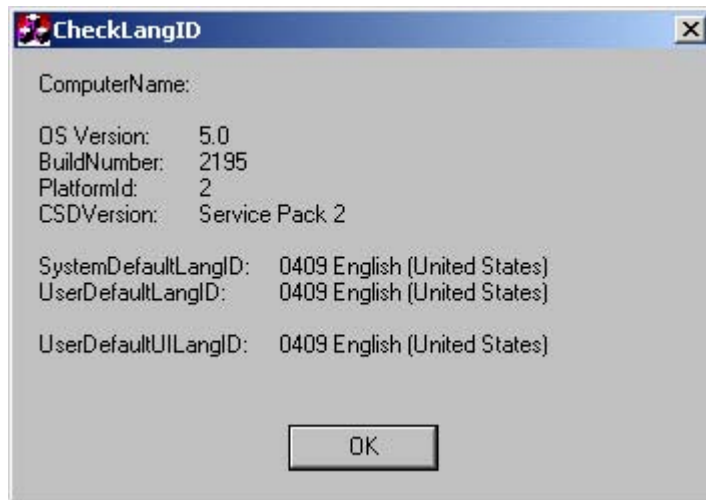

Figure 7-4 CheckLanguageID

- SystemDefaultLangID: System language
- UserDefaultLangID: User language
- UserDefaultUILangID: User interface language

Notice

All three languages displayed should be assigned to the same ID.

7.2.7 Multilingual setting for the operating system

Windows 2000 MultiLanguage enables users to set the language of the GUI to their individual preference. Some elements are not localized, however, and remain in the original language of the system - English.

You should therefore always install English language service packs. Further information about the language of the GUI, regional settings and inputs is available in the Internet at "<http://support.microsoft.com>".

Operation

8.1 Operator controls

On / Off switch

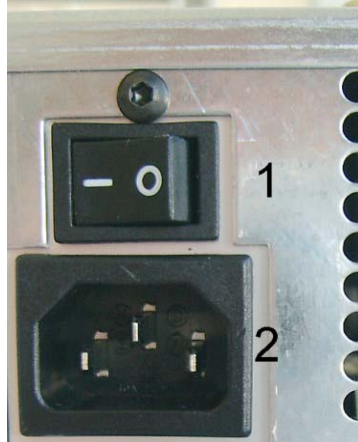
On / Off switch	Description
	<p>The device is on when the power switch (1) is in position "0". Voltage is supplied to the device even when it is switched off.</p>



Warning

The On / Off switch cannot be used to isolate the device from mains!

"Soft Power" key

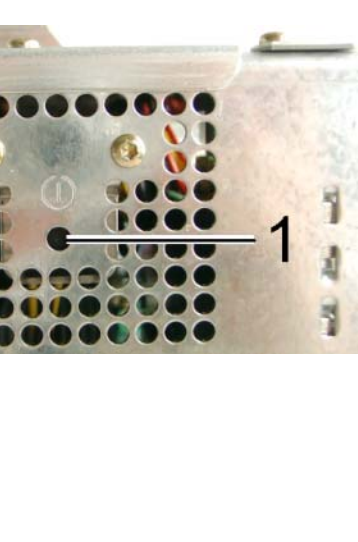
"Soft Power" key	Description
	<p>The key has two functions:</p> <ul style="list-style-type: none"> When the "Soft Power" (1) key is briefly pressed when the device switched on with a sharp object for example, any operating system loaded is properly closed and the device is shut down. <p>Caution: Wait at least 7 seconds before pressing the key a second time. The key will cause the device to reboot if pressed again.</p> When the "Soft Power" (1) key is pressed and held for 4 seconds when the device switched on, the device is immediately shut down without properly closing any operating system loaded. You can use this function to shut down the device when it no longer responds. This does not trigger a hardware reset. <p>Caution: Data may be lost. Wait at least 7 seconds before pressing the key again. The device will reboot if the key is pressed again.</p>

8.2 Operator controls on key panels

8.2.1 Overview

The device has the following keypads:

- 2 x 8 vertical keypads with softkey functions
- 2 x 10 horizontal keypads with function keys F1 -F20

The number of keys, their labeling and function is the same on all key panels. The various panel types differ only in the arrangement of the keys and in the size and type of the display. The following figure is therefore only an example using the front view of the 12" variant.

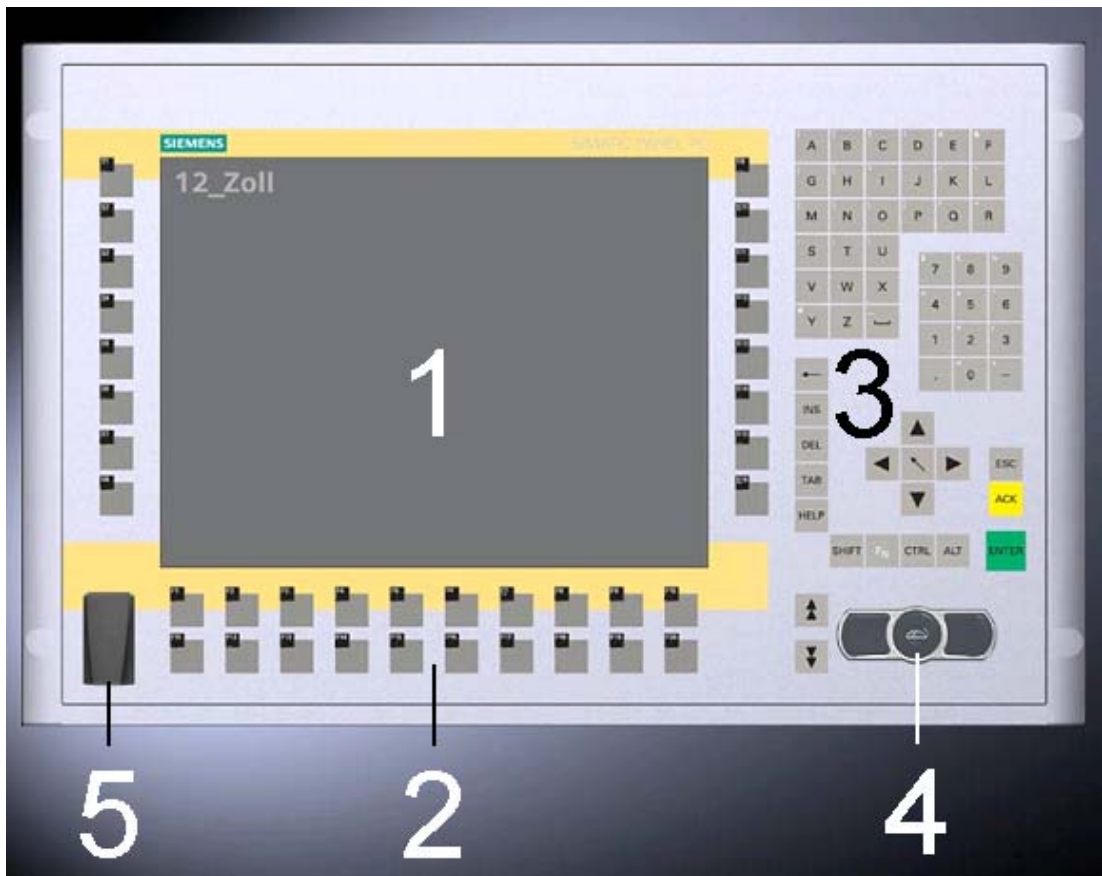

Figure 8-1 Example of a 12" control unit with key panel

- 1 Display
- 2 Function keys, softkeys
- 3 Alphanumeric, numeric, cursor keys and control keys
- 4 Integrated mouse
- 5 USB port

8.2.2 Keyboard

Principle

The layout of the membrane keyboard is "English/USA international."



Warning

Inadvertent operation

If you activate several keys simultaneously, a malfunction on the device cannot be excluded. Activate function keys and softkeys only in sequence! Use "KeyTools" as described in the chapter "Additional Drivers and Applications."

Applies after the deactivation of the "security features" of "Key Tools" or after the deinstallation of "KeyHook":

When the additional function keys F13 and S16 are used, or when using your own key code table, serious malfunctions of the user software can occur because the key codes behind the function keys can also be activated by pressing keys other than the configured ones.

Activating a key using a hard object, e.g. a screwdriver, reduces the life of the key.

Overview

The keyboard is divided into different functional groups:

- Function keys and softkeys
- Control keys
- Alphanumeric keys
- Numeric keys
- Cursor keys

Function keys and softkeys

The softkeys are arranged on the left and on the right, and the function keys in a double row below the display.

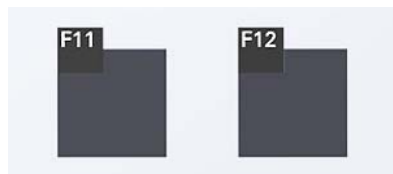

Figure 8-2 Function keys and softkeys

Control keys

The control keys activate editing functions and control functions in different applications:

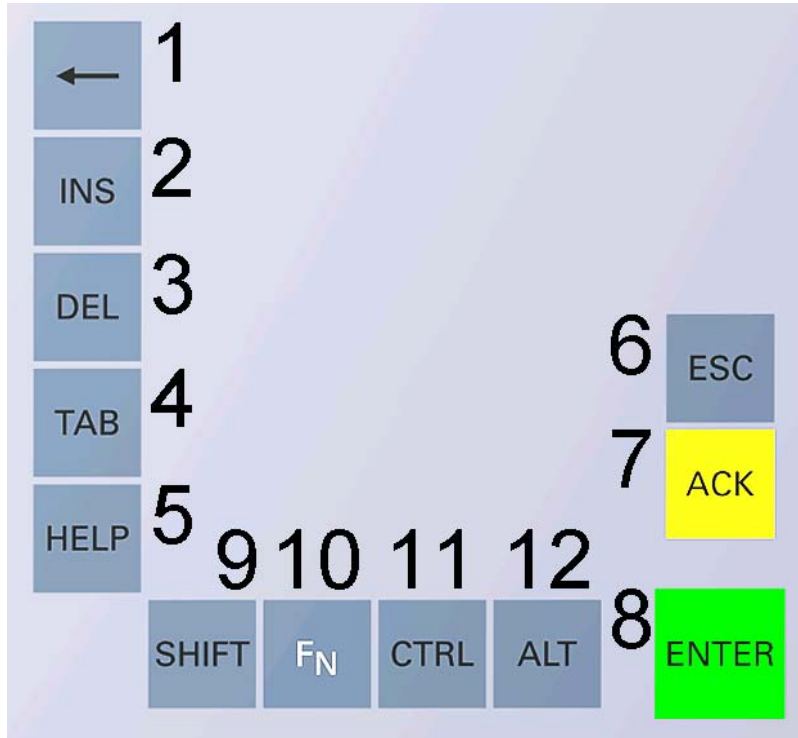

Figure 8-3 Control keys

- 1 Backspace
- 2 Insert
- 3 Delete
- 4 Tabulator
- 5 Help
- 6 Cancel
- 7 Acknowledge
- 8 Enter
- 9 Toggling between small case letters and large case letters
- 10 Toggling between the pre-defined key assignment and special characters, arithmetic symbols and signs
- 11 <CTRL> key: application specific functions and special key codes, compare keyboard table in the appendix
- 12 <ALT> key: application specific functions and special key codes, compare keyboard table in the appendix

Alphanumeric keys

Enter letters, special characters, blank spaces and underline using the alphanumeric keys.

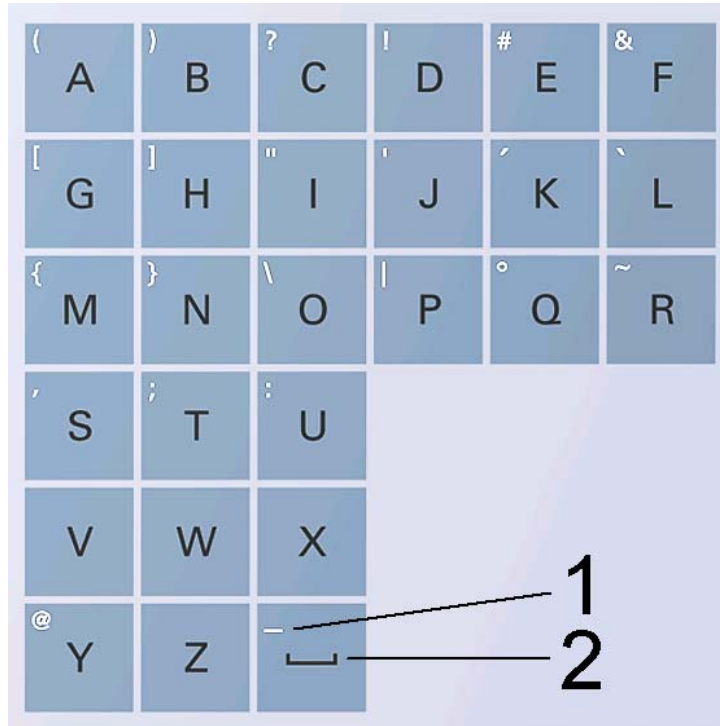

Figure 8-4 Alphanumeric keys

- 1 Underline
- 2 Blank space

toggling between lowercase and uppercase letters

Enter the lower case letters using the pre-defined assignment of the alphanumeric keys. To enter an upper case letter, proceed as follows:

1. Hold down the <Shift> key.
2. Activate the desired alphanumeric key at the same time. The displayed upper case letter will be entered.
3. To enter lower case letters, release the <Shift> key.

Numeric keys

Enter the numerals "0" to "9" and special characters, e.g. the decimal point, using the pre-defined assignment of the numeric keys.



Figure 8-5 Numeric keys

Enter special characters, arithmetic signs and signs

Special characters, arithmetic signs and signs are also assigned to most of the alphanumeric and numeric keys. These signs are indicated by white symbols on the top left of the keys. To enter such a sign, proceed as follows:

1. Hold down the <FN> key.
2. Activate the desired alphanumeric or numeric key at the same time. The displayed special character, arithmetic sign or signs will be entered.
3. To enter the signs of the pre-defined assignment again, release the <FN> key.

Cursor keys

Navigate, scroll or move the writing mark using the cursor keys. The cursor keys correspond to the usual keys of the PC keyboard.

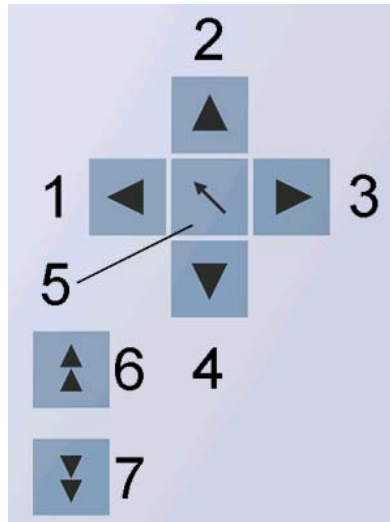

Figure 8-6 Cursor keys

- 1 <Left> key
- 2 <Up> key
- 3 <Right> key
- 4 <Down> key
- 5 <Pos 1> key
- 6 <Page up> key
- 7 <Page down> key

External keyboards

The keyboard layout has been set to "English/USA international." If you use a keyboard with a layout other than the "English/USA international" layout, the key codes of the internal and external keyboards might no longer correspond.

8.2.3 Labelling function keys and softkeys

Area of validity

This section applies only to control units with key panels.

Introduction

The control unit has two horizontal and two vertical keypads. Assign user specific functions to the keys as needed. Label the keys with labelling strips from the options.

DIN A4 film is available for the production and insertion of the labelling strips, as described under Service and Maintenance in the options.



Warning

Labeling

Label the function keys and softkeys to conform with the project. Labeling without reference to a project leads to incorrect operations on the system to be observed.

Procedure

1. Label the DIN A4 film with a laser printer with the printing templates from the options, for example.
2. Cut the labeling strips along the pre-printed lines.

Note

Do not insert handwritten labeling strips until the ink has dried.

3. Insert the labeling strips into the slots provided on the rear side of the control unit.

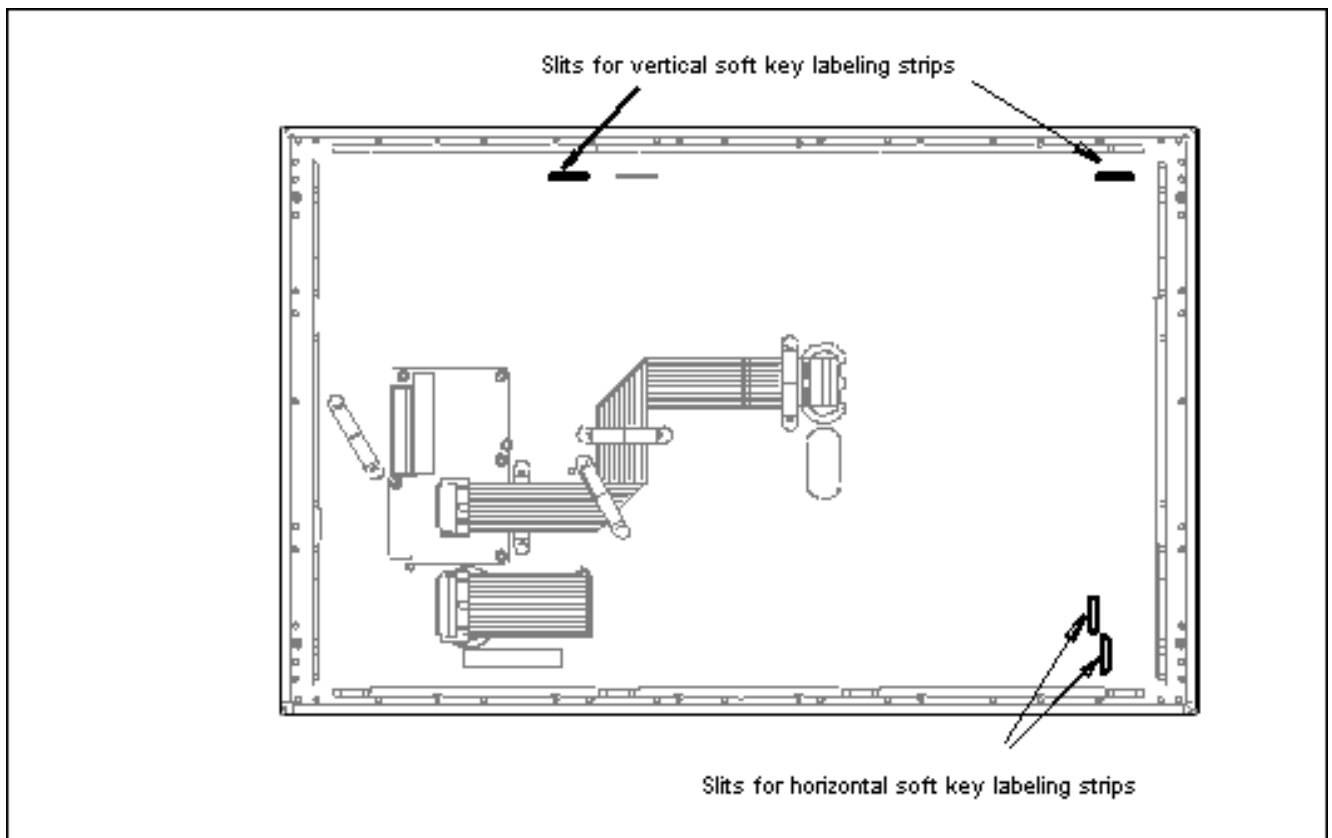

Figure 8-7 Rear side of the control unit with connectors and slots for the labeling strips

8.2.4 Integrated mouse

The position on which you press the middle round button determines the direction in which the cursor moves. The amount of pressure determines the speed of the cursor.

You can also connect an external mouse to the front USB port.

8.3 Operator controls for touch screen panels

8.3.1 Overview

The 12" variant and the 15" variant differ in their dimensions and the size of the display. The 12" variant has no drill hole covers on the sides.

The following figure is therefore only an example using the front view of the 15" variant.



Figure 8-8 Example of a 15" touch screen panel

- 1 Display
- 2 USB port

8.3.2 Touch screen

The display is sensitive to touch and application-specific surface elements, e.g. a button, appear on the screen. By tapping the button with your finger, the function assigned to the button is activated.

Caution

Only touch one point on the touch screen and not several points at one time. You may otherwise trigger unintended reactions.

Do not touch the screen in the following situations:

- When the device is booting until the boot process is completed
- When plugging or unplugging USB components
- While Scandisk is running

The following types of pressure are permissible:

- Using a plastic pen with a 1 mm radius at the point: 25 g.
- Using a silicone finger with a diameter of 1.6 cm: 50 g.

8.4 CD-ROM drive

Introduction

You can use the CD-ROM drive to install software during commissioning or when servicing a device.

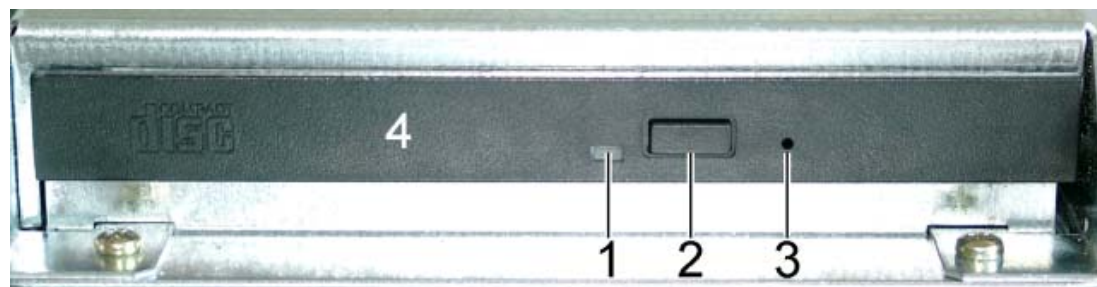

Figure 8-9 CD-ROM drive

- | | |
|---|----------------------------|
| 1 | Access LED |
| 2 | Eject key |
| 3 | Emergency removal aperture |
| 4 | Tray |

Emergency removal

An emergency removal involves removing a CD when the tray is blocked or there is no power for the drive. In this case the tray can be moved manually instead of motor-driven

Procedure

1. Ensure that the power to the drive is really interrupted. Switch off the device.
2. Insert a long thin prong such as a bent paper clip, maximum 1.3 mm thick, into the emergency removal aperture.
3. Carefully open the tray with as little pressure as necessary and then pull it out of the drive.
4. Pull the tray out until the CD is easily accessible.
5. Remove the CD.

8.5 Transferring authorizations

Note

The device has floppy disk drive. Therefore, transfer the authorizations for SIMATIC HMI software from a USB floppy disk drive.

Caution

The USB floppy disk drive is only suitable when mounted in a switchgear cabinet.

The following devices have been tested:

- SINUMERIK FLOPPY DISK DRIVE, order number 6FC5235-0AA05-1AA2

Integration in TIA

9.1 Industrial communications

Introduction

The following options are available for integrating the device in existing or planned system environments and networks.

Ethernet

The integrated Ethernet interface can be used for communication, and data exchange to automation devices such as SIMATIC S7.

You require suitable software for this: STEP7, WinCC, ProTool, WinCC flexible, WinAC, SIMATIC NET.

PROFIBUS / MPI

You can use a floating PROFIBUS interface to connect distributed Field devices or to interconnect to SIMATIC S7.

You require suitable software for this: STEP7, WinCC, ProTool, WinCC flexible, WinAC, SIMATIC NET.

Further information

For further information, refer to the catalog and to the online ordering system from Siemens A&D.

Internet address: <https://mall.ad.siemens.com>

9.2 PROFIBUS/MPI interface and WinAC card

Note

You can use a CP 5613 communication module for the PROFIBUS/MPI interface. A PROFIBUS/MPI interface is also provided on WinAC cards.

You can find further information in the documentation for the CP 5613 communication module and in the "Servicing and Maintenance" chapter under the section "Installing and Removing Hardware Components", "PCI/WinAC Cards".

Maintenance and servicing

10.1 Maintenance

Scope of maintenance

The device is designed to require little service. You should nevertheless clean the membrane keyboard on key panels.

Cleaning agents

Use dish soap or foaming screen cleaner only as cleaning agents.

Caution

Do not clean the device with aggressive solvents or scrubbing agents or with pressurized air or steam cleaner.

Procedure

1. Switch off the device. This prevents the accidental triggering of functions when the keys are touched.
2. Dampen the cleaning cloth.
3. Spray the cleaning agent on the cloth and not directly on the device.
4. Clean the device with the cleaning cloth.

10.2 Installing and removing hardware components

10.2.1 Repairs

Carrying out repairs

Only authorized personnel are permitted to repair the device.



Warning

Unauthorized opening and improper repairs on the device may result in substantial damage to equipment or endanger the user.

- Before you open the device, first switch it off and then disconnect the power plug.
- Install only system expansion devices designed for this computer. If you install other expansion devices, you may damage the system or violate the safety requirements and regulations on RF suppression. Contact your technical support team or where you purchased your PC to find out which system expansion devices may safely be installed.

If you install or exchange system expansions and damage your device, the warranty becomes void.

Notice

Note the EGB instructions.

Limitation of Liability

All technical specifications and licenses apply only to expansions approved by SIEMENS.

No liability can be accepted for impairment of functions caused by the use of devices and components of other manufacturers.

Tools

You can preform all installation tasks on the device using Torx T6, Torx T10 and Torx T20 screwdrivers and a Philips screwdriver.

10.2.2 Opening the device



Warning

Do not touch power lines or data transmission lines during electrical storms and do not connect any cables.



Caution



Warranty period

Within the warranty period, you are only allowed to install expansions for memory and PCB modules.

Requirements

- If the fastening screws are not accessible due to the mounting:
The device is removed from the control cabinet.
- Disconnect the device from mains.
- Unplug the cables and plugs including the keyboard cable from the device.

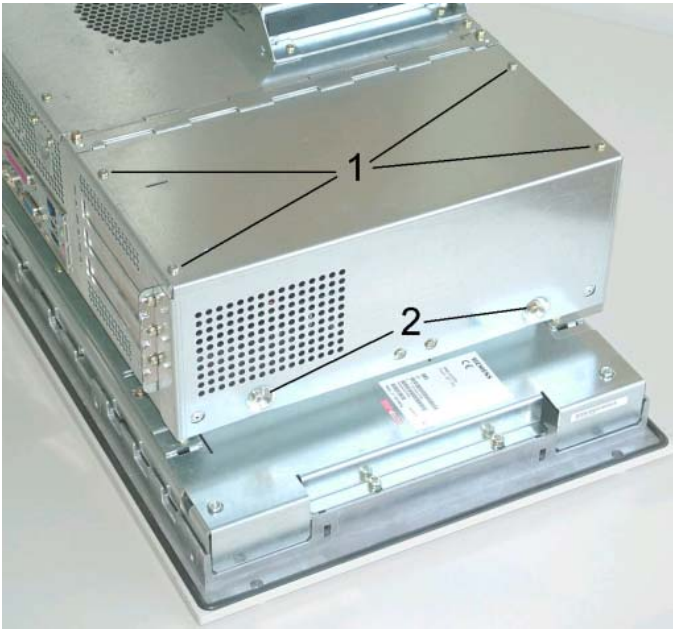
Opening the device

Accessing expansion modules	
1 Remove the four screws (1). Remove the 2 screws (2).	 A photograph showing the rear of a silver metal device. The top lid is closed. Four screws are indicated by lines and the number '1', and two screws are indicated by lines and the number '2'.
2 Lift the lid up and remove it.	 A photograph showing the same device with the lid lifted upwards. The lid is hinged and is open, revealing the internal components and expansion slots.

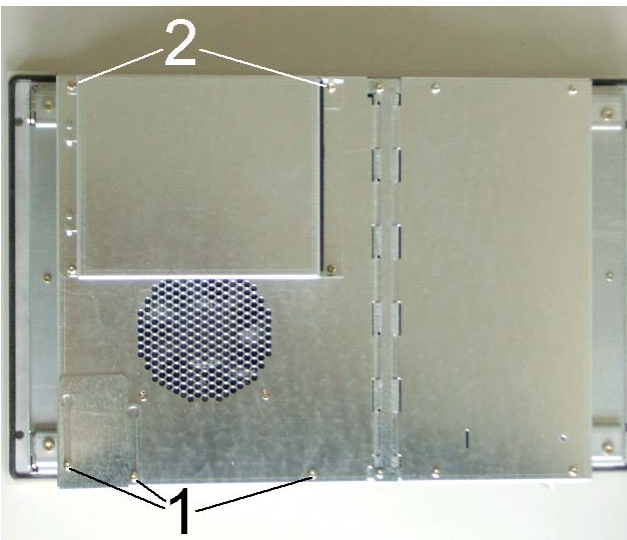
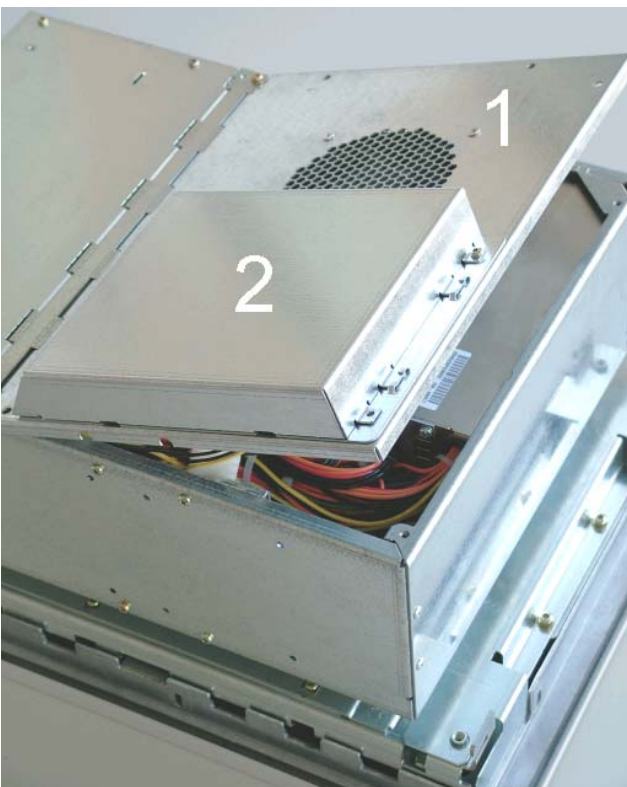
Access to memory modules, processor, heat sinks, backup battery and power supply	
<p>1 Remove the three screws (1). Remove two screws (2) from the CD-ROM drive.</p>	 <p>The image shows the rear panel of a PC chassis. Three screws are labeled '1' and are located at the bottom corners and center. Two screws are labeled '2' and are located at the top corners of the CD-ROM drive bay.</p>
<p>2 Tilt the cover (1) CD-ROM drive (2) upward.</p>	 <p>The image shows the CD-ROM drive cover tilted upward. The cover is labeled '1' and the drive bay is labeled '2'. The drive bay is open, revealing the internal components and cables.</p>

Close the device.

Observe the following when closing the device:

- No cable should be between the fan and the heat sink.
- No cable should lay on the heat sink.

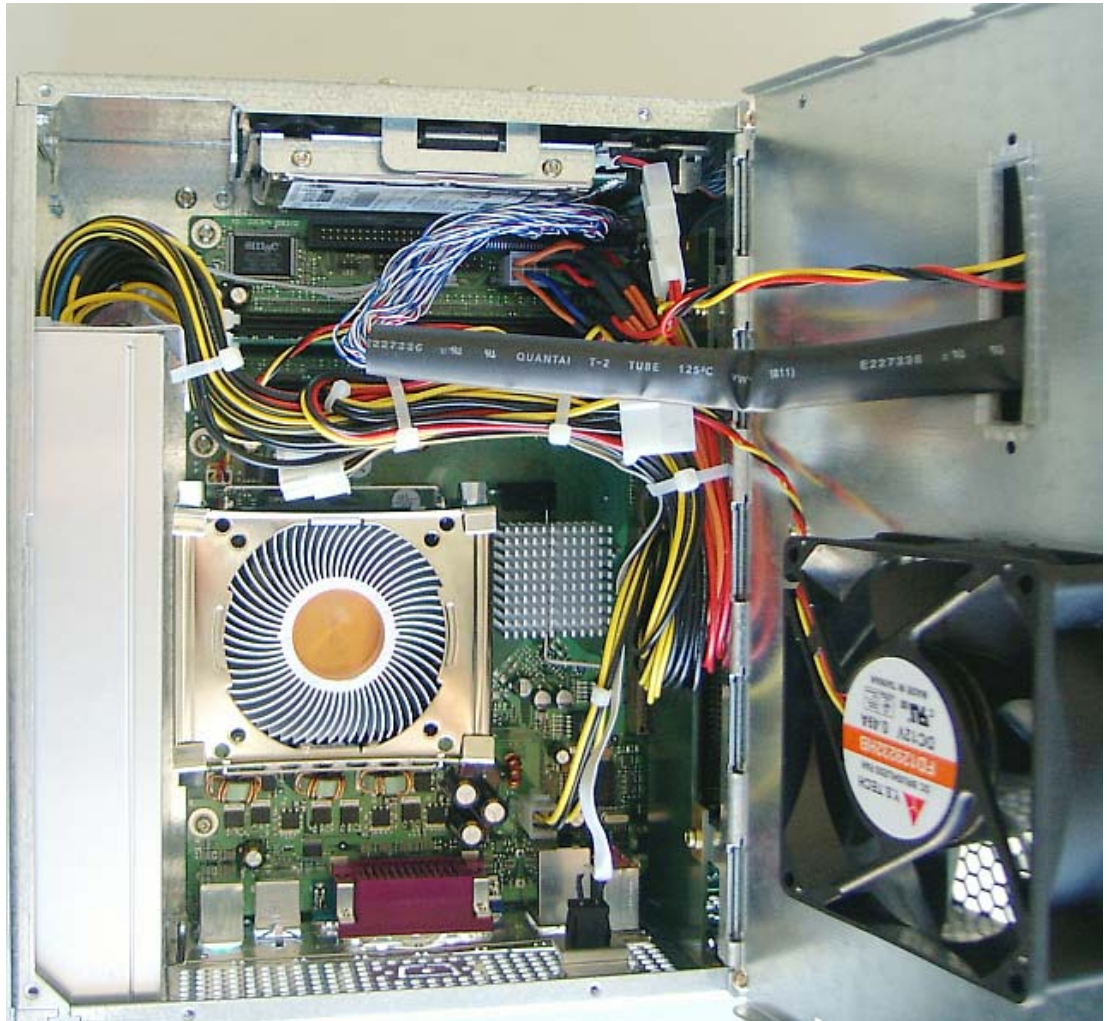

Figure 10-1 Closing the device, cable arrangement

10.2.3 View of internal components when device is open

The following components can be seen when the device is open:

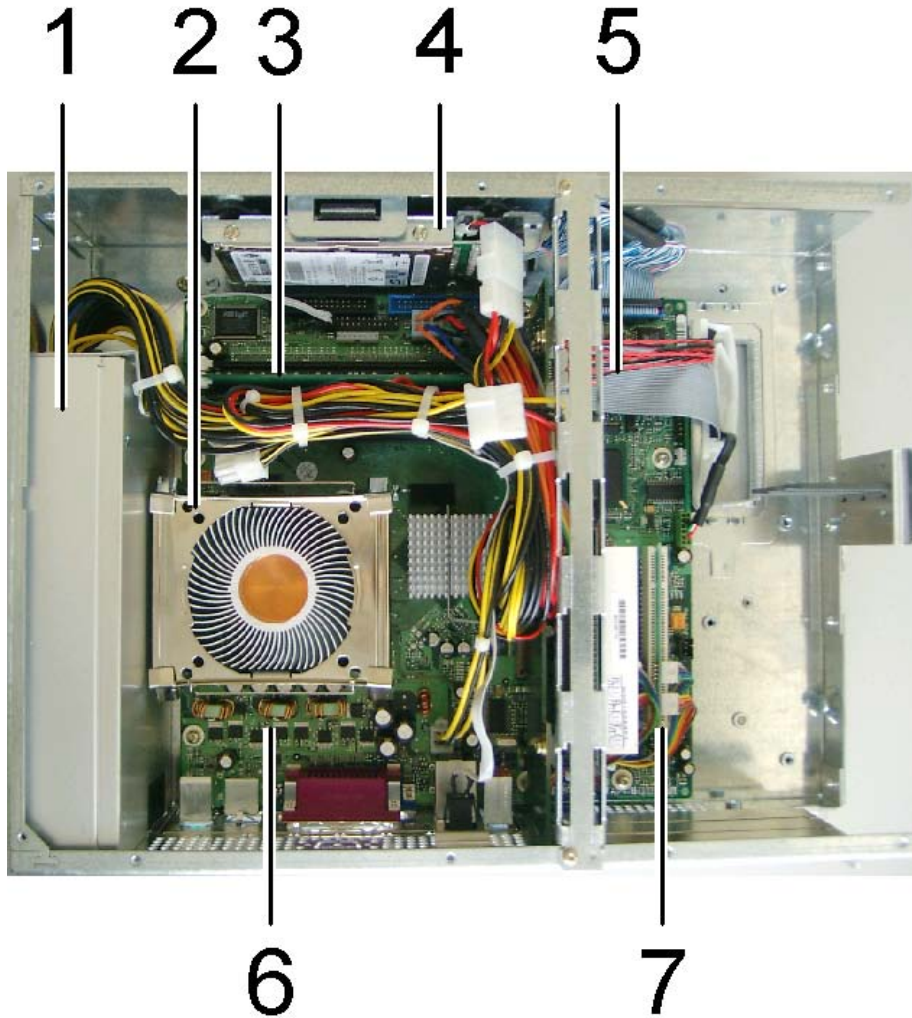

Figure 10-2 Components

- 1 Power supply
- 2 Processor with fan
- 3 Slot for a memory modules
- 4 Hard disk drive
- 5 Back up battery under the ribbon cable
- 6 Motherboard
- 7 Expansion slots

10.2.4 Installing / removing memory modules

Memory expansion



The motherboard is equipped with four slots for Memory modules available. You can therefore expand the memory capacity of the device to a maximum of 4 GB.

Depending on the variant you have ordered, the basic configuration may include 2 X 128 MB SDRAM or 2 X 256 MB SDRAM.

Caution

Read the information in the manual of the motherboard on the "Documentation and Drivers" CD.

Installing a memory module

Steps for installing a memory module		
1	Open the device	
2	Insert the memory module in the socket. Pay attention to the notch of the locking element.	
3	Lightly and carefully, press the memory module (2) into the slot until the interlocks (1) engage.	
4	Close the device.	

Caution

Ensure that the memory modules are securely inserted into the socket. They may otherwise fall out or be damaged. Incorrectly inserted modules result in device malfunctions.

Removing a memory module

Steps for removing a memory module	
1	Open the device
2	Snap the interlocks (1) to the side.
3	Pull the memory module out of the slot
4	Close the device.

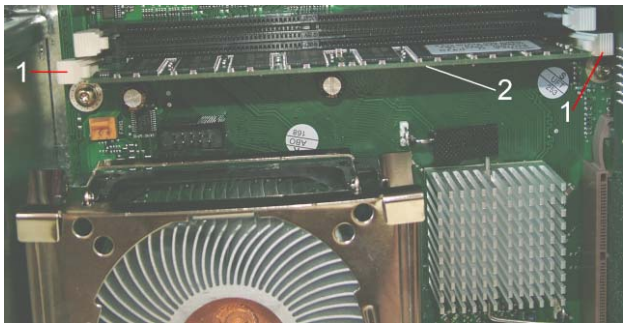

Display of the current memory configuration

Changes to the memory expansion are automatically detected. The memory allocation is displayed when the device boots.

10.2.5 PCI / WinAC cards

10.2.5.1 Notes on the modules

Notes on modules

Specifications

The device is designed for use with modules conforming to AT/PCI specifications. PCI modules with 5 V and 3.3 V supply voltage can be operated. The permitted dimensions of the modules are found in the dimensional drawings section.

Note about long PCI modules

Before long PCI cards can be inserted into the guide rails, they must be fitted with an extender (this should form part of the scope of supply of long PCI boards).

Power requirements

A maximum consumption of 15 W per slot is permitted for PCI cards.

Notice

Ensure that the total consumption does not exceed 25 W on the 3.3 V line and 25 W on the 5 V line.

10.2.5.2 Installing expansion modules



PCI card

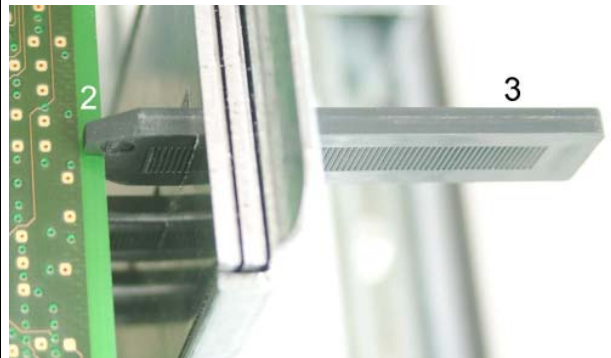
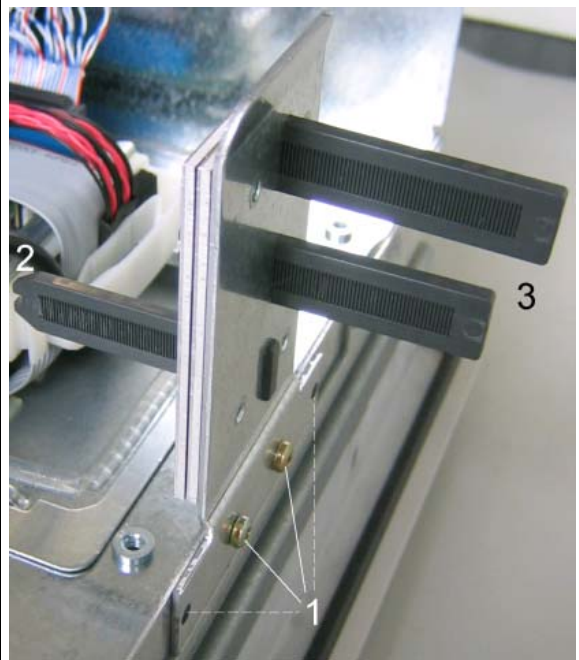

Steps for installing a PCI card:	
1	Open the device
2	Remove the relevant steel slot cover (1)
3	Insert the expansion module (2) into the relevant slot.
4	Secure the frame with the (2,3) card retainers. <ul style="list-style-type: none"> • Make sure that the frame is connected to the device from the outside. • To adapt to different cards, the frame can be offset horizontally and secured by 2 of the 4 threaded holes (1). • Screw on the frame from the outside using the suitable threaded holes (1).
5	Carefully insert the card retainer from the outside (3) until the notch (2) securely grips the card.
6	Saw off the projecting end (3). Otherwise you cannot close the device.
7	Close the device.

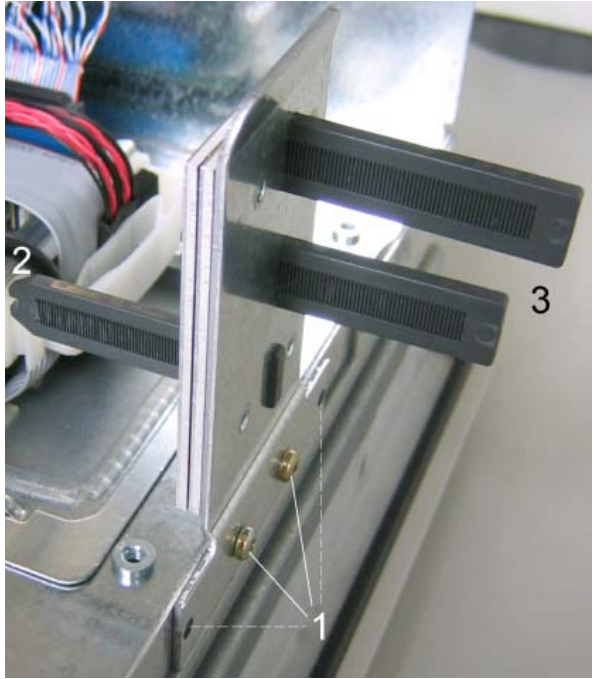

WinAC card

Further information is available in the section "WinAC Card" of the "Integration in TIA" chapter.

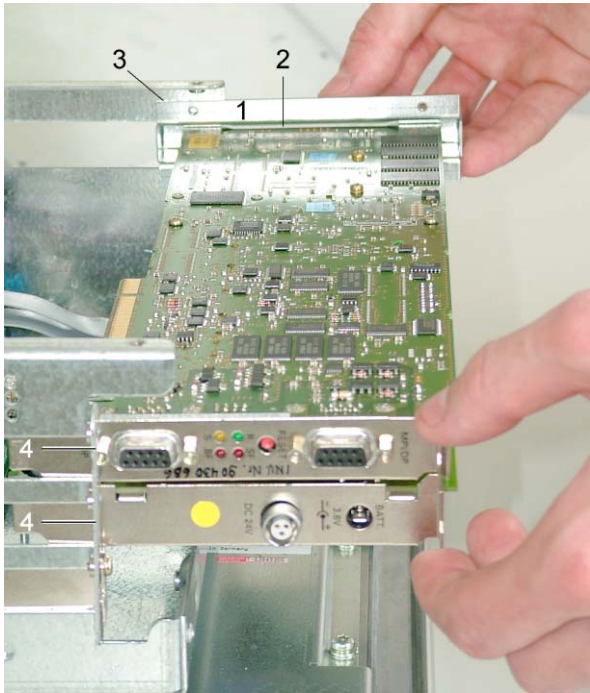
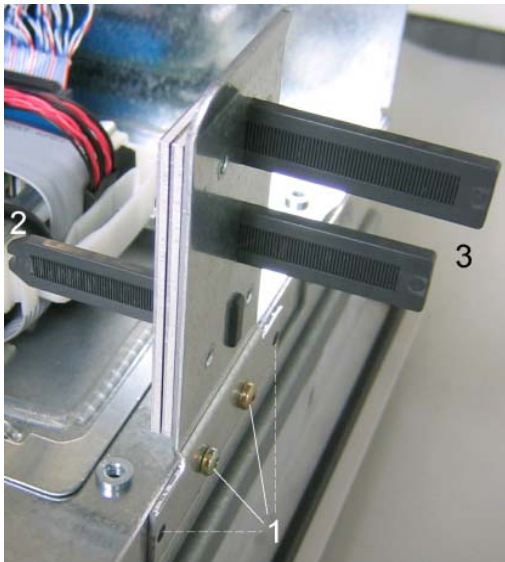
Steps for installing a WinAC card:		
1	Open the device.	
2	Remove the frame with the card retainer (2, 3): remove the 2 retaining screws (1) of the threads from the outside.	
3	Unscrew the steel slot cover of the upper two slots (1).	
4	Unscrew the WinAC cover plate from the outside.	

5	Place the WinAC cover plate (1) over the WinAC card from the right. Ensure that the WinAC card is inserted in the guide rail (2).	
6	Insert the WinAC card into the upper slot. <ul style="list-style-type: none"> • Ensure that the threaded holes (3) are toward the inside. • Insert the WinAC card squarely. Ensure that the WinAC card is aligned correctly. • Insert the ports through the cut-outs (4) in the support metal. 	
7	Screw on the WinAC cover plate (1) from the outside using the threaded holes (3).	
8	Secure the frame with the (2, 3) card retainers <ul style="list-style-type: none"> • Make sure that the frame is connected to the device from the outside. • To adapt to different cards, the frame can be offset horizontally and secured by 2 of the 4 threaded holes (1). • Screw on the frame from the outside using the suitable threaded holes (1). 	
9	Carefully insert the card retainer from the outside (3) until the notch (2) securely grips the card.	
10	Saw off the projecting end (3). Otherwise you cannot close the device.	
11	Close the device.	

Notes on the allocation of resources

The upper two slots provide non-shared interrupts for WinAC cards.

If the new expansion module requires exclusive resources, disable functions on the motherboard as required. You can disable functions in BIOS Setup in the "Peripheral Configuration" submenu of the "Advanced" menu.

For information on allocated resources, refer to the "System Resources" section in the "Detailed Descriptions" chapter. For additional information, refer to the documentation of the BIOS.

10.2.6 Drives

10.2.6.1 Installing and removing a CD-ROM drive

Procedure

1. Loosen the 4 screws (1).

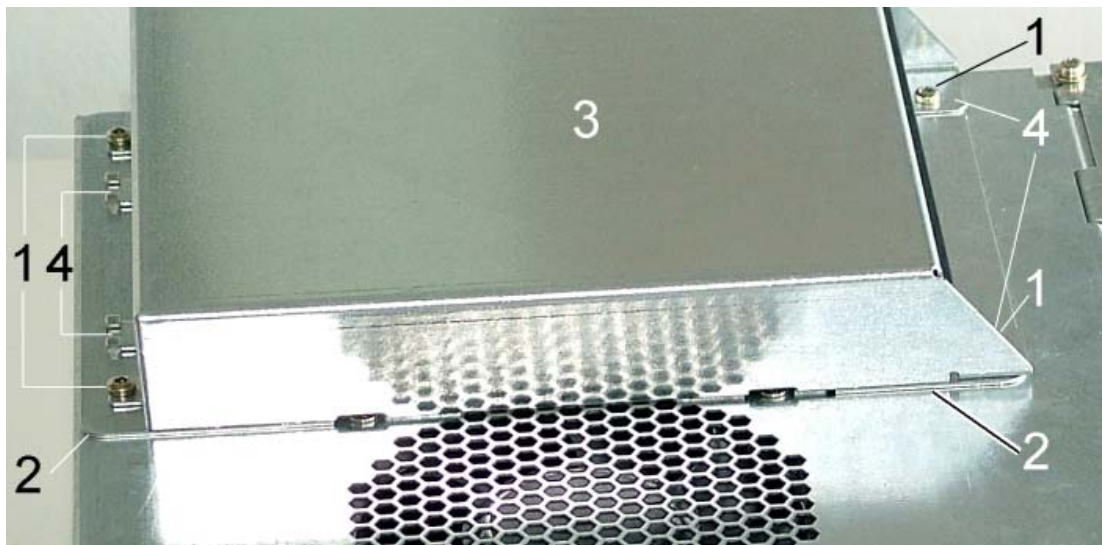

Figure 10-3 Drive with housing

2. To remove the housing of the drive, hold down the base sheet metal (2) of the drive securely and slide the housing (3) to the right until the eyes (4) are free.
3. Lift the housing (3) from the drive.

4. Detach the IDE plug (1) and the power supply plug (2).



Figure 10-4 Drive without housing

5. Loosen the 4 screws (3) that secure the drive to the base sheet metal.
6. Lift the drive out.
7. To remove the connector board, loosen the 2 screws (4).

The drive is now fully removed.



Figure 10-5 Removed drive

Reverse the procedure to install the drive.

10.2.6.2 Exchanging a hard disk

Procedure

1. Open the device.
2. Detach the plug (1) from the motherboard.

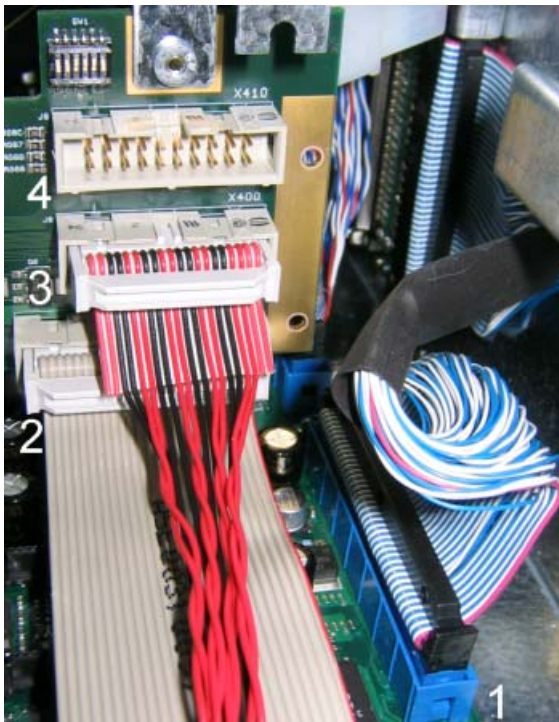

Figure 10-6 Ribbon cable and IDE cable on the motherboard

3. Remove the 4 screws (1) while securely holding the retaining frame (2).

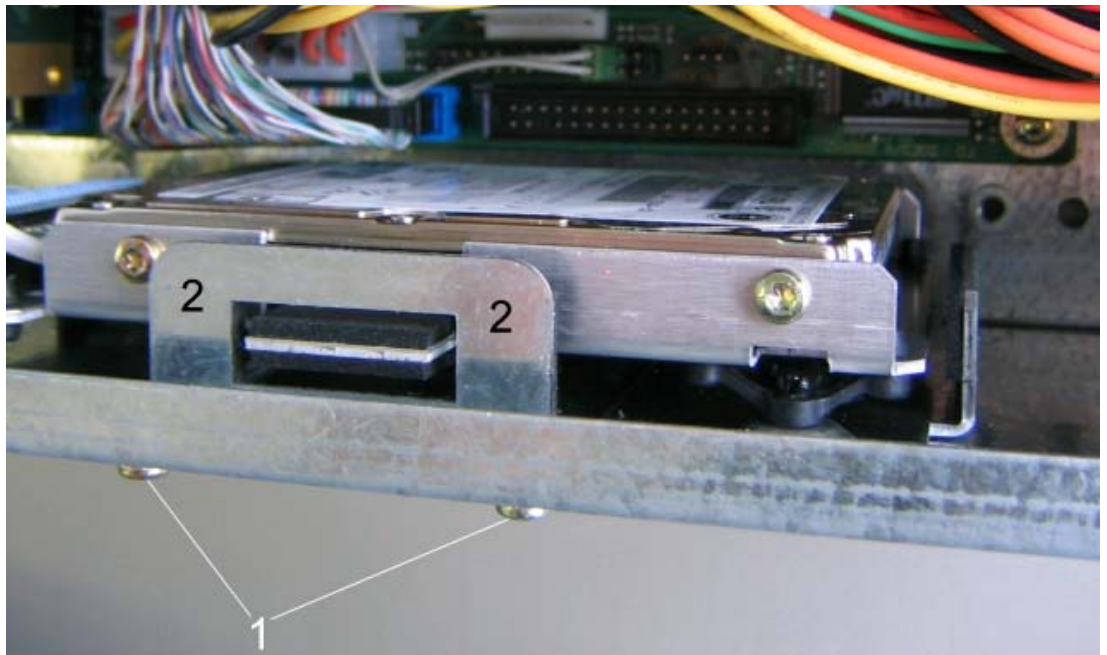

Figure 10-7 Removing the hard disk

4. Remove the drive from the retaining frame.
5. Loosen the 4 screws (1) that secure the hard disk (2) to the retaining frame.



Figure 10-8 Removed hard disk

6. Remove the drive (2) from the bracket.

7. Detach the plug (1) from the drive.



Figure 10-9 Hard disk connector

Reverse the procedure to install the drive.

Caution

Pin connections

The plug (1) is connected to the drive via the circuit board (2). Ensure that the pins of the circuit board are correctly aligned to the left when inserted into the drive (3). The last two pins on the right (4) are open. The drive may otherwise malfunction.

10.2.7 Changing processors and heat sinks

Introduction

To exchange the processor, first remove the heat sink.

Procedure

1. Open the device.
2. Open the clips (1) of the heat sink retainer (2).

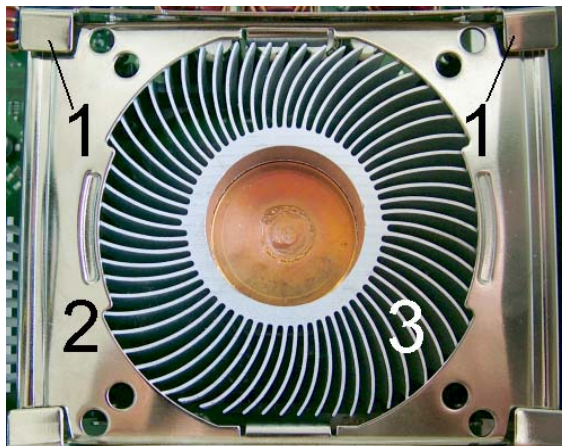

Figure 10-10 Removing the heat sink

3. The heat sink retainer is hooked into the base frame from below. Unhook the heat sink retainer and lift it out.
4. Lift out the heat sink (3). The processor is now accessible.
5. Lift the lever (1) and press it until it stops.



Figure 10-11 Processor

6. Lift the processor (2) out of the slot.

Reverse the procedure to install the processor and hear sink. The processor will be automatically detected by the BIOS.

Caution

Insert the new processor into the slot so that the notch on the processor matches the marking on the processor slot. Swing the lever (1) downwards until it clicks into position.

Ensure that the processor (2) is covered with a thin transparent layer of heat conductive paste. Clean the hear sink if necessary and apply new heat conductive past before installing it.

If the heat sink has a heat conductive pad (a rubbery foil), use the heat conductive pad instead. Only use a heat conductive pad once.

10.2.8 Replacing the backup battery

Introduction

A 3.6 V Lithium battery acts as a backup battery for the hardware clock when the device is disconnected from the mains. It saves the configuration data as well as the system time.

The battery can last several years due to the low power consumption of the clock and the high capacity of the Lithium battery.



Warning

Risk of explosion and release of harmful substances!

Therefore, do not throw Lithium batteries into an open fire, do not solder or open the cell body, do not short-circuit or reverse polarity, do not heat up above 100 °C, dispose as regulated and protected against direct exposure to sunlight, humidity and dewing.

Caution

Data loss

The configuration data of the device are lost if the backup battery fails or is removed from the plug-in contact.

Risk of damage!

Replace the Lithium battery with an identical battery or with a type recommended by the manufacturer.

Disposal

Batteries must be disposed of in accordance with local regulations.

Notice

Batteries are wearing parts. Replaced the batteries every five years. When you replace the battery, you delete the configuration data of the device.

Prerequisite

You have noted the current BIOS Setup settings.

Procedure

Steps for replacing the battery		
1	Open the device	
2	Open the terminal clamp (1). The backup battery will pop slightly out of the holder.	
3	Lift out the backup battery (2).	
4	Insert the new backup battery at an angle and push it under the terminal strip (3).	
5	Press the backup battery down until the terminal clamp clicks (1).	
6	Close the device.	

Reconfiguring the BIOS Setup

The configuration data of the device are lost when the battery is replaced. Reenter the configuration data in the BIOS Setup. The default settings are described in the "Detailed Descriptions" chapter under the section "BIOS Setup", "BIOS Setup Default Settings." Reenter the date and time in the BIOS Setup.

10.2.9 Installing / removing the power supply module

Prerequisite

- The device is opened.
- All power supply cables are unplugged.

Procedure

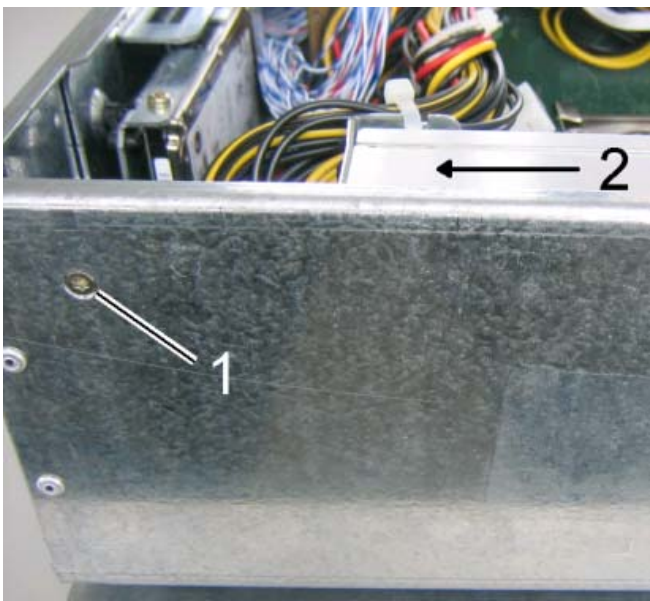
Steps for removing and installing the power supply module		
1	Remove the 2 screws (1).	
2	Remove the screws (1).	
3	Slide the power supply module (2).	
4	Lift out the power supply module (2).	
5	Proceed in reverse order to install the new power supply module.	

10.2.10 Separating the control unit and computer unit

Introduction

The control unit is separated from the computer unit to carry out repairs or to replace the control unit, for example.

Procedure

1. Isolate the device from mains.
2. Open the switchgear cabinet.
3. Remove the device from the switchgear cabinet: Secure the device against falling out and unscrew it. Or remove the clamps which secure the control unit to the installation wall, as shown in the installation cut-out in the dimensions diagram.
4. Carefully set the unit down with the control unit at the bottom.
5. Open the device.
6. Make a note of the arrangement of the ribbon cable plugs in the sockets on the motherboard.
7. Detach the plugs (2) and (3) and also plug (4) when a 19" touch or key panel is used.

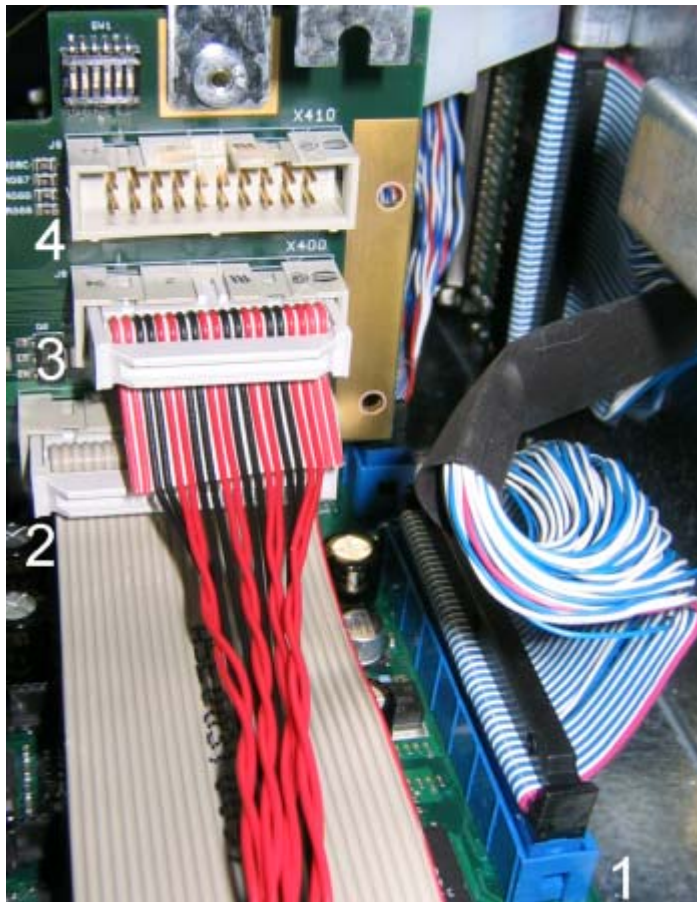

Figure 10-12 Ribbon cable and IDE cable on the motherboard

8. The next two steps apply to control units with 12" touch panels: Loosen the 2 screws (1) that secure the computer unit to the control unit.

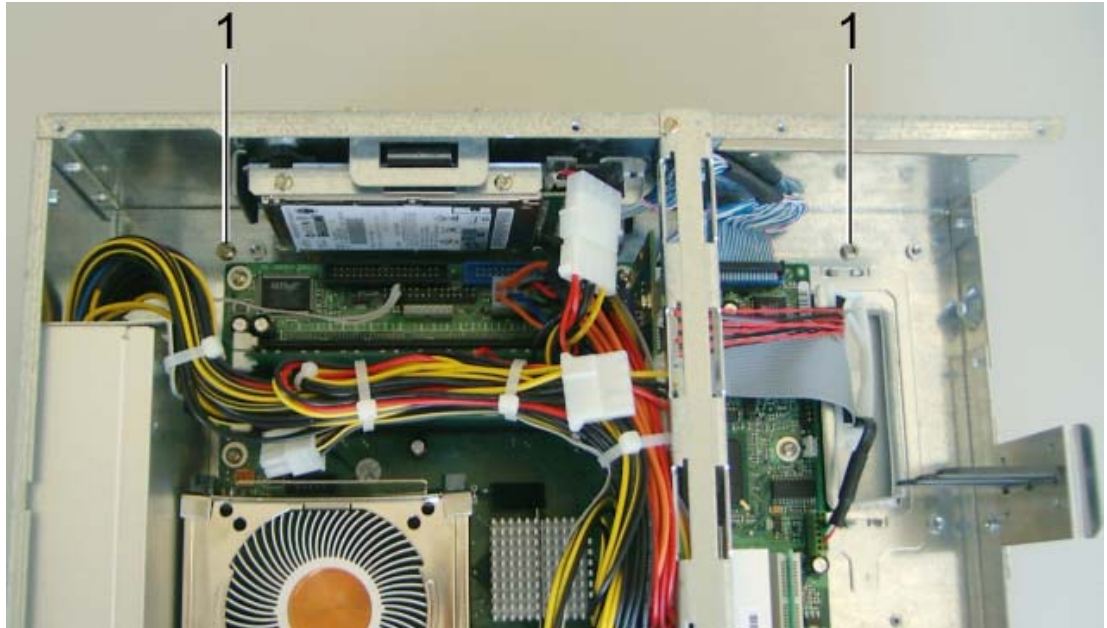

Figure 10-13 Separating a 12" touch screen from the computer unit

A fastening rail (2) with 2 female threads is located on the control unit for screws (1). In like manner, a fastening rail with hooks (3) is located on the computer unit. The control unit latches into these hooks.

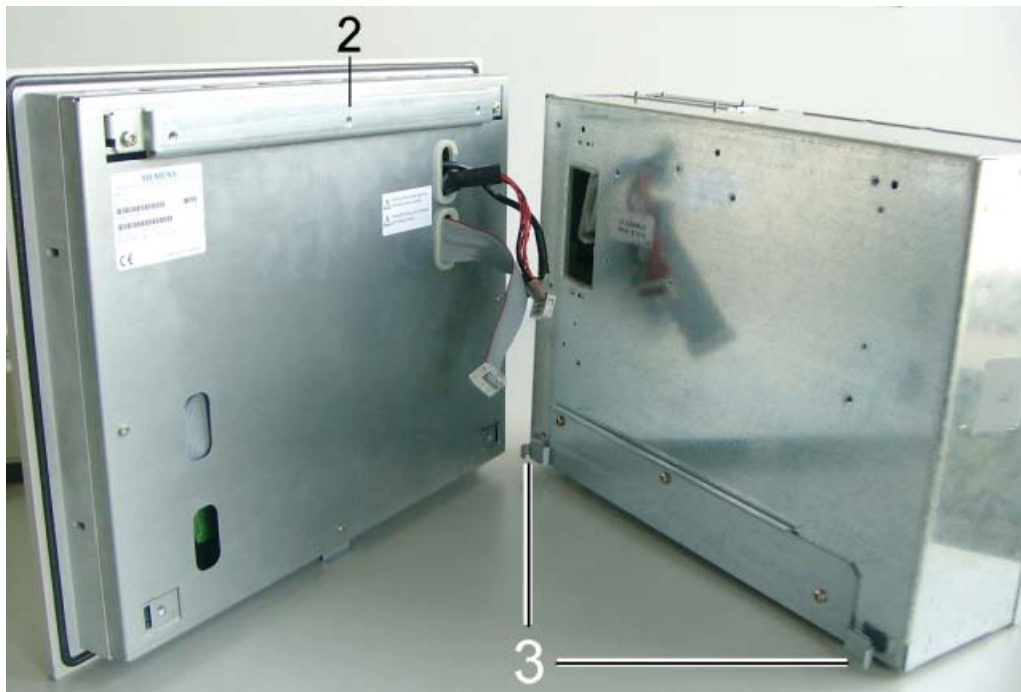

Figure 10-14 Fastening rails on the computer unit and control unit

9. Carefully swing the computer unit down until it releases from the hooks of the control unit. Now remove the computer unit entirely and carefully set it down.

10. The next two steps only apply to control units that do not have 12" touch panels: Loosen all screws (1) which attach the computer unit to the rear of the control unit.

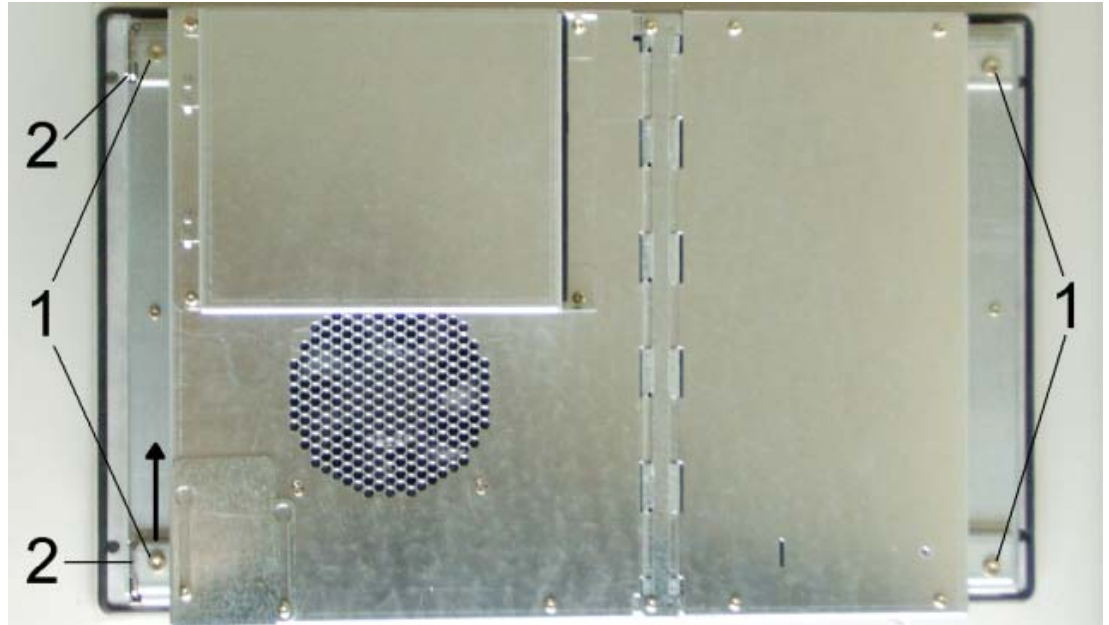

Figure 10-15 Separating the control unit from the computer unit

The control unit and the computer unit are connected to each other by a hinge joint (2) to the left of the illustration.

11. Tilt the computer unit slightly upwards from the control unit, slide the computer unit as indicated by the arrow out of the hinge joint and set it down carefully.

Installing the device

To reinstall the device, follow the reverse procedure.

Caution

Please note the following. Device malfunctions may otherwise occur.

- Ensure that the ribbon cable is plugged into the correct sockets.
- Ensure that the ribbon cable is not kinked or pinched.

- Check the switch settings (1). Ensure that the switch is set to match the settings in the following table.

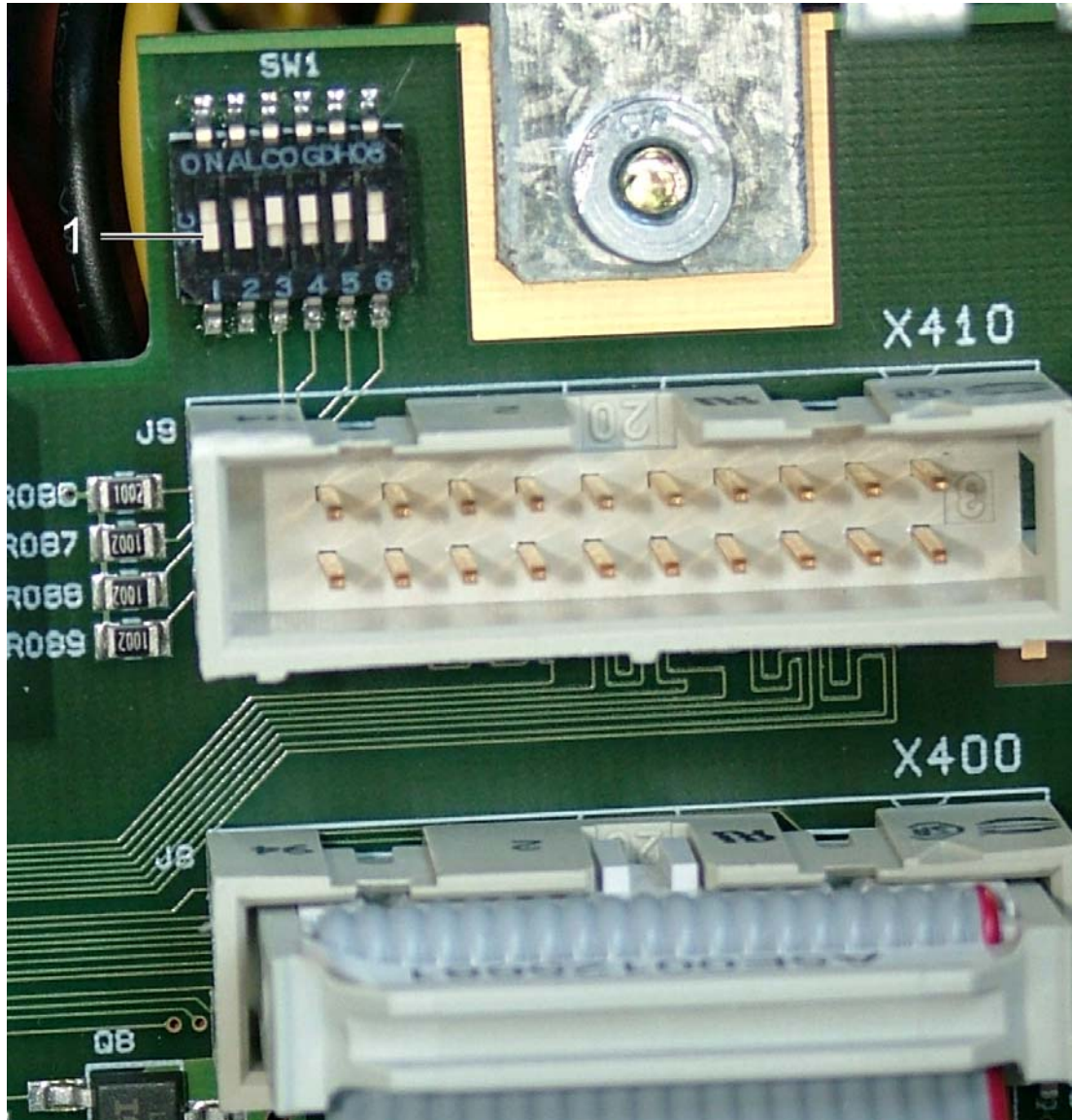

Figure 10-16 Separating the control unit from the computer unit, switch settings and connections

Table 10-1 Switch settings for the various control units

Switch				Display type	Resolution	Ribbon cable socket
3	4	5	6			
ON	ON	ON	ON	12" touch/key panel	800 x 600	X400
ON	ON	ON	OFF	15" touch/key panel	1024 x 768	X400
ON	ON	OFF	ON	19" touch panel	1280 x 1024	X400, X410
ON	ON	OFF	OFF	—	—	—
ON	OFF	ON	ON	—	—	—

- Insert the ribbon cable through the aperture underneath the computer unit.

- When rejoining the computer unit and the control unit, ensure that the ribbon cable is not pinched.



Figure 10-17 Separating from the control unit from the computer unit, ribbon cable

10.2.11 Connecting an external monitor

Introduction

When exchanging the control unit or when it fails, operate an external monitor through the VGA port. You can activate the monitor in the operating system setup.

Procedure

1. Isolate the device from mains and switch the monitor off.

Caution

Damage to the device!

Ensure that the device and the monitor are switched off.

2. Plug the monitor cable into the VGA socket.
3. Screw the monitor cable plug tight.
4. Connect the monitor cable to the monitor.
5. Connect the device to the mains again.
6. Switch on the device and the monitor.
7. When the operating system starts, press the <F5> key.
8. In the dialog that appears, select "640 x 480" as the resolution for the VGA mode.
The use of the monitor is limited with this resolution.

10.3 Installing software

10.3.1 Overview

Introduction

Restart the device systematically after exchanging the hard disk. Or reinstall the software as required.

Caution

Do not turn off the device during the installation of software. Otherwise parts of the software which are necessary for trouble-free operation will be lost. For commissioning, use the default settings in the BIOS as described in the "Detailed Descriptions" chapter under the section "BIOS Setup", "BIOS Setup Default Settings."

Note

The supplied drivers and applications have been tested for the system and released for this device. No warranty can be provided for other software.

Procedure

1. Format and partition the hard disk as required.
2. Transfer the saved data back to drives C and D using the backup utility. Use the Restore CD, for example, to transfer the original image back to the device's hard disk.
3. You can also install an operating system yourself.
4. Install the required Windows Service Packs and Security updates. Refer to the "Commissioning" section for more information.
5. For new Windows 2000 installations, install the chipset driver before installing any other drivers.
6. The following applies if you are installing Windows XP SP1 on the Panel PC without the Restore CDs:



Caution

Inadvertent operation

Install Microsoft Update KB822603. Otherwise, the USB ports and therefore the touch and key operation may not work correctly.

You can download the update and obtain additional information in the Internet at "<http://support.microsoft.com>".

7. Install any other required drivers.
8. If you install an operating system yourself, install all of the required drivers and applications.
9. Install any other required software.
10. Configure the drivers and applications as needed. Refer to the section "Additional drivers and applications" in the operating instructions for the control unit for more information.
11. Save the hard disk data to a CD or a network drive.

Note

To verify that the data on the CD is in order, transfer the data on the CD back to an empty hard disk and quickly test the device by switching it on.

10.3.2 Supplied software CDs

If your software is corrupt, reinstall your software using the Restore CD and Documentation and Drivers CD.

Restore CD:

Contains a hard disk image with the factory software consisting of the operating system and installed hardware drivers.

Documentation and Drivers CD:

Contains the documentation and required system drivers and applications such as the Microsoft Internet Explorer and hotfixes.

Caution

Use the supplied Restore CDs for the device. Verify that the order number of the Restore CD matches that of the device. You can find the order number of the device on the rating label. Do not use the supplied images for any other device. The chipsets and drivers differ.

10.3.3 Restoring the software to factory state using the Restore CD

Introduction

The Restore CD (not included in all delivery versions) can be used to restore the factory setting of the software. The CD contains the necessary images and tools for transferring the factory software to the hard disk drive of your PC. You can restore the entire hard disk with drive C: (system) and drive D: or only drive C: at the command line input. This allows you to retain any user data on drive D

Authorization or to retrieve the License Key from the hard disk.

- Check if you can retrieve your authorization or license key from the hard disk and perform the procedure described below if this is possible.
- If it is not possible to backup your authorization, please contact the Customer Support Hotline. There you can obtain information necessary for your software authorization.

Caution

When you select the "Restore system partition only" option, all data on drive C: (System) will be deleted. All data, user settings and all authorizations or License Keys on drive C: on drive C: will be lost in the process! All data on drive C: of your hard disk drive will be deleted. Setup formats the hard disk partition and reinstalls the original factory software.

When you select the "Restore entire hard disk" option, ALL the data, user settings and authorizations or License Keys will be lost on the hard disk.

State on delivery restoring

1. Insert the Restore CD in your drive and reboot the device. When the BIOS message "Press <F2> to enter Setup or <F12> to show Boot Menu" appears, press the <F12> key.
2. After initialization, a "Boot Menu" is displayed.
3. Select "CD-ROM Drive" with the cursor keys.
4. Now follow the instructions on the screen.

Caution

All existing data, programs, user settings, authorizations and license keys on the drives will be deleted and are therefore lost.

For information on the functions, refer to the "README.TXT" file on the Restore CD.

10.3.4 Operating system not installed

The device can be purchased without an operating system. If you want to install the operating system yourself, read the information available in the Internet at "<http://www.siemens.com/simatichmi>".

Notice

You must integrate the required software components yourself if you install an operating system not offered by Siemens AG. Note the following in this regard:

- The device has features that a standard PC does not, for example, a touchscreen and front panel function keys.
 - Siemens AG can only guarantee the availability of these features for operating systems that have been released.
 - Siemens AG only provides support within a strictly defined framework.
-

10.3.5 Installing individual drivers

Introduction

The "Documentation & Drivers" CD contains the required drivers for the device.

Procedure

1. Start "cdstart.exe" in the root directory of the CD.
2. Follow the instructions displayed on the screen.

Note

For more information about newly installing drivers, refer to the Internet pages at "<http://www.ad.siemens.de>". Read the operating instructions for the operator unit for information about how to configure the additional factory-installed drivers and applications.

10.4 Servicing and spare parts

The following replacement parts are available for the device:

Replacement part	Order No.
12" touch panel complete	
15" touch panel complete	
19" touch panel complete	
12" touch panel complete	
15" touch panel complete	
2.5" hard disk	
CD-ROM	
CD-ROM module	
Motherboard	
Power supply	
128 MB memory module	
256 MB memory module	
Intel Celeron 2.0GHz CPU	
Intel Pentium 4 2.4 GHz CPU	
Small accessories*	
LVDS card	
Riser card	

*) Backup battery, cord packing control panel, hard disk and CD-ROM cables, fans, keys, guide rail in the Win AC cover plate

Alarm, error and system messages

11.1 BIOS error messages

Introduction

This chapter contains a selection of alarms, error messages and troubleshooting information.

Self-test POST

During booting, the BIOS first performs a Power On Self-Test or POST. This checks to ensure that certain device components are functioning properly. The boot sequence is interrupted immediately if critical errors occur.

If the POST does not find an error, the BIOS initializes and tests further components. The graphics are already initialized in this phase of booting. Any error messages that occur are displayed on the screen.

Error diagnostics

The following describes the error message from the system BIOS.

Note

For information on error messages output by the operating system or programs, refer to the corresponding manuals.

Error	Cause	Remedy
Display remains dark	Power supply not connected properly	Check the power outlet, power cable and plug.
A beep sounds when a key is pressed but no character is displayed.	Keyboard buffer is full.	<CTRL> <PAUSE> keys
COM 1 or LPT 1 port does not respond.	The port is deactivated in BIOS Setup.	Activate the COM 1 or LPT 1 port in the submenu "Hardware Options".
Mouse pointer no longer moves.	The PS/2 port is deactivated in BIOS Setup.	Check the Setup setting.

11.2 Motherboard error messages

Error diagnostics

The manual for the motherboard contains information about error messages originating from the motherboard.

Note

For information on error messages from the operating system or programs, refer to the corresponding manuals.

Troubleshooting and FAQs

12.1 General problems

This chapter provides you with tips on how to locate and troubleshoot common problems.

Problem	Possible cause	To correct or avoid error
The device is not operational.	There is no power supply to the device.	Check the power supply, the power cord or the power plug.
The external monitor remains dark.	The monitor is switched off.	Switch on the monitor.
	The monitor is in "powersave" mode.	Press any key on the keyboard.
	The brightness button has been set to dark.	Increase the screen brightness. For detailed information, refer to the monitor operating instructions.
	The power cord or the monitor cable is not connected.	<ul style="list-style-type: none"> • Check whether the power cord has been properly connected to the monitor and to the system unit or to the grounded shockproof outlet. • Check whether the monitor cable has been properly connected to the system unit and to the monitor. <p>If the monitor screen still remains dark after you have performed these checks, please contact your technical support team.</p>
The mouse pointer does not appear on the screen.	The mouse driver is not loaded.	Check whether the mouse driver is properly installed and present when you start the application program. For more detailed information, refer to the manuals for the mouse or application programs.
	The mouse is not connected.	<p>Check whether the mouse cord is properly connected to the system unit. If you use an adapter or extension on the mouse cable, also check the connectors.</p> <p>If the mouse pointer still does not appear on the screen after you have performed these checks and measures, please contact your technical support team.</p>
Wrong time and/or date on the PC.		<ol style="list-style-type: none"> 1. Press <F2> within the boot sequence to open the BIOS Setup. 2. Set the time and date in the setup menu.
Although the BIOS setting is OK, the time and data are still wrong.	The backup battery is dead.	In this case, please contact your technical support team.

12.2 12.2 Problems with third-party modules

Problem	Possible cause	To correct or avoid error
USB device not responding.	The USB ports are disabled in your BIOS.	Use a different USB port or enable the port.
	USB 2.0 device connected but USB 2.0 is disabled.	Enable USB 2.0 in BIOS setup.
	Operating system does not support the USB port.	Enable USB Legacy Support for the mouse and keyboard. For all other devices you need USB drivers for the specific operating system.
DVD/CD: The front loader does not open.	The device is switched off, or the open/close button is disabled by a software application.	Emergency removal of the data medium: <ol style="list-style-type: none"> 1. Switch off the device. 2. Insert a pin, for example, or an opened paper clip into the emergency extraction opening of the drive. Apply slight pressure to the contact until the front loader opens. 3. Pull the loader further out.

12.2 Problems with third-party modules

Problem	Possible cause	To correct or avoid error
The PC crashes during startup.	<ul style="list-style-type: none"> • I/O addresses are assigned twice • Hardware interrupts and/or DMA channels are assigned twice • Signal frequencies or signal levels are not adhered to • Different connector pin assignments • No "Reset Configuration" in BIOS-SETUP 	Check your computer configuration: <ul style="list-style-type: none"> • If the computer configuration corresponds with factory state, contact your technical support team. • If the computer configuration has changed, restore the factor state. Remove the third-party modules and reboot the computer. If the error no longer occurs, the third-party module was the cause of the fault. Replace this module with a Siemens module or contact the module supplier. • Force a "Reset Configuration" using the BIOS setup.
		If the PC still crashes, contact your technical support team.

12.3 SystemGuard errors

Notice

SystemGuard is a freeware application for which Siemens AG offers no technical support. Please read the notes in the SystemGuard documentation. The documentation is available in the Internet at "<http://www.fujitsu-siemens.de>". Enter "SystemGuard" as a search key.

Hardware alarms

The Silent Fan controller reports hardware alarms such as a fan failure. When a hardware alarm occurs, an information window opens for the affected object and displays an error message. You can reset the alarm.

Software alarms

SystemGuard also monitors specific components such as the battery voltage or voltage fluctuations. When a software alarm occurs, an information window opens for the affected object.

Technical data

13.1 Specifications

13.1.1 EMC requirements

	Standards	
EMC requirements	EN 61000-6-4 EN 61000-6-2	
Emitted interference AC	EN 55011 EN 61000-3-2 EN 61000-3-3	Class A Class D
Noise immunity: Mains borne disturbance variables on supply lines	IEC 61000-4-4 IEC 61000-4-5 IEC 61000-4-5	± 2 kV, burst ± 1 kV, surge sym ± 2 kV, surge asym
Noise immunity on signal lines	IEC 61000-4-4 IEC 61000-4-4 IEC 61000-4-5	± 1 kV, burst, length < 3 m ± 2 kV, burst, length > 3 m ± 2 kV, surge, length > 30 m
Immunity to discharges of static electricity ESD	EN 61000-4-2	8 kV with air discharge 6 kV on contact, direct/indirect Interference criterion B
Immunity to RF interference	IEC 61000-4-3 IEC 61000-4-3 IEC 61000-4-6	10 V/m 80-1000 MHz, 80 % AM 10 V/m 900 MHz und 1.89 GHz, 50 % ED 10 V 9 KHz-80 MHz
HF radiation in lines and shielded lines	EN 61000-4-6	On signal lines and data lines 150 kHz to 80 MHz: 10 V/m Modulation: 80 % AM with 1 kHz, interference criterion A
Interference immunity against magnetic fields	IEC 61000-4-8	50/60 Hz, 30 A/m effective value

13.1.2 General specifications

Color display ¹⁾	12" TFT	15" TFT	12" TFT touch screen	15" TFT touch screen	19" TFT touch screen
Resolution	800 x 600	1024 x 768	800 x 600	1024 x 768	1280 x 1024
Lifetime Backlighting	50,000 h for 24 hours per day usage, temperature dependent				
Membrane keyboard with alphanumeric and numeric keys	X		—		
Function keys	36		—		
Labeling strips for function keys	X		—		
Front-mounted integrated mouse	X		—		
Analog resistive touch screen	—		X		
Dimensions 2)	12"	15"	12" touch screen	15" touch screen	19" touch screen
HU = Height unit in mm in inches	7 HU 483 x 310 x 147 19.0 x 12.2 x 5.8	8 HU 483 x 355 x 172 19.0 x 14.0 x 6.7	7 HU 400 x 310 x 167 15.7 x 12.2 x 6.6	7 HU 483 x 310 x 166 19.0 x 12.2 x 6.5	9 HU 483 x 400 x 162 19.0 x 15.7 x 6.4
Total weight	12.91 kg	17.03 kg	13.53 kg	15.46 kg	
Safety	Control unit			Computer unit	
Protection class	In accordance with VDE 0106 T1: 1982 IEC 536			Protection class I to IEC 61140	
Safety requirements	IEC in accordance with DIN VDE 0805/11.93			AC: UL508, EN 61131-2, CSA C22.2 No 14-95	
Approvals	CE, cULUS 508				
Degree of protection	a	With clamp attachment, encircling seal and attached plastic seal cover for USB port		IP 65, NEMA 4	
	b	With screw attachment		IP 54	
Period of warranty	24 months				
Quality assurance	to ISO 9001				
Electrical specifications					
AC power supply	120/230 V AC				
Line voltage frequency	50/60 Hz				
Transient voltage interruption	maximum 16 ms				
Maximum power consumption	285 W				
Noise emission	< 55 dB(A) to DIN 45635-1				

Motherboard	
Processor	Chipset: Intel 865G - Intel® Pentium 4 2.4 GHz - Intel® Celeron 2.0 GHz
RAM	4 slots for 128 MB, 256 MB, 512 MB, 1 GB Maximum 4 GB of memory
Free expansion slots	3 x PCI 175 mm length top slot can be used for WinAC Slot module
Maximum permitted power consumption Maximum permitted total of all slots	Maximum 12 W per slot 36 W
Disk drives	
Hard disk drive	2,5" EIDE, UDMA, ATA-100 mode See order form for hard disk capacity.
CD-ROM	EIDE, 24-speed, master on secondary EIDE interface
Graphics	
Graphic controller	SXGA-LCD controller on the AGP bus
Resolutions/frequencies	12": 800 x 600, 60 Hz 15": 1024 x 768, 60 Hz 19": 1280 x 1024, 60 Hz
Ports	
COM 1	Serial port 1, 9-pin Cannon plug
LPT 1	Parallel port, 25-pin Cannon plug
VGA	Connection for external monitor
Keyboard	PS/2 keyboard
Mouse	PS/2 mouse
USB 2.0	4x external 2x internal 1 x front
Ethernet	LAN 10/100/1000 Mbps

1) A small number of faults in the display is unavoidable.

Imperfect pixels	Acceptable number
Permanently bright and permanently dark pixels	≤ 12
Permanently bright, green pixels	≤ 5

Information concerning resistance to chemicals is located in the section "General Information."

2) Additional mounting depth with CD-ROM drive: + 28 mm = + 1.102 inches

13.1.3 Ambient and environmental conditions

EMC		
Electromagnetic compatibility (EMC)	EN 61000-6-4/EN 55022, EN 61000-6-2 / EN 61000-4-2, EN 61000-4-3, EN 61000-4-4, EN 61000-4-5, EN 61000-4-6	
Mechanical conditions		Tested according to
Vibration load during operation	10 to 58 Hz: 0.0007 in, 58 to 200 Hz: 0.01 oz	IEC 60068-2-6
Shock load during operation	1 g, 30 ms, 3 shocks	IEC 60068-2-27
Climatic ambient conditions		
Temperature limits		
Operation	5° C... 45° C	IEC 60068-2-1
Storage/transport	-20° F... 60° C	IEC 60068-2-14
Relative humidity limits		
Operation	5 ... 80 % at 25° C	IEC 60068-2-30
Storage/transport	5 ... 95 % at 25° C (+77° F)	IEC 60068-2-56
Temperature change	Maximum 10 K/h	
Condensation	Not permissible	
Supply air	No corrosive gases	

13.2 Dimensional drawing of the device

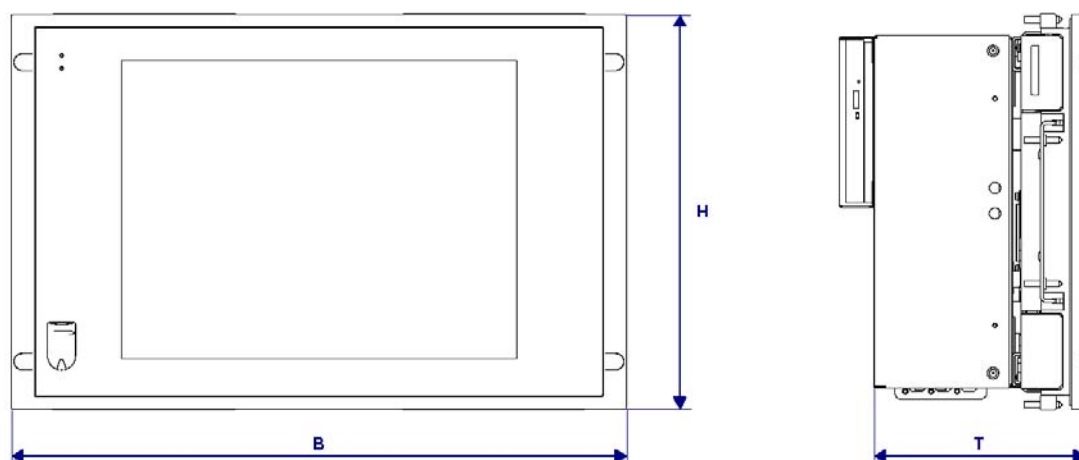

Figure 13-1 Dimensional drawing of the device

Control units	B	H	T 1)
With key panel			
12" TFT	483	310	147
15" TFT	483	355	172
With touch screen panel			
12" TFT	400	310	162
15" TFT	483	310	166
19" TFT in mm	483	400	

1) Additional with CD-ROM drive: + 28 mm = + 1.102 inches

13.3 Keyboard table

Key codes

The following table applies only to control units with key panels. It contains all characters that can be entered in SIMATIC KeyTools in the "Keycode table" area and under "User specific". The character that is triggered by pressing a specific key is listed in the "Display/function" column. Further information is available in the documentation for SIMATIC KeyTools on the "Documentation and Drivers" CD.

Name	Code (Hex) 0x	Check box	Display/function
a A	4	—	a
		L Shift/R Shift	A
		R Alt	á
		R Alt+L Shift/R Shift	Á
b B	5	—	b
		L Shift/R Shift	B
c C	6	—	c

Name	Code (Hex) 0x	Check box	Display/function
		L Shift/R Shift	C
		R Alt	©
		R Alt+L Shift/R Shift	¢
		L Ctrl/R Ctrl	Copy
d D	7	—	d
		L Shift/R Shift	D
		R Alt	ð
		R Alt+L Shift/R Shift	Ð
e E	8	—	e
		L Shift/R Shift	E
		R Alt	é
		L Shift/R Shift	É
		L Gui/R Gui	Start Windows Explorer
f F	9	—	f
		L Shift/R Shift	F
		L Gui/R Gui	Find folder and file
g G	0A	—	g
		L Shift/R Shift	G
h H	0B	—	h
		L Shift/R Shift	H
i I	0C	—	i
		L Shift/R Shift	I
		R Alt	í
		R Alt+L Shift/R Shift	Í
j J	0D	—	j
		L Shift/R Shift	J
k K	0E	—	k
		L Shift/R Shift	K
l L	0F	—	l
		L Shift/R Shift	L
		R Alt	ø
		R Alt+L Shift/R Shift	Ø
m M	10	—	m
		L Shift/R Shift	M
		R Alt	μ
		L Gui/R Gui	Minimize all windows
n N	11	—	-{}-{}-n
		L Shift/R Shift	N
		R Alt	ñ
		R Alt+L Shift/R Shift	Ñ
o O	12	—	o
		L Shift/R Shift	O
		R Alt	ó

Name	Code (Hex) 0x	Check box	Display/function
		R Alt+L Shift/R Shift	Ó
		L Ctrl/R Ctrl	Open
p P	13	—	p
		L Shift/R Shift	P
		R Alt	ö
		R Alt+L Shift/R Shift	Ö
		L Ctrl/R Ctrl	Print
q Q	14	—	q
		L Shift/R Shift	Q
		R Alt	ä
		R Alt+L Shift/R Shift	Ä
r R	15	—	r
		L Shift/R Shift	R
		R Alt	®
		L Gui/R Gui	Display "Run" dialog
s S	16	—	s
		L Shift/R Shift	S
		R Alt	ß
		R Alt+L Shift/R Shift	§
		L Ctrl/R Ctrl	Save
t T	17	—	t
		L Shift/R Shift	T
		R Alt	þ
		R Alt+L Shift/R Shift	Þ
u U	18	—	u
		L Shift/R Shift	U
		R Alt	ú
		R Alt+L Shift/R Shift	Ú
v V	19	—	v
		L Shift/R Shift	V
		L Ctrl/R Ctrl	Insert
w W	1A	—	W
		L Shift/R Shift	W
		R Alt	å
		R Alt+L Shift/R Shift	Å
x X	1B	—	x
		L Shift/R Shift	X
		L Ctrl/R Ctrl	Cut
y Y	1C	—	y
		L Shift/R Shift	Y
		R Alt	ü
		R Alt+L Shift/R Shift	Ü
z Z	1D	—	z

Name	Code (Hex) 0x	Check box	Display/function
		L Shift/R Shift	C
		R Alt	æ
		R Alt+L Shift/R Shift	Æ
		L Ctrl/R Ctrl	
1 !	1E	—	1
		L Shift/R Shift	!
		R Alt	i
		R Alt+L Shift/R Shift	´
2 @	1F	—	2
		L Shift/R Shift	@
		R Alt	²
3 #	20	—	3
		L Shift/R Shift	#
		R Alt	³
4 \$	21	—	4
		L Shift/R Shift	\$
		R Alt	¤
		R Alt+L Shift/R Shift	£
5 %	22	—	5
		L Shift/R Shift	%
		R Alt	€
6 ^	23	—	6
		L Shift/R Shift	^
		R Alt	¼
7 &	24	—	7
		L Shift/R Shift	&
		R Alt	½
8 *	25	—	8
		L Shift/R Shift	*
		R Alt	¾
9 (26	—	9
		L Shift/R Shift	(
		R Alt	'
0)	27	—	0
		L Shift/R Shift)
		R Alt	'
Return	28	—	Return
Escape	29	—	Escape
Backspace	2A	—	Backspace
Tab	2B	—	Tab
Space	2C	—	Space
- _	2D	—	-
		L Shift/R Shift	_

Name	Code (Hex) 0x	Check box	Display/function
		R Alt	¥
= +	2E	—	=
		L Shift/R Shift	+
		R Alt	×
		R Alt+L Shift/R Shift	÷
[{	2F	—	[
		L Shift/R Shift	{
		R Alt	«
] }	30	—]
		L Shift/R Shift	}
		R Alt	»
\	31	—	\
		L Shift/R Shift	
		R Alt	¬
		R Alt+L Shift/R Shift	¡
Europe 1	32	—	Europe 1
; :	33	—	;
		L Shift/R Shift	:
		R Alt	¶
		R Alt+L Shift/R Shift	°
' "	34	—	'
		L Shift/R Shift	"
		R Alt	´
		R Alt+L Shift/R Shift	¨
‘ ~	35	—	‘
		L Shift/R Shift	~
, <	36	—	,
		L Shift/R Shift	<
		R Alt	ç
		R Alt+L Shift/R Shift	Ç
. >	37	—	.
		L Shift/R Shift	>
/ ?	38	—	/
		L Shift/R Shift	?
		R Alt	¿
Caps Lock	39	—	Caps Lock
F1	3A	—	F1
		L Shift/R Shift	F13
		L Ctrl/R Ctrl	S5
F2	3B	—	F2
		L Shift/R Shift	F14
		L Ctrl/R Ctrl	S6
F3	3C	—	F3

13.3 Keyboard table

Name	Code (Hex) 0x	Check box	Display/function
		L Shift/R Shift	F15
		L Ctrl/R Ctrl	S7
F4	3D	—	F4
		L Shift/R Shift	F16
		L Ctrl/R Ctrl	S8
F5	3E	—	F5
		L Shift/R Shift	F17
		L Ctrl/R Ctrl	S9
F6	3F	—	F6
		L Shift/R Shift	F18
		L Ctrl/R Ctrl	S10
F7	40	—	F7
		L Shift/R Shift	F19
		L Ctrl/R Ctrl	S11
F8	41	—	F8
		L Shift/R Shift	F20
		L Ctrl/R Ctrl	S12
F9	42	—	F9
		L Shift/R Shift	S1
		L Ctrl/R Ctrl	S13
F10	43	—	F10
		L Shift/R Shift	S2
		L Ctrl/R Ctrl	S14
F11	44	—	F11
		L Shift/R Shift	S3
		L Ctrl/R Ctrl	S15
F12	45	—	F12
		L Shift/R Shift	S4
		L Ctrl/R Ctrl	S16
Print Screen	46	—	Print Screen
Scroll Lock	47	—	Scroll Lock
Break (Ctrl-Pause)	48	—	Break (Ctrl-Pause)
Pause	48	—	Pause
Insert	49	—	Insert
Home	4A	—	Home
Page Up	4B	—	Page Up
Delete	4C	—	Delete
End	4D	—	End
Page Down	4E	—	Page Down
Right Arrow	4F	—	Right Arrow
Left Arrow	50	—	Left Arrow
Down Arrow	51	—	Down Arrow
Up Arrow	52	—	Up Arrow

Name	Code (Hex) 0x	Check box	Display/function
Num Lock	53	—	Num Lock
Keypad /	54	—	Keypad /
Keypad *	55	—	Keypad *
Keypad -	56	—	Keypad -
Keypad +	57	—	Keypad +
Keypad Enter	58	—	Keypad Enter
Keypad 1 End	59	—	Keypad 1 End
Keypad 2 Down	5A	—	Keypad 2 Down
Keypad 3 PageDn	5B	—	Keypad 3 PageDn
Keypad 4 Left	5C	—	Keypad 4 Left
Keypad 5	5D	—	Keypad 5
Keypad 6 Right	5E	—	Keypad 6 Right
Keypad 7 Home	5F	—	Keypad 7 Home
Keypad 8 Up	60	—	Keypad 8 Up
Keypad 9 PageUp	61	—	Keypad 9 PageDn
Keypad 0 Insert	62	—	Keypad 0 Insert
Keypad . Delete	63	—	Keypad . Delete
Europe 2	64	—	Europe 2
App	65	—	App
Keyboard Power	66	—	Keyboard Power
Keypad =	67	—	Keypad =
F13	68	—	F13
F14	69	—	F14
F15	6A	—	F15
F16	6B	—	F16
F17	6C	—	F17
F18	6D	—	F18
F19	6E	—	F19
F20	6F	—	F20
F21	70	—	F21
F22	71	—	F22
F23	72	—	F23
F24	73	—	F24
Left Control	E0	—	Left Control
Left Shift	E1	—	Left Shift
Left Alt	E2	—	Left Alt
Left GUI	E3	—	Left GUI
Right Control	E4	—	Right Control
Right Shift	E5	—	Right Shift
Right Alt	E6	—	Right Alt
Right GUI	E7	—	Right GUI

Detailed descriptions

14.1 Overview of the Panel PC IL 77 motherboard

The Panel PC IL 77 contains the Fujitsu-Siemens Premium Motherboard D1562-C. Further information is available in the manual for the motherboard on the "Documentation and Drivers" CD and in the Internet at "<http://www.fujitsu-siemens.de>".

14.2 Riser card

Introduction

A passive Riser card is used as the bus board. With a passive Riser card, the interrupts are fetched from the next slot on the motherboard via an adapter and cable. The cables are plugged into the Riser card and the PCI adapter and are not soldered.

The upper two slots provide non-shared interrupts for WinAC cards.

Functional features

- 3 free PCI slots
- The 2 "top" and "middle" slots each have a non-shared interrupt.

Specifications

The Riser card conforms to PCI Local Bus Specification Revision 2.3 and ATX Riser Card Specification 1.0.

Allocation of motherboard slots to the Riser card

Motherboard slot	Slot on Riser card
PCI 1: next to AGP slot	1, top
PCI 2: middle slot	2, middle
PCI 3: right slot	3, bottom

14.3 System resources

14.3.1 Currently allocated system resources

The system resources (hardware address, memory configuration, IRQ, DMA channel) are assigned dynamically by the Windows OS, depending on the hardware configuration, drivers and connected peripheral devices. Dialogs show the current allocation of the system resources or existing conflicts.

Note

For additional information, search for the terms "System information" and "Diagnostics" in the Windows help.

14.3.2 Interrupt assignment

PCI Interrupt Line	Controller or slot INT												
	Onboard controller									Mechanischer Steckplatz			
	USB 1.1				USB 2.0	SMBus	AC97		LAN	AGP	PCI-Steckplatz		
	1 st	2 nd	3 rd	4 th			Audio	Modem			1	2	3
1 (A)	X	-	-	X	-	-	-	-	-	A	-	-	-
2 (B)	-	-	-	-	-	X	X	X	-	B	-	-	-
3 (C)	-	-	X	-	-	-	-	-	-	-	D	C	A
4 (D)	-	X	-	-	-	-	-	-	-	-	C	D	B
5 (E)	-	-	-	-	-	-	-	-	X	-	-	-	-
6 (F)	-	-	-	-	-	-	-	-	-	-	B	A	C
7 (G)	-	-	-	-	-	-	-	-	-	-	A	B	D
8 (H)	-	-	-	-	X	-	-	-	-	-	-	-	-

Figure 14-1 Interrupt assignment of the motherboard used

14.4 BIOS Setup

14.4.1 Overview

BIOS SETUP program

The BIOS SETUP program is stored in the ROM BIOS. Information about the system configuration is stored in the battery-backed RAM of the device.

You can use SETUP to set the hardware configuration (for example, the hard disk type) and define the system properties. You can also use SETUP to set the time-of-day and date.

Changing the device configuration

Your Rack PC device configuration is preset for working with the software supplied with the unit. You should only change the preset values if you have modified your Rack PC in any way, or if a fault occurs when the unit is powered up.

14.4.2 Starting BIOS Setup

Starting BIOS Setup

Start the setup program as follows:

Reset the device (warm or cold restart).

In the figures shown, the default settings differ based on the device versions. With the default settings on the Box PC, **for example**, the following screen appears after booting:

```
Phoenix cME FirstBIOS Desktop Pro
Copyright 1985-2004 Phoenix Technologies Ltd.
Copyright 2003-2004 Fujitsu Siemens Computers
Version 5.00 R2.XX.1562.01(XX je nach Version)

Intel Pentium 4 X.XX GHz (X.XX je nach Prozessor) 640K System RAM Passed
```

2. On completion of the POST, the BIOS gives you the opportunity of starting the SETUP program. The following message appears on the screen:

```
<F2> BIOS Setup / <F12> Boot Menu
```

3. Press the F2 key as long as the BIOS prompt appears on the screen.

14.4.3 BIOS Setup default settings

Panel PC IL 77 default settings

The default settings of the BIOS Setup may reset in some circumstances, for example, when the backup battery is exchanged or when the BIOS is update. The BIOS default settings, however, do not correspond to the standard settings of the device. The differences are shown in the following table.

Notice

If the BIOS has been reset, enter the settings listed in the right column of the table.

System parameters	BIOS Setup default settings	Panel PC IL77 default settings
Main		
Floppy disk A	1.44 MB 3 1/2"	None
Boot Options		
POST Errors	Enabled	No Halt On Any Errors
Advanced		
Advanced/Peripheral Configuration		
S-ATA Interface	Enabled	Disabled
Floppy disk [Diskette] controller	Enabled	Disabled
Advanced/System Management		
SM Fan Control	Enabled	Enhanced Cooling
Power		
APM Power Saving	Enabled	Disabled
APM Resume Timer	Enabled	Disabled
Standby Timeout	Enabled	Disabled
Hard Disk Timeout	Enabled	Disabled
Power/Power On/Off		
Power Failure Recovery	Previous-State	Always ON

Appendix A

A.1 Certificates and guidelines

A.1.1 Guidelines and declarations

Notes on the CE Label



The following applies to the SIMATIC product described in this documentation:

Notes for Sweden, Norway, Finland



Caution

Forsiktig

Apparatet må tilkoples jordet stikkontakt.

Varo

Laite on liitettävä suojamaadoituskoskettimilla varustettuun pistorasiaan.

Guidelines for Handling Electrostatic Sensitive Devices (EMC)

AC voltage supply

The devices with AC power supply fulfill the requirements of the EC directive "89/336/EEC Electromagnetic Compatibility" and are intended for the following fields of application in accordance to the CE label:

Field of Application	Requirement for	
	Emitted interference	Noise Immunity
Industry	EN 61000-6-4: 2001	EN 61000-6-2: 2001

The device is also compliant with EN 61000-3-2:2000, harmonic currents and EN 61000-3-3:1995, voltage fluctuation and flicker.

Low-voltage directive

The devices complies with the requirements of the EC directive 73/23/EEC "Low-Voltage Guidelines." Conformance with this standard has been verified according to EN 60950.

Declaration of conformity

The EC declaration of conformity and the corresponding documentation are made available to authorities in accordance with the EC directives stated above. Your sales representative can provide these on request.

Design guidelines

Adhere to the installation guidelines and safety instructions given in this documentation during commissioning and operation.

Connecting peripherals

The requirements regarding noise immunity to EN 61000-6-2:2001 are met when you connect a peripheral suitable for an industrial environment. Always use shielded cables to connect peripherals.

A.1.2 Certificates and approvals

DIN ISO 9001 certificate

The quality assurance system for the entire product process (development, production, and marketing) at Siemens fulfills the requirements of ISO 9001 (corresponds to EN29001: 1987).

This has been certified by DQS (the German society for the certification of quality management systems.)



EQ-Net certificate no.: 1323-01

Software License Agreement

The device is shipped with preinstalled software. Please observe the corresponding license agreements.

Certification for the USA, Canada and Australia

Safety

One of the following markings on a device is indicative of the corresponding approval:	
	Underwriters Laboratories (UL) to UL 60950 Standard (I.T.E), or to UL508 (IND.CONT.EQ)
	Underwriters Laboratories (UL) to Canadian Standard C22.2 No. 60950 (I.T.E), or to C22.2 No. 142 (IND.CONT.EQ)
	Underwriters Laboratories (UL) to Standard UL 60950, Report E11 5352 and Canadian Standard C22.2 No. 60950 (I.T.E), or to UL508 and C22.2 No. 142 (IND.CONT.EQ)

The device also fulfills the requirements for FCC und NEMA 4, indoor use.

Note

The approval or approbation is located on the rating label. The rating label is described in the chapter "Planning use."

EMC

USA	
Federal Communications Commission Radio Frequency Interference Statement	This equipment has been tested and found to comply with the limits for a Class A digital device, pursuant to Part 15 of the FCC Rules and the Canadian Interference-Causing Equipment Standard ICES-003 for digital apparatus. These limits are designed to provide reasonable protection against harmful interference in a residential installation. This equipment generates, uses, and can radiate radio frequency energy and, if not installed and used in accordance with the instructions, may cause harmful interference to radio communications. However, there is no guarantee that interference will not occur in a particular installation. If this equipment does cause harmful interference to radio or television reception, which can be determined by turning the equipment off and on, the user is encouraged to try to correct the interference by one or more of the following measures: <ol style="list-style-type: none"> 1. Reorient or relocate the receiving antenna. 2. Increase the separation between the equipment and receiver. 3. Connect the equipment into an outlet on a circuit different from that to which the receiver is connected. 4. Consult the dealer or an experienced radio/T.V. technician for help.
Shielded Cables	The use of shielded I/O cables is required when connecting this equipment to any and all optional peripheral or host devices. Failure to do so may violate FCC rules.
Modifications	Siemens AG is not responsible for any radio television interference caused by unauthorized modifications of this equipment or the substitution or attachment of connecting cables and equipment other than those specified by Siemens AG. The correction of interference caused by such unauthorized modification, substitution or attachment will be the responsibility of the user.
Canadian Notice	This Class A digital apparatus meets also all requirements of the Canadian Interference-Causing Equipment Regulations ICES-003.

A.1.3 ESD guideline

What ESD means

Almost all electronic modules are equipped with highly integrated components and elements in MOS technology. Due to their their technology, these electronic components are extremely sensitive to power surges and also to discharges of static electricity. These components are therefore marked as follows:

- **ESD:** components susceptible to **ElectroStatic Discharge**
- **ESD:** internationally recognized marking for components and modules susceptible to electrostatic discharge

The following symbols on switch cabinets, module carriers or packaging indicate their susceptibility to electrostatic discharge:



ESD components are destroyed by voltage and energy far below the limits of human perception. Such voltage can occur even when components or modules are touched by a person who is not charged with electrostatic energy. ESD components which were subject to such voltage are usually not recognized immediately as being defective, because the malfunction does not occur until after a longer period of operation.

Note

More information is located on the rating label. The rating label is described in the chapter "Planning use."

Protective measures against electrostatic charging

Most plastics can be charged easily. Therefore, keep plastics away from ESD components!

When working with electrostatically sensitive components, make sure that the person, the workstation and the packaging are properly grounded. Conduct the electrostatic charge away from your body by touching the mounting plate for the interfaces, for example.

Handling modules susceptible to electrostatic discharge

As a rule: Only touch ESD components if unavoidable due to necessary tasks.

Only touch the components when the following holds true:

- You are permanently grounded by means of an ESD armband.
- You are wearing ESD shoes or ESD shoes grounding protective strips in connection with ESD floors.

Discharge your body before touching ESD components. Touch a conductive object immediately beforehand, e.g. a bare metal part of a switch cabinet or the water pipe.

Do not allow chargeable, highly insulated materials, e.g. plastic films, insulating tabletops, synthetic clothing fibers, to come into contact with ESD components.

Place ESD components only on conductive surfaces (work surfaces with ESD surface, conductive ESD foam, ESD packing bag, ESD transport container).

Do not expose ESD components to visual display units, monitors or televisions. Maintain a distance of at least 10 cm to screens.

Handle flat components only by their edges. Do not touch component connectors or conductors. This prevents charges from reaching and damaging sensitive components.

Measuring and changing ESD modules

Measure the ESD component under the following conditions only:

- The measuring device is grounded with a protective conductor, for example.
- The probe on the potential-free measuring device has been discharged, e.g. by touching the bare metal of a part of the switch cabinet.
- Your body is discharged. To do so, touch a grounded metallic component.

Solder only with grounded soldering irons.

Shipping modules susceptible to electrostatic discharge

Always store or ship ESD components in conductive packaging, e.g. metallized plastic boxes or metal cans. Leave the components and parts in their packaging until installation.

If the packaging is not conductive, wrap the ESD component in a conductive material, e.g. rubber foam, ESD bag, household aluminum foil, or paper, before packing. Do not wrap the ESD component in plastic bags or plastic film.

In ESD components containing installed batteries, make sure that the conductive packaging does not touch the battery connectors or short circuit. Insulate the connectors with suitable material.

A.1.4 Electrostatic discharge from persons

Anyone who is not connected to the electrical potential of their surroundings can be electrostatically charged.

The figure below shows the maximum electrostatic voltages that can accumulate in a person who is operating equipment when he/she comes into contact with the materials indicated. These values correspond with specifications to IEC 801-2.

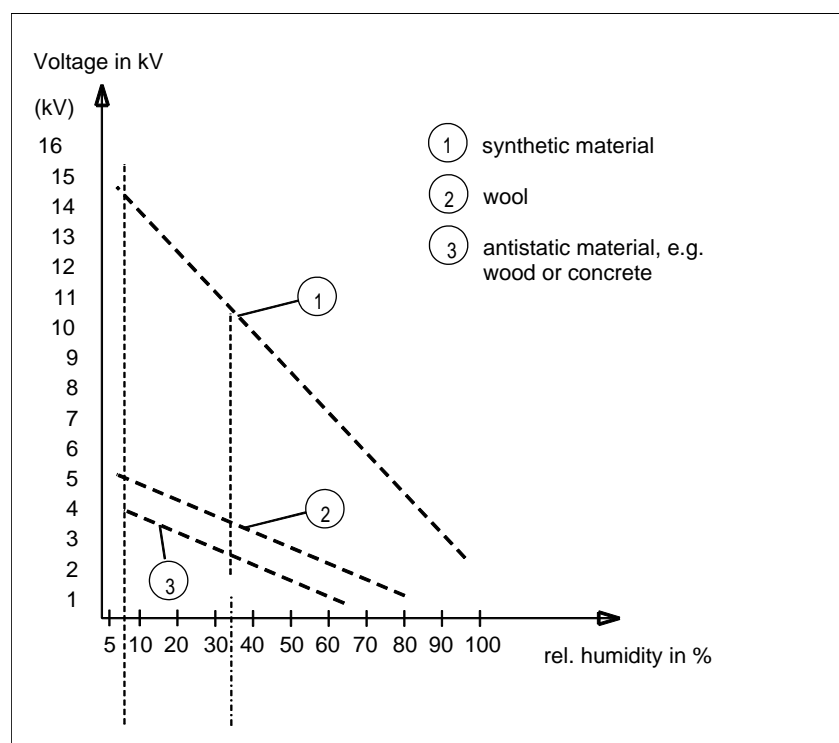

Figure A-1 Electrostatic voltages with which an operator can be charged.

A.2 Abbreviations

ANSI	American National Standards Institute
ASCII	American Standard Code for Information Interchange
B	Width
BIOS	Basic Input Output System
CD-ROM	Compact Disc – Read Only Memory
CPU	Central Processing Unit
DC	Direct Current
DHCP	Dynamic Host Configuration Protocol
DNS	Domain Name Service
DP	Distributed I/Os
DSN	Data Source Name
ESD	Modules susceptible to ElectroStatic Discharge
EMC	ElectroMagnetic Compatibility
H	Height
HF	High frequency
HMI	Human Machine Interface
IF	Interface: Interface
LCD	Liquid Crystal Display: Liquid crystal display
LED	Light Emitting Diode: Light emitting diode
Mbps	Megabits per second
PC	Personal Computer
PG	Programming device
PPI	Point to Point Interface SIMATIC S7
PS/2	Personal System 2
PLC	Programmable Logic Controller
T	Device depth
TCP/IP	Transmission Control Protocol/Internet Protocol
USB	Universal Serial Bus
VGA	Video Graphics Array

A.3 Glossary

A

Application

An application is a program which is put directly on the operating system MS-DOS or windows. An application on the PC/PG, for example, is STEP 7.

Automation device (AD)

The programmable automation devices (AD) of the SIMATIC S5 system consist of a central unit, one or several CPUs, and other modules, e.g. input modules and output modules.

Automation system (AS)

A programmable logic controller (PLC), consisting of a central unit, a CPU, and various input and output modules.

B

Baud

Unit of measurement for the transmission speed. The unit of measurement, Baud, defines the number of transferred signal states per second. When only two states occur, one baud is equivalent to a transmission rate of 1 bps.

Module

Modules are plug-in units for PLCs, programming devices, or PCs. Modules exist, for example, as central modules, power-ons, or as mass storage.

Boot diskette

A boot disk is a bootstrap loader diskette, which has a boot sector which loads the operating system from the diskette.

Booting

The starting or restarting of the computer. During the boot sequence, the operating system is loaded from the system data carrier into RAM.

C

Cache

High-speed access buffer often used for interim storage (buffering) of requested data. The computer has two cache levels, the 2 level.

Chipset

Located on the motherboard, interconnects the processor with the RAM, the graphic controller, the PCI bus, and the external interfaces.

COM interface

The COM interface is a serial V.24 modem interface. The port is suitable for asynchronous data transfer. As an alternative, connect printers with a serial interface.

Controller

Installed hardware and software which control the functions of specific internal or external devices, e.g. the keyboard controller.

D

Documentation & Drivers CD

The "Documentation & Drivers" CD is included. The CD contains specific drivers and drivers and applications for the supported operating system.

Drop down menu

Menu bar on the upper edge of the screen. The menu commands are pre-set or can be set as drop down menus or pull down menus. Drop down menus roll down as soon as the cursor is moved over the menu title. Pull down menus roll down after clicking on the title.

E

EPROM, EEPROM

Plug-in module with EPROM/EEPROM chips. The chips store S5/S7 application programs permanently. This programmed module is then inserted into the prepared slots of the automation systems.

Ethernet

Local network with Bus structure for data communication with a transmission speed of 10/100 baud.

F

Formatting

Basic partitioning of memory space on a magnetic data carrier into tracks and segments. Formatting deletes all data on a data carrier. All data carriers must be formatted prior to their first use.

D

Gender Changer

The Gender Changer 25-pin male / 25-pin male is used to convert the COM1/V24/AG interface of the SIMATIC PC family into the common 25-pin male connector.

Motherboard

The motherboard, as the central part of the computer, processes and stores data, controls and manages interfaces and peripheral devices.

H

RAM

The main memory represents the complete RAM area on a PC/PG.

Hub

A term from network technology. A device which joins communication lines at a central location and provides a common connection to all devices on the network.

I

Image

An image is, for example, an image of hard disk partitions. Save the image in a file in order to restore it as needed.

Interface

See Interface.

K

Cold start

A start sequence which begins when the computer is turned on. During a cold start, the operating system carries out basic hardware checks and then boots.

L

LPT interface

The LPT interface is a parallel centronic interface to which a printer is connected, for example.

P

Plug and play

Through plug and play, the computer configures itself automatically to be able to communicate with peripheral devices, e.g. screens, modems and printers. User connects a peripheral device: plug. Afterwards, the peripheral device can be used immediately. play, without having to configure the operating system manually. The Plug and Play PC requires both a BIOS that supports Plug and Play and a corresponding expansion card.

R

Recovery CD

Contains the DOS tools for installing drivers in hard disks and Windows operating systems.

Restore CD

The Restore CD is used to restore the system partition or the entire hard disk to factory state if the system has crashed. The bootable CD contains all the necessary image files. They create a start diskette which restores the factory state through the network drive.

ROM memory

Read-Only Memory The ROM memory is a read only memory in which every memory location can be addressed individually. They contain factory set programs and data that are not lost in the event of a power failure.

Hibernation

The screen and hard disk are shut off during hibernation. All data located in the RAM is stored on the hard disk and the PG is shut off.

S

Interface

The connection of individual hardware elements, e.g. automation device, PCs, programming device, printer, or screen, by means of physical plug connectors.

Connection between different programs in order to exchange data.

T

Drivers

Program parts of the operating system. They adapt user program data to the specific formats required by peripheral devices, such as hard disk, monitors, and printers.

V

V.24 interface

The V.24 interface is a standardized port for data transfer. Connect printers, modems, and other hardware components to the V.24 interfaces.

Index

<

<Shift> key, 8-5

1

12" variant, 3-5, 8-2

15" variant, 8-9

A

Abbreviations, A-6

AC power supply, 5-9, A-1

 AC uninterruptible power supply, 5-9

AC uninterruptible power supply, 5-9

Active PFC, 5-9

Allocation

 Resources, 10-8

Allocation of resources, 10-12

Application, A-7

Application features, 2-1

Approbation, A-2

Approval, 13-2, A-2

Approvals, A-2

Arithmetic symbols, 8-6

 Entering, 8-6

AS, A-7

Assignment

 Interrupts, 14-2

Assignment, 14-2

Authorization, v, 10-28

Automatic updates, 6-6

Automation device, A-7

Automation System, A-7

B

Back-lighting, 13-2

 Service life, 13-2

Battery replacement, 10-18

Baud, A-7

BIOS, 7-2

 BIOS settings, 7-2

 Setup, 14-3

BIOS SETUP, 14-3

BIOS Setup default settings, 14-4

Boot diskette, A-7

Boot options

 BIOS Setup, 14-3

Booting, A-7

C

Cable connector, 10-21

Cache, A-7

Canada, 5-7

Caring, 10-1

 Sensor, 10-1

CD-ROM drive, 8-11, 13-3

CD-RW, 13-3

Certificates, A-2

Change, A-4

Changing

 ESD, A-4

CheckLanguageID, 7-6

Checklist, 6-1

Chipset, A-7

Clamp, 4-1

Cleaning agents, 10-1

Closing, 10-5

 Device, 10-5

Cold start, A-8

COM 1, 13-3

COM interface, A-7

COM port

 Ports, 2-4, 5-3

Commissioning, 1-4, 5-1, 5-2, 5-6, 6-1, 10-26

 Sensor, 6-1

Communications environment, ii

Components

 additional, 6-3

Components susceptible to ElectroStatic

Discharge, A-3

Computer unit, 10-21

 Separating from the control unit, 10-21

Condensation, 1-4, 6-1

connecting, 5-5

 Monitor, 5-5

Connecting, 1-2, 5-1, 5-4, 5-5, 5-6, 5-7, 6-1, 7-1, 8-7, 10-2, 10-25, A-2
 Connecting external keyboard, 8-7
 Electrical connection, 1-2, 10-2
 Equipotential bonding, 5-4, 5-5
 I/O modules, 6-1, 7-1, A-2
 Monitor, 10-25
 Peripherals, 5-5
 Power supply, 5-7
 Sensor, 5-6
 USB device, 5-6
 Connection sequence, 5-1
 Control key, 8-4
 Control unit, 5-2, 10-21
 Separating from the computer unit, 10-21
 without front USB port, 5-2
 Controller, A-7
 Conventions, iii
 Cursor key, 8-7

D

Dash, 8-6
 Data exchange, 9-1
 Decimal point, 8-6
 Declaration of conformity, A-1
 Defaults, 14-4
 Degree of protection, 3-6
 Degree of protection IP65, 3-6
 IP54 degree of protection, 3-6
 Design, 2-2, 3-4
 EMC compliant design, 3-4
 Design guidelines, A-2
 Device, 2-2, 3-4, 4-1, 7-1, 7-2, 10-5
 Closing, 10-5
 Enabling, 7-1
 Installing the device according to EMC
 guidelines, 3-4
 mounting, 4-1
 Side view port side, 2-2
 Switch off, 7-2
 Device number, 3-3
 Checking, 3-3
 Diagnostics, 11-1, 11-2
 Error, 11-1, 11-2
 Troubleshooting, 12-1
 Differences in potential, 5-4
 Dimensions, 3-7, 4-2
 Disk drives, 13-3
 Display, 1-5
 TFT-LC display, 1-5
 distributed, 9-1
 Documentation, ii

Documentation & Drivers CD, A-7
 Drive, 2-3
 Drivers, 10-29, A-9
 Installing, 10-29
 Drop down menu, A-8
 DVD ROM, 13-3

E

EELY Touch software, 7-3, 7-4
 Inadvertent operation, 7-4
 Setting, 7-3
 Special features, 7-4
 EEPROM, A-8
 Electromagnetic Compatibility, 3-3
 Electromagnetic compatibility (EMC), 13-4
 Electrostatic charge, A-5
 Electrostatic charging, A-4
 Protective measures, A-4
 EMC, 3-3, 3-4, 13-4
 EMC compliant design, 3-4
 Guideline, 3-3
 EMV-Richtlinie, A-3
 Enable, 3-1
 Enabling, 7-1
 Device, 7-1
 Energy-saving mode, 6-3
 Entering, 8-6
 Arithmetic symbols, 8-6
 Signs, 8-6
 Special characters, 8-6
 EPROM, A-8
 Equipotential bonding, 5-4, 5-5
 Connecting, 5-4, 5-5
 Difference in potential, 5-4
 Requirements, 5-4
 Error, 11-1, 11-2
 Diagnostics, 11-1, 11-2
 Error messages
 Troubleshooting, 12-1
 ESD, A-3, A-4, A-5
 Changing, A-4
 Electrostatic charge, A-5
 Guideline, A-4
 Handling, A-4
 Measuring, A-4
 Shipping, A-5
 Ethernet, 9-1, A-8
 Ports, 2-4
 Ethernet address, 3-3
 Expansion, 2-3
 Memory, 2-3
 Expansion slots, 13-3

F

field devices, 9-1
 Field of application, 3-1
 Formatting, A-8
 Function key, 8-3, 8-8, 13-2
 Labeling, 8-8

G

Gender Changer, A-8
 Glossary, A-7
 Graphics, 2-3, 13-3
 Graphics
 Specifications, 13-3
 Guidelines for Handling Electrostatic Sensitive
 Devices (EMC), A-1
 AC power supply, A-1

H

Hard disk, 2-3
 Hard disk drive, 13-3
 Hardware components, 6-3
 Additional hardware components, 6-3
 Hibernation, A-9
 Hub, A-8

I

I/O modules, 6-1, 7-1, A-2
 Connecting, 6-1, 7-1, A-2
 Identification data, 3-3
 Writing down, 3-3
 IEC, 13-2
 IEC power connector, 5-4
 Image, A-8
 Inadvertent operation, 7-4, 8-3
 installation, 4-1, 10-19, 10-23
 Power supply, 10-19
 Sensor, 4-1, 10-23
 Installation cut-out, 3-6
 Selecting, 3-6
 Installation guidelines, 3-4
 Installing, 3-4, 10-29
 Drivers, 10-29
 Installing the device according to EMC
 guidelines, 3-4
 Operating system, 10-29
 Integration, 9-1
 Ethernet, 9-1
 PROFIBUS, 9-1
 Interconnection to SIMATIC S7, 9-1

Interface, 5-2, A-8, A-9

Interfaces

 Keyboard, 5-3
 Mouse, 5-3
 USB, 5-3

Interference immunity, 3-3, 3-4

 EMC compliant design, 3-4

 Guidelines for Handling Electrostatic Sensitive
 Devices (EMC), 3-3

Interrupt, 14-2

IT communication, 9-1

K

Key, 8-5, 8-6

 Alphanumeric key, 8-5

 Numeric key, 8-6

Key code, 13-5

Key panel, 8-2

Keyboard, 2-4, 5-2, 8-3, 8-7

 External keyboard, 5-2, 8-7

 Interfaces, 5-3

Keyboard table, 13-5

L

Labeling, 8-8

 Function key, 8-8

 Softkey, 8-8

Labeling strips, 8-8, 13-2

 Handwritten strips, 8-8

Laser printer, 8-8

License Key, 10-28

Lithium battery, 10-18

Local information, 5-7

Lower case letter, 8-5

 Toggling to upper case letters, 8-5

Low-voltage directive, A-1

LPT 1, 13-3

LPT interface, A-9

LPT port

 Ports, 5-3

M

Maintenance, 10-1

Measuring, A-4

 ESD, A-4

Mechanical conditions, 13-4

Membrane keyboard, 13-2

Memory expansion, 10-7, 10-8

 Display, 10-8

- Minus sign, 8-6
- Module, A-7
- Modules, 10-8
- Modules susceptible to ElectroStatic Discharge, A-3
- Monitor, 5-5, 10-25
 - connecting, 5-5
 - Connecting, 10-25
- Motherboard, A-8
- mounting, 4-1
 - Device, 4-1
- Mounting position, 3-5
 - Approved mounting position, 3-5
- Mouse, 2-4, 5-2, 5-5, 8-9, 13-2
 - External mouse, 5-2
 - Integrated mouse, 8-9
 - Interfaces, 5-3
- Mouse pointer, 8-9
 - Direction, 8-9
 - Speed, 8-9

N

- Navigation, 8-7
- Notation, iii
- Note, 1-2, 1-3, 3-4, 10-2
 - General Notes, 1-3
 - Installation notes, 3-4
 - Safety Information, 1-2, 10-2

O

- Offices, iv
- On / Off switch, 8-1
- Online ordering system, 9-1
- Operating, 8-10
 - Touch screen, 8-10
- Operating elements, 8-9
 - For touch screen panel, 8-9
- Operating system, 2-3, 10-29
 - Installing, 10-29
- Operator controls, 8-2
 - On the key panel, 8-2

P

- Package contents, 3-2
 - Checking, 3-2
- Packaging, 3-2
 - Checking, 3-2
 - Removing, 3-2
- Panel PC IL77, 10-21
- Parallel port, 2-4, 5-3

- PCI / AT format PCBs
 - Expansion, 10-8
- Period of warranty, 13-2
- Peripherals, 5-5
 - Connecting, 5-5
- Pixel, 1-5
 - Faulty pixel, 1-5
- PLC, A-7
- Plug and play, A-9
- Plus sign, 8-6
- Port
 - Front ports, 5-2
 - USB port, 5-2
- Ports, 2-1, 2-4, 13-3
 - Ethernet, 2-4
 - Keyboard, 2-4
 - Mouse, 2-4
 - Parallel, 5-3
 - Parallel port, 2-4
 - PROFIBUS, 2-4
 - RJ45 Ethernet, 5-3
 - Serial port, 2-4
 - USB, 2-4, 5-3, 13-3
 - VGA, 2-3, 5-3
- Ports
 - Serial, 13-3
- POST, 11-1
- Power consumption, 13-2
- Power supply, 2-3, 5-7, 5-8, 10-19
 - 120 AC 230 V ..., 5-7
 - 120 V, 5-8
 - 230 V, 5-8
 - Canada, 5-7
 - Connecting, 5-7
 - IEC power connector, 5-4
 - installation, 10-19
 - remove, 10-19
 - USA, 5-7
- Preface, i
- Processor, 2-3, 13-3
- Product key, 3-3
- PROFIBUS, 2-4, 9-1
 - Integration, 9-1
 - Ports, 2-4
- Protection class, 13-2
- PS/2 port
 - Interfaces, 5-3
 - Ports, 2-4
- Purpose of this manual, i

R

- Radiation, 1-3

- High frequency radiation, 1-3
- RAM, 13-3, A-8
- RAM expansion, 2-3
- Range of validity, i
- Recovery CD, A-9
- Relative humidity, 13-4
- remove, 10-19
 - Power supply, 10-19
- Repairs, 10-1
- Replacement parts, 10-30
- Representatives, iv
- Resolution, 13-2
- Restarting, 10-26
- Restore CD, 10-27, A-9
- Restore CD, 10-28
- RJ45 Ethernet
 - Ports, 5-3
- ROM memory, A-9

S

- Safety, 13-2
- Safety Information, 1-1, 1-2, 10-2
- Safety requirement, 13-2
- Scope of maintenance, 10-1
- Screw mounting, 4-1
- Screws, 4-1
- Scrolling, 8-7
- Securing, 4-1
 - Securing with clamps, 4-1
 - Securing with screws, 4-1
- Securing with clamps, 4-1
- Self test, 6-2, 7-2
- Self-test, 11-1
- Sensor, 4-1, 5-6, 6-1, 10-1, 10-21, 10-23
 - Caring, 10-1
 - Commissioning, 6-1
 - Connecting, 5-6
 - installation, 4-1, 10-23
 - Separating, 10-21
 - USB device, 5-6
- Separating, 10-21
 - Sensor, 10-21
- Serial port, 2-4, 5-3
- Service
 - In the Internet, iv
- Service pack, 6-6
- Setting, 7-3
 - EELY Touch software, 7-3
 - Touch screen, 7-3
- Shipping, A-5
 - ESD, A-5
- Shock load, 13-4

- Sicherheitshinweise, A-1
- Signs, 8-6
 - Entering, 8-6
- SIMATIC S7, 9-1
 - Integration, 9-1
- Slot, 2-3
- Soft Power key, 8-1
- Softkey, 8-3, 8-8
 - Labeling, 8-8
- Softkey row, 8-8
- Software, 1-4, 10-28
- Software components, 6-3
 - Additional software components, 6-3
- Special characters, 8-6
 - Entering, 8-6
- State on delivery, 10-28
- Steel slot cover, 10-9, 10-10
- Supply voltage, 13-2
- Support
 - In the Internet, iv
- Switch off, 7-2
 - Device, 7-2
- System partition, 10-28
- System resources, 14-2
 - Interrupt assignment, 14-2
- SystemGuard, 7-5

T

- Technical Support, v
- Temperature change, 13-4
- Temperature limit, 13-4
- Toggling, 8-5
 - Toggling between lowercase and uppercase letters, 8-5
- Tools, 10-2
- Touch screen
 - Special features, 7-4
- Touch screen, 7-3, 7-4, 8-10, 13-2
 - Inadvertent operation, 7-4
 - Operating, 8-10
 - Setting, 7-3
- Touch screen front, 8-9
- TouchInputPC, 7-6
- Trademark, iii
- Training center, iv
- Transport, 1-3
- Troubleshooting/FAQs, 12-1
- Type of fixation, 3-5

U

- Uninterruptible power supply, 5-9

- Selection criteria, 5-9
- Updates, 1-4
- Upper case letter, 8-5
 - Toggling to lower case letter, 8-5
- USA, 5-7
- USB, 2-4, 5-6, 13-3
 - Interfaces, 5-3
 - Ports, 2-4, 5-3
 - Specifications, 13-3
- USB mouse, 8-9
- USB port, 5-2, 8-2, 8-9

V

- V.24 interface, A-9
- VGA, 2-3, 5-3
 - Ports, 2-3, 5-3

W

- Warranty, 1-1
- Weight, 13-2
- Writing down, 3-3
 - Identification data, 3-3