

SIEMENS

SIMATIC

Industrial PC SIMATIC IPC427C

Operating Instructions

<u>Introduction</u>	1
<u>Safety Instructions</u>	2
<u>Description</u>	3
<u>Application planning</u>	4
<u>Installing/mounting</u>	5
<u>Connecting</u>	6
<u>Commissioning</u>	7
<u>Integration into an Automation System</u>	8
<u>Functions</u>	9
<u>Expansions and Configurations</u>	10
<u>Maintenance and Service</u>	11
<u>Alarm, error and system messages</u>	12
<u>Troubleshooting/FAQs</u>	13
<u>Technical specifications</u>	14
<u>Dimension drawings</u>	15
<u>Detailed descriptions</u>	16
<u>Appendix</u>	A
<u>ESD guidelines</u>	B
<u>List of abbreviations</u>	C

Legal information

Warning notice system

This manual contains notices you have to observe in order to ensure your personal safety, as well as to prevent damage to property. The notices referring to your personal safety are highlighted in the manual by a safety alert symbol, notices referring only to property damage have no safety alert symbol. These notices shown below are graded according to the degree of danger.

⚠ DANGER
indicates that death or severe personal injury will result if proper precautions are not taken.
⚠ WARNING
indicates that death or severe personal injury may result if proper precautions are not taken.
⚠ CAUTION
with a safety alert symbol, indicates that minor personal injury can result if proper precautions are not taken.
CAUTION
without a safety alert symbol, indicates that property damage can result if proper precautions are not taken.
NOTICE
indicates that an unintended result or situation can occur if the corresponding information is not taken into account.

If more than one degree of danger is present, the warning notice representing the highest degree of danger will be used. A notice warning of injury to persons with a safety alert symbol may also include a warning relating to property damage.

Qualified Personnel

The product/system described in this documentation may be operated only by **personnel qualified** for the specific task in accordance with the relevant documentation for the specific task, in particular its warning notices and safety instructions. Qualified personnel are those who, based on their training and experience, are capable of identifying risks and avoiding potential hazards when working with these products/systems.

Proper use of Siemens products

Note the following:

⚠ WARNING
Siemens products may only be used for the applications described in the catalog and in the relevant technical documentation. If products and components from other manufacturers are used, these must be recommended or approved by Siemens. Proper transport, storage, installation, assembly, commissioning, operation and maintenance are required to ensure that the products operate safely and without any problems. The permissible ambient conditions must be adhered to. The information in the relevant documentation must be observed.

Trademarks

All names identified by ® are registered trademarks of the Siemens AG. The remaining trademarks in this publication may be trademarks whose use by third parties for their own purposes could violate the rights of the owner.

Disclaimer of Liability

We have reviewed the contents of this publication to ensure consistency with the hardware and software described. Since variance cannot be precluded entirely, we cannot guarantee full consistency. However, the information in this publication is reviewed regularly and any necessary corrections are included in subsequent editions.

Table of contents

1	Introduction	9
1.1	Preface.....	9
1.2	Guideline to the Operating Instructions	10
2	Safety Instructions	11
2.1	General safety instructions	11
3	Description	13
3.1	Overview	13
3.2	Applications.....	13
3.3	Features	14
3.4	Windows Embedded Standard 2009	16
3.5	Windows Embedded Standard 7	18
3.6	Design	19
3.6.1	External Design.....	19
3.6.2	Connection components	20
3.6.3	Operator controls	22
3.6.4	Status displays.....	23
4	Application planning	25
4.1	Transport.....	25
4.2	Unpacking and checking the delivery unit	25
4.3	Ambient and Environmental Conditions.....	27
5	Installing/mounting	29
5.1	Permitted mounting positions.....	29
5.2	Mounting information	31
5.3	Mounting the device.....	31
5.4	Mounting on DIN rails	31
5.5	Mounting with mounting brackets	33
5.6	Upright mounting.....	35
6	Connecting	37
6.1	Connecting peripheral equipment.....	37
6.2	Connecting the 24 V DC power supply.....	38
6.3	Protective ground connection	39
6.4	USB strain-relief.....	40
6.5	PROFINET strain relief	41

7	Commissioning	43
7.1	Note before commissioning.....	43
7.2	Commissioning - Windows Embedded Standard	44
7.2.1	Basic commissioning - initial startup	44
7.2.2	Setting up the language selection in Windows Embedded Standard 2009	45
7.2.3	Language selection in Windows Embedded Standard 7	46
7.3	Commissioning - Windows XP Professional / Windows 7 Ultimate	47
7.3.1	Basic commissioning - initial startup	47
7.3.2	Setting up language selection in Windows XP Professional / Windows 7 Ultimate.....	49
7.4	Windows XP, Windows 7 Security Center	49
7.5	Commissioning - other operating systems.....	50
7.5.1	Commissioning - guide.....	50
8	Integration into an Automation System	51
8.1	Overview	51
8.2	PROFINET	52
9	Functions	55
9.1	Monitoring Functions.....	55
9.1.1	Introduction	55
9.1.2	Temperature monitoring/display	55
9.1.3	Watchdog (WD).....	56
9.2	Enhanced Write Filter (EWF)	57
9.3	File Based Write Filter (FBWF)	59
9.4	HAL tool.....	60
9.5	SRAM buffer memory.....	61
9.6	Battery monitoring	61
9.7	Operation without monitor and keyboard.....	61
10	Expansions and Configurations	63
10.1	Open the device (front panel)	63
10.2	Memory expansion.....	64
10.2.1	Installing the memory module	64
10.3	Installing PCI-104 / PC/104 Plus modules	66
10.3.1	Notes on the modules	66
10.3.2	Mounting PCI-104 or PC/104 Plus modules	66
10.4	Installing/Removing Compact Flash Cards.....	69
10.4.1	Installation options for Compact Flash cards.....	69
10.4.2	Installing/removing an accessible Compact Flash card	70
10.4.3	Installing/removing a built-in Compact Flash card	73
11	Maintenance and Service	75
11.1	Removing and Installing Hardware Components.....	75
11.1.1	Repairs.....	75
11.1.2	Preventive maintenance.....	76
11.1.3	Replacing hard disk or SSD drive	76
11.1.4	Replace the backup battery	78

11.2	Reinstalling the operating system	80
11.2.1	Windows Embedded Standard	80
11.2.1.1	General installation procedure	80
11.2.1.2	Restoring the software to factory state using the Restore DVD	80
11.2.2	Windows XP Professional	81
11.2.2.1	General installation procedure	81
11.2.2.2	Restoring the software to delivery state using the Restore CD/DVD	82
11.2.2.3	Setting up the operating system via the Recovery DVD	83
11.2.3	Recovery of Windows 7	85
11.3	Partitioning data media	88
11.3.1	Setting up the partitions under Windows Embedded Standard 2009	88
11.3.2	Setting up the partitions in Windows Embedded Standard 7	89
11.3.3	Setting up the partitions under Windows XP Professional	90
11.3.4	Setting up the partitions in Windows 7 Ultimate	91
11.3.5	Adapting partitions in Windows 7 and Windows Embedded Standard 7	92
11.4	Installing drivers and software	93
11.4.1	Installing drivers for Windows Embedded Standard	93
11.4.2	Installing drivers and software	93
11.5	Installing updates	94
11.5.1	Updating the operating system	94
11.5.2	Installing or updating application programs and drivers	94
11.5.3	Performing a BIOS update	95
11.6	Data backup	95
11.6.1	Creating an image	95
11.7	CP 1616 onboard	95
12	Alarm, error and system messages	97
12.1	Boot error messages	97
13	Troubleshooting/FAQs	99
13.1	General problems	99
13.2	Problems when using modules of third-party manufacturers	100
14	Technical specifications	101
14.1	General specifications	101
14.2	Power requirements of the components	105
14.3	Integrated DC power supply	105
15	Dimension drawings	107
15.1	Overview of the dimensional drawings	107
15.2	Dimension drawings of the device	108
15.3	Dimension drawings of the device with mounting brackets	109
15.4	Dimensional drawings of the device with vertical mounting angles	111
15.5	Dimensional drawings of the device with expansion frames	112
15.6	Dimension drawing of the blanking plate	113

16	Detailed descriptions	115
16.1	Internal components.....	115
16.1.1	Overview of internal components.....	115
16.1.2	Technical features of the motherboard	116
16.1.3	External ports	116
16.1.3.1	Overview	116
16.1.3.2	COM1/2.....	117
16.1.3.3	DVI-I	117
16.1.3.4	Ethernet.....	118
16.1.3.5	USB.....	119
16.1.3.6	PROFIBUS.....	119
16.1.3.7	PROFINET	120
16.1.3.8	CAN bus	121
16.1.4	Internal ports	121
16.1.4.1	Overview	121
16.1.4.2	Compact Flash card interface	122
16.1.4.3	PCI-104 or PC/104-Plus interface (PCI part)	122
16.2	BIOS Setup	123
16.2.1	Overview	123
16.2.2	Starting BIOS Setup.....	124
16.2.3	BIOS Setup menus	125
16.2.4	Main menu.....	126
16.2.5	Advanced Menu	132
16.2.6	Security menu	135
16.2.7	Boot menu	136
16.2.8	Version menu	139
16.2.9	Exit Menu	140
16.2.10	Default BIOS Setup entries	141
16.3	System resources	143
16.3.1	Currently allocated system resources.....	143
16.3.2	System resources used by the BIOS/DOS	143
16.3.2.1	PCI Interrupt Lines	143
16.4	I/O Address Areas.....	145
16.4.1	Overview of the internal module registers.....	145
16.4.2	Watchdog enable register / 066h select register (read/write, address 062h)	145
16.4.3	Watchdog trigger register (read only, address 066h)	146
16.4.4	CAN base address register (write only, address 066h)	146
16.4.5	Output register user LED L1/L2 (read/write, address 404Eh).....	147
16.4.6	Battery status tab (read-only, address 50Fh).....	148
16.4.7	SRAM address register.....	148
16.5	CP 1616 onboard communications processor	149
16.5.1	Introduction	149
16.5.1.1	Network connections.....	149
16.5.1.2	Typical Communication Partners	149
16.5.2	Firmware Loader	151
16.5.2.1	Loading firmware.....	151
16.5.3	Further actions in STEP 7/NCM PC.....	153
A	Appendix.....	155
A.1	Guidelines and declarations.....	155
A.2	Certificates and approvals.....	156
A.3	Service and support	157

B	ESD guidelines	159
	B.1 ESD Guidelines.....	159
C	List of abbreviations.....	161
	C.1 Abbreviations	161
	Glossary	167
	Index.....	179

Introduction

1.1 Preface

Objective of this documentation

These operating instructions contain all the information you need for commissioning and operation of the SIMATIC IPC427C.

It is intended both for programming and testing personnel who commission the device and connect it with other units (automation systems, programming devices), as well as for service and maintenance personnel who install add-ons or carry out fault/error analyses.

Basic knowledge requirements

A solid background in personal computers and Microsoft operating systems is required to understand this manual. General knowledge in the field automation control engineering is recommended.

Scope of validity of this document

The operating instructions are valid for all supplied variants of SIMATIC IPC427C and describe the delivery state as of October 2010.

Position in the information landscape

The documentation for the SIMATIC IPC427C includes the following sections:

- SIMATIC IPC427C, Operating Instructions (Compact)
- SIMATIC IPC427C, Operating Instructions

The documentation is supplied in German and English with the device in electronic form as a PDF file on the "Documentation and Drivers" CD/DVD.

Conventions

The term "PC" or "device" is sometimes used to refer to the SIMATIC IPC427C product in this documentation. The abbreviation "CP" stands for CP 1616 onboard.

History

Currently released versions of this operating manual:

Edition	Comment
04/2009	First edition
08/2009	Variants with PROFINET
10/2010	Variants with Windows 7 Ultimate / Windows Embedded Standard 7

1.2 Guideline to the Operating Instructions

Contents format	Table of Contents
Contents	Organization of the documentation, including the index of pages and chapters
Introduction	Purpose, layout and description of the important topics.
Safety instructions	Refers to all the valid technical safety aspects which have to be adhered to while installing, commissioning and operating the product/system in and in reference to statutory regulations.
Description	Fields of application, the features and the structure of the product/system
Application planning	Aspects of storage, transport, environmental and EMC conditions to be considered in the preparatory stage
Mounting	Product installation options and installation instructions
Connecting	Options of connecting the product and connection instructions
Commissioning	Commissioning the product/system.
Integration	Options of integrating the product into existing or planned system environments/networks
Functions	Monitoring and display functions
Expansions / configurations	Procedure for installing expansion devices (memory, modules).
Maintenance and service	Replacement of hardware components, restoring and setup of the operating system, installation of drivers and software
Alarm, error and system messages	Error messages from booting
Troubleshooting	Problems, cause, remedy
Technical specifications	General specifications in compliance with relevant standards and current/voltage values
Dimension drawings	Dimensions of the device and of modules
Detailed descriptions	Structure, function and features of vital components, distribution of system resources and use of the BIOS Setup routine
Appendix	Guidelines and certifications, service and support, notes on retrofitting.
ESD guidelines	General ESD guidelines.

Safety Instructions

2

2.1 General safety instructions

 CAUTION
Please observe the safety instructions on the back of the cover sheet of this documentation. You should not expand your device unless you have read the relevant safety instructions.

This device is compliant with the relevant safety measures to IEC, EN, VDE, UL, and CSA. If you have questions about the validity of the installation in the planned environment, please contact your service representative.

Repairs

Only authorized personnel are permitted to repair the device.

 WARNING
Unauthorized opening of and improper repairs to the device may result in substantial damage to equipment or endanger the user.

System expansions

Only install system expansion devices designed for this device. The installation of other expansions can damage the system and violate the radio-interference suppression regulations. Contact your technical support team or where you purchased your PC to find out which system expansion devices may safely be installed.

CAUTION
If you install or exchange system expansions and damage your device, the warranty becomes void.

Battery

This device is equipped with a Lithium battery. Batteries may only be replaced by qualified personnel.

⚠ CAUTION

There is the risk of an explosion if the battery is not replaced as directed. Replace the battery only with the same type or with an equivalent type recommended by the manufacturer. Dispose of used batteries in accordance with local regulations.

⚠ WARNING

Risk of explosion and release of harmful substances!

For this reason, do not burn lithium batteries, do not solder on the cell body, do not open, do not short circuit, do not reverse polarity, do not heat above 100°C, dispose of correctly, and protect against direct sunlight, dampness and dew.

ESD directives

Modules containing electrostatic sensitive devices (ESDs) can be identified by the following label:



Strictly follow the guidelines mentioned below when handling modules which are sensitive to ESD:

- Always discharge your body's static electricity before handling modules that are sensitive to ESD (for example, by touching a grounded object).
- All devices and tools must be free of static charge.
- Always pull the mains connector and disconnect the battery before installing or removing modules which are sensitive to ESD.
- Handle modules fitted with ESDs only by their edges.
- Do not touch any connector pins or conductors on modules containing ESDs.

Description

3.1 Overview

The SIMATIC IPC427C provides high-level industrial performance.

- Compact design
- Maintenance-free operation
- High degree of ruggedness

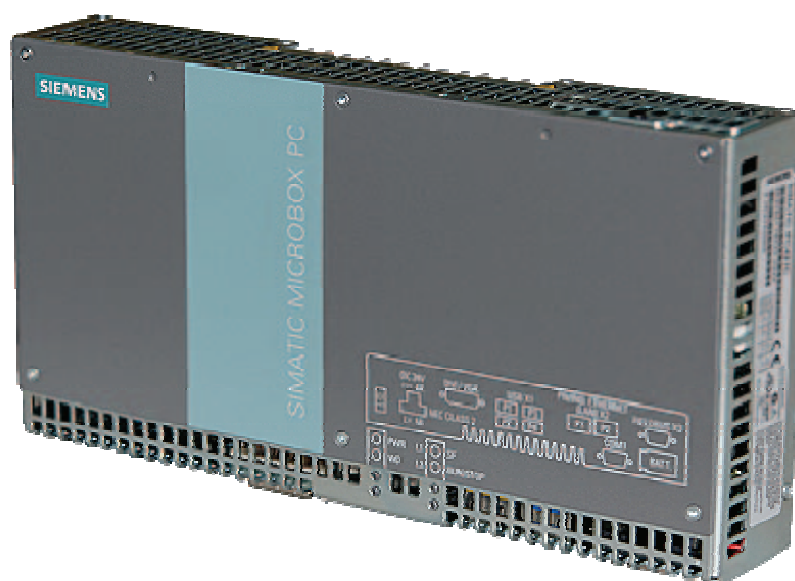

Figure 3-1 SIMATIC IPC427C

3.2 Applications

The device provides industrial PC systems for high-performance and space-saving applications in particular in the field of machine, systems and switchgear cabinet engineering:

- Measuring and controlling of process and machine data (for example, automated washing systems, assembling machines, packaging machines)
- Operating and visualization tasks with separate display / monitor solutions (information terminals, large-scale displays in automotive production)
- Data logging and processing (for example, system data logging, distributed process control)

3.3 Features

Basic data	
Installation / mounting	<ul style="list-style-type: none"> • Installation on a DIN rail • Wall mounting • Vertical mounting • Hanging assembly
Processor	<ul style="list-style-type: none"> • Intel Celeron M 1.2 GHz, 800 MHz FSB, 1 MB SLC or • Intel Pentium Core 2 Solo 1.2 GHz, 800 MHz FSB, 3 MB SLC or • Intel Pentium Core 2 Duo 1.2 GHz, 800 MHz FSB, 3 MB SLC
Main memory	<ul style="list-style-type: none"> • 512 MB DDR3-SDRAM SODIMM • 1 GB DDR3-SDRAM SODIMM • 2 GB DDR3-SDRAM SODIMM • 4 GB DDR3-SDRAM SODIMM
Free slots for expansion	Up to 3 x PCI/104 modules or 3x PC/104- <i>Plus</i> module (PCI bus only); installed with expansion frame
Graphics	<ul style="list-style-type: none"> • Integrated Intel GMA4500 graphics • CRT resolution of 640x480 pixels up to 1920x1200 pixels • DVI resolution of 640x480 pixels up to 1920x1200 pixels • 32 to 256 MB graphics memory is taken from main memory (dynamic UMA)
Power supply	24 VDC (19.2 to 28.8 V) max. 4 A
Conditions of use	<ul style="list-style-type: none"> • Operation without fan
Drives and storage media	
CompactFlash card	<ul style="list-style-type: none"> • 256 MByte optional or • 2 GB optional or • 4 GB optional or • 8 GB optional
Hard disk	≥ 80 GB SATA HD 2.5" optional
SSD (Solid State Disk)	≥ 32 GB optional
Floppy/CD-ROM drive	Connected via external USB port
USB stick	Connected via external USB port
Ports	
Serial	COM1 (RS232) COM2 (RS232); optional
Graphics	DVI-I: combined DVI and VGA
USB	4 x USB 2.0 high current
Ethernet	2 x RJ 45 (10/100/1000 Mbit/s) or 1x RJ 45 (10/100/1000 Mbit/s) for PROFINET variants
PROFIBUS DP	12 Mbps (electrically isolated, compatible to CP 5611), optional

Basic data	
PROFINET	3 x RJ 45 (10/100 Mbit/s), CP 1616 onboard; optional
CAN interface	Optional
Keyboard, mouse	Connected via external USB port

Monitoring and safety functions	
Temperature	<ul style="list-style-type: none"> When permitted temperature range is exceeded Warnings can be analyzed by application program (local, via LAN)
Watchdog	<ul style="list-style-type: none"> Monitoring function for program execution Restart can be parameterized in the event of a fault Warnings can be analyzed by application program (local, via LAN)
LED display	4 LEDs (or 5 for PROFINET variants) for displaying system states 2 of these can be programmed by the user ¹
Transient voltage interruption	Up to 15 ms buffer time at full load
Buffer memory	2 MB battery-buffered SRAM ¹

Software	
Operating systems	
Available	<ul style="list-style-type: none"> Without Windows Embedded Standard 2009 Windows Embedded Standard 7 (32-bit) Windows XP Professional MUI SP3 preinstalled² Windows 7 Ultimate MUI², (32 bit)
Project-specific	<ul style="list-style-type: none"> LINUX QNX VxWorks Others on request RMOS V3.50 (can be ordered separately)

¹ For additional information about addressing the LEDs or the SRAM under a Windows operating system, refer to section Output register user LED L1/L2 (read/write, address 404Eh) (Page 147). Example programs for addressing the LEDs on Windows operating systems and on RMOS3 are available on the FAQ pages at Siemens Customer Support Industry Automation and Drive Technologies - Homepage (<http://www.siemens.com/automation/service&support>).

² MUI: Multi Language User Interface; 5 languages (English, German, French, Spanish, Italian)

The following additional languages can be installed from the Operating System Recovery DVD:

Language	Windows XP	Windows 7
German	X	X
English		X
French	X	X
Italian	X	X
Spanish	X	X
Japanese	X	X
Chinese (Hong Kong)	X	X
Chinese (simplified)	X	X
Chinese (Taiwan)		X
Korean	X	
Russian	X	X

3.4 Windows Embedded Standard 2009

The supplied Windows Embedded Standard has the product version 2009. The overview shows the basic device functions under Windows Embedded Standard 2009:

Function	Version HDD / SSD	CompactFlash card version
Enhanced Write Filter (EWF)	In RAM RAM(REG)	In RAM RAM(REG)
SIMATIC IPC DiagBase	Available V1.2	Available V1.2
Pagefile	Deactivated in favor of the EWF	Deactivated in favor of the EWF
System Restore Core	Deactivated in favor of the EWF	Deactivated in favor of the EWF
File based Writefilter (FBWF)	Available	Available
Registryfilter	Available	Available
Device Update Agent (DUA)	Available	Available
HORM	Available	Available
Telnet Server	Available	Available
Windows Backup	Available	Available
User Mode Driver Framework (UMDF)	Available	Available
MUI	GER/FRA/ITA/SPA Default language: English	GER default language: English
Administrator Account	Available	Available
User Account	Available	Available
Explorer Shell	Available	Available
Internet Explorer (IE)	Available, IE7	Available, IE7
Internet Information Server (IIS)	Available V5.1	Available V5.1
Terminal Services	Available	Available
Bluetooth	Available	Available

Function	Version HDD / SSD	CompactFlash card version
Wireless Network Support	Available	Available
Windows Firewall	Available	Available
Windows Security Center	Available	Available
MSN Explorer	Available	Not available
Outlook Express	Available	Available
Administrative Tools	Available	Available
SMS Advanced Client	Available	Not available
Remote Desktop	Available V6.0	Available V6.0
Remote Assistance	Available	Available
.NET Framework	Available, V3.5	Not available
ASP.NET	Available, V3.5	Not available
Windows .NET Messenger	Available V4.7	Available V4.7
Code pages/User Location/Keyboard	Available	Selection available
Disk Management Services	Available	Available
Windows Installer Service	Available V3.1	Available V3.1
Class Installer	Available	Available
CoDevice Installer	Available	Available
Windows Movie Maker	Available V 2.1	Not available
Media Player	Available, V11.0	Available, V11.0
Windows Media Player Tour	Available	Not available
DirectX	V9.0c	V9.0c
Accessories	Available	Available
Help files for all components	Available	Not available
Games	Available	Not available
Fonts	316	118
Windows XP Tour	Available	Not available
Microsoft Silverlight	Available V 1.0	Available V 1.0
NetMeeting	Available V 3.1	Available V 3.1

Note

Activation of "HORM" and creation of a "Hiber File"

When "HORM" is activated, the "Hibernate" function can be used for Windows Embedded Standard 2009:

- EWFmgr C: /activatehorm

"Hibernate" is activated following a restart. The system then always boots from this file.

3.5 Windows Embedded Standard 7

The overview shows the most important device functions under Windows Embedded Standard 7:

Function	Version HDD / SSD	Compact Flash card version
.Net Framework	Available, V3.5	Available, V3.5
Accessories	Available	Available
Aero background	Available	Available
Backup and Restore	Available	Available
Bluetooth	Available	Available
Dialog box filter	Available	Available
DirectX and Windows Device Experience	Available, V11	Available, V11
Domain services	Available	Available
Driver database	Available	Not available
Driver frameworks	Available	Available
Encrypted File System (EFS)	Available	Available
Enhanced Write Filter	Available	Available
Fax and Scan	Available	Available
File Based Write Filter (FBWF)	Available	Available
Fonts	134	48
Help and Support Engine	Available	Available
Hibernate Once Resume Many (HORM-EEF)	Available	Available
Image Mastering API V2	Available	Available
IME Base Components	Available	Available
Internet Explorer	Available, IE 8	Available, IE 8
Internet Information Server (IIS)	Available, V7.0	Available, V7.0
Language (Standard)	English ¹⁾	English ¹⁾
Mobility Center	Available	Available
Network and Sharing Center	Available	Available
Network Diagnostics	Available	Available
Pagefile	Available	Available
Printing Utilities and Management	Available	Available
Registry Filter	Available	Available
Remote Assistance	Available	Available
Remote Client	Available	Available
Remote Desktop	Available	Available
SIMATIC IPC DiagBase	Available, V1.4	Available, V1.4
Speech	Available	Not available
System Management Administrative Tools	Available	Available
Telnet Server	Available	Available
User Account Control	Available	Available

Function	Version HDD / SSD	Compact Flash card version
Windows Explorer Shell	Available	Available
Windows Firewall	Available	Available
Windows Installer	Available	Available
Windows Media Player	Available, V12	Available, V12
Windows PowerShell 2.0	Available	Available
Windows Search and Natural Language 6	Available	Available
Windows Security Center	Available	Available
Windows Update	Available	Available
Wireless Networking	Available	Available

1) Please note the license terms for Windows Embedded Standard 7.

See also

Language selection in Windows Embedded Standard 7 (Page 46)

3.6 Design

3.6.1 External Design

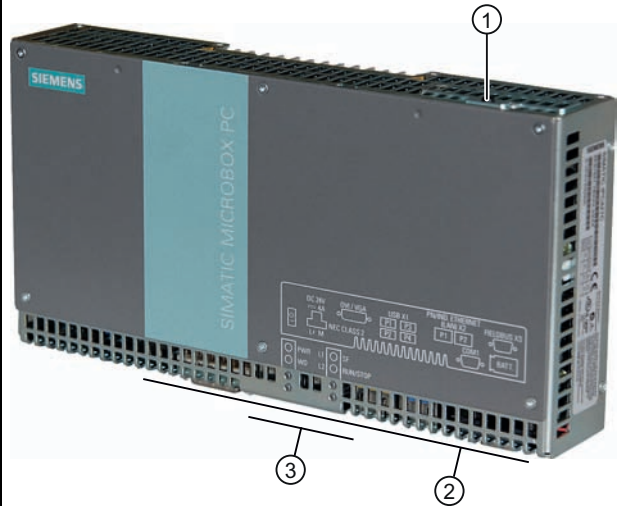
Device components	Pos	Description
	①	Cover plate for Compact Flash module
	②	Connection elements
	③	Status displays

3.6.2 Connection components

Ports and power supply

Location of connection elements (version with PROFIBUS or CAN)		
Pos	Designation	Description
①	24 VDC	Connection for a 24 V DC power supply
②	DVI/VGA	DVI/VGA connection for CRT or LCD monitor with DVI interface
③	USB	4 USB 2.0 connections, high-speed / low current
④	PN/IND. ETHERNET	RJ45 Ethernet connection 1 (exclusive PCI interrupt) for 10/100/1000 Mbps
⑤	PN/IND. ETHERNET	RJ45 Ethernet connection 2 (shared PCI interrupt) for 10/100/1000 Mbps (not for PROFINET versions)
⑥	PROFIBUS DP/MPI CAN fieldbus	PROFIBUS DP/MPI interface (RS 485 electrically isolated), 9-pin D-Sub socket or CAN field bus (optional; not for PROFINET variants)
⑦	COM1	Serial port (RS232) 9-pin D-Sub connector
⑧	USB strain-relief fastener	The USB strain relief must be fastened to the device enclosure with an oval-head screw (M4 thread). The USB cables can be fastened to the strain-relief assembly with a cable tie.
⑨	PE terminal	The PE terminal (M4 thread) must be connected to the protective ground conductor of the plant, in which the device is to be installed. The minimum conductor cross-section may not be less than 2,5 mm ² .

Location of the connection elements (second COM interface)

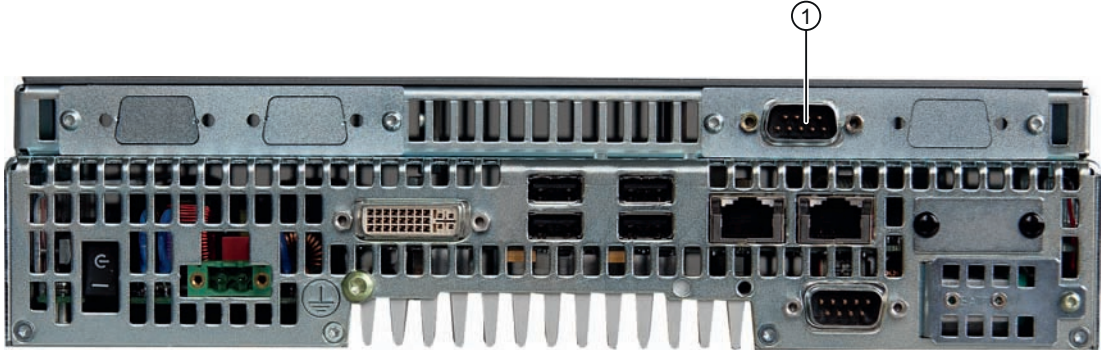

Item	Designation	Description
①	COM2	Serial port (RS232) 9-pin D-Sub connector

Location of connection elements (version with PROFINET)



Item	Designation	Description
⑥	PROFINET	CP 1616 onboard interface, three RJ45 jacks (optional product version)

3.6.3 Operator controls

On/Off switch

⚠ CAUTION

The On/Off switch does not disconnect the device from the supply voltage.

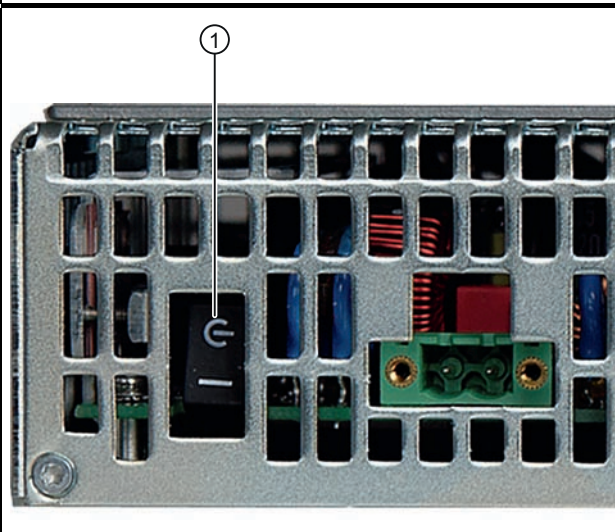
Position of on/off switch	Pos	Description
	<p>①</p>	<p>The on/off switch turns off the output voltages of the power supply but not disconnect from the supply system.</p> <p>The delivery condition is: On/Off switch turned off.</p>

3.6.4 Status displays

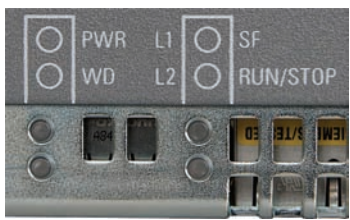
Status displays	LED	Meaning	LED	Description
	PWR	Power supply	OFF GREEN	Standby mode Supply voltage available
	WD	Watchdog status display	OFF GREEN RED	Watchdog disabled Watchdog enabled, monitoring time not expired Watchdog enabled, monitoring time expired
	L1	User LED L1	OFF YELLOW RED	Can be controlled by user programs ¹
	SF	Group errors	RED	Can be controlled by controller program (e.g. WinAC) ¹
	L2	User LED L2	OFF YELLOW GREEN	Can be controlled by user programs ¹
	RUN/STOP	RUN STOP	GREEN YELLOW	Can be controlled by controller program (e.g. WinAC) ¹

¹ For additional information about addressing the LEDs or the SRAM under a Windows operating system, refer to section Output register user LED L1/L2 (read/write, address 404Eh) (Page 147). Example programs for addressing the LEDs on Windows operating systems and on RMOS are available on the FAQ pages at Siemens Customer Support Industry Automation and Drive Technologies - Homepage (<http://www.siemens.com/automation/service&support>).

PROFINET status display (additional display for PROFINET variants)

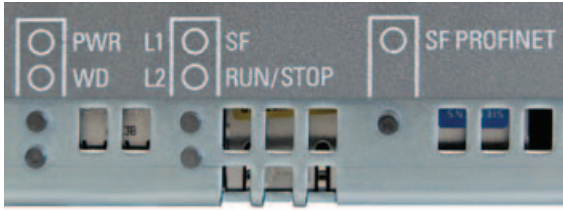
PROFINET status display			
			
LED	Meaning	LED	Description
SF PROFINET	Status display for CP 1616 onboard	OFF	<ul style="list-style-type: none"> CP not available CP disabled No error, communication established Charging in progress
		RED: Flashes slowly	<ul style="list-style-type: none"> Link status error I/O controller: I/O device cannot be addressed I/O controller: Redundant IP address
		RED: Flashes rapidly	Exception error: diagnostics via Web or SNMP is no longer possible
		RED	<ul style="list-style-type: none"> Diagnostics information available No communication established.

Virtual status displays			
The two "virtual" CP 1616 LEDs are only visible in the SIMATIC software and can be read via SNMP.			
PROFINET	Virtual LEDs	RUN	CP is active
		STOP	CP is in the stop state
		Flashes	The states "flashes slowly" or "flashes rapidly" do not exist.

Application planning

4.1 Transport

Despite the device's rugged design, its internal components are sensitive to severe vibrations or shock. You must therefore protect the device from severe mechanical stress when transporting it.

You should always use the **original packaging** for shipping and transporting the device.

CAUTION
Risk of damage to the device!
If you are transporting the device in extreme weather conditions with large fluctuations in temperature, care must be taken to ensure that no moisture forms on or in the device (condensation).
If condensation has developed on the device, wait at least 12 hours before you switch it on.

4.2 Unpacking and checking the delivery unit

Unpacking the device

Note the following when unpacking the unit:

- It is advisable not to dispose of the original packing material. Keep it in case you have to transport the unit again.
- Please keep the documentation in a safe place. It is required for initial commissioning and is part of the device.
- Check the delivery unit for any visible transport damage.
- Verify that the shipment contains the complete unit and your separately ordered accessories. Please inform your local dealer of any disagreements or transport damages.

Noting the device identification data

The device can be identified uniquely with the help of these numbers in case of repairs or theft.

Enter the data in the following table:

Serial number	S VP ...
Order number of the device	6ES 7647-7B ...
Microsoft Windows Product Key	
Ethernet address 1	
Ethernet address 2 (not for PROFINET versions)	
CP 1616 onboard MAC Address Layer 2 (only for PROFINET variants)	
CP 1616 onboard MAC address PROFINET (only for PROFINET variants)	

You can find the corresponding data here:

- Serial number: The serial number is available on the rating plate on the right side of the device.



- Order number of the device: The order number is located on the rating plate.
- Ethernet address: The Ethernet address of the device is available in your BIOS Setup (**F2 function key**) under **Main > Hardware Options**
- Microsoft Windows "Product Key" from the "Certificate of Authenticity" (COA): The COA label is attached only to the rear panel of devices with pre-installed Windows Embedded Standard 2009, Windows Embedded Standard 7, Windows XP Professional, or Windows 7 Ultimate.

Examples for COA-Labels

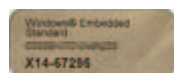

Figure 4-1 COA label for Windows Embedded Standard 2009 and Windows Embedded Standard 7

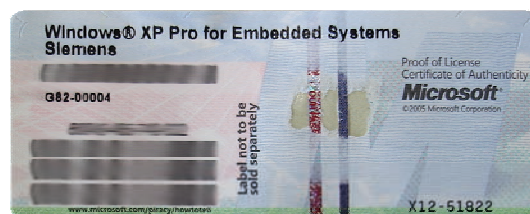

Figure 4-2 COA label for Windows XP Pro for Embedded Systems

4.3 Ambient and Environmental Conditions



When you plan your project, you should make allowances for:

- The climatic and mechanical environmental conditions specified in the specifications given in your operating instructions.
- The device is approved for operation in closed rooms only.
- Avoid extreme ambient conditions. Protect the device against dust, moisture and heat.
- Do not place the device in direct sunlight.
- Ensure that the distance to other components or the sides of cabinets is at least 50 mm above and 100 mm below the device.
- Do not cover the ventilation slots of the device.
- Always observe the mounting positions permitted for this device.
- The connected or installed I/O must not generate a reverse voltage greater than 0.5 V in the device.



Installing/mounting

5.1 Permitted mounting positions

NOTICE
<p>The device is approved for operation in closed rooms only.</p> <p>Ensure that there is a minimum clearance to the other components or the walls of a housing:</p> <ul style="list-style-type: none"> • Below at least 100 mm • Above at least 50 mm

Horizontal (preferred position)	Permitted temperatures
	<p>Operation with hard disk:</p> <ul style="list-style-type: none"> • with up to 3 expansion modules (max. load 9 W): +5 to +40°C <p>Operation with CompactFlash card and/or SSD drive:</p> <ul style="list-style-type: none"> • with up to 3 expansion modules (max. load 9 W): 0 to +45°C • with up to 3 expansion modules (max. load 9 W) in RAL: 0 to +50°C <p>Operation with Compact Flash cards:</p> <ul style="list-style-type: none"> • without expansion modules in RAL: 0 to +55°C
Vertical (power supply at the top)	
	<p>Operation with hard disk:</p> <ul style="list-style-type: none"> • with up to 3 expansion modules (max. load 9 W): +5 to +40°C <p>With installed Compact Flash card:</p> <ul style="list-style-type: none"> • without expansion modules: 0 to +45°C <p>Operation with CompactFlash card and/or SSD drive:</p> <ul style="list-style-type: none"> • with up to 3 expansion modules (max. load 9 W) in RAL: 0 to +45°C <p>Operation with Compact Flash cards:</p> <ul style="list-style-type: none"> • with up to 3 expansion modules (max. load 9 W) in RAL: 0 to +50°C <p>Notes:</p> <p>When mounted on a DIN rail, the device should be secured to prevent shifting (e.g. with a DIN rail ground terminal).</p>

5.1 Permitted mounting positions

<p>Suspended</p> 	<p>Operation with CompactFlash card and/or SSD drive and without expansion modules: 0 to +40°C</p> <p>Note: Mounting brackets are required if the device is suspended.</p>
<p>Upright mounting</p> 	<p>Permitted temperatures</p> <p>Operation with hard disk:</p> <ul style="list-style-type: none"> with up to 3 expansion modules (max. load 9 W): +5 to +40°C <p>Operation with CompactFlash card:</p> <ul style="list-style-type: none"> Without expansion modules: 0 to +45°C <p>Operation with CompactFlash card and/or SSD:</p> <ul style="list-style-type: none"> with up to 3 expansion modules (max. load 9 W) in RAL: 0 to +45°C <p>Operation with Compact Flash cards:</p> <ul style="list-style-type: none"> with up to 3 expansion modules (max. load 9 W) in RAL: 0 to +50°C

RAL = Restricted Access Location
(e.g. installation of the unit in a lockable cabinet)

<p>NOTICE</p> <p>The safety and installation instructions for the expansion modules should be followed if the device is expanded with PCI-104 / PC/104-plus modules.</p> <p>If necessary, the device should be installed in an enclosure that meets the requirements of paragraphs 4.6 and 4.7.3 of IEC/UL/EN/DINEN60950-1.</p>
--

5.2 Mounting information

Before you install the device, read the following mounting instructions.

NOTICE

Adhere to the SIMATIC assembly guidelines and the relevant DIN/VDE requirements or the country-specific regulations when mounting in switching cabinets.
--

NOTICE

Ensure that the device is classified as "Open Type" when using the device in the area of Industrial Control Equipment (UL508). A UL508 conform enclosure is therefore a mandatory requirement for approval or operation according to UL508.

5.3 Mounting the device

Mounting methods

SIMATIC IPC427C can be mounted on DIN rails, with mounting brackets and in an upright position.

5.4 Mounting on DIN rails

Mounting the device on DIN rails

Note

Use of Siemens 35 mm standard mounting rail is recommended.

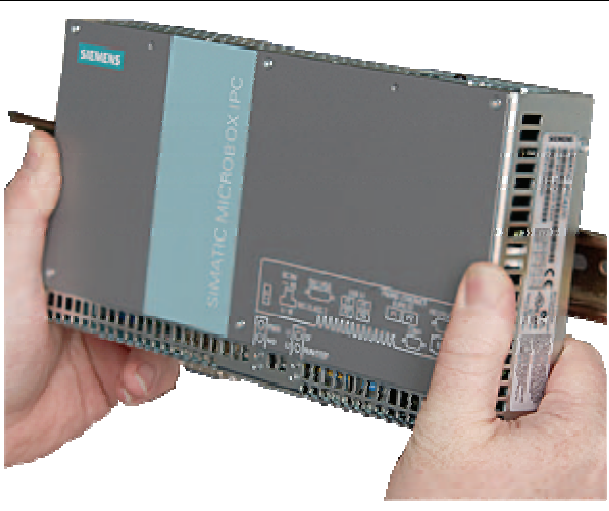
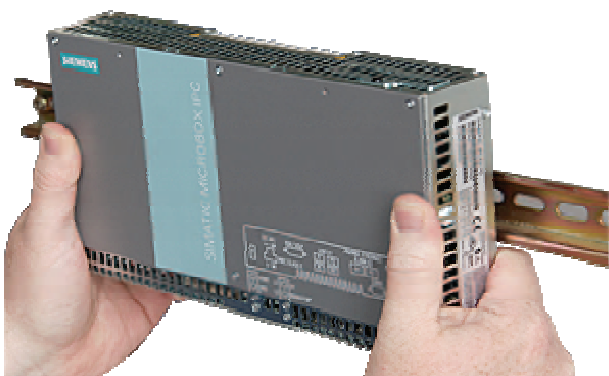
Steps for mounting on DIN rails		
1.	Set the device inclined on the upper DIN rail.	
2.	Swing the device fully onto the rails until both clamps completely latch.	

Note

To ensure secure mounting on vertical mounting rails, a DIN rail ground terminal should be mounted beneath the device.

NOTICE

The rails are secured to a wall or cabinet similar to mounting with mounting brackets. Ensure that the wall or ceiling can hold four times the total weight of the device (including the rails and additional expansion modules). Also see section Mounting with mounting brackets (Page 33).

Removing the device from the DIN rail

- Push down the device until the clamps release it.
- Swing the device out of the rails.

5.5 Mounting with mounting brackets

Removing mounting clamps from the device

Two mounting clamps are factory installed on the device for DIN rail mounting. These need to be removed before mounting the mounting brackets.

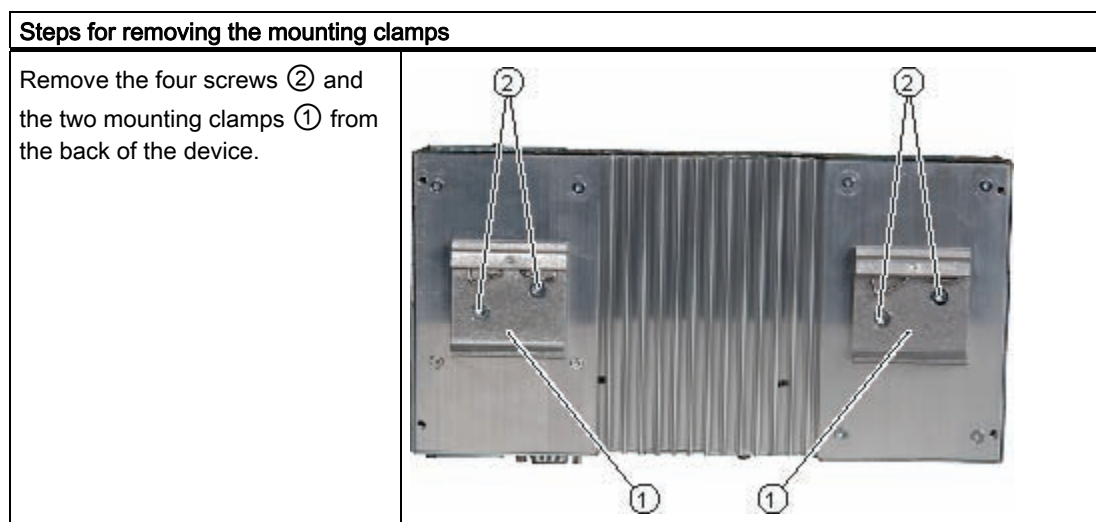

Installing brackets on the device

Two mounting brackets are included in the scope of delivery. They can be installed on the device with four screws supplied.

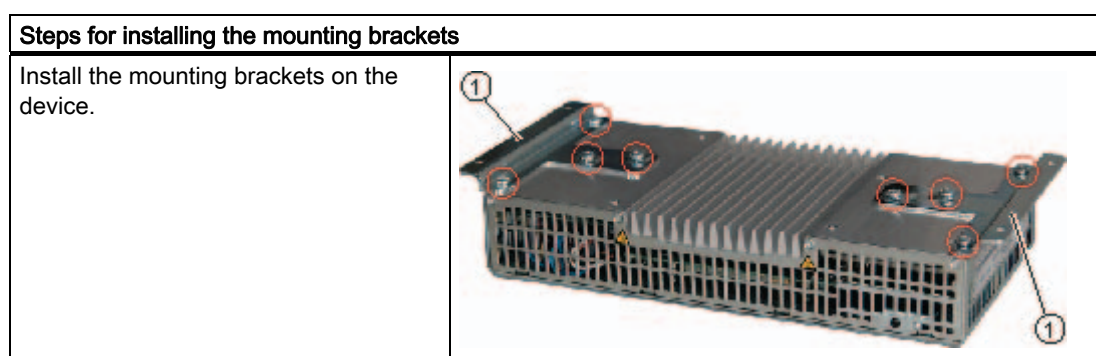

Note

Required tools

You need a TORX T20 screwdriver to remove the mounting clamps and mount the mounting brackets.

Mounting/demounting the device

The dimensions of the device with mounting brackets are listed under Dimension drawings of the device with mounting brackets (Page 109).

Mounting examples		
Material	Bore diameter	Mounting
Concrete	8 mm diameter 60 mm depth	Dowel: 8 mm diameter 50 mm length Screws: 4 mm diameter 50 mm length
Plasterboard (min. 13 mm thick)	14 mm diameter	Gravity toggle: 4 mm diameter 50 mm length
Metal (min. 2 mm thick)	5 mm diameter	Metal screws M 4: 4 mm diameter 15 mm length



WARNING

Ensure that the wall or ceiling can hold four times the total weight of the device (including the cabinet brackets and additional expansion modules).

5.6 Upright mounting

With the available optional vertical mounting kit you have the possibility to implement a place saving installation.

Mounting the vertical mounting bracket onto the device

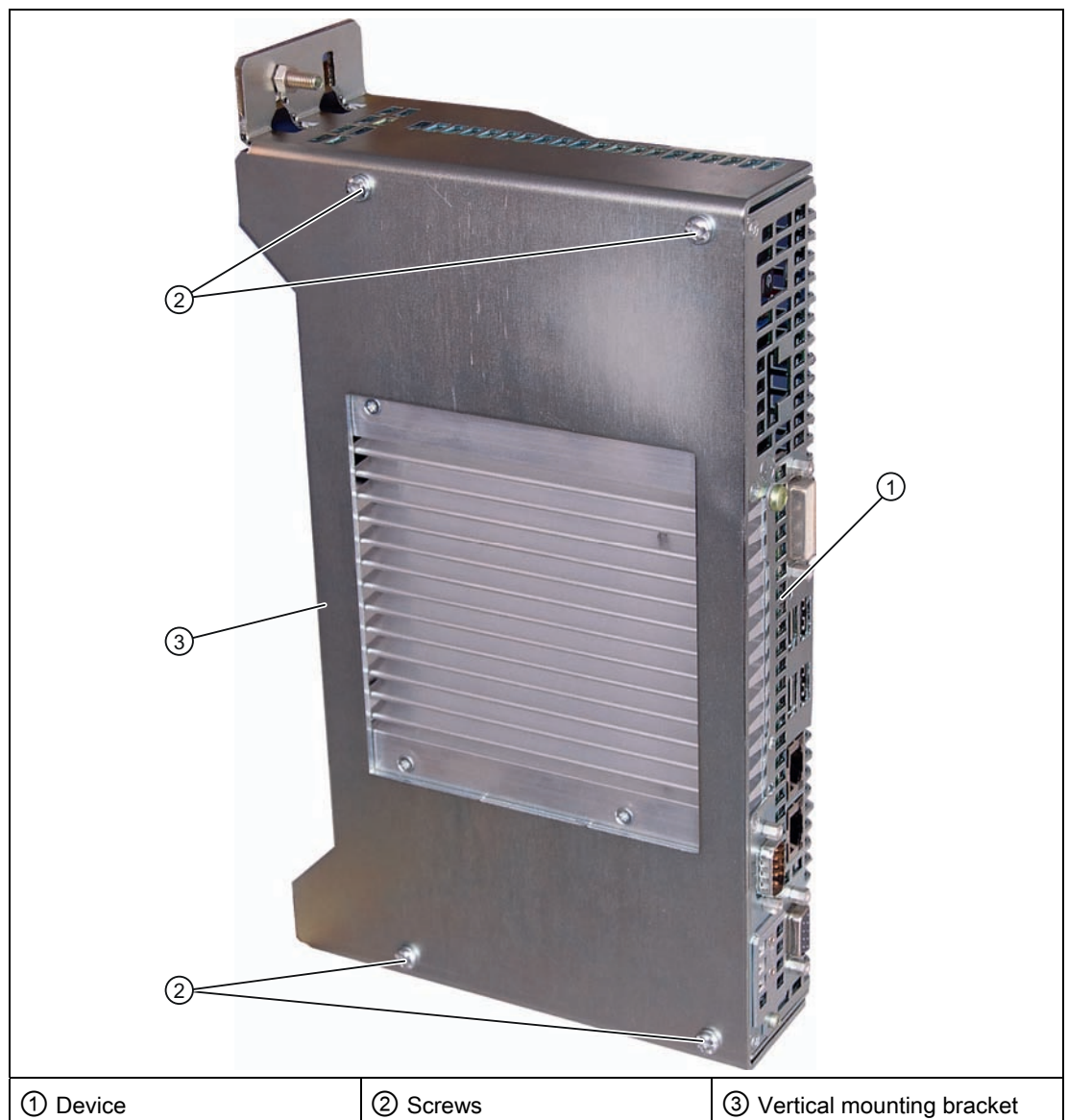

Note

- Information on installation and operation is available in the supplement of the accessories.

6.1 Connecting peripheral equipment

NOTICE

Connect only peripheral devices approved for industrial applications conforming to EN 61000-6-2 / IEC 61000-6-2.
--

Note

Hot-plug peripherals (USB) may be connected while the PC is in operation.

CAUTION

Peripheral devices that are incapable of hot-plugging may only be connected after the device has been disconnected from the power supply.

CAUTION

Strictly adhere to the specifications for peripheral equipment.

Note

A DVI or CRT monitor should be connected and switched on when the device boots in order for it to be correctly detected by the BIOS and the operating system. The screen may otherwise remain dark.

NOTICE

The connected or built-in peripherals, such as USB drives, should not introduce a counter emf into the device.
--

Generation of reverse voltage greater than 0.5 V to ground on + 3.3 VDC / + 5 VDC / + 12 VDC at a connected or installed component can prevent normal operation or destroy components of the device.
--

6.2 Connecting the 24 V DC power supply

To be noted before you connect the device

Note the following in order to operate the device safely and according to regulation:

<p>⚠ WARNING</p> <p>The device should only be connected to a 24V DC power supply which satisfies the requirements of safe extra low voltage (SELV).</p> <p>If the device is used on a wall, in an open rack or other similar locations, an NEC Class 2 current source is required in order to meet the UL requirements (UL 60950-1). In all other cases (IEC / EN / DIN EN 60950-1) either a current source of limited output (LPS = Low Power Source), or a line-side fuse or a line-side circuit breaker is necessary. The power needs to be limited to a value below 4.16 A. The fuse value required: Max. 4 A.</p> <p>Use the special plug supplied to connect the supply voltage. Connect the PE conductors as described in the next section.</p>

<p>NOTICE</p> <p>The permitted cable cross-section for the 24 VDC connection is 0.75 mm² to 2.5 mm².</p>

<p>NOTICE</p> <p>If a CompactFlash card is used in the device, make sure that the card is seated correctly before you connect it.</p>
--

Connecting

Steps for connecting the device to the 24 V DC power supply	
1.	Switch off the 24 V DC power source.
2.	Connect the power supply using the plug (included in the scope of delivery).
3.	Connect the PE conductor.

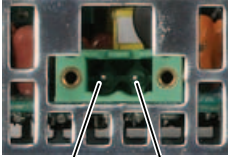

(P24 in) (M in)

6.3 Protective ground connection

The PE terminal (M4 thread) on the device (large surface, large-area contact) must be connected to the PE conductor on the cabinet or system in which the PC is to be installed. The conductor cross-section must not be less than 2.5 mm².

The PE terminal is needed to protect the device and ensures that interference signals generated by external power cables, signal cables or cables to the I/O modules are safely discharged to earth.

Required tool for protective earth terminal: TORX T20 screwdriver

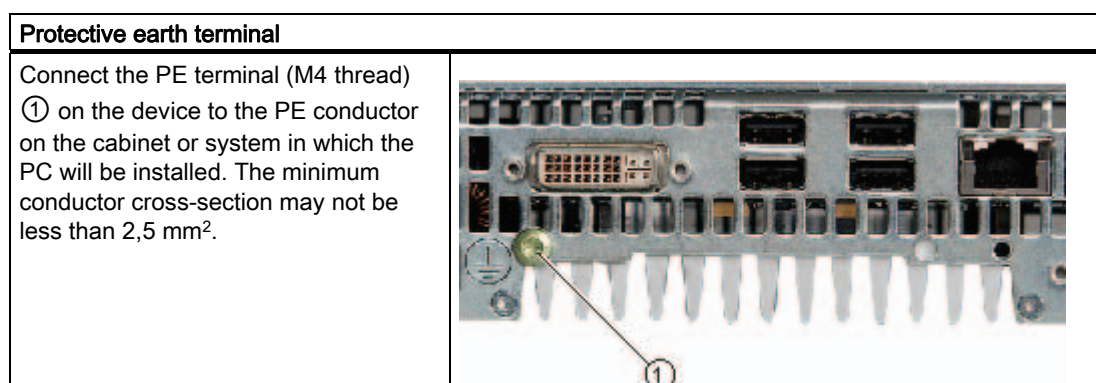

6.4 USB strain-relief

The USB strain-relief provided as an accessory is used to prevent accidental loosening of the USB cable from the device. A cable binder (not included in the package) is needed to use this accessory.

To fix the USB strain relief, you will need a TORX T20 screwdriver.

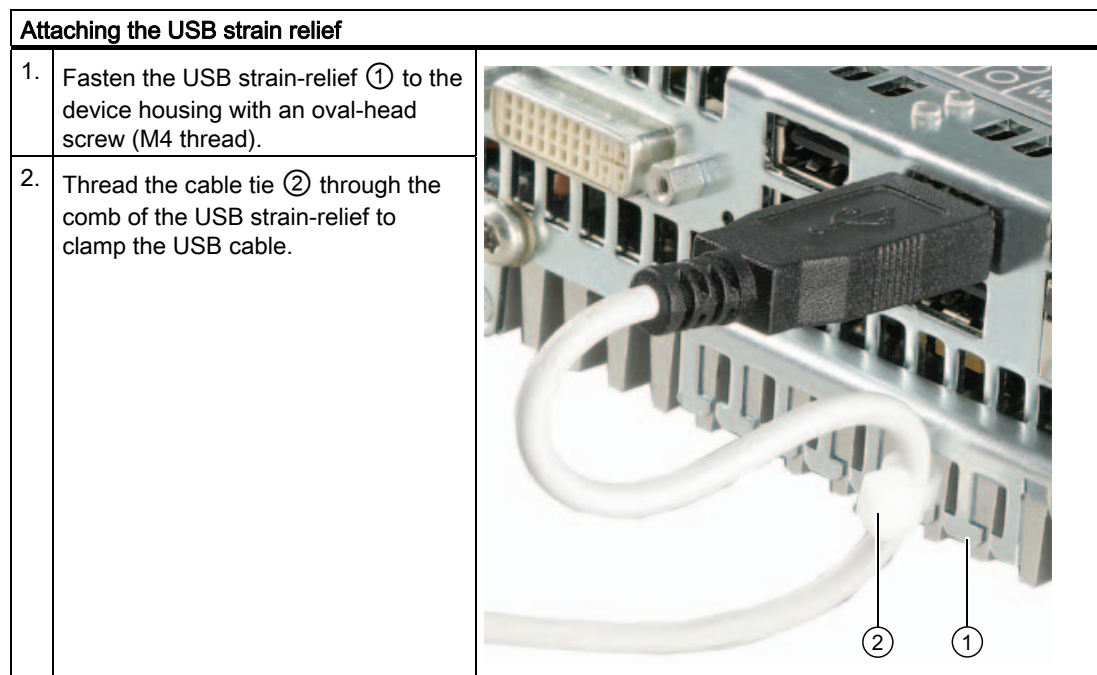

6.5 PROFINET strain relief

The PROFINET strain relief provided in the package is used to prevent accidental loosening of the cable from the device. One cable tie (not included in the scope of delivery) is required for each interface.

To fix the PROFINET strain relief, you will need a TORX T10 screwdriver.

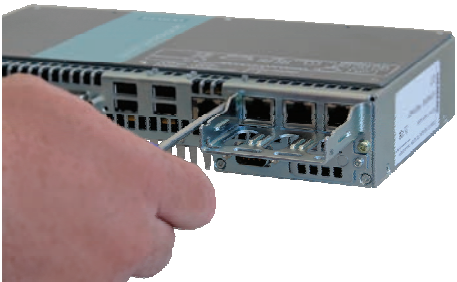
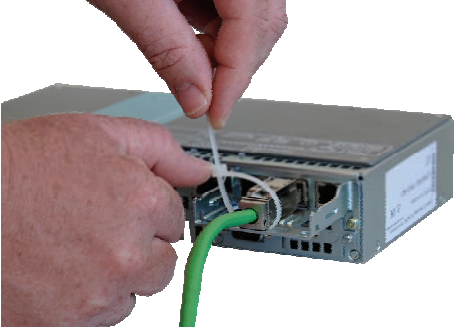
Attaching the PROFINET strain relief		
1	Attach the PROFINET strain relief.	
2	Attach the cable using the cable tie.	

Commissioning

7

7.1 Note before commissioning

Factory state

The SIMATIC IPC427C is available in the following versions:

- With Windows Embedded Standard 2009 or Windows Embedded Standard 7 operating system (pre-installed on CompactFlash card, SSD, or hard disk)
- With Windows XP Professional or Windows 7 Ultimate operating system (pre-installed on SSD or hard disk)
- Without operating system

Connections before commissioning

Before connecting the device to the power supply, a DVI or CRT monitor should be connected in order for it to be correctly detected by the BIOS and the operating system during startup.

 CAUTION
--

Risk of damage to the device

If condensation has developed, wait at least 12 hours before commissioning the device.
--

NOTICE

Windows Embedded Standard 2009 / Windows Embedded Standard 7:
--

Read the EWF and FBWF information
--

Two configurable write filters (Enhanced Write Filter and File Based Write Filter) are provided on systems running Windows Embedded Standard 2009 and Windows Embedded Standard 7. Please be aware of this when activating and using the EWF/FBWF information, otherwise you may experience data loss.
--

Note

Setting up CompactFlash cards on the employed device

If you want to use CompactFlash cards with the device, they need to be set up on the device. CompactFlash cards set up on other devices will not boot due to the differing drive parameters.

7.2 Commissioning - Windows Embedded Standard

7.2.1 Basic commissioning - initial startup

Requirements

- The device is connected to the 24 VDC power supply.
- The equipotential bonding lines are wired.
- The connecting cables are properly inserted.

Setting up the operating system

After **initial** power up, the Windows Embedded Standard operating system that is pre-installed on the CompactFlash card, SSD, or hard disk is set up automatically on the computer.

Proceed as follows:

1. Switch on the device using the On/Off switch. The device performs a power on self-test. During the self-test, this message appears:

```
Press F2 go to Setup Utility or  
Press ESC go to Boot Manager
```

2. Wait until this message is cleared, then follow the instructions on the screen.

NOTICE
The device may not be switched off at any time during the installation process. Do not change the defaults in BIOS Setup, otherwise the operating system setup may become corrupted.

3. Restart
After you have entered all the necessary information and the operating system is configured, you are prompted to restart the system. Respond to this prompt with **Yes**.

Note

Initial commissioning of Windows Embedded Standard 2009

System startup can take considerably longer than usual during initial commissioning of Windows Embedded Standard 2009. Only a blue or black screen is displayed for several minutes.

As of now, each time you power up the computer and complete the startup routine, the logon window or user interface of the Windows Embedded Standard operating system is opened immediately.

Note

Once you have completed initial commissioning, you should create an image of your system partition in order to prevent data loss.

Switch off the device.

When you work with Windows Embedded Standard, always shut down the PC with the command **Start > Shut Down**. You can then switch off the device with the power switch or by disconnecting the power supply.

Note

The Enhanced Write Filter should be enabled following the installation of Windows Embedded Standard on a CompactFlash card or SSD. When this is enabled, the device can be switched off with the power switch by disconnecting the power supply.

7.2.2 Setting up the language selection in Windows Embedded Standard 2009

Windows Embedded Standard 2009 offers the option of selecting the menu and dialog languages. You can select the German and English languages.

Setting up the language selection

Windows Embedded Standard 2009 is set up by default with English menu and dialog language and US international keyboard layout. You can change the language in the Control Panel by selecting:

Start > Settings > Control Panel > Regional and Language Options > Languages tab, Language used in menus and dialogs field.

In addition to the menu and dialog language, select **Regional and Language Options** and set the default to **non-Unicode programs** in the **Advanced** section.

7.2.3 Language selection in Windows Embedded Standard 7

Changing languages is possible using the Restore CD/DVD (forms part of the scope of delivery). The CD/DVD contains the required language packages and help for changing the system language.

Note

Note the license terms of Windows Embedded Standard 7

Please note the license terms for Windows Embedded Standard 7 and especially the extended SIEMENS AG Software terms for Windows Embedded Standard 7.

You can find the license terms in the delivered document "MICROSOFT SOFTWARE LICENSE TERMS for Windows Embedded Standard 7(E)" and in the system drive under \Windows\System32\license.rtf.

Change system language

To change the language for Windows Embedded Standard 7, follow these steps:

Prerequisite:

The "Legacy USB Support" option has to be set to "Enabled" in the Advanced menu of the BIOS so that the device can address a USB CD-ROM drive.

1. Connect a USB CD-ROM drive to the device.
2. Insert the Restore CD/DVD in the drive, restart the device and when the BIOS message:
`Press <F2> to enter Setup or <ESC> to show Boot menu`
appears, press the F2 key.
3. Select the Boot menu and move the entry "CD-ROM Drive" to the first position.
4. End the BIOS setup with the "Exit Saving Changes" entry.

5. Follow the on-screen instructions.
6. After selecting the menu dialog language of the Restore CD/DVD, select the menu entry "Select language packages".

Depending on the current language setup, you have the following options in the "Select language packages" menu:

- Display language settings
- Install language
- Change language
- Deinstall the "Non-system language"

Note

The "Install language or Deinstall language" process can take several minutes.

Note

The "Legacy USB Support" option has to be set to "Enabled" in the Advanced menu of the BIOS so that the device can address a USB CD-ROM drive. Additional information is available in the section .

7.3 Commissioning - Windows XP Professional / Windows 7 Ultimate

7.3.1 Basic commissioning - initial startup

Requirements

- The device is connected to the 24 VDC power supply.
- The equipotential bonding lines are wired.
- The connecting cables are properly inserted.

Setting up the operating system

On completion of **initial** power up, the Windows XP Professional or Windows 7 Ultimate operating system that is pre-installed on the hard disk or SSD is set up automatically on the computer.

Proceed as follows:

1. Switch on the device using the On/Off switch. The device performs a power on self-test. During the self-test, this message appears:

```
Press F2 go to Setup Utility or  
Press ESC go to Boot Manager
```

2. Wait until this message is cleared, then follow the instructions on the screen.

NOTICE
The device may not be switched off at any time during the installation process. Do not change the defaults in BIOS Setup, otherwise the operating system setup may become corrupted.

3. Automatic restart

After you have entered all necessary information and the operating system is configured, the PC is automatically restarted and displays the user interface of the operating system.

Note

System startup can take considerably longer than usual for the initial commissioning.

As of now, each time you power up the computer and complete the startup routine, the user interface of the Windows XP Professional / Windows 7 Ultimate operating system is opened immediately.

Note

Once you have completed initial commissioning, you should create an image of your system partition in order to prevent data loss.

Switch off the device.

When working with Windows XP Professional or Windows 7 Ultimate, always select **Start > Turn Off Computer...** to shut down the PC. You can then switch off the device with the power switch or by disconnecting the power supply.

7.3.2 Setting up language selection in Windows XP Professional / Windows 7 Ultimate

The **Multilingual User Interface (MUI)** allows you to change the menu and dialog language.

The English language and US keyboard layout are set up by default for the operating system menus and dialogs. You can change the menu and dialog language as follows:

- On Windows XP Professional:
Start > Control Panel > Regional and Language Options
- On Windows 7:
Start > Control Panel > Regional and Language Options

7.4 Windows XP, Windows 7 Security Center

Warning from the Windows Security Center

A warning from the Windows Security Center appears the first time you switch on your device. The Security Center checks the status of the device in regard to the three important security aspects listed below. If a problem is detected (an outdated antivirus program, for example), the Security Center issues a warning and makes recommendations on how you can better protect the device.

- **Firewall:** The Windows Firewall adds protection to the device by blocking network or Internet access to the device by unauthorized users. Windows checks if the device is protected by a software firewall.
The firewall is enabled by default in the factory state.
- **Antivirus software:** Antivirus programs add protection to the device by searching for and eliminating viruses and other security threats. Windows checks if a full-range, up-to-date antivirus program is running on the device.
No antivirus software is installed in the factory state.
- **Automatic updates:** Using the Automatic Update feature allows Windows to regularly search for the latest critical updates for the device and to install them automatically. This feature is disabled in the factory state.
- **Real-time protection (Windows 7 only):** Windows Defender displays warnings if spyware or possibly unwanted software is installed or executed on the computer. You will also receive a warning if programs attempt to modify important Windows settings.

Configure the Security Center according to your requirements.

7.5 Commissioning - other operating systems

7.5.1 Commissioning - guide

The operating system can be installed on the hard disk, CompactFlash card or SSD. A variety of USB devices (hard disk, external floppy or CD-ROM drive, USB stick) or CompactFlash cards can be used as boot media.

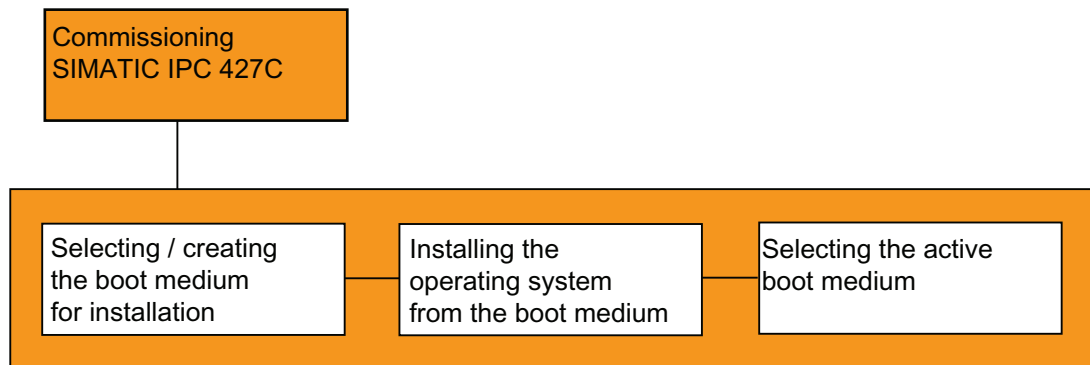

The following provides an overview of the steps involved in commissioning:

Steps	Description
1 Select and create a boot medium for installation.	In the BIOS Setup, select a suitable medium for booting the operating system (CD-ROM drive, CompactFlash card, hard disk or USB device). See Boot menu (Page 136). If no boot medium is available, one must be created based on the instructions provided by the respective operating system documentation. You can use the SIMATIC IPC Image & Partition Creator tool to create a bootable USB stick.
2 Install the operating system on the boot medium.	Install the operating system based on the instructions provided by the respective documentation.
3 Select final boot medium	In the BIOS Setup, select the medium on which the operating system has been installed.

Additional information

Further information about installation and commissioning is available in the documentation of the respective operating system.

Integration into an Automation System

8.1 Overview

Options of integration in existing or planned system environments/networks:

Ethernet

The integrated Ethernet port (10/100/1000 Mbps) can also be used for communication and for data exchange with automation devices such as SIMATIC S7.
For this purpose you require the "SIMATIC NET" software package.

PROFIBUS/MPI

The optional electrically isolated PROFIBUS interface (12 Mbps) can be used to interconnect distributed field devices or for coupling to SIMATIC S7.

The "SOFTNET for PROFIBUS" software package is required for coupling to S7 automation systems.

PROFINET

CP 1616 onboard enables the connection of industrial PCs to Industrial Ethernet. Only one CP 1616 can be installed in a PG/PC. For more information, refer to section PROFINET (Page 52) and to chapter CP 1616 onboard communications processor (Page 149).

Device driver CP 16xx.sys

The device driver supports implementation of the Windows network protocols for the optionally available "CP 1616 onboard" Ethernet PROFINET controller on SIMATIC PCs. When used with this driver, the PROFINET interface behaves in Windows similar to a 100 Mbit Ethernet interface with MAC address. The three RJ45 sockets are interconnected via switch.

The drivers and documentation can be found in the user manual on the supplied Documentation and Drivers CD/DVD.

PROFINET IO application

You can create, operate or configure PROFINET IO applications using the "Development Kit DK-16xx PN IO". It must be installed in addition to the device driver CP 16xx.sys. This kit and the documentation are available free of charge at the following Internet address:

Development Kit DK-16xx PN IO

http://www.automation.siemens.com/net/html_00/produkte/040_cp_1616_devlopkit.htm

SIMATIC NET PC software

You can create, operate and configure SIMATIC installations using this software package. For additional information, refer to the SIMATIC NET Manual Collection CD. The software package and documentation are not included in the scope of delivery.

CAN

CAN interface (optional) for connection to CAN field bus systems.

RS232

The serial port can be used for data communication (via terminal applications, for example).

Additional information

Additional information is available in the catalog and the online ordering system Industrial Automation and Drive Technologies (<http://mall.automation.siemens.com>).

8.2 PROFINET

CP 1616 onboard

The basic characteristics of the PCS 1616 onboard are:

- Optimized for PROFINET IO
- With Ethernet realtime ASIC ERTEC 400
- Three RJ45 sockets for connecting terminal devices or addition network components
- Integrated 3-port real-time switch
- Automatic hardware detection

CAUTION
A maximum of one CP 1616/1604 module can be installed in one PG/PC. If you want to use an additional CP 1616/1604 module, the CP 1616 onboard option must be disabled via the entry "Onboard Profinet" in the BIOS Setup under Advanced > Peripheral Configuration.

Additional documentation on PROFINET

Get an overview of the information available for PROFINET
<http://support.automation.siemens.com/WW/view/en/18880715/133300>).

Document name	What is contained in this document?
This documentation is not included in the scope of delivery:	
Getting Started PROFINET IO Getting Started: Manual Collection	The documents use concrete examples to provide step-by-step instructions on how to commission a fully functional application.
Manual PROFINET System Description	This gives you the basic knowledge about the PROFINET IO topics: Network components, data exchange and communication, PROFINET IO, component-based automation, application example of PROFINET IO and component-based automation.
Manual From PROFIBUS DP to PROFINET IO	Read this document if you want to convert an installed PROFIBUS system to a PROFINET system.
Readme file for CP 1616/CP 1604 and DK-16xx PN IO	This provides the latest information about the SIMATIC NET products CP 1616/CP 1604, CP 1616 onboard, the developer kit.
Configuration Manual Commissioning PC Stations	This provides you will all the information necessary for commissioning and configuring a PC as a PROFINET IO controller or IO device.
Manual SIMATIC NET Industrial Communication with PG/PC: Volume 1 - Basics SIMATIC NET Industrial Communication with PG/PC: Volume 2 - Interfaces	This manual introduces you to industrial communication and explains the available communication protocols. It also describes the OPC interface as an alternative to the IO-based user programming interface.
S7 CPs for Industrial Ethernet Configuring and Commissioning	This provides the following support: - For commissioning S7 stations - For establishing effective communication
Manual SIMATIC NET - Twisted Pair and Fiber-Optic Networks	Configure and build your Industrial Ethernet networks based on this document.
This documentation is part of the supplied Documentation and Drivers CD:	
Operating instructions CP 1616/CP 1604/CP 1616 onboard	This provides you with all information required for operation.
Installation guide Device Driver CP16xx.sys	Read this guide if you want to install the NDIS device driver, CP16xx.sys.

Further information

You can find the information on specific products in the Internet at the address: Product-related Information SIMATIC NET (<http://www.siemens.com/simatic-net>)

Functions

9.1 Monitoring Functions

9.1.1 Introduction

Even in its basic version, the device supports the use of monitoring functions. When used in combination with the appropriate software, the following functions for displaying, monitoring and controlling are available:

- Temperature monitoring (over / under temperature)
- Monitoring of the battery level
- Monitoring of hard disks, CompactFlash cards and SSD drives with S.M.A.R.T. functionality
- Watchdog (hardware or software reset of the computer)
- Operating hours meter (information on the cumulative run time)

SIMATIC IPC DiagBase software

With the SIMATIC IPC DiagBase software (included in the scope of delivery), you can use these functions for local monitoring. You can use the DiagBase Management Explorer application for general monitoring or DiagBase Alarm Manager for notification of individual alarms.

Additional information on the functions of the SIMATIC IPC DiagBase software is available in the online help.

SIMATIC IPC DiagMonitor software

SIMATIC IPC DiagMonitor software is provided on CD (not included in the scope of delivery). It contains the monitoring software, the software for the stations to be monitored and a library for creating custom applications.

9.1.2 Temperature monitoring/display

Temperature monitoring

The temperature is recorded by means of three thermocouples. The sensors monitor the processor temperature, the temperature near the RAM module and the motherboard around the DVI/VGA socket.

If one of the three configured temperature values is exceeded (CPU: 100°C, RAM: 90°C, motherboard: 90°C), the following fault reaction is triggered:

Reaction	Option
The DiagBase or DiagMonitor software is enabled	None

The temperature error is retained in memory until temperatures have fallen below the thresholds and it is reset by one of the following measures:

- Acknowledgment of the error message by the monitoring software
- Restart of the device

9.1.3 Watchdog (WD)

Function

If the user program does not respond to the watchdog within the predetermined monitoring time, the watchdog monitors the program process and informs the user about various reactions.

After POWER ON of the device or after a HW RESET (cold restart), the watchdog is in idle state, i.e. a reaction of the WD will not be triggered and the Watchdog LED is switched off.

Watchdog reactions

If the watchdog is not triggered again within the set time, the following reactions will be triggered:

Reaction	Option
Switch watchdog LED to red	None
Trigger a PC reset	Configurable
DiagBase or DiagMonitor software is enabled	None

Note

If the desired device reset is not performed, go the Advanced menu of the BIOS Setup and set the SafeCard functions to Enabled. Contact Customer Support for a detailed description of the Watchdog functions.

WD monitoring times

The monitoring times are defined as follows:

Normal mode: 94 ms, 210 ms, 340 ms, 460 ms, 590 ms, 710 ms, 840 ms and 960 ms.

Macro mode: 2s, 4s, 6s, 8s, 16s, 32s, 48s and 64s.

Note

The watchdog is retriggered if the monitoring time is changed at the active watchdog (that is while the watchdog is running)!

9.2 Enhanced Write Filter (EWF)

Purpose and function

The EWF (Enhanced Write Filter) is a function that is only available for Windows Embedded operating systems. It provides write protection that can be configured by the user.

The Enhanced Write Filter enables you to boot Windows Embedded Standard from read-only media (e.g. CD-ROM), assign write protection attributes to partitions, and customize file system performance (when using CompactFlash cards, for example).

EWF can be used to minimize write access to CompactFlash cards. This is important because the write cycles on CompactFlash cards are limited due to technical reasons. We therefore recommend using EWF if you work with CompactFlash cards.

CAUTION
Activate only one write filter per partition - otherwise you may incur data loss.
Both EWF and FBWF are preinstalled in the SIMATIC IPC images.
Ensure that only one write filter is enabled on a partition, otherwise you may incur data loss.

Note

In Windows Embedded Standard, the Enhanced Write Filter is disabled by default. After the operating system has been set up, you should back up your data and then enable the EWF.

Set EWF

The EWFmgr.EXE program can be used to install, enable or disable the EWF. Use the command prompt to call up the program. The following functions are available:

Function	Command
Write-protect drive C: Switching on	ewfmgr c: -enable
Write-protect drive C: disable (modified files are accepted)	ewfmgr c: -commitanddisable
Modified files on drive C: Accept	ewfmgr c: -commit

Display information about the EWF drive	<code>ewfmgr c:</code>
Display help	<code>ewfmgr c: /h</code>

Note

The EWF commands affecting the write protection do not become active until after the next booting process.

Note

The EWF command `ewfmgr c: -commitanddisable` cannot be used in combination with the `-live` option (invalid entry, for example: `ewfmgr c: -commitanddisable -live`).

Special features for the use of Enhanced Write Filters (EWF)

- In the event of a power failure, if the EWF is enabled changes made after the boot sequence on drive C: are lost.
To prevent data loss in the event of a power failure, the use of a USV is recommended.
- You can save the files in the EWF RAM overlay to the CompactFlash card or the hard disk before you shut down the device. To do so, enter the following command in the command prompt:

`ewfmgr c: -commitanddisable`

Then restart the system.

`ewfmgr c: -enable`

Then restart the system.

Note

When the system is set to automatically adjust the clock for daylight saving time adjustment, systems without central time management and with activated EWF set the clock forward or backward by one hour in the daylight saving time or standard time period each time the system boots.

The reason for this behavior is that Windows Embedded Standard 2009 has a registry entry that detects if the clock has been adjusted for daylight saving time. Since this file is also protected against modification by the EWF, the marker is lost during the boot sequence and the adjustment is made again.

We therefore recommend that you deactivate the automatic adjustment and change the clock manually.

Procedure:

1. Switch off the EWF filter (`ewfmgr c: -commitanddisable`) and reboot the system.
2. Deactivate automatic adjustment in the Control Panel. In the Time Zone tab opened with the menu command Start > Control Panel > Date and Time, remove the check mark from the "Automatically adjust clock for daylight saving changes" check box.
3. Enable EWF again (`ewfmgr c: -enable`) and reboot the system.

9.3 File Based Write Filter (FBWF)

Purpose and function

With the Feature Pack 2007 for Windows XP Embedded, Microsoft introduced a second write filter, File Based Write Filter (FBWF).

In contrast to EWF, which protects partitions based on sectors, FBWF works on the file level. When FBWF is enabled, all files and folders of a partition are protected unless they are included in an exception list.

FBWF is disabled by factory default in the operating system images for SIMATIC IPC and must be enabled and configured by the user.

When you enable FBWF, the folders C:\FBWF and D:\FBWF are authorized for writing by default.

Comparison between EWF and FBWF

- You should prefer FBWF, because it is more flexible in its configuration and allows immediate writing without rebooting.
- If you use HORM or compressed NTFS, EWF is indispensable.

CAUTION
Activate only one write filter per partition - otherwise you may incur data loss.
Both EWF and FBWF are preinstalled in the SIMATIC IPC images.
Ensure that only one write filter is enabled on a partition, otherwise you may incur data loss.

Configuring FBWF

FBWF can be configured in command console using the program FBWFMGR.EXE.

NOTICE
<ul style="list-style-type: none"> • Observe the following syntax: Enter a space after the drive designation colon. • Changes for direct write access only take effect after rebooting. • Only existing files and folders can be entered in the exception list.

Function	Command
Display the current FBWF status	<code>fbwfmgr /displayconfig</code>
Enable FBWF after the next startup	<code>fbwfmgr /enable</code>
Write to protected files	<code>fbwfmgr /commit c: \Test.txt</code>
Adding/removing elements in the exception list:	
<ul style="list-style-type: none"> • Add file 	<code>fbwfmgr /addexclusion C: \Test.txt</code>
<ul style="list-style-type: none"> • Add folder 	<code>fbwfmgr /addexclusion C: \Test folder</code>

• Remove file	fbwfmgr /removeexclusion C: \Test.txt
• Remove folder	fbwfmgr /removeexclusion C: \Test folder
Call up the help function	fbwfmgr /?

For detailed instructions on FBWF go to ([http://msdn.microsoft.com/en-us/library/aa940926\(WinEmbedded.5\).aspx](http://msdn.microsoft.com/en-us/library/aa940926(WinEmbedded.5).aspx))

9.4 HAL tool

On a SIMATIC IPC with uncore processor, you can use the HAL tool to change from the installed Multiprocessor PC HAL to a Uniprocessor PC HAL. The HAL tool is used in Windows Embedded Standard 2009.

Installation of the HAL tool

1. Unzip the "HAL-Tool.zip" file to a folder.
2. Change to HAL:
 - To change to Multiprocessor PC HAL:
Run "HAL_Multiprocessor.bat"
 - To change to Uniprocessor PC HAL:
Run "HAL_Uniprocessor.bat"
1. Restart the computer.
2. Once again restart the computer when prompted in Windows.

Restoring the original state in Windows Embedded Standard 2009

1. Boot Windows Embedded Standard 2009.
2. Open the folder: C:\Windows\HAL-Backup\original
3. Run the "undo.bat" batch file.
4. Restart Windows Embedded Standard 2009.

Restoring the original state in Windows PE

1. Boot Windows PE (e.g. from the Restore CD/DVD).
2. Open a console window.
3. Open the following folder: C:\Windows\HAL-Backup\original
4. Run the "undo.bat" batch file.
5. Restart Windows Embedded Standard 2009.

9.5 SRAM buffer memory

For applications to be able to store data following a power failure, the motherboard features a battery-buffered CMOS-RAM. If the supply voltage fails longer than 5 ms, this is indicated by the DC FAIL signal.

Enough time is provided for copying data to the buffered RAM that 256 KB can be saved with a full configuration.

A maximum 2048 Kb memory window is displayed via a PCI address register. The base address is initialized by the BIOS.

A corresponding function is implemented there for using the CMOS-RAM under WinAC RTX.

NOTICE

If replacement of the battery takes longer than 30 seconds, the data saved in the CMOS RAM and in the buffered SRAM is lost.
--

9.6 Battery monitoring

The installed buffer battery has a service life of at least 5 years. The status can be checked with two-tier battery monitoring. The information can be read from an I/O register and evaluated.

When the first warning level is reached, the remaining service life of the battery for buffering CMOS data and buffered SRAM is at least 1 month.

9.7 Operation without monitor and keyboard

The device can be operated without a monitor and keyboard. The device startup is guaranteed without these peripherals. A USB keyboard and mouse and an analog CRT monitor can be later connected for diagnostics.

A digital DVI monitor cannot be activated unless the Windows Embedded Standard / Windows XP Professional / Windows 7 Ultimate operating system has completed its boot operation.

Expansions and Configurations

10

10.1 Open the device (front panel).

CAUTION
Work on the open device may only be carried out by authorized and qualified personnel. Within the warranty time, you are only allowed to install expansions for memory and expansion card modules.

 CAUTION
The device contains electronic components which may be destroyed by electrostatic charge.
You therefore need to take precautionary measures before you open the device. Refer to the ESD guidelines on handling electrostatically sensitive components under ESD Guidelines (Page 159).

Tools

- Cover and top cover plate: Torx T8
- Hard disk mounting: Torx T10
- Protective earth terminal: Torx T20
- Spacing bolts PC/104: Hexagon head 5mm

Preparation

Isolate the device from power supply.

Open the device

Steps in opening the device (front panel)	
1	Remove the six screws. 
2	Remove the front panel.

10.2 Memory expansion

10.2.1 Installing the memory module

Memory expansion options

The motherboard is equipped with one slot for an SO-DIMM DDR3 memory module. This lets you expand the memory capacity of your device to a maximum of 4 GB. 3 GB of this memory is available for the operating system and applications.

Note

We recommend using the original spare parts for memory configuration.

Preparation

Disconnect the device from the power supply.

CAUTION

The electronic components on the PCBs are highly sensitive to electrostatic discharge. Always take appropriate precautionary measures when handling these components. Refer to the ESD directives on handling electrostatically sensitive components ESD Guidelines (Page 159).

Removing a memory module

How to remove a memory module

- | | |
|---|--|
| 1 | Open the device. |
| 2 | Open the retention clamps ①. Tilt the memory module forward. |
| 3 | Carefully remove the memory module. |

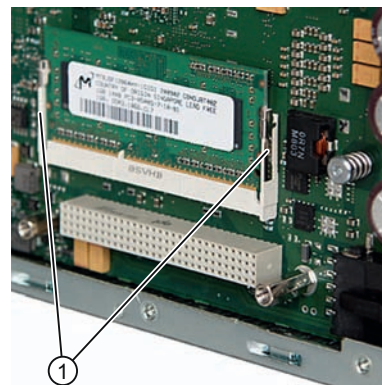

Installing a memory module

How to install a memory module		
1	Set the memory module in the mount tilting forward.	
2	Carefully push the memory module back into the heat sink until it fully engages.	
3	Close the device.	

Display of the current memory configuration

The new memory configuration is detected automatically. System RAM, Extended RAM and Cache SRAM are displayed during device startup.

10.3 Installing PCI-104 / PC/104 Plus modules

10.3.1 Notes on the modules

Notes on module specifications

The device is designed for use with modules conforming to specifications of the PC/104 Consortium.

- PCI-104 modules: PCI compatible (120-pin plug)
- PC/104 *Plus* modules that use only the 120-pin plug (PCI bus)

Note

The necessary expansion frames for mounting these modules can be ordered as a six-pack with order number 6AG4070-0BA00-0XA0 via the A&D online ordering system (<http://www.siemens.com/automation/mall>).

NOTICE

When expanding the device with PCI-104 / PC/104 Plus modules, adhere to the safety and mounting regulations for the expansion modules.

The device may be mounted in an enclosure that meets the requirements of Sections 4.6 and 4.7.3 of IEC/UL/EN/DINEN60950-1.

10.3.2 Mounting PCI-104 or PC/104 Plus modules

Tools

Use hexagon head screws (5 mm) to mount the spacing bolts of the PCI-104- or PC/104-*Plus* module. If this is the only PCI-104 or PC/104-*Plus* module you wish to mount, you can also use screws (M3) instead of the spacing bolts.

Preparation

- Isolate the device from power supply.
- Two blanking plates are mounted on the expansion frame. If the PCI-104 or PC/104-Plus module features external ports, you can use these blinding plates to mount the connectors. You can also use a slot plate with existing connector perforations. You can find required dimensions in the section Dimension drawing of the blanking plate (Page 113).

CAUTION

The electronic components on the PCBs are highly sensitive to electrostatic discharge. Always take appropriate precautionary measures when handling these components. Refer to the ESD directives on handling electrostatically sensitive components ESD Guidelines (Page 159).

Mounting PCI-104 or PC/104-Plus modules

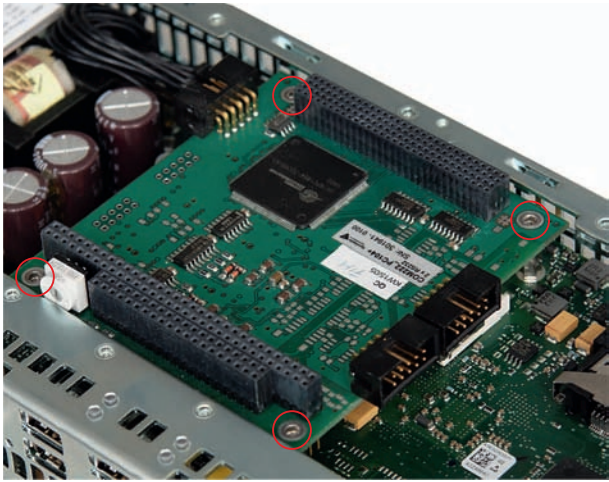
Steps for mounting an expansion module	
1	Open the device (remove front panel).
2	<div style="display: flex; align-items: flex-start;"> <div style="flex: 1;"> <p>Insert module in slot ①.</p> </div> <div style="flex: 2;">  </div> </div>
3	<div style="display: flex; align-items: flex-start;"> <div style="flex: 1;"> <p>Secure the module with four screws or spacing bolts.</p> </div> <div style="flex: 2;">  </div> </div>

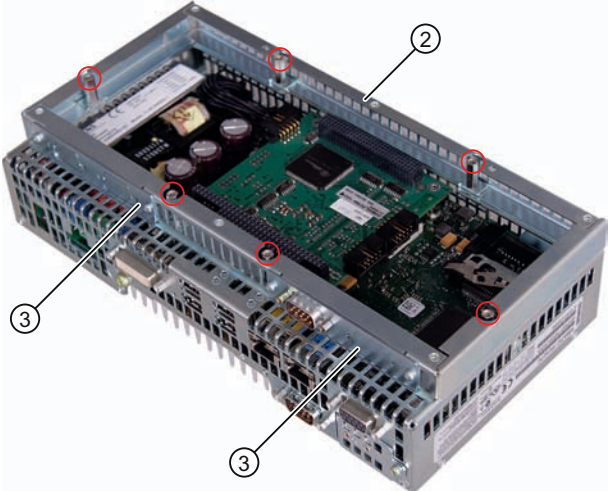
Steps for mounting an expansion module	
<p>4 Mount the expansion frame ② and secure it with six spacing bolts. Mount the slot plates ③.</p>	 A perspective view of the SIMATIC IPC427C expansion frame. The frame is a metal chassis with a green PCB inside. Callout 2 points to the top edge of the frame where six spacing bolts are located. Callout 3 points to the front panel slot plates on the left side of the frame.
<p>5 Mount the front panel on the expansion frame.</p>	

Mounting additional PCI-104 or PC/104-Plus modules

The device can be equipped with a maximum of PCI-104 or PC/104-Plus modules. An additional expansion frame is required for each module.

Follow the mounting procedure described in the previous section (steps 2 to 4).

Configuring/installing a PCI-104 or PC/104-Plus module

You may need to make settings in the BIOS Setup. For detailed information about installation, refer to the manufacturer documentation for the respective module.

10.4 Installing/Removing Compact Flash Cards

10.4.1 Installation options for Compact Flash cards

Memory expansion options

The device features an accessible slot for CompactFlash cards (types I / II). As an alternative to a hard disk, you can optionally order a fixed-mounted, inaccessible CompactFlash card drive.

Only use SIMATIC PC CompactFlash cards for industrial application.

Note

Replace the CompactFlash card only with a card of the same product version.

The device supports only SIMATIC PC CompactFlash cards with product version 02 (ES 02).



Figure 10-1 SIMATIC PC Compact Flash®



Figure 10-2 SIMATIC PC CompactFlash 4GB - rear side with product version ES 02

10.4.2 Installing/removing an accessible Compact Flash card

Preparation

Disconnect the device from the power supply.

⚠ CAUTION

The electronic components on the PCBs are highly sensitive to electrostatic discharge. Always take appropriate precautionary measures when handling these components. Refer to the ESD directives on handling electrostatically sensitive components ESD Guidelines (Page 159).

Opening the module receptacle

Steps for opening the module receptacle

Turn the cover plate ① of the module receptacle 180 degrees counter-clockwise.

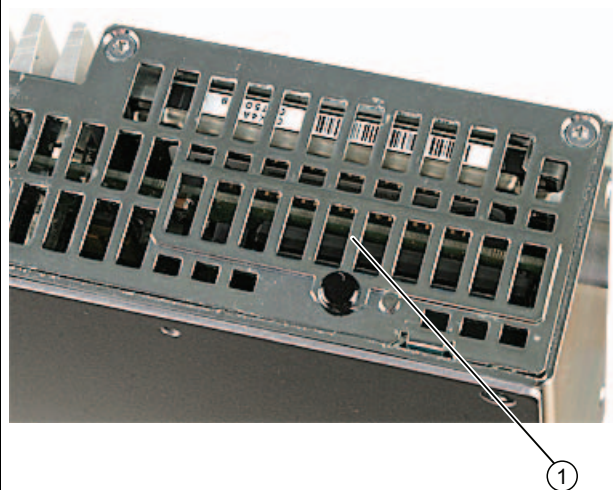

Installing the Compact Flash card

Steps for installing a Compact Flash card	
1	Open the module receptacle.
2	Insert the CompactFlash card with the connector facing in until it locks into place ①.
3	Close the module receptacle again.

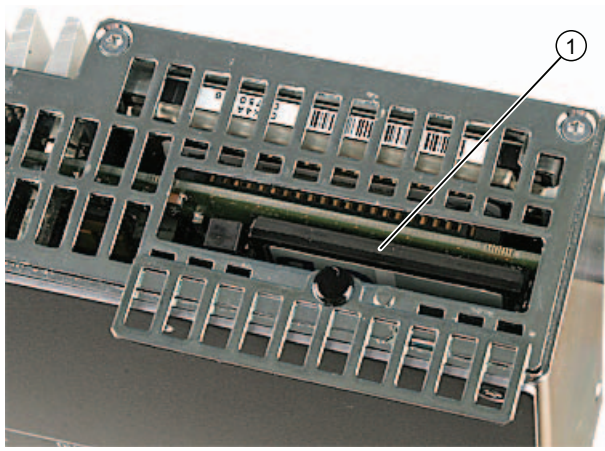

Note

The Compact Flash slot is coded against reversed insertion. Insert it so that its upper side (label side) is facing the front panel of the device.

CAUTION

If the Compact Flash card meets resistance, flip it over. Never insert the CompactFlash card with force.

Removing the Compact Flash card

Steps for removing a Compact Flash card	
1	Open the module receptacle.
2	Press the eject button ① and remove the CompactFlash card.
3	Close the module receptacle again.

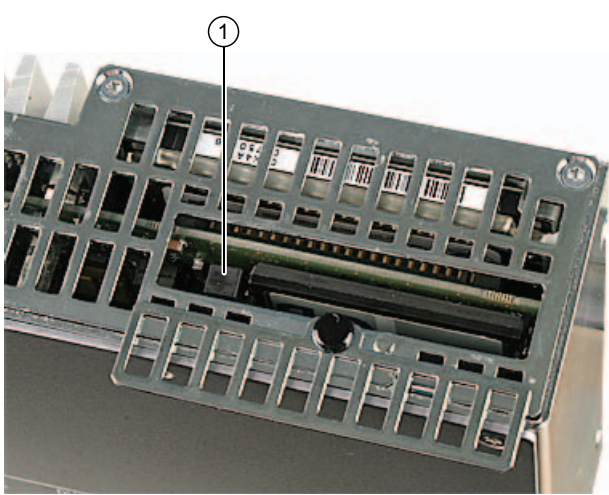

10.4.3 Installing/removing a built-in Compact Flash card

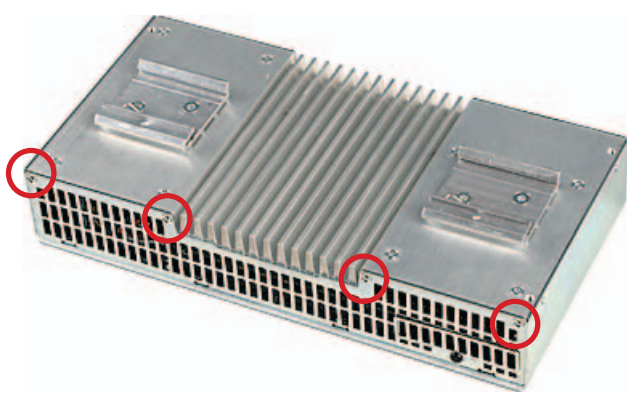
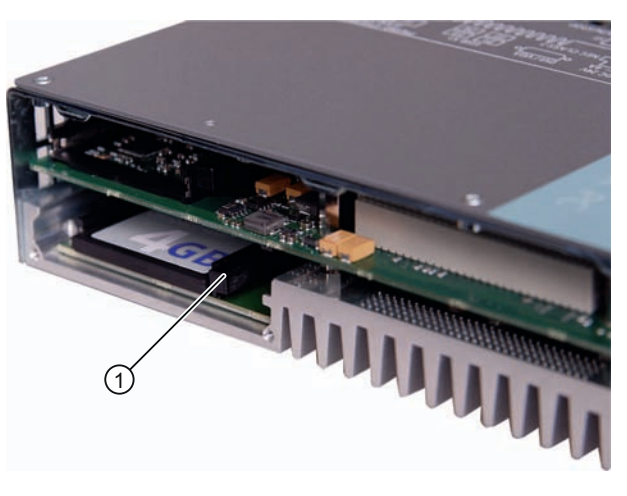
Steps for installing/removing a permanently installed CompactFlash card		
1	Remove the four screws of the cover plate and remove it	
2	Slide the CompactFlash carefully into the slot, or press the ejector ① and remove it carefully from the slot.	
3	Fasten the cover plate again.	

Maintenance and Service

11.1 Removing and Installing Hardware Components

11.1.1 Repairs

Carrying out repairs

Only authorized personnel are permitted to repair the device.

 WARNING
--

Unauthorized opening and improper repairs on the device may result in substantial damage to equipment or endanger the user.
--

- Always separate the device from the mains before opening it.
- Only install system expansion devices designed for this device. If you install other expansion devices, you may damage the device or violate the safety requirements and regulations on RF suppression. Contact your technical support team or where you purchased your PC to find out which system expansion devices may safely be installed.

If you install or exchange system expansions and damage your device, the warranty becomes void.

NOTICE

Check the ESD Guidelines (Page 159).

Limitation of Liability

All specifications and approvals are only valid when the expansion component feature the CE symbol. Observe the installation instructions for the expansion components.

UL approval of the device only applies when the UL-approved components are operated taking the "Conditions of Acceptability" into consideration.

No liability can be accepted for impairment of functions caused by the use of third-party devices or components.

Tools

- Torx T8 (cover and top sheet metal cover)
- Torx T10 (hard disk mounting)
- Torx T20 (Protective earth terminal)
- Hexagon head 5mm (spacing bolts PC/104)

11.1.2 Preventive maintenance

To maintain high system availability, we recommend the preventative exchange of those PC components that are subject to wear. The table below indicates the intervals for this exchange.

Component	Exchange interval:
Hard disk	3 years
CMOS backup battery	5 years

11.1.3 Replacing hard disk or SSD drive

 CAUTION
Drives may only be replaced by authorized qualified personnel.

Tools

You will need size TORX T8 and T10 screwdrivers to mount the hard disk and a 5mm Allen wrench for installing/removing PC/104 modules.



You will need a TORX T20 screwdriver to loosen the protective earth terminal.

Preparation

1. Disconnect the device from the power supply.
2. Unplug all peripherals (mouse, keyboard, monitor, for example) from the device.

Removing drives

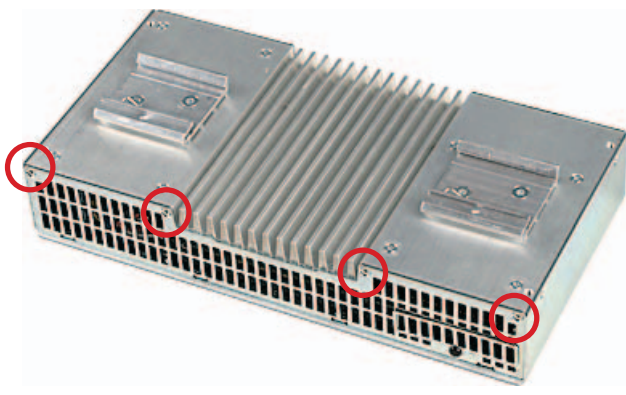
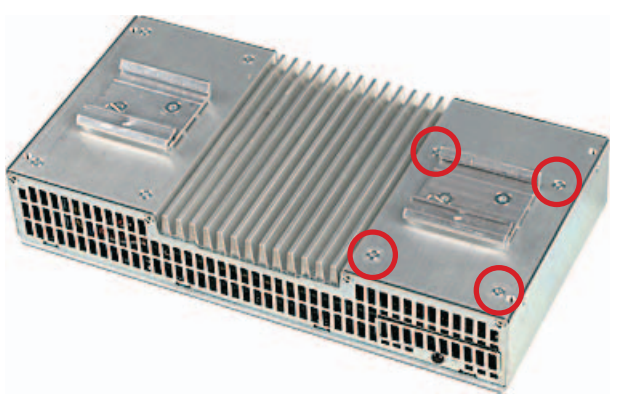
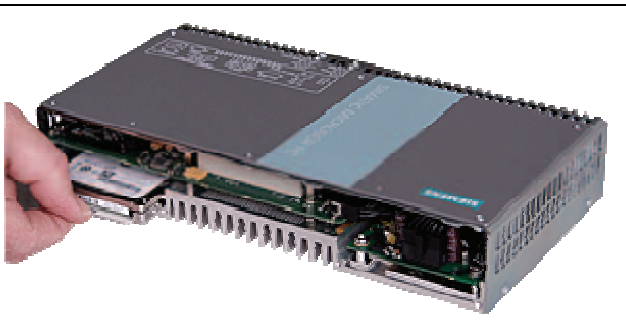
NOTICE
Check the ESD Guidelines (Page 159).

How to remove a drive		
1	Remove the four screws of the cover plate and remove it	
2	Remove the four screws holding the drive to the back of the enclosure.	
3	Carefully remove the drive from the enclosure.	
4	Take the drive out of the holder.	

Installing a drive

Carry out the described tasks in the reverse order.

11.1.4 Replace the backup battery

To be noted before you replace the battery

Note

The service life of a backup battery is approximately 5 - 8 years, depending on the operating conditions.

CAUTION

Risk of damage!

Always replace the lithium battery with an identical type, or with a type recommended by the manufacturer (order no.: A5E00331143).

Disposal

CAUTION

Depleted batteries must be disposed of in accordance with local regulations.
--

Preparation

Note

The configuration data and contents of the SRAM in the device are buffered for at least 30 seconds.

1. Write down the current settings of the BIOS setup or save the settings as a user profile in the Exit menu (Page 140) of the BIOS setup.
A list in which you can note this information is available in the BIOS description.
2. Disconnect the device from the power supply.

Tool

You will need a TORX T8 screwdriver to open the battery compartment.

Replacing the battery

Proceed as follows:

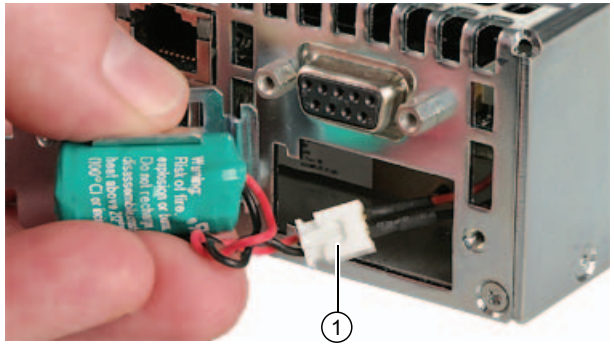
Steps for replacing the battery		
1	Open the battery compartment.	
2	Remove the battery holder.	
3	Pull out the battery plug ①.	
4	Take the old battery out of the holder.	
5	Place a new battery in the holder and reconnect the battery plug.	
6	Close the battery compartment.	

Reconfiguring the BIOS Setup

If the battery replacement takes longer than 30 seconds, the configuration data of the device will be lost. You will have to reconfigure the BIOS setup in this case.

11.2 Reinstalling the operating system

11.2.1 Windows Embedded Standard

11.2.1.1 General installation procedure

If your software becomes corrupt for any reason, you can reinstall it from the Restore CD/DVD. The Restore CD/DVD contains an image file for the hard disk/SSD or CF card with the original software package (operating system with installed hardware drivers).

Note

You require a USB keyboard and a USB CD-ROM drive to reinstall the operating system. Before performing the new installation, you should check the date and time set in the BIOS Setup (Page 126) and correct it if necessary.

11.2.1.2 Restoring the software to factory state using the Restore DVD

You can restore the original factory software using the Restore CD/DVD. The CD/DVD contains the necessary images and tools for transferring the factory software to the hard disk / SSD or CF card of your PC. The following options are available for restoring software:

- Restore the entire hard disk / SSD with drive C: (system) and drive D:
- Restore drive C: only. This allows you to retain any user data on drive D.
- Restore the entire CF card
- Restore the system partition of the CF card only.

CAUTION

If "Restore system partition only" is set all data on drive C: (system) will be deleted. All data, user settings and all authorizations or license keys on drive C: will be lost in the process! All data on drive C: of your hard disk drive will be deleted. Setup formats the hard disk partition and reinstalls the original factory software.
--

When you select the "Restore entire hard disk" option, ALL the data, user settings and authorizations or license keys will be lost on the hard disk.
--

Restoring the factory state

To restore the factory state, proceed as follows:

1. Connect a USB CD-ROM drive to the device.
2. Insert the Restore CD/DVD in the drive and reboot the device. When the BIOS message appears, press

Press <F2> to enter Setup or <ESC> to show the Boot menu

the F2 key.

3. Select the Boot menu and move the entry "CD-ROM Drive" to the first position.
4. Close the BIOS setup with the "Exit Saving Changes" entry.
5. Follow the on-screen instructions.

CAUTION

All existing **data, programs, user settings** and **authorizations or license keys will be deleted** from the hard disk and are therefore lost.

Note

The "Legacy USB Support" option has to be set to "Enabled" in the Advanced menu of the BIOS so that the device can address a USB CD-ROM drive.

11.2.2 Windows XP Professional

11.2.2.1 General installation procedure

If your software becomes corrupt for any reason, you have two possibilities:

- **Restoring the factory state of the software by means of the Restore DVD**
The Restore DVD contains an image of the original supplied software (operating system with installed hard ware drivers) and is included in the Windows XP Professional supply variant.
- **Setting up the operating system with the Recovery DVD**
The recovery DVD contains the tools required to set up the hard drive/SSD as well as the Windows XP Professional operating system. After the required data have been copied to the hard disk / SSD, you can run Windows XP Professional Setup to install the operating system.
The Recovery DVD is included in the scope of delivery for Windows XP Professional.

Note

You require a USB keyboard and a USB CD-ROM drive to reinstall the operating system. Before performing the new installation, you should check the date and time set in the BIOS Setup (Page 126) and correct it if necessary.

11.2.2.2 Restoring the software to delivery state using the Restore CD/DVD

You can reinstall the original factory software (included in the Windows XP Professional supply variant) using the Restore CD/DVD. The DVD contains the necessary images and tools for transferring the factory software to the hard disk or SSD of your PC. The following options are available for restoring software:

- Restore the entire hard disk or SSD with the system drive with all partitions and drive D:.
- Restore the system partition only. This allows you to retain any user data on drive D.

CAUTION
If "Restore system partition" option is set, all data on your system partition will be deleted. All data, user settings and all authorizations or license keys on the system drive will be lost in this case. The system drive on the hard disk will be completely deleted and reformatted, and the original factory software will be copied to it.
When you select the "Restore entire system drive" option, ALL data, user settings and authorizations or license keys on the system drive will be lost together with all partitions.

Restoring the factory state

To restore the factory state, proceed as follows:

1. Connect a USB DVD-ROM drive to the device.
2. Insert the Restore CD/DVD in the drive and reboot the device. When the BIOS message appears
`Press <F2> to enter Setup or <ESC> to show the Boot menu`
press the F2 key.
3. Select the Boot menu and move the entry "CD-ROM Drive" to the first position.
4. Close the BIOS setup with the "Exit Saving Changes" entry.
5. Follow the on-screen instructions.

CAUTION
All existing data, programs, user settings and authorizations or license keys will be deleted from the hard disk and are therefore lost.

Note
The "Legacy USB Support" option has to be set to "Enabled" in the Advanced menu of the BIOS so that the device can address a USB DVD-ROM drive.

Setting up the language selection for Windows XP Professional / Embedded Standard

The **Multilanguage User Interface (MUI)** allows you to set up the Windows XP Professional / Embedded Standard menus and dialogs for additional languages.

The English language and US keyboard layout are set up by default for the operating system menus and dialogs. You can change the menu and dialog language as follows:

Start > Control Panel > Regional and Language Options > Tab: Languages > Field: Language used in menus and dialogs.

In addition to the menu and dialog language, you must set the default for **non-Unicode programs** in the **Regional and Language Options > Advanced** dialog.

11.2.2.3 Setting up the operating system via the Recovery DVD

Use the Recovery DVD to install Windows to suit your particular requirements. You also need the included Documentation and Drivers CD/DVD.

Note

Prerequisite is that you connect a USB CD-ROM drive to the device and have set the "Legacy USB Support" option to "Enabled" in the BIOS setup.

Booting with the Recovery DVD

1. Insert the Recovery CD in your drive, restart the device and press the ESC key when the BIOS message
Press <F2> to enter Setup or <ESC> to show Boot Menu
appears. The "Boot Menu" is displayed when initialization is completed.
2. Follow the on-screen instructions until the "Windows XP Professional Setup" window opens.

Partition setup

After you have installed a new hard disk or SSD, or if partitions are faulty, or when you wish to change the partitioning on your hard disk, you need to create or reconfigure partitions on the hard disk.

CAUTION

When you delete or create partitions or logical DOS partitions, you lose all data on the hard disk. All drives on the hard disk or SSD will be deleted.

With Windows XP operating systems, the factory state features two partitions with an NTFS file system on the hard disk. To restore the partitions to factory state, follow the on-screen instructions:

- To install the selected partition, select "ENTER"
- To create a new partition in an unpartitioned area, press C.
- To delete the selected partition, press D.

Note

The on-screen instructions are in English.

Installation of the operating system.

Follow the on-screen instructions when the "Windows XP Professional Setup" window appears.

Note

Note that there must still be free space on the drive after the selected recovery data has been transferred:
1500 MB for Windows XP

Note

If you want to use Windows XP as a professional you should have the following manual (not included in the product package) available:
Microsoft Windows XP Professional, the technical reference" (MSPress Nr 934).

This manual contains information specifically for administrators involved in installing, managing and integrating Windows in networks or multi-user environments.

Setting up the language selection for Windows XP Professional

The **Multilanguage User Interface (MUI)** allows you to set up the Windows XP Professional menus and dialogs for additional languages.

To install the MUI, start the "MUISETUP.EXE" program on the "MUI-English" Recovery DVD under the folder

CD_DRIVE:\MUI

or "MUI Windows XP" in root folder of your Recovery DVD. Follow the on-screen instructions to install the required languages.

Default language of your Windows XP MUI installation is English and a US keyboard layout. You can change the language in the Control Panel. Select:

Start > Control Panel > Regional and Language Options Languages, tab Language used in menus and dialogs field.

For the **Regional and Language Options** set the default as **non-Unicode programs** under **Advanced** in addition to the language for menus and dialogs.

11.2.3 Recovery of Windows 7

There is a full graphical user interface available for recovery of Windows 7. It may take several minutes before the first input window appears. In this window, you can set the time and currency formats and select the keyboard language.

English is the basic language and other languages can be installed later with the MUI. The MUI is on the recovery DVD.

Now follow the on-screen instructions. It may take several minutes before the next prompt for the product key is displayed.

Note

Due to the previous activation, you do not need to enter the product key (COA number). This is entered automatically during the installation.

Setting up and formatting partitions

Set up the hard disk partitions after having installed a new hard disk, or to repair faulty partitions, or to change the partitioning.

In the next dialog box, you can set up the hard disk according to your requirements and add controllers that are not yet known to the system.

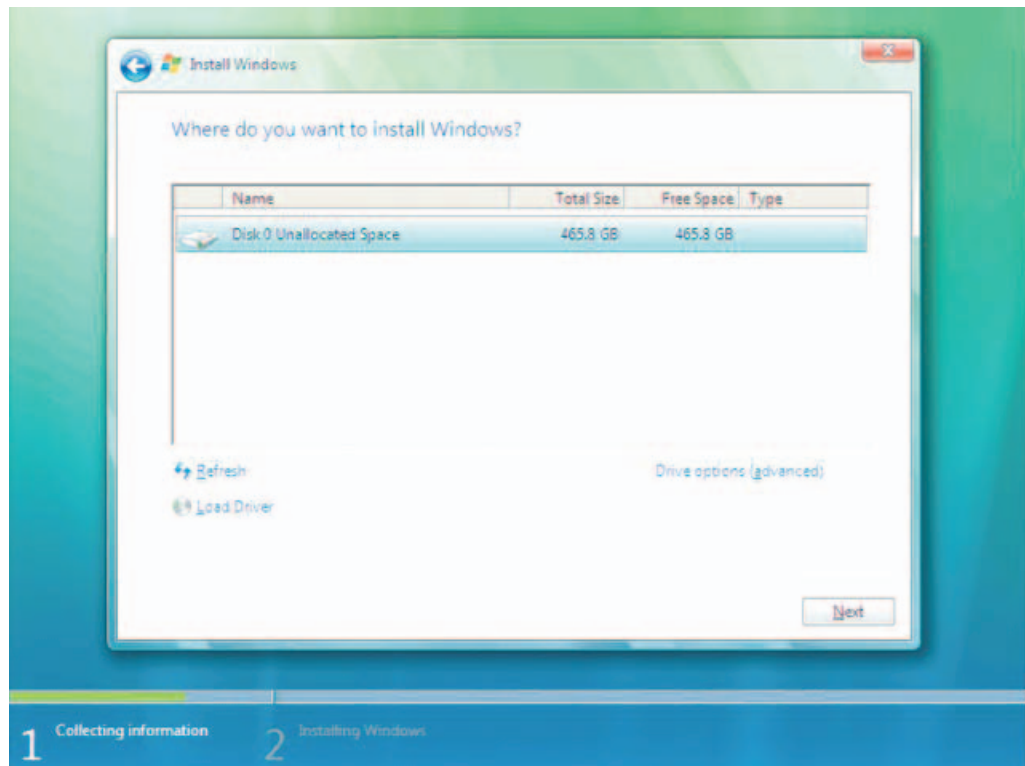

Options	Meaning
Drive options (advanced)	Further functions are displayed with which you can set up the hard disk.
Load Driver	To add new drivers, for example the driver for RAID.

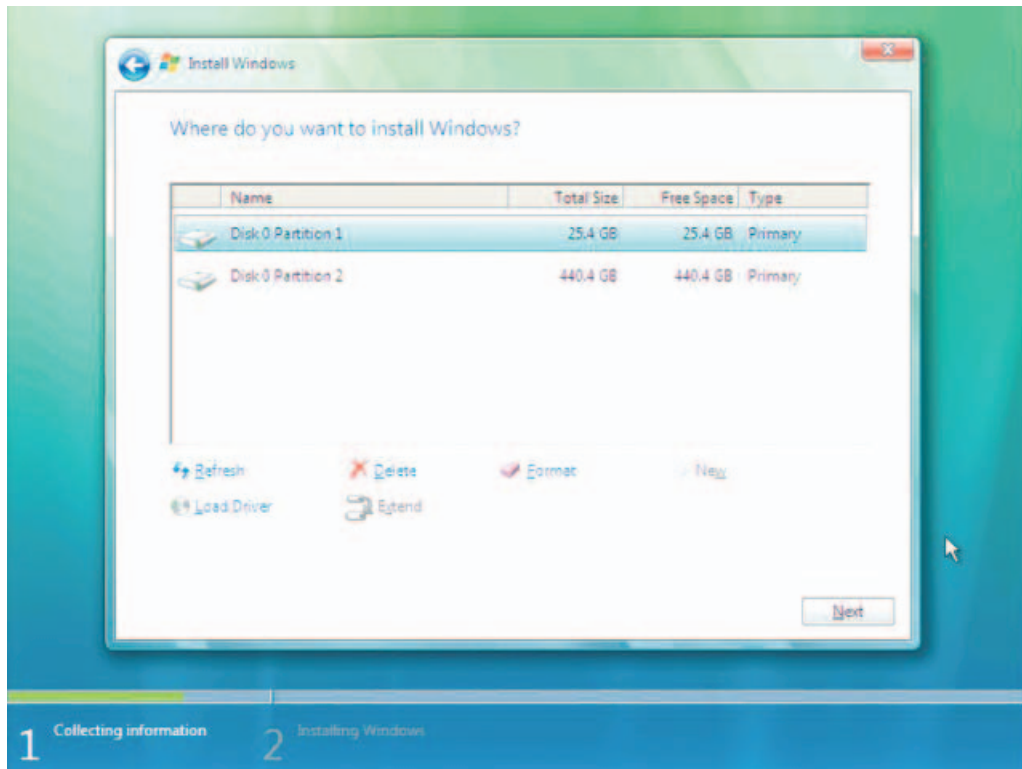

Options	Meaning
Refresh	Updating
Delete	Deleting a partition
Format	Formatting a partition
New	Creating new partitions
Load Driver	To add new drivers, for example the driver for RAID
Extend	Changing the partition size
	Any error messages that occur are displayed behind this icon, for example if the hard disk was not formatted in the required "NTFS" format.

The first partition should be at least 25 GB. The operating system must be installed on this partition. You can use the rest of the hard disk as a data partition. Both partitions must be installed with NTFS file system.

When shipped, the partitions are set up as follows:

Partition	Operating system	Name	Size	File system
First	Windows 7	SYSTEM	25 GB	NTFS not compressed
Second	Windows 7	DATA	Remainder	NTFS not compressed

Following a required reboot, Windows will be installed on the hard disk. This process takes at least 20 minutes.

Now follow the instructions on the screen.

Note

If you want to reinstall drivers from a USB floppy disk drive, select Floppy Drive (A:).

Note

If you want to use Microsoft Windows as a professional user, you will need the following manual (not supplied):

- Windows 7 Technical Reference (MS Press No. 5913)

This manual contains information specifically for administrators involved in installing, managing and integrating Windows in networks or multi-user environments.

Setting up the language selection in Windows 7

With the Multilanguage User Interface (MUI), you can set up the Windows menus and dialogs for additional languages. When shipped, Windows 7 is installed with English menus and dialogs. You can change this in the Control Panel with the "Regional and Language options" or "Time and Date" dialogs.

To change all system formats select:

Start > Control Panel > Clock, Language, and Region > Change display language > Regional and Language options

To change only the date and time formats, select:

Start > Control Panel > Clock, Language, and Region > Change display language > Time and Date

If you want to install additional languages, you can install these later in the Control Panel, as follows. You will find the necessary files on the recovery DVD in the "Languagepacks" folder.

Start > Control Panel > Clock, Language, and Region > Change display language > Regional and Language options > Keyboards and Languages

Additional languages can be integrated through Windows Update.

11.3 Partitioning data media

11.3.1 Setting up the partitions under Windows Embedded Standard 2009

Set up the hard disk partitions again after having installed a new hard disk, or to repair faulty partitions, or to change the partitioning.

Partitioning the CompactFlash card

For the Windows Embedded Standard 2009 operating system, the following default partitions are set up on the CompactFlash card:

Partition	Name	Card size			File system
		2 GB	4 GB	8 GB	
1. Partition	SYSTEM	1536 MB	2560 MB	5120 MB	NTFS (compressed)
2. Partition	DATA	Remainder *	Remainder *	Remainder *	NTFS (compressed)

* Due to partitioning/formatting, the actual CompactFlash capacity does not correspond to the memory size specified on the CF card.

Partitioning the hard disk

For the Windows Embedded Standard 2009 operating system, the following default partitions are set up on the hard disk:

Partition	Name	Size	File system
1. Partition	SYSTEM	25 GB	NTFS (not compressed)
2. Partition	DATA	Remainder	NTFS (not compressed)

Partitioning the SSD

For the Windows Embedded Standard 2009 operating system, the following default partitions are set up on the SSD:

Partition	Name	Size	File system
1. Partition	SYSTEM	15 GB	NTFS (not compressed)
2. Partition	DATA	Remainder	NTFS (not compressed)

To restore the partition to factory state, it is recommended to use the software tool **SIMATIC IPC Image & Partition Creator**. For more information about the tool, refer to the manufacturer documentation.

11.3.2 Setting up the partitions in Windows Embedded Standard 7

Set up the hard disk partitions again after having installed a new hard disk, or to repair faulty partitions, or to change the partitioning.

Partitioning the CompactFlash card

For the Windows Embedded Standard 7 operating system, the following default partitions are set up on the CompactFlash card:

Partition	Name	Card size		File system
		4 GB	8 GB	
1. Partition	SYSTEM	3690 MB	6150 MB	NTFS (compressed)
2. Partition	DATA	Remainder *	Remainder *	NTFS (compressed)

* Due to partitioning/formatting, the actual CompactFlash capacity does not correspond to the memory size specified on the CF card.

Partitioning the hard disk

For the Windows Embedded Standard 7 operating system, the following default partitions are set up on the hard disk:

Partition	Name	Size	File system
1. Partition	SYSTEM	25 GB	NTFS (not compressed)
2. Partition	DATA	Remainder	NTFS (not compressed)

Partitioning the SSD

For the Windows Embedded Standard 7 operating system, the following default partitions are set up on the SSD:

Partition	Name	Size	File system
1. Partition	SYSTEM	25 GB	NTFS (not compressed)
2. Partition	DATA	Remainder	NTFS (not compressed)

To restore the partition to factory state, it is recommended to use the software tool **SIMATIC IPC Image & Partition Creator**. For more information about the tool, refer to the manufacturer documentation.

11.3.3 Setting up the partitions under Windows XP Professional

Set up the hard disk partitions again after having installed a new hard disk, or to repair faulty partitions, or to change the partitioning.

Partitioning the hard disk

The factory state of the hard disk with Windows XP Professional includes the following partitions:

Partition	Name	Size	File system
1. Partition	SYSTEM	25 GB	NTFS (not compressed)
2. Partition	DATA	Remainder	NTFS (not compressed)

Partitioning the SSD

For the Windows XP Professional operating system, the following default partitions are set up on the SSD:

Partition	Name	Size	File system
1. Partition	SYSTEM	15 GB	NTFS (not compressed)
2. Partition	DATA	Remainder	NTFS (not compressed)

To restore the partition to factory state, it is recommended to use the software tool **SIMATIC IPC Image & Partition Creator**. For more information about the tool, refer to the manufacturer documentation.

11.3.4 Setting up the partitions in Windows 7 Ultimate

You need to reset the partitions after installing a new drive if the partitions are corrupt or if you want to change the layout of the partitions.

Partitioning the hard disk

For the Windows 7 Ultimate operating system, the following default partitions are set up on the hard disk:

Partition	Name	Size	File system
1. Partition	SYSTEM	25 GB	NTFS (not compressed)
2. Partition	DATA	Remainder	NTFS (not compressed)

Partitioning the SSD

For the Windows 7 Ultimate operating system, the following default partitions are set up on the SSD:

Partition	Name	Size	File system
1. Partition	SYSTEM	25 GB	NTFS (not compressed)
2. Partition	DATA	Remainder	NTFS (not compressed)

To restore the original partition to its delivery state, it is recommended to use the software tool **SIMATIC IPC Image & Partition Creator**. Detailed information about using this tool is available in the manufacturer documentation.

11.3.5 Adapting partitions in Windows 7 and Windows Embedded Standard 7

You can adapt the partitioning of your CF, SSD or HDD with the partition manager.

You can reduce or delete an available partition to acquire unassigned memory space, which you can use to set up a new partition or to increase an existing partition.

NOTICE
Data lost in the case of deleting a partition! If you delete a partition, all the data on this partition is lost. Back up your data before you change partitions.

Requirements

You are logged on as an administrator.

Reduce partition

1. Click with the right mouse button on the partition to be reduced and click on "Reduce size".
2. Follow the instructions.

Increase partition

Note

To increase a partition, this partition must not be formatted with a data system or the partition must be formatted with an "NTFS" data system.

1. Click in the partition manager with the right mouse button on the partition to be increased and click on "Increase size".
2. Follow the on-screen instructions.

Additional information is available in the "Help" menu under "Help topics" and "Search".

11.4 Installing drivers and software

11.4.1 Installing drivers for Windows Embedded Standard

The drivers for Windows Embedded Standard are installed as in Windows XP Professional. Pay attention to the installation instructions of the driver manufacturer.

When installing drivers for Windows Embedded Standard, the setup routine possibly prompts you to insert the "Windows XP Installation CD".

- In this case, insert the Restore CD/DVD.
The required files are in the folder \Drivers_WES.
- Disable the Enhanced Write Filter before installing drivers and enable it again when you are finished.

11.4.2 Installing drivers and software

NOTICE

Before you install new drivers or updates for multilingual operating systems, (MUI versions), set the regional settings for menus and dialogs and the default language to US English.

Install the drivers and software from the included "Documentation and Drivers" CD.
Procedure:

1. Insert the CD/DVD into the drive.
2. Start the program with "START".
3. Select "Drivers & Updates" from the index.
4. Select the operating system in "Drivers & Updates".
5. Install the required driver.

NOTICE

After having installed Windows XP Professional or Windows 7, always install the the chipset driver before you install any other drivers.
--

11.5 Installing updates

11.5.1 Updating the operating system

Windows

The latest updates for the Windows operating system are available on the Internet at Microsoft Side Guide (<http://www.microsoft.com>).

NOTICE

Before you install new drivers or operating system updates for Windows MUI versions, set the default language to US English in the regional settings for menus and dialogs.

other operating systems

Please contact the corresponding manufacturer.

11.5.2 Installing or updating application programs and drivers

To install software for Windows operating systems from CD and/or floppy disk, you must connect a corresponding external USB drive to the computer.

The USB drivers for external floppy drives and CD-R drives are included in the operating and do not have to be installed separately.

For information about installation of SIMATIC software packages, refer to the corresponding manufacturer documentation.

For updates of drivers and application programs from third-party manufacturers, contact the respective manufacturer.

NOTICE

Before you install new drivers or operating system updates at Windows XP Professional MUI versions, the regional settings for menus and dialogs and the default language have to be reset to US English.
--

11.5.3 Performing a BIOS update

Download from BIOS update

Check regularly if updates are available for download to your device.

You can find the downloads in the Internet (<http://www.siemens.com/asis>) in the "Support" tab under "Tools & Downloads". Using the global search function, you can then also search for any downloads you require.

11.6 Data backup

11.6.1 Creating an image

Data backup in Windows Embedded Standard / Windows XP Professional / Windows 7 Ultimate

It is recommended to use the **SIMATIC IPC Image & Partition Creator** software tool (V3.1 or higher) for data backups in Windows Embedded Standard / Windows XP Professional / Windows 7 Ultimate. This tool provides comfortable and efficient functions for backup and restoring the full content of CompactFlash cards, hard disks, and of individual partitions (images.)

SIMATIC IPC Image & Partition Creator supports the burning of DVD media only and can be ordered using the Siemens A&D Online Ordering System (<http://www.siemens.com/automation/mall>). For more information about SIMATIC IPC Image & Partition Creator, refer to its product documentation.

11.7 CP 1616 onboard

NDIS device driver

Read the information in the description Installation_CP16xx.pdf document on the supplied Documentation and Drivers CD.

PROFINET IO

Please observe the information on the SIMATIC devices and SIMATIC NET documentation listed in the chapter "Integration".

Alarm, error and system messages

12.1 Boot error messages

During startup (the boot process), the BIOS first performs a **Power On Self Test (POST)** and checks whether certain functional units of the PC are operating error-free. The boot sequence is immediately interrupted if critical errors occur.

BIOS initializes and tests further functional units if the POST does not return any errors. In this startup phase, the graphics controller is initialized and any error messages are output to the screen.

The error messages output by system BIOS are listed below. For information on error messages output by the operating system or application programs, refer to the corresponding manuals.

On-screen error messages

On-screen error message	Meaning / tip
Operating system not found	Possible causes: <ul style="list-style-type: none">• No operating system installed• Incorrect active boot partition• Wrong boot drive settings in SETUP
Keyboard controller error	Controller error. Contact your technical support team.
SMART error	Hard disk reports pending failure through S.M.A.R.T.

Troubleshooting/FAQs

13.1 General problems

This chapter provides you with tips on how to locate and troubleshoot common problems.

Problem	Possible cause	To correct or avoid error
The device is not operational.	There is no power supply to the device.	Check if the power switch is set to ON.
The monitor remains dark.	The monitor is switched off.	Switch on the monitor.
	The monitor is in "powersave" mode.	Press any key on the keyboard.
	The brightness button has been set to dark.	Set the monitor brightness button to obtain more light. For detailed information, refer to the monitor operating instructions.
	The power cord or the monitor cable is not connected.	<ul style="list-style-type: none"> Check whether the power cord has been properly connected to the monitor and to the system unit or to the grounded shockproof outlet. Check whether the monitor cable has been properly connected to the system unit and to the monitor.
		If the monitor screen still remains dark after you have performed these checks, please contact your technical support team.
The mouse pointer does not appear on the screen.	The mouse driver is not loaded.	Check whether the mouse driver is properly installed and present when you start the application program. For more detailed information, refer to the manuals for the mouse or application programs.
	The mouse is not connected.	Check whether the mouse cord is properly connected to the system unit. If you use an adapter or extension on the mouse cable, also check the connectors.
	If the mouse pointer still does not appear on the screen after you have performed these checks and measures, please contact your technical support team.	
Wrong time and/or date on the PC.		<ul style="list-style-type: none"> Press <F2> within the boot sequence to open BIOS Setup. Set the time and date in the setup menu.
Although the BIOS setting is OK, the time and data are still wrong.	The backup battery is dead.	In this case, please contact your technical support team.
USB device not responding	Operating system does not support the USB port.	No remedy.
	The operating system does not have a suitable driver for the USB device.	<p>Install a suitable driver; the correct driver can often be downloaded from the homepage of the device's manufacturer.</p> <p>The EWF for Windows Embedded Standard 2009 must first be disabled for this purpose.</p>

13.2 Problems when using modules of third-party manufacturers

Problem	Possible cause	To correct or avoid error
The PC crashes during startup.	<ul style="list-style-type: none"> • I/O addresses are assigned twice. • Hardware interrupts and/or DMA channels are assigned twice • Signal frequencies or signal levels are not adhered to • Different connector pin assignments 	Check your computer configuration: <ul style="list-style-type: none"> • If the computer configuration corresponds with factory state, please contact your technical support team. • If the computer configuration has changed, restore the original factory settings. Remove all third-party modules, then restart the PC. If the error no longer occurs, the third-party module was the cause of the fault. Replace this module with a Siemens module or contact the module supplier.
		If the PC still crashes, contact your technical support team.

Technical specifications

14.1 General specifications

General technical specifications	
Order numbers	see the order documents
Dimensions	262x142x47 (WxHxD in mm)
Weight	Approximately 2 kg
Supply voltage (DC)	24 VDC ¹ (19.2 to 28.8 V)
Brief power failure according to Namur	min. 15 ms (at 20.4 V) Max. 10 events per hour; min. 1 s recovery time
Maximum power consumption	4 A (at 24 V)
Noise emission	<40dB (A) to DIN 45635-1
Degree of protection	IP 20 to IEC 60529
Safety	
Protection class	Protection class I to IEC 61140
Safety specifications	EN 60950-1; UL 60950-1; CAN/CSA-C22.2 No. 60950-1; UL 508; CAN/CSA-C22.2 No. 142 or CAN/CSA-C22.2 No.14-05
Electromagnetic compatibility (EMC)	
Emitted interference	EN 61000-6-3 , EN 61000-6-4 , CISPR22:2004 Class B; FCC Class A
Noise immunity: Mains borne disturbance variables on supply lines	+/- 2 kV to IEC 61000-4-4; Burst +/-1 kV to IEC 61000-4-5; surge symmetric +/- 2 kV to IEC 61000-4-5; Surge asymmetric
Noise immunity on signal lines	± -1 kV to IEC 61000-4-4; Burst; Length < 3 m ± /-2 kV to IEC 61000-4-4; Burst; length > 3 m ± /-2 kV to IEC 61000-4-5; Surge; length > 30 m
Immunity to discharges of static electricity	+/-6 kV contact discharge according to IEC 61000-4-2 -8 kV air discharge according to IEC 61000-4-2
Immunity to RF interference	10 V/m 80 – 1000 MHz and 1.4 - 2 GHz, 80% AM to IEC 61000-4-3 1 V/m 2 - 2.7 GHz, 80% AM to IEC 61000-4-3 10 V 10 KHz – 80 MHz, 80% AM to IEC 61000-4-6
Magnetic field	100 A/m rms at 50/60 Hz according to IEC 61000-4-8
¹	The generation of the 24 VDC supply voltage by the line-side power supply must be made as functional extra-low voltage with safe electrical isolation according to IEC 60364-4-41 or as SELV in conformity with IEC/UL/EN/DIN-EN 60950-1 and LPS / NEC Class 2.

Climatic Conditions	
Temperature	Tested to IEC 60068-2-1, IEC 60068-2-2, IEC 60068-2-14
- During operation	<p>Horizontal mounting position:</p> <p>Operation with hard disk:</p> <ul style="list-style-type: none"> with up to 3 expansion modules (max. load 9 W): +5 to +40° C <p>Operation with CompactFlash card and/or SSD:</p> <ul style="list-style-type: none"> with up to 3 expansion modules (max. load 9 W): 0 to +45°C with up to 3 expansion modules (max. load 9 W) in RAL: 0 to +50°C <p>Operation with CompactFlash card:</p> <ul style="list-style-type: none"> Without expansion modules in RAL: 0 to +55°C <p>Vertical / portrait mounting position:</p> <p>Operation with hard disk:</p> <ul style="list-style-type: none"> with up to 3 expansion modules (max. load 9 W): +5 to +40° C <p>Operation with CompactFlash card:</p> <ul style="list-style-type: none"> Without expansion modules: 0 to +45° C <p>Operation with CompactFlash card and/or SSD:</p> <ul style="list-style-type: none"> with up to 3 expansion modules (max. load 9 W) in RAL: 0 to +45° C <p>Operation with CompactFlash card:</p> <ul style="list-style-type: none"> with up to 3 expansion modules (max. load 9 W) in RAL: 0 to +50° C <p>Horizontal mounting position:</p> <p>Operation with CompactFlash card and/or SSD and without expansion modules: 0 to +40° C</p> <p>RAL = Restricted Access Location (installation of device in operating facilities with restricted access - for example, a locked control cabinet)</p>
- During storage/shipping	-40°C to +60°C (for variants with HD) or -40°C to +70°C (for variants with CF or SSD)
- Gradient	Operating mode: Max. 10°C/h; Storage: 20°C/h; no condensation
Relative humidity	tested to IEC 60068-2-78, IEC 60068-2-30
- During operation	5% to 80% at 25° C (no condensation)
- During storage/shipping	5% to 95% at 25° C (no condensation)
Barometric pressure	
- During operation	1080 to 795 hPa (corresponds to an altitude of -1000 m to 2000 m)
- During storage/shipping	1080 to 660 hPa (corresponds to an altitude of -1000 m to 3500 m)

Mech. Ambient conditions	
Vibration	Tested to DIN IEC 60068-2-6
- During operation	with CompactFlash card or SSD: 5 to 9 Hz: 3.5 mm 9 to 500 Hz: 9.8 m/s ² with hard disk and wall installation: 10 to 58 Hz: 0.0375 mm 58 to 200 Hz: 4.9 m/s ² with hard disk and DIN rail mounting or vertical installation: excitation not allowed
- During storage/shipping	5 to 9 Hz: 3.5 mm 9 to 500 Hz: 9.8 m/s ²
Resistance to shock	Tested to DIN IEC 60068-2-27
- During operation	without hard disk drive: 150 m/s ² , 11 ms; with hard disk drive: 50 m/s ² , 30 ms
- During storage/shipping	250 m/s ² , 6 ms
Special Features	
Quality assurance	acc. to ISO 9001
Motherboard	
Processor	Intel Celeron M 1.2 GHz, 1 MB SLC or Intel Pentium Core 2 Solo 1.2 GHz, 3 MB SLC or Intel Pentium Core 2 Duo 1.2 GHz, 3 MB SLC
Front Side Bus	800 MHz
Main memory	SO-DIMM modules; 512/1024/2048/4096 MB DDR3-SDRAM
Buffer memory	2 MB SRAM (256 KB of this can be backed up in the buffer time of the power supply under full load)
Free expansion slots	Up to 3 PCI-104 or PC/104- <i>Plus</i> modules can be used (max. permitted power loss: 3 W per module, 9 W total)
Drives / storage media	
Hard disk drive	1x 2.5" SATA-HD optional
Solid State Disk	1x 2.5" SATA-SSD optional
CompactFlash card	256/2048/4096/8192 MB
Graphics	
Graphics controller	Intel GMA4500
Graphics memory	32 - 256 MB shared memory
Resolutions/frequencies/color depth	CRT: 640 x 480 to 1920 x 1200 / 60 - 120Hz DVI-LCD: 640 x 480 to 1920 x 1200 / 60Hz
Ports	
COM1; COM2 (optional)	RS232, max. 115 Kbps., 9-pin Cannon, male
VGA/DVI	VGA integrated in the DVI-I
Keyboard	USB support
Mouse	USB support
USB	4x USB 2.0 high-speed / high current

Technical specifications

14.1 General specifications

PROFIBUS / MPI interface, isolated	9-pin Cannon socket, 2-row
- Transmission speed	9.6 Kbps to 12 Mbps
- Operating modes	DP master: DP-V0, DP-V1 with SOFTNET-DP DP slave: DP-V0, DP-V1 with SOFTNET DP slave
PROFINET ²	3x RJ45 connection, CP 1616 compatible onboard interface based on ERTEC 400, 10/100 Mbps isolated
Ethernet ²	2 x Ethernet ports (RJ45) Intel 82574L 10/100/1000 Mbps, isolated Teaming-capable , or 1 x Ethernet port for PROFINET variants
CAN (optional)	Philips SJA1000
²	For unique labeling, the LAN interfaces are numbered on the housing. The numbering by the operating system can differ.

Status displays on the device

PWR	GREEN	Indicates correct supply voltage of 3.3 V, 5 V and 12 V from the integrated power unit
WD	OFF	Watchdog disabled
	GREEN	Watchdog enabled, monitoring time not expire
	RED	Watchdog enabled, monitoring time expired
L1 (user LED 1)	OFF	Can be controlled by user programs
	YELLOW	
	RED	
SF (Group error)	RED	Can be controlled by controller programs (e.g. WinAC)
L2 (user LED 2)	OFF	Can be controlled by user programs
	YELLOW	
	GREEN	
RUN	GREEN	Can be controlled by controller programs (e.g. WinAC)
STOP	YELLOW	
SF PROFINET (optional)	OFF	<ul style="list-style-type: none"> • CP not available • CP disabled • No error, communication established • Charging in progress
	RED: Flashes slowly	<ul style="list-style-type: none"> • Link status error • I/O controller: I/O device cannot be addressed • I/O controller: Redundant IP address
	RED: Flashes rapidly	<ul style="list-style-type: none"> • Exception error: diagnostics via Web or SNMP is no longer possible
	RED	<ul style="list-style-type: none"> • Diagnostics information available • No communication established.

14.2 Power requirements of the components

Maximum power consumption of the auxiliary components

Auxiliary components		Maximum permitted power consumption				Max. total power
		+5 V	+3.3 V	+12 V	-12 V	
USB device	High current	500 mA	--	--	--	10 W (for all USB devices)
PC/104 modules	Per slot	1.5 A	1.5 A	0.3 A	0.2 A	9 W (for the whole device)
	Total	2 A	2 A	0.5 A	0.5 A	

1) The total load for PCI-104 and USB expansion is max. 15W.

NOTICE
Device can overheat!
For thermal reasons, a 3 watt power loss per PCI/104 slot should not be exceeded.

14.3 Integrated DC power supply

Technical specifications

Input voltage	24 VDC (19.2 to 28.8 VDC)
Power consumption ¹	max. 72 W
Power failure buffering	Hold-up time > 15 ms (after > 5 ms DC_FAIL becomes active)
Maximum continuous output power ¹	60 W
Degree of protection	IP 20
Protection class	Safety class I (A protective conductor must be connected to the device)

¹ The performance specifications apply to the power supply component, but not to the IPC427C device.

Note

Inrush current

A minimum of 4.5 A inrush current for 15 ms is required for starting the IPC427C.

The peak value of the inrush current depends on the input voltage and the impedance of the 24V source; peak values higher than 4.5 A are possible. This will not inhibit the operation of the IPC427C.

Typical power consumption

	Current consumption	Power consumption (at 24 V rated voltage)
Base device with Core 2 Solo processor	550 mA	13 W
Base device with Celeron or Core 2 Duo processor	750 mA	18 W
Fieldbus (Profibus or Profinet)	120 mA	3 W
2.5" hard disk	100 mA	2 W
USB expansion ¹⁾	max. 500 mA	max. 12 W
Expansion PCI-104 ¹⁾	max. 460 mA	max. 11 W

¹⁾ The accumulated load for PCI-104 and USB expansions must not exceed 15 W

Dimension drawings

15.1 Overview of the dimensional drawings

This section contains the following dimension drawings:

- Dimension drawings of the device (Page 108)
- Dimension drawings of the device with mounting brackets (Page 109)
- Dimensional drawings of the device with vertical mounting angles (Page 111)
- Dimensional drawings of the device with expansion frames (Page 112)
- Dimension drawing of the blanking plate (Page 113)

Note

The dimensions are always given in in mm and inch (above: Millimeter, below: Inch)

15.2 Dimension drawings of the device

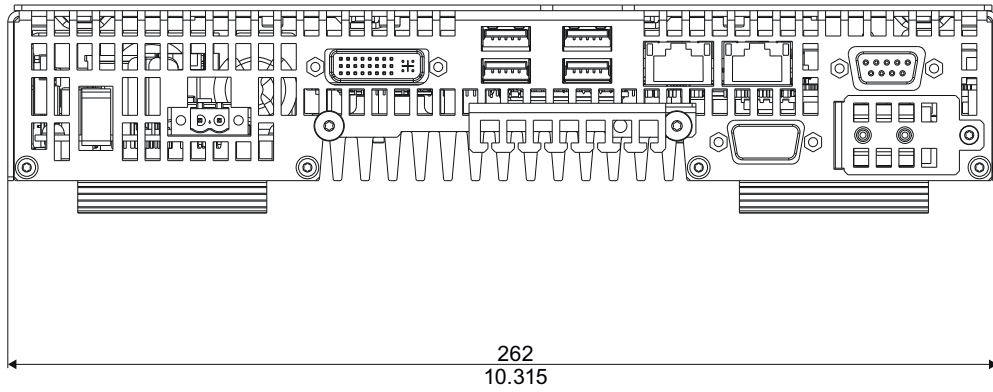

Figure 15-1 Dimensional drawing of the device: Front view

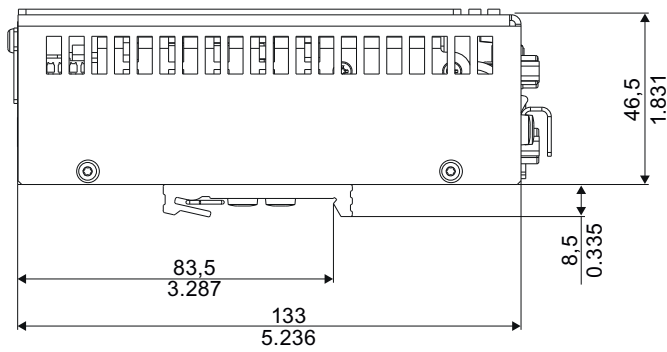

Figure 15-2 Dimensional drawing of the device: Side view

15.3 Dimension drawings of the device with mounting brackets

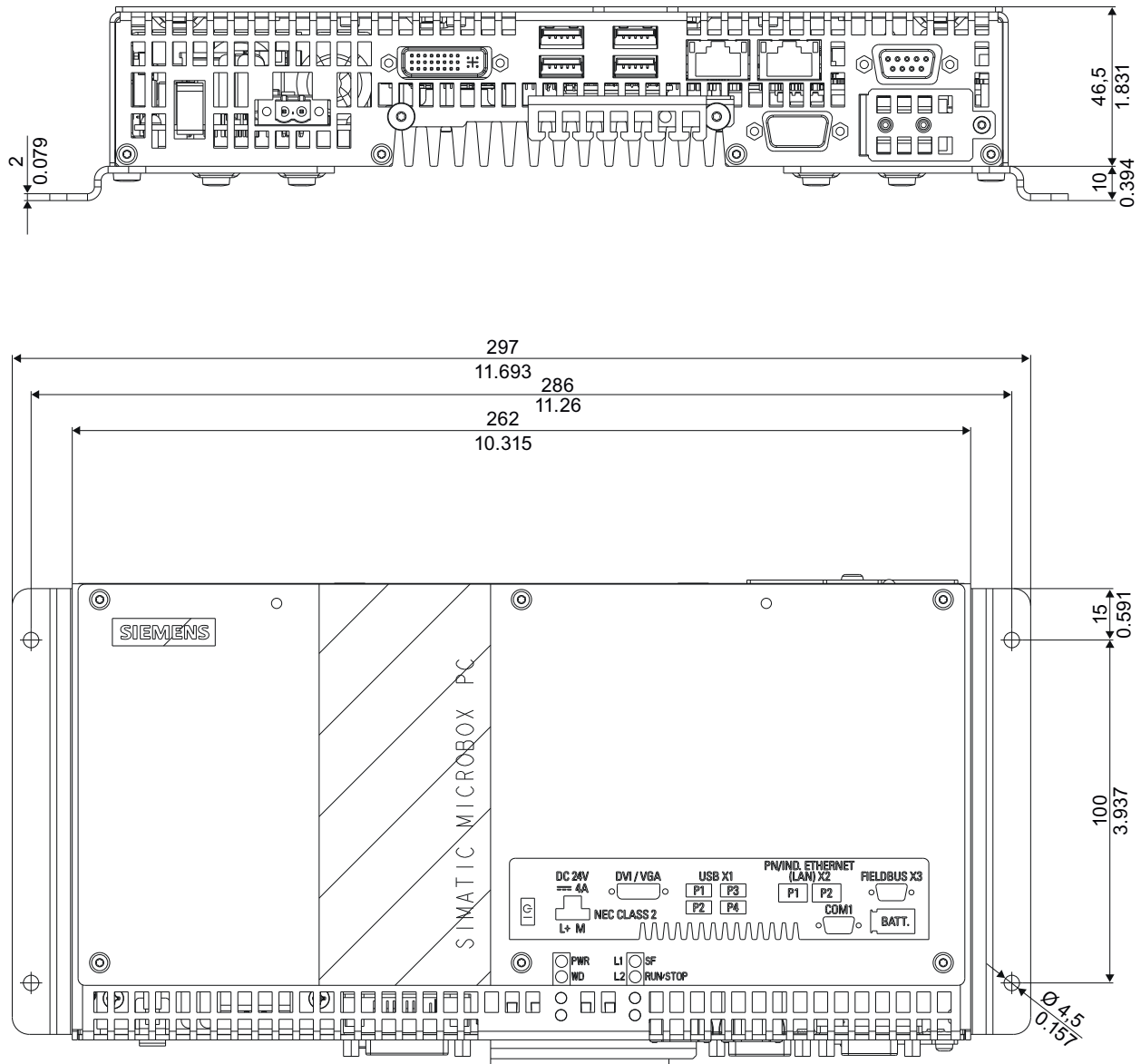

Figure 15-3 Dimensional drawing of the device with mounting brackets Front view and top view

15.3 Dimension drawings of the device with mounting brackets

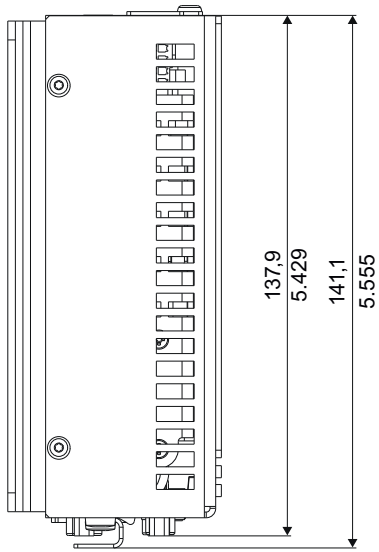

Figure 15-4 Dimensional drawing of the device with mounting brackets Side view

15.4 Dimensional drawings of the device with vertical mounting angles

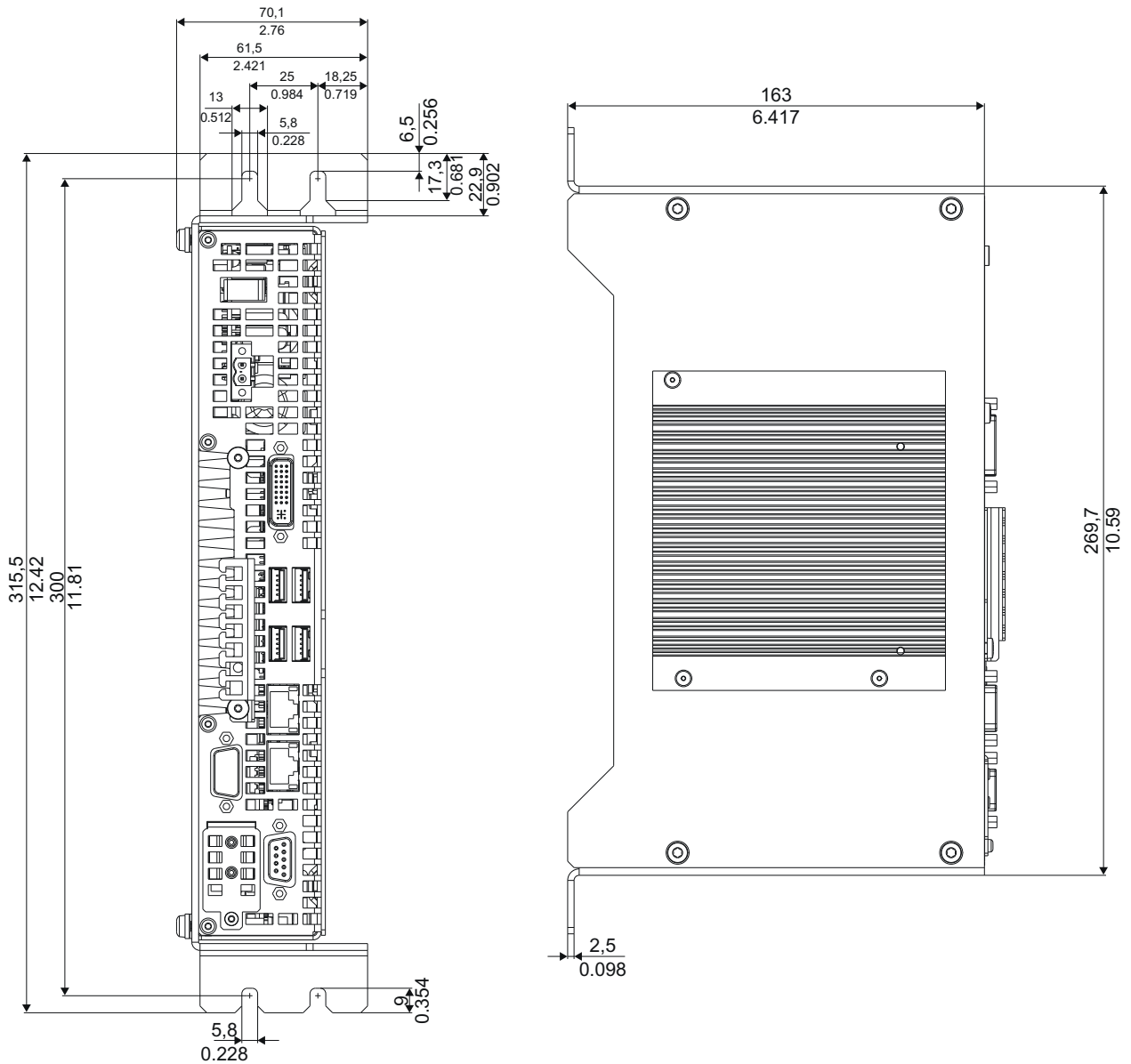

Figure 15-5 Dimensional drawings of the device with vertical mounting brackets

15.5 Dimensional drawings of the device with expansion frames

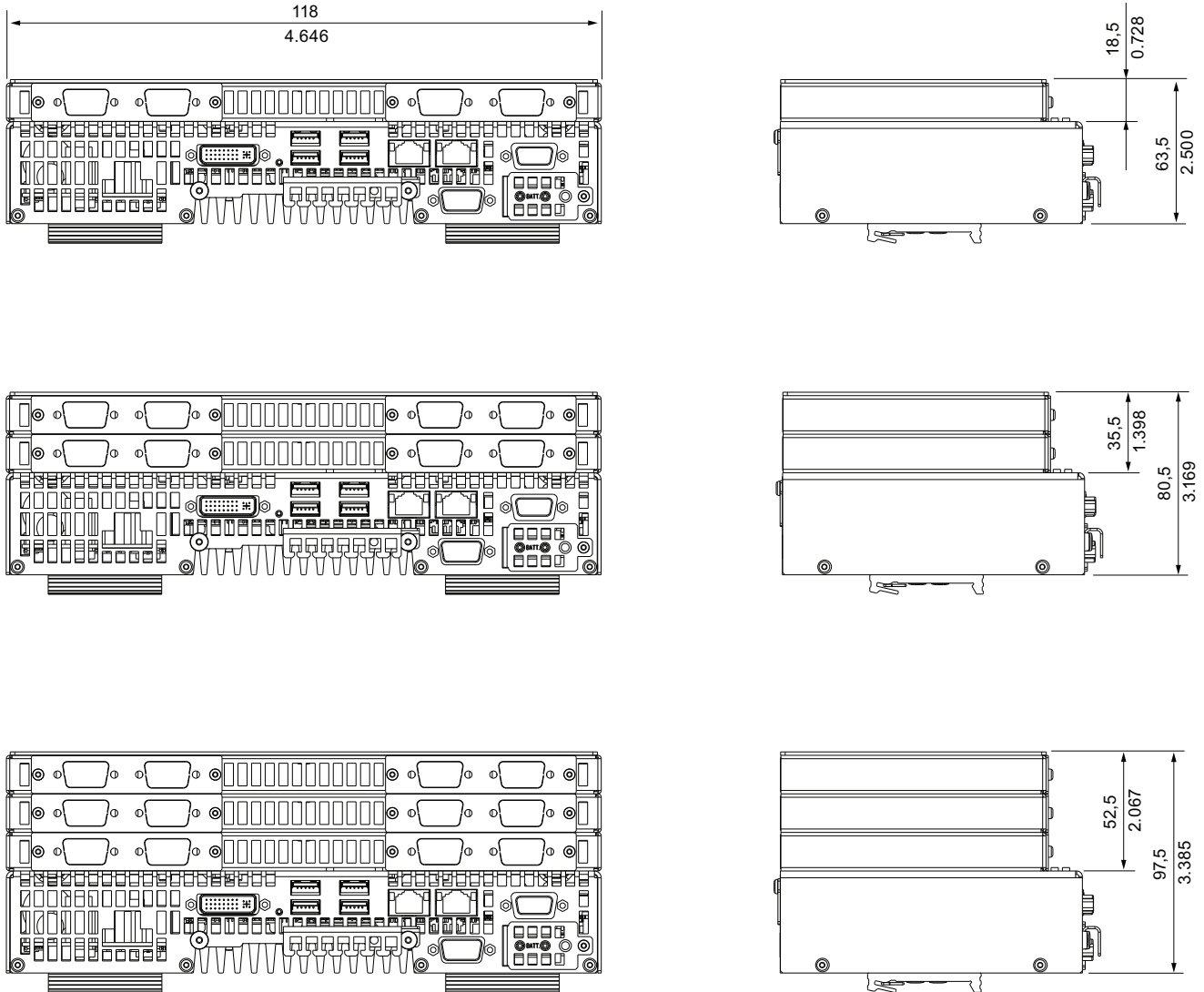

Figure 15-6 Dimensional drawings of the device with expansion frames

15.6 Dimension drawing of the blanking plate

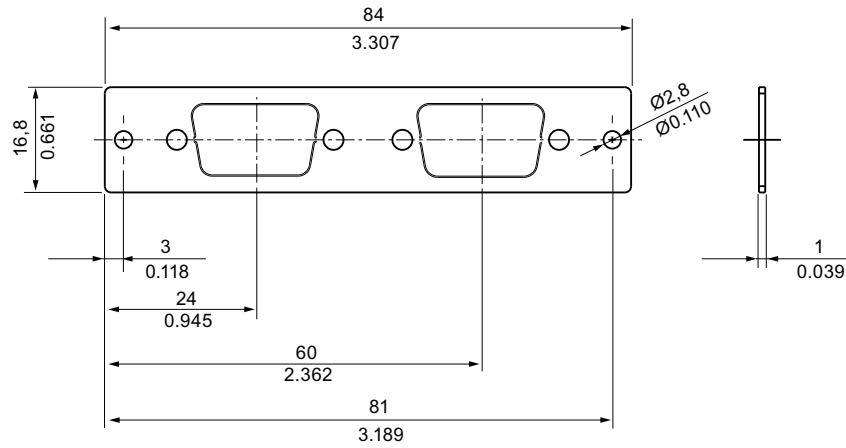

Figure 15-7 Dimensional drawing of the blinding plate

Detailed descriptions

16.1 Internal components

16.1.1 Overview of internal components

The basic components of the device are

- the motherboard with processor, chipset, one slot for a RAM module, internal and external ports,
- a DC/DC converter for the power supply of the device

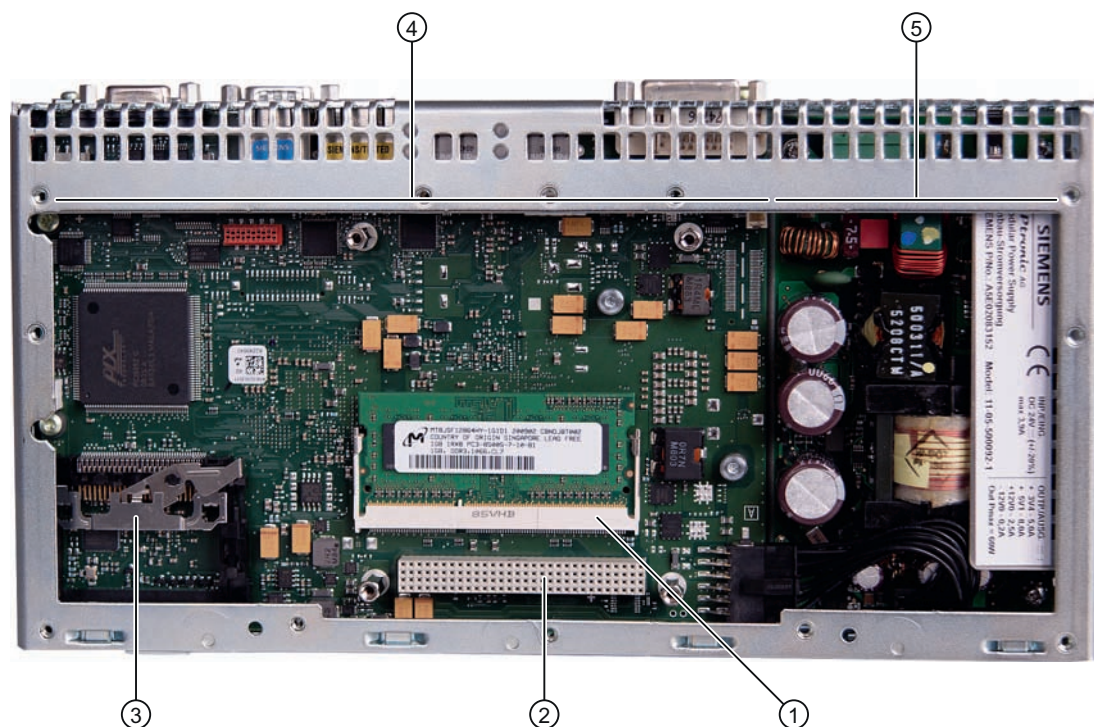

Figure 16-1 Internal layout of the device

①	Slot for a memory module	④	Motherboard
②	Slot for up to three PCI-104 or PC/104-Plus modules	⑤	DC/DC converter
③	Slot for Compact Flash card		

16.1.2 Technical features of the motherboard

Component / port	Description	Parameters
Chipset	Intel GM45+ICH-9m	
BIOS	Insyde H20...	
CPU	Intel Celeron M Inter Pentium Core 2 Solo Intel Pentium Core 2 Duo	1.2 GHz, 1 MB SLC 1.2 GHz, 3 MB SLC 1.2 GHz, 3 MB SLC
Memory	DDR 3 SO-DIMM module	512 MB / 1024 MB / 2048 MB / 4096 MB
Graphics	Intel GMA4500	32 - 256 MB graphics memory taken dynamically from RAM

16.1.3 External ports

16.1.3.1 Overview

Port	Position	Description	
COM1; COM2 (optional)	external	9-pin male	V24
USB	external	4 USB channels 4 x high current	USB 1.1 USB 2.0
PROFIBUS DP/MPI (optional)	external	9-pin female	
PROFINET (optional)	External	3x RJ45	CP 1616 compatible
CAN (optional)	external	9-pin female	CAN
Ethernet	external	2 x RJ45 1 x RJ45 (for PROFINET versions)	10/100/1000 Mbps
DVI-I	external	DVI-I standard socket	

16.1.3.2 COM1/2

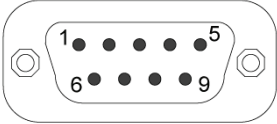
Serial port COM1, 9-pin (plug) or COM2 (optional)		
		
Pin no.	Short description	Description
1	DCD	Data carrier detect (I)
2	RxD	Received data (I)
3	TxD	Transmitted data (O)
4	DTR	Data terminal ready (O)
5	GND	Ground
6	DSR	Data set ready (I)
7	RTS	Request to send (O)
8	CTS	Clear to send (I)
9	RI	Incoming call (I)

16.1.3.3 DVI-I

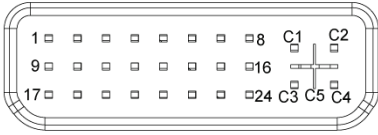
DV-I port, standard socket		
		
Pin no.	Short description	Description
1	TMDS Data2-	DVI data channel (O)
2	TMDS Data2+	DVI data channel (O)
3	TMDS Data2/4 shield	Cable shield
4	NC*	
5	NC	
6	DDC clock (SCL)	Display data channel – clock (I/O)
7	DDC data (SDA)	Display data channel – data (I/O)
8	Analog vertical sync (VSYNC)	Analog vertical sync signal (O)
9	TMDS Data1-	DVI data channel (O)
10	TMDS Data1+	DVI data channel (O)
11	TMDS Data1/3 shield	Cable shield
12	NC	
13	NC	
14	+5V power (VCC)	+5V power for DCC (O)

16.1 Internal components

DV-I port, standard socket		
15	Ground (return for +5V, Hsync and Vsync) (GND)	Analog ground
16	Hot Plug Detect	
17	TMDS data 0-	DVI data channel (O)
18	TMDS data 0+	DVI data channel (O)
19	TMDS Data0/5 shield	Cable shield
20	NC	
21	NC	
22	TMDS clock shield	Cable shield
23	TMDS clock+	DVI clock channel (O)
24	TMDS clock-	DVI clock channel (O)
C1	Analog red (R)	Analog red signal (O)
C2	Analog green (G)	Analog green signal (O)
C3	Analog blue (B)	Analog blue signal (O)
C4	Analog horizontal sync (HSYNC)	Analog horizontal sync signal (O)
C5	Analog ground (analog R, G, & return) (GND)	Analog ground

16.1.3.4 Ethernet

Ethernet RJ45 connection			
Pinno.	Short description	Description	Input / output
1	BI_DA+	Bi-directional data A+	Input/output
2	BI_DA-	Bi-directional data A-	Input/output
3	BI_DB+	Bi-directional data B+	Input/output
4	BI_DC+	Bi-directional data C+	Input/output
5	BI_DC-	Bi-directional data C-	Input/output
6	BI_DB-	Bi-directional data B-	Input/output
7	BI_DD+	Bi-directional data D+	Input/output
8	BI_DD-	Bi-directional data D-	Input/output
S		Shield	-

Ethernet RJ45 connection			
	LED 1	Off: 10 Mbps Lit in green: 100 Mbps Lit in orange: 1000 Mbps	–
	LED 2	Lit: Active connection (to a hub, for example) Flashing: Activity	–

16.1.3.5 USB

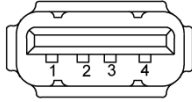
USB port, 4 channel high current		
		
Pin no.	Short description	Description
1	USB_P5V_fused (O)	+ 5 V (fused) for external USB interface
2	USB_D0M (I/O)	Data+, USB channel 0
3	USB_D0P (I/O)	Data-, USB channel 0
4	USB_GND	Ground for external USB interface

16.1.3.6 PROFIBUS

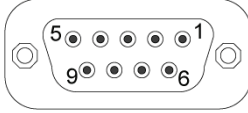
PROFIBUS interface, 9-pin (socket)		
		
Pin no.	Short description	Description
1-2	NC	Not connected
3	LTG_B	Data line (I/O)
4	RTS_AS	Turn on PLC transmitter (O)
5	GND	Ground isolated
6	P5V_dp_fused	+5 V (fused) isolated
7	NC	Not connected
8	LTG_A	Data line (I/O)
9	RTS_PG	PG Request to send (O)

16.1.3.7 PROFINET

PROFINET LAN X1 Port P1, P2, P3

PROFINET interface			
Pinno.	Short name	Meaning	Input / output
1	RD+	Receive data *	Input
2	RD-	Receive data *	Input
3	TD+	Transmit data *	Output
4, 5 ¹⁾	SYMR	Internal 75 Ohm terminating resistor	—
6	TD-	Receive data *	Output
7, 8 ¹⁾	SYMT-	Internal 75 Ohm terminating resistor	—
S		Shield	
	LED 1	Lights up green: link	
	LED 2	Lights up yellow: Activity	
* Auto Negotiation and auto cross over is supported			

16.1.3.8 CAN bus

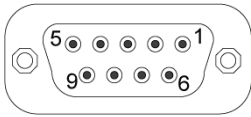
CAN bus port, 9-pin (socket)		
		
Pin no.	Short description	Description
1	-	Reserved
2	CAN_L	CAN bus signal (L active)
3	CAN_GND	CAN station ground
4	-	Reserved
5	-	Reserved
6	-	Reserved
7	CAN_H	CAN bus signal (H active)
8	-	Reserved
9	-	Reserved

NOTICE
The permitted maximum length of the CAN bus cable is 30 meters.

16.1.4 Internal ports

16.1.4.1 Overview

Port	Position	Connector	Description
Compact Flash card (True IDE mode)	Internal	X3	50-pin CF socket, types I / II
PCI -104	Internal		PCI interface

16.1.4.2 Compact Flash card interface

Compact Flash card interface, X3		
Pin no.	Short description	Description
41	RESET#	Reset (output)
7	CS0#	Chip select 0(output)
32	CS1#	Chip select 1(output)
34	IORD#	I/O read (output)
35	IOWR#	I/O write (output)
20, 19, 18,	A0-A2	Address bit 0-2 (output)
17, 16, 15, 14, 12, 11, 10, 8	A3-A10	Address bit 3-10 (output) to ground
21, 22, 23, 2, 3, 4, 5, 6, 47, 48, 49, 27, 28, 29, 30, 31	D0-D15	Data bits 0-15 (in/out)
37	INTRQ	Interrupt request (input)
9	OE# /ATA SEL#	Enables True IDE mode
24	IOCS16#	I/O-chip select 16 (input)
39	CSEL#	Cable select (output)
42	IORDY	I/O ready (input)
46	PDIAG#	Passed diagnostic
45	DASP#	Drive active/slave present (not connected)
26, 25	CD1#, CD2#	Card detect (not connected)
33, 40	VS1#, VS2#	Voltage sense (not connected)
43	DMARQ	DMA request (input)
44	DMACK#	DMA acknowledge (output)
36	WE#	Write enable
1, 50	GND	Ground
13, 38	VCC	+ 5V power

16.1.4.3 PCI-104 or PC/104-Plus interface (PCI part)

PCI-104 or PCI part of the PC/104-Plus interface, X7				
Pin no.	O	B	C	D
1	GND	Reserved	+5	AD00
2	VI/O 5V	AD02	AD01	+5V
3	AD05	GND	AD04	AD03
4	C/BE0#	AD07	GND	AD06
5	GND	AD09	AD08	GND
6	AD11	VI/O	AD10	M66EN
7	AD14	AD13	GND	AD12
8	+3.3V	C/BE1#	AD15	+3.3V
9	SERR#	GND	--	PAR

PCI-104 or PCI part of the PC/104-Plus interface, X7				
10	GND	PERR#	+3.3V	--
11	STOP#	+3.3V	LOCK#	GND
12	+3.3V	TRDY#	GND	DEVSEL#
13	FRAME#	GND	IRDY#	+3.3V
14	GND	AD16	+3.3V	C/BE2#
15	AD18	+3.3V	AD17	GND
16	AD21	AD20	GND	AD19
17	+3.3V	AD23	AD22	+3.3V
18	IDSEL0 = AD28	GND	IDSEL1= AD29	IDSEL2 = AD30
19	AD24	C/BE3#	VI/O	IDSEL3 = AD31
20	GND	AD26	AD25	GND
21	AD29	+5V	AD28	AD27
22	+5V	AD30	GND	AD31
23	REQ0#	GND	REQ1#	VI/O
24	GND	REQ2#	+5V	GNT0#
25	GNT1#	VI/O	GNT2#	GND
26	+5V	CLK0	GND	CLK1
27	CLK2	+5V	CLK3	GND
28	GND	INTD#	+5V	RST#
29	+12V	INTA#	INTB#	INTC#
30	-12V	Reserved	Reserved	GND

16.2 BIOS Setup

16.2.1 Overview

BIOS Setup program

BIOS Setup program is stored in ROM BIOS. System configuration data are stored in battery-backed RAM of the device.

SETUP can be used to define the hardware configuration (for example, the hard disk type) and system properties. SETUP is also used to set the time and date of the realtime clock.

Changing the device configuration

Your device configuration is preset for operating with the included software. You should only change the default values if you have modified the technical configuration your device, or if a fault occurs when the unit is powered up.

16.2.2 Starting BIOS Setup

Starting BIOS Setup

Start the setup program as follows:

1. Reset the device (warm or cold restart).

In the figures shown, the default settings differ based on the device versions. With the default setting of your device, the display shown below appears following power-on, **for example:**

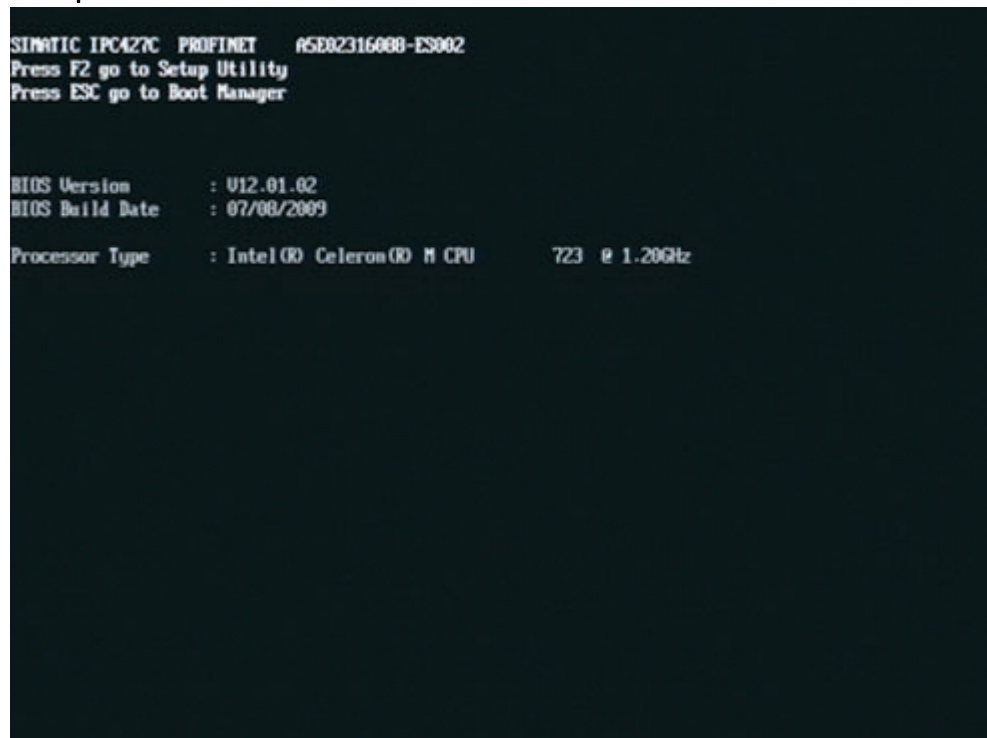

On completion of the POST, the BIOS gives you the opportunity of starting the SETUP program. The following message appears on the screen:

```
PRESS F2 go to Setup Utility OR
Press ESC go to Boot Manager
```

2. Press F2 key as long as BIOS prompt appears on screen.

16.2.3 BIOS Setup menus

The various menus and submenus are listed on the next pages. You can obtain information on the selected SETUP item from the "Item-specific help" part of the respective menu.

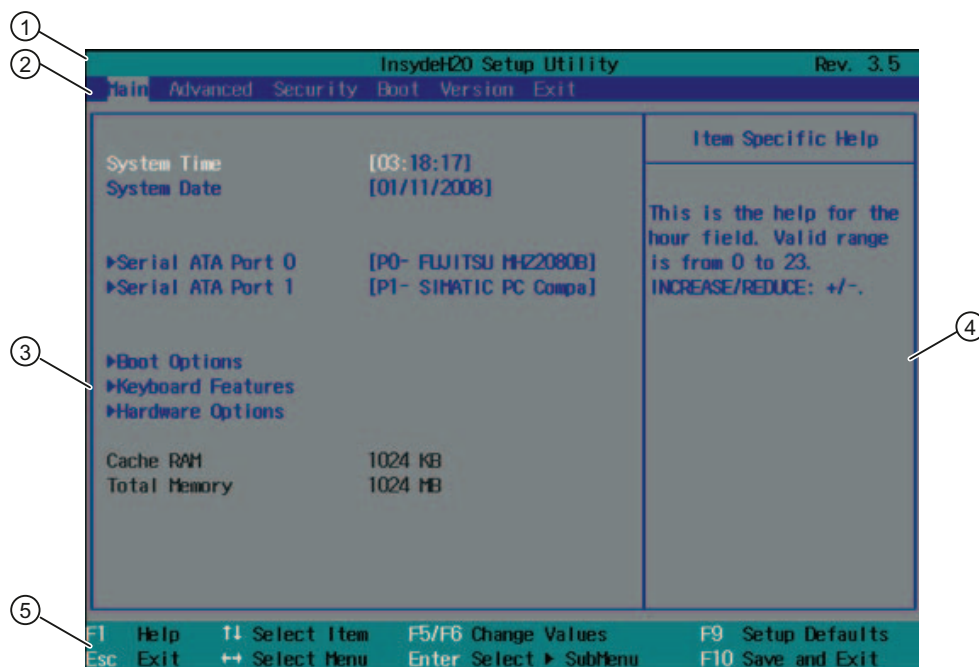

Figure 16-2 BIOS SETUP menu (example)

① Header	④ Help window
② Menu bar	⑤ Command line
③ Selectable submenu	

Menu layout

The screen is divided into four sections. In the top section ②, you can select the submenus [Main] [Advanced] [Security] [Boot] [Version] [Exit]. You can select various settings or submenus in the left middle section ③. Short help texts are displayed on the right ④ for currently selected menu entries; the bottom section contains information for operator input.

The following figures represent examples of specific device configurations. The screen content may deviate slightly depending on the equipment actually supplied.

You can move between the menu forms using the cursor keys [←] left and [→] right.

Menu	Description
Main	System functions are set here
Advanced	An extended system configuration can be set here
Security	Security functions are set here, for example, a password.
Boot	This is where the boot priority is specified.

Menu	Description
Version	Information about the programming device (for example, release status) can be found here.
Exit	Used for terminating and saving.

16.2.4 Main menu

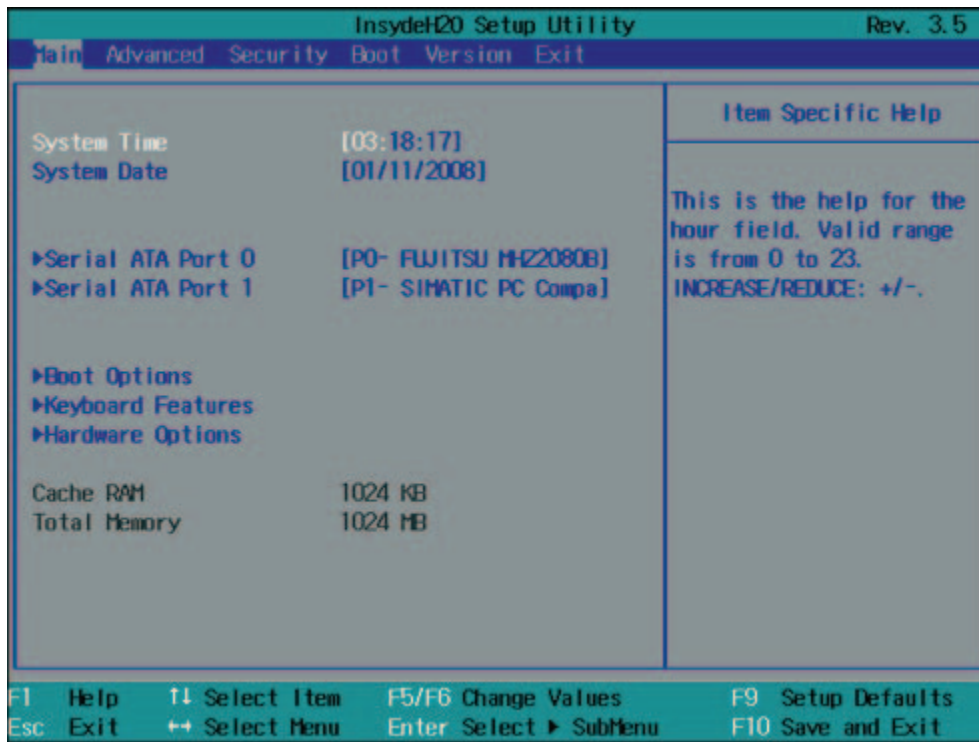

Figure 16-3 Main menu

Settings in the main menu

In the main menu, you can move up and down to select the following system configuration boxes by means of the [↑] up and [↓] down cursor keys:

Field	Meaning
System Time	For viewing and setting the current time
System Date	For viewing and setting the current date
by submenus	
Serial ATA Port 0	Type of installed drives
Serial ATA Port 1	Type of installed drives
Boot options	Used for setting the boot options
Keyboard Features	Used for setting the keyboard interface (Numlock)
Hardware Options	Used for setting the hardware options

System time and date

System Time and System Date indicate the current values. Once you have selected the appropriate option, you can use the [+] and [-] keys to modify the time setting

Hour: Minute: Second

and for the date

Month/Day/Year

You can navigate through the entries within the date and time fields (for example, from hour to minute) using the Enter key.

Serial ATA Port 0, Serial ATA Port 1

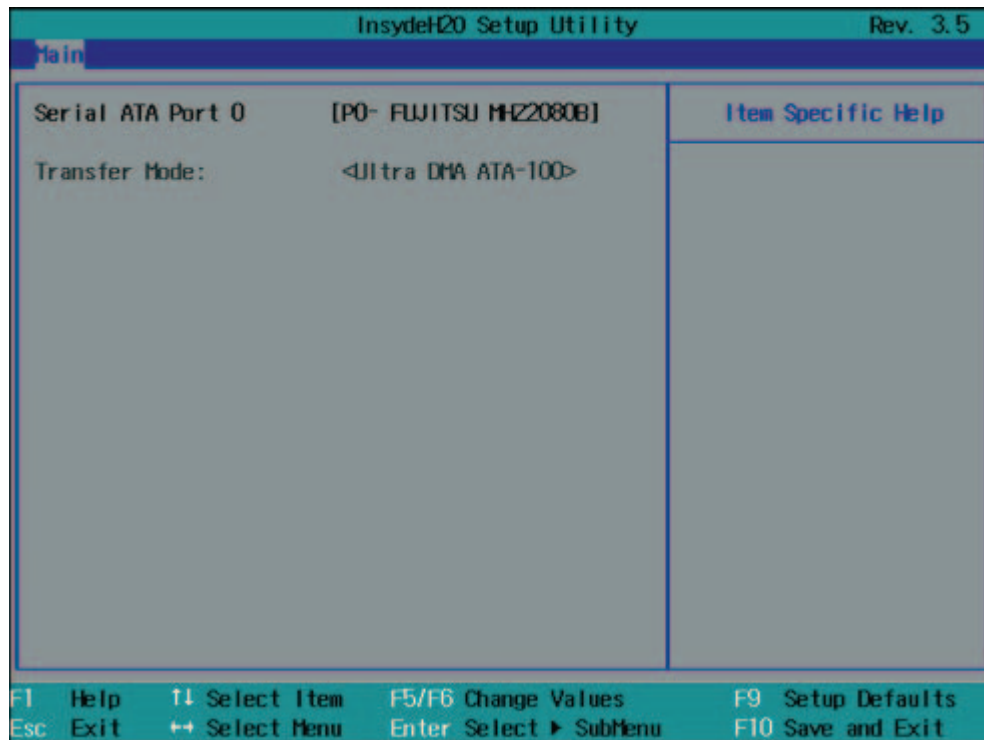

Figure 16-4 "Serial ATA Port 0" submenu (example)

Transfer Mode	Fast PIO	This field shows the transmission speed of the interface. The displayed value depends on the type of drive connected.
	Ultra DMA ATA-33	
	Ultra DMA ATA-66	
	Ultra DMA ATA-100	Exit the submenu by pressing ESC.

"Boot Options" submenu

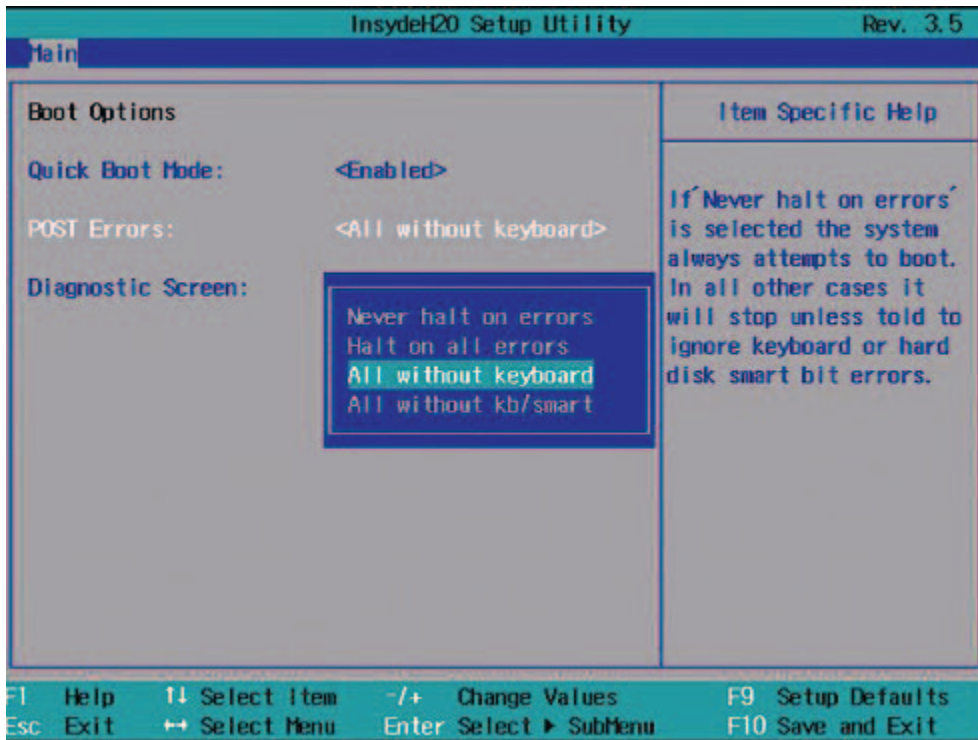

Figure 16-5 "Boot Options" submenu

Quick Boot Mode	Some hardware tests are skipped to speed up the boot sequence.	
POST errors	The boot sequence is stopped if an error is detected during booting; you must press F1 to acknowledge.	
	Never halt on errors	Bootting continues if errors occur
	Halt on all errors	Bootting is stopped if an error is detected
	All without keyboard	Bootting is stopped if any error except a keyboard error occurs
	All without kb/smart	Stop at any error, but not with a keyboard or S.M.A.R.T storage media error.
Diagnostic screen	Shows the diagnostics messages on the monitor during booting.	

"Keyboard Features" submenu

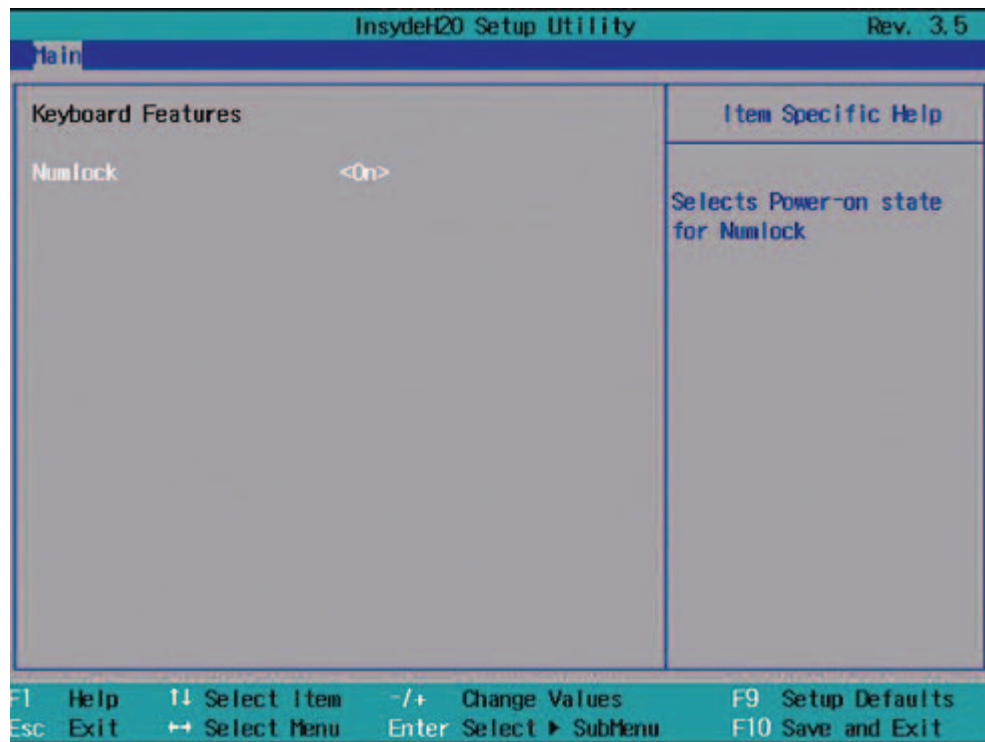

Figure 16-6 "Keyboard Features" submenu

Numlock	On	Switches Numlock on or off following power on.
	Off	

"Hardware Options" submenu

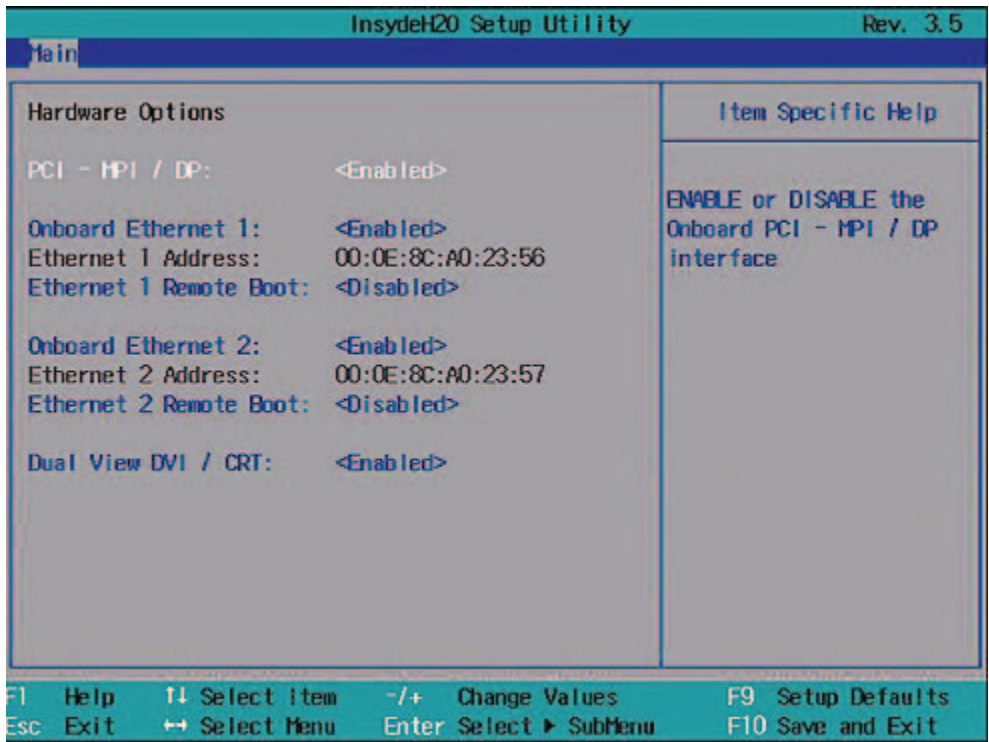

Figure 16-7 "Hardware Options" field (example PROFIBUS)

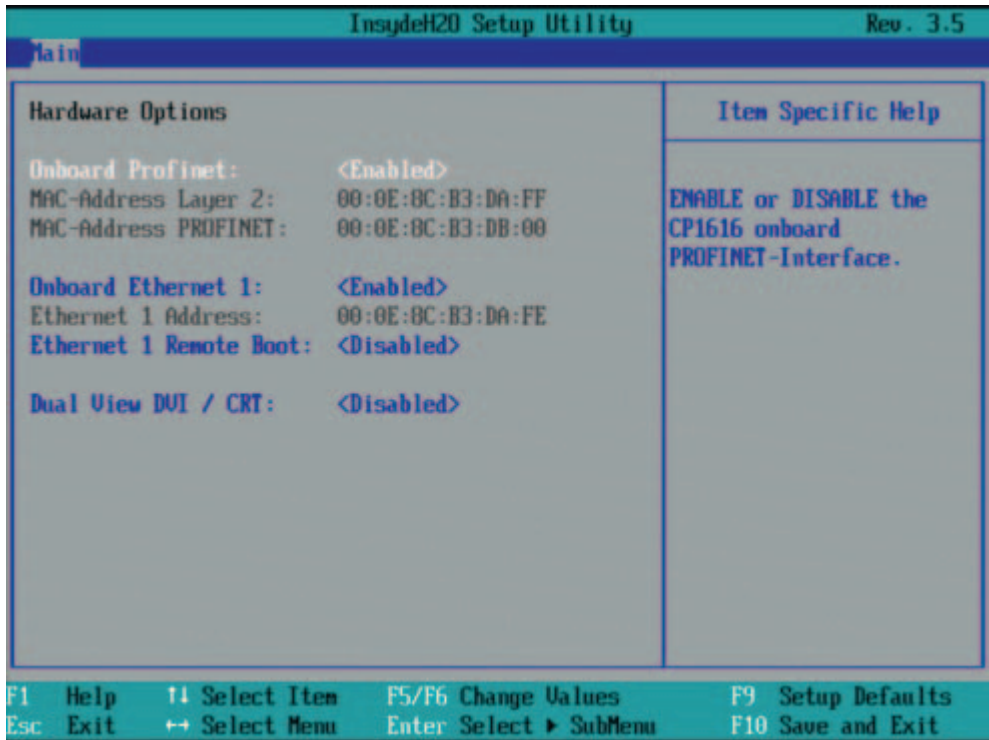

Figure 16-8 "Hardware Options" field (example PROFINET)

The parameters of the interfaces present on the motherboard are set here.

Entry	Meaning	
PCI-MPI/DP *	Enabled	Sharing the MPI/DP interface. The resources are managed by the BIOS PCI Plug and Play mechanism.
	Disabled	The MPI/DP interface is disabled.
Onboard Profinet *	Enabled	CP 1616 onboard is enabled
	Disabled	CP 1616 onboard is disabled
MAC address layer 2 *		This address is for NDIS applications. Example: 00:0E:8C:B3:DA:FF
MAC address Profinet *		This is the main address for PROFINET applications. Example: 00:0E:8C:B3:DB:00 The MAC addresses of the individual ports are derived from "MAC Address Profinet". They are not displayed in the BIOS Setup.
Onboard Ethernet 1/2 *	Enabled	The Ethernet port on the motherboard is enabled.
	Disabled	The Ethernet port on the motherboard is disabled.
Ethernet 1/2 address *	Shows the individual Ethernet address.	
Ethernet 1/2 Remote Boot *	Enabled	Booting via a connected LAN is possible.
	Disabled	Booting via LAN is not possible.
Dual view DVI/CRT	Enabled	Dual view DVI/CRT is available via the DVI-I socket.
	Disabled	Only one monitor can be enabled via the DVI/VGA socket.
* This menu item depends on the device configuration.		

Note

Support for Ethernet interface 2 is OS dependent. For DOS-based applications (e.g. SIMATIC IPC Image & Partition Creator), use Ethernet interface 1 and disable Ethernet interface 2 in BIOS Setup. This is practical because some programs use the second Ethernet interface because it is the first one found on the PCI bus.

16.2.5 Advanced Menu

Menu layout

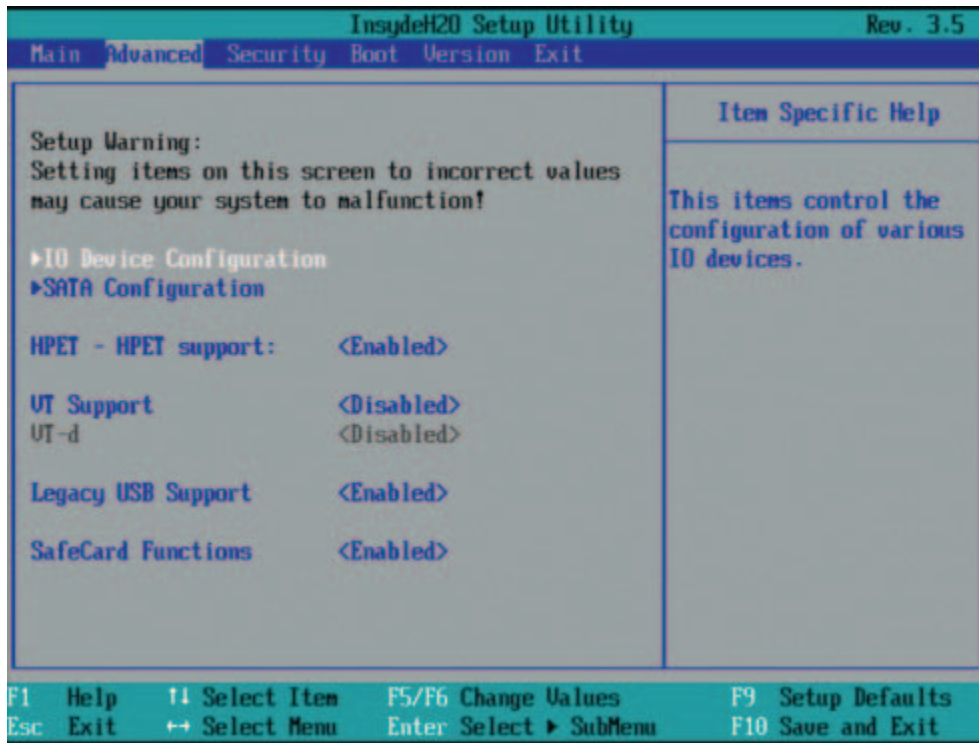

Figure 16-9 Advanced Menu

Settings in the Advanced Menu

HPET - HPET support	Disabled	High Precision Event Timer is disabled.
	Enabled	High Precision Event Timer is enabled.
VT Support	Enabled	Virtualization Technology Support of the CPU is enabled.
	Disabled	Virtualization Technology Support of the CPU is disabled.
VT -d	Enabled	Virtualization Technology Support for directed I/O is enabled.
	Disabled	Virtualization Technology Support for directed I/O is disabled.
Legacy USB support	Disabled	Disables Legacy Universal Serial Bus support. Booting via USB media is not possible: but USB keyboard and USB mouse work.
	Enabled	Enables Legacy Universal Serial Bus support Booting via USB media is possible and the USB keyboard and USB mouse work. The USB Boot function must be enabled to allow booting from a USB device, or if the system is to be operated without USB support with a USB keyboard or mouse.

SafeCard functions	Enabled	Watchdog reset is enabled.
	Disabled	Watchdog reset is disabled.
	The relevant driver and the application must be started for operation of the monitoring functions.	

"IO Device Configuration" submenu

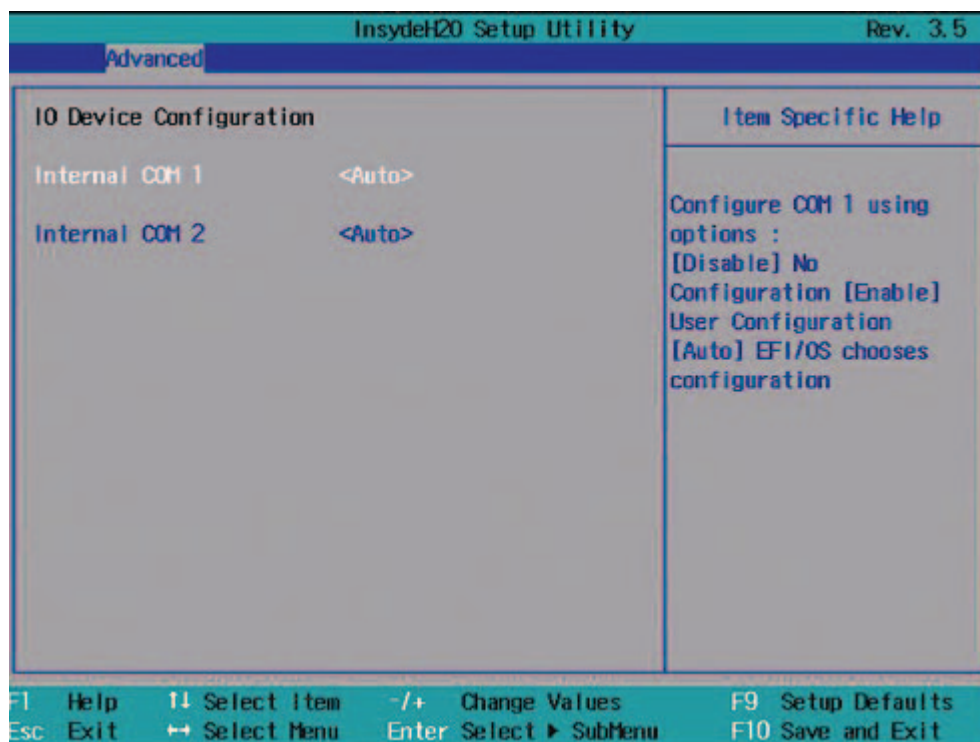

Figure 16-10 "IO Device Configuration" submenu

Internal COM 1 / COM 2 (COM2 optional)	Disabled	COM 1 or COM 2 is always disabled.
	Auto	BIOS switches on the COM. Resources are assigned in the OS per reconfiguration.
	Enabled	COM 1 or COM 2 is always enabled. BIOS assigns resources to COM.

"SATA Configuration" submenu

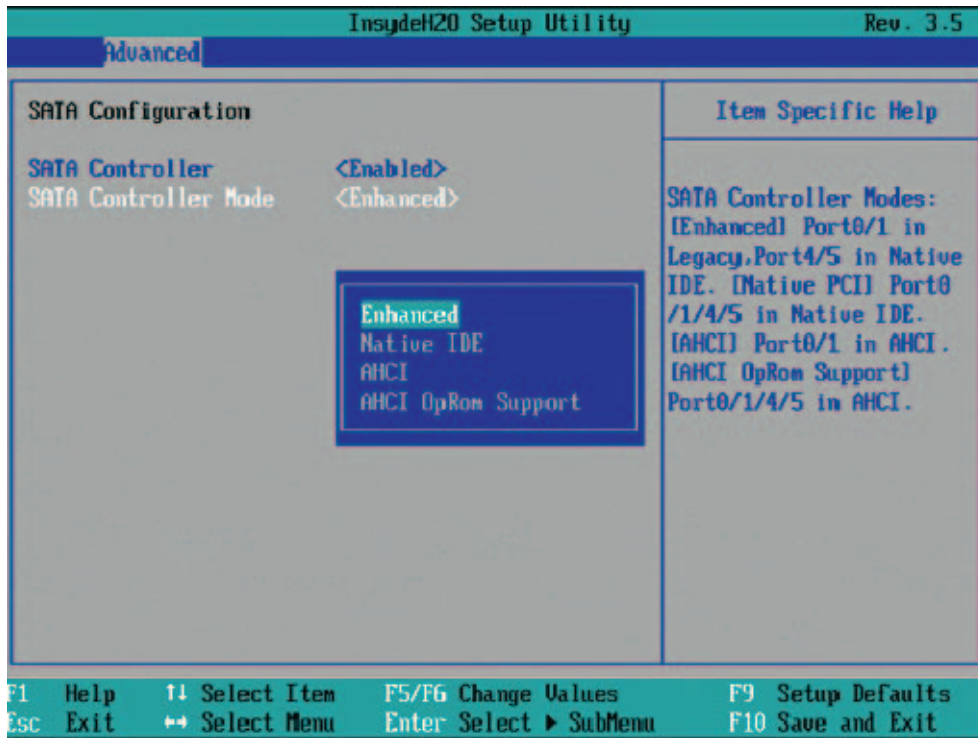

Figure 16-11 "SATA Configuration" submenu

SATA Controller	[Enabled] [Disabled]	Disables or enables the SATA controller
SATA Controller mode	[Enhanced]	Serial ATA Ports 0/1 work in Legacy Mode. Serial ATA Ports 4/5 work in Native IDE Mode.
	Native PCI	Serial ATA Ports 0/1/4/5 work in Native IDE Mode.
	AHCI	Serial ATA Ports 0/1 work in AHCI Mode (only relevant for IPC427C).
	AHCI OpRom Support	Serial ATA Ports 0/1/4/5 operate in AHCI mode with ROM support option (setting for Panel IPC; irrelevant for IPC427C).

16.2.6 Security menu

You can only edit the fields enclosed in square brackets. Two passwords can be assigned to protect your PC from unauthorized use. The Supervisor password can be used to restrict access to the hard disks.

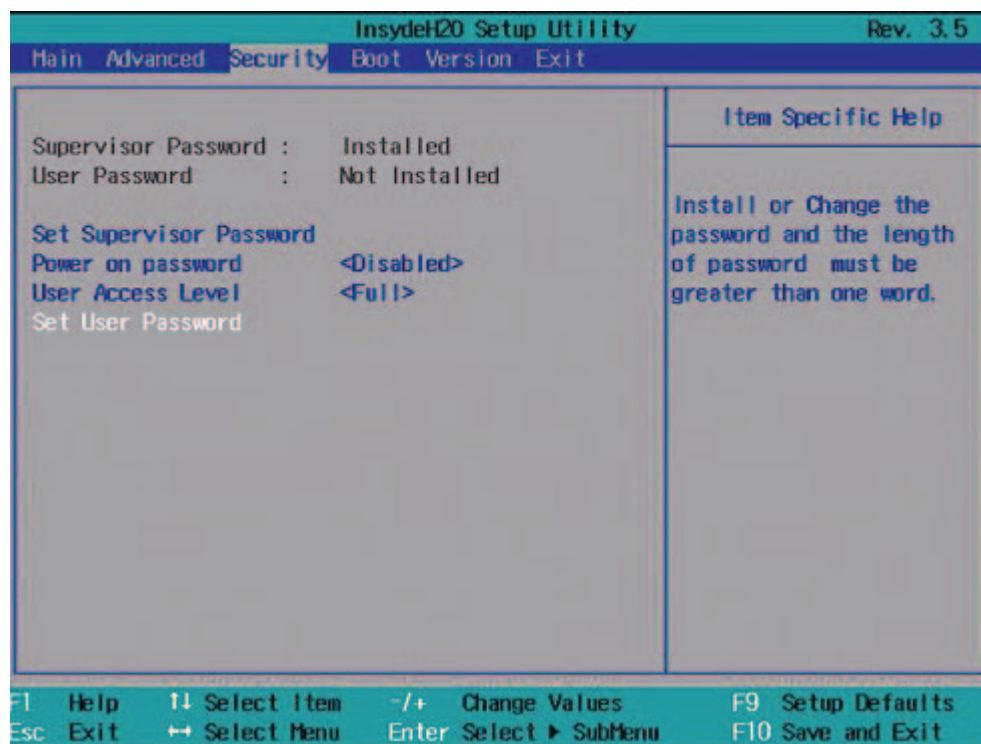

Figure 16-12 "Security" menu (example)

Supervisor Password	Installed	Certain Setup fields are configurable by the user, including the user password.
	Not installed	The password is disabled.
User password	Installed	Certain setup fields can be changed by the user, including the user password.
	Not installed	The password is disabled.
Set Supervisor Password	This field opens the password input dialog. Authorized logged on users can change the supervisor password, or delete and deactivate it by pressing "Return."	
Power on password	Enabled	Password must be entered to boot.
	Disabled	Password must be entered to access BIOS Setup.
User Access Level	View only	Setup is accessible, but fields cannot be changed.
	Limited	Some setup entries can be changed.
	Full	All setup entries can be changed, except for the supervisor password.
Set User Password	This field opens the password input dialog. Logged on users can change the password, or clear and deactivate it by pressing "Return."	

16.2.7 Boot menu

This menu allows you to assign a priority for the boot devices.

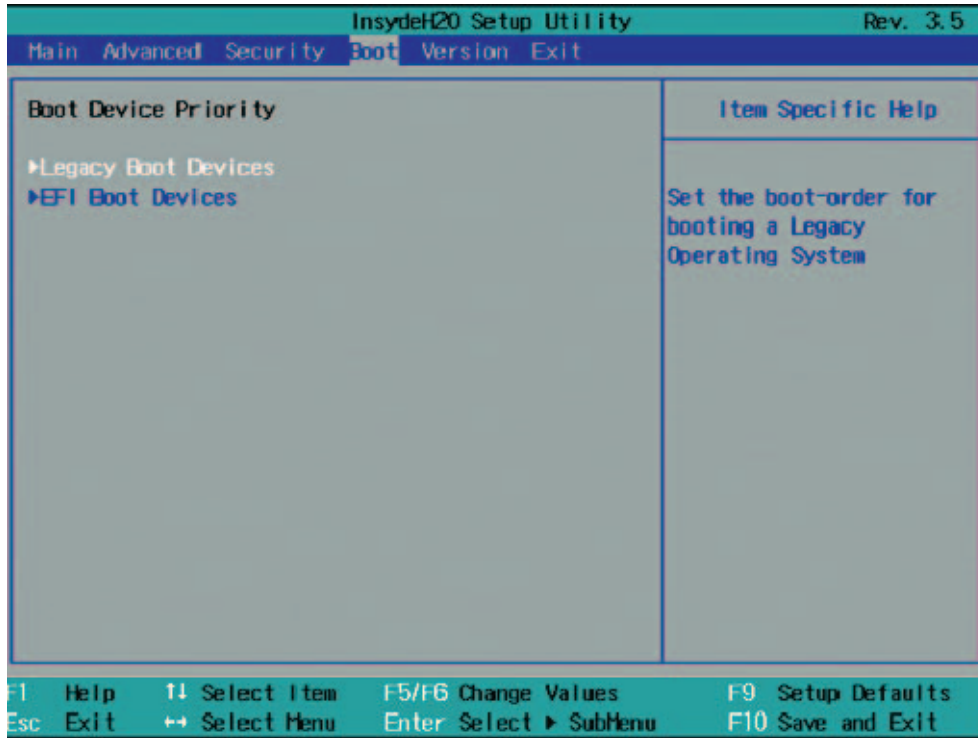

Figure 16-13 "Boot" menu

Legacy

Specifies the boot sequence for boot devices with Legacy operating systems.

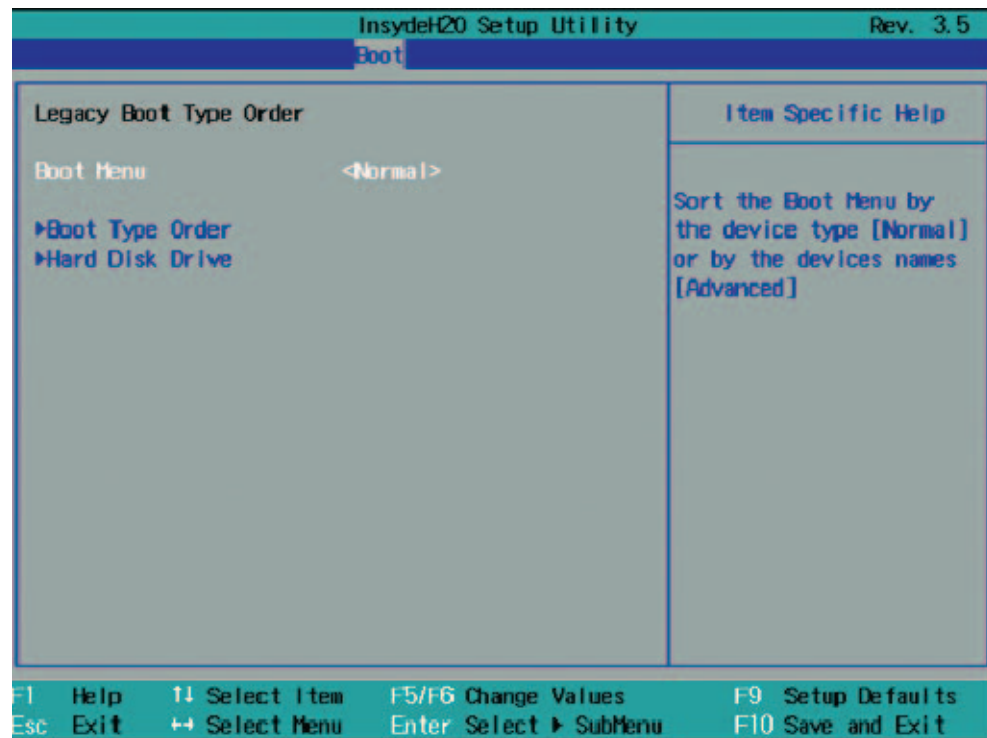

Figure 16-14 "Legacy" submenu

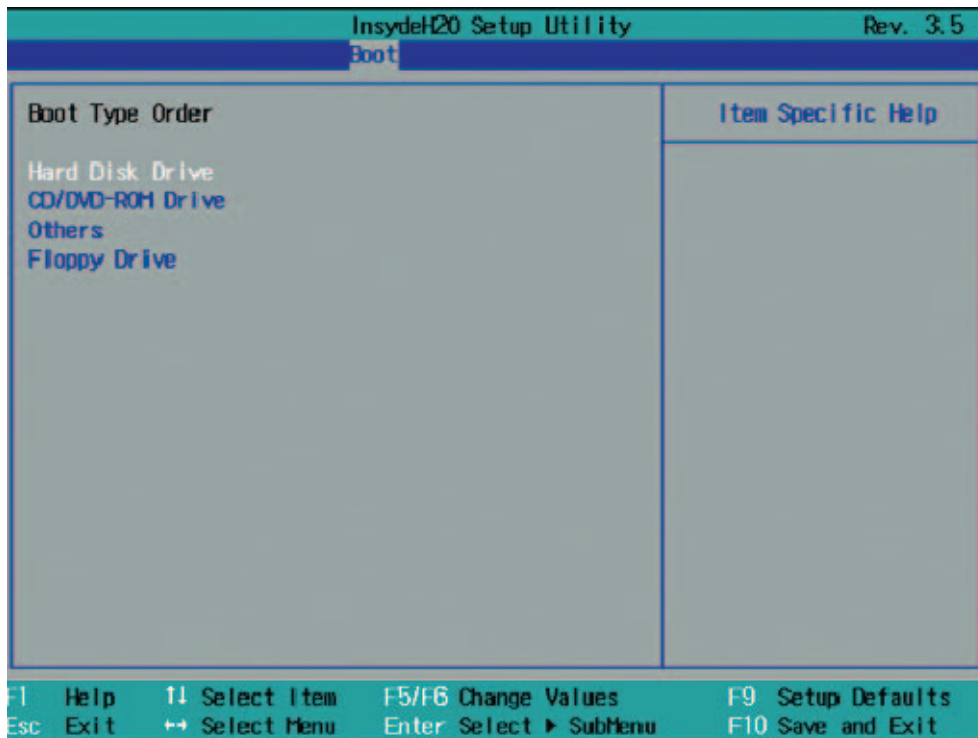
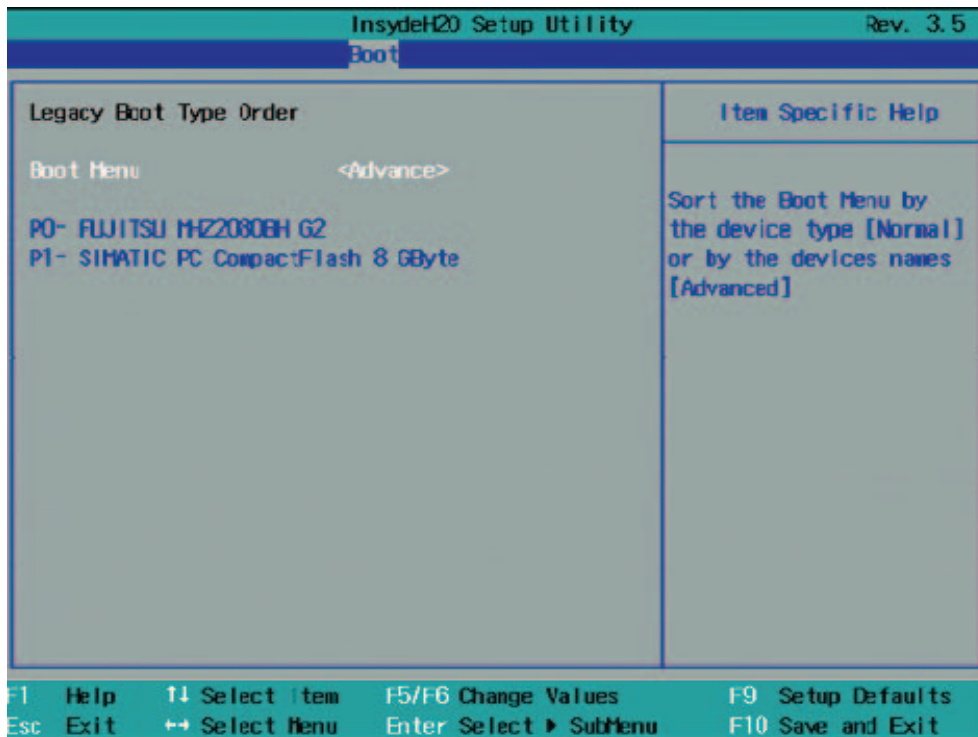

Figure 16-15 "Boot Type Order" field

This screen shows all possible legacy boot types. The boot type with highest boot priority is shown at the top. To change the sequence:

Select the boot source with the ↑ ↓ keys, move to the desired position with + or -.



Note

You can open the Boot menu and select the boot volume by pressing the ESC key during system startup.

16.2.8 Version menu

Keep this information at hand if customer support has technical questions about your system.

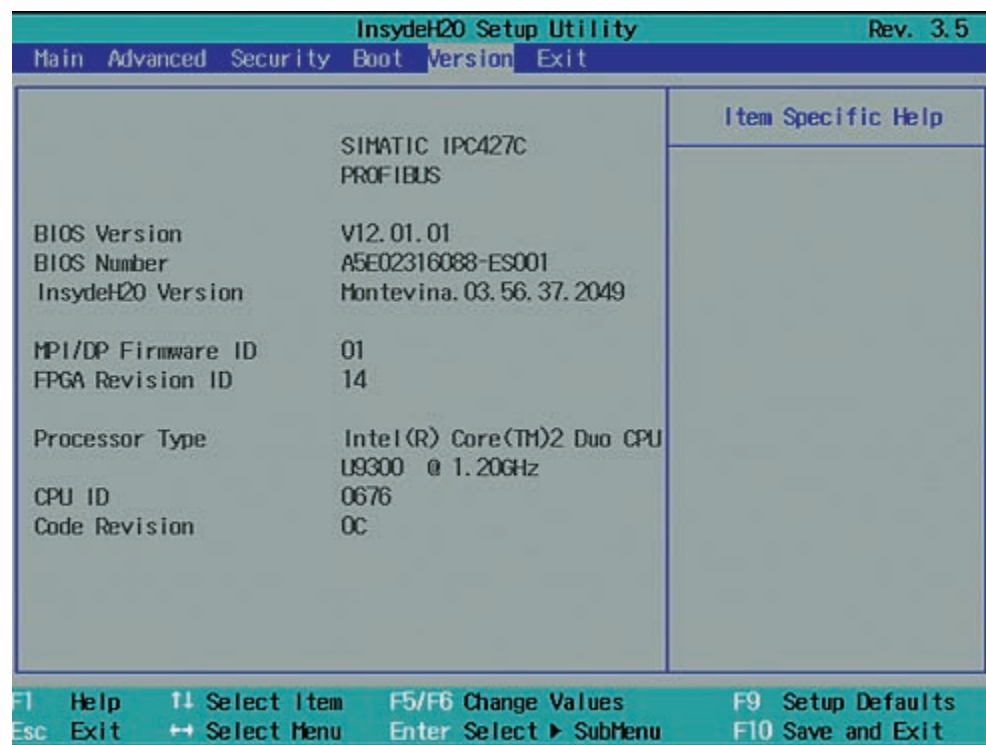

Figure 16-16 Version menu (example)

16.2.9 Exit Menu

You always exit BIOS Setup in this menu.

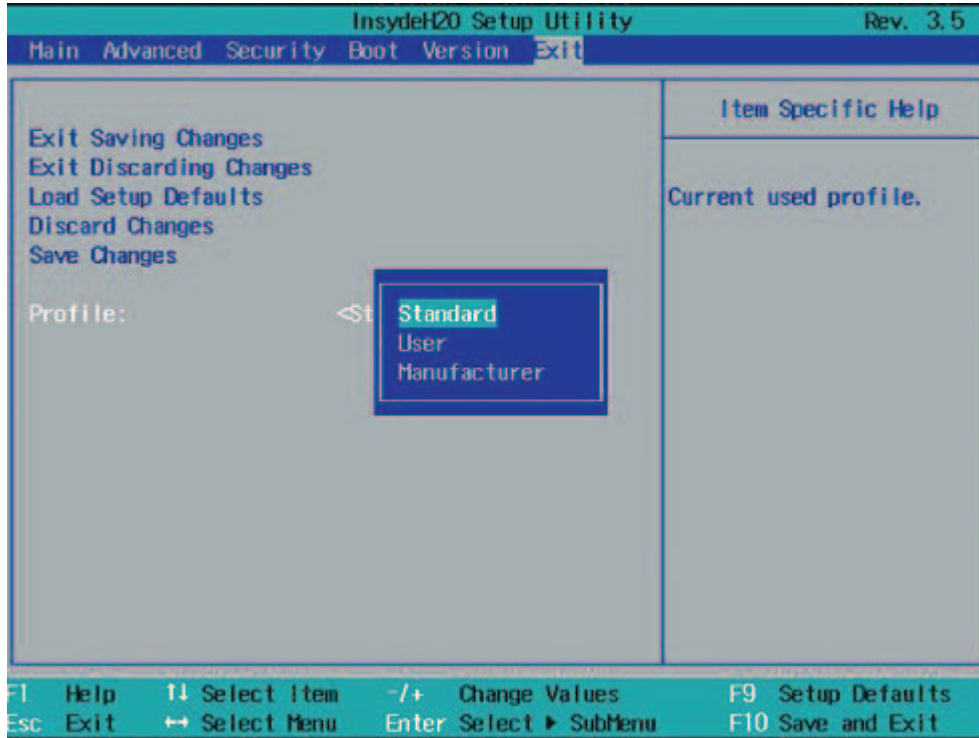

Figure 16-17 Exit menu

Exit Saving Changes	All changes are saved and the system is restarted with the new parameters.	
Exit Discarding Changes	All changes are discarded and the system is restarted with the old parameters.	
Load Setup Defaults	The default values are loaded.	
Discard Changes	All changes are discarded.	
Save Changes	All changes are saved	
Profiles	Standard	The BIOS settings are backed up to buffered CMOS
	User	The BIOS settings are saved in the non-volatile FLASH memory.
	Manufacturer	This setting is only used for production purposes. Do not use.

16.2.10 Default BIOS Setup entries

Documenting your device configuration

If you have changed any default settings in Setup, you can enter them in the following table. You can then refer to these entries for any future hardware modifications.

Note

Print out the table below and keep the pages in a safe place once you made your entries.

BIOS Setup default settings

System parameters	Defaults	Custom entries
Main		
System Time	hh:mm:ss	
System Date	MM/DD/YYYY	

Serial ATA Port 0, Serial ATA Port 1		
Transfer Mode		

Boot options		
Quick Boot Mode	Enabled	
POST errors	All without keyboard	
Diagnostic screen	Enabled	

Keyboard Features		
Numlock	On	

Hardware Options		
PCI - MPI/DP ¹⁾	Enabled	
Internal CAN ²⁾	Enabled	
CAN bus I/O address ²⁾	5400	
On-board Ethernet 1	Enabled	
Ethernet 1 Address	00.0E.8C.xx.xx.xx	
Ethernet 1 Remote Boot	Disabled	
Onboard Ethernet 2 ³⁾	Enabled	
Ethernet 2 address ³⁾	00.0E.8C.xx.xx.xx	
Ethernet 2 Remote Boot ³⁾	Disabled	
Onboard Profinet ⁴⁾	Enabled	

Hardware Options		
MAC address layer 2 ⁴⁾	00.0E.8C.xx.xx.xx	
MAC address PROFINET ⁴⁾	00.0E.8C.xx.xx.xx	
Dual view DVI/CRT	Disabled	

1) only for versions with PROFIBUS

2) only for versions with CAN bus

3) not for PROFINET versions

4) only for versions with PROFINET

Advanced		
HPET - HPET support	Enabled	
VT Support	Disabled	
VT -d	Disabled	
Legacy USB support	Enabled	
SafeCard functions	Enabled	

IO device configuration		
Internal COM 1	Auto	
Internal COM 2	Auto	

SATA Configuration		
SATA Controller	Enabled	
SATA Controller mode	Enhanced	

Security		
Supervisor Password	Not installed	
User password	Not installed	
Set Supervisor Password		
Power on password		
User Access Level		
Set User Password		

Boot		
Legacy Boot Devices		
EFI Boot Devices		

Legacy Boot Type Order		
Boot menu	Standard	

Version		
SIMATIC PC	IPC427C PROFIBUS	
BIOS Version	V12.01.xx	
BIOS Number	A5E02316088-ES0xx	
InsideH20 Version	Montevina.03.56.37.20xx	
MPI / DP Firmware ID	xx	
FPGA Revision ID	xx	
Processor Type		
CPU ID		
Code Revision		

16.3 System resources

16.3.1 Currently allocated system resources

All system resources (hardware addresses, memory configuration, allocation of interrupts, DMA channels) are assigned dynamically by the Windows OS, depending on the hardware configuration, drivers and connected external devices. You can view the current configuration of system resources or possible conflicts with the following operating systems:

Windows Embedded Standard 2009	Start > Run : In the Open dialog, enter <i>msinfo32</i> and confirm with OK
--------------------------------	---

16.3.2 System resources used by the BIOS/DOS

The following tables and pictures describe the system resources for the factory state of the device.

16.3.2.1 PCI Interrupt Lines

The interrupts are assigned to devices by BIOS. Exclusive non-shared interrupts are available for the first two PCI-104 or PC/104-*Plus* slots as well as for DP12 and the first Ethernet interface.

This means that applications or realtime operating system extensions can operate these devices exclusively and with high-performance without having to share the interrupt with other devices.

Table 16- 1 Interrupt sharing in APIC mode

Interrupt		Interrupt type
IRQ0	System Timer / HPET	ISA exclusive
IRQ1	PS/2 keyboard controller emulation	ISA exclusive
IRQ2	Interrupt controller 2	ISA exclusive
IRQ3	Reserved for Com Port 2 (COM2)	ISA exclusive (COM2)
IRQ4	Com Port 1 (COM1)	ISA exclusive
IRQ5	Free	
IRQ6	Reserved	
IRQ7	Free	
IRQ8	Realtime clock	ISA exclusive
IRQ9	ACPI-SCI (system control interrupt)	
IRQ10	CAN (optional) or free	ISA exclusive (CAN)
IRQ11	Free	
IRQ12	PS/2 mouse controller emulation	ISA exclusive
IRQ13	Coprocessor	ISA exclusive
IRQ14	Primary IDE Channel (enhanced mode)	ISA exclusive
IRQ15	Secondary IDE Channel (enhanced mode)	ISA exclusive
IRQ16	Graphics, PCI-Express Bridge, LAN2, SATA Controller 2 (enhanced / native IDE mode)	PCI shared
IRQ17	LAN1 exclusive	PCI exclusive
IRQ18	SATA-AHCI Controller (AHCI mode), SATA Controller 1 (native IDE mode)	PCI shared
IRQ19	DP12/MPI or PROFINET (optional)	PCI exclusive
IRQ20	PCI104 Slot 1	PCI exclusive
IRQ21	PCI104 Slot 2	PCI exclusive
IRQ22	PCI104 Slot 3, USB-UHCI Controller 1-3 (USB1.1), USB-EHCI Controller 1 (USB2.0)	PCI shared
IRQ23	PCI104 Slot 3, USB-UHCI Controller 4-6 (USB1.1), USB-EHCI Controller 2 (USB2.0)	PCI shared

16.4 I/O Address Areas

16.4.1 Overview of the internal module registers

Overview of the internal module registers

The following addresses are used for the internal registers:

Addresses	Input/output unit
I/O 062h	Watchdog enable register / 066h select register (Page 145)
I/O 066h	Watchdog trigger register (Watchdog enable register bit 2=0) (Page 146)
	CAN base address register (Watchdog enable register bit 2=1) (Page 146)
I/O 404Eh - 404Fh	Output register LED 1/2 and SF LED / RUN/STOP LED (Page 147)
I/O 50Fh	Battery status register (read-only) (Page 147)

16.4.2 Watchdog enable register / 066h select register (read/write, address 062h)

Meaning of the bits

Watchdog enable register / 066h select register (r/w address 062h)								
Bit								Meaning of the bits
7	6	5	4	3	2	1	0	
								Watchdog enable bit (WDE)
							0	Watchdog circuit disabled
							1	Watchdog circuit enabled
								Watchdog Mode
							0	Standard
							1	Macro
								066h select register selection
							0	066h is Watchdog trigger register
							1	066h is CAN base address register
								Scaler watchdog time (Normal/Macro)
		0	0	0				94 ms / 2 s (default)
		0	0	1				210 ms / 4 s
		0	1	0				340 ms / 6 s
		0	1	1				460 ms / 8 s
		1	0	0				590 ms / 16 s
		1	0	1				710 ms / 32 s
		1	1	0				840 ms / 48 s

Watchdog enable register / 066h select register (r/w address 062h)									
		1	1	1					960 ms / 64 s
Trigger red Watchdog LED									
	0								Red LED (WD) off
	1								Red LED (WD) on
Watchdog error / Display and reset									
0									WD inactive
1									WD triggered Reset LED after watchdog alarm (Bit 7 = write 1)

16.4.3 Watchdog trigger register (read only, address 066h)

Watchdog trigger register

The watchdog is triggered by a read action (address 066h) by this register. The result of the read access can be disregarded (i.e., dummy read).

16.4.4 CAN base address register (write only, address 066h)

A 512 byte window is created in the I/O area for the CAN controller (Philips SJA1000). The block itself only needs 32 or 128 bytes of this depending on the operating mode. The address window can be selected in 1024 byte steps between 4000h and 7C00h through the CAN base address register (write only, address 066h).

A limited selection can be preset in the BIOS Setup.

Note

The CAN base address register shares its I/O address with other registers. The watchdog enable register / 066h select register therefore must be selected before access.

Meaning of the bits

CAN base address register (write only, address 066h, Address register selection 1)								
Bit								
7	6	5	4	3	2	1	0	
						0	0	Reserved (Write: 00)
0	1							Reserved (Write:01)
		0	0	0	0			40h
	
	
		1	1	1	1			7Ch

Sets the high byte of the CAN base address 01nnnn00

16.4.5 Output register user LED L1/L2 (read/write, address 404Eh)

Meaning of the bits

Output register LED 1 / 2 (read/write address 404Eh)						
Bits						
15	14	13 - 8	7	6	5 - 0	
	1			1		LED L1 / SF dark (default)
	1			0		LED L1 / SF lights yellow
	0			1		LED L1 / SF lights red (= group fault)
1			1			LED L2 / R/S dark (default)
1			0			LED L2 / R/S lights yellow (= STOP)
0			1			LED L2 / R/S lights green (= RUN)
		xxxxxx			xxxxxx	Reserved (read/write)

Note

The L1 and L2 LEDs indicate by flashing alternatively yellow the progress of the BIOS self-test during the device startup. On completion of the BIOS self-test, the L1 and L2 LEDs go dark.

16.4.6 Battery status tab (read-only, address 50Fh)

The status of the CMOS battery is monitored; the status (two-tier) can be read from the battery status register.

Meaning of the bits

Battery status register (read-only, address 50Fh)								
Bit								Description
7	6	5	4	3	2	1	0	
0	0							CMOS battery capacity is still sufficient.
1	0							CMOS battery capacity is exhausted (remaining capacity is sufficient for approx. one month)
1	1							CMOS battery is empty

16.4.7 SRAM address register

The battery-buffered SRAM uses a 2 MB memory address area, which can be read via the PCI register.

Meaning of the bits

SRAM address register		
PCI register address: SRAM base address register	PCI register content: SRAM memory address (default)	Length of the memory area
8010 2010h	9040 0000h Address is assigned dynamically (depending on device)	20 0000h

16.5 CP 1616 onboard communications processor

16.5.1 Introduction

16.5.1.1 Network connections

Ethernet

The CP 1616 is designed for operation in Ethernet networks. Additional features are:

- The connectors are designed for 10BaseT and 100BaseTX.
- Data transfer rates of 10 and 100 Mbps in full/half duplex mode are supported.
- The handshake is performed automatically (auto negotiation).
- A 3-port realtime switch is located in the module.
- Autocrossing

Three RJ45 connectors

The CP 1616 is connected to the LAN (Local Area Network) via one of the three RJ45 sockets of the PC.

These three sockets lead to the integrated realtime switch.

16.5.1.2 Typical Communication Partners

CP 1616 onboard as an IO controller

The following diagram shows a typical application: CP 1616 onboard as PROFINET IO controller on the IO controller layer.

The IO base controller user program runs on the PC. This program accesses the functions of the IO base user program interface.

Data traffic is routed via the communication processor to several SIMATIC S7 PROFINET IO devices, ET 200S over Industrial Ethernet.

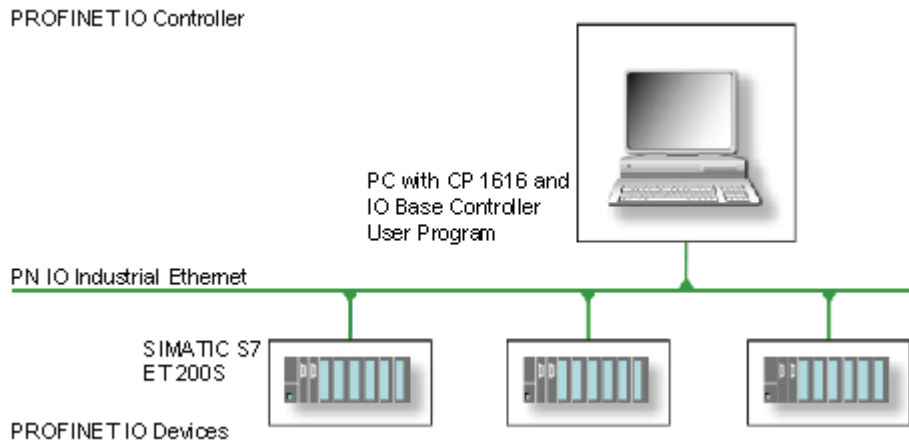

CP 1616 onboard as IO device

The following diagram shows a typical application: Two PCs each with a CP as a PROFINET IO device on the IO device layer.

A PC with a CP as PROFINET IO controller, a SIMATIC S7-400 with a CP 443-1 as PROFINET IO controller and two SIMATIC S7 ET 200S PROFINET IO devices are also connected in the network.

The IO base device user program runs on the IO device PC. This program accesses the functions of the IO base user program interface. Data traffic is routed via the CP 1616 onboard communication processor to a PC as PROFINET IO controller, or to an S7-400 automation system with CP 443-1 over Industrial Ethernet.

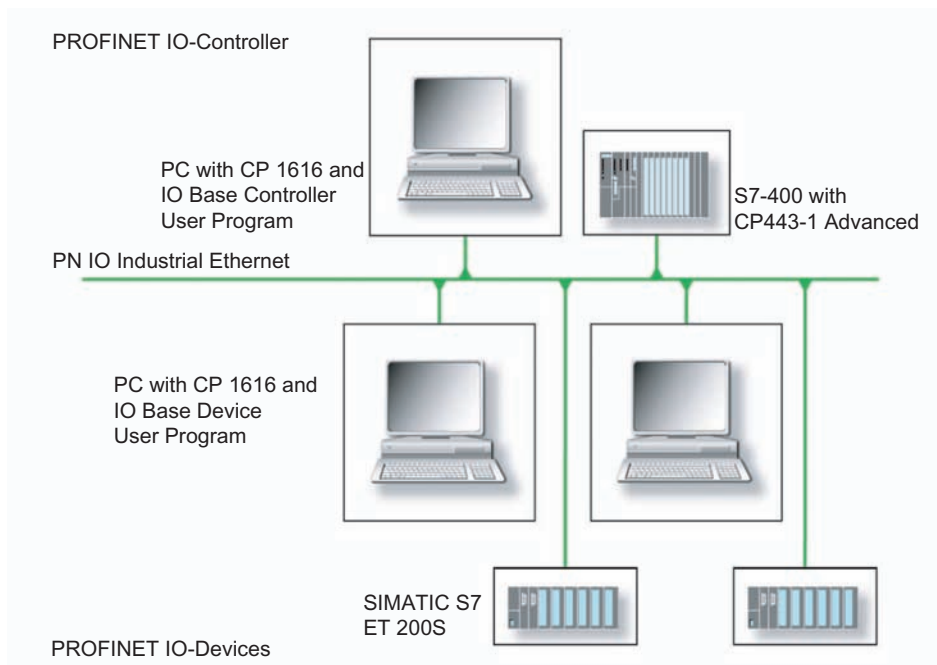

16.5.2 Firmware Loader

Scenario for using the firmware loader

The CP 1616 onboard is supplied with the latest version of the firmware. If new functions become available due to product development, you can make them available by performing a firmware download.

Description

This section will familiarize you with the application area and use of the firmware loader. You can find additional, detailed information about the individual loader variants in the integrated help of the program.

Firmware

This refers to the system program in the SIMATIC NET modules.

Application area for the firmware loader

The firmware loader enables you to reload new firmware releases to SIMATIC NET modules. It is used for:

- PROFIBUS modules
- Industrial Ethernet modules
- Modules for gateways, for example IE/PB link

Installation

The firmware loader is available on your PG/PC under Windows following the installation of STEP 7/NCM PC.

Loader files

The firmware loader supports the following file types:

- <file>.FWL
A file form that contains further information, which is displayed by the firmware loader. The firmware loader can use this information to check if the firmware is compatible to the device.

Read the information provided along with the loader file, for example, in the readme file. This information is also displayed in the firmware loader when the FWL file is loaded.

16.5.2.1 Loading firmware

Start downloading procedure

1. In the Windows Start menu, select the menu command SIMATIC > STEP 7 > NCM S7 > Firmware Loader.

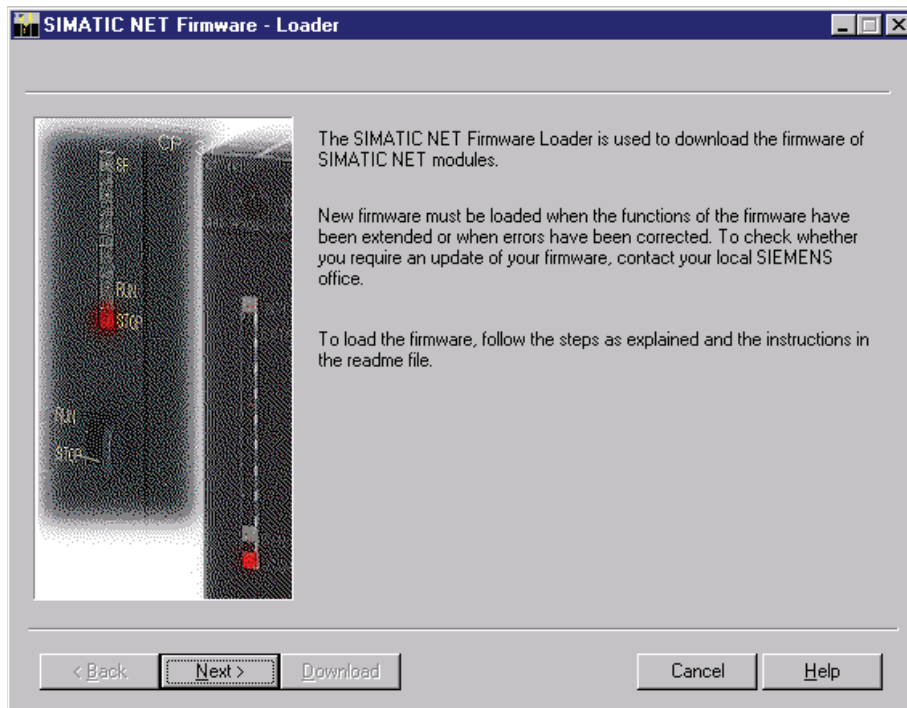

2. Click "Next" and follow the instructions in the dialog fields that follow. A help function is integrated in the software as support.

CAUTION

Ensure that the loader file you are using for the update is suitable for the version of firmware on your module. If you have any doubts, contact your local Siemens consultant.

CAUTION

Be aware that aborting the loading process may result in an inconsistent state in your module.

You can find additional, detailed information about the individual loader variants in the integrated help.

NOTICE

When loading the firmware or commissioning the module, be aware that the CP 1616 onboard takes five MAC addresses (always in direct sequence). The first two are shown in the BIOS.

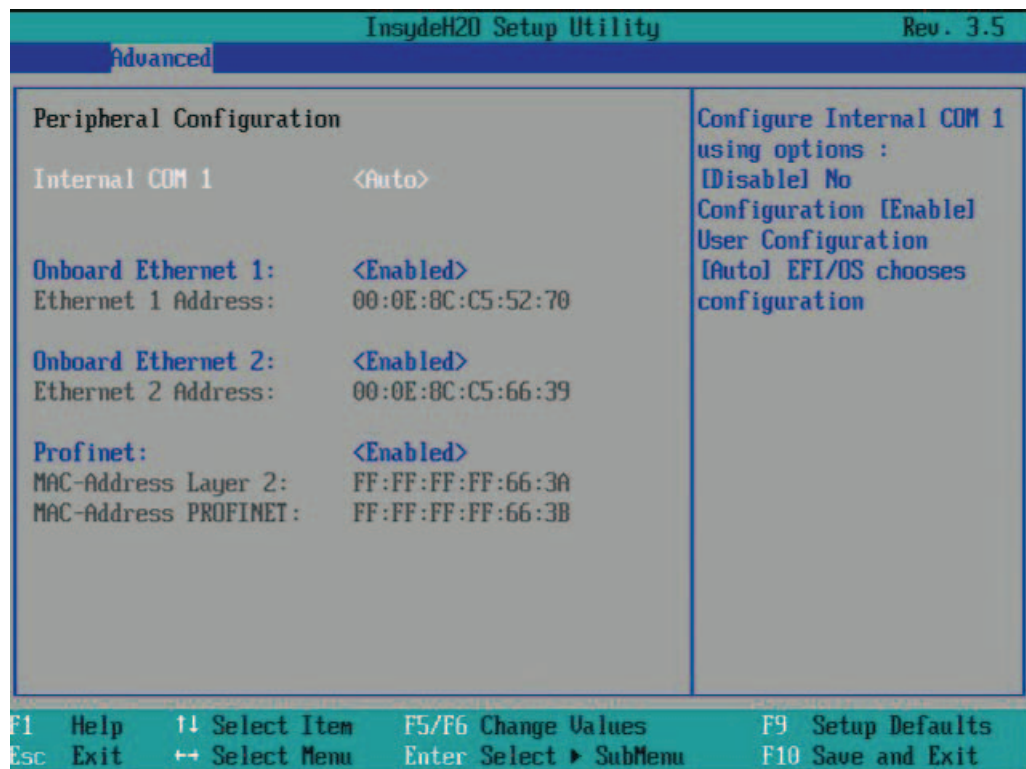

Figure 16-18 Advanced menu Peripheral Configuration

Example

The lower MAC address at "Profinet" is provided for Layer 2 communication, while the second one is used for Ethernet/PROFINET communication.

16.5.3 Further actions in STEP 7/NCM PC

Configuring

Your PC is now ready, although you still have to configure the SIMATIC NET communication software. The rest of the procedure is described in the "Commissioning PC Stations" manual (on the Windows PC that also contains STEP 7/NCM PC: Start > Simatic > Documentation > English > Commissioning PC Stations).

Appendix

A

A.1 Guidelines and declarations

Notes on the CE Label



The following applies to the SIMATIC product described in this documentation:

EMC directive

The devices meet the requirements for the EC directive "2004/108/EEC Electromagnetic Compatibility," and the following fields of application applies according to this CE label:

Area of application	Requirement for	
	Emitted interference	Immunity to interferences
Residential area, business and trade areas and small businesses.	EN 61000-6-3: 2007	EN 61000-6-1: 2007
Industry	EN 61000-6-4: 2007	EN 61000-6-2: 2005

Declaration of conformity

The EC declaration of conformity and the corresponding documentation are made available to authorities in accordance with the EC directives stated above. Your sales representative can provide these on request.

Note the installation guidelines

The installation guidelines and safety instructions given in this documentation have to be noted during commissioning and operation.

Connecting peripherals

Noise immunity requirements to EN 61000-6-2 / IEC 61000-6-2 are met if connected peripherals are suitable for industrial applications. Peripheral devices are only be connected via shielded cables.

A.2 Certificates and approvals

DIN ISO 9001 certificate

The Siemens quality management system for all production processes (development, production and sales) meets DIN ISO 9001:2000 requirements.

This has been certified by DQS (the German society for the certification of quality management systems).

Q-Net certificate no.: DE-001108 QM

Software License Agreement

The device is shipped with preinstalled software. Please observe the respective license agreements.

Approvals for the USA, Canada and Australia

Product safety

The following approvals are available for the device:	
	Underwriters Laboratories (UL) according to Standard UL 60950-1, File E115352 and Canadian National Standard CAN/CSA-C22.2 No. 60950-1 (I.T.E) or according to UL508, File E85972 and Canadian National Standard CAN/CSA-C22.2 No. 142 (IND.CONT.EQ) or according to Canadian National Standard CAN/CSA-C22.2 No. 14-05

EMC

USA	
Federal Communications Commission Radio Frequency Interference Statement	This equipment has been tested and found to comply with the limits for a Class A digital device, pursuant to Part 15 of the FCC Rules. These limits are designed to provide reasonable protection against harmful interference when the equipment is operated in a commercial environment. This equipment generates, uses, and can radiate radio frequency energy and, if not installed and used in accordance with the instruction manual, may cause harmful interference to radio communications. Operation of this equipment in a residential area is likely to cause harmful interference in which case the user will be required to correct the interference at his own expense.
Shielded Cables	Shielded cables must be used with this equipment to maintain compliance with FCC regulations.
Modifications	Changes or modifications not expressly approved by the manufacturer could void the user's authority to operate the equipment.
Conditions of Operations	This device complies with Part 15 of the FCC Rules. Operation is subject to the following two conditions: (1) this device may not cause harmful interference, and (2) this device must accept any interference received, including interference that may cause undesired operation.

CANADA	
Canadian Notice	This Class A digital apparatus complies with Canadian ICES-003.
Avis Canadian	Cet appareil numérique de la classe B est conforme à la norme NMB-003 du Canada.

AUSTRALIA	
	This product meets the requirements of EN 61000-6-3:2007 Generic standards - Emission standard for residential areas, business and commercial operations, and small businesses.

A.3 Service and support

Local information

Contain your Siemens representative (<http://www.siemens.com/automation/partner>) if you have questions about the products described here.

Technical documentation for SIMATIC products

You can find additional documentation for SIMATIC products and systems in the Internet: SIMATIC Guide manuals (<http://www.siemens.com/simatic-tech-doku-portal>)

Easy shopping at the mall

You can find the online catalog and order system under:
Industrial Automation and Drive Technologies (<http://mall.automation.siemens.com>)

Training center

All the training options are listed at:
SITRAIN homepage (<http://www.sitrain.com>)

Technical support

You can contact technical support for all Industry Automation and Drive Technologies products by:

- E-mail: support.automation@siemens.com
- Internet: Online support request form: (<http://www.siemens.com/automation/support-request>)

When you contact the customer support, please have the following information for the technician on hand:

- BIOS version
- Order No. (MLFB) of the device
- Installed additional software
- Installed additional hardware

Online Service & Support

Information about the product, Support and Service, right through to the Technical Forum, can be found at: Industry Automation and Drive Technologies - Homepage (<http://www.siemens.com/automation/service&support>)

After-sales information system for SIMATIC PC / PG

Information about contacts, drivers, and BIOS updates, FAQs and Customer Support can be found at: After-sales information system for SIMATIC PC/PG (<http://www.siemens.com/asis>)

ESD guidelines

B

B.1 ESD Guidelines

Definition of ESD

All electronic modules are equipped with large-scale integrated ICs or components. Due to their design, these electronic elements are highly sensitive to overvoltage, and thus to any electrostatic discharge.

The electrostatic sensitive components/modules are commonly referred to as ESD devices. This is also the international abbreviation for such devices.

ESD modules are identified by the following symbol:



CAUTION

ESD devices can be destroyed by voltages well below the threshold of human perception. These static voltages develop when you touch a component or electrical connection of a device without having drained the static charges present on your body. The electrostatic discharge current may lead to latent failure of a module, that is, this damage may not be significant immediately, but in operation may cause malfunction.

Electrostatic charging

Anyone who is not connected to the electrical potential of their surroundings can be electrostatically charged.

The figure below shows the maximum electrostatic voltage which may build up on a person coming into contact with the materials indicated. These values correspond to IEC 801-2 specifications.

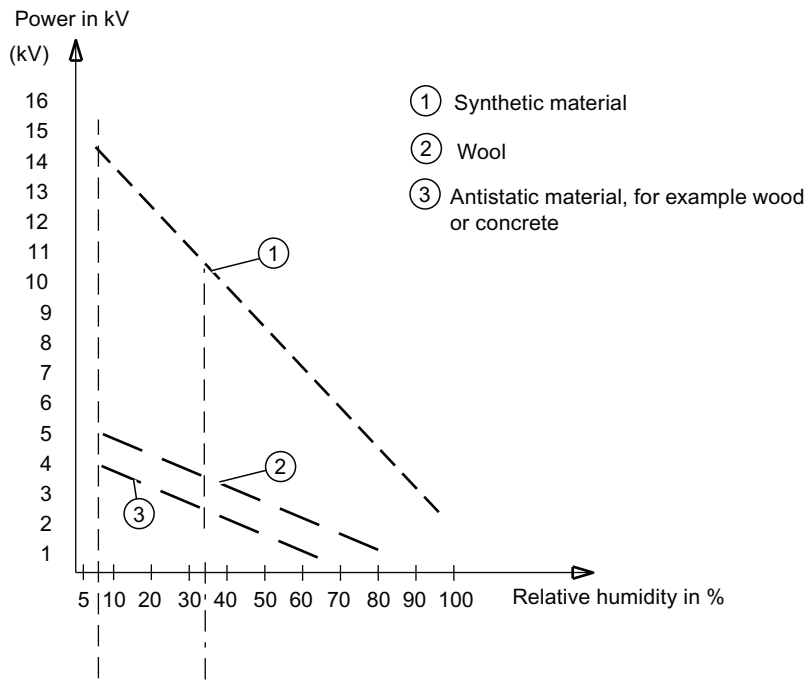

Figure B-1 Electrostatic voltages on an operator

Basic protective measures against electrostatic discharge

- Ensure good equipotential bonding:
When handling electrostatic sensitive devices, ensure that your body, the workplace and packaging are grounded. This prevents electrostatic charge.
- Avoid direct contact:
As a general rule, only touch electrostatic sensitive devices when this is unavoidable (e.g. during maintenance work). Handle the modules without touching any chip pins or PCB traces. In this way, the discharged energy can not affect the sensitive devices.

Discharge your body before you start taking any measurements on a module. Do so by touching grounded metallic parts. Always use grounded measuring instruments.

List of abbreviations



C.1 Abbreviations

Abbreviation	Term	Meaning
AC	Alternating current	Alternating current
ACPI	Advanced Configuration and Power Interface	
PLC	Programmable controller	
AGP	Accelerated Graphics Port	High speed bus system
AHCI	Advanced Host Controller Interface	Standardized controller interface for SATA devices. This is supported in Microsoft Windows XP as of SP1 and IAA driver.
APIC	Advanced Programmable Interrupt Controller	Extended programmable interrupt controller
APM	Advanced Power Management	Tool for monitoring and reducing power consumption of the PC
AS	Automation system	
ASIS	After Sales Information System	
AT	Advanced Technology	
ATA	Advanced Technology Attachment	
ATX	AT-Bus-Extended	
AWG	American Wire Gauge	US standard for the cable diameter
BIOS	Basic Input Output System	Basic Input Output System
CAN	Controller Area Network	
CD-ROM	Compact Disc – Read Only Memory	Removable storage medium for large data volumes
CD-RW	Compact Disc – Rewritable	Rewritable CD
CE	Communauté Européenne (CE symbol)	The product is in conformance with all applicable EC directives
CF	Compact Flash	
CGA	Color Graphics Adapter	Standard monitor interface
CLK	Clock pulse	Clock signal for controllers
CMOS	Complementary Metal Oxide Semiconductors	Complementary metal oxide semiconductors
COA	Certificate of authentication	Microsoft Windows Product Key
CoL	Certificate of License	License authorization
COM	Communications Port	Term for the serial interface
CP	Communication Processor	Communication computer
CPU	Central Processing Unit	CPU
CRT	Cathode Ray Tube	

List of abbreviations

C.1 Abbreviations

Abbreviation	Term	Meaning
CSA	Canadian Standards Association	Canadian organization for tests and certifications according to own or binational standards (with UL / USA) standards
CTS	Clear To Send	Clear to send
DRAM	Dynamic Random Access Memory	
DC	Direct Current	DC current
DCD	Data Carrier Detect	Data carrier signal detection
DMA	Direct Memory Access	Direct memory access
DOS	Disk Operating System	Operating system without GUI
DP	Display Port	New powerful digital monitor port
DQS	Deutsche Gesellschaft zur Zertifizierung von Qualitätsmanagement mBH	
DDRAM	Double Data Random Access Memory	Memory chip with high-speed interface
DSR	Data Set Ready	Ready for operation
DTR	Data Terminal Ready	Data terminal is ready
DVD	Digital Versatile Disk	Digital versatile disk
DVI	Digital Visual Interface	Digital display interface
DVI-I	Digital Visual Interface	Digital display interface with digital and VGA signals
ECC	Error checking and correction	Error correction code
ECP	Extended capability port	Extended parallel port
EFI	Extensible Firmware Interface	
EGA	Enhanced Graphics Adapter	PC to monitor interface
ESD	Components sensitive to electrostatic charge	
DM	Electronic Manual	
EIDE	Enhanced Integrated Drive Electronics	An enhancement of the IDE standard
EISA	Extended Industry Standard Architecture	Extended ISA standard
EMM	Expanded Memory Manager	Manages memory expansions
EM64T	Extended Memory 64 technology	
EN	European standard	
EPROM / EEPROM	Erasable Programmable Read-Only Memory / Electrically Erasable Programmable Read-Only Memory	Plug-in submodules with EPROM/EEPROM chips
EPP	Enhanced Parallel Port	Bi-directional Centronics interface
ESC	Escape character	Control character
EWf	Enhanced Write Filter	
FAQ	Frequently Asked Questions	FAQs
FAT 32	File Allocation Table 32-bit	32-bit file allocation table
FBWF	File-Based Write Filter	
FD	Floppy disk	Disk drive, 3.5"
FSB	Front Side Bus	
GND	Ground	Chassis ground
HD	Hard disk	Hard disk

Abbreviation	Term	Meaning
HDA	High Definition Audio	
HDD	Hard Disk Drive	HDD
HU	Height unit	
HMI	Human Machine Interface	User interface
HORM	Hibernate Once - Resume Many	
HT	Hyper-Threading	
HTML	Hyper Text Markup Language	Script language for creating Internet pages.
HTTP	Hypertext Transfer Protocol	Protocol for data transfer on the Internet
Hardware	Hardware	
IAMT	Intel Active Management Technology	Technology that permits the diagnostics, management and remote control of PCs
I/O	Input/Output	Data input/output on computers
IAA	Intel Application Accelerator	
IDE	Integrated Device Electronics	
IEC	International Electrical Commission	
IGD	Integrated Graphics Device	
IP	Ingress Protection	Degree of protection
IR	Infrared	Infrared
IRDA	Infrared Data Association	Standard for data transfer via IR module
IRQ	Interrupt Request	Interrupt request
ISA	Industry Standard Architecture	Bus for expansion modules
ITE	Information Technology Equipment	
L2C	Level 2 cache	
LAN	Local Area Network	Computer network that is limited to a local area.
LCD	Liquid Crystal Display	Liquid crystal display
LEDs	Light Emitting Diode	Light emitting diode
LPT	Line Printer	Printer port
LVDS	Low Voltage Differential Signaling	
LW	Drive	
MAC	Media access control	Media access control
MC	Memory Card	Memory card in credit card format
MLFB	Machine-readable product designation	
MMC	Micro Memory Card	Memory card of the format 32 mm x 24.5 mm
MPI	Multipoint-capable interface for programming devices	
MS-DOS	Microsoft Disc Operating System	
MTBF	Mean Time Between Failures	
MUI	Multilanguage User Interface	Language localization in Windows
NA	Not Applicable	
NAMUR	Normenarbeitsgemeinschaft für Mess- und Regelungstechnik in der chemischen Industrie (standardization body for instrumentation and control technology in the chemicals industry)	

List of abbreviations

C.1 Abbreviations

Abbreviation	Term	Meaning
NC	Not Connected	Not connected
NCQ	Native Command Queuing	Automatic re-sorting of the file and disk access, for increased performance
NEMA	National Electrical Manufacturers Association	Syndicate of manufacturers of electrical components in the USA
NMI	Non Maskable Interrupt	Interrupt the processor can not reject
NTFS	New Techniques File System	Secure file system for Windows versions (2000, XP, 7)
ODD	Optical Disk Drive	
OPC	OLE for Process Control	Standardized interface for industrial processes
PATA	Parallel ATA	
PC	Personal computer	
PCI	Peripheral Component Interconnect	High-speed expansion bus
PCIe	Peripheral Component Interconnect express	High-speed serial, differential full-duplex PtP interface with high data rate.
PCMCIA	Personal Computer Memory Card International Association	
PE	Protective Earth	Protective conductor
PEG	PCI Express Graphics	
PG	Programming device	
PIC	Programmable Interrupt Controller	Programmable interrupt controller
POST	Power On Self Test	
PXE	Preboot Execution Environment	Software for running new PCs without hard disk data via the network
RAID	Redundant Array of Independent Disks	Redundant hard disk array
RAL	Restricted Access Location	Installation of device in operating facilities with restricted access - for example, a locked switchgear cabinet
RAM	Random Access Memory	
RI	Ring Input	Incoming call
ROM	Read-Only Memory	
RS 485	Reconciliation Sublayer 485	Bi-directional bus system designed for up to 32 nodes
RTC	Real Time Clock	Real-time clock
RTS	Reliable Transfer Service	Request to send
RxD	Receive Data	Data transfer signal
SATA	Serial Advanced Technology Attachment	
SCSI	Small Computer System Interface	
SDRAM	Synchronous DRAM	
SELV	Safety Extra Low Voltage	Safety extra low voltage
SLC	Second Level Cache	
SMART	Self Monitoring Analysis and Reporting Technology	Hard disk error diagnostics program
SMS	Short Message Service	Short message via telecommunication network
SNMP	Simple Network Management Protocol	Network protocol

Abbreviation	Term	Meaning
SO-DIMM	Small Outline Dual Inline Memory Module	
SOM	SafeCard on Motherboard (SOM)	
SPP	Standard Parallel Port	Synonym for parallel port
SRAM	Static Random Access Memory	Static RAM
SSD	Solid State Drive	
SVGA	Super Video Graphics Array	Enhanced VGA standard with at least 256 colors
SVP	Serial number of the device	
SW	Software	
TCO	Total Cost of Ownership	
TFT	Thin-Film-Transistor	Type of LCD flat-screen
TTY	Tele Type	Asynchronous data transfer
TxD	Transmit Data	Data transfer signal
TXT	Trusted Execution Technology	Hardware implementation
TWD	Watchdog Time	Watchdog monitoring time
UEFI	Unified Extensible Firmware Interface	
UL	Underwriters Laboratories Inc.	US organization for tests and certifications according to own or binational standards (with CSA / Canada) standards
UMA	Unified Memory Architecture	Video memory
URL	Uniform Resource Locator	Designation of the full address of an Internet page
USB	Universal Serial Bus	
UXGA	Ultra Extended Graphics Array	Graphic standard, maximum resolution 1600x1200 pixels.
V.24		ITU-T standardized recommendation for data transfer via serial ports
VCC		Positive supply voltage of integrated circuits
VDE	Verein deutscher Elektrotechniker (Union of German Electrical Engineers)	
VGA	Video Graphics Array	Video adapter which meets industrial standard
VRM	Voltage Regulator Module	
VT	Virtualization Technology	Intel technology with which a virtually closed environment can be made available.
VT-D	Virtualization Technology for Directed I/O	Enables the direct assignment of a device (e.g. network adapter) to a virtual device.
W2k	Windows 2000	
WAN	Wide Area Network	
WAV	Wave Length Encoding	Loss-free file format for audio data
WD	Watchdog	Program monitoring with error detection and alarming.
WLAN	Wireless LAN	LWireless local area network
WoL	Wake on Local Area Network	
WWW	World Wide Web	

List of abbreviations

C.1 Abbreviations

Abbreviation	Term	Meaning
XD	Execute Disable Capability	Hardware implementation
XGA	Extended Graphics Array	Graphic standard, maximum resolution 1024x768 pixels.

Glossary

AHCI mode

AHCI is a standardized method to address the SATA controller. AHCI describes a structure in the RAM, which contains a general area for control and status, as well as a command list.

APIC mode

Advanced peripheral interrupt controller. 24 interrupt lines are available.

ATAPI CD-ROM Drive

AT Bus Attachment Packet Interface (connected to AT bus) CD-ROM drive

Automation system (AS)

A programmable controller (PLC) of the SIMATIC S7 system consist of a central controller, one or several CPUs, and various I/O modules.

Backup

Duplicate of a program, data medium or database, used either for archiving purposes or for the protection of vital and non-replaceable data against loss when the working copy is corrupted. Certain applications automatically generate backup copies of data files, and manage both the current and the previous versions on the hard disk.

Baud

Physical unit for the step speed in signal transmission. Defines the number of transferred signal states per second. With only two states, one baud is equivalent to a transmission rate of 1 bps.

Boot disk

A boot disk is a disk with a "Boot" sector. This can be used to load the operating system from the disk.

Cache

High-speed access buffer for interim storage (buffering) of requested data.

CE marking

Communauté Européene The CE mark confirms compliance of the product with corresponding EC Directives, for example, with the EMC Directive.

Chipset

Located on the motherboard, connects the processor with the RAM, the graphics controller, the PCI bus, and the external interfaces.

Cold restart

A start sequence, starting when the computer is switched on. The system usually performs some basic hardware checks within the cold start sequence, and then loads the operating system from the hard disk to work memory -> boot

COM interface

The COM interface is a serial V.24 interface. The interface is suitable for asynchronous data transfer.

Compact Flash cards (CF)

Compact Flash is a digital storage medium in card format and without moving parts. The CF card contains the non-volatile memory and the controller. The interface of the CF card corresponds with the IDE interface. CF cards can be operated without additional electronics on PCMCIA or IDE hard disk controllers using a plug and socket adapter. There are two design forms: CF-I (42.6 x 36.4 x 3.3 mm) and CF-II (42.8 x 36.4 x 5 mm).

Configuration files

These are files containing data which define the configuration after restart. Examples of such files are CONFIG.SYS, AUTOEXEC.BAT and the registry files .

Configuration software

The configuration software updates the device configuration when new modules are installed . This is done either by copying the configuration files supplied with the module or by manual configuration using the configuration utility.

Controller

Integrated hardware and software controllers that control the functions of certain internal or peripheral devices (for example, the keyboard controller).

Device configuration

The configuration of a PC or programming device contains information on hardware and device options, such as memory configuration, drive types, monitor, network address, etc. The data are stored in a configuration file and enable the operating system to load the correct device drivers and configure the correct device parameters. . If changes are made to the hardware configuration, the user can change entries in the configuration file using the SETUP program. .

Disc-at-once

With this burning technique, data are written to a CD in a single session, and the CD is then closed. Further write access is then no longer possible.

DP

Display Port: New digital monitor interface.

Drivers

Program parts of the operating system. They adapt user program data to the specific formats required by I/O devices such as hard disk, printers, and monitors.

Dual Core CPU

Dual-core processors significantly increase the speed of computing and program execution compared to the previous generation of single-core processors with hyperthreading technology.

ECC

Error checking and correction is a method for detecting and correcting errors when saving and transferring data, frequently used in conjunction with RAM modules with and without ECC.

EMC directive

Directive concerning **E**lectromagnetic **C**ompatibility. Compliance is confirmed by the CE symbol and the EC certificate of conformity.

Energy management

The energy management functions of a modern PC allow individual control over the current consumption of vital computer components (e.g. of the monitor, hard disk and CPU), by restricting their activity based on the current system or component load. Energy management is of particular importance for mobile PCs.

Energy options

The energy options can be used to reduce energy consumption of the computer, while keeping it ready for immediate use. This can be configured in Windows by selecting Settings > Control Panel > Energy options.

Enhanced Write Filter (EWF)

Configurable write filter that allows you, for example, to boot Windows Embedded Standard from write-protected media (such as CD-ROM), to write protect individual partitions and adapt the performance of the file system to your needs (when using Compact Flash cards).

ESD directive

Directive for using electrostatic sensitive components.

Ethernet

Local network (bus structure) for text and data communication with a transfer rate of 10/100/1000 Mbps.

Execute Disable Capability

Hardware implementation that prevents mutual memory accesses by programs and applications. It is only effective when all relevant system components, such as processors, operating systems and applications are supported.

Extensible Firmware Interface (EFI)

Refers to the central interface between the firmware, the individual components of a computer and the operating system. EFI is located logically beneath the operating system and represents the successor to PC BIOS, focusing on 64-bit systems.

File Based Write Filter (FBWF)

Configurable write filter to protect individual files from write access.

Formatting

Basic partitioning of memory space on a magnetic data medium into tracks and segments. Formatting deletes all data on a data medium. All data media must be formatted prior to their first use.

Gender changer

Using the gender changer (25-pin / 25-pin), the COM1/V24/AG interface of the SIMATIC PC family can be converted to the usual 25-pin male connector.

HORM

Hibernate once, resume many is a method for fast booting from a single Hibernate file that only needs to be created once. HORM ensures restoration of a uniform, saved system state when booting. This reduces the writing to a CompactFlash medium to a minimum, for example, when starting up and shutting down Windows Embedded Standard 2009.

Hot plug

The SATA interface gives the device's hard drive system hot plugging capability. Prerequisite for this configuration is a RAID1 system with SATA RAID controller (onboard, or slot module), and at least two SATA removable cartridges. The advantage of hot plugging is that defective hard disks can be replaced without having to reboot the computer.

Hub

A term in network technology. In a network, a device joining communication lines at a central location, providing a common connection to all devices on the network.

Hyper Threading

HT technology (multi-threading) enables the parallel computing of processes. HT is only effective when all relevant system components, such as processors, operating systems and applications are supported.

IGD

Integrated Graphics Device. Graphics interface integrated in the chipset.

Image

This refers to the image, for example, of hard disk partitions saved to a file in order to restore them when necessary.

Intel Active Management Technology

This technology permits the diagnostics, management and remote control of PCs. It is only effective when all relevant system components, such as processors, operating systems and applications are supported.

Intel VT

The Intel Virtualization Technology (IVT) is the implementation of a secure closed environment for applications. Special (visualization) software and a VT-capable processor is required for its use.

Interface

See Interface

- Physical interconnection (cable) of hardware elements such as PLCs, PCs, programming devices, printers or monitors.
- Interface for interactive software applications.

Interface, multi-point

MPI is the programming interface of SIMATIC S7/M7. Allows remote access to programmable modules, text-based displays and OPs from central locations. The MPI nodes can intercommunicate.

LAN

Local Area Network: LAN is a local network that consists of a group of computers and other devices that are distributed across a relatively restricted range and are linked with communication cables. The devices connected to a LAN are called nodes. The purpose of networks is the mutual use of files, printers or other resources.

Legacy Boot Device

Conventional drives can be used as USB devices.

Legacy USB support

Support of USB devices (e.g. mouse, keyboard) on the USB ports without driver.

License key

The license key represents the electronic license stamp of a license. Siemens provides the license keys for protected software.

License key disk

The license key disk contains the authorizations or license keys required to enable protected SIMATIC software.

Low-voltage directive

EC Product Safety Directive relating to the safety of products which are operated on low voltage (50 VAC to 1000 VAC, 70 VDC to 1500 VDC) and not specified in other directives. Compliance is confirmed by the CE symbol and the EC certificate of conformity.

LPT interface

The LPT interface (Centronics interface) is a parallel interface that can be used to connect a printer.

Memory card

Memory cards in credit card format. Memory for user programs and parameters, for example, for programmable modules and CPs.

Module

Modules are plug-in units for PLCs, programming devices or PCs. They are available as local modules, expansion modules, interfaces or mass storage (Mass storage module).

Motherboard

The motherboard is the core of the computer. Here, data are processed and stored, and interfaces and device I/Os are controlled and managed.

NEC Class 2

The "NEC", National Electrical Code, is the USA collection of regulations that generally correspond to German VDE 0100 standards. All USA standards governing the safety of electrical equipment and corresponding "deviations" in IEC standards are based on NEC in terms of their country-specific requirements.

NEC Class 2 specifies higher safety requirements for protection against electric shock and National Fire Protection Association (NFPA) requirements for fire protection. Power supplies operating within the range from 20 VDC to 30 VDC must be equipped with an internal current limiting circuit which safely prevents output power higher than 100 VA.

Operating system

Generic term which describes all functions for controlling and monitoring user program execution, distribution of system resources to the user programs and the operating mode in cooperation with the hardware (for example Windows XP Professional).

Packet writing

The CD-RW is used as a disk medium. The CD can then be read only by packet-writing compatible software or has to be finalized. Finalization of a CD closes the CD within an ISO9660 shell. You can still write to the CD-RW several times in spite of finalization. Not all CD drives can read packet-written CDs. There are restrictions to using this method in general data transfer.

PATA

Interface for hard disk drives and optical drives, with parallel data transmission rate up to 100 Mbps.

PC card

Trademark of the Personal Computer Memory Card International Association (PCMCIA). Designation for auxiliary cards that conform with PCMCIA specifications. A PC card that has roughly the size of a credit card can be plugged into a PCMCIA slot. Version 1 specifies cards of Type I with a thickness of 3.3 millimeters, which are designed mainly for use as external memory. Version 2 of the PCMCIA specification also defines cards of Type II with a thickness of 5 mm and cards of Type III with a thickness of 10.5 mm. Type II cards can realize devices such as modems, fax cards and network interface cards. Type III cards are equipped with devices that require more space, for example wireless communications modules, or rotary storage media such as hard disk drives, for example.

PC/104 / PC/104-Plus

Two bus architectures are especially fashionable today in the industrial world. PC/104 and PC/104-*Plus*. Both are standard in single-board computers of the PC class. The electrical and logical layout of the two bus systems is identical with ISA (PC/104) and PCI (PC/104-*Plus*). Software cannot usually detect a difference between them and normal desktop bus systems. Their advantage is the compact design and the resulting space they save.

PCMCIA

Association consisting of approx. 450 member companies of the computer industry whose focus is set on providing worldwide standards for miniaturization and flexible use of PC expansion cards in order to provide basic technologies to the market.

PEG interface

PCI Express for Graphics. Graphics interface with 16 PCIe lanes for expansions with graphics modules.

PIC mode

Peripheral interrupt controller. 15 interrupt lines are available.

Pixel

PixElement (picture point). The pixel represents the smallest element that can be reproduced on-screen or on a printer.

Plug&Play

Generally, a reference to the ability of a computer to automatically configure the system for communication with peripheral devices (for example monitors, modems or printers). The user can plug in a peripheral and "play" it at once without manually configuring the system. A Plug&Play PC requires both a BIOS that supports Plug&Play and a Plug&Play expansion card.

POST

Self-test performed by the BIOS after the computer is switched on. Performs a RAM test and a graphics controller test, for example. The system outputs audible signals (beep codes) if the BIOS detects any errors; the relevant message indicating cause of error is output on the screen.

PROFIBUS/MPI

Process Field Bus (standard bus system for process applications)

PROFINET

PROFINET is the name of the standard for Industrial Ethernet developed and maintained by the PROFIBUS user organization. PROFINET unites protocols and specifications with which Industrial Ethernet meets the requirements of industrial automation technology.

Programmable controller (PLC)

The programmable controllers (PLC) of the SIMATIC S5 system consist of a central controller, one or more CPUs, and various other modules (e.g. I/O modules).

PXE server

A **Preboot Execution Environment** server is part of a network environment and can provide software to connected computers even before they boot. This can involve operating system installations or servicing tools, for example.

RAID

Redundant Array of Independent Disks: Data storage system which is used to save data and the corresponding error correction codes (parity bits, for example) to at least two hard disk volumes in order to enhance reliability and performance. The hard disk array is controlled by management programs and a hard disk controller for error correction. The RAID system is usually implemented in network servers.

RAL

Restricted Access Location: Installation of the device in a production facility with restricted access, for example, a locked control cabinet.

Recovery CD

Contains the tools for configuring hard disks and the Windows operating system.

Reset

Hardware reset: Reset/restart of the PC using a button/switch.

Restart

Warm restart of a computer without switching the power off (Ctrl + Alt + Del)

Restore DVD

The Restore DVD is used to restore the system partition or the entire hard disk to factory state if the system has crashed. The bootable DVD contains all the necessary image files. You can also create a boot disk allowing restoration via the network.

ROM

Read-Only Memory ROM is a read-only memory in which every memory location can be addressed individually. The programs or data are permanently stored and are not lost in the event of a power failure.

S.M.A.R.T

The Self-Monitoring, Analysis and Reporting Technology (SMART or S.M.A.R.T.) is an industry standard integrated in storage media. It makes for permanent monitoring of important parameters and early detection of imminent problems.

SATA

Serial ATA Interface for hard disk drives and optical drives with serial data transmission rates of up to 300 Mbps.

SCSI interface

Small Computer System Interface Interface for connecting SCSI devices such as hard disk drives or optical drives.

Session at once

In session at once, the CD can be written to both with an audio session and a data session. The two sessions are written to at once (as in disc at once).

SETUP (BIOS Setup)

A program in which information about the device configuration (that is the configuration of the hardware on the PC/PG) is defined. The device configuration of the PC/PG is preset with defaults. Changes must therefore be entered in the SETUP if a memory expansion, new modules or a new drive are added to the hardware configuration.

SSD (Solid State Drive)

A Solid State Drive is a drive that can be installed like any other drive; it does not contain a rotating disk or other moving parts because only semiconductor memory chips of similar capacity will be used. This design makes SSDs more rugged, provides shorter access times, low energy consumption and rapid data transfer.

STEP 7

Programming software for the creation of user programs for SIMATIC S7 controllers.

Track-at-once

In track-at-once recording, a CD can be written to in bits in several sessions if the CD was not closed.

Troubleshooting

Error cause, cause analysis, remedy

Trusted Execution Technology

Hardware implementation that allows secured execution of programs and applications. It is only effective when all relevant system components, such as processors, operating systems and applications are supported.

Turbo Mode

In this mode individual processor cores can be clocked higher in accordance with the load from the user programs and as required. It is only supported by Core i5 and Core i7 processors.

V.24 interface

V.24 is a standardized interface for data transfer. Printers, modems, and other hardware modules can be connected to a V.24 interface.

Wake on LAN (WoL)

Wake on Local area network. This function allows the PC to be started via the LAN interface.

Warm restart

The restart of a computer after a program was aborted. The operating system is loaded and restarted again. The CTRL+ ALT+ DEL hotkey can be used to initiate a warm restart.

WLAN

Wireless LAN is a local network that transmits data via radio waves, infrared light or another wireless technology. Wireless LAN is mainly used for mobile computer applications in office or factory environments.

Index

2

24 V DC power supply
Connecting, 38

A

Abbreviations, 161, 166
Adapting
Partitioning, 92
Ambient and environmental conditions, 27
Antivirus software, 49

B

Battery, 12, 79
Battery change, 78
Battery monitoring, 61
BIOS Setup, 123
Advanced Menu, 132
Defaults, 141
Exit menu, 140
Main menu, 126
Menu layout, 125
Version menu, 139
Blanking plate, 113
Boot options, 128
Boot sequence, 97
Buffer memory, 61

C

CAN, 104, 116
Base address register, 147, 148
CAN bus interface, 121
CAN interface, 52
CE label, 155
Certificates
Certifications and approvals, 156
Cold restart, 48
COM1 port, 117
Commissioning
Other operating systems, 50
Windows Embedded Standard, 44
Windows XP Professional, 48

Compact Flash card
Installation/removal, 72
Compact Flash card interface, 122
Connecting
24 V DC power supply, 38
Peripherals, 37, 155
Power supply, 37
Connection elements, 20
Coupling with SIMATIC S7, 51
CP 1616 onboard, 52
Creating an image, 95

D

Data backup, 95
Date
BIOS Setup, 127
DC power supply, 38
Declaration of conformity, 155
Degree of protection, 101
Design, external, 19
Device
Mounting, 31
opening, 63
unpacking, 25
Device configuration, 141
Device driver CP 16xx.sys, 51
Device driver CP16xx.sys, 53
DiagBase software, 55
DiagMonitor
Temperature monitoring, 56
DiagMonitor software, 55
Diagnostics
DiagBase software, 55
DiagMonitor software, 55
Error Messages, 97
Troubleshooting, 99
Dimension drawings
Blanking plate, 113
Device with expansion frames, 112
Dimensions, 101
Disk drives, 103
Driver installation, 93
DVI-I port, 118

- E**
 - Electrostatic sensitive devices, 12
 - EMC directive, 155
 - Enable register
 - Watchdog, 146
 - Enhanced Write Filter, 57
 - Equipotential bonding, 20, 39, 63, 76
 - Error Messages
 - Troubleshooting, 99
 - ESD directives, 12
 - ESD guidelines, 159
 - Ethernet, 51, 104, 116
 - Ethernet address, 26
 - EWf (Enhanced Write Filter), 57
 - Expansion frame, 68
 - Expansion slots, 103
 - External ports, 116

- F**
 - Factory state, 43, 80, 82
 - FAQs, 99
 - FBWF (File Based Write Filter), 59
 - File Based Write Filter, 59
 - Firewall, 49

- G**
 - General technical specifications, 101
 - Guidelines
 - ESD guidelines, 159

- H**
 - Hard disk drive, 103
 - Hardware Options, 130

- I**
 - Identification data, 26
 - Initial commissioning
 - Windows Embedded Standard, 44
 - Windows XP Professional, 48
 - Installing a memory module, 65
 - Interfaces, 20
 - Ethernet, 20, 51
 - ETHERNET, 20
 - PROFIBUS, 20
 - PROFINET, 51
 - Internal components
 - Overview, 115
 - Internal interfaces, 121
 - IT communication, 51

- K**
 - Keyboard
 - Ports, 20
 - Keyboard Features, 129

- L**
 - Language selection, 83
 - Setup in Windows Embedded Standard 2009, 45
 - Windows 7, 87
 - Windows XP, 84
 - License key, 80, 82
 - Limitation of Liability, 75
 - Lithium battery, 78

- M**
 - Main memory, 103
 - Messages
 - On the screen, 97
 - Microsoft Windows Product Key, 26
 - Modules, 66
 - Monitoring
 - Status displays, 24
 - Motherboard
 - External ports, 116
 - Layout and function, 115
 - Technical features, 116
 - Mounting
 - Bracket, 33
 - Device, 31
 - Modules, 67
 - Mounting bracket
 - Screw-mounting, 35
 - Mounting brackets, 33
 - Mounting instructions, 31
 - Mounting positions, 30

- O**
 - On-board Ethernet, 131
 - Online ordering system, 52
 - On-screen error messages, 97
 - Open
 - Device, 63

Operating system
 Updates, 94
 Windows 7, 85
 Windows XP Professional, 83
 Order number, 26

P

Partitioning, 92
 Adapting, 92
 CompactFlash card, 88, 89
 Hard disk, 88, 89
 SSD, 88, 89, 90, 91
 Windows 7 Ultimate, 91
 Windows Embedded Standard 2009I, 88
 Windows Embedded Standard 7, 89
 Windows XP Professional, 90
 PCI cards, 66
 PCI-104 interface, 123
 PE terminal, 39
 Peripherals, 37, 155
 Connecting, 155
 Ports, 20
 CAN, 52
 COM, 20
 COM1, 117
 Compact Flash card, 122
 DVI/VGA, 20
 DVI-I, 117
 PCI -104, 123
 PROFIBUS, 119
 PROFIBUS/MPI, 51
 RJ45 Ethernet, 118
 USB, 20, 119
 Power supply, 37
 Connecting, 38
 DC power supply, 105
 Processor, 103
 PROFIBUS interface, 119
 PROFIBUS/MPI, 51, 104, 116
 PROFINET, 51
 PROFINET IO, 95
 PROFINET strain relief, 41

R

Real-time protection, 49
 Recovery
 Windows 7, 85
 Repairs, 11, 75, 76
 Replacing the hard disk, 76

Restore CD, 80
 Restore CD/DVD for Windows Embedded Standard, 80
 Restore CD/DVD for Windows XP Professional, 82
 RJ45 Ethernet, 118

S

Safety instructions, 11
 SATA/PATA Configuration, 134
 Scope of application, 13
 Serial number, 26
 SIMATIC NET PC software, 52
 SIMATIC S7, 51
 SOFTNET S7, 51
 SRAM, 61
 SSD
 Partitioning, 88, 89, 90, 91
 Startup, 61, 97
 Status displays, 24
 Supply voltage, 101
 System Date, 127
 System partition, 80, 82
 System resources, 143
 System Time, 127

T

Temperature monitoring, 56
 Third-party modules, 100
 Time
 BIOS Setup, 127
 Tools, 76
 Transport, 25
 Trigger register
 Watchdog, 146
 Troubleshooting/FAQs, 99

U

Unpacking
 Device, 25
 Updates
 Operating system, 94
 User programs and drives, 94
 USB, 20, 119
 USB interface, 119
 USB strain-relief, 40
 User password, 135

V

Vent slots, 27

W

Warranty, 11

Watchdog, 146

- Enable register, 146

- Monitoring function, 56

- Monitoring times, 57

- Trigger register, 146

Weight, 101

Windows 7

- Recovery, 85

Windows 7 Ultimate

- Data backup, 95

- Partitioning the hard disk, 91

Windows Embedded Standard

- Data backup, 95

- Driver installation, 93

- Initial commissioning, 44

Windows Embedded Standard 2009I

- Partitioning the hard disk, 88

Windows Embedded Standard 7

- Partitioning the hard disk, 89

Windows Security Center, 49

Windows XP Professional

- Data backup, 95

- Initial commissioning, 48

- Partitioning the hard disk, 90

- Reinstalling the operating system, 81