

**CASTOMAT® System**

Industrial I/O-Node

ION VIB-A T001

6AT8000-1BA00-4XA0

Manual - English

Release 2008-07

Preface	1
Scope of Delivery	2
Product Characteristics	3
Installation and Maintenance	4
Notes on the CE Mark	5
References	6
Appendix	7
Contact Information	8

Safety Guidelines

This document contains notices which you should observe to ensure your own personal safety as well as to avoid property damage. The notices referring to your personal safety are highlighted in the manual by a safety alert symbol, notices referring to property damage only have no safety alert symbol.



Danger

indicates an **imminently** hazardous situation which, if not avoided, will result in death or serious injury.



Warning

indicates a **potentially** hazardous situation which, if not avoided, could result in death or serious injury.



Caution

used with the safety alert symbol indicates a potentially hazardous situation which, if not avoided, may result in minor or moderate injury.

Caution

used without safety alert symbol indicates a potentially hazardous situation which, if not avoided, may result in property damage.

Notice

used without the safety alert symbol indicates a potential situation which, if not avoided, may result in an undesirable result or state.

When several danger levels apply, the notices of the highest level (lower number) are always displayed. If a notice refers to personal damages with the safety alert symbol, then another notice may be added warning of property damage.

Qualified Personnel

The device/system may only be set up and operated in conjunction with this documentation. Only qualified personnel should be allowed to install and work on the equipment. Qualified persons are defined as persons who are authorized to commission, to earth, and to tag circuits, equipment and systems in accordance with established safety practices and standards.

Intended Use

Please note the following:



Warning

This device and its components may only be used for the applications described in the catalog or technical description, and only in connection with devices or components from other manufacturers approved or recommended by Siemens.

This product can only function correctly and safely if it is transported, stored, set up and installed correctly, and operated and maintained as recommended.

Trademarks

All designations marked with ® are registered trademarks of Siemens AG. Other designations in this documentation might be trademarks which, if used by third parties for their purposes, might infringe upon the rights of the proprietors.

Copyright Siemens AG 2008. All rights reserved.

Reproduction, transmission or use of this document or its contents is not permitted without express written authority. Offenders will be liable for damages. All rights, including rights created by patent grant or registration of a utility model or design, are reserved.

Disclaimer of Liability

We have checked the contents of this document for agreement with the hardware and software described. Since deviations cannot be precluded entirely, we cannot guarantee full agreement. However, the data in the manual are reviewed regularly, and any necessary corrections will be included in subsequent editions. Suggestions for improvement are welcomed.

Table of Contents

1	Preface	4
1.1	Purpose of this Document.....	4
1.2	Validity of this Document.....	4
1.3	Audience	4
1.4	Standards and Approvals.....	4
2	Scope of Delivery	5
2.1	Scope of Delivery	5
2.2	Unpacking and Checking	5
3	Product Characteristics	6
3.1	Introduction	6
3.2	Hard- and Software Requirements	7
3.2.1	Hardware.....	7
3.2.2	Software	7
3.3	Order Numbers	7
3.4	Network Topology	8
3.5	Interfaces	9
3.5.1	Overview of Interfaces	9
3.5.2	IEEE1394a Interfaces.....	10
3.5.3	Power Supply Interface.....	11
3.5.4	Rotational Speed Sensor / Incremental Position Encoder Interface.....	12
3.5.5	ICP-Sensor Interface	13
3.6	Indicators.....	14
3.7	Technical Data	15
3.8	Block Diagram.....	17
4	Installation and Maintenance	18
4.1	Types of Installation	18
4.2	Installation	18
4.3	Disassembly.....	19
4.4	Example of Installation.....	20
4.5	Grounding	20
4.6	Maintenance.....	20
5	Notes on the CE Mark	20
6	References	22
6.1	Other Documentation	22
7	Appendix	23
7.1	Dimension Drawing.....	23
8	Contact Information.....	24

1 Preface

1.1 Purpose of this Document

This document supports you when commissioning and using the device

- ION VIB-A T001

of the CASTOMAT® System.

1.2 Validity of this Document

This document is valid for the following device:

- ION VIB-A T001

1.3 Audience

This document is intended for personnel involved in the commissioning and using of the device:

- ION VIB-A T001

1.4 Standards and Approvals

The device

- ION VIB-A T001

meets the requirements of the CE mark.

Extended information can be found in the appendix of this manual.

Note

The particularized approvals are only valid at the time, when the product is conformity marked.

2 Scope of Delivery

2.1 Scope of Delivery

What is shipped?

- Device
ION VIB-A T001
- 3-pin plug-in terminal block
PHOENIX CONTACT, COMBICON, 3 Pin MVSTBW 2,5/3-STF-5,08
- 8-pin plug-in terminal block
PHOENIX CONTACT, COMBICON, 8 Pin MVSTBW 2,5/8-STF-5,08

2.2 Unpacking and Checking

After unpacking, please check

- the packet for completeness and
- all parts for transport damage.



Warning

Do not use any parts that show evidence of damage!

3 Product Characteristics

3.1 Introduction

This chapter gives you an overview of the function of the component

- ION VIB-A T001

of the CASTOMAT® System.

The ION VIB-A T001 captures four ICP-sensor signals and one speed signal and transmits the measured data to a superior industrial-PC via its FireWire (IEEE1394a-standard) link with 400 Mbps. The maximum sample rate is up to 40 kHz per channel.

The device is designed for the usage on a DIN rail.



ION VIB-A T001

3.2 Hard- and Software Requirements

3.2.1 Hardware

- PC with Windows XP Professional (Service Pack 2 recommended)
 - CPU with ≥ 2.4 GHz
 - working memory ≥ 512 MByte
 - OpenGL enabled graphic controller (from 1024x768 Pixels, 1280x1024 Pixels or more recommended)
 - IEEE1394, Ethernet and USB interfaces
- power supply units and connecting cables (depending on the used CASTOMAT® System components)

3.2.2 Software

- CASTOMAT® X-Tools XP (Standard or Professional Edition)

3.3 Order Numbers

Article	Order Number (MLFB)
CASTOMAT® ION VIB-A T001	6AT8000-1BA00-4XA0
CASTOMAT® System - User Documentation	6AT8000-5AA00-0XA0
CASTOMAT® X-Tools XP - Standard Edition	6AT8000-0AA00-1BA0
CASTOMAT® X-Tools XP - Professional Edition	6AT8000-0AA00-2BA0

Further information is obtained from your local Siemens office and from the homepage

<http://www.siemens.com/castomat>.

3.4 Network Topology

Which network topologies can be realized?

The IEEE1394a technology allows the building of extended networks with up to 63 participants.

With the component ION VIB-A T001, tree and chain topologies can be built.

Caution

The net topology is equal to the one of a bus with branching - but without loops!

Tree topology

The tree topology facilitates the building of networked systems by connecting two further nodes to each node.

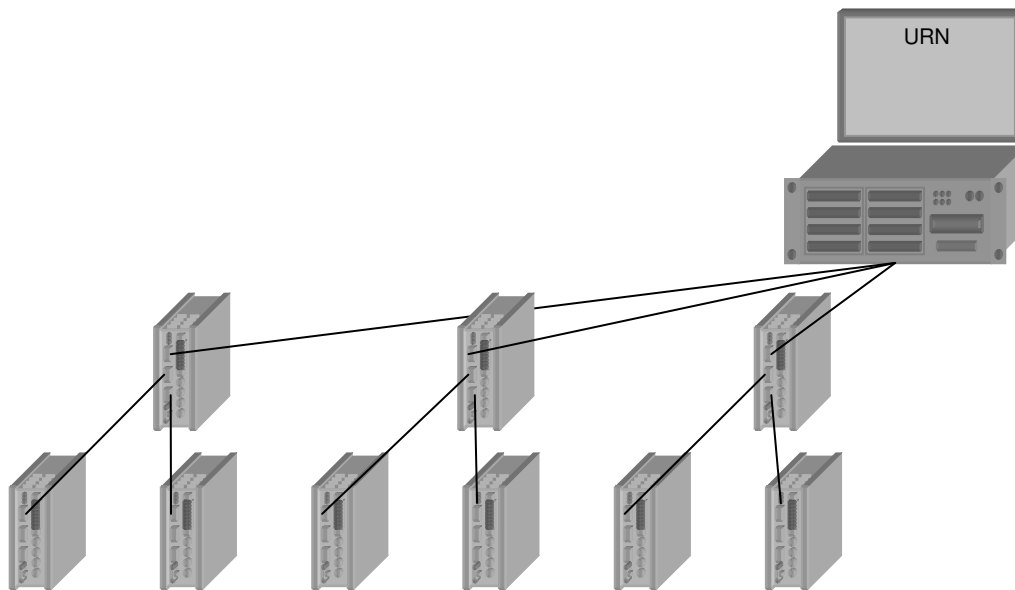

tree topology

Chain topology

The chain topology enables the building of networked systems by connecting one further node to each node.

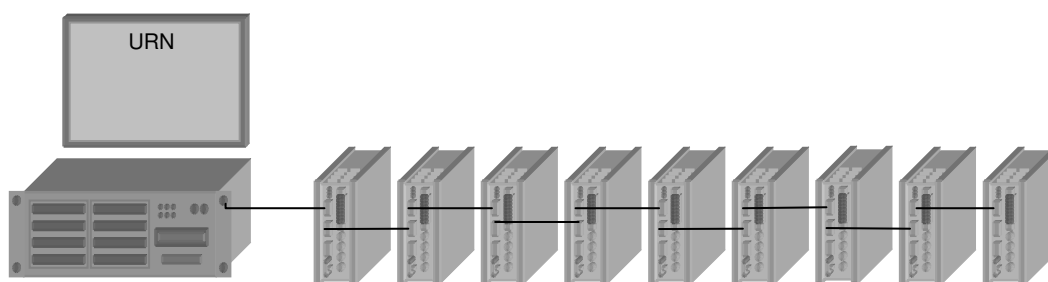

chain topology

Caution

The maximum number of nodes per bus is limited to 63. The maximum number of hops (peer-to-peer-connections) from one node to any other node is limited to 15 - i.e. there may not be more than 16 nodes connected in a row.

3.5 Interfaces

3.5.1 Overview of Interfaces

The device ION VIB-A T001 provides three plugs for further CASTOMAT® system components, one interface to connect ICP-sensors and one interface for a rotational speed signal.



ION VIB-A T001

3.5.2 IEEE1394a Interfaces

At the ION VIB-A T001 the IEEE1394a Interfaces (P1 / P2 / P3) are implemented as 6-pin-sockets.

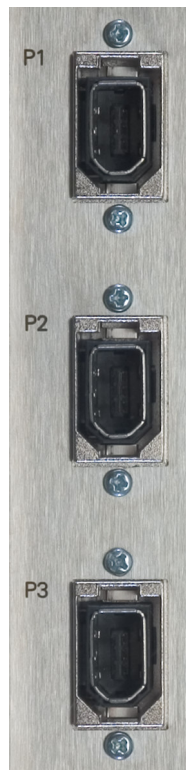

IEEE1394a Interfaces

Caution

Only cables of a maximum length of 4.5 m may be connected to the IEEE1394a Interfaces.

3.5.3 Power Supply Interface

The connection takes place via a 3-pin plug-in terminal block. The power supply is connected to the chassis via a low resistance in order to keep a high interference resistance.

The supply voltage is attached via pin 1 (24V) and pin 2 (0V).

The power feed of 24 V on pin 3 (PD - Power Down) of the terminal block of 90 seconds causes a RESET of the device. After approximately 90 seconds the device starts automatically again.

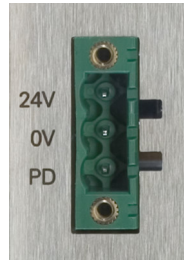

power supply interface



Caution

The device ION VIB-A T001 is designed for operation with safety extra-low voltage. This means that only safety extra-low voltages (SELV) complying with IEC950/EN60950/VDE0805 can be connected to the power supply terminals.

The power supply unit for the supply of the ION VIB-A T001 has to meet NEC Class 2 (range of voltage 18-32 V, maximum load of 1 A).

The ION VIB-A T001 has to be protected with a fuse element of double maximum load and tripping characteristic „medium time lag“ or „time lag“.

Never operate the ION VIB-A T001 with AC voltage or DC voltage higher than 32 VDC.

3.5.4 Rotational Speed Sensor / Incremental Position Encoder Interface

At the ION VIB-A T001, the interface to a rotational speed sensor / incremental position encoder is implemented as 8-pin-socket (PHOENIX, MVSTBW 2,5/8-GF-5,08).



rotational speed sensor / incremental position encoder interface

T+	rotational speed sensor (positive terminal)
T-	rotational speed sensor (negative terminal)
M	Mass (shielding cable rotational speed sensor)
A	incremental position encoder (A)
B	incremental position encoder (B)
N	incremental position encoder (N)
G	mass for incremental position encoder (A/B/N)
M	mass (shielding cable incremental position encoder)

3.5.5 ICP-Sensor Interface

At the ION VIB-A T001 the interfaces to the ICP-sensor signals are implemented as 4-pin sockets (Binder, 09-3391-81-04).



ICP-sensor interfaces

1	input ICP-sensor 1
2	input ICP-sensor 2
3	input ICP-sensor 3
4	input ICP-sensor 4
TRI	input ICP-sensor (triaxial)

3.6 Indicators



Name		PWR
Description		power indicator
Color		green
Condition	off	no operating voltage
	blinks	firmware operates
Name		ERR
Description		error indicator
Color		red
Condition	off	no error
	on	error fan - if any
Name		LNK
Description		indicator for the connection to the controller
Color		yellow
Condition	off	no connection to the controller
	on	connection to the controller established
	blinks	data exchange with the controller

3.7 Technical Data

Connections	
Power Supply Interface	24V / 0V / PD
Number	1
Connector type	3-pin plug-in terminal block, Phoenix Contact
Type	input
Input voltage	18 ... 32 VDC
Power loss at 24 VDC	24 W
Current consumption at 24 VDC	1 A
IEEE1394a Interface	P1 ... P3
Number	3
Connector type	6-pin socket
Type	IEEE1394a interface
Transmission speed	400 Mbps
Standard	IEEE1394a
Rotational Speed Sensor Interface	T+ / T-
Number	1
Connector type	8 pin connector, Phoenix Contact
Type	differential input
Input voltage	+/- 10 V
Input protection	+/- 60 V
Insulation	+/- 0.4 kV
Input resistance	$R \geq 1 \text{ M}\Omega$
Input current	$I < 10 \text{ }\mu\text{A}$
Sample frequency	$\leq 40 \text{ kHz}$
Resolution	16 bit (15+1)
Coupling	DC
Gain error	0.025 % +/- 1 digit
Offset error	0.017 % +/- 1 digit
Static offset	max. 0.12 %
CMR	100 dB
Incremental Position Encoder Interface	A / B / N
Number	1 (A, B, N)
Connector type	8 pin connector, Phoenix Contact
Type	incremental encoder input
Input voltage	TTL, HTL
Insulation	+/- 0.4 kV
Input resistance	$R \geq 100 \text{ k}\Omega$
Sample frequency	500 kHz

ICP Sensor Interface		1 / 2 / 3 / 4
Number	4 (4 x ICP or 1 x ICP (triaxial) and 1 x ICP)	
Connector type	4 pin connector, Binder	
Type	ICP sensor input	
Input voltage	+/- 10 V, +/- 1 V, +/- 100 mV, +/- 10 mV	
Input protection	+/- 60 V	
Insulation	+/- 0.4 kV	
Input resistance	$R \geq 1 \text{ M}\Omega$	
Output current	$I = 4 \text{ mA}$	
Sample frequency	$\leq 40 \text{ KHz}$ / ICP sensor input	
Resolution	16 bit (15+1)	
Coupling	AC	
Gain error	0.025 % +/- 1 digit	
Offset error	0.017 % +/- 1 digit	
Static offset	max. 0.12 %	
CMR	100 dB	
Permitted Cable / Cable Length		
FireWire	according to IEEE1394a standard	
Signal inputs	according to sensor specification	
Permitted Environmental Conditions / EMC		
Ambient temperature during operation	0 ... +55 °C	
Transportation and storage temperature	-25 ... +85 °C	
Humidity rating	5 ... 95 %, not condensing	
EMC interference emission	EN 55011 (Class A)	
EMC interference immunity	EN 61000-6-2:2005	
Degree of protection	IP20	
Constructive Structure		
Dimensions (H x W x D) in mm	200 x 60.2 x 126.5	
Design	aluminum / stainless steel	
Color	silver	
Weight	1 kg	
Mounting	DIN rail profile DIN EN 50022-35x15 (thickness 2.3 mm)	
Approvals		
CE	EN 61000-6-4:2001 EN 61000-6-4:2007 EN 61000-6-2:2005 DIN EN 61000-6-2:2006-03 DIN EN 61000-6-4:2002-08 DIN EN 61000-6-4:2007-09	

3.8 Block Diagram

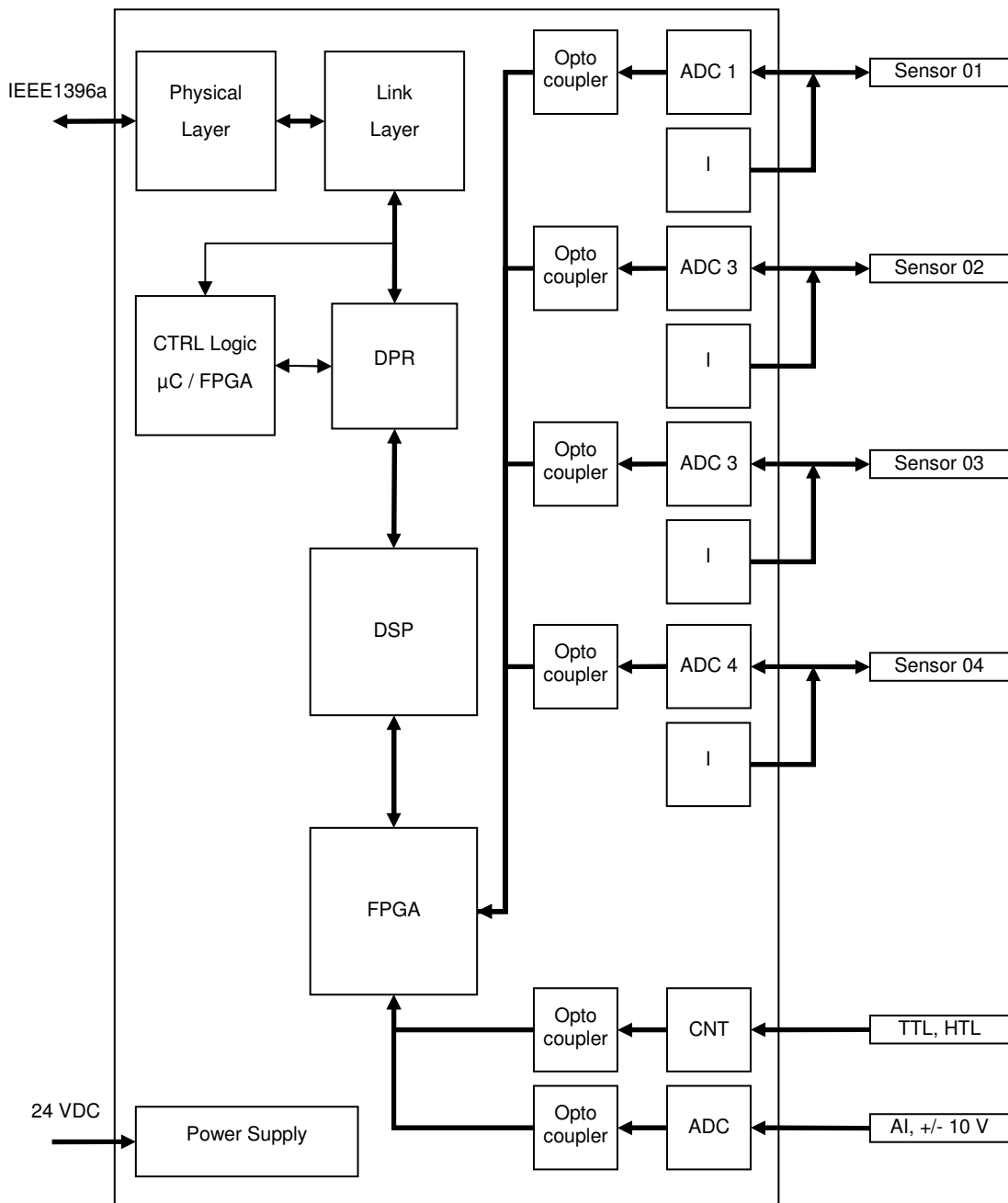

block diagram

4 Installation and Maintenance

4.1 Types of Installation

Note

The device ION VIB-A T001 may exclusively be operated when installed on a DIN rail.

4.2 Installation

Installation of the device on a DIN rail:

- Hang the upper table-track of the device on the DIN rail and push it down towards the DIN rail so that it snaps in.

Installation of electric connection cables:

- Install the terminal block of the rotational speed sensor/incremental position encoder connection cables.
- Install the plug of the ICP-sensor connection cables.
- Install the plugs of the IEEE1394 connection cables.
- Install the terminal block of the power supply connection cable.

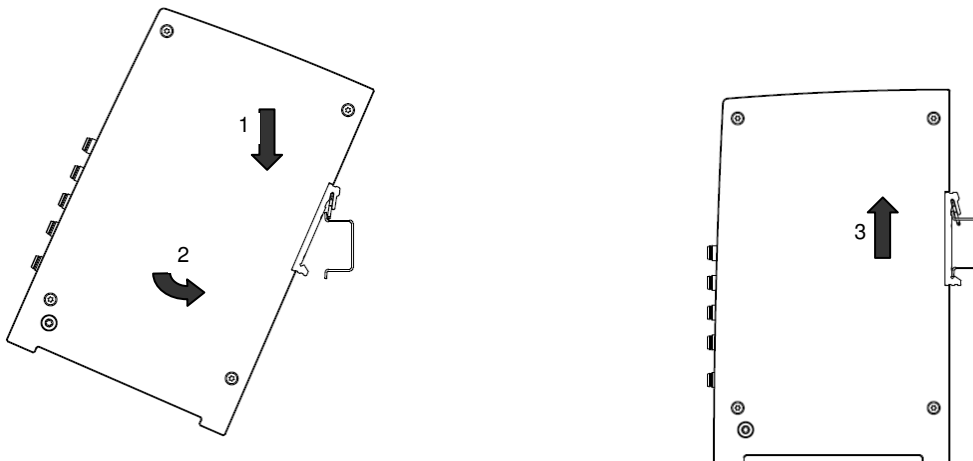

installation of the ION VIB-A T001 on a DIN rail

Caution

The spaces, which are specified in chapter „Appendix“, paragraph „Dimension Drawing“, on top and underneath the device (25 mm) and in front of the device (80 mm) have to be kept.

4.3 Disassembly

Disassembly of electric connection cables:

- Disassemble the terminal block of the power supply connection cable.
- Disassemble the plugs of the IEEE1394 connection cable.
- Disassemble the plug of the ICP-sensor connection cables.
- Disassemble the terminal block of the rotational speed sensor/incremental position encoder connection cables.

Removal of the device from the DIN rail:

- Push the device down against the DIN rail and hang it out.

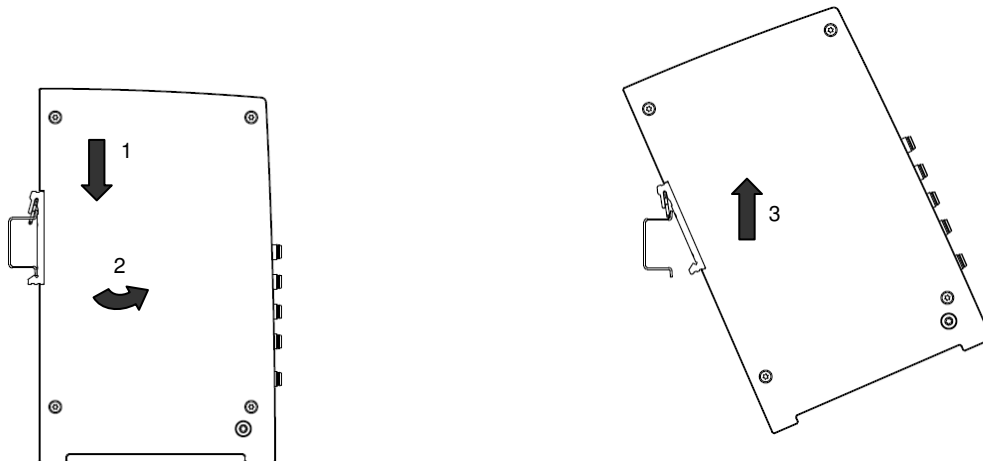

disassembly of the ION VIB-A T001 from the DIN rail

4.4 Example of Installation

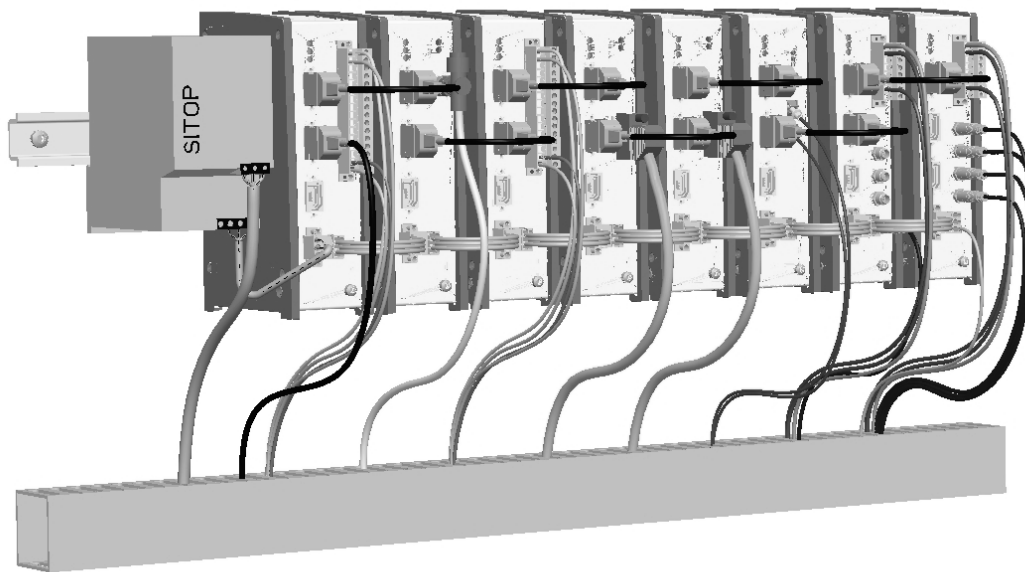

example of installation

Note

This image shows an exemplary installation.

Technical data subject to change.

4.5 Grounding

The screw on the front side of the device is provided as grounding connection.

4.6 Maintenance

If a fault develops, please send the device to the Siemens logistics center.

Address

SIEMENS AG
I IA RETOUREN-CENTER FUERTH
SIEMENSSTR. 2
90766 FUERTH
GERMANY

5 Notes on the CE Mark

Product Name

Device	ION VIB-A T001
---------------	----------------

EMC Directive

The product is designed for use in an industrial environment.

Area of Application	Requirements for Emission	Immunity
Industry	EN 55011 (Class A)	EN 61000-6-2:2005

Installation Guide Lines

The product meets the requirements if you meet the installation instructions and safety-related notices as described in this commissioning manual.

Conformity Certificates

The EC Declaration of Conformity is available for the responsible authorities according to the abovementioned EC Directive at the following address:

SIEMENS AG
 I IA SE DE
 WUERZBURGER STR. 121
 90766 FUERTH
 GERMANY

Notes for the Manufacturers of Machines

This product is not a machine in the sense of the EC Machinery Directive. There is therefore no declaration of conformity relating to the EC Machinery Directive 89/392/ECC for this product.

If the product is part of the equipment of a machine, it must be included in the procedure for the declaration of conformity by the manufacturer of the machine.

6 References

6.1 Other Documentation

- CASTOMAT® System - User Documentation (CD)

7 Appendix

7.1 Dimension Drawing

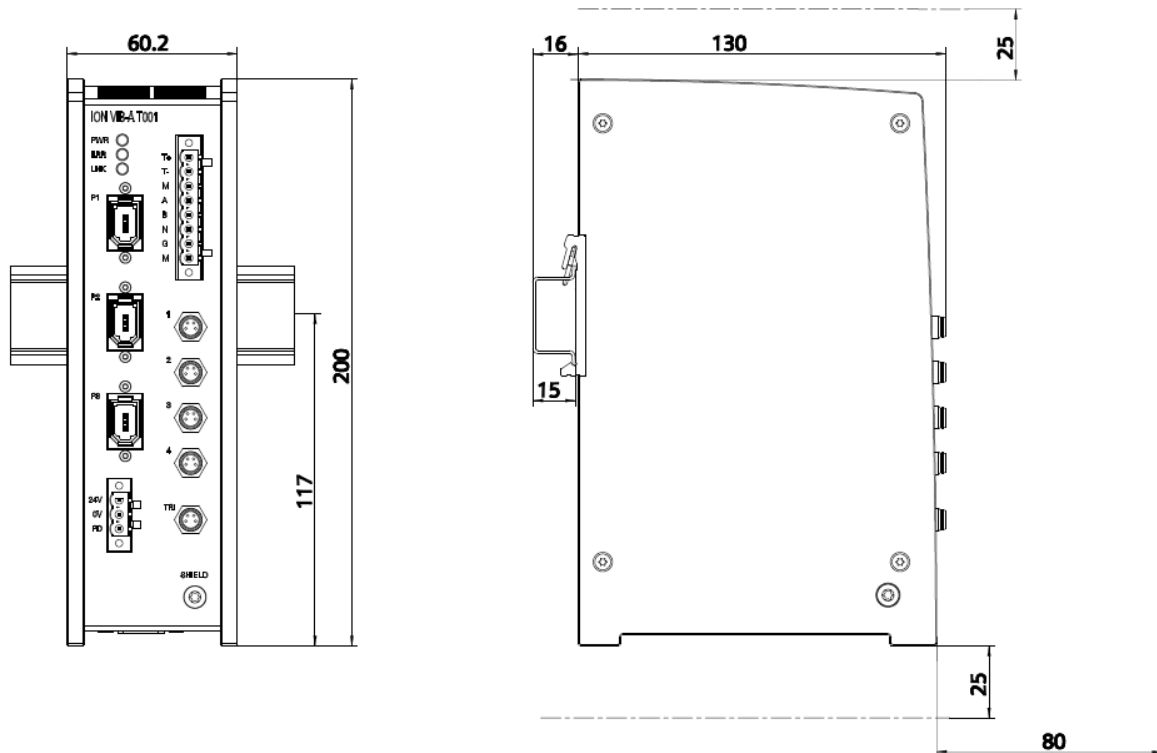

dimension drawing

Note

This document does not contain complete detail information to the product due to reasons of clarity and can therefore exclude each thinkable case of assembly, usage or the maintenance.

Further information is obtained from your local Siemens office and from the homepage <http://www.siemens.com/castomat>.

Technical data subject to change.

In cases of doubt the German document is valid.

8 Contact Information

Address

SIEMENS AG
I IA SE DE
WUERZBURGER STR. 121
90766 FUERTH
GERMANY

Internet

<http://www.siemens.com/castomat>
<http://www.siemens.com/automation/service>