

SIEMENS

SIMATIC NET

Industrial Remote Communication Remote Networks SCALANCE M874, M876

Operating Instructions

Preface

Security recommendations

1

Description of the device

2

Installation

3

Connecting up

4

Dimension drawings

5

Technical specifications

6



Approvals

A

Legal information

Warning notice system

This manual contains notices you have to observe in order to ensure your personal safety, as well as to prevent damage to property. The notices referring to your personal safety are highlighted in the manual by a safety alert symbol, notices referring only to property damage have no safety alert symbol. These notices shown below are graded according to the degree of danger.

 DANGER
indicates that death or severe personal injury will result if proper precautions are not taken.
 WARNING
indicates that death or severe personal injury may result if proper precautions are not taken.
 CAUTION
indicates that minor personal injury can result if proper precautions are not taken.
NOTICE
indicates that property damage can result if proper precautions are not taken.

If more than one degree of danger is present, the warning notice representing the highest degree of danger will be used. A notice warning of injury to persons with a safety alert symbol may also include a warning relating to property damage.

Qualified Personnel

The product/system described in this documentation may be operated only by **personnel qualified** for the specific task in accordance with the relevant documentation, in particular its warning notices and safety instructions. Qualified personnel are those who, based on their training and experience, are capable of identifying risks and avoiding potential hazards when working with these products/systems.

Proper use of Siemens products

Note the following:

 WARNING
Siemens products may only be used for the applications described in the catalog and in the relevant technical documentation. If products and components from other manufacturers are used, these must be recommended or approved by Siemens. Proper transport, storage, installation, assembly, commissioning, operation and maintenance are required to ensure that the products operate safely and without any problems. The permissible ambient conditions must be complied with. The information in the relevant documentation must be observed.

Trademarks

All names identified by ® are registered trademarks of Siemens AG. The remaining trademarks in this publication may be trademarks whose use by third parties for their own purposes could violate the rights of the owner.

Disclaimer of Liability

We have reviewed the contents of this publication to ensure consistency with the hardware and software described. Since variance cannot be precluded entirely, we cannot guarantee full consistency. However, the information in this publication is reviewed regularly and any necessary corrections are included in subsequent editions.

Preface

Purpose of the Operating Instructions

These compact operating instructions contain information with which you will be able to install and connect up a device of the SCALANCE M874, M876 product line. The configuration and the integration of the device in a network are not described in these instructions.

Validity of the manual

These operating instructions apply to the following devices:

- SCALANCE M874-2
- SCALANCE M874-3
- SCALANCE M876-3
- SCALANCE M876-4

Naming of the devices

Classification	Description	Terms used
Product line	For all devices and variants of all product groups within the SCALANCE M-800 product line, the term M-800 is used.	M-800
Product group	For all devices and variants of a product group, only the product group is used.	<ul style="list-style-type: none"> • M874 stands for M874-2, M874-3 • M876 stands for M876-3, M876-4 • M87x stands for M874-2, , M874-3, M876-3, M876-4
Device	For a device, only the device name is used.	M874-2 M874-3 M876-3 M876-4

Further documentation

- System manual "Industrial Ethernet"

The system manual contains information on other SIMATIC NET products that you can operate along with the devices of this product line in an Industrial Ethernet network.

There, you will find among other things optical performance data of the communications partner that you require for the installation.

The "SIMATIC NET Industrial Ethernet" system manual can be found on the Internet pages of Siemens Industry Online Support under the following entry ID:27069465 (<http://support.automation.siemens.com/WW/view/wn/27069465>)

- "Passive network components" system manual

This system manual contains installation instructions for several of the most common components and guidelines for setting up networked automation plants in buildings.

The "Passive Network Components" system manual can be found on the Internet pages of Siemens Industry Online Support under the following entry ID:84922825 (<http://support.automation.siemens.com/WW/view/en/84922825>)

SIMATIC NET manuals

You will find SIMATIC NET manuals on the Internet pages of Siemens Industry Online Support:

- using the search function:

Link to Siemens Industry Online Support (<http://support.automation.siemens.com/>)

Enter the entry ID of the relevant manual as the search item.

- In the navigation panel on the left hand side in the area "Industrial Communication":

Link to the area "Industrial Communication"

(<http://support.automation.siemens.com/WWW/view/en/10805878/133400>)

Go to the required product group and make the following settings:

tab "Entry list", Entry type "Manuals"

You will find the documentation for the SIMATIC NET products relevant here on the data medium that ships with some products:

- Product CD / product DVD
- SIMATIC NET Manual Collection

You will find the article numbers for the Siemens products of relevance here in the following catalogs:

- SIMATIC NET Industrial Communication / Industrial Identification, catalog IK PI
- SIMATIC Products for Totally Integrated Automation and Micro Automation, catalog ST 70
- Industry Mall - catalog and ordering system for automation and drive technology, Online catalog (<http://eb.automation.siemens.com/>)

You can request the catalogs and additional information from your Siemens representative.

Security information

Siemens provides products and solutions with industrial security functions that support the secure operation of plants, systems, machines and networks.

In order to protect plants, systems, machines and networks against cyber threats, it is necessary to implement – and continuously maintain – a holistic, state-of-the-art industrial security concept. Siemens' products and solutions constitute one element of such a concept.

Customers are responsible for preventing unauthorized access to their plants, systems, machines and networks. Such systems, machines and components should only be connected to an enterprise network or the internet if and to the extent such a connection is necessary and only when appropriate security measures (e.g. firewalls and/or network segmentation) are in place.

For additional information on industrial security measures that may be implemented, please visit <https://www.siemens.com/industrialsecurity>

Siemens' products and solutions undergo continuous development to make them more secure. Siemens strongly recommends that product updates are applied as soon as they are available and that the latest product versions are used. Use of product versions that are no longer supported, and failure to apply the latest updates may increase customer's exposure to cyber threats.

To stay informed about product updates, subscribe to the Siemens Industrial Security RSS Feed under <https://www.siemens.com/industrialsecurity>

Trademarks

The following and possibly other names not identified by the registered trademark sign ® are registered trademarks of Siemens AG:

SCALANCE, SINEMA, KEY-PLUG, C-PLUG

License conditions

Note

Open source software

Read the license conditions for open source software carefully before using the product.

You will find license conditions in the following documents on the supplied data medium:

- OSS_Scalance-M-800-S615_86.htm

SIMATIC NET glossary

Explanations of many of the specialist terms used in this documentation can be found in the SIMATIC NET glossary.

You will find the SIMATIC NET glossary on the Internet at the following address:

50305045 (<http://support.automation.siemens.com/WW/view/en/50305045>)

Table of contents

	Preface	3
1	Security recommendations	11
2	Description of the device	15
2.1	Product characteristics	15
2.2	Accessories	17
2.3	Terminals	20
2.4	LED display	22
2.4.1	SCALANCE M874-2, M874-3	22
2.4.2	SCALANCE M876-3, M876-4	25
2.5	SET button	27
2.6	C-PLUG and KEY-PLUG	29
3	Installation	31
3.1	Securing the housing	33
3.2	Wall mounting	34
3.3	Installation on the DIN rail	36
3.4	Installing on the S7-300 standard rail	38
3.5	Installing on the S7-1500 standard rail	40
3.6	Installation on a desktop pedestal	42
4	Connecting up	45
4.1	SIM card	47
4.2	Power supply	48
4.3	Grounding	50
4.4	Digital input/output	51
4.5	Antennas	54
4.6	Ethernet port	57
4.7	Inserting and removing the PLUG	58
5	Dimension drawings	61
5.1	SCALANCE M874-2, M874-3	61
5.2	SCALANCE M876-3, M876-4	63

6	Technical specifications	65
6.1	GPRS/EDGE router SCALANCE M874-2	65
6.2	HSPA+ router SCALANCE M874-3	68
6.3	HSPA+ router SCALANCE M876-3	71
6.4	LTE router SCALANCE M876-4	75
6.5	LTE router SCALANCE M876-4 (NAM)	79
6.6	Antenna gain	83
A	Approvals	85
A.1	EU declaration of conformity	87
A.1.1	ATEX	88
A.1.2	RoHS	88
A.1.3	R&TTE / RED	89
A.1.3.1	Protection of health and safety	89
A.1.4	Products	90
A.2	RCM / C-TICK	91
A.3	ATEX	92
A.4	IECEX	93
A.5	Conformity with FCC	94
A.6	RSS-210 Industry of Canada	96
A.7	FM certification	97
A.8	UL certification (product safety)	98
A.9	UL HAZ. LOC certification (explosion protection)	99
A.10	EAC	100
	Index	101

Security recommendations

To prevent unauthorized access, note the following security recommendations.

General

- You should make regular checks to make sure that the device meets these recommendations and/or other security guidelines.
- Evaluate your plant as a whole in terms of security. Use a cell protection concept with suitable products: (<http://www.industry.siemens.com/topics/global/en/industrial-security/network-security/Pages/Default.aspx>)
- When the internal and external network are disconnected, an attacker cannot access internal data from the outside. Therefore operate the device only within a protected network area.
- Operate the device only within a protected network area.
- Use VPN to encrypt and authenticate communication from and to the devices.
- For data transmission via a non-secure network use an encrypted VPN tunnel (IPsec, Open VPN).
- Separate connections correctly (WBM, Telnet, SSH etc.).

Physical access

- Limit physical access to the device to qualified personnel. The memory card or the PLUG (C-PLUG, KEY-PLUG) contains sensitive data such as certificates, keys etc. that can be read out and modified.
- Lock unused physical ports on the device. Unused ports can be used to gain forbidden access to the plant.

Software (security functions)

- Keep the software up to date. Check regularly for security updates of the product. You will find information on this on the Internet pages "Industrial Security (<http://www.siemens.com/industrialsecurity>)".
- Inform yourself regularly about security advisories and bulletins published by Siemens ProductCERT (<http://www.siemens.com/cert/en/cert-security-advisories.htm>).
- Only activate protocols that you really require to use the device.
- The option of VLAN structuring provides good protection against DoS attacks and unauthorized access. Check whether this is practical or useful in your environment.
- Restrict access to the device by firewall, VPN (IPsec, OSINEMA RC) and NAT.
- Use a central logging server to log changes and accesses. Operate your logging server within the protected network area and check the logging information regularly.

Passwords

- Define rules for the use of devices and assignment of passwords.
- Regularly update passwords and keys to increase security.
- Change all default passwords for users before you operate the device.
- Only use passwords with a high password strength. Avoid weak passwords for example password1, 123456789, abcdefgh.
- Make sure that all passwords are protected and inaccessible to unauthorized personnel.
- Do not use the same password for different users and systems or after it has expired.

Keys and certificates

This section deals with the security keys and certificates you require to set up TLS, VPN (IPsec, OpenVPN) and SINEMA RC.

- The device contains a pre-installed X.509 certificate with key. Replace this certificate with a self-made certificate with key. We recommend that you use a certificate signed by a reliable external or internal certification authority.
- Use the certification authority including key revocation and management to sign the certificates.
- Make sure that user-defined private keys are protected and inaccessible to unauthorized persons.
- Verify certificates and fingerprints on the server and client to prevent "man in the middle" attacks.
- It is recommended that you use password-protected certificates in the PKCS #12 format
- It is recommended that you use certificates with a key length of at least 2048 bits.
- Change keys and certificates immediately, if there is a suspicion of compromise.

Secure/non-secure protocols

- Avoid or disable non-secure protocols, for example Telnet and TFTP. For historical reasons, these protocols are still available, however not intended for secure applications. Use non-secure protocols on the device with caution.
- Avoid or disable non-secure protocols. Check whether use of the following protocols is necessary:
 - Broadcast pings
 - Non authenticated and unencrypted interfaces
 - ICMP (redirect)
 - LLDP
 - Syslog
 - DHCP Options 66/67
 - TFTP

- The following protocols provide secure alternatives:
 - SNMPv1/v2 → SNMPv3

Check whether use of SNMPv1 is necessary. SNMPv1 is classified as non-secure. Use the option of preventing write access. The product provides you with suitable setting options.

If SNMP is enabled, change the community names. If no unrestricted access is necessary, restrict access with SNMP.
 - HTTP → HTTPS
 - Telnet → SSH
 - TFTP → SFTP
- Use secure protocols when access to the device is not prevented by physical protection measures.
- To prevent unauthorized access to the device or network, take suitable protective measures against non-secure protocols.
- If you require non-secure protocols and services, activate these at interfaces that are located within a protected network area.
- Using a firewall, restrict the services and protocols available to the outside to a minimum.
- For the DCP function, enable the "DCP read-only" mode after commissioning.

Available protocols per port

The following list provides you with an overview of the open ports on this device. Keep this in mind when configuring a firewall.

The table includes the following columns:

- **Protocol**

All protocols that the device supports
- **Port number**

Port number assigned to the protocol
- **Port status**
 - Open

The port is always open and cannot be closed.
 - Open (when configured)

The port is open if it has been configured.

- **Factory setting**

- Open

The factory setting of the port is "Open".

- Closed

The factory setting of the port is "Closed".

- **Authentication**

Specifies whether or not the protocol is authenticated during access.

With some protocols the port can be open but access is prevented by a predefined IP package filter rule. You will find further information on the predefined IP package rules in "Security > Firewall > Predefined IPv4 rules"

Protocol	Port number	Port status	Factory setting		Authentication
			Internal interface	External interface	
SSH SFTP	TCP/22	Open (when configured)	Open	Closed	Yes
HTTP	TCP/80	Open (when configured)	Open	Closed	Yes
HTTPS	TCP/443	Open	Open	Closed	Yes
SNTP	UDP/123	Open (only outgoing)	Closed	Closed	No
SNMP	UDP/161	Open (when configured)	Open	Closed	Yes
DNS	TCP/53	Open (when configured)	Open	Closed	No
	UDP/53	Open (when configured)	Open	Closed	No
Syslog	UDP/514	Open (only outgoing)	Closed	Closed	No
IPsec	UDP/500 UDP/4500	Open (when configured)	Closed	Open	Yes
DHCP	UDP/67 UDP/68	Open (when configured)	Open	Closed	No
NTP	UDP/123	Open (only outgoing)	Closed	Closed	Yes
Siemens Remote Service (cRSP/SRS)	TCP/443	Open (only outgoing)	Closed	Closed	Yes
PROFINET	UDP/34964	Open (when configured)	Closed	Closed	No
OpenVPN to SINEMA RC	TCP, any	Open (only outgoing)	Closed	Closed	Yes
TFTP	UDP/69	Open (only outgoing)	Closed	Closed	No
DynDNS	TCP/80	Open (only outgoing)	Closed	Closed	No
Telnet	TCP/23	Open (when configured)	Open	Closed	Yes
Ping	ICMP	Open	Open	Closed	No

Description of the device

2.1 Product characteristics

Interfaces

Functionality	M874-2 M874-3	M876-3 M876-4
Connectors for external antennas	1 SMA antenna connector	2 SMA antenna connectors
Ethernet interface	2 x RJ-45 10 / 100 Mbps	4 x RJ-45 10 / 100 Mbps
Digital input/output	1/1	1/1

Scope of delivery

The following components ship with the product:

- One device
- A 5-pin terminal block for the power supply
- A 2-pin terminal block for the digital output
- A 2-pin terminal block for the digital input
- Product CD

Note

Not included with the product

The following components do not ship with the product:

- KEY-PLUG / C-PLUG
You will find more detailed information in "C-PLUG and KEY-PLUG (Page 29)".
 - Antennas
You will find more detailed information in "Accessories (Page 17)".
 - Standard SIM card
Use the SIM card from the chosen mobile wireless provider
-

Article numbers

Type	Article number	Description
SCALANCE M874-2	6GK5 874-2AA00-2AA2	Mobile wireless router for 2G (EDGE)
SCALANCE M874-3	6GK5 874-3AA00-2AA2	Mobile wireless router for 3G (HSPA+)
SCALANCE M876-3	6GK5 876-3AA02-2BA2	Mobile wireless router for 3G (HSPA+) with antenna diversity
	6GK5876-3AA02-2EA2 (Korea)	
SCALANCE M876-4	6GK5 876-4AA00-2BA2	Mobile wireless router for 4G (LTE) with antenna diversity
	6GK5876-4AA00-2DA2 (NAM: North America)	

Unpacking and checking

 WARNING
Do not use any parts that show evidence of damage
If you use damaged parts, there is no guarantee that the device will function according to the specification.
If you use damaged parts, this can lead to the following problems:
<ul style="list-style-type: none">• Injury to persons• Loss of the approvals• Violation of the EMC regulations
Use only undamaged parts.

1. Make sure that the package is complete.
2. Check all the parts for transport damage.

2.2 Accessories

You will find further information on the accessories program for the M-800 in the Industry Mall

(<https://eb.automation.siemens.com/goos/WelcomePage.aspx?regionUrl=/en&language=en>)

Type	Properties	Article number
C-PLUG	Exchangeable storage medium (32 MB) for the configuration data	6GK1900-0AB00
	Exchangeable storage medium (256 MB) for the configuration data	6GK1900-0AB10
KEY-PLUG SINEMA RC	Exchangeable storage medium (256 MB) to enable the connection functionality to SINEMA Remote Connect and for storing configuration data.	6GK5908-0PB00
Desktop pedestal	SCALANCE M-800 desktop pedestal for table mounting for SCALANCE M812 / M816 / M874-X / M876-X / S615	6GK5898-8MD00

Antennas

Type	Properties	Article number
ANT794-3M	Flat antenna for GSM networks, for tri-band with 900 / 1800 / 1900 MHz; weatherproof for indoor and outdoor areas; 1.2 m connecting cable connected permanently to the antenna; SMA connector, including adhesive mounting tape	6NH9870-1AA00
ANT794-4MR	Omnidirectional antenna for GSM (2G), UMTS (3G) and LTE(4G); weatherproof for indoor and outdoor areas; 5 m connecting cable connected permanently to the antenna; SMA connector, including installation bracket, screws, wall plugs	6NH9860-1AA00
ANT 896-4MA	IRC antenna ANT 896-4MA for GSM (2G), UMTS (3G) and LTE (4G), omnidirectional characteristic, radial swiveling, with additional joint, antenna gain: 2 dBi, incl. SMA connector, IP54, (-40 to +85 °C), note national approvals, for direct mounting with SMA connector; package contains: 1X ANT896-4MA compact instructions on paper German / English, scope of delivery 1x ANT896-6MA	6GK5896-4MA00-0AA3
ANT 896-4ME	IRC antenna ANT 896-4MA for GSM (2G), UMTS (3G) and LTE (4G) networks, omnidirectional characteristic incl. N female connector 3 dBi; IP66 (-40 to +70 °C), note national approvals; mounting on cabinet; compact instructions on paper German/English;; scope of delivery: 1X ANT896-4ME	6GK5896-4ME00-0AA0

2.2 Accessories

Type	Properties	Article number
ANT 896-6MH	Mobile wireless antenna ANT 896-6MH for GSM (2G), UMTS (3G) and LTE (4G) networks, suitable for railway applications, omnidirectional characteristic incl. N-female connector; 5/6 dBi; IP69K (-40 to +85 °C), note national approvals; mounting on vehicle roof compact instructions on paper German/English; scope of delivery: 1X ANT896-6MH	6GK5896-6MH00-0AA0
ANT 896-6MM	Mobile wireless antenna ANT 896-6MM for GSM (2G), UMTS (3G), LTE EU (4G) networks, GPS and WLAN 2.4/5 GHz, omnidirectional characteristic incl. 3x pigtail with QMA connector antenna gain: 5/8 dBi; IP69K (-40 to +85 °C), note national approvals; mounting on vehicle roof; compact instructions on paper German/English; scope of delivery: 1x ANT896-6MM	6GK5896-6MM00-0AA0
SIMATIC NET CABLE N-CONNECT/SMA	Flexible connecting cable SCALNCE M antenna, preassembled, various lengths.	
	0.3 meters	6XV1875-5LE30
	1 meter	6XV1875-5LH10
	2 meters	6XV1875-5LH20
	5 meters	6XV1875-5LH50
	Flexible connecting cable SCALNCE M antenna, preassembled, various lengths, railway applications.	
	1 meter	6XV1875-5UH10
	2 meters	6XV1875-5UH20
	5 meters	6XV1875-5UH50
SIMATIC NET N-CONNECT MALE/MALE	Flexible connecting cable e.g. for 2 RCOAX segments, various lengths.	
	1 meter	6XV1875-5AH10
	2 meters	6XV1875-5AH20
	5 meters	6XV1875-5AH50
	5 meters	6XV1875-5AH50
	10 meters	6XV1875-5AN10
	Flexible connecting cable e.g. for 2 RCOAX segments, various lengths, railway applications	
	1 meter	6XV1875-5SH10
	2 meters	6XV1875-5SH20
	5 meters	6XV1875-5SH50
5 meters	6XV1875-5SH50	

Type	Properties	Article number
SIMATIC NET CABLE QMA/N-CONNECT	Flexible adapter cable, preassembled with two connectors QMA/N connect male/female, length 1 m, pack of 3	6XV1875-5JH10
	Flexible adapter cable, preassembled with two connectors QMA/N connect male/female, railway applications, length 1 m, pack of 1	6XV1875-5VH10
SIMATIC NET WINKELADAPTER SMA/SMA MALE/ FEMALE	Angled adapter with two connectors SMA male and SMA female. This adapter simplifies the mounting of an antenna connecting cable on a SCALANCE M and e.g. allows a space-saving feed from above or below.	6GK5898-1CV00-4AA0
IE FC RJ45 PLUG	RJ-45 connector (10/100 Mbps) with rugged metal housing and FC connection technology for IE FC cable 2x2 180 degree cable outlet various package sizes	
	Pack of 1	6GK1901-1BB10-2AA0
	Pack of 10	6GK1901-1BB10-2AB0
	Pack of 50	6GK1901-1BB10-2AE0
SIMATIC NET Lightning Protector LP798-1N	Lightning protection element with N/N female/female connector, IP65 (-40 to +100 °C), 0 to 6 GHz with gas discharge technology for SCALANCE W and M antennas, compact instructions on paper German/English	6GK5798-2LP00-2AA6
SIMATIC N-Connect/N- Connect	Female / female panel feedthrough 2.4.GHz and 5 GHz cabinet feedthrough for wall thickness maximum 4.5 mm	6GK5798-2PP00-2AA6

2.3 Terminals

The device has the following terminal strips.

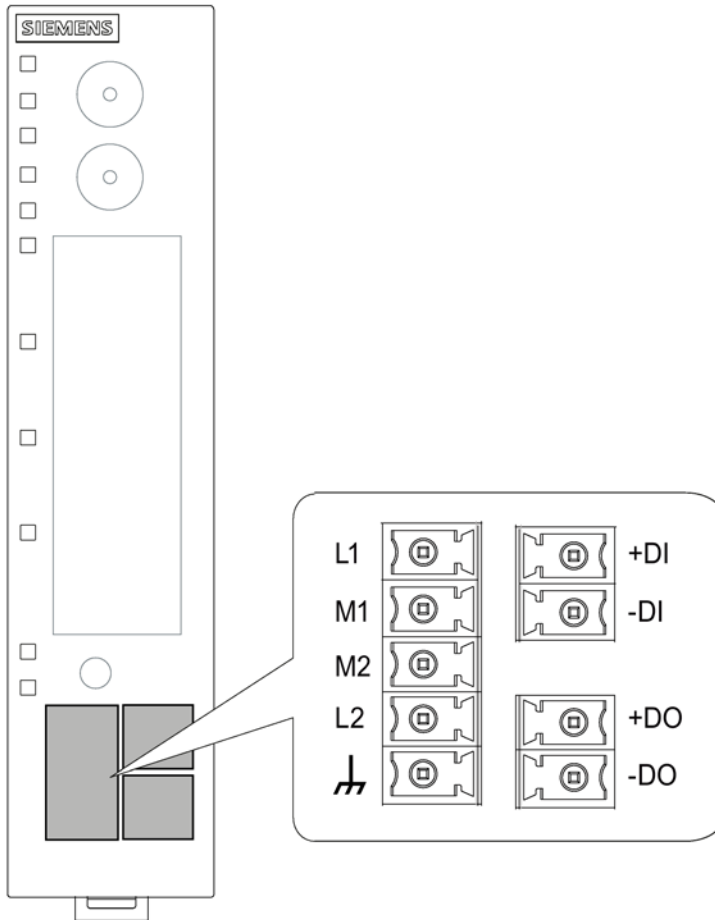





Connectors and terminal markings	
① Input for the power supply L1, M2, L2, M2	Terminal strip with five screw connectors
② Functional ground 	
③ Digital input +DI, -DI	Terminal strip with two screw connectors
④ Digital output +DO, -DO	Terminal strip with two screw connectors



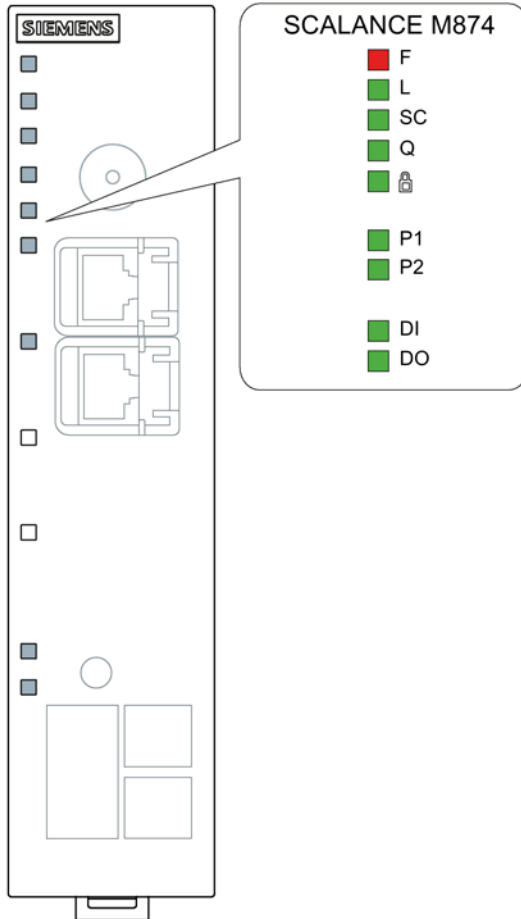













	Terminals ① - ④	
Screwdriver blade	0.4 x 2.5 (DIN 5264)	
Clamping screw	M2	
Tightening torque	0.2 Nm - 0.25 Nm	
AWG	28 AWG	16 AWG
Wire end ferrule without plastic collar to DIN 46228/1	0.2 mm ²	1.5 mm ²
Wire end ferrule with plastic collar to DIN 46228/4	0.2 mm ²	1.5 mm ²
Stripped length	7 mm	7 mm

2.4 LED display

2.4.1 SCALANCE M874-2, M874-3



LED	Status	Meaning
F	OFF 	No fault/error.
	ON 	The device is starting up or an error has occurred. Possible errors/faults: <ul style="list-style-type: none"> • Wrong PIN number
	Flashing 	The bootloader waits in this state for a new firmware file that you can download using TFTP.





LED	Status	Meaning
L	OFF 	Device turned off, no power supply.
	ON 	Device turned on, power supply present.
SC	OFF 	SIM card OK, no connection.
	ON 	Wrong PIN number / SIM card error
	ON 	Connection established
Q	OFF 	No reception Signal strength: < -109 dBm
	Flashing 	Signal strength bad: -89 dBm to -109 dBm
	On 	Signal strength medium: -73 dBm to -89 dBm
	ON 	Signal strength good: > -73 dBm
	OFF 	No VPN connection is established.
	ON 	All configured VPN connections are established.
	Flashing 	Only some of the configured VPN connections are established.
P1/P2	OFF 	Ethernet connection to local computer or LAN not established
	ON 	Ethernet connection to local computer or LAN established
	ON 	Device receiving / sending data

2.4 LED display

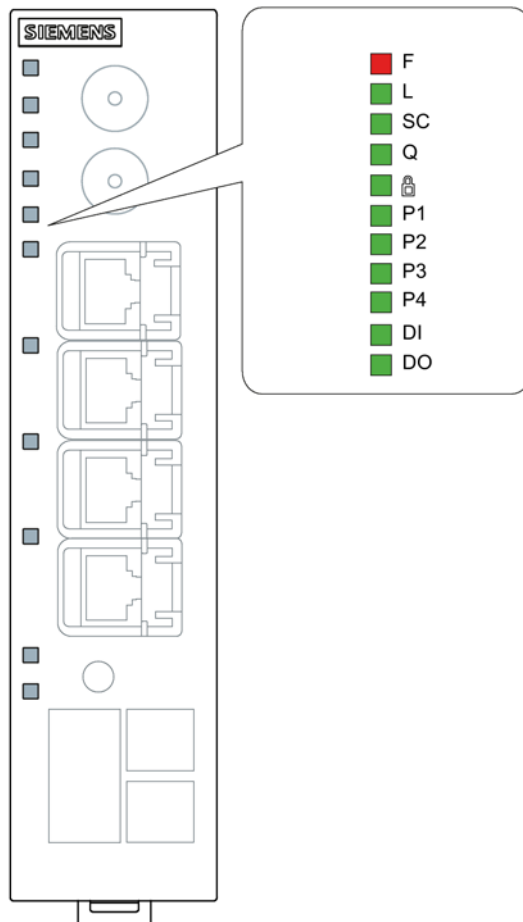

















LED	Status	Meaning
DI	OFF <input type="checkbox"/>	Digital input inactive
	ON <input checked="" type="checkbox"/>	Digital input active.
DO	OFF <input type="checkbox"/>	Digital output inactive
	ON <input checked="" type="checkbox"/>	Digital output active.

2.4.2 SCALANCE M876-3, M876-4



LED	Status	Meaning
F	OFF 	No fault/error.
	ON 	The device is starting up or an error has occurred. Possible errors/faults: <ul style="list-style-type: none"> • Wrong PIN number
	Flashing 	The bootloader waits in this state for a new firmware file that you can download using TFTP.
L	OFF 	Device turned off, no power supply.
	ON 	Device turned on, power supply present.

2.4 LED display

LED	Status	Meaning
SC	OFF 	SIM card OK, no connection.
	ON 	Wrong PIN number / SIM card error
	ON 	Connection established
Q	OFF 	No reception Signal strength: < -109 dBm
	Flashing 	Signal strength bad: -89 dBm to -109 dBm
	On 	Signal strength medium: -73 dBm to -89 dBm
	ON 	Signal strength good: > -73 dBm
	OFF 	No VPN connection is established.
	ON 	All configured VPN connections are established.
	Flashing 	Only some of the configured VPN connections are established.
P1 P2 P3 P4	OFF 	Ethernet connection to local computer or LAN not established
	ON 	Ethernet connection to local computer or LAN established
	ON 	Device receiving / sending data
DI	OFF 	Digital input inactive
	ON 	Digital input active.
DO	OFF 	Digital output inactive
	ON 	Digital output active.

2.5 SET button

With a SCALANCE M.800, the SET button is on the front of the housing beside the LED display.

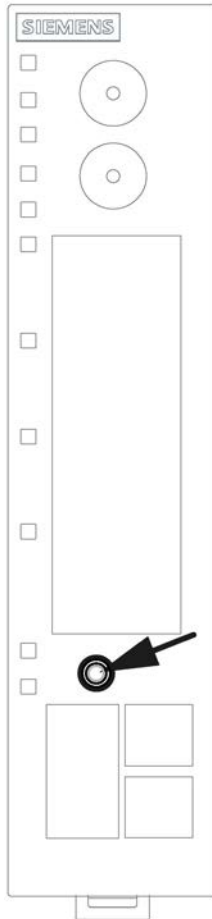

The SET button has the following functions:

- Restart

Hold down the button for shorter than 3 seconds to run a restart.

- Loading new firmware

If the normal procedure with the "Load & Save" menu of Web Based Management does not work, the reset button can be used to load new firmware. This situation can occur if there is a power outage during the normal firmware update.

- Hold down the button until the red fault LED (F) starts to flash after approximately 3 seconds.
- Now release the button. The bootloader waits in this state for a new firmware file that you can download using TFTP.

You will find more information in the section "Service and Maintenance" in the SCALANCE M-800 Web Based Management configuration manual.

2.5 SET button

- Reset to factory defaults
 - Hold down the button until the red fault LED (F) stops flashing after approximately 10 seconds and is permanently lit.
 - Now release the button and wait until the fault LED (F) goes off again. The device then starts automatically with the factory settings and can be reached via the IP address 192.168.1.1.

You will find more information in the section "Service and Maintenance" in the SCALANCE M-800 Web Based Management configuration manual.

 WARNING
EXPLOSION HAZARD
Do not press the SET button if there is a potentially explosive atmosphere.

2.6 C-PLUG and KEY-PLUG

How it works

The C-PLUG or KEY-PLUG is used to transfer the configuration of the old device to the new device when a device is replaced.

NOTICE

Do not remove or insert a C-PLUG / KEY-PLUG during operation!
--

A PLUG may only be removed or inserted when the device is turned off. The device checks whether or not a PLUG is present at one second intervals. If it is detected that the PLUG was removed, there is a restart.

If a valid KEY-PLUG was inserted in the device, the device changes to a defined error state following the restart.
--

When the new device starts up with the PLUG, it then continues automatically with exactly the same configuration as the old device. One exception to this can be the IP configuration if it is set over DHCP and the DHCP server has not been reconfigured accordingly.

A reconfiguration is necessary if you use functions based on MAC addresses. If an incorrect PLUG, for example from another product or a damaged PLUG is inserted, the device signals an error with the "F" LED.

You can either remove the PLUG again or select the option to reformat the PLUG.

In terms of the PLUG, devices work in two modes:

- Without PLUG

The device stores the configuration in internal memory. This mode is active when no PLUG is inserted.

- With PLUG

The configuration stored on the PLUG is displayed in WBM in "Information > PLUG". If changes are made to the configuration, the device stores the configuration directly on the PLUG and in the internal memory. This mode is active as soon as a PLUG is inserted. As soon as the device is started with a PLUG inserted, the device starts up with the configuration data on the PLUG.

License information on the KEY-PLUG

In addition to the configuration, the KEY-PLUG also contains a license that allows the use of Siemens Remote Services.

See also

Inserting and removing the PLUG (Page 58)

Accessories (Page 17)

Installation

3

Safety notices

When installing the device, keep to the safety notices listed below.

 WARNING
If a device is operated in an ambient temperature of more than 50 °C, the temperature of the device housing may be higher than 70 °C. The device must therefore be installed so that it is only accessible to service personnel or users that are aware of the reason for restricted access and the required safety measures at an ambient temperature higher than 50 °C.

Safety notices on use in hazardous areas

General safety notices relating to protection against explosion

 WARNING
EXPLOSION HAZARD
SUBSTITUTION OF COMPONENTS MAY IMPAIR SUITABILITY FOR CLASS I, DIVISION 2 OR ZONE 2.

 WARNING
The device may only be operated in an environment with pollution degree 1 or 2 (see IEC 60664-1).

 WARNING
When used in hazardous environments corresponding to Class I, Division 2 or Class I, Zone 2, the device must be installed in a cabinet or a suitable enclosure.

General notes on use according to ATEX and IECEx

 **WARNING**

To comply with EC Directive 94/9 (ATEX95) or the conditions of IECEx, this enclosure or cabinet must meet the requirements of at least IP54 in compliance with EN 60529.

3.1 Securing the housing

Types of installation

For the device, you have the following options:

- Wall mounting (no ceiling mounting)
- Installation on a DIN rail
- Installing on the S7-300 standard rail
- Installing on the S7-1500 standard rail
- Mounting on a pedestal

Strain relief for the cables

Regardless of the type of installation, make sure that there is suitable strain relief for the connecting cable.

Shielding of cables

If cables are installed permanently, it is advisable to remove the insulation of the shielded cable and to establish contact on the shield/PE conductor bar.

Permitted installation direction

- Vertical installation (ventilation openings at the top and bottom)

Clearances

Keep to the minimum clearances to other components or to walls of a housing so that the convection ventilation of the device is not blocked.

- Below at least 10 cm
- Above at least 10 cm
- M876-3
 - At an ambient temperature up to 60° C, a clearance of 5 cm must be maintained between the sides and adjacent devices.
- M876-4
 - At an ambient temperature up to 60° C, a clearance of 5 cm must be maintained between the sides and adjacent devices.
 - Only permitted in the "LTE only" mode:
 - At an ambient temperature OF 60 °C to 70 °C, a convection with an air speed of 0.5 m/s must be must pass through the device.

3.2 Wall mounting

Note

The wall mounting must be capable of supporting four times the weight of the device, but at least 50 N. For information on the weight, refer to the section "Technical specifications (Page 65)".

Requirement

A standard SIM card exists for the device.

Installation

1. Insert the SIM card, see section "SIM card (Page 47)".
2. Prepare the drill holes for wall mounting. For the precise dimensions, refer to the section "SCALANCE M874-2, M874-3 (Page 61)".
3. Secure the device to the wall with two screws. When mounting on a wall, use mounting fittings suitable for the type of wall.

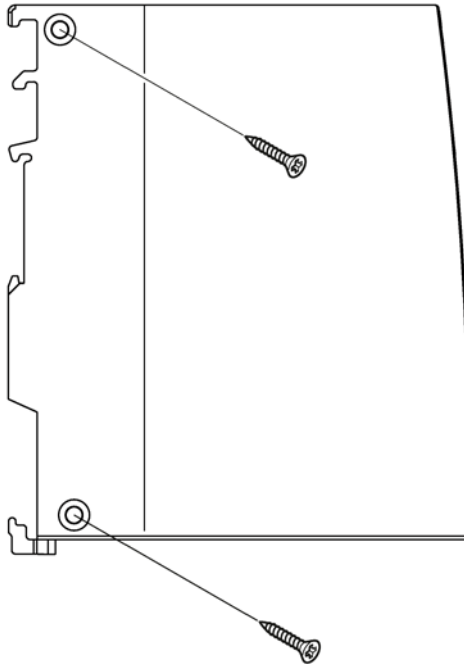

1. Connect the power supply, refer to the section "Power supply (Page 48)".
2. Fit the connectors for the digital input and digital output, refer to the section "Digital input/output (Page 51)".

3. Connect the antenna, refer to the section "Antennas (Page 54)".
4. Connect the device to the local network, refer to the section "Ethernet port (Page 57)".
5. Connect the terminal with as short a cable as possible ≤ 150 mm and a large cross-sectional area ≥ 1.5 mm² to the functional ground of the system, see section "Terminals (Page 20)" and section "Grounding (Page 50)".

3.3 Installation on the DIN rail

Requirement

A standard SIM card exists for the device.

Installation

1. Insert the SIM card, see section "SIM card (Page 47)".
2. Place the third housing guide of the device on the top edge of the DIN rail ①.

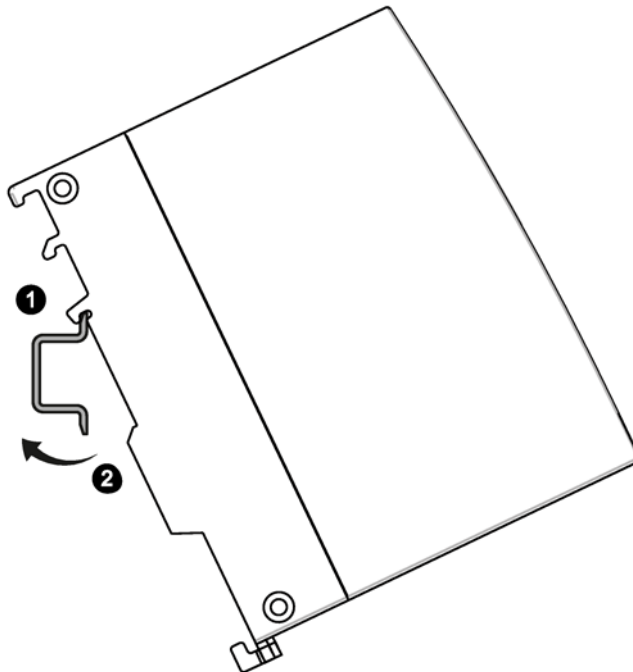

3. Press the device down against the DIN rail until the spring catch locks in place ②.
4. Connect the power supply, refer to the section "Power supply (Page 48)".
5. Fit the connectors for the digital input and digital output, refer to the section "Digital input/output (Page 51)".
6. Connect the antenna, refer to the section "Antennas (Page 54)".
7. Connect the device to the local network, refer to the section "Ethernet port (Page 57)".
8. Connect the terminal with as short a cable as possible ≤ 150 mm and a large cross-sectional area ≥ 1.5 mm² to the functional ground of the system, see section "Terminals (Page 20)" and section "Grounding (Page 50)".

Dismantling

1. Disconnect all connected cables.
2. Using a screwdriver, pull down the catch on the rear of the device.
3. Pull lower part of the device away from the DIN rail.

3.4 Installing on the S7-300 standard rail

Requirement

A standard SIM card exists for the device.

Installation

1. Insert the SIM card, see section "SIM card (Page 47)".
2. Place the second housing guide of the device on the top edge of the standard rail ①.

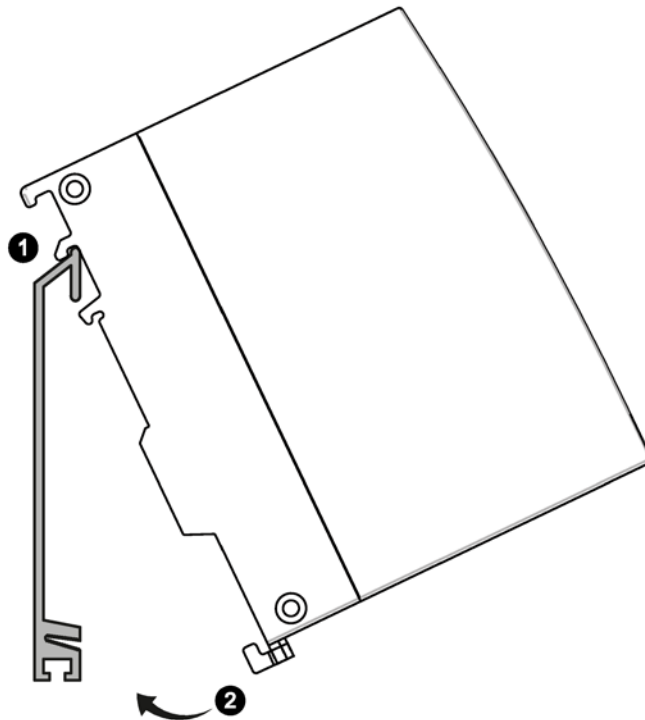

3. Press the device down against the standard rail until the spring catch locks in place ②.
4. Connect the power supply, refer to the section "Power supply (Page 48)".
5. Fit the connectors for the digital input and digital output, refer to the section "Digital input/output (Page 51)".
6. Connect the antenna, refer to the section "Antennas (Page 54)".
7. Connect the device to the local network, refer to the section "Ethernet port (Page 57)".
8. Connect the terminal with as short a cable as possible ≤ 150 mm and a large cross-sectional area ≥ 1.5 mm² to the functional ground of the system, see section "Terminals (Page 20)" and section "Grounding (Page 50)".

Dismantling

1. Disconnect all connected cables.
2. Using a screwdriver, pull down the catch on the rear of the device.
3. Remove the device from the standard rail.

3.5 Installing on the S7-1500 standard rail

Requirement

There is a SIM card for the device.

Installation

1. Insert the SIM card, see section "SIM card (Page 47)".
2. Place the first housing guide of the device on the top edge of the standard rail ①.

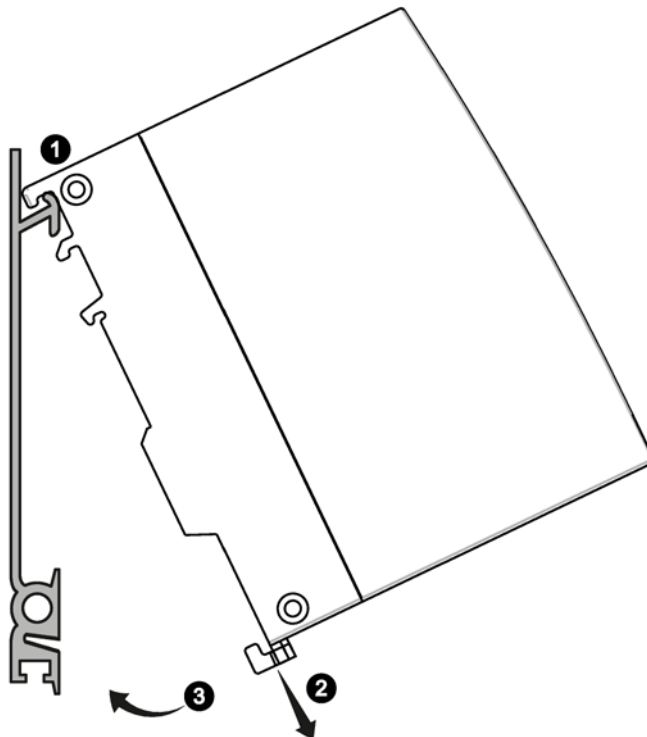

3. Using a screwdriver, pull down the catch ② on the rear of the device.
4. Swing the device down while pulling down the catch ③. After it is released, the spring catch locks in place.
5. Connect the power supply, refer to the section "Power supply (Page 48)".
6. Fit the connectors for the digital input and digital output, refer to the section "Digital input/output (Page 51)".
7. Connect the antenna, refer to the section "Antennas (Page 54)".
8. Connect the device to the local network, refer to the section "Ethernet port (Page 57)".
9. Connect the terminal with as short a cable as possible ≤ 150 mm and a large cross-sectional area ≥ 1.5 mm² to the functional ground of the system, see section "Terminals (Page 20)" and section "Grounding (Page 50)".

Dismantling

1. Disconnect all connected cables.
2. Using a screwdriver, pull down the catch on the rear of the device.
3. Remove the device from the standard rail.

3.6 Installation on a desktop pedestal

Requirement

A standard SIM card exists for the device.

Installation

1. Insert the SIM card, see section "SIM card (Page 47)".
2. Place the third housing guide of the device on the top edge of the pedestal ①.

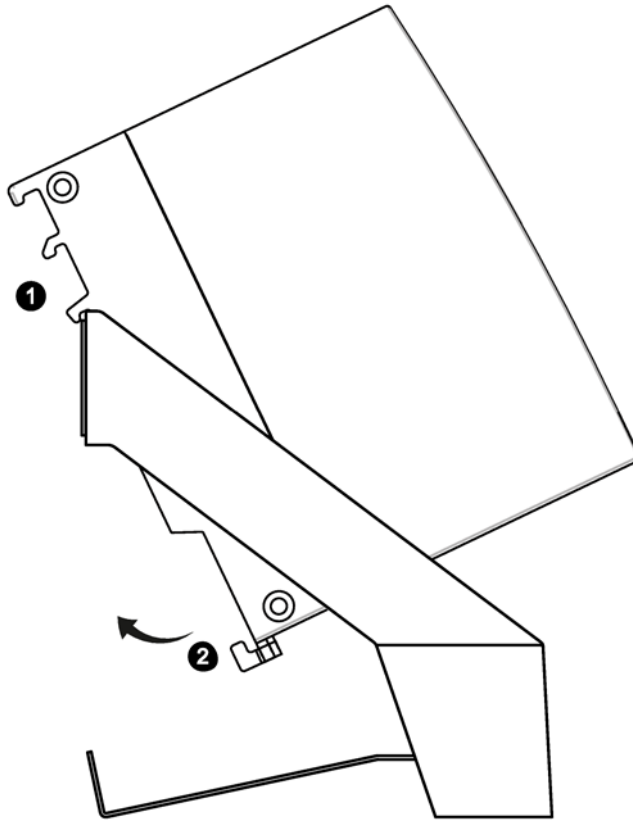

3. Press the device down against the pedestal until the spring catch locks in place ②.
4. Connect the power supply, refer to the section "Power supply (Page 48)".
5. Fit the connectors for the digital input and digital output, refer to the section "Digital input/output (Page 51)".
6. Connect the antenna, refer to the section "Antennas (Page 54)".
7. Connect the device to the local network, refer to the section "Ethernet port (Page 57)".
8. Connect the terminal with as short a cable as possible ≤ 150 mm and a large cross-sectional area ≥ 1.5 mm² to the functional ground of the system, see section "Grounding (Page 50)" and section "Terminals (Page 20)".

Dismantling

1. Disconnect all connected cables.
2. Using a screwdriver, pull down the catch on the rear of the device.
3. Remove the device from the pedestal.

See also

Accessories (Page 17)

Connecting up

4

 WARNING
EXPLOSION HAZARD SUBSTITUTION OF COMPONENTS MAY IMPAIR SUITABILITY FOR CLASS I, DIVISION 2 OR ZONE 2.

 WARNING
EXPLOSION HAZARD DO NOT OPEN WHEN ENERGIZED.

Safety notices

When connecting up the device, keep to the safety notices listed below.

 WARNING
The equipment is designed for operation with Safety Extra-Low Voltage (SELV) by a Limited Power Source (LPS). This means that only SELV / LPS complying with IEC 60950-1 / EN 60950-1 / VDE 0805-1 must be connected to the power supply terminals. The power supply unit for the equipment power supply must comply with NEC Class 2, as described by the National Electrical Code (r) (ANSI / NFPA 70). If the equipment is connected to a redundant power supply (two separate power supplies), both must meet these requirements.

Safety notices on use in hazardous areas

General safety notices relating to protection against explosion

 WARNING
EXPLOSION HAZARD DO NOT CONNECT OR DISCONNECT EQUIPMENT WHEN A FLAMMABLE OR COMBUSTIBLE ATMOSPHERE IS PRESENT.

Safety notices for use according to ATEX and IECEx

If you use the device under ATEX or IECEx conditions you must also keep to the following safety notices in addition to the general safety notices for protection against explosion:

 WARNING
Take measures to prevent transient voltage surges of more than 40% of the rated voltage. This is the case if you only operate devices with SELV (safety extra-low voltage).

Safety notices when using the device according to Hazardous Locations (HazLoc)

If you use the device under HazLoc conditions you must also keep to the following safety notices in addition to the general safety notices for protection against explosion:

 WARNING
EXPLOSION HAZARD DO NOT DISCONNECT WHILE CIRCUIT IS LIVE UNLESS AREA IS KNOWN TO BE NON-HAZARDOUS.

This equipment is suitable for use in Class I, Division 2, Groups A, B, C and D or non-hazardous locations only.

This equipment is suitable for use in Class I, Zone 2, Group IIC or non-hazardous locations only.

4.1 SIM card

NOTICE

Turn off the power supply before replacing SIM cards

Before you insert or remove the SIM card, turn off the power supply of the M-800.

Do not open the compartment for the SIM card during operation. This can damage the SIM card and the device.

Procedure

1. The compartment for the standard SIM card is located on the back of the device. Directly beside to the compartment for the SIM card in the opening in the housing, there is a small button. To open the drawer, press the button with a sharp object, for example a pencil.

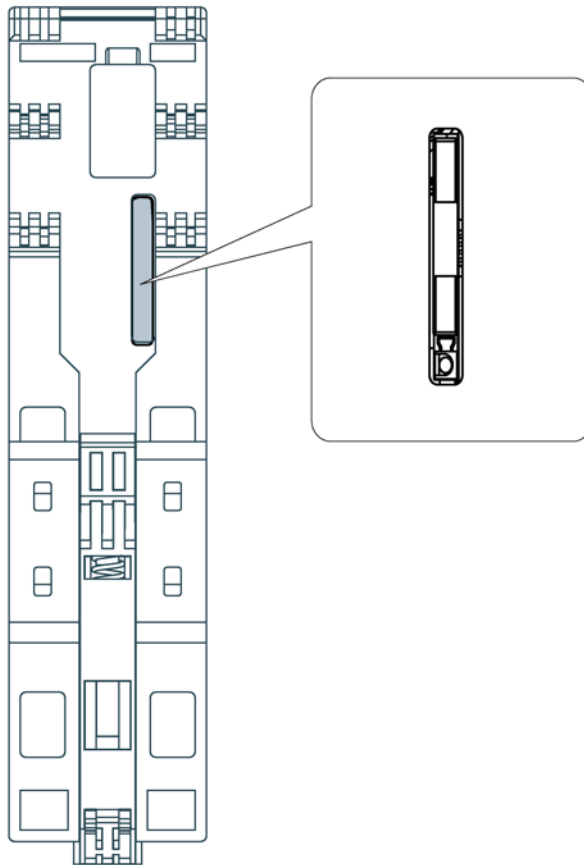

2. Place the SIM card in the tray so that the card audibly locks in place and so that its gold-plated contacts remain visible.
3. Then push the tray with the SIM card completely back into the housing.

4.2 Power supply

The power supply is connected using a 5-pin terminal block. The power supply is non-floating.

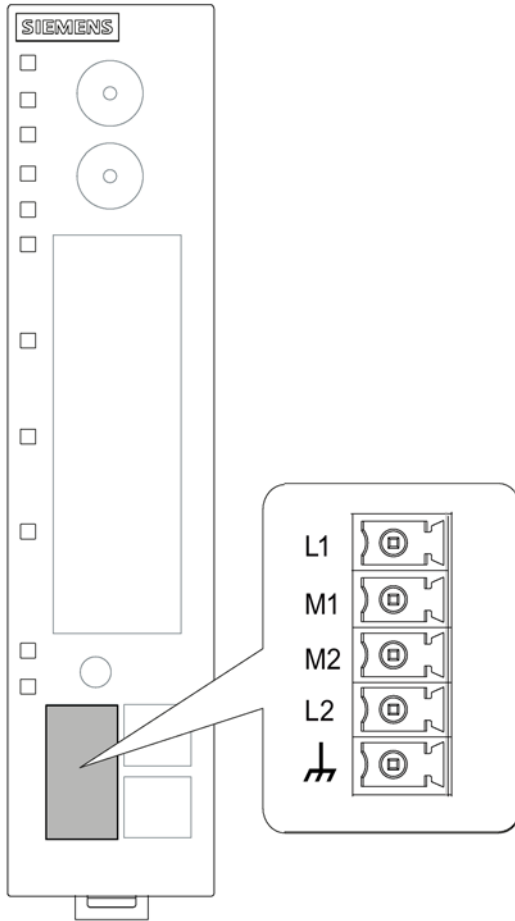

PIN	Signal	Description
1	L1+	24 VDC
2	M1	Ground
3	M2	Ground
4	L2+	24 VDC
5		Functional ground, refer to the section Grounding (Page 50)"

External power supply

Note

Permitted external power supplies

The power supply unit to supply the SCALANCE M87x must comply with the requirements for a limited power source according to IEC/EN 60950-1, section 2.5.

The external power supply for the SCALANCE M87x must meet the requirements for NEC class 2 circuits as specified in the National Electrical Code ® (ANSI/NFPA 70).

Refer to the section Connecting up (Page 45) and the installation instructions and instructions for use of the manufacturer of the power supply, the battery or the accumulator.

Note

External power supply for operation in China

The device may only be used with an external power supply that has a CCC approval.

4.3 Grounding

EMC disturbances are diverted to ground via ground. This increases the immunity of the data transmission.

It is crucial for the correct operation of ground that the connection to the reference potential surface always has low impedance. Such a connection of the functional ground of the device does not go first through the cable channel and then to the mounting plate or DIN rail terminal, but goes directly to the mounting plate or DIN rail terminal.

The SCALANCE M87x has a terminal for grounding, refer to the section "Power supply (Page 48)" or section "Terminals (Page 20)".

The terminal is identified by the following symbol for the grounding.



1. Connect the terminal of the device with as short a cable as possible ≤ 150 mm and a large cross-sectional area ≥ 2.5 mm² to the functional ground of the system. In many cases, the entire metallic construction of the system serves as ground.
2. Also connect the standard rails of a system with ground.

Protective earth/functional ground

The connection of the reference potential surface with the protective earth system is normally in the cabinet close to the power feed-in. This earth conducts fault currents to ground safely and according to DIN/VDE 0100 is a protective earth to protect people, animals and property from too high contact voltages.

Apart from the protective earth, there is functional grounding in the cabinet. According to EN60204-1 (DIN/VDE 0113 T1) electrical circuits must be grounded. The chassis (0 V) is grounded at one defined point. Here, once again the grounding is implemented with the lowest leakage resistance to ground in the vicinity of the power feed-in.

With automation components, functional ground also ensures interference-free operation of a controller. Via the functional ground, interference currents coupled in via the connecting cables are discharged to ground.

In terms of the large-area and low impedance implementation, a functional ground set up for this purpose generally also meets the requirements of protective earth. On the other hand, protective earth does not always meet the requirements of functional ground. In general while the connection for protective earth is always low resistance, it is not necessarily low impedance.

The resistance of a connection for protective earth must always be as small as possible to divert fault currents safely to ground. The length of a protective earth cable can therefore be several meters (m) long, without seriously impairing this effect. For a functional ground for diverting HF disturbances, this cable does however have impedance and is therefore not suitable.

4.4 Digital input/output

The digital input/output (relay contact) is a floating switch with which error/fault states can be signaled by breaking the contact.

 **CAUTION**

Damage due to voltage being too high or too low

The voltage at the digital input/output must not exceed 30 VDC and not fall below -30 VDC, otherwise the digital input/output will be destroyed.

Note

Interference pulse

To avoid evaluating an interference pulse, the pulse for the signal 1 (TRUE / HIGH) must be at least 200 ms.

Rules for user wiring

- Always wire the digital input/output in pairs-
- The maximum permitted cable length is 30 m.

Digital input

The 2-pin terminal block has the following assignment:

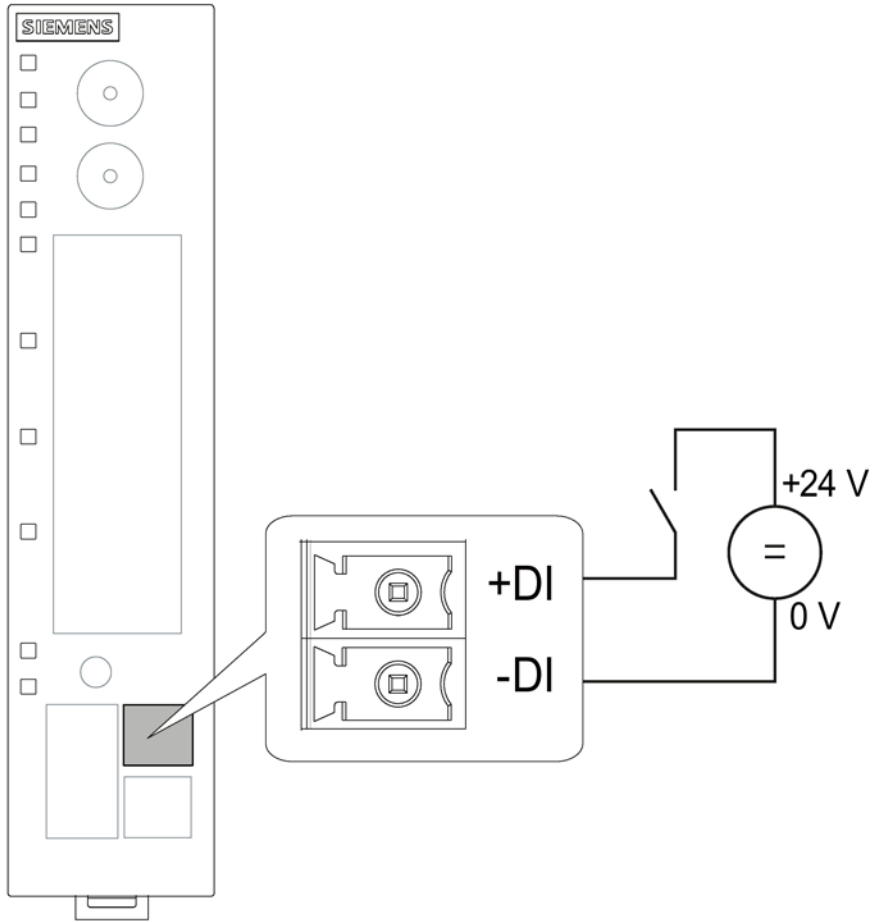

DI+	24 VDC
DI- (input ground)	-

If there is an adequate switching voltage at the digital input, the digital input is active and the "DI" LED is lit.

Digital output

The 2-pin terminal block has the following assignment:

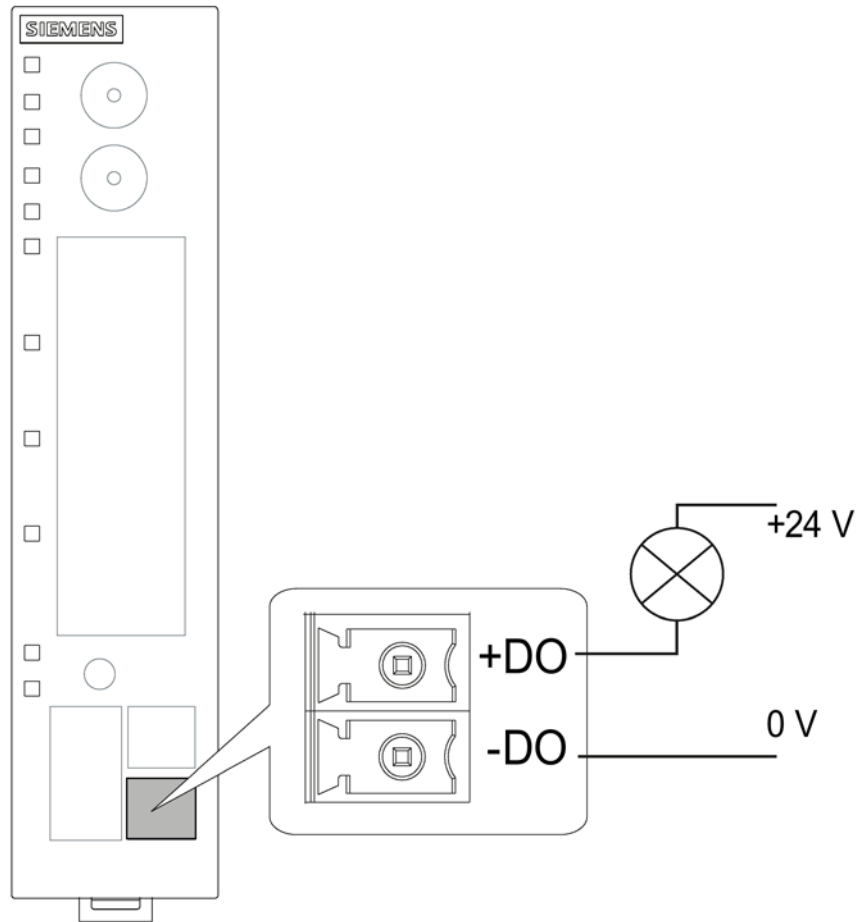

DO+	Relay 24 VDC / 1 A
DO-	Relay 24 VDC / 1 A

4.5 Antennas

Note

Use the antennas from the accessories program for the M87x device. You will find more detailed information in "Accessories (Page 17)". If you use a different antenna, there is no guarantee that the device will function according to the specification.

The antenna socket for connecting the antenna is of the type SMA. The antenna used should have an impedance of about 50 ohms.

 CAUTION
--

Minimum clearance to the device
--

The device may only be operated when the distance between the device (or antenna) and user is at least 20 cm.

Notes on lightning protection



 WARNING

Danger due to lightning strikes
--

Antennas installed outdoors must be within the area covered by a lightning protection system. Make sure that all conducting systems entering from outdoors are protected by lightning protection electrical bonding.
--

When implementing your lightning protection concept, make sure you adhere to the requirements of the VDE 0182 or IEC 62305 standards.

Suitable lightning protectors are available in the range of accessories of SIMATIC NET Industrial WLAN:

- Lightning protector LP798-1N (order no. 6GK5798-2LP00-2AA6)
- Lightning protector LP798-2N (order no. 6GK5798-2LP10-2AA6)

Note

We recommend that you use the maintenance-free lightning protector LP798-2N. Exception:

When there is also DC power supplied via the antenna cable. In this case, only the lightning protector LP798-1N can be used.

- Depending on the connector, an adapter cable is required to connect to SMA.



⚠ WARNING

Danger due to lightning strikes

Installing this lightning protector between an antenna and a SCALANCE M87x is not adequate protection against a lightning strike. The LP798-1N lightning protector only works within the framework of a comprehensive lightning protection concept. If you have questions, ask a qualified specialist company.

Note

The requirements of EN61000-4-5, "Surge Immunity Test" on power supply lines with 24 VDC are met only when a Blitzductor is used:

24 VDC: BVT AVD 24 type no. 918 422

Vendor: DEHN+SÖHNE GmbH+Co.KG, Hans Dehn Str. 1, Postfach 1640, D - 92306 Neumarkt, Germany

Frequency bands in Europe, China, the USA and other regions

Depending on the frequency bands used by your mobile wireless provider, antennas must be tuned to the following frequencies:

- In Europe, America, Africa, Asia and Australia:
 - GSM 900 MHz
 - DCS 1800 MHz
 - UMTS 2100 MHz
 - LTE 800 MHz, 900 MHz, 1800 MHz, 2100 MHz, 2600 MHz depending on the provider
- In the USA:
 - GSM 850 MHz
 - PCS 1900 MHz (also for UMTS)
- In Korea:
 - UMTS 2100 MHz

Check with your mobile wireless provider for the suitable frequencies.

Signal quality

During installation make sure that there is a good signal strength of > -73 dBm.

If the "Q" LED is lit permanently, the signal quality is good. For more detailed information, refer to the section "LED display (Page 22)".

Avoid large metal objects in the immediate vicinity.

SCALANCE M876 antenna connectors

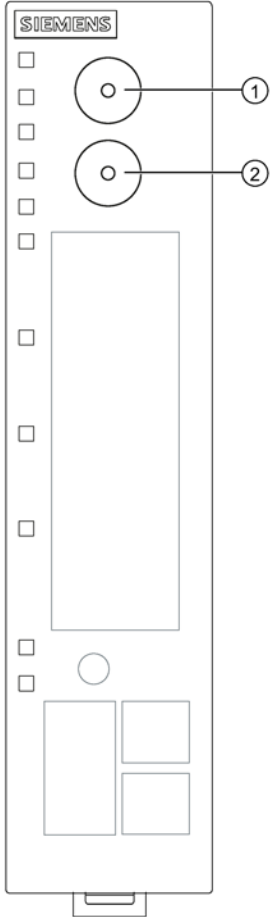

- ① Antenne (Receive Diversity)
- ② Antenne (Main)

4.6 Ethernet port

Connect the local network with the local applications to the Ethernet port, for example a programmable logic controller, a machine with an Ethernet interface for remote monitoring or a PC.

To set up the device, connect a PC with a Web browser to one of the Ethernet ports.

For the connection, use a patch cable with an RJ-45 plug. You will find the properties of the Ethernet interface in the technical specifications.

4.7 Inserting and removing the PLUG

NOTICE

Do not remove or insert a C-PLUG / KEY-PLUG during operation!

A PLUG may only be removed or inserted when the device is turned off.

The device checks whether or not a PLUG is present at one second intervals. If it is detected that the PLUG was removed, there is a restart. If a valid KEY-PLUG was inserted in the device, the device changes to a defined error state following the restart. With SCALANCE M, the wireless interface is deactivated in this case.

Inserting the PLUG

1. Turn off the power to the device.
2. The housing of the PLUG has a protruding ridge on the long side. The slot has a groove at this position.
Insert the PLUG correctly oriented into the slot.

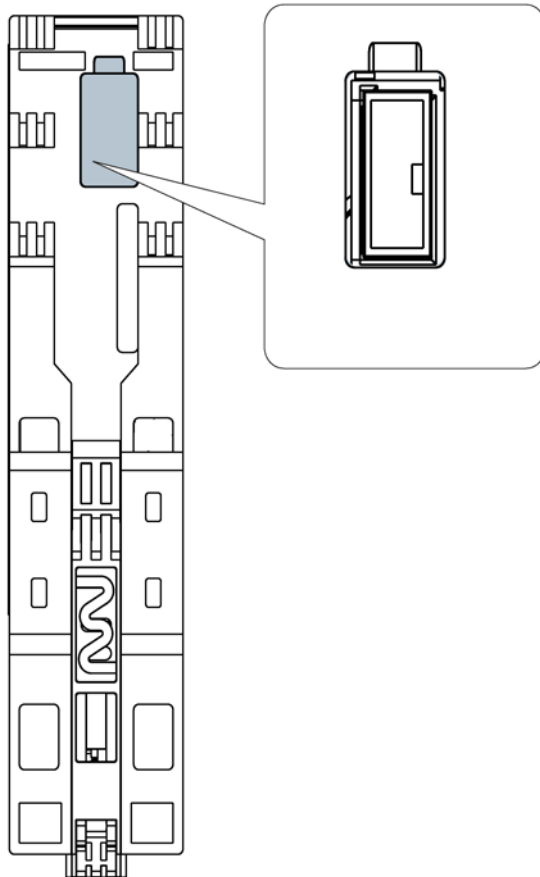

Removing the PLUG

1. Turn off the power to the device.
2. Insert a screwdriver between the front edge of the PLUG and the slot and release the PLUG.
3. Remove the PLUG.

Dimension drawings

5.1 SCALANCE M874-2, M874-3

Dimensions are specified in mm.

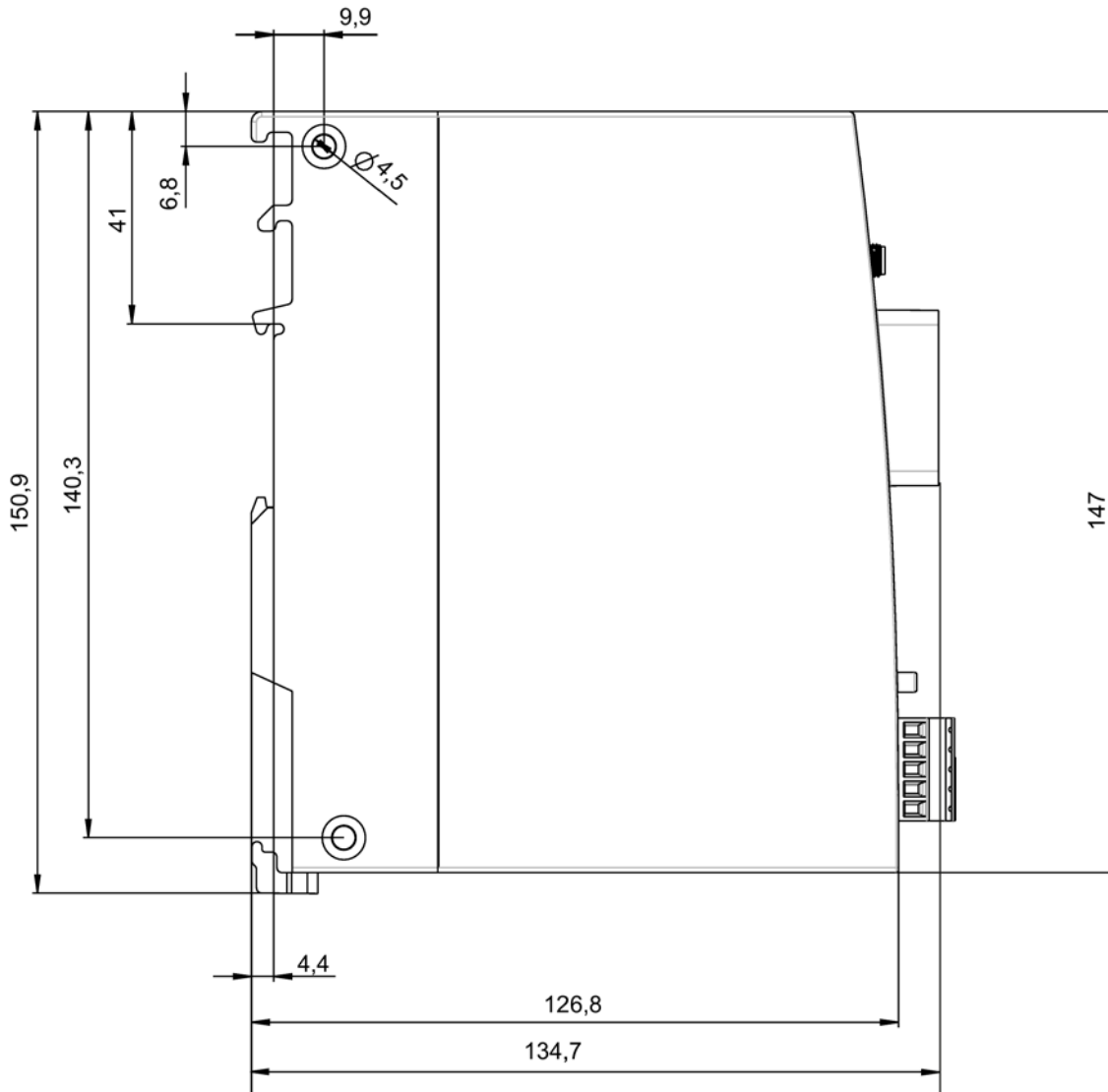

Figure 5-1 Side view M874-2 and M874-3

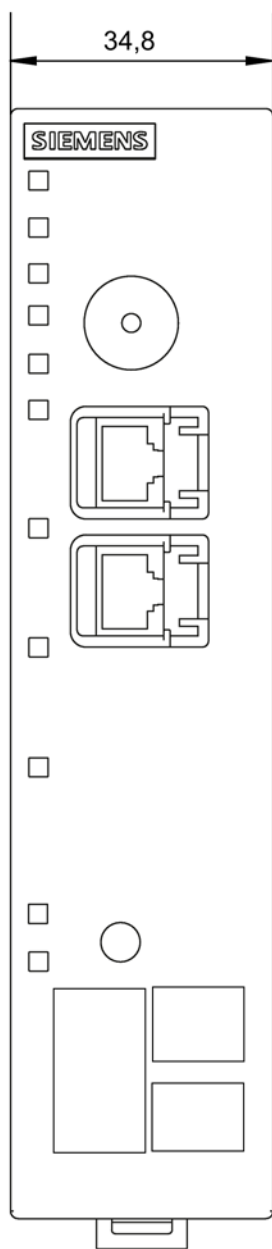

Figure 5-2 Front view M874-2 and M874-3

5.2 SCALANCE M876-3, M876-4

Dimensions are specified in mm.

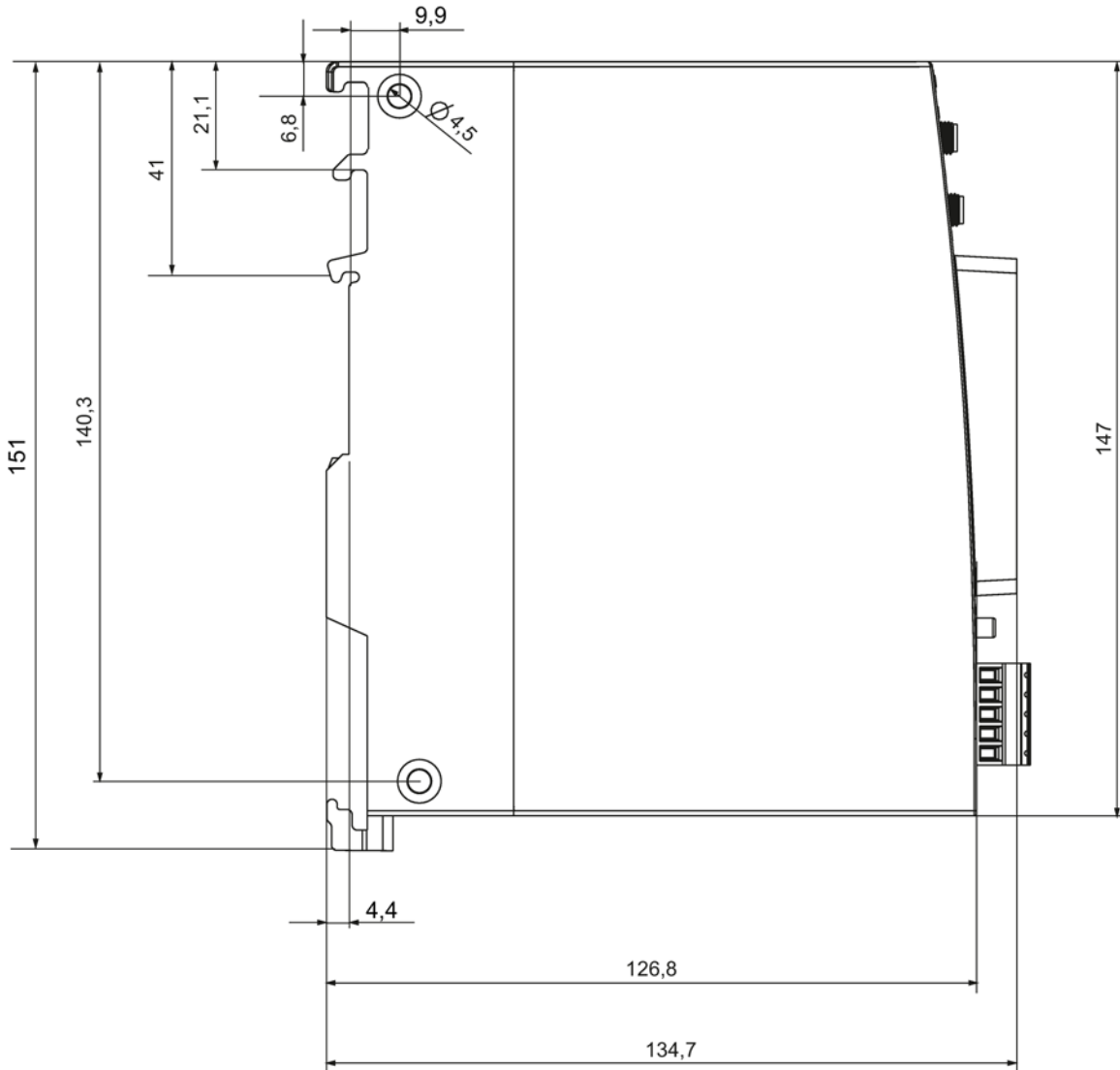

Figure 5-3 M876-3 and M876-4 side view

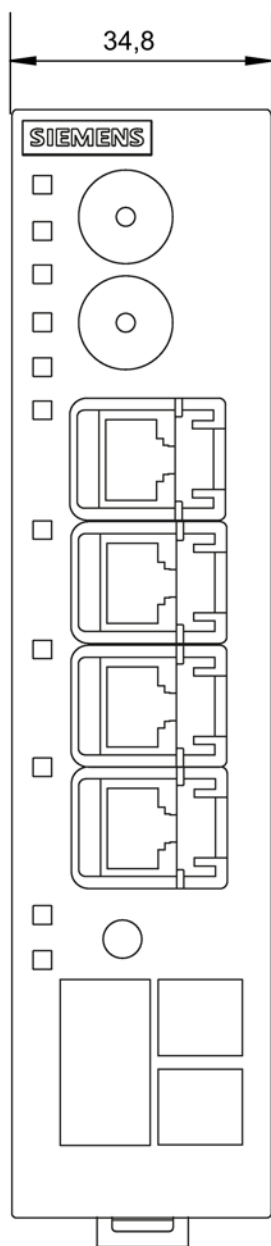

Figure 5-4 M876-3 and M876-4 front view

Technical specifications

6.1 GPRS/EDGE router SCALANCE M874-2

M874-2		
Article number		6GK5 874-2AA00-2AA2
Ethernet interface		
Attachment to Industrial Ethernet	Quantity	2
	Design	RJ-45 jack Characteristics: <ul style="list-style-type: none"> • 10/100BASE-T • Ethernet IEEE 802.3 • 10/100 Mbps
Wireless interface		
Antenna connector	Quantity	1
	Design	SMA socket (straight)
	Impedance	50 Ω nominal
	Antenna cable	Cable length < 30 m
Frequency band	GSM	850 MHz = GSM 850 900 MHz = GSM 900 1800 MHz = GSM 1800 1900 MHz = GSM 1900
EGPRS	Properties	Multislot class 12, end device class B <ul style="list-style-type: none"> • Coding scheme downlink: CS 1 ... 4, MCS 1 ... 9 • Coding scheme uplink: CS 1 ... 4, MCS 1 ... 9
	Transmission speed	<ul style="list-style-type: none"> • Downlink: up to 237 kbps: • Uplink: up to 237 kbps:
GPRS	Properties	Multislot class 12, end device class B, coding scheme 1 ... 4
	Transmission speed	<ul style="list-style-type: none"> • Downlink: up to 85.6 kbps. • Uplink: up to 85.6 kbps.
GSM (CSD dial-in)	Properties	Radio Link Protocol (RLP) V.110, non-transparent
	Transmission speed	up to 14.4 kbps
SMS (TX)	Properties	Text mode, SMSoverIP

M874-2		
Electrical data		
Power supply	Quantity	1
	Design	Terminal block, 5 terminals
	Properties	Input voltage: <ul style="list-style-type: none"> • 12 to 24 VDC • min. 10.8 VDC, max. 28.8 VDC Maximum power consumption 8 W Maximum cable length < 3 m
Digital input	Quantity	1
	Design	Terminal block, 2 terminals
	Properties	Rated voltage 24 VDC Safety Extra Low Voltage (SELV) For state "1": 10 to 30 VDC For state "0": -30 to 3 VDC Maximum input current 8 mA Cables should be routed in pairs Maximum cable length < 30 m Inputs isolated from electronics.
Digital output	Quantity	1
	Design	Terminal block, 2 terminals
	Properties	Rated voltage 24 VDC Safety Extra Low Voltage (SELV) Relay, internally not current limited Maximum current carrying capacity 1 A Cables should be routed in pairs Maximum cable length < 30 m Output isolated from electronics
Permitted ambient conditions		
Ambient temperature	During operation	-20 °C to +60 °C
	During storage	-40 °C to +70 °C
	During transportation	-40 °C to +70 °C
Relative humidity	During operation	≤ 95% at 25 °C, no condensation

M874-2	
Design, dimensions and weight	
Module format	Compact module S7-1500
Degree of protection	IP20
Weight	290 g
Dimensions (W x H x D)	34.8 x 150.9 x 134.7 mm
Installation options	<ul style="list-style-type: none"> • Wall mounting • Mounting on a DIN rail • Mounting on an S7-300 standard rail • Mounting on an S7-1500 standard rail • Mounting on a pedestal
Installation direction	Vertical (ventilation openings at the top and bottom)
Product functions	
Firewall and security	<ul style="list-style-type: none"> • Stateful inspection • Packet filter • IPsec VPN for up to 20 connections • Password protection
Router functions	<ul style="list-style-type: none"> • NAT (port forwarding) • NAT (IP masquerading) • NAT traversal • NETMAP • Dynamic DNS client • DNS cache • NTP • Remote logging • Connection monitoring • Alarm SMS • Sending SMS messages from the local area network
Configuration / management	<ul style="list-style-type: none"> • Web-based administration user interface (WBM) • Remote access with HTTPS • SNMP and SNMP traps

6.2 HSPA+ router SCALANCE M874-3

M874-3		
Article number		6GK5 874-3AA00-2AA2
Ethernet interface		
Attachment to Industrial Ethernet	Quantity	2
	Design	RJ-45 jack
		Characteristics:
		<ul style="list-style-type: none"> • 10/100BASE-T • Ethernet IEEE 802.3 • 10/100 Mbps
Wireless interface		
Antenna connector	Quantity	1
	Design	SMA socket (straight)
	Impedance	50 Ω nominal
	Antenna cable	Cable length < 30 m
Frequency bands	UMTS	800 MHz = band VI 850 MHz = band V 900 MHz = band VIII 1900 MHz = band II 2100 MHz = band I
	GSM	850 MHz = GSM 850 900 MHz = GSM 900 1800 MHz = GSM 1800 1900 MHz = GSM 1900
UMTS with HSPA+	Transmission speed	<ul style="list-style-type: none"> • HSDPA (downlink): up to 14.4 Mbps • HSUPA (uplink): up to 5.76 Mbps
EGPRS	Properties	Multislot class 12, end device class B <ul style="list-style-type: none"> • Coding scheme downlink: CS 1 ... 4, MCS 1 ... 9 • Coding scheme uplink: CS 1 ... 4, MCS 1 ... 9
	Transmission speed	<ul style="list-style-type: none"> • Downlink: up to 237 kbps: • Uplink: up to 237 kbps:
GPRS	Properties	Multislot class 12, end device class B, coding scheme 1 ... 4
	Transmission speed	<ul style="list-style-type: none"> • Downlink: up to 85.6 kbps. • Uplink: up to 85.6 kbps.

M874-3		
GSM (CSD dial-in)	Properties	Radio Link Protocol (RLP) V.110, non-transparent
	Transmission speed	up to 14.4 kbps
SMS (TX)	Properties	Text mode, SMSoverIP
Electrical data		
Power supply	Quantity	1
	Design	Terminal block, 5 terminals
	Properties	Input voltage: <ul style="list-style-type: none"> • 12 to 24 VDC • min. 10.8 VDC, max. 28.8 VDC Maximum power consumption 8 W Maximum cable length < 3 m
Digital input	Quantity	1
	Design	Terminal block, 2 terminals
	Properties	Rated voltage 24 VDC Safety Extra Low Voltage (SELV) For state "1": 10 to 30 VDC For state "0": -30 to 3 VDC Maximum input current 8 mA Cables should be routed in pairs Maximum cable length < 30 m Inputs isolated from electronics.
Digital output	Quantity	1
	Design	Terminal block, 2 terminals
	Properties	Rated voltage 24 VDC Safety Extra Low Voltage (SELV) Relay, internally not current limited Maximum current carrying capacity 1 A Cables should be routed in pairs Maximum cable length < 30 m Output isolated from electronics
Permitted ambient conditions		
Ambient temperature	During operation	-20 °C ... +60 °C (vertical installation) Installed horizontally, the device can be used for ambient temperatures up to 40 °C.
	During storage	-40 °C to +70 °C
	During transportation	-40 °C to +70 °C
Relative humidity	During operation	≤ 95% at 25 °C, no condensation

M874-3	
Design, dimensions and weight	
Module format	Compact module S7-1500
Degree of protection	IP20
Weight	290 g
Dimensions (W x H x D)	34.8 x 150.9 x 134.7 mm
Installation options	<ul style="list-style-type: none">• Wall mounting• Mounting on a DIN rail• Mounting on an S7-300 standard rail• Mounting on an S7-1500 standard rail• Mounting on a pedestal
Installation direction	Vertical (ventilation openings at the top and bottom)
Product functions	
Firewall and security	<ul style="list-style-type: none">• Stateful inspection• Packet filter• IPsec VPN for up to 20 connections• SINEMA RC client• Password protection
Router functions	<ul style="list-style-type: none">• NAT (port forwarding)• NAT (IP masquerading)• NAT traversal• NETMAP• Dynamic DNS client• DNS cache• NTP• Remote logging• Connection monitoring
Configuration / management	<ul style="list-style-type: none">• Web-based administration user interface (WBM)• Remote access with HTTPS• SNMP and SNMP traps

6.3 HSPA+ router SCALANCE M876-3

M876-3		
Article number		6GK5 876-3AA02-2BA2 6GK5 876-3AA02-2EA2
Ethernet interface		
Attachment to Industrial Ethernet	Quantity	4
	Design	RJ-45 jack Characteristics: <ul style="list-style-type: none"> • 10/100BASE-T • Ethernet IEEE 802.3 • 10/100 Mbps
Wireless interface		
Antenna connector	Quantity	2 A1: Main antenna A2: UMTS: RX diversity
	Design	SMA socket (straight)
	Impedance	50 Ω nominal
	Antenna cable	Cable length < 30 m
Frequency bands	GSM	850 MHz = GSM 850 900 MHz = GSM 900 1800 MHz = GSM 1800 1900 MHz = GSM 1900
	UMTS with HSPA+	800 MHz = band VI 850 MHz = band V 900 MHz = band VIII 1900 MHz = band II 2100 MHz = band I
	CDMA	800, 1900 MHz
UMTS with HSPA+	Transmission speed	<ul style="list-style-type: none"> • HSDPA (downlink): up to 14.4 Mbps • HSUPA (uplink): up to 5.76 Mbps
CDMA	Properties	EV-DO Rev.A
	Transmission speed	<ul style="list-style-type: none"> • Forward link: up to 3.1 Mbps • Reverse link: up to 1.8 Mbps

M876-3		
EGPRS	Properties	Multislot class 12, end device class B <ul style="list-style-type: none"> Coding scheme downlink: CS 1 ... 4, MCS 1 ... 9 Coding scheme uplink: CS 1 ... 4, MCS 1 ... 9
	Transmission speed	<ul style="list-style-type: none"> Downlink: up to 237 kbps: Uplink: up to 237 kbps:
GPRS	Properties	Multislot class 12, end device class B, coding scheme 1 ... 4
	Transmission speed	<ul style="list-style-type: none"> Downlink: up to 85.6 kbps. Uplink: up to 85.6 kbps.
GSM (CSD dial-in)	Properties	Radio Link Protocol (RLP) V.110, non-transparent
	Transmission speed	up to 14.4 kbps
SMS (TX)	Properties	Text mode, SMSoverIP
Electrical data		
Power supply	Quantity	1
	Design	Terminal block, 5 terminals
	Properties	Input voltage: <ul style="list-style-type: none"> 12 to 24 VDC min. 10.8 VDC, max. 28.8 VDC Maximum power consumption 8 W Maximum cable length < 3 m
Digital input	Quantity	1
	Design	Terminal block, 2 terminals
	Properties	Rated voltage 24 VDC Safety Extra Low Voltage (SELV) For state "1": 10 to 30 VDC For state "0": -30 to 3 VDC Maximum input current 8 mA Cables should be routed in pairs Maximum cable length < 30 m Inputs isolated from electronics.
Digital output	Quantity	1
	Design	Terminal block, 2 terminals
	Properties	Rated voltage 24 VDC Safety Extra Low Voltage (SELV) Relay, internally not current limited Maximum current carrying capacity 1 A Cables should be routed in pairs Maximum cable length < 30 m Output isolated from electronics

M876-3		
Permitted ambient conditions		
Ambient temperature	During operation	Without air flow and with a clearance at the side of 5 cm to the neighboring device: -20 °C to +60 °C
	During storage	-40 °C to +70 °C
	During transportation	-40 °C to +70 °C
Relative humidity	During operation	≤ 95% at 25 °C, no condensation
Design, dimensions and weight		
Module format	Compact module S7-1500	
Degree of protection	IP20	
Weight	290 g	
Dimensions (W x H x D)	34.8 x 147 x 134.7 mm	
Installation options	<ul style="list-style-type: none"> • Wall mounting • Mounting on a DIN rail • Mounting on an S7-300 standard rail • Mounting on an S7-1500 standard rail • Mounting on a pedestal 	
Installation direction	Vertical (ventilation openings at the top and bottom)	
Product functions		
Firewall and security	<ul style="list-style-type: none"> • Stateful inspection • Packet filter • IPsec VPN for up to 20 connections • SINEMA RC client • Password protection 	

	M876-3
Router functions	<ul style="list-style-type: none">• NAPT (port forwarding)• NAT (IP masquerading)• NAT traversal• NETMAP• Dynamic DNS client• DNS cache• NTP• Remote logging• Connection monitoring• Alarm SMS• Sending SMS messages from the local area network
Configuration / management	<ul style="list-style-type: none">• Web-based administration user interface (WBM)• Remote access with HTTPS• SNMP and SNMP traps

6.4 LTE router SCALANCE M876-4

M876-4		
Article number		6GK5 876-4AA00-2BA2
Ethernet interface		
Attachment to Industrial Ethernet	Quantity	4
	Design	RJ-45 jack Characteristics: <ul style="list-style-type: none"> • 10/100BASE-T • Ethernet IEEE 802.3 • 10/100 Mbps
Wireless interface		
Antenna connector	Quantity	2 A1: Main antenna A2: UMTS: RX diversity LTE: RX MIMO
	Design	SMA socket (straight)
	Impedance	50 Ω nominal
	Antenna cable	Cable length < 30 m
Frequency bands	LTE	2100 MHz = band I
		1800 MHz = band 3
		2600 MHz = band 7
		900 MHz = band 8
		800 MHz = band 20
	UMTS with HSPA+	900 MHz = band VIII
		1800 MHz = band III
		2100 MHz = band I
	GSM	850 MHz = GSM 850
		1900 MHz = GSM 1900
LTE	Transmission speed	<ul style="list-style-type: none"> • Downlink: up to 100 Mbps • Uplink: up to 50 Mbps
UMTS with HSPA+	Transmission speed	<ul style="list-style-type: none"> • HSDPA (downlink): up to 14.4 Mbps • HSUPA (uplink): up to 5.76 Mbps
EGPRS	Properties	Multislot class 12, end device class B <ul style="list-style-type: none"> • Coding scheme downlink: CS 1 ... 4, MCS 1 ... 9 • Coding scheme uplink: CS 1 ... 4, MCS 1 ... 9
	Transmission speed	<ul style="list-style-type: none"> • Downlink: up to 237 kbps: • Uplink: up to 237 kbps:

M876-4		
GPRS	Properties	Multislot class 12, end device class B, coding scheme 1 ... 4
	Transmission speed	<ul style="list-style-type: none"> • Downlink: up to 85.6 kbps. • Uplink: up to 85.6 kbps.
GSM (CSD dial-in)	Properties	Radio Link Protocol (RLP) V.110, non-transparent
	Transmission speed	up to 14.4 kbps
SMS (TX)	Properties	Text mode, SMSoverIP
Electrical data		
Power supply	Quantity	1
	Design	Terminal block, 5 terminals
	Properties	Input voltage: <ul style="list-style-type: none"> • 12 to 24 VDC • min. 10.8 VDC, max. 28.8 VDC Maximum power consumption 8 W Maximum cable length < 3 m
Digital input	Quantity	1
	Design	Terminal block, 2 terminals
	Properties	Rated voltage 24 VDC Safety Extra Low Voltage (SELV) For state "1": 10 to 30 VDC For state "0": -30 to 3 VDC Maximum input current 8 mA Cables should be routed in pairs Maximum cable length < 30 m Inputs isolated from electronics.
Digital output	Quantity	1
	Design	Terminal block, 2 terminals
	Properties	Rated voltage 24 VDC Safety Extra Low Voltage (SELV) Relay, internally not current limited Maximum current carrying capacity 1 A Cables should be routed in pairs Maximum cable length < 30 m Output isolated from electronics

M876-4		
Permitted ambient conditions		
Ambient temperature	During operation	Without air flow and with a clearance at the side of 5 cm to the neighboring device: -20 °C to +60 °C Without clearance at the side and an air flow of 0.5 m/s (only with the "LTE only" mode) -20 °C to +70 °C
	During storage	-40 °C to +70 °C
	During transportation	-40 °C to +70 °C
Relative humidity	During operation	≤ 95% at 25 °C, no condensation
Design, dimensions and weight		
Module format	Compact module S7-1500	
Degree of protection	IP20	
Weight	290 g	
Dimensions (W x H x D)	34.8 x 147 x 134.7 mm	
Installation options	<ul style="list-style-type: none"> • Installation in a 19" rack • Mounting on a DIN rail • Mounting on an S7-300 standard rail • Mounting on an S7-1500 standard rail • Wall mounting • Mounting on a pedestal 	
Installation direction	Vertical (ventilation openings at the top and bottom)	
Product functions		
Firewall and security	<ul style="list-style-type: none"> • Stateful inspection • Packet filter • IPsec VPN for up to 20 connections • SINEMA RC client • Password protection 	

M876-4	
Router functions	<ul style="list-style-type: none">• NAPT (port forwarding)• NAT (IP masquerading)• NAT traversal• NETMAP• Dynamic DNS client• DNS cache• NTP• Remote logging• Connection monitoring• Alarm SMS• Sending SMS messages from the local area network
Configuration / management	<ul style="list-style-type: none">• Web-based administration user interface (WBM)• Command Line Interface (CLI)• Remote access with HTTPS• SNMP and SNMP traps

6.5 LTE router SCALANCE M876-4 (NAM)

M876-4 (NAM)		
Article number		6GK5876-4AA00-2DA2
Ethernet interface		
Attachment to Industrial Ethernet	Quantity	4
	Design	RJ-45 jack Characteristics: <ul style="list-style-type: none"> • 10/100BASE-T • Ethernet IEEE 802.3 • 10/100 Mbps
Wireless interface		
Antenna connector	Quantity	2
		A1: Main antenna A2: UMTS: RX diversity LTE: RX MIMO
	Design	SMA socket (straight)
	Impedance	50 Ω nominal
	Antenna cable	Cable length < 30 m
Frequency bands	LTE	1900 MHz = band 2 AWS = band 4 850 MHz = band 5 700 MHz = band 17 700 MHz = band 13
	UMTS with HSPA+	850 MHz = band V AWS = band IV 1900 MHz = band II
	GSM	850 MHz = GSM 850 900 MHz = GSM 900 1800 MHz = GSM 1800 1900 MHz = GSM 1900
LTE	Transmission speed	<ul style="list-style-type: none"> • Downlink: up to 100 Mbps • Uplink: up to 50 Mbps
UMTS with HSPA+	Transmission speed	<ul style="list-style-type: none"> • HSDPA (downlink): up to 14.4 Mbps • HSUPA (uplink): up to 5.76 Mbps
EGPRS	Properties	Multislot class 12, end device class B <ul style="list-style-type: none"> • Coding scheme downlink: CS 1 ... 4, MCS 1 ... 9 • Coding scheme uplink: CS 1 ... 4, MCS 1 ... 9

M876-4 (NAM)		
	Transmission speed	<ul style="list-style-type: none"> • Downlink: up to 237 kbps: • Uplink: up to 237 kbps:
GPRS	Properties	Multislot class 12, end device class B, coding scheme 1 ... 4
	Transmission speed	<ul style="list-style-type: none"> • Downlink: up to 85.6 kbps. • Uplink: up to 85.6 kbps.
GSM (CSD dial-in)	Properties	Radio Link Protocol (RLP) V.110, non-transparent
	Transmission speed	up to 14.4 kbps
SMS (TX)	Properties	Text mode, SMSoverIP
Electrical data		
Power supply	Quantity	1
	Design	Terminal block, 5 terminals
	Properties	Input voltage: <ul style="list-style-type: none"> • 12 to 24 VDC • min. 10.8 VDC, max. 28.8 VDC Maximum power consumption 8 W Maximum cable length < 3 m
Digital input	Quantity	1
	Design	Terminal block, 2 terminals
	Properties	Rated voltage 24 VDC Safety Extra Low Voltage (SELV) For state "1": 10 to 30 VDC For state "0": -30 to 3 VDC Maximum input current 8 mA Cables should be routed in pairs Maximum cable length < 30 m Inputs isolated from electronics.
Digital output	Quantity	1
	Design	Terminal block, 2 terminals
	Properties	Rated voltage 24 VDC Safety Extra Low Voltage (SELV) Relay, internally not current limited Maximum current carrying capacity 1 A Cables should be routed in pairs Maximum cable length < 30 m Output isolated from electronics
Permitted ambient conditions		

M876-4 (NAM)		
Ambient temperature	During operation	Without air flow and with a clearance at the side of 5 cm to the neighboring device: -20 °C to +60 °C Without clearance at the side and an air flow of 0.5 m/s (only with the "LTE only" mode) -20 °C to +70 °C
	During storage	-40 °C to +70 °C
	During transportation	-40 °C to +70 °C
Relative humidity	During operation	≤ 95% at 25 °C, no condensation
Design, dimensions and weight		
Module format		Compact module S7-1500
Degree of protection		IP20
Weight		290 g
Dimensions (W x H x D)		34.8 x 147 x 134.7 mm
Installation options		<ul style="list-style-type: none"> • Installation in a 19" rack • Mounting on a DIN rail • Mounting on an S7-300 standard rail • Mounting on an S7-1500 standard rail • Wall mounting • Mounting on a pedestal
Installation direction		Vertical (ventilation openings at the top and bottom)
Product functions		
Firewall and security		<ul style="list-style-type: none"> • Stateful inspection • Packet filter • IPsec VPN for up to 20 connections • SINEMA RC client • Password protection

M876-4 (NAM)	
Router functions	<ul style="list-style-type: none">• NAPT (port forwarding)• NAT (IP masquerading)• NAT traversal• NETMAP• Dynamic DNS client• DNS cache• NTP• Remote logging• Connection monitoring• Alarm SMS• Sending SMS messages from the local area network
Configuration / management	<ul style="list-style-type: none">• Web-based administration user interface (WBM)• Command Line Interface (CLI)• Remote access with HTTPS• SNMP and SNMP traps

6.6 Antenna gain

Antenna gain for M874-2, M87x-3

Users and installers must be provided with antenna installation instructions and transmitter operating conditions that must be followed to avoid exceeding the permitted RF exposure.

	Maximum antenna gain	
	GSM 1800	GSM 900
SCALANCE M874-2	10.04 dBi	4.05 dBi
SCALANCE M874-3	9.36 dBi	2.91 dBi
SCALANCE M876-3	9.36 dBi	2.91 dBi

Antenna gain for M876-4

Note

Depending on the selected wireless standard and the wireless frequency used, antennas with different antenna gains can be used. If you change the frequency band during operation, it is possible that the maximum permitted antenna gain also changes. Check whether the antenna you are using is approved for the changed frequency range. If necessary, change the antenna so as not to violate the operational requirements. Or use an antenna with a gain less than 3.58 dBi to cover all bands.

Frequency band	Maximum antenna gain in dBi
GSM /GPRS 900	3.58
E-GPRS 900	9.88
GSM /GPRS 1800	9.84
E-GPRS 1800	13.85
UMTS FDD1	13.35
UMTS FDD III	13.45
UMTS VIII	10.27
LTE FDD 3	12.66
LTE FDD 7	13.86
LTE FDD 8	10.58
LTE FDD 20	8.76

Antenna gain for M876-4NAM

R&TTE / RED (Europe)

Frequency band		Maximum antenna gain in dBi
900 MHz	GSM /GPRS 900	2.96
	GSM /GPRS 1800	8.85

FFC (USA)

Frequency band			Maximum antenna gain in dBi
850 MHz	LTE	850 MHz = band 5	3.25
		700 MHz = band 17	3.25
	GSM	850 MHz = GSM 850	3.25
	UMTS with HSPA+	850 MHz = band V	3.25
1700 MHz	LTE	AWS = band 4	5.5
	UMTS with HSPA+	AWS = band IV	5.5
1900 MHz	LTE	1900 MHz = band 2	2.51
	GSM	1900 MHz = GSM 1900	2.51
	UMTS with HSPA+	1900 MHz = band II	2.51

IC (Canada)

Frequency band		Maximum antenna gain in dBi
850 MHz		
LTE	850 MHz = band 5	0.16
	700 MHz = band 13	0.16
	700 MHz = band 17	0.16
GSM	850 MHz = GSM 850	0.16
UMTS with HSPA+	850 MHz = band V	0.16
1700 MHz		
LTE	AWS = band 4	5.5
UMTS with HSPA+	AWS = band IV	5.5
1900 MHz		
LTE	1900 MHz = band 2	2.51
GSM	1900 MHz = GSM 1900	2.51
UMTS with HSPA+	1900 MHz = band II	2.51

Approvals

Approvals issued

Note**Issued approvals on the type plate of the device**

The specified approvals apply only when the corresponding mark is printed on the product. You can check which of the following approvals have been granted for your product by the markings on the type plate.

Approvals for shipbuilding are not printed on the device type plate.

 WARNING**Personal injury and property damage can occur**

The installation of expansions that are not approved for SIMATIC NET products or their target systems may violate the requirements and regulations for safety and electromagnetic compatibility.

Only use expansions that are approved for the system.

- **Keep to the installation guidelines**

The devices meet the requirements if you adhere to the installation and safety instructions contained in this documentation and in the following documentation when installing and operating the devices.
- **You can always find the latest documentation on the Internet**

The current descriptions of the currently available products can always be found on the Internet under the specified entry IDs/Internet pages:

 - "Industrial Ethernet / PROFINET Industrial Ethernet" System Manual
 - "Industrial Ethernet / PROFINET - Passive network components" System Manual

You will find information on the system manuals in the section "Preface (Page 3)", in "Further documentation".

 - "EMC Installation Guidelines" configuration manual

ID = 60612658 (<http://support.automation.siemens.com/WWW/view/en/60612658>)

- **Working on the device**

To protect the device from electrostatic discharge, personnel must first discharge any electrostatic charge from their body before touching the device.

Note

The test was performed with a device and a connected communications partner that also meets the requirements of the standards listed above.

When operating the device with a communications partner that does not comply with these standards, adherence to the corresponding values cannot be guaranteed.

Current approvals on the Internet

You will find the current approvals for the product on the Internet pages of Siemens Industry Online Support.

80046561 (<http://support.automation.siemens.com/WW/view/en/80046561/134200>)

National approvals

You will find an overview of the country-specific wireless approvals of SIMATIC NET devices with GSM or UMTS services on the Internet pages of Siemens Automation Customer Support. You will find the link to the document on the following page:

ik-Info (www.siemens.com/simatic-net/ik-info)

A.1 EU declaration of conformity



The EC Declaration of Conformity is available for all responsible authorities at:

Siemens Aktiengesellschaft
Process Industries and Drives Division,
Process Automation
DE-76181 Karlsruhe
Germany

You will find the EC declaration of conformity for these products on the Internet pages of Siemens Industry Online Support (<https://support.industry.siemens.com/cs/ww/en/ps/15914/cert>).

The SIMATIC NET products described in these Operating Instructions meet the requirements of the following EC directives:

- 94/9/EC
Directive of the European Parliament and the Council of 23 March 1994 on the approximation of the laws of the Member States concerning equipment and protective systems intended for use in potentially explosive atmospheres (until 19.04.2016).
- 2014/34/EU
Directive of the European Parliament and of the Council of 26 February 2014 on the harmonization of the laws of the Member States relating to equipment and protective systems intended for use in potentially explosive atmospheres official journal of the EU L96, 29/03/2014, pages. 309–356 (as of 20.04.2016)
- 1999/5/EC
Directive of the European Parliament and of the Council of March 9, 1999 on Radio Equipment and Telecommunications Terminal Equipment and the mutual recognition of their conformity (until 12.06.2016).
- 2014/53/EU
Directive of the European Parliament and of the Council of April 16, 2014 on the harmonization of the laws of the member states relating to placing radio equipment on the market.; official journal of the EU L153, 22/05/2014, pages. 62–106 (as of 13.06.2016)
- 2011/65/EU (RoHS)
RoHS directive of the European Parliament and of the Council of 8 June 2011 on the restriction of the use of certain hazardous substances in electrical and electronic equipment.

The current versions of the applied standards can be seen in the EC Declaration of Conformity.

Which of the described standards apply to the product can be found in Products (Page 90).

A.1.1 ATEX

ATEX directive (correct usage in potentially explosive atmospheres)

The SIMATIC NET product meets the requirements of the EC directive:94/9/EC (until 19.04.2016) and 2014/34/EU (as of 20.04.2016) "Equipment and Protective Devices for Use in Potentially Explosive Atmospheres" according to the standards listed in the section Products (Page 90):

Applied standard:

- 1 EN 60079-0
Hazardous areas - Part 0: Equipment - General requirements
- 2 EN 60079-15
Explosive atmospheres - Part 15: Equipment protection by type of protection "n"

A.1.2 RoHS

RoHS directive (restriction of the use of certain hazardous substances)

The SIMATIC NET products described in these operating instructions meet the requirements of the EC directive 2011/65/EC for the restriction of the use of certain hazardous substances in electrical and electronic equipment:

Applied standard:

- 3 EN 50581
Technical documentation for the assessment electrical and electronic products with respect to restriction of hazardous substances

A.1.3 R&TTE / RED

A.1.3.1 Protection of health and safety

Article 3 (1) a) protection of health and safety

- 4 EN 60950-1
Information technology equipment - Safety - Part 1: General requirements
- 5 EN 62311
Assessment of electronic and electrical equipment related to human exposure restrictions for electromagnetic fields (0 Hz – 300 GHz)

Art. 3 (1) b) EMC

- 6 ETSI EN 301 489-1
Electromagnetic compatibility and radio spectrum matters (ERM) - Electromagnetic compatibility for radio equipment and services - Part 1 : Common technical requirements
- 7 ETSI EN 301 489-7
Electromagnetic compatibility and radio spectrum matters (ERM) - Electromagnetic compatibility for radio equipment and services - Part 7 : Specific conditions for mobile and portable radio and ancillary equipment of digital cellular radio telecommunications systems (GSM and DCS).
- 8 ETSI EN 301 489-24
Electromagnetic compatibility and radio spectrum matters (ERM) - Electromagnetic compatibility for radio equipment and services - Part 24 : Specific conditions for mobile and portable IMT-2000 CDMA Direct Spread (UTRA) radio and ancillary equipment.
- 9 EN 61000-6-2
Electromagnetic compatibility (EMC) - Part 6-2: Generic standards - Immunity for industrial environments
- 10 EN 61000-6-3
Electromagnetic compatibility (EMC) - Part 6-3: Generic standards - Emission standard for residential, commercial and light-industrial environments
- 11 EN 61000-6-4
Electromagnetic compatibility (EMC) - Part 6-4: Generic standards - Emission standard for industrial environments

Art. 3 (2) Efficient use of the radio spectrum

- 12 ETSI EN 301 511
Global System for Mobile communications (GSM); Harmonized EN for mobile stations in the GSM 900 and GSM 1800 bands covering essential requirements of article 3.2 of the R&TTE directive
- 13 ETSI EN 301 908-1
IMT cellular networks - Harmonized EN covering the essential requirements of article 3.2 of the R&TTE directive - Part 1: Introduction and common requirements
- 14 ETSI EN 301 908-2
IMT cellular networks - Harmonized EN covering the essential requirements of article 3.2 of the R&TTE directive - Part 2: CDMA Direct Spread (UTRA FDD) User Equipment (UE)
- 15 ETSI EN 301 908-13
IMT cellular networks - Harmonized EN covering the essential requirements of article 3.2 of the R&TTE directive - Part 13: Further developed universal terrestrial wireless access (E-UTRA) end devices (UE)

A.1.4 Products

Product designation and standards

The standards that apply to the product are described in ATEX (Page 88), RoHS (Page 88) and R&TTE / RED (Page 89).

Product name	Standards
SCALANCE M874-2	1, 2, 3, 4, 5, 6, 9, 10, 11, 12
SCALANCE M874-3	1, 2, 3, 4, 5, 6, 7, 9, 11, 12, 13, 14
SCALANCE M876-3	1, 2, 3, 4, 5, 6, 7, 9, 11, 12, 13, 14
SCALANCE M876-4	1, 2, 3, 4, 5, 6, 7, 8, 9, 11, 12, 13, 14, 15

See also

Antenna gain (Page 83)

A.2 RCM / C-TICK

The products meet the requirements of the AS/NZS CISPR11 : 2011 standard (Industrial, scientific and medical equipment - Radio- frequency disturbance characteristics - Limits and methods of measurement).

A.3 ATEX

Explosion protection directive (ATEX)

The SIMATIC NET product meets the requirements of the EC directives:94/9/EC (until 19.04.2016) and 2014/34/EU (as of 20.04.2016) "Equipment and Protective Devices for Use in Potentially Explosive Atmospheres".

 **WARNING**

When using (installing) SIMATIC NET products in hazardous area zone 2, make absolutely sure that the associated conditions are adhered to:

You will find these conditions in the document (DC_ATEX_99.pdf) "Approval of SIMATIC/SIMATIC NET Products for Direct Installation in Ex-Zone 2"

You will find the document on the accompanying product CD and in the SIMATIC NET Manual Collection.

ATEX code:

II 3 G Ex nA IIC T4 Gc

Name, address of the notified center:

DEKRA
CERTIFICATION B.V.,
Utrechtseweg
310, 6812 AR Arnhem,
P.O. Box 5185, 6802 ED
Arnhem,

The Netherlands

Test type certificate

KEMA 07 ATEX 0145X

The product meets the requirements of the standards

- EN 60079-0: Explosive atmospheres - Part 0: Equipment - General requirements
- EN 60079-15: Explosive atmospheres - Part 15: Equipment protection by type of protection "n"

The current versions of the standards can be seen in the current version of the type examination certificate KEMA 07 ATEX 0145 X.

A.4 IECEx

IECEx

The SIMATIC NET products meet the requirements of explosion protection according to IECEx.

IECEx classification:

Ex nA IIC T4 Gc

DEK 14.0025X

The products meet the requirements of the following standards:

- IEC 60079-0 : Explosive atmospheres - Part 0: Equipment - General requirements
- IEC 60079-15 : Explosive atmospheres - Part 15: Equipment protection by type of protection "n"

The current versions of the standards can be seen in the current version of the IECEx certificate DEK 14.0025X.

A.5 Conformity with FCC

The FCC approval applies to the following SCALANCE M device:

	FCC ID
SCALANCE M874-3	QIPPHS8-P
SCALANCE M876-3	QIPPHX8
SCALANCE M876-4 (NAM)	QIPPLS8-X

FCC Part 15

This equipment has been tested and found to comply with the limits for a Class A digital device, pursuant to Part 15 of the FCC Rules.

These limits are designed to provide reasonable protection against harmful interference in a residential installation. This equipment generates, uses and can radiate radio frequency energy.

If not installed and used in accordance with the instructions, this may cause harmful interference to wireless communications. There can be no guarantee, however, with certain installations, even when complying with the instructions, that no interference will be caused. If this equipment does cause harmful interference to radio or television reception that can be determined by turning the equipment off and on, the user is recommended to try to combat the interference with the following measures.

- Change the orientation of the receiving antenna or install it at a different location.
- Increase the distance between the SCALANCE M and the radio or television receiver.
- Connect the device to an outlet on a circuit different from that to which the receiver is connected.
- Consult a dealer / installer or an experienced radio / TV technician.

FCC Part 15.19

This device complies with Part 15 of the FCC Rules. Operation is subject to the following conditions:

- This device must not cause harmful interference.
- This device must accept any interference received, including interference that may cause undesired operation.

FCC Part 15.21

Modifications to the device not expressly approved by the manufacturer could void the user's right to operate the equipment.

The SCALANCE M may only be used with an antenna from the range of accessories of the SCALANCE M.

The installation of the SCALANCE M and the antenna as well as servicing must be performed by qualified technical personnel only. When servicing the antenna, or working at distances closer than those listed below, make sure that the device has been turned off.

This device contains GSM, GPRS Class 12, EGPRS Class 10, and UMTS functions in the 900 and 1800 MHz band that must not be used in territories of the USA.

This device can be used for mobile and fixed applications. Internal / external antennas used with this device must be at a distance of at least 20 cm from all persons and must not be located so that they operate in combination with any other antenna or transmitter.

Users and installers must be provided with antenna installation instructions and transmitter operating conditions that must be followed to avoid exceeding the permitted RF exposure.

Antennas for the transmitter module used must not exceed the following antenna gains in operating configurations for mobile and fixed applications, see Maximum antenna gain (Page 90).

This device is approved as a module for installation in other devices.

See also

Antenna gain (Page 83)

A.6 RSS-210 Industry of Canada

RSS-247 of Industry Canada for SCALANCE M876-4 (NAM)

This device complies with Industry Canada licence-exempt RSS standard(s).

Operation is subject to the following two conditions: (1) this device may not cause interference, and (2) this device must accept any interference, including interference that may cause undesired operation of the device.

This radio transmitter (IC: 267AA-MPCIE1V1) has been approved by Industry Canada to operate with the antenna types listed in section 5.4 with the maximum permissible gain and required antenna impedance for each antenna type indicated. Antenna types not included in this list, having a gain greater than the maximum gain indicated for that type, are strictly prohibited for use with this device.

Under Industry Canada regulations, this radio transmitter may only operate using an antenna of a type and maximum (or lesser) gain approved for the transmitter by Industry Canada. To reduce potential radio interference to other users, the antenna type and its gain should be so chosen that the equivalent isotropically radiated power (e.i.r.p.) is not more than that necessary for successful communication.

To reduce potential radio interference to other users, the antenna type and its gain should be so chosen that the equivalent isotropically radiated power (e.i.r.p.) is not more than that permitted for successful communication.

That the device for the band 5150-5250 MHz is only for indoor usage to reduce potential for harmful interference to co-channel mobile satellite systems.

Users should also be cautioned to take note that high power radars are allocated as primary users (meaning they have priority) of 5250-5350 MHz and 5650-5850 MHz and these radars could cause interference and/or damage to LE-LAN devices.

This equipment complies with IC RSS-102 radiation exposure limits set forth for an uncontrolled environment. This equipment should be installed and operated with minimum distance 20cm between the radiator & your body.

Le présent appareil est conforme aux CNR d'Industrie Canada applicables aux appareils radio exempts de licence. L'exploitation est autorisée aux deux conditions suivantes : (1) l'appareil ne doit pas produire de brouillage, et (2) l'utilisateur de l'appareil doit accepter tout brouillage radioélectrique subi, même si le brouillage est susceptible d'en compromettre le fonctionnement.

See also

Antenna gain (Page 83)

A.7 FM certification



Approved for use in
Cl. 1, Div. 2, GP. A, B, C, D, T4
Cl. 1, Zone 2, GP. IIC T4

Ta: -20 °C to + 60 C

For the use of the product in hazardous areas, the following requirements are met:

- Factory Mutual Approval Standard Class Number 3611
- FM Hazardous (Classified) Location Electrical Equipment:
Non Incendive / Class I / Division 2 / Groups A,B,C,D / T4 and
Non Incendive / Class I / Zone 2 / Group IIC / T4

A.8 UL certification (product safety)



Applied standards

- UL 60950-1 (Information Technology Equipment)
- UL 508 (Industrial Control Equipment)
- CSA C22.2 No.60950-1 (Information Technology Equipment)

A.9 UL HAZ. LOC certification (explosion protection)



I.T.E. for HAZ.LOC.

CL.I, DIV.2, GP A,B,C,D T4

CL.1, Zone2, GP IIC, T4

For temperature information "T.." or the maximum ambient temperature "Ta:..", refer to the type plate.

Applied standards

- UL 60950-1 (Information Technology Equipment)
- CSA C22.2 No.60950-1 (Information Technology Equipment)
- ANSI/ISA 12.12.01-2007
- CSA C22.2 No. 213-M1987

A.10 EAC

Marking for the customs union



EAC (Eurasian Conformity)

Customs union of Russia, Belarus and Kazakhstan

Declaration of the conformity according to the technical regulations of the customs union (TR CU)

Index

A

Accessories, 17

C

Connecting up

Digital input, 52

Digital output, 53

Ethernet interface, 57

Grounding, 50

Power supply, 48

SIM card, 47

C-PLUG, 29

D

Digital input, 52

Digital output, 53

Dimension drawing

SCALANCE M874-2, 61

SCALANCE M874-3, 61

SCALANCE M876-3, 63

SCALANCE M876-4, 63

DIN rail, 36

E

Ethernet interface, 57

External power supply

China, 49

G

Glossary, 7

Grounding, 50

I

Installation

DIN rail, 36

Pedestal, 42

S7-1500 standard rail, 40, 40

S7-300 standard rail, 38

Wall, 34

K

KEY-PLUG, 29

L

LED display

M874-2, 22

M874-3, 22

M876-3, 25

P

Power supply, 48

Product property, 15

S

S7-1500 standard rail, 40

S7-300 standard rail, 38

Safety notices

for installation, 31

Use in hazardous areas, 31, 45

when connecting up, 45

Scope of delivery, 15

SET button, 27

Signal quality, 55

SIM card, 47

SIMATIC NET glossary, 7

System manual, 85

W

Wall mounting, 34

