

ACS350

User's Manual

ACS350 Drives (0.37...22 kW, 0.5...30 HP)



ACS350 drive manuals

OPTION MANUALS (delivered with optional equipment)

FCAN-01 CANopen Adapter Module User's Manual
3AFE68615500 (EN)

FDNA-01 DeviceNet Adapter Module User's Manual
3AFE68573360 (EN)

FMBA-01 Modbus Adapter Module User's Manual
3AFE68586704 (EN)

FPBA-01 PROFIBUS DP Adapter Module User's Manual
3AFE68573271 (EN)

FRSA-00 RS-485 Adapter Board User's Manual
3AFE68640300 (EN)

MFDT-01 FlashDrop User's Manual
3AFE68591074 (EN)

MPOT-01 Potentiometer Module Instructions for Installation
and Use
3AFE68591082 (EN, DA, DE, ES, FI, FR, IT, NL, PT, RU, SV)

MTAC-01 Pulse Encoder Interface Module User's Manual
3AFE68591091 (EN)

MUL1-R1 Installation Instructions for ACS150 and ACS350
3AFE68642868 (EN, DA, DE, ES, FI, FR, IT, NL, PT, RU, SV)

MUL1-R3 Installation Instructions for ACS150 and ACS350
3AFE68643147 (EN, DA, DE, ES, FI, FR, IT, NL, PT, RU, SV)

MAINTENANCE MANUALS

Guide for Capacitor Reforming in ACS50/150/350/550
3AFE68735190 (EN)

ACS350 Drives
0.37...22 kW
0.5...30 HP

User's Manual

3AFE68462401 Rev D
EN
EFFECTIVE: 30.09.2007

Safety

What this chapter contains

The chapter contains the safety instructions which you must follow when installing, operating and servicing the drive. If ignored, physical injury or death may follow, or damage may occur to the drive, motor or driven equipment. Read the safety instructions before you work on the drive.

Use of warning symbols

There are two types of safety warnings throughout this manual:



Danger; electricity warns of high voltage which can cause physical injury and/or damage to the equipment.



General danger warns about conditions, other than those caused by electricity, which can result in physical injury and/or damage to the equipment.

Installation and maintenance work

These warnings are intended for all who work on the drive, motor cable or motor.



WARNING! Ignoring the following instructions can cause physical injury or death, or damage to the equipment.

Only qualified electricians are allowed to install and maintain the drive!

- Never work on the drive, motor cable or motor when input power is applied. After disconnecting the input power, always wait for 5 minutes to let the intermediate circuit capacitors discharge before you start working on the drive, motor or motor cable.

Always ensure by measuring with a multimeter (impedance at least 1 Mohm) that:

1. There is no voltage between the drive input phases U1, V1 and W1 and the ground.
 2. There is no voltage between terminals BRK+ and BRK- and the ground.
- Do not work on the control cables when power is applied to the drive or to the external control circuits. Externally supplied control circuits may carry dangerous voltage even when the input power of the drive is switched off.
 - Do not make any insulation or voltage withstand tests on the drive.
 - If a drive whose EMC filter is not disconnected is installed on an IT system [an ungrounded power system or a high resistance-grounded (over 30 ohms) power system], the system will be connected to earth potential through the EMC filter capacitors of the drive. This may cause danger or damage the drive.
 - If a drive whose EMC filter is not disconnected is installed on a corner grounded TN system, the drive will be damaged.

Note:

- Even when the motor is stopped, dangerous voltage is present at the power circuit terminals U1, V1, W1 and U2, V2, W2 and BRK+ and BRK-.



WARNING! Ignoring the following instructions can cause physical injury or death, or damage to the equipment.



- The drive is not field repairable. Never attempt to repair a malfunctioning drive; contact your local ABB representative or Authorized Service Center for replacement.
- Make sure that dust from drilling does not enter the drive during the installation. Electrically conductive dust inside the drive may cause damage or lead to malfunction.
- Ensure sufficient cooling.

Operation and start-up

These warnings are intended for all who plan the operation, start up or operate the drive.



WARNING! Ignoring the following instructions can cause physical injury or death, or damage to the equipment.

- Before adjusting the drive and putting it into service, make sure that the motor and all driven equipment are suitable for operation throughout the speed range provided by the drive. The drive can be adjusted to operate the motor at speeds above and below the speed provided by connecting the motor directly to the power line.
- Do not activate automatic fault reset functions if dangerous situations can occur. When activated, these functions will reset the drive and resume operation after a fault.
- Do not control the motor with an AC contactor or disconnecting device (disconnecting means); use instead the control panel start and stop keys  and  or external commands (I/O or fieldbus). The maximum allowed number of charging cycles of the DC capacitors (i.e. power-ups by applying power) is two per minute and the maximum total number of chargings is 15 000.

Note:



- If an external source for start command is selected and it is ON, the drive will start immediately after an input voltage break or fault reset unless the drive is configured for 3-wire (a pulse) start/stop.
- When the control location is not set to local (LOC not shown on the display), the stop key on the control panel will not stop the drive. To stop the drive using the control panel, press the LOC/REM key  and then the stop key .

Table of contents

ACS350 drive manuals	2
----------------------------	---

Safety

What this chapter contains	5
Use of warning symbols	5
Installation and maintenance work	6
Operation and start-up	7

Table of contents

About the manual

What this chapter contains	19
Compatibility	19
Intended audience	19
Categorization according to the frame size	19
Product and service inquiries	19
Product training	19
Providing feedback on ABB Drives manuals	19
Installation and commissioning flowchart	20

Hardware description

What this chapter contains	21
Overview	21
Overview: Connections	22
Type code	23

Mechanical installation

What this chapter contains	25
Unpacking the drive	25
Delivery check	26
Before installation	26
Requirements for the installation site	26
Mounting the drive	27
Mount the drive	27
Fasten clamping plates	28
Attach the optional fieldbus module	28

Planning electrical installation

What this chapter contains	29
Motor selection	29

AC power line connection	29
Supply disconnecting device	29
Thermal overload and short-circuit protection	30
Protection against short-circuit inside the drive or in the supply cable	30
Protection against short-circuit in the motor and motor cable	31
Thermal overload protection of the motor	31
Selecting the power cables	32
General rules	32
Alternative power cable types	32
Motor cable shield	33
Additional US requirements	33
Protecting the relay output contact and attenuating disturbances in case of inductive loads	34
Residual current device (RCD) compatibility	34
Selecting the control cables	34
Relay cable	35
Control panel cable	35
Connection of a motor temperature sensor to the drive I/O	35
Routing the cables	35
Control cable ducts	36

Electrical installation

What this chapter contains	37
Checking the insulation of the assembly	37
Drive	37
Input cable	37
Motor and motor cable	37
Connecting the power cables	38
Connection diagram	38
Procedure	39
Connecting the control cables	40
I/O terminals	40
Procedure	42

Installation checklist

Checklist	43
-----------	----

Start-up, control with I/O and ID Run

What this chapter contains	45
How to start up the drive	45
How to start up the drive without a control panel	45
How to perform the limited start-up	46
How to perform the guided start-up	51
How to control the drive through the I/O interface	53
How to perform the ID Run	54
ID Run procedure	54

Control panels

What this chapter contains	57
About control panels	57
Compatibility	57
Basic Control Panel	58
Features	58
Overview	58
Operation	59
Output mode	61
Reference mode	62
Parameter mode	63
Copy mode	65
Basic Control Panel alarm codes	66
Assistant Control Panel	67
Features	67
Overview	67
Operation	68
Output mode	72
Parameters mode	74
Assistants mode	76
Changed Parameters mode	77
Fault Logger mode	78
Time and Date mode	79
Parameter Backup mode	81
I/O Settings mode	84

Application macros

What this chapter contains	85
Overview of macros	85
Summary of I/O connections of application macros	86
ABB Standard macro	87
Default I/O connections	87
3-wire macro	88
Default I/O connections	88
Alternate macro	89
Default I/O connections	89
Motor Potentiometer macro	90
Default I/O connections	90
Hand/Auto macro	91
Default I/O connections	91
PID Control macro	92
Default I/O connections	92
Torque Control macro	93
Default I/O connections	93
User macros	94

Program features

What this chapter contains	95
Start-up Assistant	95
Introduction	95
The default order of the tasks	95
List of the tasks and the relevant drive parameters	96
Contents of the assistant displays	97
Local control vs. external control	97
Local control	98
External control	98
Settings	98
Diagnostics	98
Block diagram: Start, stop, direction source for EXT1	99
Block diagram: Reference source for EXT1	99
Reference types and processing	100
Settings	100
Diagnostics	100
Reference trimming	101
Settings	101
Example	102
Programmable analog inputs	102
Settings	102
Diagnostics	103
Programmable analog output	103
Settings	103
Diagnostics	103
Programmable digital inputs	103
Settings	104
Diagnostics	104
Programmable relay output	104
Settings	104
Diagnostics	104
Frequency input	105
Settings	105
Diagnostics	105
Transistor output	105
Settings	105
Diagnostics	105
Actual signals	106
Settings	106
Diagnostics	106
Motor identification	106
Settings	106
Power loss ride-through	107
Settings	107
DC Magnetising	107
Settings	107
Maintenance trigger	107
Settings	107

DC Hold	108
Settings	108
Speed compensated stop	108
Settings	108
Flux Braking	108
Settings	109
Flux Optimisation	110
Settings	110
Acceleration and deceleration ramps	110
Settings	110
Critical Speeds	110
Settings	110
Constant speeds	111
Settings	111
Custom U/f ratio	112
Settings	112
Diagnostics	112
Speed controller tuning	113
Settings	113
Diagnostics	113
Speed control performance figures	114
Torque control performance figures	114
Scalar control	115
Settings	115
IR compensation for a scalar controlled drive	115
Settings	115
Programmable protection functions	115
AI<Min	115
Panel Loss	115
External Fault	116
Stall Protection	116
Motor Thermal Protection	116
Underload Protection	117
Earth Fault Protection	117
Incorrect wiring	117
Input phase loss	117
Preprogrammed faults	117
Overcurrent	117
DC overvoltage	117
DC undervoltage	117
Drive temperature	118
Short circuit	118
Internal fault	118
Operation limits	118
Settings	118
Power limit	118
Automatic resets	118
Settings	118
Supervisions	119
Settings	119

Diagnostics	119
Parameter lock	119
Settings	119
PID control	120
Process controller PID1	120
External/Trim controller PID2	120
Block diagrams	120
Settings	122
Diagnostics	122
Sleep function for the process PID (PID1) control	122
Example	123
Settings	123
Diagnostics	123
Motor temperature measurement through the standard I/O	124
Settings	125
Diagnostics	125
Control of a mechanical brake	126
Example	126
Operation time scheme	127
State shifts	128
Settings	128
Jogging	129
Settings	130
Diagnostics	130
Timed functions	131
Settings	132
Timer	132
Settings	132
Diagnostics	132
Counter	133
Settings	133
Diagnostics	133
Sequence programming	133
Settings	134
Diagnostics	134
Example 1	136
Example 2:	137

Actual signals and parameters

What this chapter contains	141
Terms and abbreviations	141
Fieldbus addresses	141
Fieldbus equivalent	141
Default values with different macros	142
Actual signals	143
01 OPERATING DATA	143
03 FB ACTUAL SIGNALS	145
04 FAULT HISTORY	147
Parameters – short form list	148

Parameters – complete descriptions	159
10 START/STOP/DIR	159
11 REFERENCE SELECT	161
12 CONSTANT SPEEDS	164
13 ANALOGUE INPUTS	167
14 RELAY OUTPUTS	168
15 ANALOGUE OUTPUTS	170
16 SYSTEM CONTROLS	171
18 FREQ IN & TRAN OUT	175
19 TIMER & COUNTER	176
20 LIMITS	180
21 START/STOP	183
22 ACCEL/DECEL	186
23 SPEED CONTROL	189
24 TORQUE CONTROL	191
25 CRITICAL SPEEDS	192
26 MOTOR CONTROL	192
29 MAINTENANCE TRIG	195
30 FAULT FUNCTIONS	196
31 AUTOMATIC RESET	201
32 SUPERVISION	203
33 INFORMATION	204
34 PANEL DISPLAY	205
35 MOTOR TEMP MEAS	209
36 TIMED FUNCTIONS	211
40 PROCESS PID SET 1	214
41 PROCESS PID SET 2	221
42 EXT / TRIM PID	221
43 MECH BRK CONTROL	223
50 ENCODER	224
51 EXT COMM MODULE	224
52 PANEL COMM	225
53 EFB PROTOCOL	225
54 FBA DATA IN	227
55 FBA DATA OUT	227
84 SEQUENCE PROG	228
98 OPTIONS	237
99 START-UP DATA	238

Fieldbus control with embedded fieldbus

What this chapter contains	243
System overview	243
Setting up communication through the embedded modbus	245
Drive control parameters	246
The fieldbus control interface	248
The Control Word and the Status Word	248
References	248
Actual Values	248
Fieldbus references	249

Reference selection and correction	249
Fieldbus reference scaling	253
Reference handling	254
Actual value scaling	254
Modbus mapping	255
Register mapping	255
Function codes	257
Exception codes	257
Communication profiles	258
ABB Drives communication profile	258
DCU communication profile	262

Fieldbus control with fieldbus adapter

What this chapter contains	267
System overview	267
Setting up communication through a fieldbus adapter module	268
Drive control parameters	269
The fieldbus control interface	270
Communication profile	271
Fieldbus references	272

Fault tracing

What this chapter contains	273
Safety	273
Alarm and fault indications	273
How to reset	273
Fault history	273
Alarm messages generated by the drive	274
Alarms generated by the Basic Control Panel	276
Fault messages generated by the drive	278
Embedded fieldbus faults	283
No master device	283
Same device address	283
Incorrect wiring	283

Maintenance and hardware diagnostics

What this chapter contains	285
Safety	285
Maintenance intervals	285
Fan	285
Fan replacement (R1...R4)	286
Capacitors	286
Reforming	286
Control panel	286
Cleaning	286
Battery	287

LEDs	287
------------	-----

Technical data

What this chapter contains	289
Ratings	290
Current and power	290
Symbols	291
Sizing	291
Derating	291
Cooling air flow requirements	292
Power cable sizes and fuses	293
Power cables: terminal sizes, maximum cable diameters and tightening torques	295
Dimensions, weights and noise	295
Symbols	295
Input power connection	296
Motor connection	296
Control connections	297
Brake resistor connection	297
Efficiency	297
Cooling	297
Degrees of protection	297
Ambient conditions	298
Materials	298
CE marking	299
Compliance with the EMC Directive	299
Compliance with EN 61800-3 (2004)	299
C-Tick marking	299
Compliance with IEC 61800-3 (2004)	299
RoHS marking	299
Applicable standards	299
UL marking	300
IEC/EN 61800-3 (2004) Definitions	300
Compliance with the IEC/EN 61800-3 (2004)	301
Product protection in the USA	301
Brake resistors	302
Brake resistor selection	302
Resistor installation and wiring	304
Mandatory circuit protection	304
Parameter set-up	304

Dimensions

Frame sizes R0 and R1, IP20 (cabinet installation) / UL open	306
Frame sizes R0 and R1, IP20 / NEMA 1	307
Frame size R2, IP20 (cabinet installation) / UL open	308
Frame size R2, IP20 / NEMA 1	309
Frame size R3, IP20 (cabinet installation) / UL open	310
Frame size R3, IP20 / NEMA 1	311
Frame size R4, IP20 (cabinet installation) / UL open	312

About the manual

What this chapter contains

The chapter describes the intended audience and compatibility of this manual. It also contains a flowchart of steps for checking the delivery and installing and commissioning the drive. The flowchart refers to chapters/sections in this manual.

Compatibility

The manual is compatible with the ACS350 drive firmware version 2.52b or later. See parameter [3301](#) FIRMWARE.

Intended audience

This manual is intended for persons who plan the installation, install, commission, use and service the drive. Read the manual before working on the drive. The reader is expected to know the fundamentals of electricity, wiring, electrical components and electrical schematic symbols.

This manual is written for readers worldwide. Both SI and imperial units are shown. Special US instructions for installations in the United States are given.

Categorization according to the frame size

The ACS350 is manufactured in frame sizes R0...R4. Some instructions, technical data and dimensional drawings which only concern certain frame sizes are marked with the symbol of the frame size (R0...R4). To identify the frame size of your drive, see the rating table on page [290](#) in chapter *Technical data*.

Product and service inquiries

Address any inquiries about the product to your local ABB representative, quoting the type code and serial number of the unit in question. A listing of ABB sales, support and service contacts can be found by navigating to www.abb.com/drives and selecting *Drives – Sales, Support and Service network*.

Product training

For information on ABB product training, navigate to www.abb.com/drives and select *Drives – Training courses*.

Providing feedback on ABB Drives manuals

Your comments on our manuals are welcome. Go to www.abb.com/drives, then select successively *Drives – Document Library – Manuals feedback form*.

Installation and commissioning flowchart

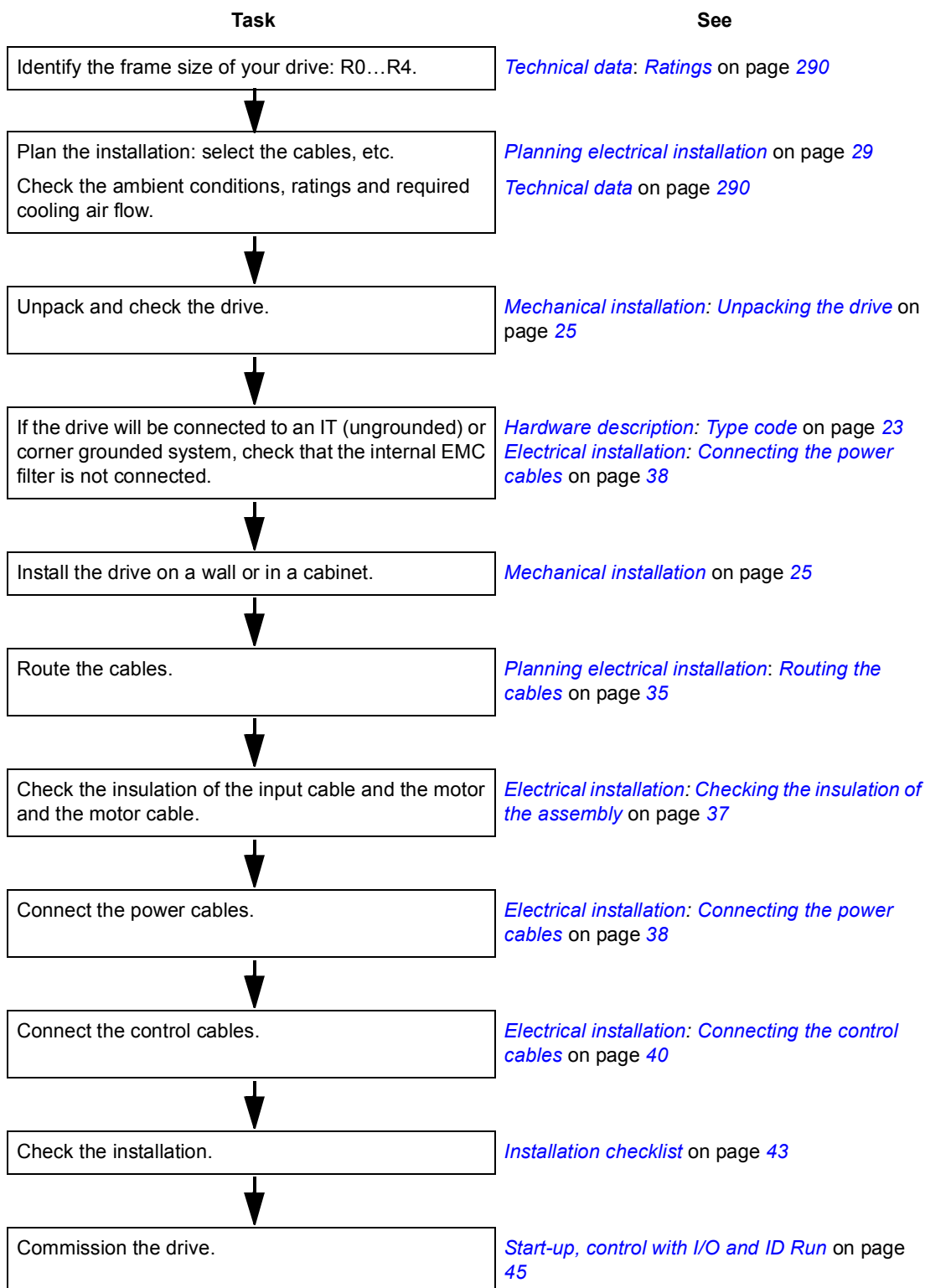

Hardware description

What this chapter contains

The chapter describes the construction and type code information in short.

Overview

The ACS350 is a wall or cabinet mountable drive for controlling AC motors. The construction of frame sizes R0...R4 varies to some extent.

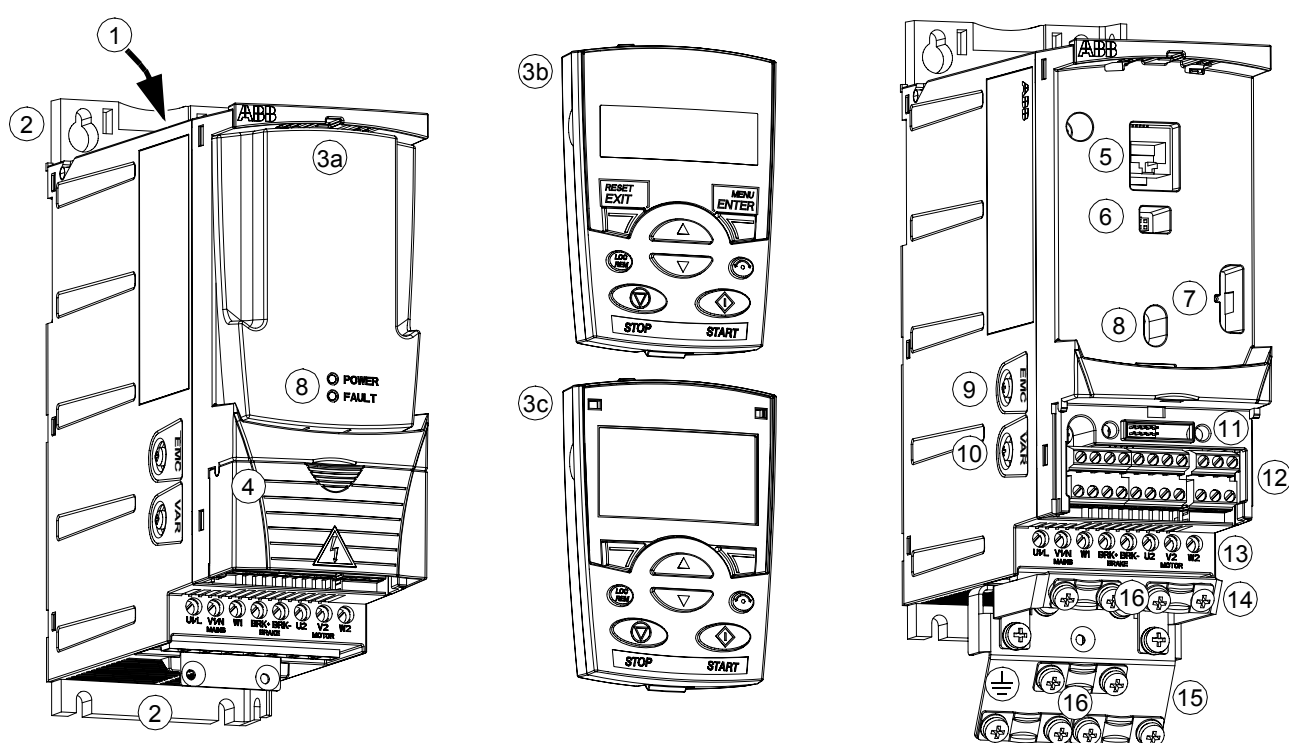

Covers on (R0 and R1)

Covers off (R0 and R1)

1	Cooling outlet through top cover
2	Mounting holes
3	Panel cover (a) / Basic Control Panel (b) / Assistant Control Panel (c)
4	Terminal cover (or optional potentiometer unit MPOT-01)
5	Panel connection
6	Option connection
7	FlashDrop connection
8	Power OK and Fault LEDs (see LEDs on page 287)

9	EMC filter grounding screw (EMC). Note: Screw is on front for frame size R4.
10	Varistor grounding screw (VAR)
11	Fieldbus adapter (serial communication module) connection
12	I/O connections
13	Input power connection (U1, V1, W1), brake resistor connection (BRK+, BRK-) and motor connection (U2, V2, W2)
14	I/O clamping plate
15	Clamping plate
16	Clamps

Overview: Connections

The diagram gives an overview of connections. I/O connections are parameterable. The diagram shows the default I/O connections for the ABB standard macro. See chapter [Application macros](#) for I/O connections for the different macros and chapter [Electrical installation](#) for installation in general.

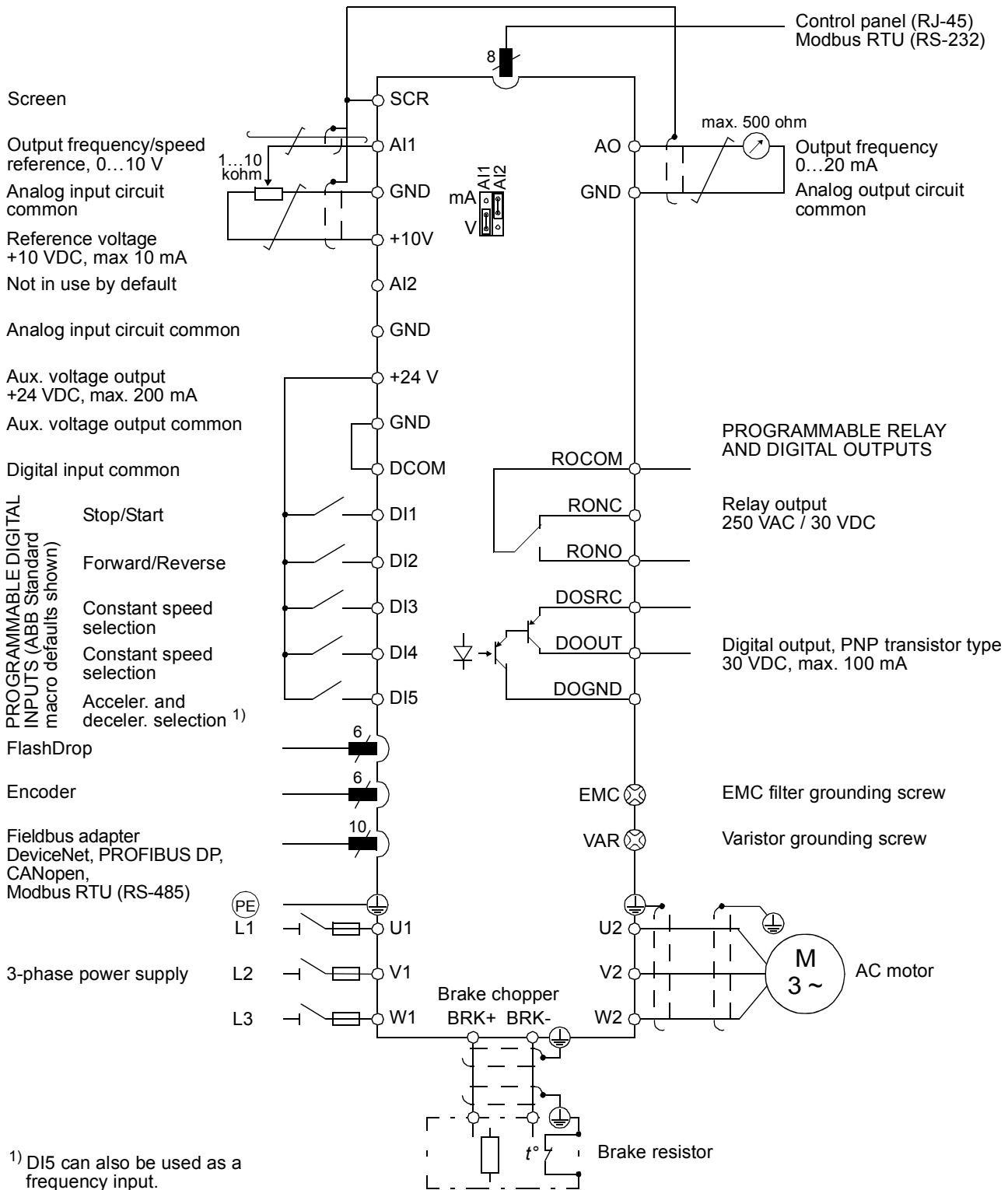

Type code

The type code contains information on the specifications and configuration of the drive. You find the type code on the type designation label attached to the drive. The first digits from the left express the basic configuration, for example ACS350-03E-08A8-4. The optional selections are given after that, separated by + signs, for example +J404. The explanations of the type code selections are described below.

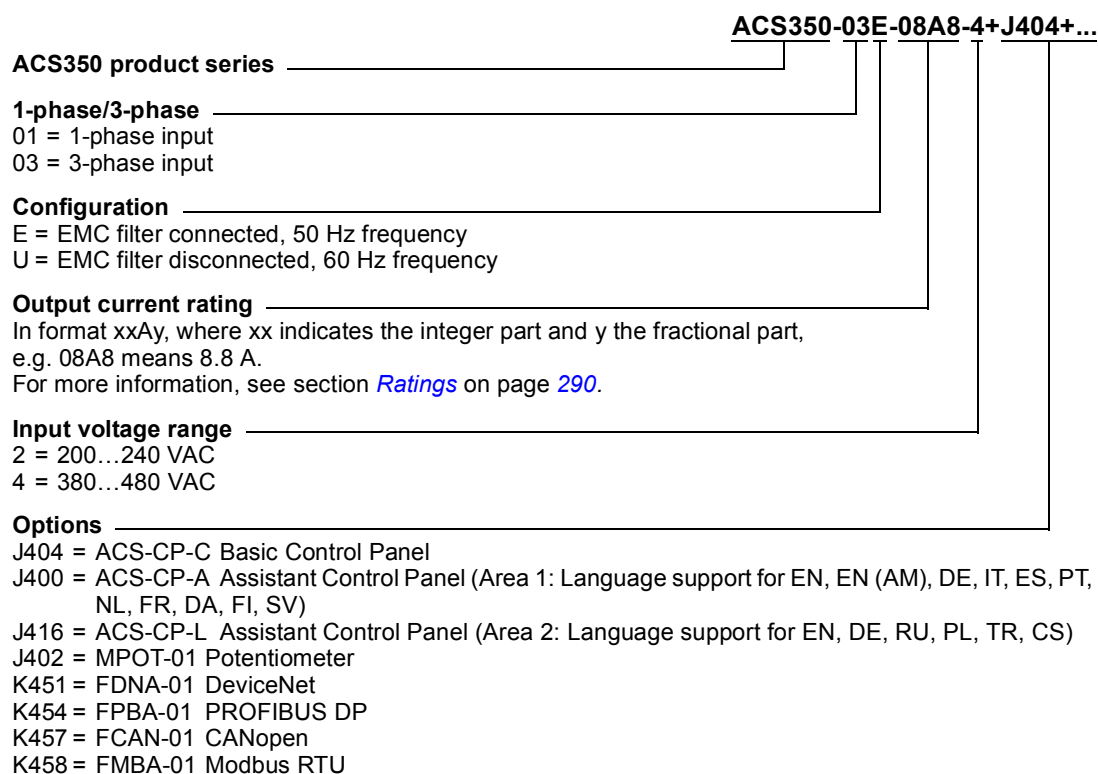

Mechanical installation

What this chapter contains

The chapter describes the mechanical installation procedure of the drive.

Unpacking the drive

The drive (1) is delivered in a package that also contains the following items (frame size R1 shown in the figure):

- plastic bag (2) including clamping plate (also used for I/O cables in frame size R3 and R4), I/O clamping plate (for frame sizes R0...R2), fieldbus option ground plate, clamps and screws
- panel cover (3)
- mounting template, integrated into the package (4)
- user's manual (5)
- possible options (fieldbus, potentiometer, encoder, all with instructions, Basic Control Panel or Assistant Control Panel).

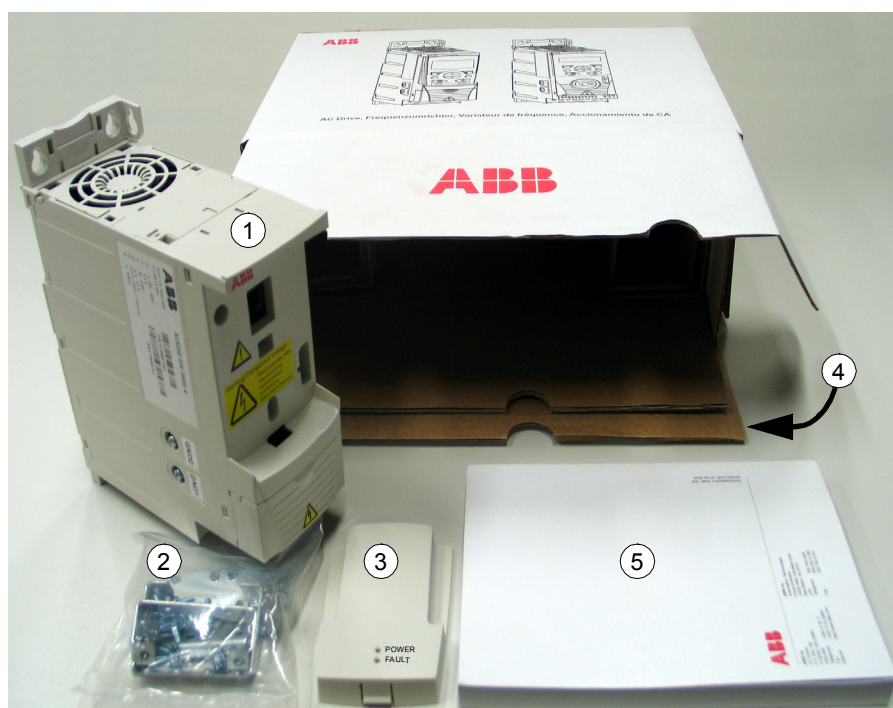

Delivery check

Check that there are no signs of damage. Notify the shipper immediately if damaged components are found.

Before attempting installation and operation, check the information on the type designation label of the drive to verify that the drive is of the correct type. The type designation label is attached to the left side of the drive. An example label and explanation of the label contents are shown below.

° ° ° °		ACS350-03E-08A8-4 ①	
IP20 / UL Open type ②		S/N YWWRXXXX	④
4 kW (5 HP)		68468167	⑤
U1 3~380...480 V			
I1 ③ 13.6 A			
f1 48...63 Hz			
U2 3~0...U1 V			
I2 8.8 A (150% 1/10 min)			
f2 0...500 Hz			
		CE C-Tick C-UL US RoHS ⑥	

Type designation label

1	Type code, see section Type code on page 23
2	Degree of protection (IP and UL/NEMA)
3	Nominal ratings, see section Ratings on page 290.
4	Serial number of format YWWRXXXXWS, where Y: 5...9, A, ... for 2005...2009, 2010, ... WW: 01, 02, 03, ... for week 1, week 2, week 3, ... R: A, B, C, ... for product revision number XXXX: Integer starting every week from 0001
5	ABB MRP code of the drive
6	CE marking and C-Tick, C-UL US and RoHS marks (the label of your drive shows the valid markings)

Before installation

The ACS350 may be installed on the wall or in a cabinet. Check the enclosure requirements for the need to use the NEMA 1 option in wall installations (see chapter [Technical data](#)).

The drive can be mounted in three different ways, depending on the frame size:

- back mounting (all frame sizes)
- side mounting (frame sizes R0...R2)
- DIN rail mounting (all frame sizes).

The drive must be installed in an upright position. Check the installation site according to the requirements below. Refer to chapter [Dimensions](#) for frame details.

Requirements for the installation site

See chapter [Technical data](#) for the allowed operation conditions of the drive.

Wall

The wall should be as close to vertical and even as possible, of non-flammable material and strong enough to carry the weight of the drive.

Floor

The floor/material below the installation should be non-flammable.

Free space around the drive

The required free space for cooling above and below the drive is 75 mm (3 in.). No free space is required on the sides of the drive, so they can be mounted side by side.

Mounting the drive

Mount the drive

Note: Make sure that dust from drilling does not enter the drive during the installation.

With screws

1. Mark the locations for the holes using e.g. the mounting template cut out from the package. The locations of the holes are also shown in the drawings in chapter [Dimensions](#). The number and location of the holes used depend on how the drive is mounted:
 - a) back mounting (frame sizes R0...R4): four holes
 - b) side mounting (frame sizes R0...R2): three holes; one of the bottom holes is located in the clamping plate.
2. Fix the screws or bolts to the marked locations.
3. Position the drive onto the screws on the wall.
4. Tighten the screws in the wall securely.

On DIN rail

1. Click the drive to the rail as shown in Figure a below. To detach the drive, press the release lever on top of the drive as shown in Figure b.

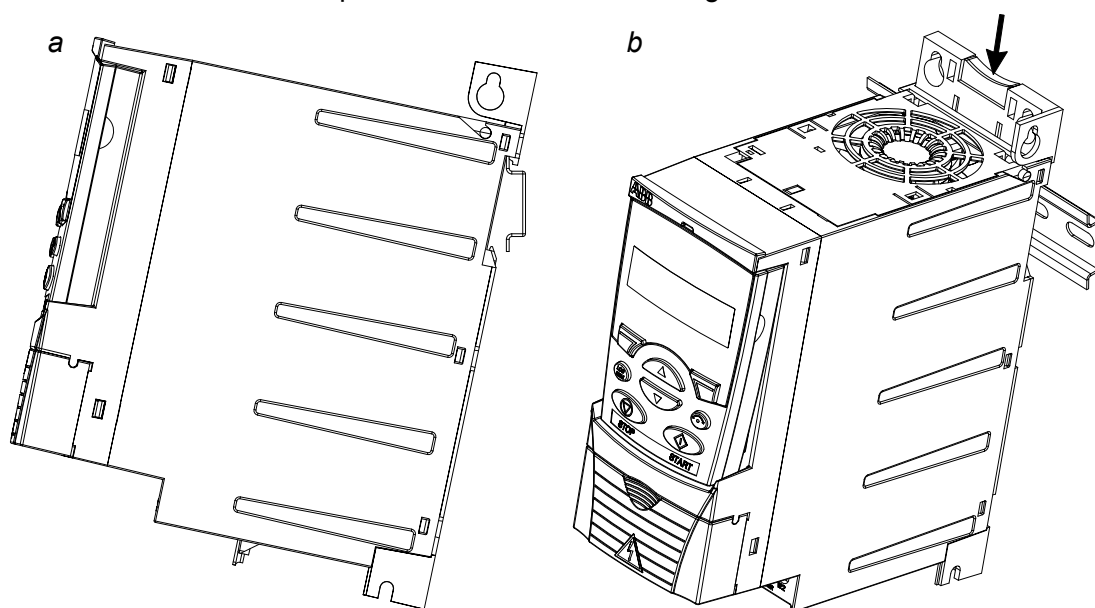

Fasten clamping plates

See Figure a below.

1. Fasten the clamping plate to the plate at the bottom of the drive with the provided screws.
2. Fasten the I/O clamping plate to the clamping plate (frame sizes R0...R2) with the provided screws.

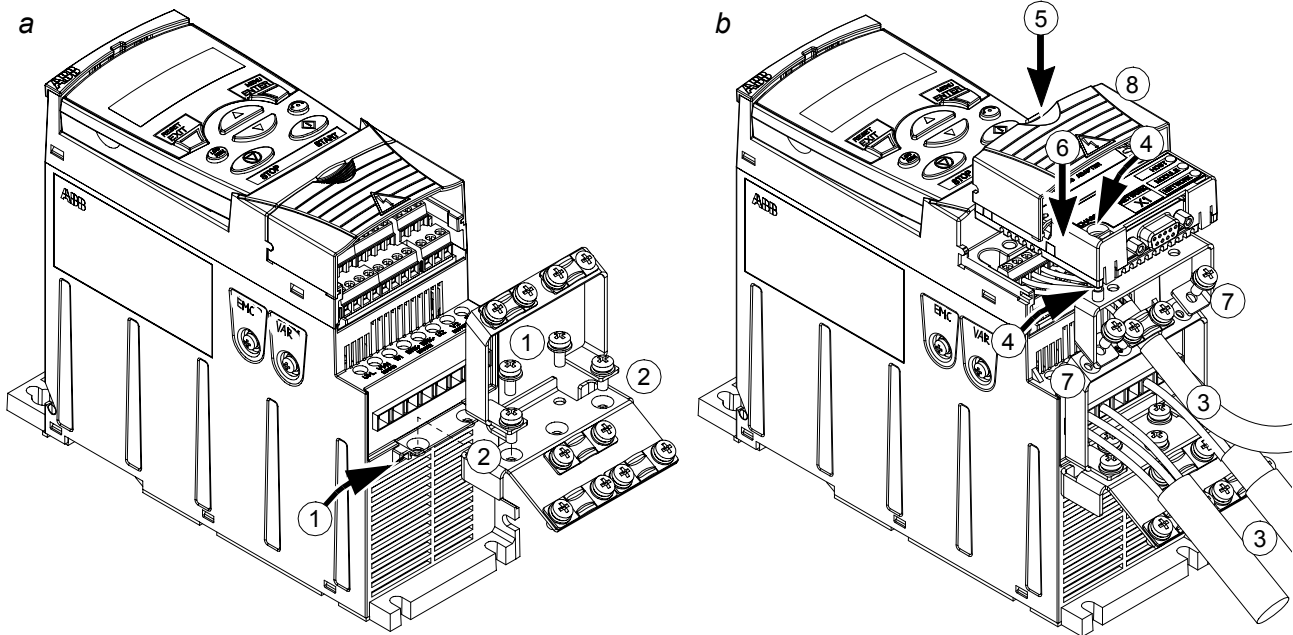

Attach the optional fieldbus module

See Figure b above.

3. Connect the power and control cables as instructed in chapter [Electrical installation](#).
4. Place the fieldbus module on the option ground plate and tighten the grounding screw on the left corner of the fieldbus module. This fastens the module to the option ground plate.
5. If the terminal cover is not already removed, push the recess in the cover and simultaneously slide the cover off the frame.
6. Snap the fieldbus module attached to the option ground plate in position so that the module is plugged to the connection on the drive front and the screw holes in the option ground plate and the I/O clamping plate are aligned.
7. Fasten the option ground plate to the I/O clamping plate with the provided screws.
8. Slide the terminal cover back in place.

Planning electrical installation

What this chapter contains

The chapter contains the instructions that you must follow when selecting the motor, cables, protections, cable routing and way of operation for the drive. If the recommendations given by ABB are not followed, the drive may experience problems that the warranty does not cover.

Note: The installation must always be designed and made according to applicable local laws and regulations. ABB does not assume any liability whatsoever for any installation which breaches the local laws and/or other regulations.

Motor selection

Select the 3-phase AC induction motor according to the rating table on page 290 in chapter *Technical data*. The table lists the typical motor power for each drive type.

AC power line connection

Use a fixed connection to the AC power line.



WARNING! As the leakage current of the device typically exceeds 3.5 mA, a fixed installation is required according to IEC 61800-5-1.

Supply disconnecting device

Install a hand-operated input disconnecting device (disconnecting means) between the AC power source and the drive. The disconnecting device must be of a type that can be locked to the open position for installation and maintenance work.

- **Europe:** To meet the European Union Directives, according to standard EN 60204-1, Safety of Machinery, the disconnecting device must be one of the following types:
 - a switch-disconnector of utilization category AC-23B (EN 60947-3)
 - a disconnector having an auxiliary contact that in all cases causes switching devices to break the load circuit before the opening of the main contacts of the disconnector (EN 60947-3)
 - a circuit breaker suitable for isolation in accordance with EN 60947-2.
- **Other regions:** The disconnecting device must conform to the applicable safety regulations.

Thermal overload and short-circuit protection

The drive protects itself and the input and motor cables against thermal overload when the cables are dimensioned according to the nominal current of the drive. No additional thermal protection devices are needed.



WARNING! If the drive is connected to multiple motors, a separate thermal overload switch or a circuit breaker must be used for protecting each cable and motor. These devices may require a separate fuse to cut off the short-circuit current.

Protection against short-circuit inside the drive or in the supply cable

Arrange the protection according to the following guidelines.

Circuit diagram		Short-circuit protection	
Distribution board	Input cable	Drive	Protect the drive and input cable with fuses or a circuit breaker. See footnotes 1) and 2).

1) Size the fuses according to instructions given in chapter [Technical data](#). The fuses will protect the input cable in short-circuit situations, restrict drive damage and prevent damage to adjoining equipment in case of a short-circuit inside the drive.

2) Circuit breakers which have been tested by ABB with the ACS350 can be used. Fuses must be used with other circuit breakers. Contact your local ABB representative for the approved breaker types and supply network characteristics.



WARNING! Due to the inherent operating principle and construction of circuit breakers, independent of the manufacturer, hot ionized gases may escape from the breaker enclosure in case of a short-circuit. To ensure safe use, special attention must be paid to the installation and placement of the breakers. Follow the manufacturer's instructions.

Protection against short-circuit in the motor and motor cable

The drive protects the motor and motor cable in a short-circuit situation when the motor cable is dimensioned according to the nominal current of the drive. No additional protection devices are needed.

Thermal overload protection of the motor

According to regulations, the motor must be protected against thermal overload and the current must be switched off when overload is detected. The drive includes a motor thermal protection function that protects the motor and switches off the current when necessary. It is also possible to connect a motor temperature measurement to the drive. The user can tune both the thermal model and the temperature measurement function further by parameters.

The most common temperature sensors are:

- motor sizes IEC180...225: thermal switch (e.g. Klixon)
- motor sizes IEC200...250 and larger: PTC or Pt100.

For more information on the thermal model, see section [Motor Thermal Protection](#) on page 116. For more information on the temperature measurement function see section [Motor temperature measurement through the standard I/O](#) on page 124.

Selecting the power cables

General rules

Dimension the input power and motor cables **according to local regulations**.

- The cable must be able to carry the drive load current. See chapter [Technical data](#) for the rated currents.
- The cable must be rated for at least 70°C maximum permissible temperature of the conductor in continuous use. For US, see section [Additional US requirements](#) on page 33.
- The conductivity of the PE conductor must be equal to that of the phase conductor (same cross-sectional area).
- 600 VAC cable is accepted for up to 500 VAC.
- Refer to chapter [Technical data](#) for the EMC requirements.

A symmetrical shielded motor cable (see the figure below) must be used to meet the EMC requirements of the CE and C-tick marks.

A four-conductor system is allowed for input cabling, but a shielded symmetrical cable is recommended.

Compared to a four-conductor system, the use of a symmetrical shielded cable reduces electromagnetic emission of the whole drive system as well as motor bearing currents and wear.

Alternative power cable types

Power cable types that can be used with the drive are presented below.

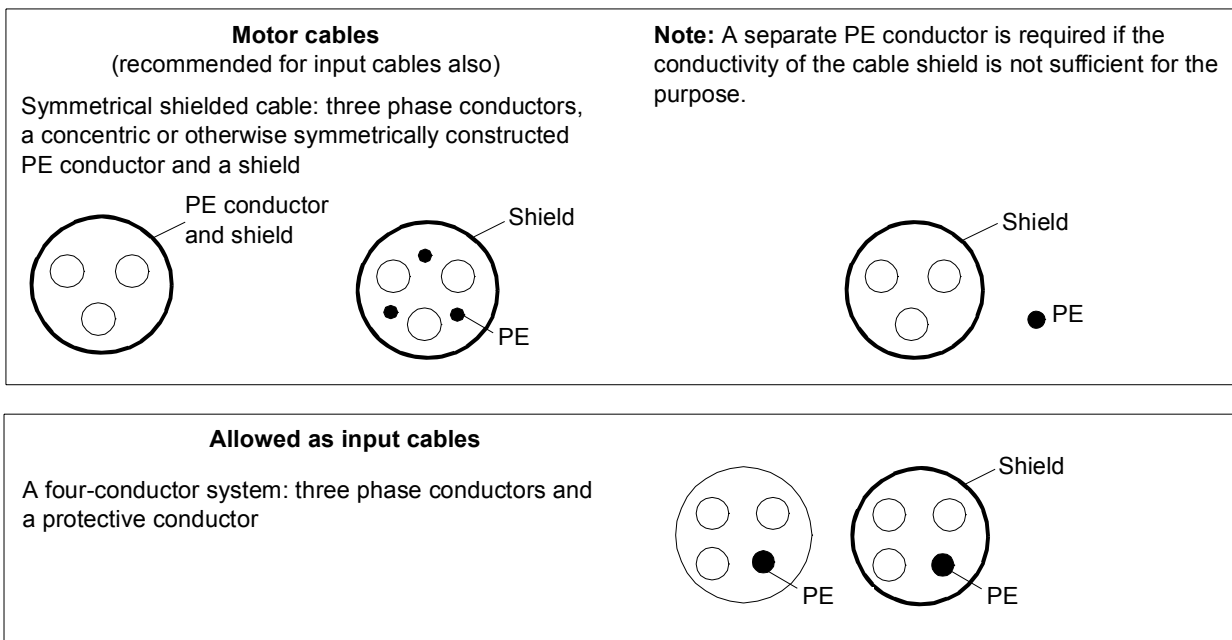

Motor cable shield

To function as a protective conductor, the shield must have the same cross-sectional area as the phase conductors when they are made of the same metal.

To effectively suppress radiated and conducted radio-frequency emissions, the shield conductivity must be at least 1/10 of the phase conductor conductivity. The requirements are easily met with a copper or aluminium shield. The minimum requirement of the motor cable shield of the drive is shown below. It consists of a concentric layer of copper wires. The better and tighter the shield, the lower the emission level and bearing currents.

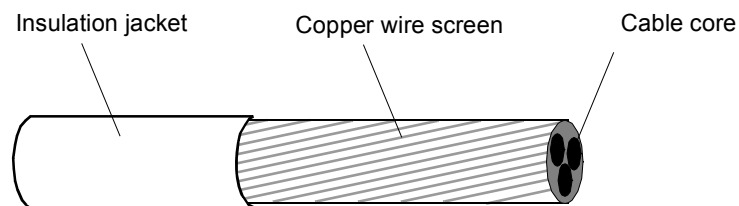

Additional US requirements

Type MC continuous corrugated aluminium armor cable with symmetrical grounds or shielded power cable is recommended for the motor cables if metallic conduit is not used.

The power cables must be rated for 75°C (167°F).

Conduit

Where conduits must be coupled together, bridge the joint with a ground conductor bonded to the conduit on each side of the joint. Bond the conduits also to the drive enclosure. Use separate conduits for input power, motor, brake resistors and control wiring. Do not run motor wiring from more than one drive in the same conduit.

Armored cable / shielded power cable

Six-conductor (three phases and three ground) type MC continuous corrugated aluminium armor cable with symmetrical grounds is available from the following suppliers (trade names in parentheses):

- Anixter Wire & Cable (Philsheath)
- BICC General Corp (Philsheath)
- Rockbestos Co. (Gardex)
- Oaknite (CLX).

Shielded power cables are available from Belden, LAPPKABEL (ÖLFLEX) and Pirelli.

Protecting the relay output contact and attenuating disturbances in case of inductive loads

Inductive loads (relays, contactors, motors) cause voltage transients when switched off.

Equip inductive loads with noise attenuating circuits [varistors, RC filters (AC) or diodes (DC)] in order to minimize the EMC emission at switch-off. If not suppressed, the disturbances may connect capacitively or inductively to other conductors in the control cable and form a risk of malfunction in other parts of the system.

Install the protective component as close to the inductive load as possible. Do not install protective components at the I/O terminal block.

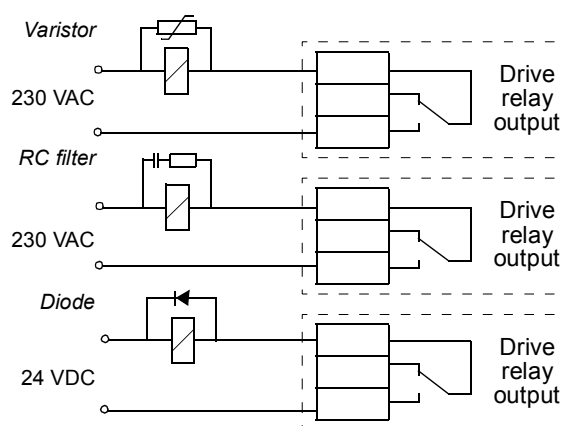

Residual current device (RCD) compatibility

ACS350-01x drives are suitable to be used with residual current devices of Type A, ACS350-03x drives with residual current devices of Type B. For ACS350-03x drives, other measures for protection in case of direct or indirect contact, such as separation from the environment by double or reinforced insulation or isolation from the supply system by a transformer, can also be applied.

Selecting the control cables

All analog control cables and the cable used for the frequency input must be shielded.

Use a double-shielded twisted pair cable (Figure a, e.g. JAMAK by NK Cables) for analog signals. Employ one individually shielded pair for each signal. Do not use common return for different analog signals.

A double-shielded cable is the best alternative for low-voltage digital signals, but a single-shielded or unshielded twisted multipair cable (Figure b) is also usable. However, for frequency input, always use a shielded cable.

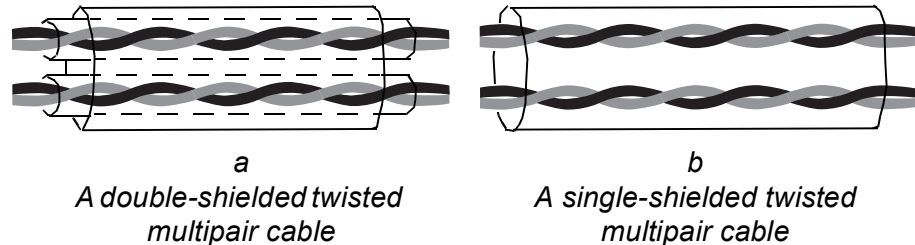

Run analog and digital signals in separate cables.

Relay-controlled signals, providing their voltage does not exceed 48 V, can be run in the same cables as digital input signals. It is recommended that the relay-controlled signals are run as twisted pairs.

Never mix 24 VDC and 115/230 VAC signals in the same cable.

Relay cable

The cable type with braided metallic screen (e.g. ÖLFLEX by LAPPKABEL) has been tested and approved by ABB.

Control panel cable

In remote use, the cable connecting the control panel to the drive must not exceed 3 m (10 ft). The cable type tested and approved by ABB is used in control panel option kits.

Connection of a motor temperature sensor to the drive I/O

Please refer to section [Motor temperature measurement through the standard I/O](#) on page 124 for information on connecting a motor temperature sensor to the drive I/O.

Routing the cables

Route the motor cable away from other cable routes. Motor cables of several drives can be run in parallel installed next to each other. It is recommended that the motor cable, input power cable and control cables be installed on separate trays. Avoid long parallel runs of motor cables with other cables to decrease electromagnetic interference caused by the rapid changes in the drive output voltage.

Where control cables must cross power cables make sure that they are arranged at an angle as near to 90 degrees as possible.

The cable trays must have good electrical bonding to each other and to the grounding electrodes. Aluminium tray systems can be used to improve local equalizing of potential.

A diagram of the cable routing is shown below.

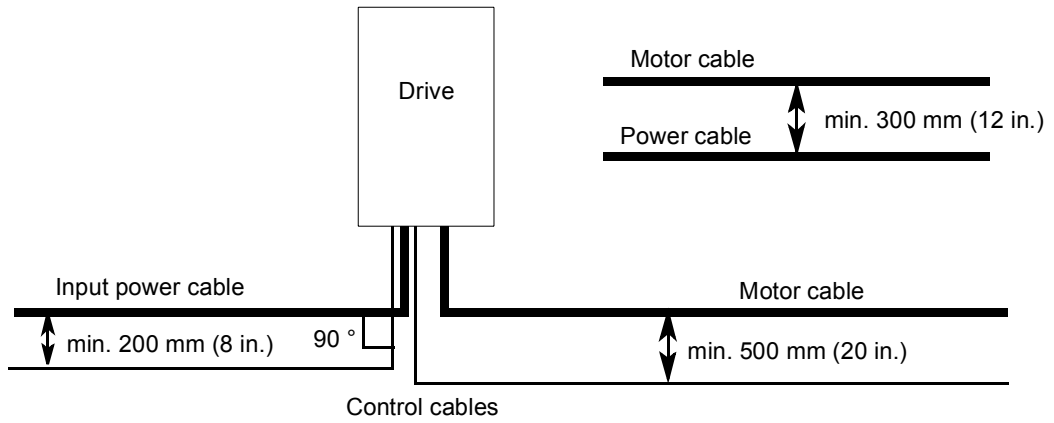

Control cable ducts

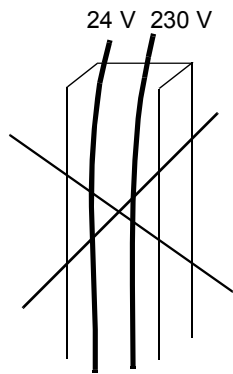

Not allowed unless the 24 V cable is insulated for 230 V or insulated with an insulation sleeving for 230 V.

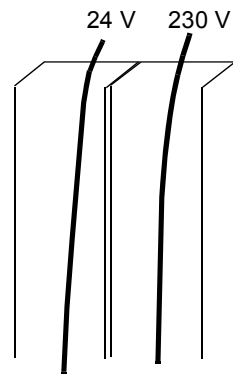

Lead 24 V and 230 V control cables in separate ducts inside the cabinet.

Electrical installation

What this chapter contains

The chapter describes the electrical installation procedure of the drive.



WARNING! The work described in this chapter may only be carried out by a qualified electrician. Follow the instructions in chapter [Safety](#) on page 5. Ignoring the safety instructions can cause injury or death.

Make sure that the drive is disconnected from the input power during installation. If the drive is already connected to the input power, wait for 5 minutes after disconnecting the input power.

Checking the insulation of the assembly

Drive

Do not make any voltage tolerance or insulation resistance tests (e.g. hi-pot or megger) on any part of the drive as testing can damage the drive. Every drive has been tested for insulation between the main circuit and the chassis at the factory. Also, there are voltage-limiting circuits inside the drive which cut down the testing voltage automatically.

Input cable

Check the insulation of the input cable according to local regulations before connecting to the drive.

Motor and motor cable

Check the insulation of the motor and motor cable as follows:

1. Check that the motor cable is connected to the motor and disconnected from the drive output terminals U2, V2 and W2.
2. Measure the insulation resistances of the motor cable and the motor between each phase and the Protective Earth by using a measuring voltage of 1 kV DC. The insulation resistance must be higher than 1 Mohm.

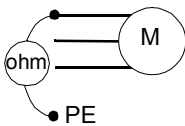

Connecting the power cables

Connection diagram

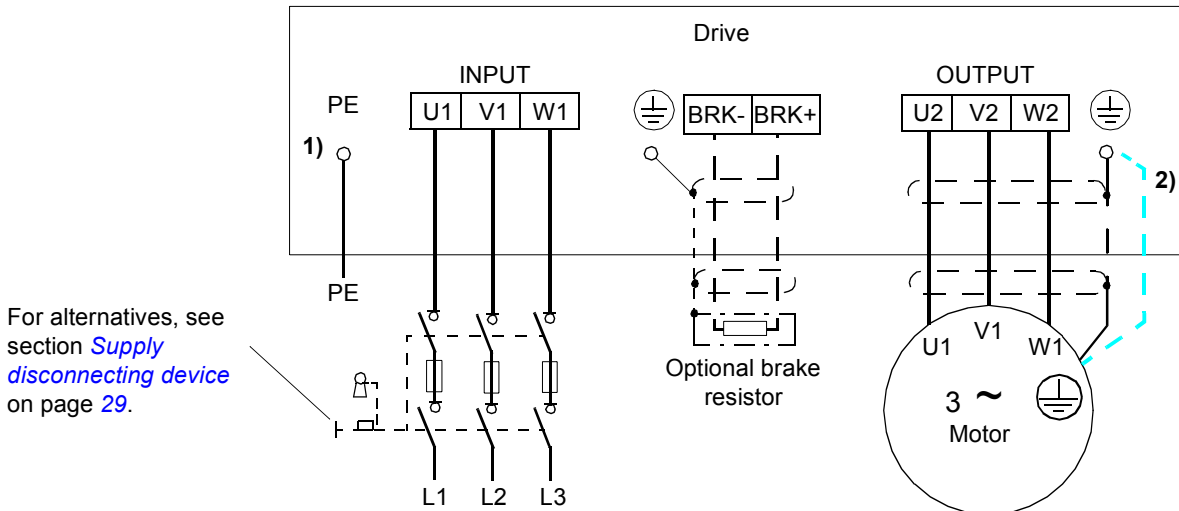

- 1) Ground the other end of the PE conductor at the distribution board.
- 2) Use a separate grounding cable if the conductivity of the cable shield is insufficient (smaller than the conductivity of the phase conductor) and there is no symmetrically constructed grounding conductor in the cable (see section [Selecting the power cables](#) on page 32).

Note:

Do not use an asymmetrically constructed motor cable.

If there is a symmetrically constructed grounding conductor in the motor cable in addition to the conductive shield, connect the grounding conductor to the grounding terminal at the drive and motor ends.

Grounding of the motor cable shield at the motor end

For minimum radio frequency interference:

- ground the cable by twisting the shield as follows: flattened width $\geq 1/5 \cdot \text{length}$
- or ground the cable shield 360 degrees at the lead-through of the motor terminal box.

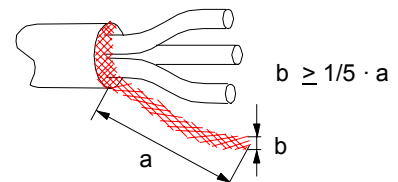

Procedure

1. On IT (ungrounded) systems and corner grounded TN systems, disconnect the internal EMC filter by removing the EMC screw. For 3-phase U-type drives (with type code ACS350-03U-), the EMC screw is already removed at the factory and replaced by a plastic one.



WARNING! If a drive whose EMC filter is not disconnected is installed on an IT system [an ungrounded power system or a high resistance-grounded (over 30 ohms) power system], the system will be connected to earth potential through the EMC filter capacitors of the drive. This may cause danger or damage the drive.

If a drive whose EMC filter is not disconnected is installed on a corner grounded TN system, the drive will be damaged.

2. Fasten the grounding conductor (PE) of the input power cable under the grounding clamp. Connect the phase conductors to the U1, V1 and W1 terminals. Use a tightening torque of 0.8 N·m (7 lbf in.) for frame sizes R0...R2, 1.7 N·m (15 lbf in.) for R3, and 2.5 N·m (22 lbf in.) for R4.
3. Strip the motor cable and twist the shield to form as short a pigtail as possible. Fasten the twisted shield under the grounding clamp. Connect the phase conductors to the U2, V2 and W2 terminals. Use a tightening torque of 0.8 N·m (7 lbf in.) for frame sizes R0...R2, 1.7 N·m (15 lbf in.) for R3, and 2.5 N·m (22 lbf in.) for R4.
4. Connect the optional brake resistor to the BRK+ and BRK- terminals with a shielded cable using the same procedure as for the motor cable in step 3.
5. Secure the cables outside the drive mechanically.

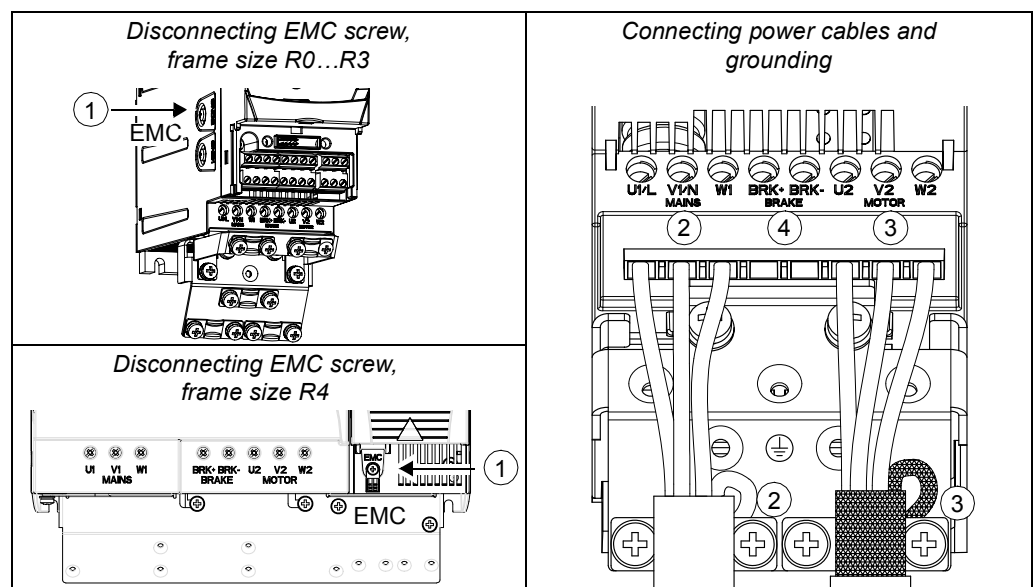

Connecting the control cables

I/O terminals

The figure below shows the I/O connectors. Tightening torque is 0.5 N·m / 4.4 lbf. in.

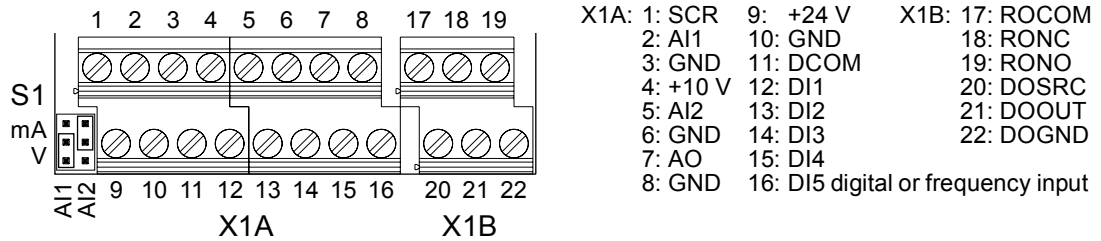

Default connection

The default connection of the control signals depends on the application macro in use, which is selected with parameter [9902](#). See chapter [Application macros](#) for the connection diagrams.

Voltage and current selection

Switch S1 selects voltage (0 (2)...10 V / -10...10 V) or current (0 (4)...20 mA / -20...20 mA) as the signal types for analog inputs AI1 and AI2. The factory settings are unipolar voltage for AI1 (0 (2)...10 V) and unipolar current for AI2 (0 (4)...20 mA), which correspond to the default usage in the application macros.

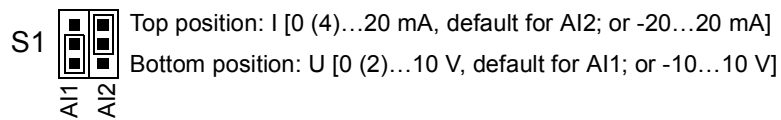

Voltage and current connection

Bipolar voltage (-10...10 V) and current (-20...20 mA) are also possible. If a bipolar connection is used instead of a unipolar one, see section [Programmable analog inputs](#) on page [102](#) for how to set parameters accordingly.

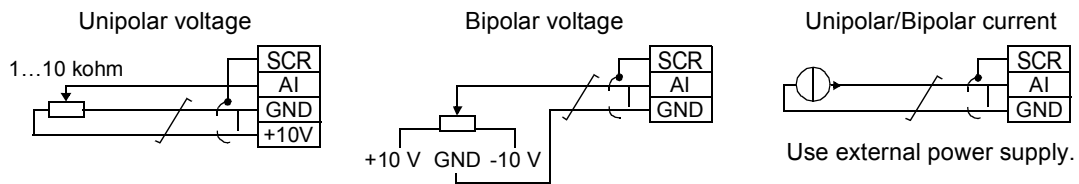

Frequency input

If DI5 is used as a frequency input, see section [Frequency input](#) on page [105](#) for how to set parameters accordingly.

Connection example of a two-wire sensor

Hand/Auto, PID Control and Torque Control macros (see pages 91, 92, 93, respectively) use analog input 2 (AI2). The macro wiring diagrams for these macros show the connection when a separately powered sensor is used. The figure below gives an example of a connection using a two-wire sensor.

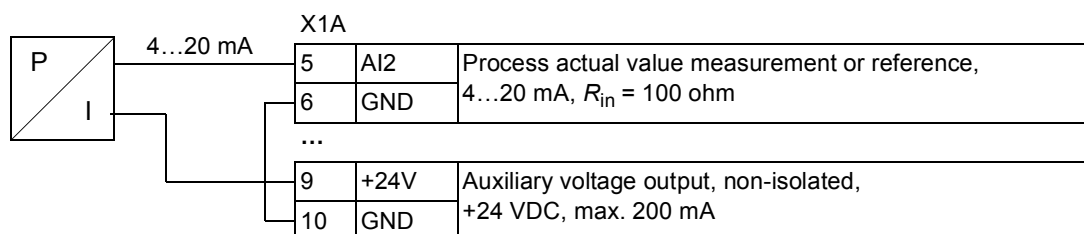

Note: The sensor is supplied through its current output. Thus the output signal must be 4...20 mA.



WARNING! All ELV (extra low voltage) circuits connected to the drive must be used within a zone of equipotential bonding, i.e. within a zone where all simultaneously accessible conductive parts are electrically connected to prevent hazardous voltages appearing between them. This is accomplished by a proper factory grounding.

Procedure

1. Remove the terminal cover by simultaneously pushing the recess and sliding the cover off the frame.
2. *Analog signals:* Strip the outer insulation of the analog signal cable 360 degrees and ground the bare shield under the clamp.
3. Connect the conductors to the appropriate terminals.
4. Twist the grounding conductors of each pair in the analog signal cable together and connect the bundle to the SCR terminal.
5. *Digital signals:* Connect the conductors of the cable to the appropriate terminals.
6. Twist the grounding conductors and shields (if any) of the digital signal cables to a bundle and connect to the SCR terminal.
7. Secure all cables outside the drive mechanically.
8. Unless you need to install the optional fieldbus module (see page 28), slide the terminal cover back in place.

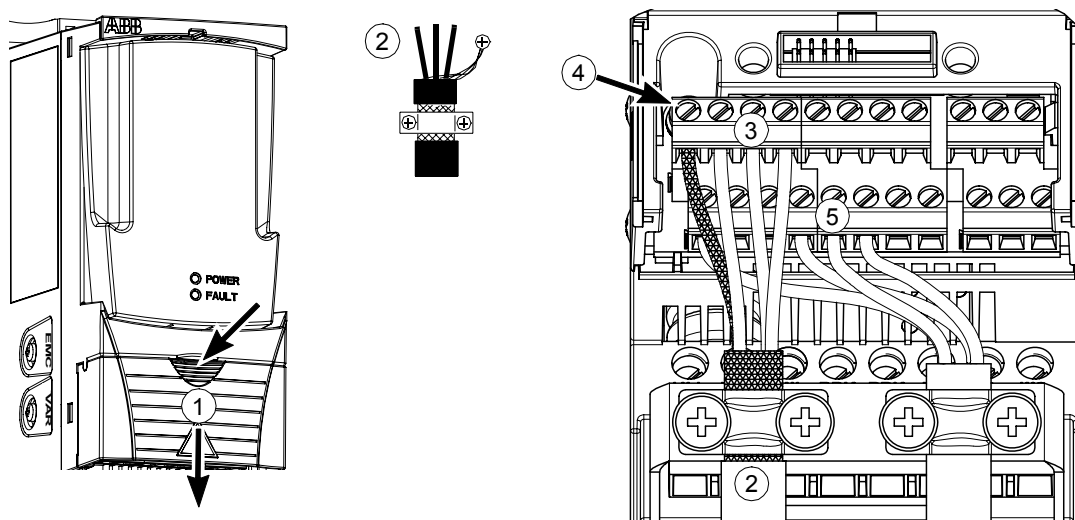

Installation checklist

Checklist

Check the mechanical and electrical installation of the drive before start-up. Go through the checklist below together with another person. Read chapter [Safety](#) on the first pages of this manual before you work on the drive.

Check
MECHANICAL INSTALLATION
<input type="checkbox"/> The ambient operating conditions are allowed. (See Mechanical installation: Requirements for the installation site on page 26, Technical data: Cooling air flow requirements on page 292 and Ambient conditions on page 298.)
<input type="checkbox"/> The drive is fixed properly on an even vertical non-flammable wall. (See Mechanical installation .)
<input type="checkbox"/> The cooling air will flow freely. (See Mechanical installation: Free space around the drive on page 26.)
<input type="checkbox"/> The motor and the driven equipment are ready for start. (See Planning electrical installation: Motor selection on page 29 and Technical data: Motor connection on page 296.)
ELECTRICAL INSTALLATION (See Planning electrical installation and Electrical installation .)
<input type="checkbox"/> For ungrounded and corner grounded systems: The internal EMC filter is disconnected (EMC screw removed).
<input type="checkbox"/> The capacitors are reformed if the drive has been stored over two years.
<input type="checkbox"/> The drive is grounded properly.
<input type="checkbox"/> The input power voltage matches the drive nominal input voltage.
<input type="checkbox"/> The input power connections at U1, V1 and W1 are OK and tightened with the correct torque.
<input type="checkbox"/> Appropriate input power fuses and disconnectors are installed.
<input type="checkbox"/> The motor connections at U2, V2 and W2 are OK and tightened with the correct torque.
<input type="checkbox"/> The motor cable is routed away from other cables.
<input type="checkbox"/> The external control (I/O) connections are OK.
<input type="checkbox"/> The input power voltage cannot be applied to the output of the drive (with a bypass connection).
<input type="checkbox"/> Terminal cover and, for NEMA 1, hood and connection box, are in place.

Start-up, control with I/O and ID Run

What this chapter contains

The chapter instructs how to:

- perform the start-up
- start, stop, change the direction of rotation and adjust the speed of the motor through the I/O interface
- perform an Identification Run for the drive.

Using the control panel to do these tasks is explained briefly in this chapter. For details on how to use the control panel, refer to chapter [Control panels](#) starting on page 57.

How to start up the drive

How you start up the drive depends on the control panel you have, if any.

- **If you have no control panel**, follow the instructions given in section [How to start up the drive without a control panel](#) on page 45.
- **If you have a Basic Control Panel**, follow the instructions given in section [How to perform the limited start-up](#) on page 46.
- **If you have an Assistant Control Panel**, you can either run the Start-up Assistant (see section [How to perform the guided start-up](#) on page 51) or perform a limited start-up (see section [How to perform the limited start-up](#) on page 46).

The Start-up Assistant, which is included in the Assistant Control Panel only, guides you through all essential settings to be done. In the limited start-up, the drive gives no guidance; you go through the very basic settings by following the instructions given in the manual.

How to start up the drive without a control panel

SAFETY



The start-up may only be carried out by a qualified electrician.

The safety instructions given in chapter [Safety](#) must be followed during the start-up procedure.

The drive will start up automatically at power up if the external run command is on.



- Check the installation. See the checklist in chapter [Installation checklist](#).
- Check that the starting of the motor does not cause any danger.
De-couple the driven machine if there is a risk of damage in case of incorrect direction of rotation.

POWER-UP	
<input type="checkbox"/>	Apply input power and wait for a moment.
<input type="checkbox"/>	Check that the red LED is not lit and the green LED is lit but not blinking.
The drive is now ready for use.	















How to perform the limited start-up

For the limited start-up, you can use the Basic Control Panel or the Assistant Control Panel. The instructions below are valid for both control panels, but the displays shown are the Basic Control Panel displays, unless the instruction applies to the Assistant Control Panel only.

Before you start, ensure that you have the motor nameplate data on hand.

SAFETY																						
	<p>The start-up may only be carried out by a qualified electrician.</p> <p>The safety instructions given in chapter Safety must be followed during the start-up procedure.</p>																					
	<p>The drive will start up automatically at power up if the external run command is on.</p>																					
<input type="checkbox"/>	<p>Check the installation. See the checklist in chapter Installation checklist.</p>																					
<input type="checkbox"/>	<p>Check that the starting of the motor does not cause any danger.</p> <p>De-couple the driven machine if:</p> <ul style="list-style-type: none"> • there is a risk of damage in case of incorrect direction of rotation, or • an ID Run needs to be performed during the drive start-up. ID Run is essential only in applications that require the ultimate in motor control accuracy. 																					
POWER-UP																						
<input type="checkbox"/>	<p>Apply input power.</p> <p>The Basic Control Panel powers up into the Output mode.</p> <p>The Assistant Control Panel asks if you want to run the Start-up Assistant. If you press , the Start-up Assistant is not run, and you can continue with manual start-up in a similar manner as described below for the Basic Control Panel.</p>																					
<table border="1" style="width: 100%; border-collapse: collapse;"> <tr> <td style="width: 15%; padding: 2px;">REM</td> <td style="text-align: center; font-size: 2em; padding: 2px;">0.0</td> <td style="width: 10%; padding: 2px;">Hz</td> </tr> <tr> <td style="padding: 2px;">OUTPUT</td> <td colspan="2" style="text-align: center; padding: 2px;">FWD</td> </tr> <tr> <td colspan="3" style="padding: 2px;"> <table border="1" style="width: 100%; border-collapse: collapse;"> <tr> <td style="width: 10%; padding: 2px;">REM</td> <td style="width: 10%; padding: 2px;">CHOICE</td> <td style="width: 80%; padding: 2px;">Do you want to use the start-up assistant?</td> </tr> <tr> <td style="text-align: center; padding: 2px;">Yes</td> <td colspan="2"></td> </tr> <tr> <td style="text-align: center; padding: 2px;">NO</td> <td colspan="2"></td> </tr> <tr> <td style="padding: 2px;">EXIT</td> <td style="padding: 2px;">00:00</td> <td style="padding: 2px;">OK</td> </tr> </table> </td> </tr> </table>		REM	0.0	Hz	OUTPUT	FWD		<table border="1" style="width: 100%; border-collapse: collapse;"> <tr> <td style="width: 10%; padding: 2px;">REM</td> <td style="width: 10%; padding: 2px;">CHOICE</td> <td style="width: 80%; padding: 2px;">Do you want to use the start-up assistant?</td> </tr> <tr> <td style="text-align: center; padding: 2px;">Yes</td> <td colspan="2"></td> </tr> <tr> <td style="text-align: center; padding: 2px;">NO</td> <td colspan="2"></td> </tr> <tr> <td style="padding: 2px;">EXIT</td> <td style="padding: 2px;">00:00</td> <td style="padding: 2px;">OK</td> </tr> </table>			REM	CHOICE	Do you want to use the start-up assistant?	Yes			NO			EXIT	00:00	OK
REM	0.0	Hz																				
OUTPUT	FWD																					
<table border="1" style="width: 100%; border-collapse: collapse;"> <tr> <td style="width: 10%; padding: 2px;">REM</td> <td style="width: 10%; padding: 2px;">CHOICE</td> <td style="width: 80%; padding: 2px;">Do you want to use the start-up assistant?</td> </tr> <tr> <td style="text-align: center; padding: 2px;">Yes</td> <td colspan="2"></td> </tr> <tr> <td style="text-align: center; padding: 2px;">NO</td> <td colspan="2"></td> </tr> <tr> <td style="padding: 2px;">EXIT</td> <td style="padding: 2px;">00:00</td> <td style="padding: 2px;">OK</td> </tr> </table>			REM	CHOICE	Do you want to use the start-up assistant?	Yes			NO			EXIT	00:00	OK								
REM	CHOICE	Do you want to use the start-up assistant?																				
Yes																						
NO																						
EXIT	00:00	OK																				

MANUAL ENTRY OF START-UP DATA (parameter group 99)

- If you have an Assistant Control Panel, select the language (the Basic Control Panel does not support languages). See parameter [9901](#) for the values of the available language alternatives.
- The general parameter setting procedure is described below for the Basic Control Panel. You find more detailed instructions for the Basic Control Panel on page [63](#). Instructions for the Assistant Control Panel are on page [74](#).
- The general parameter setting procedure:
1. To go to the Main menu, press  if the bottom line shows OUTPUT; otherwise press  repeatedly until you see MENU at the bottom.
 2. Press keys / until you see "PAR" and press .
 3. Find the appropriate parameter group with keys / and press .
 4. Find the appropriate parameter in the group with keys /.
 5. Press and hold  for about two seconds until the parameter value is shown with **SET** under the value.
 6. Change the value with keys /. The value changes faster while you keep the key pressed down.
 7. Save the parameter value by pressing .
- Select the application macro (parameter [9902](#)). The general parameter setting procedure is given above.
The default value 1 (ABB STANDARD) is suitable in most cases.
- Select the motor control mode (parameter [9904](#)).
- 1 (VECTOR:SPEED) is suitable in most cases. 2 (VECTOR:TORQ) is suitable for torque control applications. 3 (SCALAR:FREQ) is recommended
- for multimotor drives when the number of the motors connected to the drive is variable
 - when the nominal current of the motor is less than 20% of the nominal current of the drive
 - when the drive is used for test purposes with no motor connected.

REM	↻ PAR EDIT
9901	LANGUAGE ENGLISH
[0]	
CANCEL	00:00
	SAVE

REM	rEF
	MENU FWD

REM	-01-
	PAR FWD

REM	2001
	PAR FWD

REM	2002
	PAR FWD

REM	1500	rpm
	PAR SET FWD	

REM	1600	rpm
	PAR SET FWD	

REM	2002
	PAR FWD

REM	9902
	PAR FWD

REM	9904
	PAR FWD

- Enter the motor data from the motor nameplate:

ABB Motors									
3 ~ motor		M2AA 200 MLA 4							
IEC 200 M/L 55									
No									
Ins.cl. F					IP 55				
V	Hz	kW	r/min	A	cos φ	I _A /I _N	t _E /s		
690 Y	50	30	1475	32.5	0.83				
400 D	50	30	1475	56	0.83				
660 Y	50	30	1470	34	0.83				
380 D	50	30	1470	59	0.83				
415 D	50	30	1475	54	0.83				
440 D	60	35	1770	59	0.83				
Cat. no 3GAA 202 001 - ADA									
6312/C3			6210/C3				180 kg		
IEC 34-1									

380 V
supply
voltage

Note: Set the motor data to exactly the same value as on the motor nameplate. For example, if the motor nominal speed is 1440 rpm on the nameplate, setting the value of parameter **9908** MOTOR NOM SPEED to 1500 rpm results in the wrong operation of the drive.

- motor nominal voltage (parameter **9905**)
- motor nominal current (parameter **9906**)
Allowed range: 0.2...2.0 · I_{2N} A
- motor nominal frequency (parameter **9907**)
- motor nominal speed (parameter **9908**)
- motor nominal power (parameter **9909**)

REM **9905**
PAR FWD

REM **9906**
PAR FWD

REM **9907**
PAR FWD

REM **9908**
PAR FWD

REM **9909**
PAR FWD

- Select the motor identification method (parameter **9910**).

The default value 0 (OFF/IDMAGN) using the identification magnetization is suitable for most applications. It is applied in this basic start-up procedure. Note however that this requires that:













- parameter **9904** is set to 1 (VECTOR: SPEED) or 2 (VECTOR: TORQ)
- parameter **9904** is set to 3 (SCALAR: FREQ), and parameter **2101** is set to 3 (SCALAR FLYSTART) or 5 (FLY + BOOST).

If your selection is 0 (OFF/IDMAGN), move to the next step.

Value 1 (ON) should be selected if:

- the operation point is near zero speed, and/or
- operation at torque range above the motor nominal torque over a wide speed range and without any measured speed feedback is required.

If you decide to do the ID Run (value 1 (ON)), continue by following the separate instructions given on page **54** in section **How to perform the ID Run** and then return to step **DIRECTION OF THE MOTOR ROTATION** on page **49**.

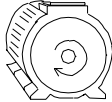
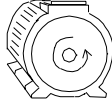
IDENTIFICATION MAGNETIZATION WITH ID RUN SELECTION 0 (OFF)	
<input type="checkbox"/> Press key  to switch to local control (LOC shown on the left). Press  to start the drive. The motor model is now calculated by magnetizing the motor for 10 to 15 s at zero speed.	
DIRECTION OF THE MOTOR ROTATION	
<input type="checkbox"/> Check the direction of the motor rotation. <ul style="list-style-type: none"> • If the drive is in remote control (REM shown on the left), switch to local control by pressing . • To go to the Main menu, press  if the bottom line shows OUTPUT; otherwise press  repeatedly until you see MENU at the bottom. • Press keys / until you see "rEF" and press . • Increase the frequency reference from zero to a small value with key . • Press  to start the motor. • Check that the actual direction of the motor is the same as indicated on the display (FWD means forward and REV reverse). • Press  to stop the motor. <p>To change the direction of the motor rotation:</p> <ul style="list-style-type: none"> • Disconnect input power from the drive, and wait 5 minutes for the intermediate circuit capacitors to discharge. Measure the voltage between each input terminal (U1, V1 and W1) and earth with a multimeter to ensure that the drive is discharged. • Exchange the position of two motor cable phase conductors at the drive output terminals or at the motor connection box. • Verify your work by applying input power and repeating the check as described above. 	<div style="border: 1px solid black; padding: 5px; margin-bottom: 20px;"> LOC XXX Hz <div style="text-align: center;"> FWD</div> </div> <div style="display: flex; flex-direction: column; align-items: center;"> <div style="display: flex; align-items: center; margin-bottom: 20px;">  <div style="margin-left: 10px;">forward direction</div> </div> <div style="display: flex; align-items: center;">  <div style="margin-left: 10px;">reverse direction</div> </div> </div>
SPEED LIMITS AND ACCELERATION/DECELERATION TIMES	
<input type="checkbox"/> Set the minimum speed (parameter 2001).	<div style="border: 1px solid black; padding: 5px; text-align: center;"> LOC 2001 PAR FWD </div>
<input type="checkbox"/> Set the maximum speed (parameter 2002).	<div style="border: 1px solid black; padding: 5px; text-align: center;"> LOC 2002 PAR FWD </div>
<input type="checkbox"/> Set the acceleration time 1 (parameter 2202). Note: Check also acceleration time 2 (parameter 2205) if two acceleration times will be used in the application.	<div style="border: 1px solid black; padding: 5px; text-align: center;"> LOC 2202 PAR FWD </div>

- Set the deceleration time 1 (parameter [2203](#)).
Note: Set also deceleration time 2 (parameter [2206](#)) if two deceleration times will be used in the application.

LOC	2203
	PAR FWD

SAVING A USER MACRO AND FINAL CHECK

- The start-up is now completed. However, it might be useful at this stage to set the parameters required by your application and save the settings as a user macro as instructed in section [User macros](#) on page [94](#).
- Check that the drive state is OK.
 Basic Control Panel: Check that there are no faults or alarms shown on the display. If you want to check the LEDs on the front of the drive, switch first to remote control (otherwise a fault is generated) before removing the panel and verifying that the red LED is not lit and the green LED is lit but not blinking.
 Assistant Control Panel: Check that there are no faults or alarms shown on the display and that the panel LED is green and does not blink.













LOC	9902
	PAR FWD

The drive is now ready for use.

How to perform the guided start-up

To be able to perform the guided start-up, you need the Assistant Control Panel.

Before you start, ensure that you have the motor nameplate data on hand.

SAFETY	
	<p>The start-up may only be carried out by a qualified electrician.</p> <p>The safety instructions given in chapter Safety must be followed during the start-up procedure.</p>
<ul style="list-style-type: none"> <input type="checkbox"/> Check the installation. See the checklist in chapter Installation checklist. <input type="checkbox"/> Check that the starting of the motor does not cause any danger. De-couple the driven machine if: <ul style="list-style-type: none"> • there is a risk of damage in case of incorrect direction of rotation, or • an ID Run needs to be performed during the drive start-up. ID Run is essential only in applications that require the ultimate in motor control accuracy. 	
POWER-UP	
<ul style="list-style-type: none"> <input type="checkbox"/> Apply input power. The control panel first asks if you want to use the Start-up Assistant. <ul style="list-style-type: none"> • Press  (when Yes is highlighted) to run the Start-up Assistant. • Press  if you do not want to run the Start-up Assistant. • Press key  to highlight No and then press  if you want to make the panel ask (or not ask) the question about running the Start-up Assistant again the next time you switch on the power to the drive. 	<div style="border: 1px solid black; padding: 5px; margin-bottom: 10px;"> REM ↻ CHOICE— Do you want to use the start-up assistant? Yes No EXIT 00:00 OK </div> <div style="border: 1px solid black; padding: 5px;"> REM ↻ CHOICE— Show start-up assistant on next boot? Yes No EXIT 00:00 OK </div>
SELECTING THE LANGUAGE	
<ul style="list-style-type: none"> <input type="checkbox"/> If you decided to run the Start-up Assistant, the display then asks you to select the language. Scroll to the desired language with keys / and press  to accept. If you press , the Start-up Assistant is stopped. 	<div style="border: 1px solid black; padding: 5px;"> REM ↻ PAR EDIT— 9901 LANGUAGE ENGLISH [0] EXIT 00:00 SAVE </div>
STARTING THE GUIDED SET-UP	
<ul style="list-style-type: none"> <input type="checkbox"/> The Start-up Assistant now guides you through the set-up tasks, starting with the motor set-up. Set the motor data to exactly the same value as on the motor nameplate. Scroll to the desired parameter value with keys / and press  to accept and continue with the Start-up Assistant. Note: At any time, if you press , the Start-up Assistant is stopped and the display goes to the Output mode. 	<div style="border: 1px solid black; padding: 5px;"> REM ↻ PAR EDIT— 9905 MOTOR NOM VOLT 220 V EXIT 00:00 SAVE </div>

How to control the drive through the I/O interface

The table below instructs how to operate the drive through the digital and analog inputs when:

- the motor start-up is performed, and
- the default (standard) parameter settings are valid.

Displays of the Basic Control Panel are shown as an example.

PRELIMINARY SETTINGS													
<p>If you need to change the direction of rotation, check that parameter 1003 is set to 3 (REQUEST).</p> <p>Ensure that the control connections are wired according to the connection diagram given for the ABB Standard macro.</p> <p>Ensure that the drive is in remote control. Press key  to switch between remote and local control.</p>	<p>See section ABB Standard macro on page 87.</p> <p>In remote control, the panel display shows text REM.</p>												
STARTING AND CONTROLLING THE SPEED OF THE MOTOR													
<p>Start by switching digital input DI1 on.</p> <p>Basic Control Panel: Text FWD starts flashing fast and stops after the setpoint is reached</p> <p>Assistant Control Panel: The arrow starts rotating. It is dotted until the setpoint is reached.</p> <p>Regulate the drive output frequency (motor speed) by adjusting the voltage of analog input AI1.</p>	<table border="1" style="width: 100%; text-align: center;"> <tr> <td style="width: 20%;">REM</td> <td style="font-size: 2em;">0.0</td> <td style="width: 10%;">HZ</td> </tr> <tr> <td>OUTPUT</td> <td></td> <td>FWD</td> </tr> </table> <table border="1" style="width: 100%; text-align: center;"> <tr> <td style="width: 20%;">REM</td> <td style="font-size: 2em;">50.0</td> <td style="width: 10%;">HZ</td> </tr> <tr> <td>OUTPUT</td> <td></td> <td>FWD</td> </tr> </table>	REM	0.0	HZ	OUTPUT		FWD	REM	50.0	HZ	OUTPUT		FWD
REM	0.0	HZ											
OUTPUT		FWD											
REM	50.0	HZ											
OUTPUT		FWD											
CHANGING THE DIRECTION OF ROTATION OF THE MOTOR													
<p>Reverse direction: Switch digital input DI2 on.</p> <p>Forward direction: Switch digital input DI2 off.</p>	<table border="1" style="width: 100%; text-align: center;"> <tr> <td style="width: 20%;">REM</td> <td style="font-size: 2em;">50.0</td> <td style="width: 10%;">HZ</td> </tr> <tr> <td>OUTPUT</td> <td></td> <td>REV</td> </tr> </table> <table border="1" style="width: 100%; text-align: center;"> <tr> <td style="width: 20%;">REM</td> <td style="font-size: 2em;">50.0</td> <td style="width: 10%;">HZ</td> </tr> <tr> <td>OUTPUT</td> <td></td> <td>FWD</td> </tr> </table>	REM	50.0	HZ	OUTPUT		REV	REM	50.0	HZ	OUTPUT		FWD
REM	50.0	HZ											
OUTPUT		REV											
REM	50.0	HZ											
OUTPUT		FWD											
STOPPING THE MOTOR													
<p>Switch digital input DI1 off. The motor stops.</p> <p>Basic Control Panel: Text FWD starts flashing slowly.</p> <p>Assistant Control Panel: The arrow stops rotating.</p>	<table border="1" style="width: 100%; text-align: center;"> <tr> <td style="width: 20%;">REM</td> <td style="font-size: 2em;">0.0</td> <td style="width: 10%;">HZ</td> </tr> <tr> <td>OUTPUT</td> <td></td> <td>FWD</td> </tr> </table>	REM	0.0	HZ	OUTPUT		FWD						
REM	0.0	HZ											
OUTPUT		FWD											

How to perform the ID Run

The drive estimates motor characteristics automatically when the drive is started for the first time and after any motor parameter (group [99 START-UP DATA](#)) is changed. This is valid when parameter [9910](#) ID RUN has value 0 (OFF/IDMAGN).

In most applications there is no need to perform a separate ID Run. The ID Run should be selected if:

- vector control mode is used [parameter 9904 = 1 (VECTOR:SPEED) or 2 (VECTOR:TORQ)], and
- operation point is near zero speed and/or
- operation at torque range above the motor nominal torque, over a wide speed range, and without any measured speed feedback (i.e without a pulse encoder) is needed.

Note: If motor parameters (group [99 START-UP DATA](#)) are changed after the ID Run, it must be repeated.

ID Run procedure

The general parameter setting procedure is not repeated here. For Basic Control Panel, see page [63](#) and for Assistant Control Panel, see page [74](#) in chapter [Control panels](#). The ID Run cannot be performed without a control panel.

PRE-CHECK





WARNING! The motor will run at up to approximately 50...80% of the nominal speed during the ID Run. The motor will rotate in the forward direction. **Ensure that it is safe to run the motor before performing the ID Run!**

- De-couple the motor from the driven equipment.
- If parameter values (group [01 OPERATING DATA](#) to group [98 OPTIONS](#)) are changed before the ID Run, check that the new settings meet the following conditions:
 - [2001](#) MINIMUM SPEED ≤ 0 rpm
 - [2002](#) MAXIMUM SPEED $> 80\%$ of the motor rated speed
 - [2003](#) MAXIMUM CURRENT $\geq I_{2N}$
 - [2017](#) MAX TORQUE 1 $> 50\%$ or [2018](#) MAX TORQUE 2 $> 50\%$, depending on which limit is in use according to parameter [2014](#) MAX TORQUE SEL
- Check that the Run Enable signal is on (parameter [1601](#)).
- Ensure that the panel is in local control (LOC shown on the left / at the top). Press key  to switch between local and remote control.

ID RUN WITH THE BASIC CONTROL PANEL

- Change parameter **9910** ID RUN to 1 (ON). Save the new setting by pressing .

- If you want to monitor actual values during the ID Run, go to the Output mode by pressing  repeatedly until you get there.

- Press  to start the ID Run. The panel keeps switching between the display that was shown when you started the ID Run and the alarm display presented on the right.
 In general, it is recommended not to press any control panel keys during the ID Run. However, you can stop the ID Run at any time by pressing .
 After the ID Run is completed, the alarm display is not shown any more.
 If the ID Run fails, the fault display presented on the right is shown.

LOC **9910**
PAR FWD

LOC **1**
PAR **SET** FWD

LOC **0.0** Hz
OUTPUT FWD



LOC **A2019**
FWD

LOC **F0011**
FWD

ID RUN WITH THE ASSISTANT CONTROL PANEL

- Change parameter **9910** ID RUN to 1 (ON). Save the new setting by pressing .

- If you want to monitor actual values during the ID Run, go to the Output mode by pressing  repeatedly until you get there.

- Press  to start the ID Run. The panel keeps switching between the display that was shown when you started the ID Run and the alarm display presented on the right.
 In general, it is recommended not to press any control panel keys during the ID Run. However, you can stop the ID Run at any time by pressing .
 After the ID Run is completed, the alarm display is not shown any more.
 If the ID Run fails, the fault display presented on the right is shown.

LOC ↕ PAR EDIT
9910 ID RUN
ON
[1]
CANCEL 00:00 SAVE

LOC ↕ **50.0HZ**
0.0 Hz
0.0 A
0.0 %
DIR 00:00 MENU

LOC ↕ ALARM
ALARM 2019
ID run
00:00

LOC ↕ FAULT
FAULT 11
ID RUN FAIL
00:00

Control panels

What this chapter contains

The chapter describes the control panel keys, LED indicators and display fields. It also instructs in using the panel in control, monitoring and changing the settings.

About control panels

Use a control panel to control the ACS350, read status data, and adjust parameters. The ACS350 works with either of two different control panel types:

- Basic Control Panel – This panel (described below) provides basic tools for manual entry of parameter values.
- Assistant Control Panel – This panel (described in section [Assistant Control Panel](#) on page 67) includes pre-programmed assistants to automate the most common parameter setups. The panel provides language support. It is available with different language sets.

Compatibility

The manual is compatible with the following versions:

- Basic Control Panel: ACS-CP-C Rev. K
- Assistant Control Panel (Area 1): ACS-CP-A Rev. Y
- Assistant Control Panel (Area 2): ACS-CP-L Rev. E
- Assistant Control Panel (Asia): ACS-CP-D Rev. M

See page 70 for how to find out the version of your Assistant Control Panel. See parameter 9901 LANGUAGE to see the languages supported by the different Assistant Control Panels.

Basic Control Panel

Features

The Basic Control Panel features:

- numeric control panel with an LCD display
- copy function – parameters can be copied to the control panel memory for later transfer to other drives or for backup of a particular system.

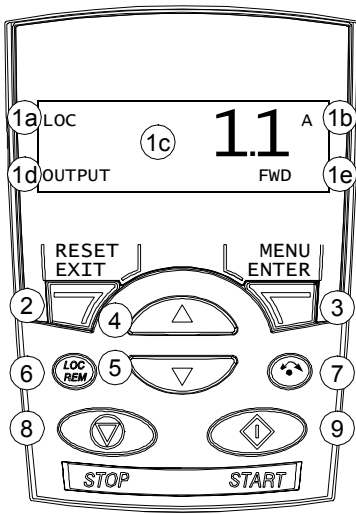

Overview

The following table summarizes the key functions and displays on the Basic Control Panel.



No.	Use
1	<p>LCD display – Divided into five areas:</p> <p>a. Upper left – Control location: LOC: drive control is local, that is, from the control panel REM: drive control is remote, such as the drive I/O or fieldbus.</p> <p>b. Upper right – Unit of the displayed value.</p> <p>c. Center – Variable; in general, shows parameter and signal values, menus or lists. Shows also fault and alarm codes.</p> <p>d. Lower left and center – Panel operation state: OUTPUT: Output mode PAR: Parameter mode MENU: Main menu. FAULT: Fault mode.</p> <p>e. Lower right – Indicators: FWD (forward) / REV (reverse): direction of the motor rotation Flashing slowly: stopped Flashing rapidly: running, not at setpoint Steady: running, at setpoint SET: Displayed value can be modified (in the Parameter and Reference modes).</p>
2	<p>RESET/EXIT – Exits to the next higher menu level without saving changed values. Resets faults in the Output and Fault modes.</p>
3	<p>MENU/ENTER – Enters deeper into menu level. In the Parameter mode, saves the displayed value as the new setting.</p>
4	<p>Up –</p> <ul style="list-style-type: none"> • Scrolls up through a menu or list. • Increases a value if a parameter is selected. • Increases the reference value in the Reference mode. <p>Holding the key down changes the value faster.</p>
5	<p>Down –</p> <ul style="list-style-type: none"> • Scrolls down through a menu or list. • Decreases a value if a parameter is selected. • Decreases the reference value in the Reference mode. <p>Holding the key down changes the value faster.</p>
6	<p>LOC/REM – Changes between local and remote control of the drive.</p>
7	<p>DIR – Changes the direction of the motor rotation.</p>
8	<p>STOP – Stops the drive in local control.</p>
9	<p>START – Starts the drive in local control.</p>

Operation

You operate the control panel with the help of menus and keys. You select an option, e.g. operation mode or parameter, by scrolling the  and  arrow keys until the option is visible in the display and then pressing the  key.

With the  key, you return to the previous operation level without saving the made changes.

The Basic Control Panel has five panel modes: Output, Reference, Parameter, Copy and Fault. The operation in the first four modes is described in this chapter. When a fault or alarm occurs, the panel goes automatically to the Fault mode showing the fault or alarm code. You can reset the fault or alarm in the Output or Fault mode (see chapter [Fault tracing](#)).

After the power is switched on, the panel is in the Output mode, where you can start, stop, change the direction, switch between local and remote control and monitor up to three actual values (one at a time). To do other tasks, go first to the Main menu and select the appropriate mode.

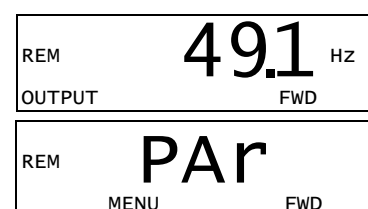





How to do common tasks

The table below lists common tasks, the mode in which you can perform them and the page number where the steps to do the task are described in detail.

Task	Mode	Page
How to switch between local and remote control	Any	60
How to start and stop the drive	Any	60
How to change the direction of the motor rotation	Any	60
How to browse the monitored signals	Output	61
How to set the speed, frequency or torque reference	Reference	62
How to change the value of a parameter	Parameter	63
How to select the monitored signals	Parameter	64
How to reset faults and alarms	Output, Fault	273
How to copy parameters from the drive to the control panel	Copy	66
How to restore parameters from the control panel to the drive	Copy	66



How to start, stop and switch between local and remote control

You can start, stop and switch between local and remote control in any mode. To be able to start or stop the drive, the drive must be in local control.

Step	Action	Display
1.	<ul style="list-style-type: none"> To switch between remote control (REM shown on the left) and local control (LOC shown on the left), press . <p>Note: Switching to local control can be disabled with parameter 1606 LOCAL LOCK.</p> <p>After pressing the key, the display briefly shows message “LoC” or “rE”, as appropriate, before returning to the previous display.</p> <p>The very first time the drive is powered up, it is in remote control (REM) and controlled through the drive I/O terminals. To switch to local control (LOC) and control the drive using the control panel, press . The result depends on how long you press the key:</p> <ul style="list-style-type: none"> If you release the key immediately (the display flashes “LoC”), the drive stops. Set the local control reference as instructed on page 62. If you press the key for about two seconds (release when the display changes from “LoC” to “LoC r”), the drive continues as before. The drive copies the current remote values for the run/stop status and the reference, and uses them as the initial local control settings. <ul style="list-style-type: none"> To stop the drive in local control, press . To start the drive in local control, press . 	<div style="border: 1px solid black; padding: 5px; margin-bottom: 10px;"> LOC 49.1 Hz OUTPUT FWD </div> <div style="border: 1px solid black; padding: 5px;"> LOC LoC FWD </div> <p>Text FWD or REV on the bottom line starts flashing slowly.</p> <p>Text FWD or REV on the bottom line starts flashing rapidly. It stops flashing when the drive reaches the setpoint.</p>

How to change the direction of the motor rotation

You can change the direction of the motor rotation in any mode.

Step	Action	Display
1.	<p>If the drive is in remote control (REM shown on the left), switch to local control by pressing . The display briefly shows message “LoC” before returning to the previous display.</p>	<div style="border: 1px solid black; padding: 5px; margin-bottom: 10px;"> LOC 49.1 Hz OUTPUT FWD </div>
2.	<p>To change the direction from forward (FWD shown at the bottom) to reverse (REV shown at the bottom), or vice versa, press .</p> <p>Note: Parameter 1003 DIRECTION must be set to 3 (REQUEST).</p>	<div style="border: 1px solid black; padding: 5px;"> LOC 49.1 Hz OUTPUT REV </div>

Output mode

In the Output mode, you can:



- monitor actual values of up to three group **01 OPERATING DATA** signals, one signal at a time
- start, stop, change the direction and switch between local and remote control.

You get to the Output mode by pressing  until the display shows text OUTPUT at the bottom.

The display shows the value of one group **01 OPERATING DATA** signal. The unit is shown on the right. Page 64 tells how to select up to three signals to be monitored in the Output mode. The table below shows how to view them one at a time.

REM	49.1 Hz
OUTPUT	FWD

How to browse the monitored signals













Step	Action	Display												
1.	<p>If more than one signals have been selected to be monitored (see page 64), you can browse them in the Output mode.</p> <p>To browse the signals forward, press key  repeatedly. To browse them backward, press key  repeatedly.</p>	<table border="1"> <tr> <td>REM</td> <td style="text-align: center;">49.1 Hz</td> </tr> <tr> <td>OUTPUT</td> <td style="text-align: center;">FWD</td> </tr> </table> <table border="1"> <tr> <td>REM</td> <td style="text-align: center;">0.5 A</td> </tr> <tr> <td>OUTPUT</td> <td style="text-align: center;">FWD</td> </tr> </table> <table border="1"> <tr> <td>REM</td> <td style="text-align: center;">10.7 %</td> </tr> <tr> <td>OUTPUT</td> <td style="text-align: center;">FWD</td> </tr> </table>	REM	49.1 Hz	OUTPUT	FWD	REM	0.5 A	OUTPUT	FWD	REM	10.7 %	OUTPUT	FWD
REM	49.1 Hz													
OUTPUT	FWD													
REM	0.5 A													
OUTPUT	FWD													
REM	10.7 %													
OUTPUT	FWD													

Reference mode

In the Reference mode, you can:

- set the speed, frequency or torque reference
- start, stop, change the direction and switch between local and remote control.

How to set the speed, frequency or torque reference

















Step	Action	Display
1.	Go to the Main menu by pressing  if you are in the Output mode, otherwise by pressing  repeatedly until you see MENU at the bottom.	
2.	If the drive is in remote control (REM shown on the left), switch to local control by pressing  . The display briefly shows “LoC” before switching to local control. Note: With group 11 REFERENCE SELECT , you can allow the reference modification in remote control (REM).	
3.	If the panel is not in the Reference mode (“rEF” not visible), press key  or  until you see “rEF” and then press  . Now the display shows the current reference value with SET under the value.	 
4.	<ul style="list-style-type: none"> • To increase the reference value, press . • To decrease the reference value, press . <p>The value changes immediately when you press the key. It is stored in the drive permanent memory and restored automatically after power switch-off.</p>	

Parameter mode

In the Parameter mode, you can:

- view and change parameter values
- select and modify the signals shown in the Output mode
- start, stop, change the direction and switch between local and remote control.

How to select a parameter and change its value

Step	Action	Display
1.	Go to the Main menu by pressing  if you are in the Output mode, otherwise by pressing  repeatedly until you see MENU at the bottom.	<div style="border: 1px solid black; padding: 5px; text-align: center;"> LOC rEF MENU FWD </div>
2.	If the panel is not in the Parameter mode ("PAR" not visible), press key  or  until you see "PAR" and then press  . The display shows the number of one of the parameter groups.	<div style="border: 1px solid black; padding: 5px; text-align: center;"> LOC PAR MENU FWD </div>
		<div style="border: 1px solid black; padding: 5px; text-align: center;"> LOC -01- PAR FWD </div>
3.	Use keys  and  to find the desired parameter group.	<div style="border: 1px solid black; padding: 5px; text-align: center;"> LOC -11- PAR FWD </div>
4.	Press  . The display shows one of the parameters in the selected group.	<div style="border: 1px solid black; padding: 5px; text-align: center;"> LOC 1101 PAR FWD </div>
5.	Use keys  and  to find the desired parameter.	<div style="border: 1px solid black; padding: 5px; text-align: center;"> LOC 1103 PAR FWD </div>
6.	Press and hold  for about two seconds until the display shows the value of the parameter with SET underneath indicating that changing of the value is now possible. Note: When SET is visible, pressing keys  and  simultaneously changes the displayed value to the default value of the parameter.	<div style="border: 1px solid black; padding: 5px; text-align: center;"> LOC 1 PAR SET FWD </div>
7.	Use keys  and  to select the parameter value. When you have changed the parameter value, SET starts flashing. <ul style="list-style-type: none"> • To save the displayed parameter value, press . • To cancel the new value and keep the original, press . 	<div style="border: 1px solid black; padding: 5px; text-align: center;"> LOC 2 PAR SET FWD </div>
		<div style="border: 1px solid black; padding: 5px; text-align: center;"> LOC 1103 PAR FWD </div>

How to select the monitored signals

Step	Action	Display
1.	<p>You can select which signals are monitored in the Output mode and how they are displayed with group 34 PANEL DISPLAY parameters. See page 63 for detailed instructions on changing parameter values.</p> <p>By default, the display shows three signals. The particular default signals depend on the value of parameter 9902 APPLIC MACRO: For macros whose default value of parameter 9904 MOTOR CTRL MODE is 1 (VECTOR:SPEED), the default for signal 1 is 0102 SPEED, otherwise 0103 OUTPUT FREQ. The defaults for signals 2 and 3 are always 0104 CURRENT and 0105 TORQUE, respectively.</p> <p>To change the default signals, select up to three signals from group 01 OPERATING DATA to be shown.</p> <p>Signal 1: Change the value of parameter 3401 SIGNAL1 PARAM to the index of the signal parameter in group 01 OPERATING DATA (= number of the parameter without the leading zero), e.g. 105 means parameter 0105 TORQUE. Value 100 means that no signal is displayed.</p> <p>Repeat for signals 2 (3408 SIGNAL2 PARAM) and 3 (3415 SIGNAL3 PARAM). For example, if 3401 = 0 and 3415 = 0, browsing is disabled and only the signal specified by 3408 appears in the display. If all three parameters are set to 0, i.e. no signals are selected for monitoring, the panel displays text "n.A".</p>	<div style="border: 1px solid black; padding: 5px; margin-bottom: 5px;">LOC 103 PAR SET FWD</div> <div style="border: 1px solid black; padding: 5px; margin-bottom: 5px;">LOC 104 PAR SET FWD</div> <div style="border: 1px solid black; padding: 5px;">LOC 105 PAR SET FWD</div>
2.	<p>Specify the decimal point location, or use the decimal point location and unit of the source signal [setting (9 (DIRECT))]. Bar graphs are not available for Basic Operation Panel. For details, see parameter 3404.</p> <p>Signal 1: parameter 3404 OUTPUT1 DSP FORM Signal 2: parameter 3411 OUTPUT2 DSP FORM Signal 3: parameter 3418 OUTPUT3 DSP FORM.</p>	<div style="border: 1px solid black; padding: 5px;">LOC 9 PAR SET FWD</div>
3.	<p>Select the units to be displayed for the signals. This has no effect if parameter 3404/3411/3418 is set to 9 (DIRECT). For details, see parameter 3405.</p> <p>Signal 1: parameter 3405 OUTPUT1 UNIT Signal 2: parameter 3412 OUTPUT2 UNIT Signal 3: parameter 3419 OUTPUT3 UNIT.</p>	<div style="border: 1px solid black; padding: 5px;">LOC 3 PAR SET FWD</div>
4.	<p>Select the scalings for the signals by specifying the minimum and maximum display values. This has no effect if parameter 3404/3411/3418 is set to 9 (DIRECT). For details, see parameters 3406 and 3407.</p> <p>Signal 1: parameters 3406 OUTPUT1 MIN and 3407 OUTPUT1 MAX Signal 2: parameters 3413 OUTPUT2 MIN and 3414 OUTPUT2 MAX Signal 3: parameters 3420 OUTPUT3 MIN and 3421 OUTPUT3 MAX.</p>	<div style="border: 1px solid black; padding: 5px; margin-bottom: 5px;">LOC 0.0 Hz PAR SET FWD</div> <div style="border: 1px solid black; padding: 5px;">LOC 500.0 Hz PAR SET FWD</div>

Copy mode

The Basic Control Panel can store a full set of drive parameters and up to three user sets of drive parameters to the control panel. The control panel memory is non-volatile.

In the Copy mode, you can do the following:

- Copy all parameters from the drive to the control panel (uL – Upload). This includes all defined user sets of parameters and internal (not adjustable by the user) parameters such as those created by the ID Run.
- Restore the full parameter set from the control panel to the drive (dL A – Download All). This writes all parameters, including the internal non-user-adjustable motor parameters, to the drive. It does not include the user sets of parameters.

Note: Only use this function to restore a drive, or to transfer parameters to systems that are identical to the original system.

- Copy a partial parameter set from the control panel to a drive (dL P – Download Partial). The partial set does not include user sets, internal motor parameters, parameters [9905...9909](#), [1605](#), [1607](#), [5201](#), nor any group [51 EXT COMM MODULE](#) and [53 EFB PROTOCOL](#) parameters.

The source and target drives and their motor sizes do not need to be the same.











- Copy USER S1 parameters from the control panel to the drive (dL u1 – Download User Set 1). A user set includes group [99 START-UP DATA](#) parameters and the internal motor parameters.

The function is only shown on the menu when User Set 1 has been first saved using parameter [9902 APPLIC MACRO](#) (see section [User macros](#) on page [94](#)) and then uploaded to panel.

- Copy USER S2 parameters from the control panel to the drive (dL u2 – Download User Set 2). As dL u1 – Download User Set 1 above.
- Copy USER S3 parameters from the control panel to the drive (dL u3 – Download User Set 3). As dL u1 – Download User Set 1 above.
- Start, stop, change the direction and switch between local and remote control.

How to upload and download parameters

For the upload and download functions available, see above.

Step	Action	Display	
1.	Go to the Main menu by pressing  if you are in the Output mode, otherwise by pressing  repeatedly until you see MENU at the bottom.	<div style="border: 1px solid black; padding: 5px; text-align: center;"> LOC PAR MENU FWD </div>	
2.	If the panel is not in the Copy mode ("CoPY" not visible), press key  or  until you see "CoPY". Press  .	<div style="border: 1px solid black; padding: 5px; text-align: center;"> LOC CoPY MENU FWD </div>	
		<div style="border: 1px solid black; padding: 5px; text-align: center;"> LOC uL MENU FWD </div>	
3.	<ul style="list-style-type: none"> To upload all parameters (including user sets) from the drive to the control panel, step to "uL" with keys  and . Press  . During the transfer, the display shows the transfer status as a percentage of completion.	<div style="border: 1px solid black; padding: 5px; text-align: center;"> LOC uL MENU FWD </div>	
		<div style="border: 1px solid black; padding: 5px; text-align: center;"> LOC uL 50 % FWD </div>	
		<ul style="list-style-type: none"> To perform downloads, step to the appropriate operation (here "dL A", Download all, is used as an example) with keys  and . Press  . During the transfer, the display shows the transfer status as a percentage of completion.	<div style="border: 1px solid black; padding: 5px; text-align: center;"> LOC dL A MENU FWD </div>
		<div style="border: 1px solid black; padding: 5px; text-align: center;"> LOC dL 50 % FWD </div>	

Basic Control Panel alarm codes

In addition to the faults and alarms generated by the drive (see chapter [Fault tracing](#)), the Basic Control Panel indicates control panel alarms with a code of the form A5xxx. See section [Alarms generated by the Basic Control Panel](#) on page 276 for a list of the alarm codes and descriptions.

Assistant Control Panel

Features

The Assistant Control Panel features:

- alphanumeric control panel with an LCD display
- language selection for the display
- Start-up Assistant to ease drive commissioning
- copy function – parameters can be copied to the control panel memory for later transfer to other drives or for backup of a particular system.
- context sensitive help
- real time clock.

Overview

The following table summarizes the key functions and displays on the Assistant Control Panel.

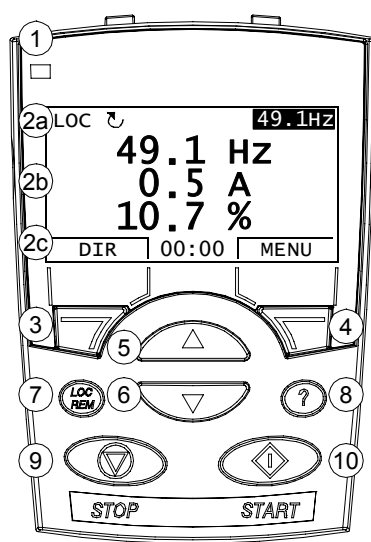

No.	Use
1	Status LED – Green for normal operation. If LED is flashing, or red, see section LEDs on page 287.
2	LCD display – Divided into three main areas: <ol style="list-style-type: none"> Status line – variable, depending on the mode of operation, see section Status line on page 68. Center – variable; in general, shows signal and parameter values, menus or lists. Shows also faults and alarms. Bottom line – shows current functions of the two soft keys and, if enabled, the clock display.
3	Soft key 1 – Function depends on the context. The text in the lower left corner of the LCD display indicates the function.
4	Soft key 2 – Function depends on the context. The text in the lower right corner of the LCD display indicates the function.
5	Up – <ul style="list-style-type: none"> • Scrolls up through a menu or list displayed in the center of the LCD display. • Increments a value if a parameter is selected. • Increments the reference value if the upper right corner is highlighted. Holding the key down changes the value faster.
6	Down – <ul style="list-style-type: none"> • Scrolls down through a menu or list displayed in the center of the LCD display. • Decrements a value if a parameter is selected. • Decrements the reference value if the upper right corner is highlighted. Holding the key down changes the value faster.
7	LOC/REM – Changes between local and remote control of the drive.
8	Help – Displays context sensitive information when the key is pressed. The information displayed describes the item currently highlighted in the center of the display.
9	STOP – Stops the drive in local control.
10	START – Starts the drive in local control.

Status line

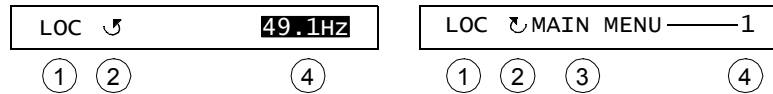

The top line of the LCD display shows the basic status information of the drive.



No.	Field	Alternatives	Significance
1	Control location	LOC	Drive control is local, that is, from the control panel.
		REM	Drive control is remote, such as the drive I/O or fieldbus.
2	State	↻	Forward shaft direction
		↺	Reverse shaft direction
		Rotating arrow	Drive is running at setpoint.
		Dotted rotating arrow	Drive is running but not at setpoint.
		Stationary arrow	Drive is stopped.
		Dotted stationary arrow	Start command is present, but the motor is not running, e.g. because start enable is missing.
3	Panel operation mode		<ul style="list-style-type: none"> Name of the current mode Name of the list or menu shown Name of the operation state, e.g. PAR EDIT.
4	Reference value or number of the selected item		<ul style="list-style-type: none"> Reference value in the Output mode Number of the highlighted item, e.g. mode, parameter group or fault.

Operation

You operate the control panel with menus and keys. The keys include two context-sensitive soft keys, whose current function is indicated by the text shown in the display above each key.

You select an option, e.g. operation mode or parameter, by scrolling the  and  arrow keys until the option is highlighted (in reverse video) and then pressing the relevant soft key. With the right soft key you usually enter a mode, accept an option or save the changes. The left soft key is used to cancel the made changes and return to the previous operation level.

The Assistant Control Panel has nine panel modes: Output, Parameters, Assistants, Changed Parameters, Fault Logger, Time and Date, Parameter Backup, I/O Settings and Fault. The operation in the first eight modes is described in this chapter. When a fault or alarm occurs, the panel goes automatically to the Fault mode showing the fault or alarm. You can reset it in the Output or Fault mode (see chapter [Fault tracing](#)).

Initially, the panel is in the Output mode, where you can start, stop, change the direction, switch between local and remote control, modify the reference value and monitor up to three actual values. To do other tasks, go first to the Main menu and select the appropriate mode on the menu. The status line (see section [Status line](#) on page 68) shows the name of the current menu, mode, item or state.

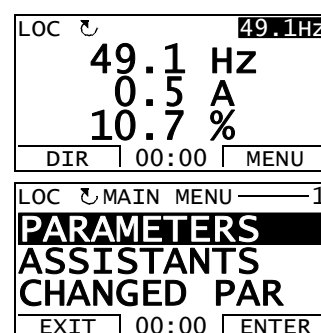





How to do common tasks



The table below lists common tasks, the mode in which you can perform them and the page number where the steps to do the task are described in detail.

Task	Mode	Page
How to get help	Any	70
How to find out the panel version	At power up	70
How to adjust the display contrast	Output	73
How to switch between local and remote control	Any	71
How to start and stop the drive	Any	72
How to change the direction of the motor rotation	Output	72
How to set the speed, frequency or torque reference	Output	73
How to change the value of a parameter	Parameters	74
How to select the monitored signals	Parameters	75
How to do guided tasks (specification of related parameter sets) with assistants	Assistants	76
How to view and edit changed parameters	Changed Parameters	77
How to view faults	Fault Logger	78
How to reset faults and alarms	Output, Fault	273
How to show/hide the clock, change date and time formats, set the clock and enable/disable automatic clock transitions according to the daylight saving changes	Time and Date	79
How to copy parameters from the drive to the control panel	Parameter Backup	82
How to restore parameters from the control panel to the drive	Parameter Backup	82
How to view backup information	Parameter Backup	83
How to edit and change parameter settings related to I/O terminals	I/O Settings	84

How to get help









Step	Action	Display
1.	Press  to read the context-sensitive help text for the item that is highlighted. If help text exists for the item, it is shown on the display.	<pre> LOC ↵ PAR GROUPS—10 01 OPERATING DATA 03 FB ACTUAL SIGNALS 04 FAULT HISTORY 10 START/STOP/DIR 11 REFERENCE SELECT EXIT 00:00 SEL </pre> <pre> LOC ↵ HELP— This group defines external sources (EXT1 and EXT2) for commands that enable start, stop and EXIT 00:00 </pre>
2.	If the whole text is not visible, scroll the lines with keys  and  .	<pre> LOC ↵ HELP— external sources (EXT1 and EXT2) for commands that enable start, stop and direction changes. EXIT 00:00 </pre>
3.	After reading the text, return to the previous display by pressing  .	<pre> LOC ↵ PAR GROUPS—10 01 OPERATING DATA 03 FB ACTUAL SIGNALS 04 FAULT HISTORY 10 START/STOP/DIR 11 REFERENCE SELECT EXIT 00:00 SEL </pre>

How to find out the panel version

Step	Action	Display
1.	If the power is switched on, switch it off.	
2.	Keep key  pressed down while you switch on the power and read the information. The display shows the following panel information: Panel FW: panel firmware version ROM CRC: panel ROM check sum Flash Rev: flash content version Flash content comment. When you release the  key, the panel goes to the Output mode.	<pre> PANEL VERSION INFO Panel FW: x.xx ROM CRC: xxxxxxxxxx Flash Rev: x.xx xxxxxxxxxxxxxxxxxxxx </pre>

How to start, stop and switch between local and remote control

You can start, stop and switch between local and remote control in any mode. To be able to start or stop the drive, the drive must be in local control.

Step	Action	Display
1.	<ul style="list-style-type: none"> • To switch between remote control (REM shown on the status line) and local control (LOC shown on the status line), press . <p>Note: Switching to local control can be disabled with parameter 1606 LOCAL LOCK.</p> <p>The very first time the drive is powered up, it is in remote control (REM) and controlled through the drive I/O terminals. To switch to local control (LOC) and control the drive using the control panel, press . The result depends on how long you press the key:</p> <ul style="list-style-type: none"> • If you release the key immediately (the display flashes “Switching to the local control mode”), the drive stops. Set the local control reference as instructed on page 73. • If you press the key for about two seconds, the drive continues as before. The drive copies the current remote values for the run/stop status and the reference, and uses them as the initial local control settings. <ul style="list-style-type: none"> • To stop the drive in local control, press . • To start the drive in local control, press . 	<div style="border: 1px solid black; padding: 5px; margin-bottom: 10px;"> <p>LOC  MESSAGE</p> <p>Switching to the local control mode.</p> <p style="text-align: center;">00:00</p> </div> <p>The arrow ( or ) on the status line stops rotating.</p> <p>The arrow ( or ) on the status line starts rotating. It is dotted until the drive reaches the setpoint.</p>

Output mode

In the Output mode, you can:





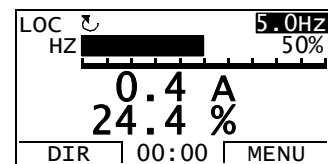
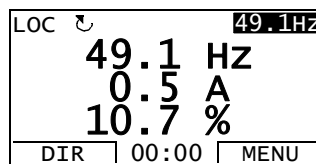

- monitor actual values of up to three signals in group **01 OPERATING DATA**
- change the direction of the motor rotation
- set the speed, frequency or torque reference
- adjust the display contrast
- start, stop, change the direction and switch between local and remote control.

You get to the Output mode by pressing  repeatedly.

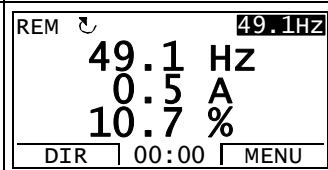

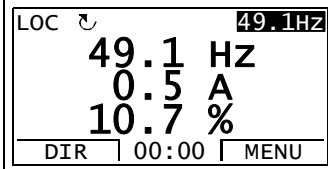

The top right corner of the display shows the reference value. The center can be configured to show up to three signal values or bar graphs; see page 75 for instructions on selecting and modifying the monitored signals.





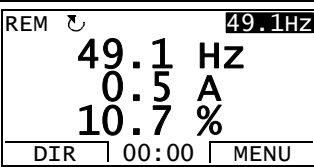

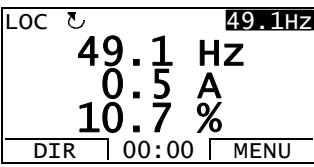
How to change the direction of the motor rotation

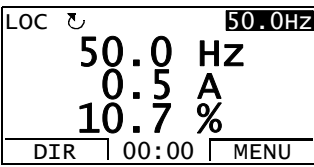
Step	Action	Display
1.	If you are not in the Output mode, press  repeatedly until you get there.	
2.	If the drive is in remote control (REM shown on the status line), switch to local control by pressing  . The display briefly shows a message about changing the mode and then returns to the Output mode.	
3.	To change the direction from forward ( shown on the status line) to reverse ( shown on the status line), or vice versa, press  . Note: Parameter 1003 DIRECTION must be set to 3 (REQUEST).	

How to set the speed, frequency or torque reference

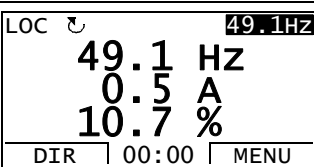
Step	Action	Display
1.	If you are not in the Output mode, press  repeatedly until you get there.	
2.	If the drive is in remote control (REM shown on the status line), switch to local control by pressing  . The display briefly shows a message about changing the mode and then returns to the Output mode. Note: With group 11 REFERENCE SELECT , you can allow the reference modification in remote control.	
3.	<ul style="list-style-type: none"> To increase the highlighted reference value shown in the top right corner of the display, press . The value changes immediately. It is stored in the drive permanent memory and restored automatically after power switch-off. To decrease the value, press . 	

How to adjust the display contrast

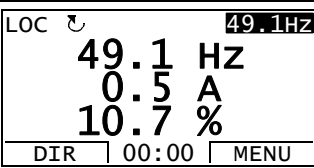













Step	Action	Display
1.	If you are not in the Output mode, press  repeatedly until you get there.	
2.	<ul style="list-style-type: none"> To increase the contrast, press keys  and  simultaneously. To decrease the contrast, press keys  and  simultaneously. 	

Parameters mode

In the Parameters mode, you can:

- view and change parameter values
- start, stop, change the direction and switch between local and remote control.

How to select a parameter and change its value

Step	Action	Display
1.	Go to the Main menu by pressing  if you are in the Output mode, otherwise by pressing  repeatedly until you get to the Main menu.	<pre> LOC ↺ MAIN MENU ——— 1 PARAMETERS ASSISTANTS CHANGED PAR EXIT 00:00 ENTER </pre>
2.	Go to the Parameters mode by selecting PARAMETERS on the menu with keys  and  , and pressing  .	<pre> LOC ↺ PAR GROUPS ——— 01 01 OPERATING DATA 03 FB ACTUAL SIGNALS 04 FAULT HISTORY 10 START/STOP/DIR 11 REFERENCE SELECT EXIT 00:00 SEL </pre>
3.	Select the appropriate parameter group with keys  and  . Press  .	<pre> LOC ↺ PAR GROUPS ——— 99 99 START-UP DATA 01 OPERATING DATA 03 FB ACTUAL SIGNALS 04 FAULT HISTORY 10 START/STOP/DIR EXIT 00:00 SEL </pre> <pre> LOC ↺ PARAMETERS ——— 9901 LANGUAGE ENGLISH 9902 APPLIC MACRO 9904 MOTOR CTRL MODE 9905 MOTOR NOM VOLT EXIT 00:00 EDIT </pre>
4.	Select the appropriate parameter with keys  and  . The current value of the parameter is shown below the selected parameter. Press  .	<pre> LOC ↺ PARAMETERS ——— 9901 LANGUAGE 9902 APPLIC MACRO ABB STANDARD 9904 MOTOR CTRL MODE 9905 MOTOR NOM VOLT EXIT 00:00 EDIT </pre> <pre> LOC ↺ PAR EDIT ——— 9902 APPLIC MACRO ABB STANDARD [1] CANCEL 00:00 SAVE </pre>
5.	Specify a new value for the parameter with keys  and  . Pressing the key once increments or decrements the value. Holding the key down changes the value faster. Pressing the keys simultaneously replaces the displayed value with the default value.	<pre> LOC ↺ PAR EDIT ——— 9902 APPLIC MACRO 3-WIRE [2] CANCEL 00:00 SAVE </pre>
6.	<ul style="list-style-type: none"> • To save the new value, press . • To cancel the new value and keep the original, press . 	<pre> LOC ↺ PARAMETERS ——— 9901 LANGUAGE 9902 APPLIC MACRO 3-WIRE 9904 MOTOR CTRL MODE 9905 MOTOR NOM VOLT EXIT 00:00 EDIT </pre>

How to select the monitored signals

Step	Action	Display
1.	<p>You can select which signals are monitored in the Output mode and how they are displayed with group 34 PANEL DISPLAY parameters. See page 74 for detailed instructions on changing parameter values.</p> <p>By default, the display shows three signals. The particular default signals depend on the value of parameter 9902 APPLIC MACRO: For macros whose default value of parameter 9904 MOTOR CTRL MODE is 1 (VECTOR:SPEED), the default for signal 1 is 0102 SPEED, otherwise 0103 OUTPUT FREQ. The defaults for signals 2 and 3 are always 0104 CURRENT and 0105 TORQUE, respectively.</p> <p>To change the default signals, select up to three signals from group 01 OPERATING DATA to be shown.</p> <p>Signal 1: Change the value of parameter 3401 SIGNAL1 PARAM to the index of the signal parameter in group 01 OPERATING DATA (= number of the parameter without the leading zero), e.g. 105 means parameter 0105 TORQUE. Value 0 means that no signal is displayed.</p> <p>Repeat for signals 2 (3408 SIGNAL2 PARAM) and 3 (3415 SIGNAL3 PARAM).</p>	<div style="border: 1px solid black; padding: 2px;"> LOC ↺ PAR EDIT ——— 3401 SIGNAL1 PARAM OUTPUT FREQ [103] CANCEL 00:00 SAVE </div> <div style="border: 1px solid black; padding: 2px;"> LOC ↺ PAR EDIT ——— 3408 SIGNAL2 PARAM CURRENT [104] CANCEL 00:00 SAVE </div> <div style="border: 1px solid black; padding: 2px;"> LOC ↺ PAR EDIT ——— 3415 SIGNAL3 PARAM TORQUE [105] CANCEL 00:00 SAVE </div>
2.	<p>Select how you want the signals to be displayed: as a decimal number or a bar graph. For decimal numbers, you can specify the decimal point location, or use the decimal point location and unit of the source signal [setting (9 (DIRECT))]. For details, see parameter 3404.</p> <p>Signal 1: parameter 3404 OUTPUT1 DSP FORM Signal 2: parameter 3411 OUTPUT2 DSP FORM Signal 3: parameter 3418 OUTPUT3 DSP FORM.</p>	<div style="border: 1px solid black; padding: 2px;"> LOC ↺ PAR EDIT ——— 3404 OUTPUT1 DSP FORM DIRECT [9] CANCEL 00:00 SAVE </div>
3.	<p>Select the units to be displayed for the signals. This has no effect if parameter 3404/3411/3418 is set to 9 (DIRECT). For details, see parameter 3405.</p> <p>Signal 1: parameter 3405 OUTPUT1 UNIT Signal 2: parameter 3412 OUTPUT2 UNIT Signal 3: parameter 3419 OUTPUT3 UNIT.</p>	<div style="border: 1px solid black; padding: 2px;"> LOC ↺ PAR EDIT ——— 3405 OUTPUT1 UNIT HZ [3] CANCEL 00:00 SAVE </div>
4.	<p>Select the scalings for the signals by specifying the minimum and maximum display values. This has no effect if parameter 3404/3411/3418 is set to 9 (DIRECT). For details, see parameters 3406 and 3407.</p> <p>Signal 1: parameters 3406 OUTPUT1 MIN and 3407 OUTPUT1 MAX Signal 2: parameters 3413 OUTPUT2 MIN and 3414 OUTPUT2 MAX Signal 3: parameters 3420 OUTPUT3 MIN and 3421 OUTPUT3 MAX.</p>	<div style="border: 1px solid black; padding: 2px;"> LOC ↺ PAR EDIT ——— 3406 OUTPUT1 MIN 0.0 HZ CANCEL 00:00 SAVE </div> <div style="border: 1px solid black; padding: 2px;"> LOC ↺ PAR EDIT ——— 3407 OUTPUT1 MAX 500.0 HZ CANCEL 00:00 SAVE </div>

Assistants mode

















When the drive is first powered up, the Start-up Assistant guides you through the setup of the basic parameters. The Start-up Assistant is divided into assistants, each of which is responsible for the specification of a related parameter set, for example Motor Set-up or PID Control. The Start-up Assistant activates the assistants one after the other. You may also use the assistants independently. For more information on the tasks of the assistants, see section [Start-up Assistant](#) on page 95.



In the Assistants mode, you can:

- use assistants to guide you through the specification of a set of basic parameters
- start, stop, change the direction and switch between local and remote control.

How to use an assistant

The table below shows the basic operation sequence which leads you through assistants. The Motor Set-up Assistant is used as an example.

Step	Action	Display
1.	Go to the Main menu by pressing  if you are in the Output mode, otherwise by pressing  repeatedly until you get to the Main menu.	<pre> LOC ↺ MAIN MENU ——— 1 PARAMETERS ASSISTANTS CHANGED PAR EXIT 00:00 ENTER </pre>
2.	Go to the Assistants mode by selecting ASSISTANTS on the menu with keys  and  , and pressing  .	<pre> LOC ↺ ASSISTANTS ——— 1 Start-up assistant Motor Set-up Application Speed control EXT1 Speed control EXT2 EXIT 00:00 SEL </pre>
3.	Select the assistant with keys  and  , and press  . If you select any other assistant than the Start-up Assistant, it guides you through the task of specification of its parameter set as shown in steps 4. and 5. below. After that you can select another assistant on the Assistants menu or exit the Assistants mode. The Motor Set-up Assistant is used here as an example. If you select the Start-up Assistant, it activates the first assistant, which guides you through the task of specification of its parameter set as shown in steps 4. and 5. below. The Start-up Assistant then asks if you want to continue with the next assistant or skip it – select the appropriate answer with keys  and  , and press  . If you choose to skip, the Start-up Assistant asks the same question about the next assistant, and so on.	<pre> LOC ↺ PAR EDIT ——— 9905 MOTOR NOM VOLT 220 V EXIT 00:00 SAVE </pre> <pre> LOC ↺ CHOICE ——— Do you want to continue with application setup? continue Skip EXIT 00:00 OK </pre>
4.	<ul style="list-style-type: none"> • To specify a new value, press keys  and . • To ask for information on the requested parameter, press key . Scroll the help text with keys  and . Close the help by pressing . 	<pre> LOC ↺ PAR EDIT ——— 9905 MOTOR NOM VOLT 240 V EXIT 00:00 SAVE </pre> <pre> LOC ↺ HELP ——— Set as given on the motor nameplate. Voltage value must correspond to motor D/Y connection. EXIT 00:00 </pre>













Step	Action	Display
5.	<ul style="list-style-type: none"> To accept the new value and continue to the setting of the next parameter, press . To stop the assistant, press . 	<pre> LOC ↺ PAR EDIT ——— 9906 MOTOR NOM CURR 1.2 A EXIT 00:00 SAVE </pre>

Changed Parameters mode

In the Changed Parameters mode, you can:

- view a list of all parameters that have been changed from the macro default values
- change these parameters
- start, stop, change the direction and switch between local and remote control.

How to view and edit changed parameters













Step	Action	Display
1.	Go to the Main menu by pressing  if you are in the Output mode, otherwise by pressing  repeatedly until you get to the Main menu.	<pre> LOC ↺ MAIN MENU ——— 1 PARAMETERS ASSISTANTS CHANGED PAR EXIT 00:00 ENTER </pre>
2.	Go to the Changed Parameters mode by selecting CHANGED PAR on the menu with keys  and  , and pressing  .	<pre> LOC ↺ CHANGED PAR ——— 1202 CONST SPEED 1 10.0 Hz 1203 CONST SPEED 2 1204 CONST SPEED 3 9902 APPLIC MACRO EXIT 00:00 EDIT </pre>
3.	Select the changed parameter on the list with keys  and  . The value of the selected parameter is shown below it. Press  to modify the value.	<pre> LOC ↺ PAR EDIT ——— 1202 CONST SPEED 1 10.0 Hz CANCEL 00:00 SAVE </pre>
4.	Specify a new value for the parameter with keys  and  . Pressing the key once increments or decrements the value. Holding the key down changes the value faster. Pressing the keys simultaneously replaces the displayed value with the default value.	<pre> LOC ↺ PAR EDIT ——— 1202 CONST SPEED 1 15.0 Hz CANCEL 00:00 SAVE </pre>
5.	<ul style="list-style-type: none"> To accept the new value, press . If the new value is the default value, the parameter is removed from the list of changed parameters. To cancel the new value and keep the original, press . 	<pre> LOC ↺ CHANGED PAR ——— 1202 CONST SPEED 1 15.0 Hz 1203 CONST SPEED 2 1204 CONST SPEED 3 9902 APPLIC MACRO EXIT 00:00 EDIT </pre>

Fault Logger mode

In the Fault Logger mode, you can:

- view the drive fault history of maximum ten faults (after a power off, only the three latest faults are kept in the memory)
- see the details of the three latest faults (after a power off, the details of only the most recent fault is kept in the memory)
- read the help text for the fault
- start, stop, change the direction and switch between local and remote control.

How to view faults

Step	Action	Display
1.	Go to the Main menu by pressing  if you are in the Output mode, otherwise by pressing  repeatedly until you get to the Main menu.	<pre> LOC ↵ MAIN MENU ——— 1 PARAMETERS ASSISTANTS CHANGED PAR EXIT 00:00 ENTER </pre>
2.	Go to the Fault Logger mode by selecting FAULT LOGGER on the menu with keys  and  , and pressing  . The display shows the fault log starting with the latest fault. The number on the row is the fault code according to which the causes and corrective actions are listed in chapter Fault tracing .	<pre> LOC ↵ FAULT LOG ——— 10: PANEL LOSS 19.03.05 13:04:57 6: DC UNDERVOLT 6: AI1 LOSS EXIT 00:00 DETAIL </pre>
3.	To see the details of a fault, select it with keys  and  , and press  .	<pre> LOC ↵ PANEL LOSS ——— FAULT 10 FAULT TIME 1 13:04:57 FAULT TIME 2 EXIT 00:00 DIAG </pre>
4.	To show the help text, press  . Scroll the help text with keys  and  . After reading the help, press  to return to the previous display.	<pre> LOC ↵ DIAGNOSTICS ——— Check: Comm lines and connections, parameter 3002, parameters in groups 10 and 11. EXIT 00:00 OK </pre>

















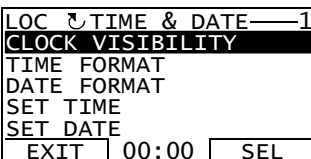





Time and Date mode









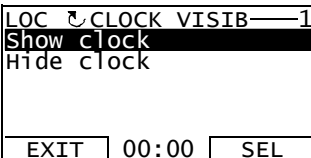
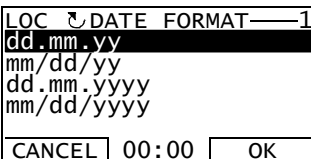
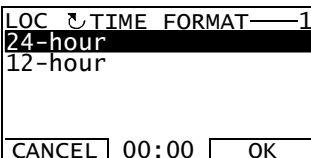
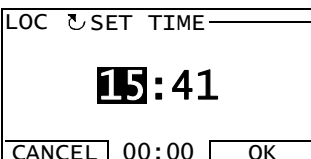



In the Time and Date mode, you can:

- show or hide the clock
- change date and time display formats
- set the date and time
- enable or disable automatic clock transitions according to the daylight saving changes
- start, stop, change the direction and switch between local and remote control.

The Assistant Control Panel contains a battery to ensure the function of the clock when the panel is not powered by the drive.

How to show or hide the clock, change display formats, set the date and time and enable or disable clock transitions due to daylight saving changes

Step	Action	Display
1.	Go to the Main menu by pressing  if you are in the Output mode, otherwise by pressing  repeatedly until you get to the Main menu.	
2.	Go to the Time and Date mode by selecting TIME & DATE on the menu with keys  and  , and pressing  .	
3.	<ul style="list-style-type: none"> • To show (hide) the clock, select CLOCK VISIBILITY on the menu, press , select Show clock (Hide clock) and press , or, if you want to return to the previous display without making changes, press . • To specify the date format, select DATE FORMAT on the menu, press  and select a suitable format. Press  to save or  to cancel your changes. • To specify the time format, select TIME FORMAT on the menu, press  and select a suitable format. Press  to save or  to cancel your changes. • To set the time, select SET TIME on the menu and press . Specify the hours with keys  and , and press . Then specify the minutes. Press  to save or  to cancel your changes. 	   

Step	Action	Display
	<ul style="list-style-type: none"> To set the date, select SET DATE on the menu and press . Specify the first part of the date (day or month depending on the selected date format) with keys  and , and press . Repeat for the second part. After specifying the year, press . To cancel your changes, press . To enable or disable the automatic clock transitions according to the daylight saving changes, select DAYLIGHT SAVING on the menu and press . Pressing  opens the help that shows the beginning and end dates of the period during which daylight saving time is used in each country or area whose daylight saving changes you can select to be followed. To disable automatic clock transitions according to the daylight saving changes, select Off and press . To enable automatic clock transitions, select the country or area whose daylight saving changes are followed and press . To return to the previous display without making changes, press . 	<div data-bbox="1082 309 1394 470"> <p>LOC  SET DATE</p> <p>19.03.05</p> <p>CANCEL 00:00 OK</p> </div> <div data-bbox="1082 481 1394 638"> <p>LOC DAYLIGHT SAV—1</p> <p>Off</p> <p>EU</p> <p>US</p> <p>Australia1:NSW,Vict..</p> <p>Australia2:Tasmania..</p> <p>EXIT 00:00 SEL</p> </div> <div data-bbox="1082 649 1394 806"> <p>LOC HELP</p> <p>EU:</p> <p>On: Mar last Sunday</p> <p>Off: Oct last Sunday</p> <p>US:</p> <p>EXIT 00:00 </p> </div>

Parameter Backup mode

The Parameter Backup mode is used to export parameters from one drive to another or to make a backup of the drive parameters. Uploading to the panel stores all drive parameters, including up to three user sets, to the Assistant Control Panel. The full set, partial parameter set (application) and user sets can then be downloaded from the control panel to another drive or the same drive.

The control panel memory is non-volatile and does not depend on the panel battery.

In the Parameter Backup mode, you can:

- Copy all parameters from the drive to the control panel (UPLOAD TO PANEL). This includes all defined user sets of parameters and internal (not adjustable by the user) parameters such as those created by the ID Run.
- View the information about the backup stored to the control panel with UPLOAD TO PANEL (BACKUP INFO). This includes e.g. the type and rating of the drive where the backup was made. It is useful to check this information when you are going to copy the parameters to another drive with DOWNLOAD FULL SET to ensure that the drives match.
- Restore the full parameter set from the control panel to the drive (DOWNLOAD FULL SET). This writes all parameters, including the internal non-user-adjustable motor parameters, to the drive. It does not include the user sets of parameters.

Note: Only use this function to restore a drive from a backup or to transfer parameters to systems that are identical to the original system.

- Copy a partial parameter set (part of the full set) from the control panel to a drive (DOWNLOAD APPLICATION). The partial set does not include user sets, internal motor parameters, parameters [9905...9909](#), [1605](#), [1607](#), [5201](#), nor any group [51 EXT COMM MODULE](#) and [53 EFB PROTOCOL](#) parameters.

The source and target drives and their motor sizes do not need to be the same.















- Copy USER S1 parameters from the control panel to the drive (DOWNLOAD USER SET1). A user set includes group [99 START-UP DATA](#) parameters and the internal motor parameters.

The function is only shown on the menu when User Set 1 has been first saved using parameter [9902 APPLIC MACRO](#) (see section [User macros](#) on page [94](#)) and then uploaded to the control panel with UPLOAD TO PANEL.











- Copy USER S2 parameters from the control panel to the drive (DOWNLOAD USER SET2). As DOWNLOAD USER SET1 above.
- Copy USER S3 parameters from the control panel to the drive (DOWNLOAD USER SET3). As DOWNLOAD USER SET1 above.
- Start, stop, change the direction and switch between local and remote control.

How to upload and download parameters

For the upload and download functions available, see above.

Step	Action	Display
1.	Go to the Main menu by pressing  if you are in the Output mode, otherwise by pressing  repeatedly until you get to the Main menu.	<pre> LOC MAIN MENU 1 PARAMETERS ASSISTANTS CHANGED PAR EXIT 00:00 ENTER </pre>
2.	Go to the Par Backup mode by selecting PAR BACKUP on the menu with keys  and  , and pressing  .	<pre> LOC PAR BACKUP 1 UPLOAD TO PANEL BACKUP INFO DOWNLOAD FULL SET DOWNLOAD APPLICATION DOWNLOAD USER SET1 EXIT 00:00 SEL </pre>
3.	<p>• To copy all parameters (including user sets and internal parameters) from the drive to the control panel, select UPLOAD TO PANEL on the Par Backup with keys  and , and press . During the transfer, the display shows the transfer status as a percentage of completion. Press  if you want to stop the operation.</p> <p>After the upload is completed, the display shows a message about the completion. Press  to return to the Par Backup.</p> <p>• To perform downloads, select the appropriate operation (here DOWNLOAD FULL SET is used as an example) on the Par Backup with keys  and , and press . The display shows the transfer status as a percentage of completion. Press  if you want to stop the operation.</p> <p>After the download is completed, the display shows a message about the completion. Press  to return to the Par Backup.</p>	<pre> LOC PAR BACKUP Copying parameters ██████████ 50% ABORT 00:00 LOC MESSAGE Parameter upload successful OK 00:00 LOC PAR BACKUP Downloading parameters (full set) ██████████ 50% ABORT 00:00 LOC MESSAGE Parameter download successfully completed. OK 00:00 </pre>

How to view information about the backup















Step	Action	Display
1.	Go to the Main menu by pressing  if you are in the Output mode, otherwise by pressing  repeatedly until you get to the Main menu.	<pre> LOC MAIN MENU 1 PARAMETERS ASSISTANTS CHANGED PAR EXIT 00:00 ENTER </pre>
2.	Go to the Par Backup mode by selecting PAR BACKUP on the menu with keys  and  , and pressing  .	<pre> LOC PAR BACKUP 1 UPLOAD TO PANEL BACKUP INFO DOWNLOAD FULL SET DOWNLOAD APPLICATION DOWNLOAD USER SET1 EXIT 00:00 SEL </pre>
3.	<p>Select BACKUP INFO on the Par Backup with keys  and , and press . The display shows the following information about the drive where the backup was made:</p> <p>DRIVE TYPE: type of the drive DRIVE RATING: rating of the drive in format XXXYZ, where XXX: Nominal current rating. If present an "A" indicates a decimal point, e.g. 4A6 means 4.6 A. Y: 2 = 200 V 4 = 400 V 6 = 600 V z: i = European loading package n = US loading package FIRMWARE: firmware version of the drive.</p> <p>You can scroll the information with keys  and .</p>	<pre> LOC BACKUP INFO DRIVE TYPE ACS350 3304 DRIVE RATING 2A41i 3301 FIRMWARE EXIT 00:00 </pre> <pre> LOC BACKUP INFO ACS350 3304 DRIVE RATING 2A41i 3301 FIRMWARE 241A hex EXIT 00:00 </pre>
4.	Press  to return to the Par Backup.	<pre> LOC PAR BACKUP 1 UPLOAD TO PANEL BACKUP INFO DOWNLOAD FULL SET DOWNLOAD APPLICATION DOWNLOAD USER SET1 EXIT 00:00 SEL </pre>

I/O Settings mode

In the I/O Settings mode, you can:

- check the parameter settings related to any I/O terminal
- edit the parameter setting. For example, if “1103: REF1” is listed under Ain1 (Analog input 1), that is, parameter **1103** REF1 SELECT has value AI1, you can change its value to e.g. AI2. You cannot, however, set the value of parameter **1106** REF2 SELECT to AI1.
- start, stop, change the direction and switch between local and remote control.

How to edit and change parameter settings related to I/O terminals

Step	Action	Display
1.	Go to the Main menu by pressing  if you are in the Output mode, otherwise by pressing  repeatedly until you get to the Main menu.	<pre> LOC ↻ MAIN MENU ——— 1 PARAMETERS ASSISTANTS CHANGED PAR EXIT 00:00 ENTER </pre>
2.	Go the I/O Settings mode by selecting I/O SETTINGS on the menu with keys  and  , and pressing  .	<pre> LOC ↻ I/O SETTINGS ——— 1 DIGITAL INPUTS (DI) ANALOG INPUTS (AI) RELAY OUTPUTS (ROUT) ANALOG OUTPUTS (AOUT) PANEL EXIT 00:00 SEL </pre>
3.	Select the I/O group, e.g. DIGITAL INPUTS, with keys  and  , and press  . After a brief pause, the display shows the current settings for the selection.	<pre> LOC ↻ SHOW I/O ——— 1 -DI1- 1001:START/STOP (E1) -DI2- — -DI3- EXIT 00:00 </pre>
4.	Select the setting (line with a parameter number) with keys  and  , and press  .	<pre> LOC ↻ PAR EDIT ——— 1001 EXT1 COMMANDS DI1 [1] CANCEL 00:00 SAVE </pre>
5.	Specify a new value for the setting with keys  and  . Pressing the key once increments or decrements the value. Holding the key down changes the value faster. Pressing the keys simultaneously replaces the displayed value with the default value.	<pre> LOC ↻ PAR EDIT ——— 1001 EXT1 COMMANDS DI1,2 [2] CANCEL 00:00 SAVE </pre>
6.	<ul style="list-style-type: none"> • To save the new value, press . • To cancel the new value and keep the original, press . 	<pre> LOC ↻ SHOW I/O ——— 1 -DI1- 1001:START/STOP (E1) -DI2- 1001:DIR (E1) -DI3- EXIT 00:00 </pre>

Application macros

What this chapter contains

The chapter describes the application macros. For each macro, there is a wiring diagram showing the default control connections (digital and analog I/O). The chapter also explains how to save a user macro and how to recall it.

Overview of macros

Application macros are preprogrammed parameter sets. While starting up the drive, the user typically selects one of the macros - the one that is best suited for the purpose - with parameter [9902 APPLIC MACRO](#), makes the essential changes and saves the result as a user macro.

The ACS350 has seven standard macros and three user macros. The table below contains a summary of the macros and describes suitable applications.

Macro	Suitable applications
ABB Standard	Ordinary speed control applications where no, one, two or three constant speeds are used. Start/stop is controlled with one digital input (level start and stop). It is possible to switch between two acceleration and deceleration times.
3-wire	Ordinary speed control applications where no, one, two or three constant speeds are used. The drive is started and stopped with push buttons.
Alternate	Speed control applications where no, one, two or three constant speeds are used. Start, stop and direction are controlled by two digital inputs (combination of the input states determines the operation).
Motor Potentiometer	Speed control applications where no or one constant speed is used. The speed is controlled by two digital inputs (increase / decrease / keep unchanged).
Hand/Auto	Speed control applications where switching between two control devices is needed. Some control signal terminals are reserved to one device, the rest for the other. One digital input selects between the terminals (devices) in use.
PID Control	Process control applications, e.g. different closed loop control systems such as pressure control, level control and flow control. It is possible to switch between process and speed control: Some control signal terminals are reserved for process control, others for speed control. One digital input selects between process and speed control.
Torque Control	Torque control applications. It is possible to switch between torque and speed control: Some control signal terminals are reserved to torque control, others for speed control. One digital input selects between torque and speed control.
User	The user can save the customised standard macro, i.e. the parameter settings including group 99 START-UP DATA , and the results of the motor identification run into the permanent memory, and recall the data at a later time. For example, three user macros can be used when switching between three different motors is required.

Summary of I/O connections of application macros

The following table gives the summary of the default I/O connections of all application macros.

Input/output	Macro						
	ABB Standard	3-wire	Alternate	Motor Potentiom.	Hand/Auto	PID Control	Torque Control
A11 (0...10 V)	Freq. ref.	Speed ref.	Speed ref.	-	Speed ref. (Hand)	Speed ref. (Hand) / Proc. ref. (PID)	Speed ref. (Speed)
A12 (0...20 mA)	-	-	-	-	Speed ref. (Auto)	Process value	Torque ref. (Torque)
AO	Output freq.	Speed	Speed	Speed	Speed	Speed	Speed
D11	Stop/Start	Start (pulse)	Start (fwd)	Stop/Start	Stop/Start (Hand)	Stop/Start (Hand)	Stop/Start (Speed)
D12	Fwd/Rev	Stop (pulse)	Start (rev)	Fwd/Rev	Fwd/Rev (Hand)	Hand/PID	Fwd/Rev
D13	Const. speed input 1	Fwd/Rev	Const. speed input 1	Speed ref. up	Hand/Auto	Const. speed 1	Speed/Torque
D14	Const. speed input 2	Const. speed input 1	Const. speed input 2	Speed ref. down	Fwd/Rev (Auto)	Run enable	Const. speed 1
D15	Ramp pair selection	Const. speed input 2	Ramp pair selection	Const. speed 1	Stop/Start (Auto)	Stop/Start (PID)	Ramp pair selection
RO	Fault (-1)	Fault (-1)	Fault (-1)	Fault (-1)	Fault (-1)	Fault (-1)	Fault (-1)
DO	Fault (-1)	Fault (-1)	Fault (-1)	Fault (-1)	Fault (-1)	Fault (-1)	Fault (-1)

ABB Standard macro

This is the default macro. It provides a general purpose I/O configuration with three constant speeds. Parameter values are the default values given in chapter [Actual signals and parameters](#), starting from page 142.

If you use other than the default connections presented below, see section [I/O terminals](#) on page 40.

Default I/O connections

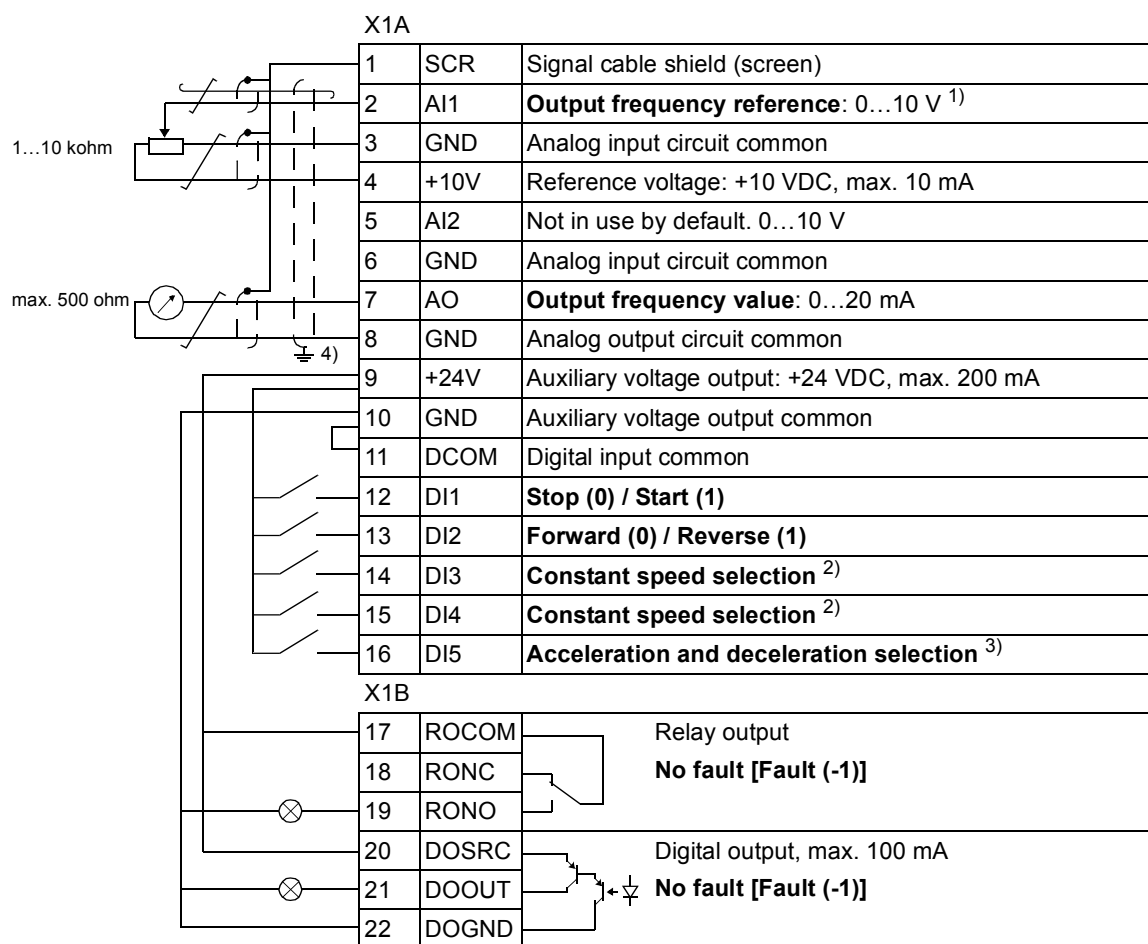

1) AI1 is used as a speed reference if vector mode is selected.

2) See parameter group [12 CONSTANT SPEEDS](#):

D13	D14	Operation (parameter)
0	0	Set speed through AI1
1	0	Speed 1 (1202)
0	1	Speed 2 (1203)
1	1	Speed 3 (1204)

3) 0 = ramp times according to parameters [2202](#) and [2203](#).

1 = ramp times according to parameters [2205](#) and [2206](#).

4) 360 degree grounding under a clamp.

Tightening torque = 0.5 N·m / 4.4 lbf. in.

3-wire macro

This macro is used when the drive is controlled using momentary push-buttons. It provides three constant speeds. To enable the macro, set the value of parameter [9902](#) to 2 (3-WIRE).

For the parameter default values, see section [Default values with different macros](#) on page [142](#). If you use other than the default connections presented below, see section [I/O terminals](#) on page [40](#).

Note: When the stop input (DI2) is deactivated (no input), the control panel start and stop buttons are disabled.

Default I/O connections

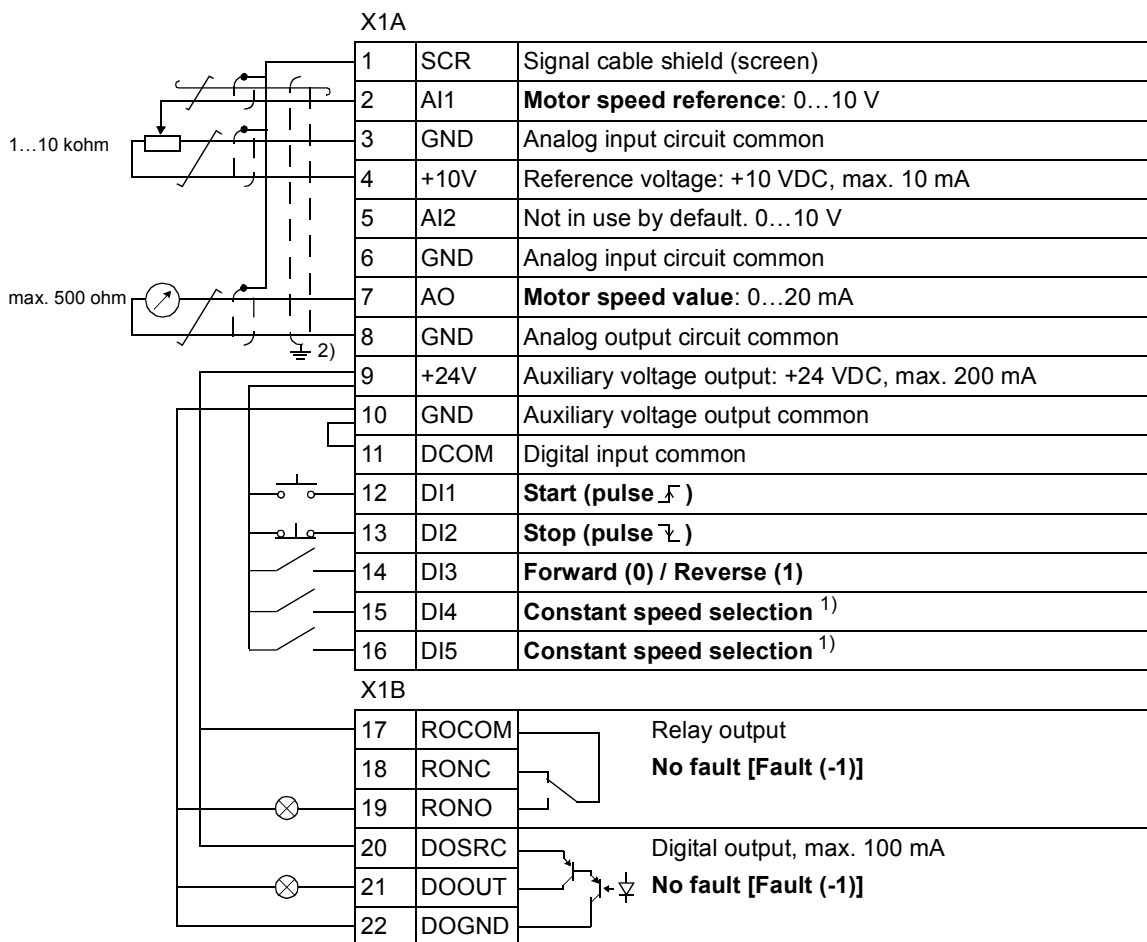

¹⁾ See parameter group [12 CONSTANT SPEEDS](#): ²⁾ 360 degree grounding under a clamp. Tightening torque = 0.5 N·m / 4.4 lbf. in.

DI3	DI4	Operation (parameter)
0	0	Set speed through AI1
1	0	Speed 1 (1202)
0	1	Speed 2 (1203)
1	1	Speed 3 (1204)

Alternate macro

This macro provides an I/O configuration adapted to a sequence of DI control signals used when alternating the rotation direction of the drive. To enable the macro, set the value of parameter [9902](#) to 3 (ALTERNATE).

For the parameter default values, see section [Default values with different macros](#) on page [142](#). If you use other than the default connections presented below, see section [I/O terminals](#) on page [40](#).

Default I/O connections

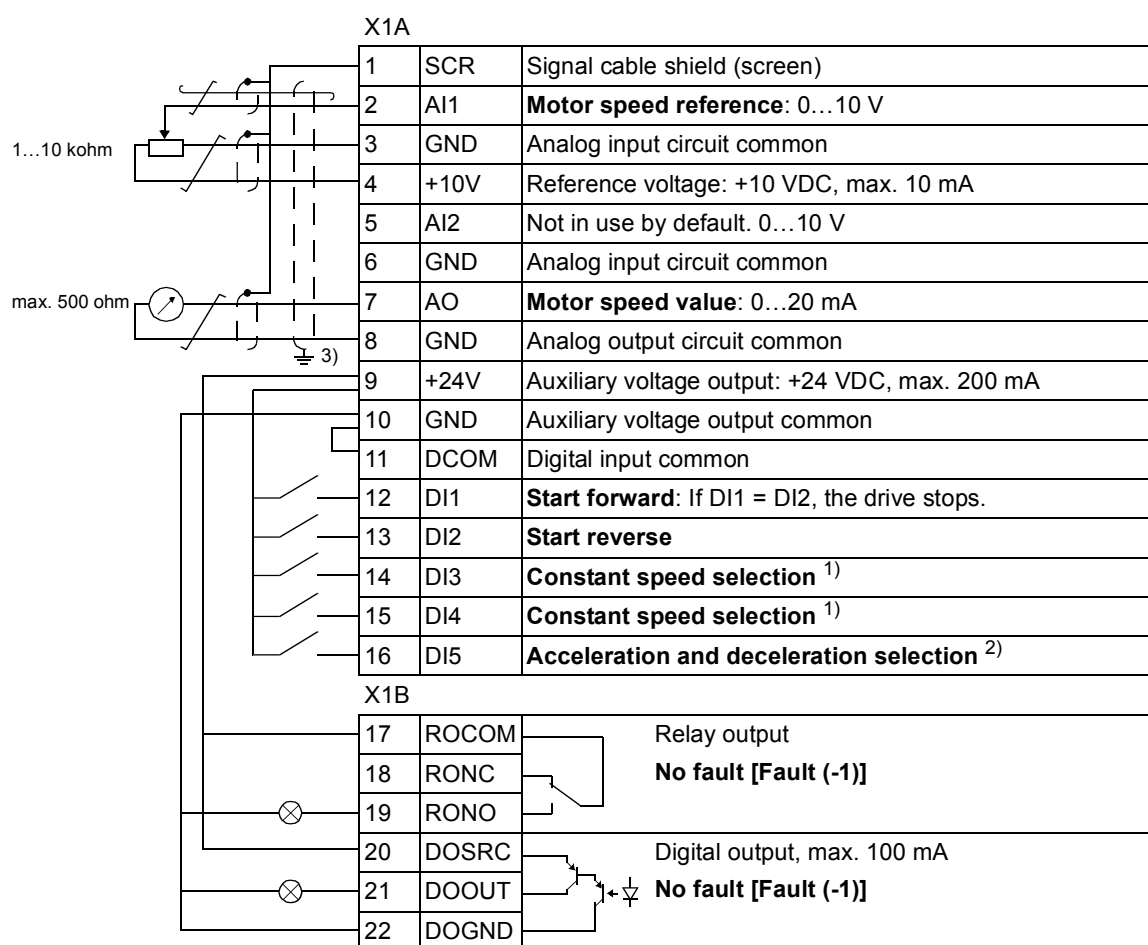

¹⁾ See parameter group [12 CONSTANT SPEEDS](#): ²⁾ 0 = ramp times according to parameters [2202](#) and [2203](#).

DI3	DI4	Operation (parameter)
0	0	Set speed through AI1
1	0	Speed 1 (1202)
0	1	Speed 2 (1203)
1	1	Speed 3 (1204)

1 = ramp times according to parameters [2205](#) and [2206](#).

³⁾ 360 degree grounding under a clamp.

Tightening torque = 0.5 N·m / 4.4 lbf. in.

Motor Potentiometer macro

This macro provides a cost-effective interface for PLCs that vary the speed of the drive using only digital signals. To enable the macro, set the value of parameter [9902](#) to 4 (MOTOR POT).

For the parameter default values, see section [Default values with different macros](#) on page [142](#). If you use other than the default connections presented below, see section [I/O terminals](#) on page [40](#).

Default I/O connections

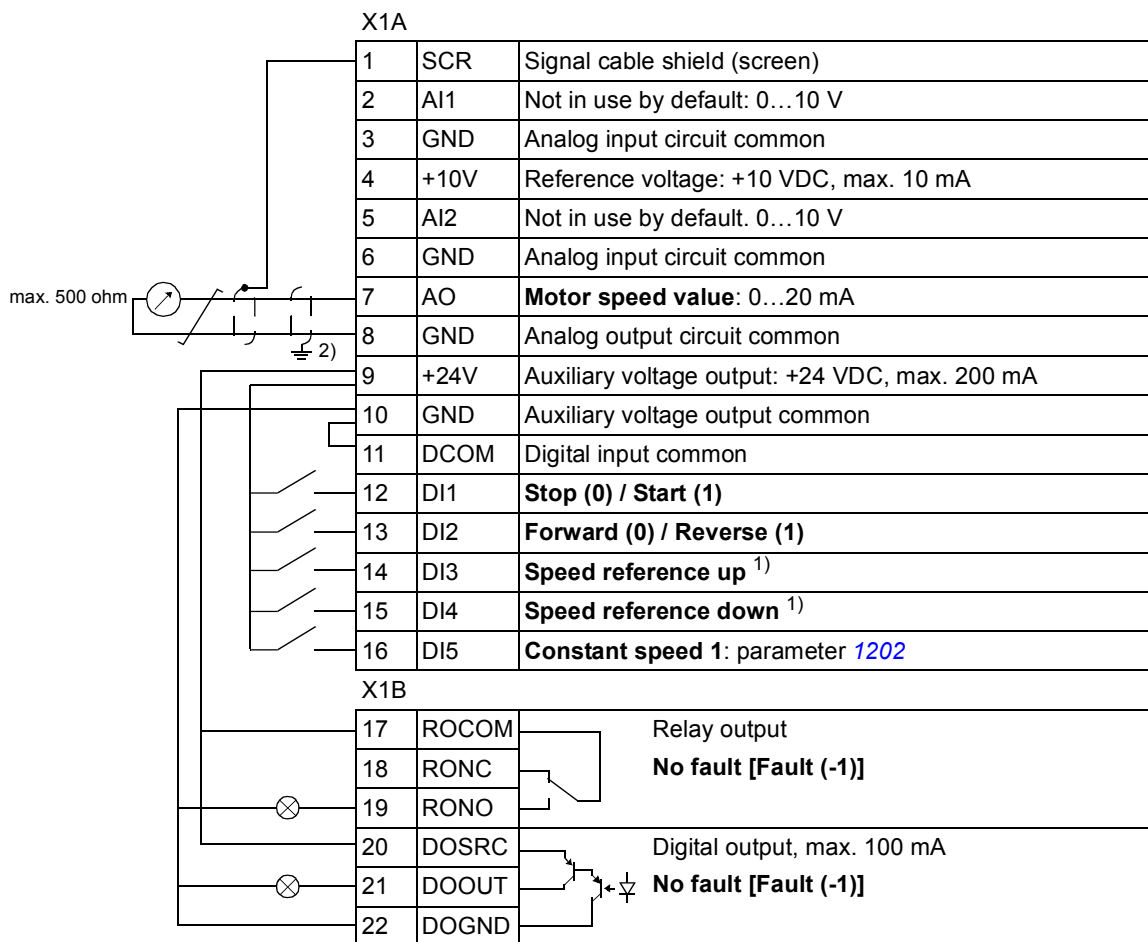

¹⁾ If DI3 and DI4 are both active or inactive, the speed reference is unchanged.

The existing speed reference is stored during stop and power down.

²⁾ 360 degree grounding under a clamp.

Tightening torque = 0.5 N·m / 4.4 lbf. in.

Hand/Auto macro

This macro can be used when switching between two external control devices is needed. To enable the macro, set the value of parameter **9902** to 5 (HAND/AUTO).

For the parameter default values, see section [Default values with different macros](#) on page [142](#). If you use other than the default connections presented below, see section [I/O terminals](#) on page [40](#).

Note: Parameter **2108** START INHIBIT must remain in the default setting 0 (OFF).

Default I/O connections

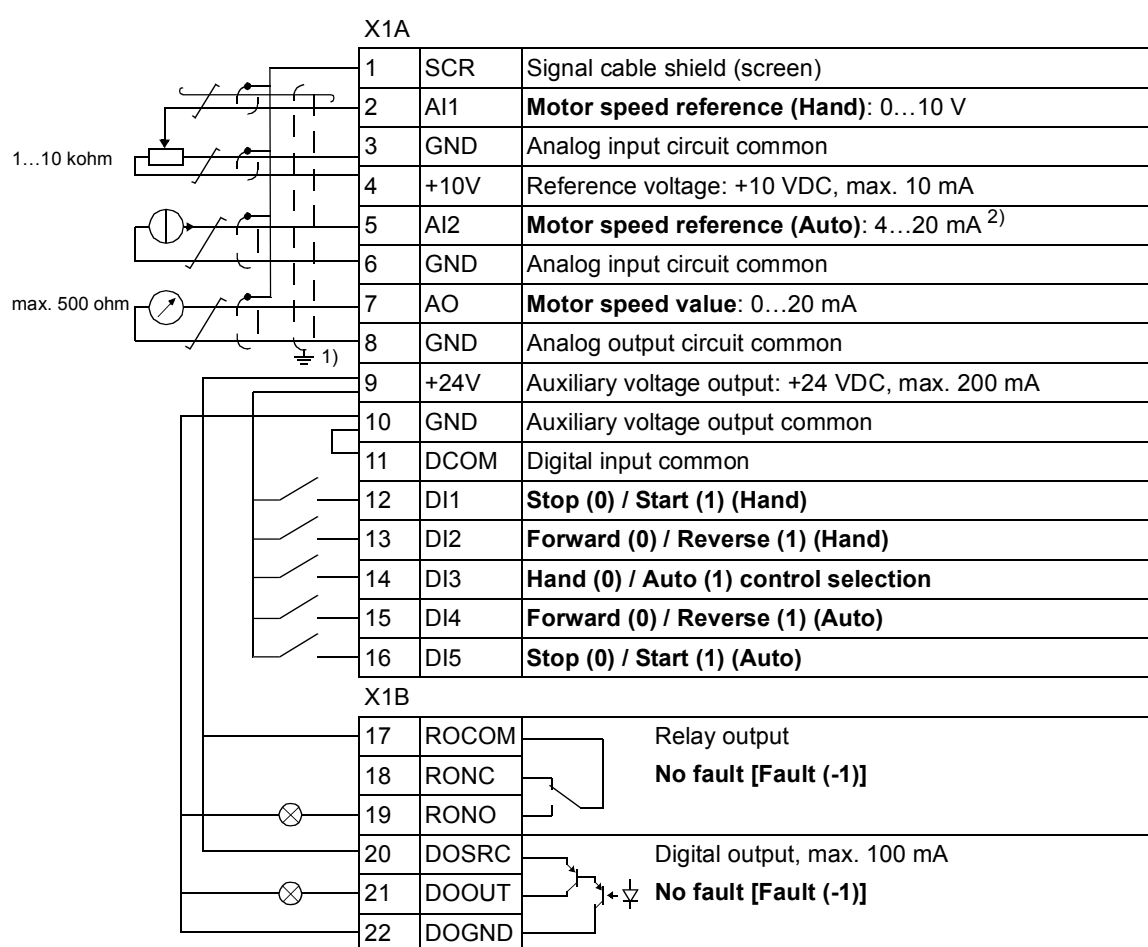

¹⁾ 360 degree grounding under a clamp.

²⁾ The signal source must be powered externally. See the manufacturer's instructions. An example of a connection using a two-wire sensor is given on page [41](#).

Tightening torque = 0.5 N·m / 4.4 lbf. in.

PID Control macro

This macro provides parameter settings for closed-loop control systems such as pressure control, flow control, etc. Control can also be switched to speed control using a digital input. To enable the macro, set the value of parameter **9902** to 6 (PID CONTROL).

For the parameter default values, see section *Default values with different macros* on page **142**. If you use other than the default connections presented below, see section *I/O terminals* on page **40**.

Note: Parameter **2108** START INHIBIT must remain in the default setting 0 (OFF).

Default I/O connections

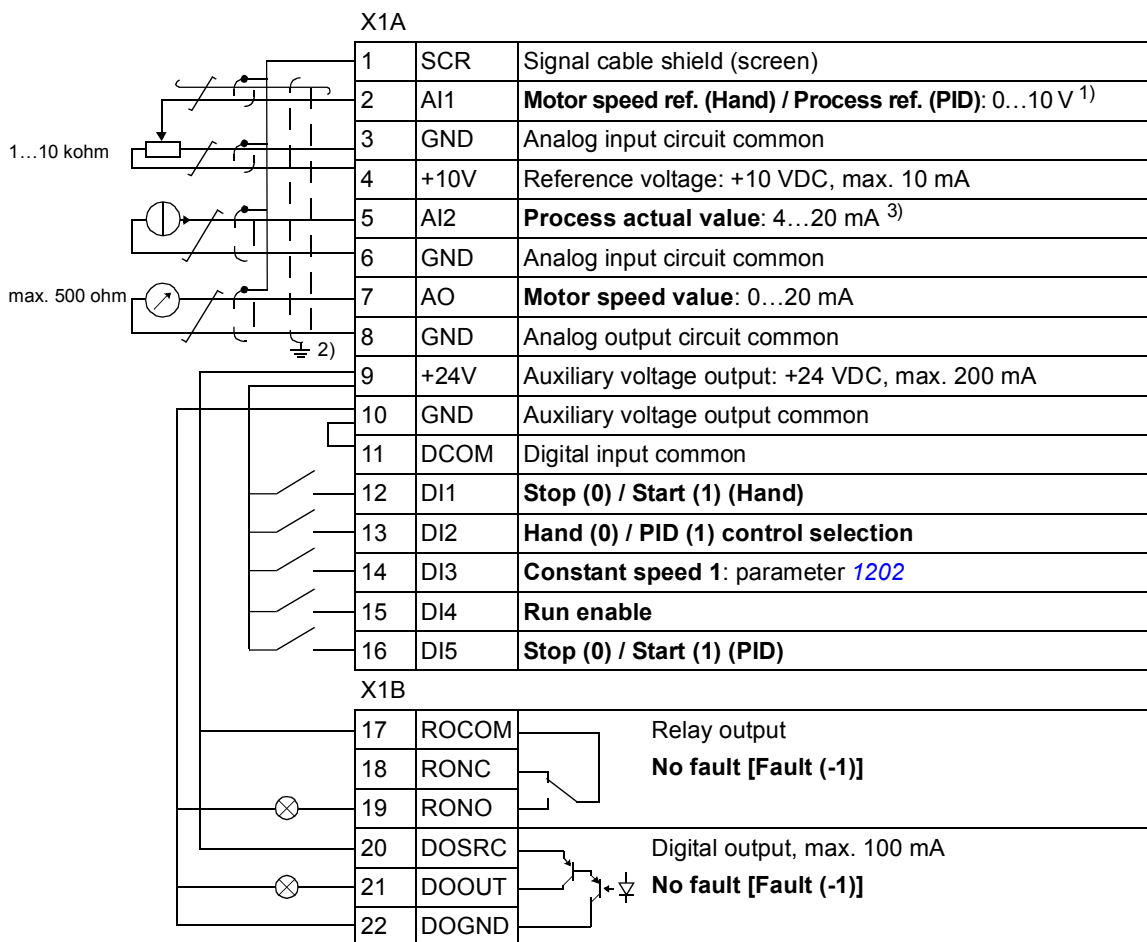

1) Hand: 0...10 V -> speed reference.
 PID: 0...10 V -> 0...100% PID setpoint.
 2) 360 degree grounding under a clamp.

3) The signal source must be powered externally. See the manufacturer's instructions. An example of a connection using a two-wire sensor is given on page **41**.

Tightening torque = 0.5 N·m / 4.4 lbf. in.

Torque Control macro

This macro provides parameter settings for applications that require torque control of the motor. Control can also be switched to speed control using a digital input. To enable the macro, set the value of parameter [9902](#) to 8 (TORQUE CTRL).

For the parameter default values, see section [Default values with different macros](#) on page [142](#). If you use other than the default connections presented below, see section [I/O terminals](#) on page [40](#).

Default I/O connections

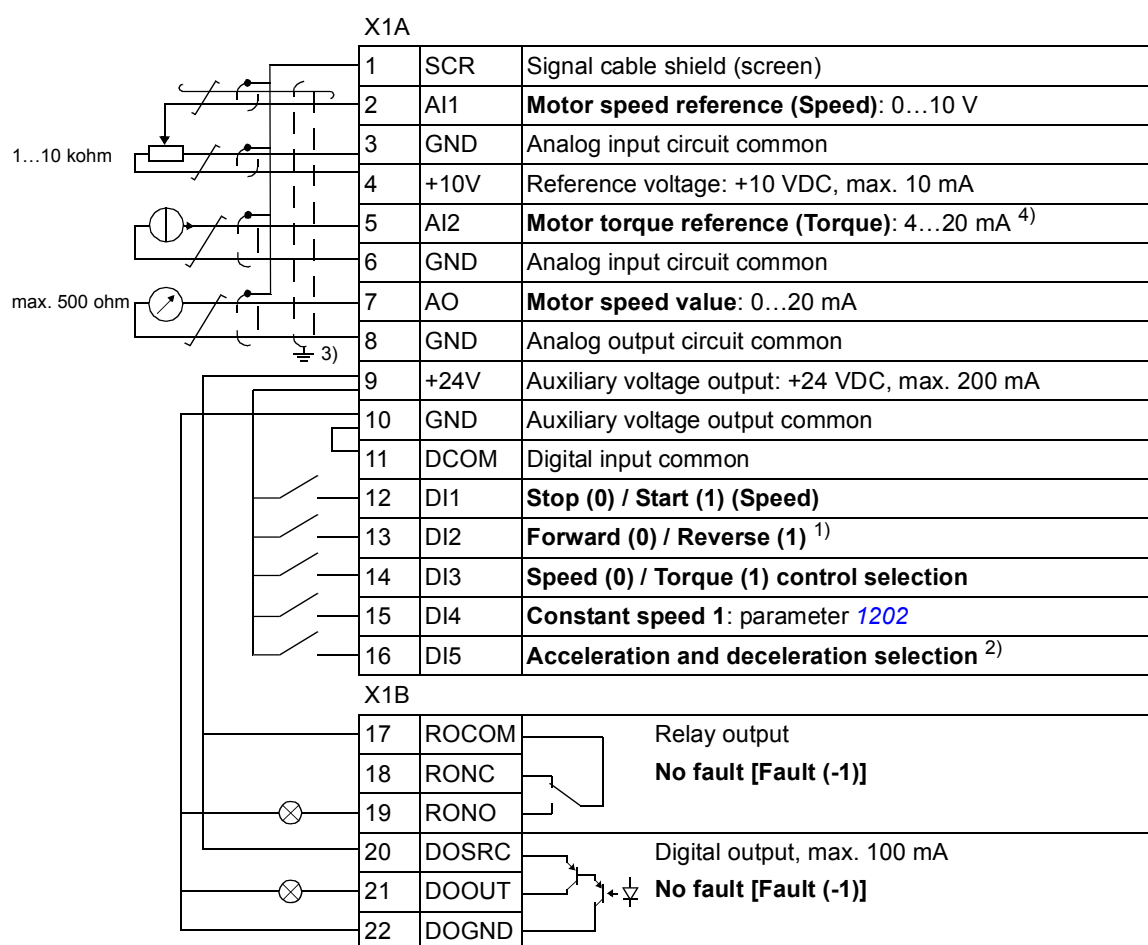

1) Speed control: Changes rotation direction.
Torque control: Changes torque direction.

2) 0 = ramp times according to parameters [2202](#) and [2203](#).
1 = ramp times according to parameters [2205](#) and [2206](#).

3) 360 degree grounding under a clamp.

4) The signal source must be powered externally. See the manufacturer's instructions. An example of a connection using a two-wire sensor is given on page [41](#).



Tightening torque = 0.5 N·m / 4.4 lbf. in.

User macros



In addition to the standard application macros, it is possible to create three user macros. The user macro allows the user to save the parameter settings, including group **99 START-UP DATA**, and the results of the motor identification into the permanent memory and recall the data at a later time. The panel reference is also saved if the macro is saved and loaded in local control. The remote control setting is saved into the user macro, but the local control setting is not.

The steps below show how to create and recall User macro 1. The procedure for the other two user macros is identical, only the parameter **9902** values are different.

To create User macro 1:

- Adjust the parameters. Perform the motor identification if it is needed in the application but it is not done yet.
- Save the parameter settings and the results of the motor identification to the permanent memory by changing parameter **9902** to -1 (USER S1 SAVE).
- Press  (Assistant Control Panel) or  (Basic Control Panel).

To recall User macro 1:

- Change parameter **9902** to 0 (USER S1 LOAD).
- Press  (Assistant Control Panel) or  (Basic Control Panel) to load.

The user macro can also be switched through digital inputs (see parameter **1605**).

Note: User macro load restores the parameter settings including group **99 START-UP DATA** and the results of the motor identification. Check that the settings correspond to the motor used.

Hint: The user can for example switch the drive between three motors without having to adjust the motor parameters and to repeat the motor identification every time the motor is changed. The user needs only to adjust the settings and perform the motor identification once for each motor and then to save the data as three user macros. When the motor is changed, only the corresponding user macro needs to be loaded, and the drive is ready to operate.

Program features

What this chapter contains

The chapter describes program features. For each feature, there is a list of related user settings, actual signals, and fault and alarm messages.

Start-up Assistant

Introduction

The Start-up Assistant (requires the Assistant Control Panel) guides the user through the start-up procedure, helping to enter the requested data (parameter values) to the drive. The Start-up Assistant also checks that the entered values are valid, i.e. within the allowed range.

The Start-up Assistant calls other assistants, each of which guides the user through the task of specifying a related parameter set. At the first start, the drive suggests entering the first task, Language Select, automatically. The user may activate the tasks either one after the other as the Start-up Assistant suggests, or independently. The user may also adjust the drive parameters in the conventional way without using the assistant at all.

See section [Assistants mode](#) on page 76 on how to start the Start-up Assistant or other assistants.

The default order of the tasks

Depending on the selection made in the Application task (parameter [9902 APPLIC MACRO](#)), the Start-up Assistant decides which consequent tasks it suggests. The default tasks are shown in the table below.

Application selection	Default tasks
ABB STANDARD	Language Select, Motor Set-up, Application, Option Modules, Speed Control EXT1, Speed Control EXT2, Start/Stop Control, Timed Functions, Protections, Output Signals
3-WIRE	Language Select, Motor Set-up, Application, Option Modules, Speed Control EXT1, Speed Control EXT2, Start/Stop Control, Timed Functions, Protections, Output Signals
ALTERNATE	Language Select, Motor Set-up, Application, Option Modules, Speed Control EXT1, Speed Control EXT2, Start/Stop Control, Timed Functions, Protections, Output Signals
MOTOR POT	Language Select, Motor Set-up, Application, Option Modules, Speed Control EXT1, Speed Control EXT2, Start/Stop Control, Timed Functions, Protections, Output Signals
HAND/AUTO	Language Select, Motor Set-up, Application, Option Modules, Speed Control EXT1, Speed Control EXT2, Start/Stop Control, Timed Functions, Protections, Output Signals
PID CONTROL	Language Select, Motor Set-up, Application, Option Modules, PID Control, Speed Control EXT2, Start/Stop Control, Timed Functions, Protections, Output Signals
TORQUE CTRL	Language Select, Motor Set-up, Application, Option Modules, Speed Control EXT2, Start/Stop Control, Timed Functions, Protections, Output Signals

List of the tasks and the relevant drive parameters

Depending on the selection made in the Application task (parameter [9902](#) APPLIC MACRO), the Start-up Assistant decides which consequent tasks it suggests.

Name	Description	Set parameters
Language Select	Selecting the language	9901
Motor Set-up	Setting the motor data Performing the motor identification. (If the speed limits are not in the allowed range: Setting the limits.)	9904...9909 9910
Application	Selecting the application macro	9902 , parameters associated to the macro
Option Modules	Activating the option modules	Group 35 MOTOR TEMP MEAS Group 52 PANEL COMM 9802
Speed Control EXT1	Selecting the source for the speed reference (If AI1 is used: Setting analog input AI1 limits, scale, inversion) Setting the reference limits Setting the speed (frequency) limits Setting the acceleration and deceleration times	1103 (1301...1303 , 3001) 1104 , 1105 2001 , 2002 , (2007 , 2008) 2202 , 2203
Speed Control EXT2	Selecting the source for the speed reference (If AI1 is used: Setting analog input AI1 limits, scale, inversion) Setting the reference limits	1106 (1301...1303 , 3001) 1107 , 1108
Torque Control	Selecting the source for the torque reference (If AI1 is used: Setting analog input AI1 limits, scale, inversion) Setting the reference limits Setting the torque ramp up and ramp down times	1106 (1301...1303 , 3001) 1107 , 1108 2401 , 2402
PID Control	Selecting the source for the process reference (If AI1 is used: Setting analog input AI1 limits, scale, inversion) Setting the reference limits Setting the speed (reference) limits Setting the source and limits for the process actual value	1106 (1301...1303 , 3001) 1107 , 1108 2001 , 2002 , (2007 , 2008) 4016 , 4018 , 4019
Start/Stop Control	Selecting the source for start and stop signals of the two external control locations, EXT1 and EXT2 Selecting between EXT1 and EXT2 Defining the direction control Defining the start and stop modes Selecting the use of Run Enable signal	1001 , 1002 1102 1003 2101...2103 1601
Timed Functions	Setting the timed functions Selecting the timed start/stop control for external control locations EXT1 and EXT2 Selecting timed EXT1/EXT2 control Activation of timed constant speed 1 Selecting timed function status indicated through relay output RO Selecting timed PID1 parameter set 1/2 control	36 TIMED FUNCTIONS 1001 , 1002 1102 1201 1401 4027
Protections	Setting the current and torque limits	2003 , 2017
Output Signals	Selecting the signals indicated through relay output RO Selecting the signals indicated through analog output AO Setting the minimum, maximum, scaling and inversion	Group 14 RELAY OUTPUTS Group 15 ANALOGUE OUTPUTS

Contents of the assistant displays

There are two types of displays in the Start-up Assistant: The main displays and the information displays. The main displays prompt the user to feed in information. The assistant steps through the main displays. The information displays contain help texts for the main displays. The figure below shows a typical example of both and explanations of the contents.

	Main display	Information display
1	LOC ↻ PAR EDIT	LOC ↻ HELP
2	9905 MOTOR NOM VOLT 240 V	Set exactly as given on the motor nameplate If connected to multiple motors
	EXIT 00:00 SAVE	EXIT 00:00
1	Parameter	Help text ...
2	Feed-in field	... help text continued

Local control vs. external control

The drive can receive start, stop and direction commands and reference values from the control panel or through digital and analog inputs. Embedded fieldbus or an optional fieldbus adapter enables control over an open fieldbus link. A PC equipped with DriveWindow Light PC tool can also control the drive.

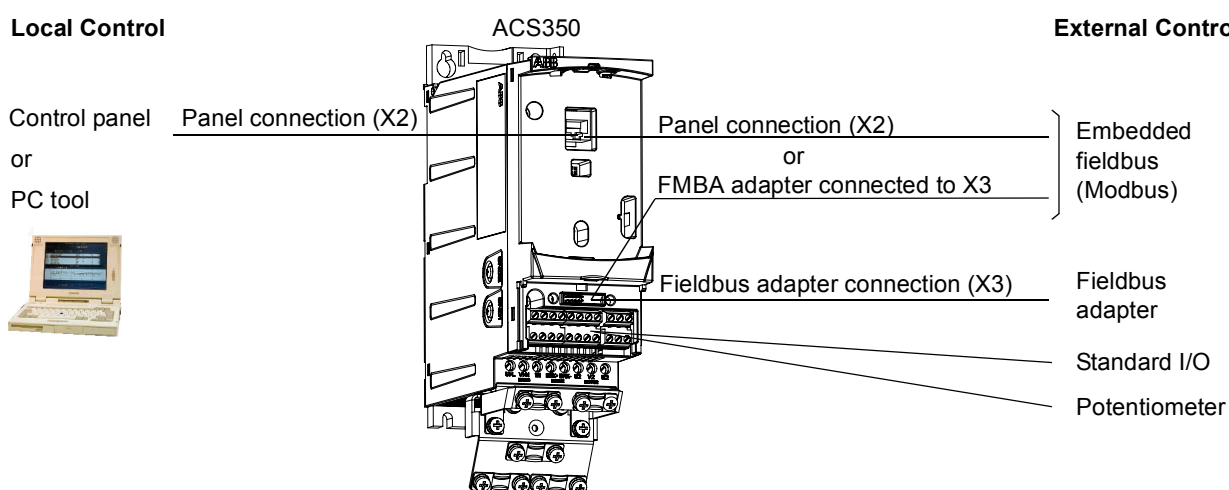

Local control

The control commands are given from the control panel keypad when the drive is in local control. LOC indicates local control on the panel display.

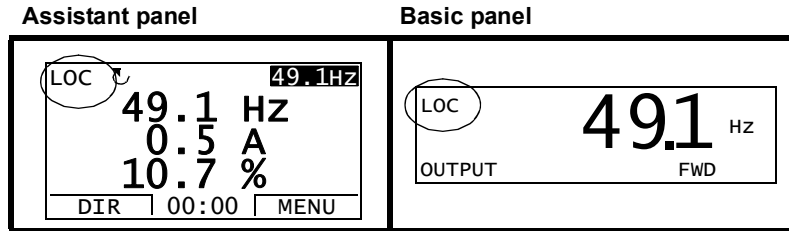

The control panel always overrides the external control signal sources when used in local mode.

External control

When the drive is in external control, the commands are given through the standard I/O terminals (digital and analog inputs) and/or the fieldbus interface. In addition, it is also possible to set the control panel as the source for the external control.

External control is indicated with REM on the panel display.

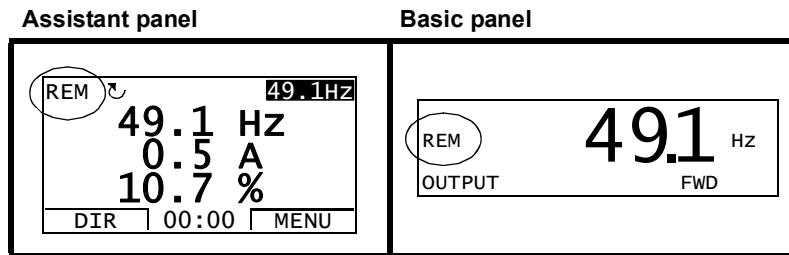

The user can connect the control signals to two external control locations, EXT1 or EXT2. Depending on the user selection, either one is active at a time. This function operates on a 2 ms time level.

Settings

Panel key	Additional information
LOC/REM	Selection between local and external control
Parameter	
1102	Selection between EXT1 and EXT2
1001/1002	Start, stop, direction source for EXT1/EXT2
1103/1106	Reference source for EXT1/EXT2

Diagnostics

Actual signals	Additional information
0111/0112	EXT1/EXT2 reference

Block diagram: Start, stop, direction source for EXT1

The figure below shows the parameters that select the interface for start, stop, and direction for external control location EXT1.

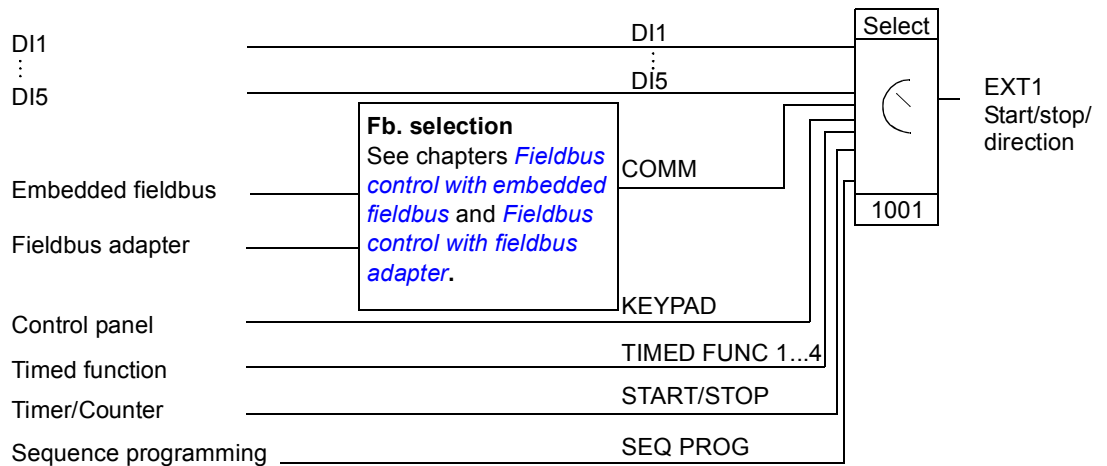

Block diagram: Reference source for EXT1

The figure below shows the parameters that select the interface for the speed reference of external control location EXT1.

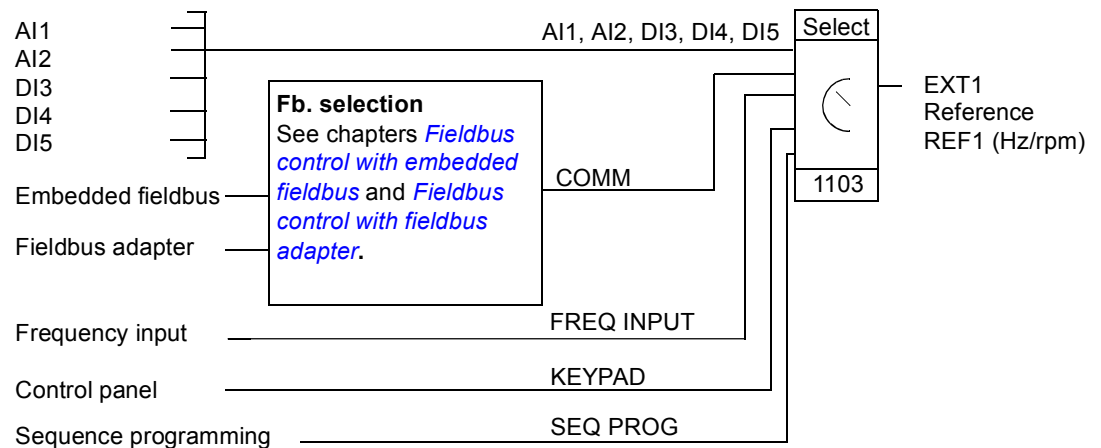

Reference types and processing

The drive can accept a variety of references in addition to the conventional analog input and control panel signals.

- The drive reference can be given with two digital inputs: One digital input increases the speed, the other decreases it.
- The drive can form a reference out of two analog input signals by using mathematical functions: Addition, subtraction, multiplication and division.
- The drive can form a reference out of an analog input signal and a signal received through a serial communication interface by using mathematical functions: Addition and multiplication.
- The drive reference can be given with frequency input.
- In external control location EXT1/2 the drive can form a reference out of an analog input signal and a signal received through sequence programming by using a mathematical function: Addition.

It is possible to scale the external reference so that the signal minimum and maximum values correspond to a speed other than the minimum and maximum speed limits.

Settings

Parameter	Additional information
Group 11 REFERENCE SELECT	External reference source, type and scaling
Group 20 LIMITS	Operating limits
Group 22 ACCEL/DECEL	Speed reference acceleration/deceleration ramps
Group 24 TORQUE CONTROL	Torque reference ramp times
Group 32 SUPERVISION	Reference supervision

Diagnostics

Actual signal	Additional information
0111/0112	REF1/REF2 reference
Group 03 FB ACTUAL SIGNALS	References in different stages of the reference processing chain

Reference trimming

In reference trimming, the external reference is corrected depending on the measured value of a secondary application variable. The block diagram below illustrates the function.

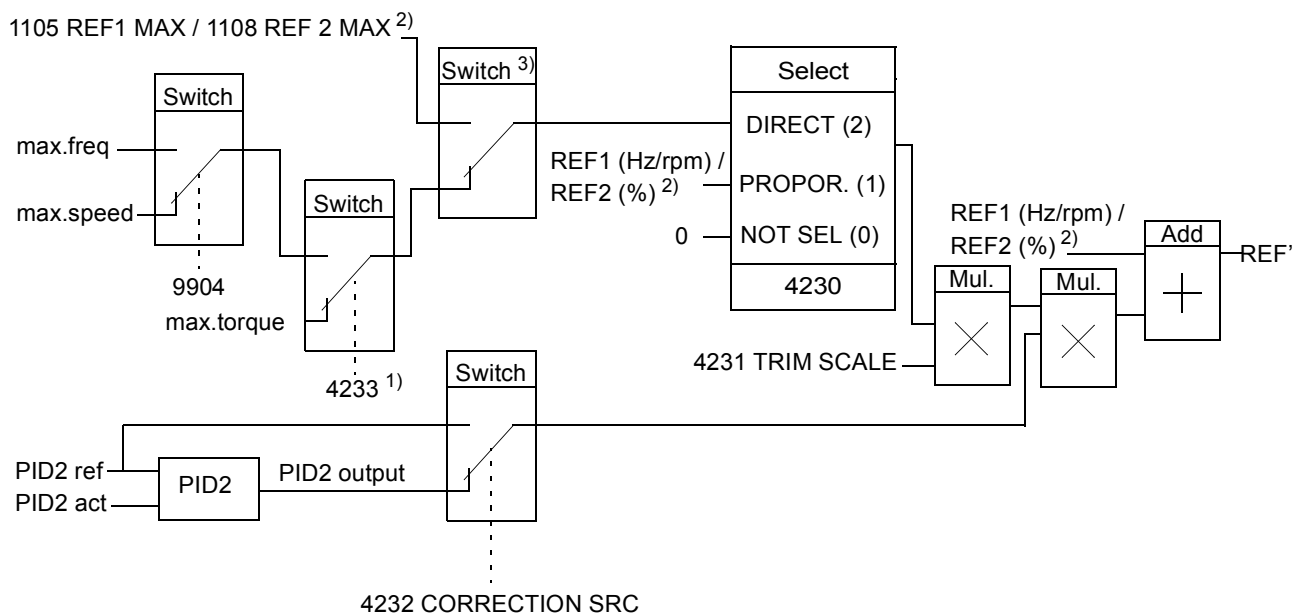

REF1 (Hz/rpm) / REF2 (%) = The drive reference before trimming

REF' = The drive reference after trimming

max. speed = par. 2002 (or 2001 if the absolute value is greater)

max. freq = par. 2008 (or 2007 if the absolute value is greater)

max. torq = par. 2014 (or 2013 if the absolute value is greater)

PID2 ref = par. 4210

PID2 act = par. 4214...4221

1) **Note:** Torque reference trimming is only for external reference REF2 (%).

2) REF1 or REF2 depending on which is active. See parameter 1102.

3) When par. 4232 = PID2REF, the maximum trimming reference is defined by parameter 1105 when REF1 is active and by parameter 1108 when REF2 is active.

When par. 4232 = PID2 OUTPUT, the maximum trimming reference is defined by parameter 2002 if parameter 9904 value is VECTOR:SPEED or VECTOR:TORQ and by parameter 2008 value if parameter 9904 value is SCALAR:FREQ.

Settings

Parameter	Additional information
1102	REF1/2 selection
4230 ... 4233	Trimming function settings
4201 ... 4229	PID control settings
Group 20 LIMITS	Drive operation limits

Example

The drive runs a conveyor line. It is speed controlled but the line tension also needs to be taken into account: If the measured tension exceeds the tension setpoint, the speed will be slightly decreased, and vice versa.

To accomplish the desired speed correction, the user

- activates the trimming function and connects the tension setpoint and the measured tension to it.
- tunes the trimming to a suitable level.

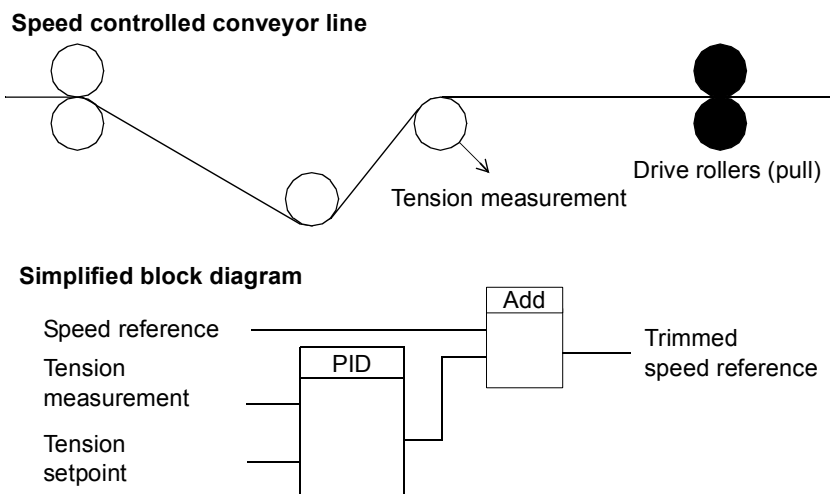

Programmable analog inputs

The drive has two programmable analog voltage/current inputs. The inputs can be inverted, filtered and the maximum and minimum values can be adjusted. The update cycle for the analog input is 8 ms (12 ms cycle once per second). The cycle time is shorter when information is transferred to the application program (8 ms -> 2 ms).

Settings

Parameter	Additional information
Group 11 REFERENCE SELECT	AI as reference source
Group 13 ANALOGUE INPUTS	Analog input processing
3001, 3021, 3022, 3107	AI loss supervision
Group 35 MOTOR TEMP MEAS	AI in motor temperature measurement
Group 40 PROCESS PID SET 1 42 EXT / TRIM PID	AI as PID process control reference or actual value source
8420, 8425, 8426 8430, 8435, 8436 ... 8490, 8495, 8496	AI as sequence programming reference or trigger signal

Diagnostics

Actual value	Additional information
0120, 0121	Analog input values
1401	AI1/A2 signal loss
Alarm	
AI1 LOSS / AI2 LOSS	AI1/AI2 signal below AI1/AI2 FAULT LIMIT (3021/3022)
Fault	
AI1 LOSS / AI2 LOSS	AI1/AI2 signal below limit AI1/AI2 FAULT LIMIT (3021/3022)
PAR AI SCALE	Incorrect AI signal scaling (1302 < 1301 or 1305 < 1304)

Programmable analog output

One programmable current output (0 to 20 mA) is available. Analog output signal can be inverted, filtered and the maximum and minimum values can be adjusted. The analog output signals can be proportional to motor speed, output frequency, output current, motor torque, motor power, etc. The update cycle for the analog output is 2 ms.

Analog output can be controlled with sequence programming. It is also possible to write a value to an analog output through a serial communication link.

Settings

Parameter	Additional information
Group 15 ANALOGUE OUTPUTS	AO value selection and processing
Group 35 MOTOR TEMP MEAS	AO in motor temperature measurement
8423/8433/.../8493	AO control with sequence programming

Diagnostics

Actual value	Additional information
0124	AO value
0170	AO control values defined by sequence programming
Fault	
PAR AO SCALE	Incorrect AO signal scaling (1503 < 1502)

Programmable digital inputs

The drive has five programmable digital inputs. The update time for the digital inputs is 2 ms.

One digital input (DI5) can be programmed as a frequency input. See section [Frequency input](#) on page [105](#).

Settings

Parameter	Additional information
Group 10 START/STOP/DIR	DI as start, stop, direction
Group 11 REFERENCE SELECT	DI in reference selection, or reference source
Group 12 CONSTANT SPEEDS	DI in constant speed selection
Group 16 SYSTEM CONTROLS	DI as external Run Enable, fault reset or user macro change signal
Group 19 TIMER & COUNTER	DI as timer or counter control signal source
2013 , 2014	DI as torque limit source
2109	DI as external emergency stop command source
2201	DI as acceleration and deceleration ramp selection signal
2209	DI as zero ramp force signal
3003	DI as external fault source
Group 35 MOTOR TEMP MEAS	DI in motor temperature measurement
3601	DI as timed function enable signal source
3622	DI as booster activation signal source
4010/4110/4210	DI as PID controller reference signal source
4022/4122	DI as sleep function activation signal in PID1
4027	DI as PID1 parameter set 1/2 selection signal source
4228	DI as external PID2 function activation signal source
Group 84 SEQUENCE PROG	DI as sequence programming control signal source

Diagnostics

Actual value	Additional information
0160	DI status
0414	DI status at the time the latest fault occurred

Programmable relay output

The drive has one programmable relay output. By means of a parameter setting it is possible to choose what information to indicate through the relay output: Ready, running, fault, alarm, etc. The update time for the relay output is 2 ms.

It is possible to write a value to a relay output through a serial communication link.

Settings

Parameter	Additional information
Group 14 RELAY OUTPUTS	RO value selections and operation times
8423	RO control with sequence programming

Diagnostics

Actual value	Additional information
0134	RO Control Word through fieldbus control
0162	RO status

Frequency input

Digital input DI5 can be programmed as a frequency input. Frequency input (0...16000 Hz) can be used as external reference signal source. The update time for the frequency input is 50 ms. Update time is shorter when information is transferred to the application program (50 ms -> 2 ms).

Settings

Parameter	Additional information
Group <i>18 FREQ IN & TRAN OUT</i>	Frequency input minimum and maximum values and filtering
<i>1103/1106</i>	External reference REF1/2 through frequency input
<i>4010, 4110, 4210</i>	Frequency input as PID reference source

Diagnostics

Actual value	Additional information
<i>0161</i>	Frequency input value

Transistor output

The drive has one programmable transistor output. The output can be used either as digital output or frequency output (0...16000 Hz). The update time for the transistor/frequency output is 2 ms.

Settings

Parameter	Additional information
Group <i>18 FREQ IN & TRAN OUT</i>	Transistor output settings
<i>8423</i>	Transistor output control in sequence programming

Diagnostics

Actual value	Additional information
<i>0163</i>	Transistor output status
<i>0164</i>	Transistor output frequency

Actual signals

Several actual signals are available:

- Drive output frequency, current, voltage and power
- Motor speed and torque
- Intermediate circuit DC voltage
- Active control location (LOCAL, EXT1 or EXT2)
- Reference values
- Drive temperature
- Operating time counter (h), kWh counter
- Digital I/O and analog I/O status
- PID controller actual values.

Three signals can be shown simultaneously on the assistant control panel display (one signal on the basic panel display). It is also possible to read the values through the serial communication link or through the analog outputs.

Settings

Parameter	Additional information
1501	Selection of an actual signal to AO
1808	Selection of an actual signal to frequency output
Group 32 SUPERVISION	Actual signal supervision
Group 34 PANEL DISPLAY	Selection of an actual signals to be displayed on the control panel

Diagnostics

Actual value	Additional information
Group 01 OPERATING DATA ... 04 FAULT HISTORY	Lists of actual signals

Motor identification

The performance of vector control is based on an accurate motor model determined during the motor start-up.

A motor Identification Magnetisation is automatically done the first time the start command is given. During this first start-up, the motor is magnetised at zero speed for several seconds to allow the motor model to be created. This identification method is suitable for most applications.

In demanding applications a separate Identification Run (ID run) can be performed.

Settings

Parameter [9910](#) ID RUN

Power loss ride-through

If the incoming supply voltage is cut off, the drive will continue to operate by utilising the kinetic energy of the rotating motor. The drive will be fully operational as long as the motor rotates and generates energy to the drive. The drive can continue the operation after the break if the main contactor remained closed.

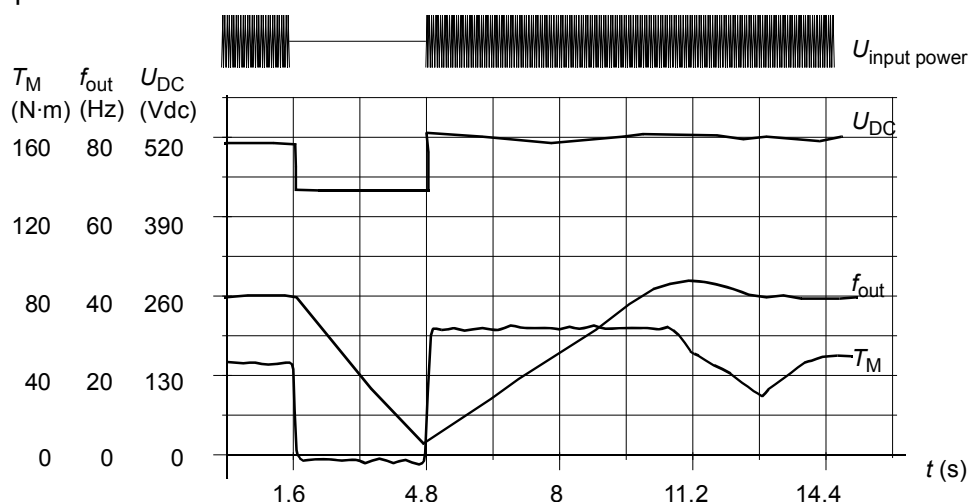

U_{DC} = Intermediate circuit voltage of the drive, f_{out} = output frequency of the drive, T_M = Motor torque

Loss of supply voltage at nominal load ($f_{out} = 40$ Hz). The intermediate circuit DC voltage drops to the minimum limit. The controller keeps the voltage steady as long as the input power is switched off. The drive runs the motor in generator mode. The motor speed falls but the drive is operational as long as the motor has enough kinetic energy.

Settings

Parameter [2006](#) UNDERVOLT CTRL

DC Magnetising

When DC Magnetising is activated, the drive automatically magnetises the motor before starting. This feature guarantees the highest possible breakaway torque, up to 180% of motor nominal torque. By adjusting the premagnetising time, it is possible to synchronise the motor start and e.g. a mechanical brake release. The Automatic Start feature and DC Magnetising cannot be activated at the same time.

Settings

Parameters [2101](#) START FUNCTION and [2103](#) DC MAGN TIME

Maintenance trigger

A maintenance trigger can be activated to show a notice on the panel display when e.g. drive power consumption has exceeded the defined trigger point.

Settings

Parameter group [29](#) MAINTENANCE TRIG

DC Hold

By activating the motor DC Hold feature it is possible to lock the rotor at zero speed. When both the reference and the motor speed fall below the preset DC hold speed, the drive stops the motor and starts to inject DC into the motor. When the reference speed again exceeds the DC hold speed, the normal drive operation resumes.

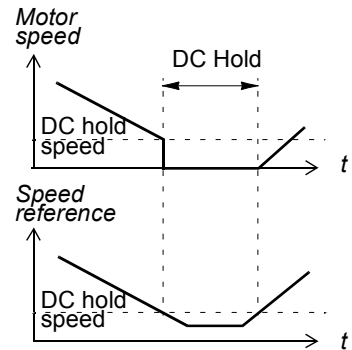

Settings

Parameters [2104...2106](#)

Speed compensated stop

Speed compensation stop is available e.g. for applications, where a conveyer needs to travel a certain distance after receiving the stop command. At maximum speed the motor is stopped normally along the defined deceleration ramp. Below maximum speed stop is delayed by running the drive at current speed before the motor is ramped to a stop. As shown in the following figure, the distance travelled after the stop command is the same in both cases, i.e. area A equals area B.

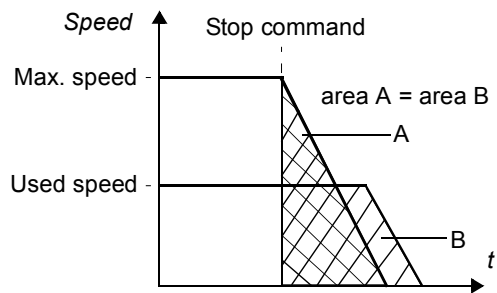

Speed compensation can be restricted to forward or reverse rotating direction.

Settings

Parameter [2102](#) STOP FUNCTION

Flux Braking

The drive can provide greater deceleration by raising the level of magnetisation in the motor. By increasing the motor flux, the energy generated by the motor during braking can be converted to motor thermal energy.

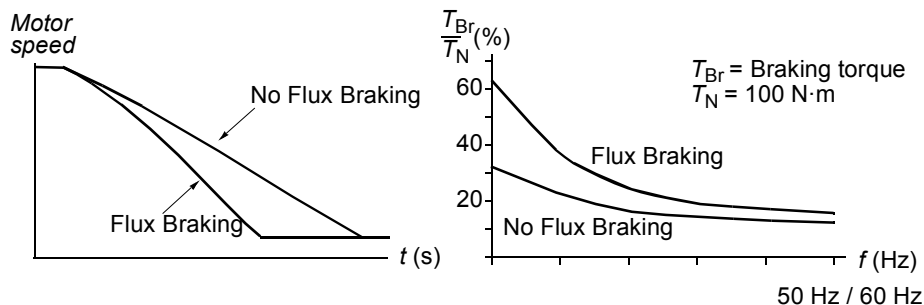

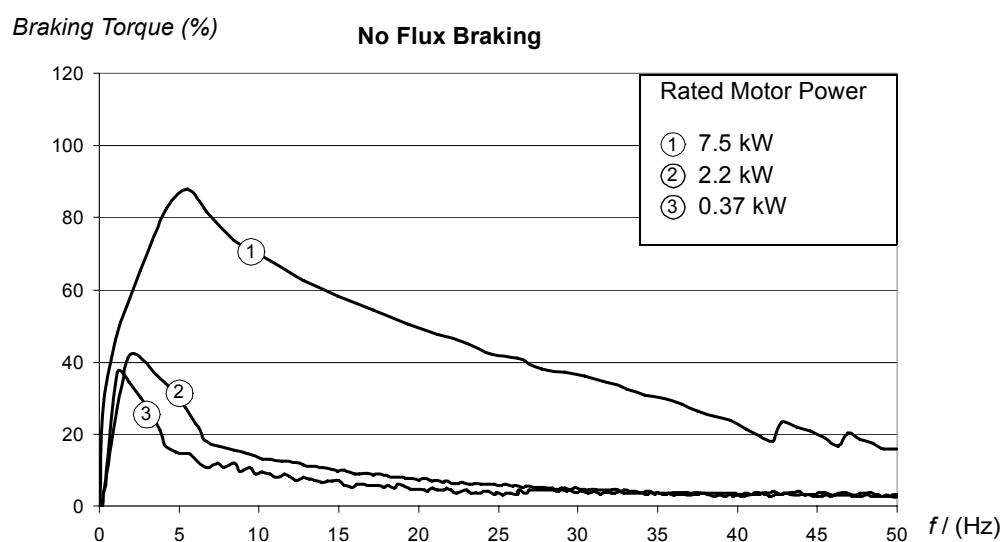
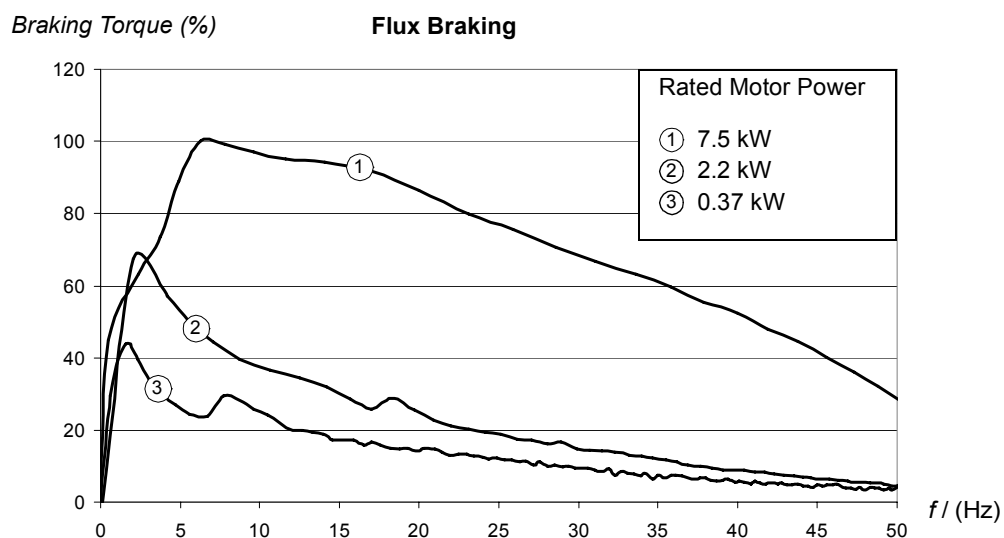

The drive monitors the motor status continuously, also during the Flux Braking. Therefore, Flux Braking can be used both for stopping the motor and for changing the speed. The other benefits of Flux Braking are:

- The braking starts immediately after a stop command is given. The function does not need to wait for the flux reduction before it can start the braking.
- The cooling of the motor is efficient. The stator current of the motor increases during the Flux Braking, not the rotor current. The stator cools much more efficiently than the rotor.

Settings

Parameter [2602](#) FLUX BRAKING

Flux Optimisation

Flux Optimisation reduces the total energy consumption and motor noise level when the drive operates below the nominal load. The total efficiency (motor and the drive) can be improved by 1% to 10%, depending on the load torque and speed.

Settings

Parameter [2601](#) FLUX OPT ENABLE

Acceleration and deceleration ramps

Two user-selectable acceleration and deceleration ramps are available. It is possible to adjust the acceleration/deceleration times and the ramp shape. Switching between the two ramps can be controlled via a digital input or fieldbus.

The available ramp shape alternatives are Linear and S-curve.

Linear: Suitable for drives requiring steady or slow acceleration/deceleration.

S-curve: Ideal for conveyors carrying fragile loads, or other applications where a smooth transition is required when changing the speed.

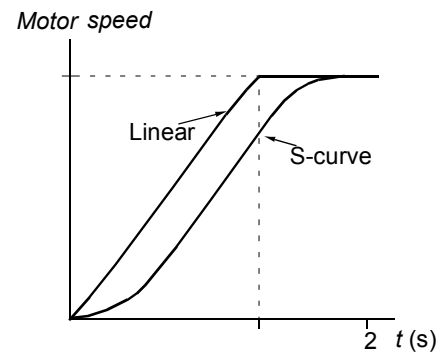

Settings

Parameter group [22 ACCEL/DECEL](#)

Sequence programming offers eight additional ramp times. See section [Sequence programming](#) on page [133](#).

Critical Speeds

A Critical Speeds function is available for applications where it is necessary to avoid certain motor speeds or speed bands because of e.g. mechanical resonance problems. The user can define three critical speeds or speed bands.

Settings

Parameter group [25 CRITICAL SPEEDS](#)

Constant speeds

It is possible to define seven positive constant speeds. Constant speeds are selected with digital inputs. Constant speed activation overrides the external speed reference.

Constant speed selections are ignored if

- torque control is active, or
- PID reference is being followed, or
- drive is in local control mode.

This function operates on a 2 ms time level.

Settings

Parameter group [12 CONSTANT SPEEDS](#)

Constant speed 7 ([1208](#) CONST SPEED 7) is also used for fault functions. See parameter group [30 FAULT FUNCTIONS](#).

Constant speed 6 or 7 ([1207](#) CONST SPEED 6 / [1208](#) CONST SPEED 7) is also used for jogging function. See section [Jogging](#) on page [129](#).

Custom U/f ratio

The user can define a U/f curve (output voltage as a function of frequency). This custom ratio is used only in special applications where linear and squared U/f ratio are not sufficient (e.g. when motor break-away torque needs to be boosted).

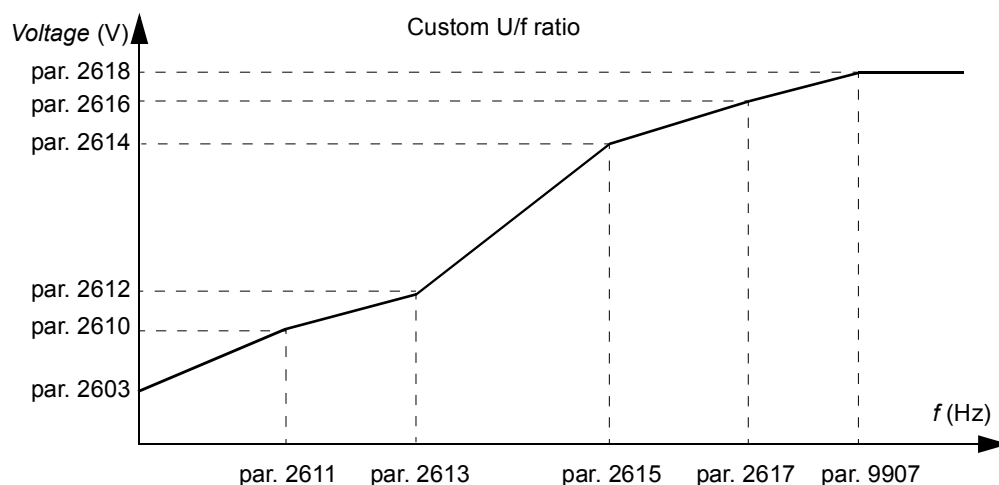

Note: The voltage and the frequency points of the U/f curve must fulfill the following requirements:

$$2610 < 2612 < 2614 < 2616 < 2618$$

and

$$2611 < 2613 < 2615 < 2617 < 9907$$



WARNING! High voltage at low frequencies may result in poor performance or motor damage (overheating).

Settings

Parameter	Additional information
2605	Custom U/f ratio activation
2610...2618	Custom U/f ratio settings

Diagnostics

Fault	Additional information
PAR CUSTOM U/F	Incorrect U/f ratio

Speed controller tuning

It is possible to manually adjust the controller gain, integration time and derivation time, or let the drive perform a separate speed controller Autotune Run (parameter [2305 AUTOTUNE RUN](#)). In Autotune Run, the speed controller is tuned based on the load and inertia of the motor and the machine. The figure below shows speed responses at a speed reference step (typically, 1 to 20%).

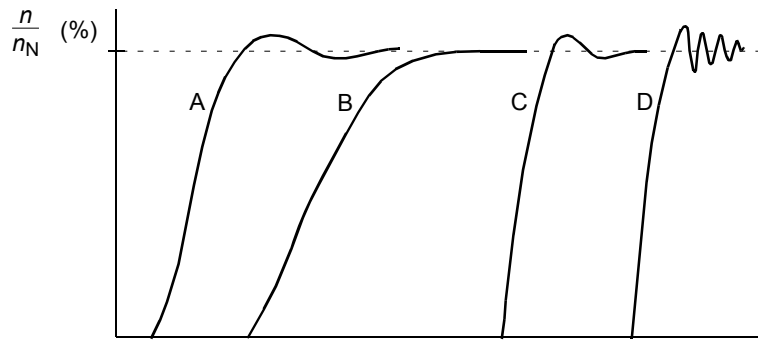

- A: Undercompensated
- B: Normally tuned (autotuning)
- C: Normally tuned (manually). Better dynamic performance than with B
- D: Overcompensated speed controller

The figure below is a simplified block diagram of the speed controller. The controller output is the reference for the torque controller.

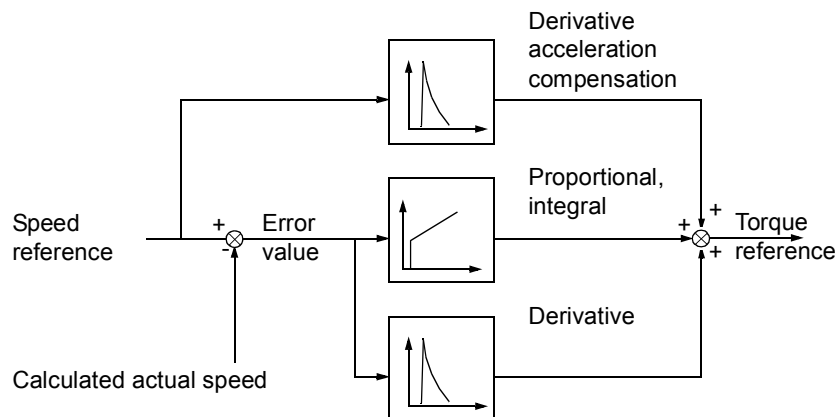

Settings

Parameter groups [23 SPEED CONTROL](#) and [20 LIMITS](#)

Diagnostics

Actual signal [0102 SPEED](#)

Speed control performance figures

The table below shows typical performance figures for speed control.

Speed control	No pulse encoder	With pulse encoder
Static accuracy	20% of motor nominal slip	2% of motor nominal slip
Dynamic accuracy	< 1% s with 100% torque step	< 1% s with 100% torque step

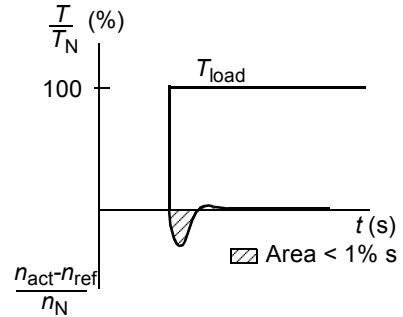

T_N = rated motor torque
 n_N = rated motor speed
 n_{act} = actual speed
 n_{ref} = speed reference

Torque control performance figures

The drive can perform precise torque control without any speed feedback from the motor shaft. The table below shows typical performance figures for torque control.

Torque control	No pulse encoder	With pulse encoder
Non-linearity	$\pm 5\%$ with nominal torque ($\pm 20\%$ at the most demanding operating point)	$\pm 5\%$ with nominal torque
Torque step rise time	< 10 ms with nominal torque	< 10 ms with nominal torque

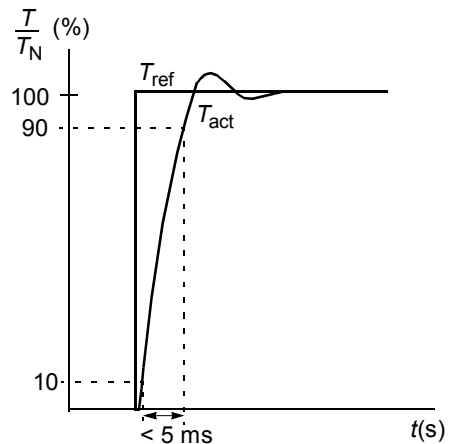

T_N = rated motor torque
 T_{ref} = torque reference
 T_{act} = actual torque

Scalar control

It is possible to select scalar control as the motor control method instead of vector control. In the scalar control mode, the drive is controlled with a frequency reference.

It is recommended to activate the scalar control mode in the following special applications:

- In multimotor drives: 1) if the load is not equally shared between the motors, 2) if the motors are of different sizes, or 3) if the motors are going to be changed after the motor identification.
- If the nominal current of the motor is less than 20% of the nominal output current of the drive.

In the scalar control mode, some standard features are not available.

Settings

Parameter [9904](#) MOTOR CTRL MODE

IR compensation for a scalar controlled drive

IR compensation is active only when the motor control mode is scalar (see section [Scalar control](#) on page [115](#)). When IR compensation is activated, the drive gives an extra voltage boost to the motor at low speeds. IR compensation is useful in applications that require high breakaway torque. In vector control, no IR compensation is possible/needed.

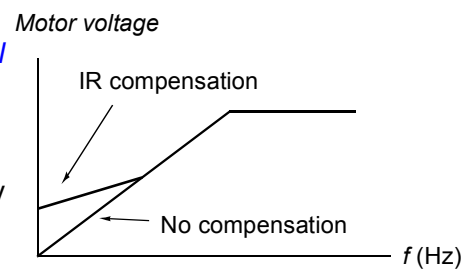

Settings

Parameter [2603](#) IR COMP VOLT

Programmable protection functions

AI<Min

AI<Min function defines the drive operation if an analog input signal falls below the set minimum limit.

Settings

Parameters [3001](#) AI<MIN FUNCTION, [3021](#) AI1 FAULT LIMIT and [3022](#) AI2 FAULT LIMIT

Panel Loss

Panel Loss function defines the operation of the drive if the control panel selected as control location for the drive stops communicating.

Settings

Parameter [3002](#) PANEL COMM ERR

External Fault

External Faults (1 and 2) can be supervised by defining one digital input as a source for an external fault indication signal.

Settings

Parameters [3003](#) EXTERNAL FAULT 1 and [3004](#) EXTERNAL FAULT 2

Stall Protection

The drive protects the motor in a stall situation. It is possible to adjust the supervision limits (frequency, time) and choose how the drive reacts to the motor stall condition (alarm indication / fault indication & drive stop / no reaction).

Settings

Parameters [3010...3012](#)

Motor Thermal Protection

The motor can be protected against overheating by activating the Motor Thermal Protection function.

The drive calculates the temperature of the motor on the basis of the following assumptions:

- 1) The motor is in the ambient temperature of 30°C when power is applied to the drive.
- 2) Motor temperature is calculated using either the user-adjustable or automatically calculated motor thermal time constant and motor load curve (see the figures below). The load curve should be adjusted in case the ambient temperature exceeds 30°C.

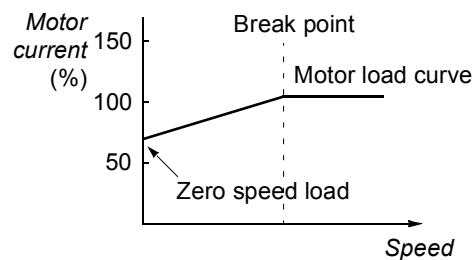
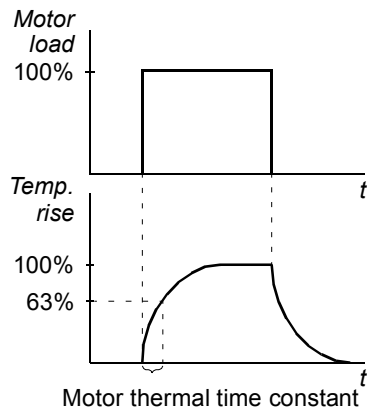

Settings

Parameters [3005...3009](#)

Note: It is also possible to use the motor temperature measurement function. See section [Motor temperature measurement through the standard I/O](#) on page 124.

Underload Protection

Loss of motor load may indicate a process malfunction. The drive provides an underload function to protect the machinery and process in such a serious fault condition. Supervision limits - underload curve and underload time - can be chosen as well as the action taken by the drive upon the underload condition (alarm indication / fault indication & drive stop / no reaction).

Settings

Parameters [3013](#)...[3015](#)

Earth Fault Protection

The Earth Fault Protection detects earth faults in the motor or motor cable. The protection is active only during start.

An earth fault in the input power line does not activate the protection.

Settings

Parameter [3017](#) EARTH FAULT

Incorrect wiring

Defines the operation when incorrect input power cable connection is detected.

Settings

Parameter [3023](#) WIRING FAULT

Input phase loss

Input phase loss protection circuits supervise the input power cable connection status by detecting intermediate circuit ripple. If a phase is lost, the ripple increases.

Settings

Parameter [3016](#) SUPPLY PHASE

Preprogrammed faults

Overcurrent

The overcurrent trip limit for the drive is 325% of the drive nominal current.

DC overvoltage

The DC overvoltage trip limit is 420 V (for 200 V drives) and 840 V (for 400 V drives).

DC undervoltage

The DC undervoltage trip limit is 162 V (for 200 V drives) and 308 V (for 400 V drives).

Drive temperature

The drive supervises the IGBT temperature. There are two supervision limits: Alarm limit and fault trip limit.

Short circuit

If a short circuit occurs, the drive will not start and a fault indication is given.

Internal fault

If the drive detects an internal fault, the drive is stopped and a fault indication is given.

Operation limits

The drive has adjustable limits for speed, current (maximum), torque (maximum) and DC voltage.

Settings

Parameter group [20 LIMITS](#)

Power limit

Power limitation is used to protect the input bridge and the DC intermediate circuit. If the maximum allowed power is exceeded, the drive torque is automatically limited. Maximum overload and continuous power limits depend on the drive hardware. For specific values, see chapter [Technical data](#).

Automatic resets

The drive can automatically reset itself after overcurrent, overvoltage, undervoltage, external and “analog input below a minimum” faults. The Automatic Resets must be activated by the user.

Settings

Parameter	Additional information
31 AUTOMATIC RESET	Automatic reset settings
Alarm	
AUTORESET	Automatic reset alarm

Supervisions

The drive monitors whether certain user selectable variables are within the user-defined limits. The user may set limits for speed, current etc. The supervision status can be indicated through relay or digital output.

The supervision functions operate on a 2 ms time level.

Settings

Parameter group [32 SUPERVISION](#)

Diagnostics

Actual Signals	Additional information
1401	Supervision status through RO
1805	Supervision status through DO
8425, 8426 / 8435, 8436 /.../ 8495, 8496	Sequence programming state change according to supervision functions

Parameter lock

The user can prevent parameter adjustment by activating the parameter lock.

Settings

Parameters [1602](#) PARAMETER LOCK and [1603](#) PASS CODE

PID control

There are two built-in PID controllers in the drive:

- Process PID (PID1) and
- External/Trim PID (PID2).

The PID controller can be used when the motor speed needs to be controlled based on process variables such as pressure, flow or temperature.

When the PID control is activated, a process reference (setpoint) is connected to the drive instead of a speed reference. An actual value (process feedback) is also brought back to the drive. The drive compares the reference and the actual values, and automatically adjusts the drive speed in order to keep the measured process quantity (actual value) at the desired level (reference).

The control operates on a 2 ms time level.

Process controller PID1

PID1 has two separate sets of parameters ([40 PROCESS PID SET 1](#), [41 PROCESS PID SET 2](#)). Selection between parameter sets 1 and 2 is defined by a parameter.

In most cases when there is only one transducer signal wired to the drive, only parameter set 1 is needed. Two different parameter sets (1 and 2) are used e.g. when the load of the motor changes considerably in time.

External/Trim controller PID2

PID2 ([42 EXT / TRIM PID](#)) can be used in two different ways:

- External controller: Instead of using additional PID controller hardware, the user can connect PID2 output via drive analog output or fieldbus controller to control a field instrument like a damper or a valve.
- Trim controller: PID2 can be used to trim or fine tune the reference of the drive. See section [Reference trimming](#) on page [101](#).

Block diagrams

The figure below shows an application example: The controller adjusts the speed of a pressure boost pump according to the measured pressure and the set pressure reference.

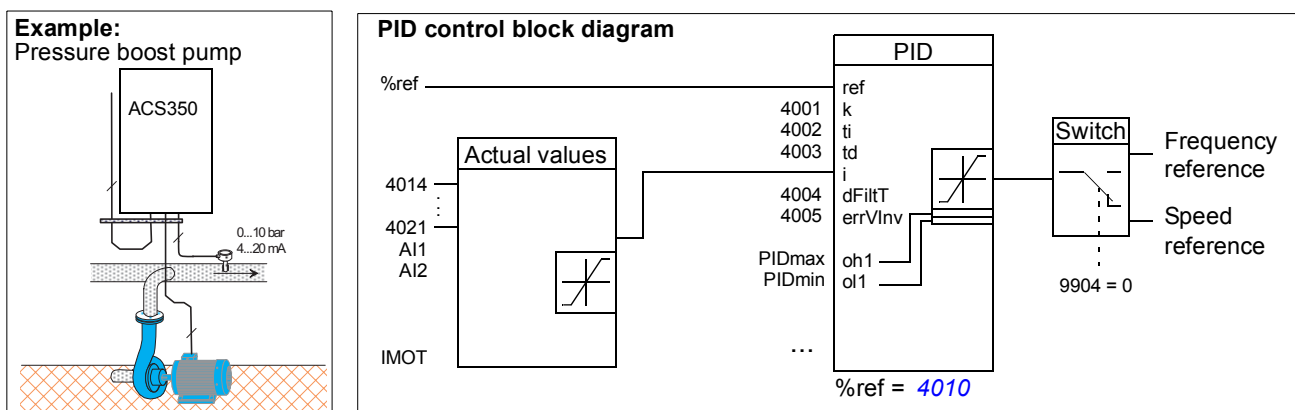

The following figure presents the speed/scalar control block diagram for process controller PID1.

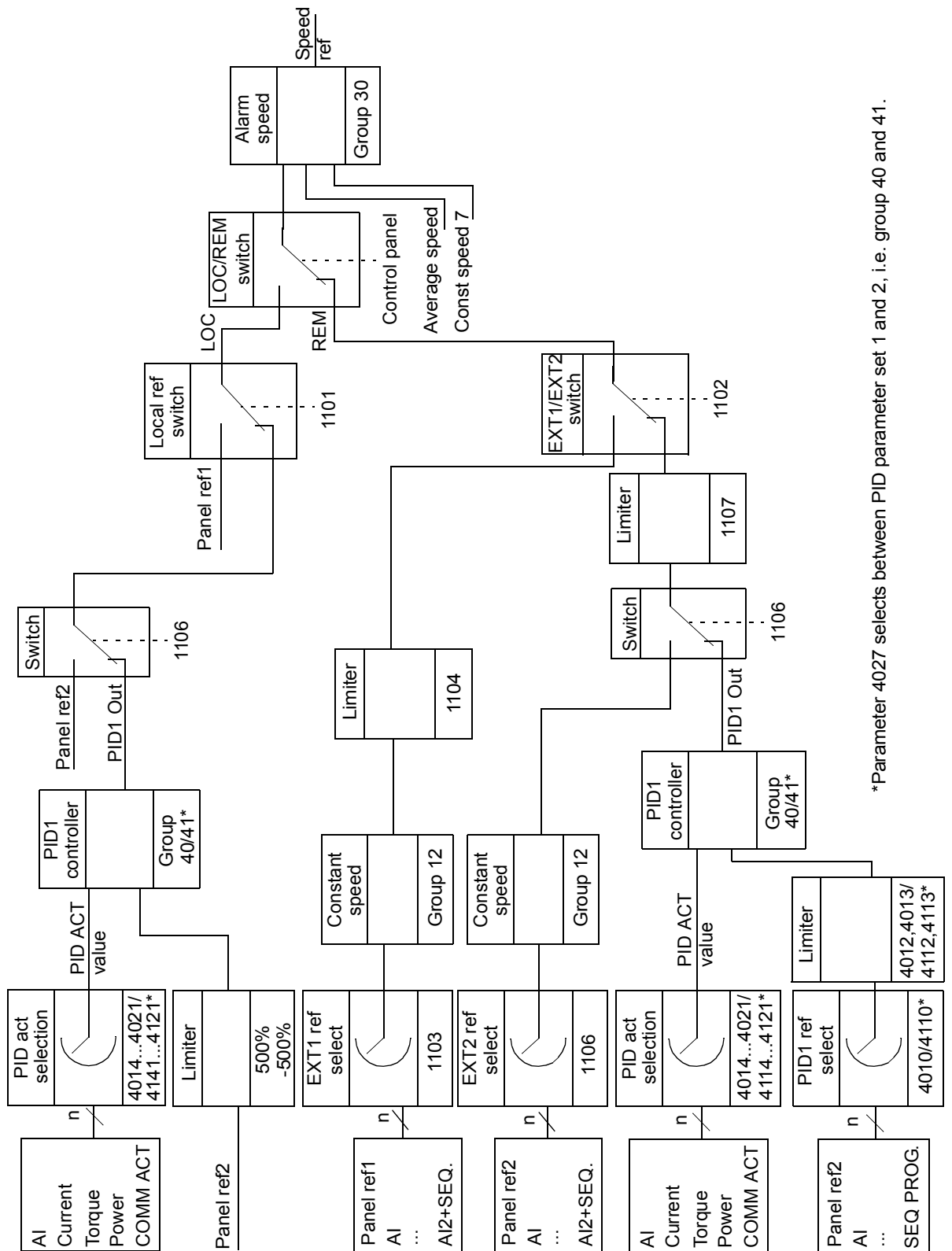

*Parameter 4027 selects between PID parameter set 1 and 2, i.e. group 40 and 41.

Settings

Parameter	Additional information
1101	Local control mode reference type selection
1102	EXT1/2 selection
1106	PID1 activation
1107	REF2 minimum limit
1501	PID2 output (external controller) connection to AO
9902	PID control macro selection
Group 40 PROCESS PID SET 1...41 PROCESS PID SET 2	PID1 settings
Group 42 EXT / TRIM PID	PID2 settings

Diagnostics

Actual Signals	Additional information
0126/0127	PID 1/2 output value
0128/0129	PID 1/2 setpoint value
0130/0131	PID 1/2 feedback value
0132/0133	PID 1/2 deviation
0170	AO value defined by sequence programming

Sleep function for the process PID (PID1) control

The sleep function operates on a 2 ms time level.

The block diagram below illustrates the sleep function enable/disable logic. The sleep function can be put into use only when the PID control is active.

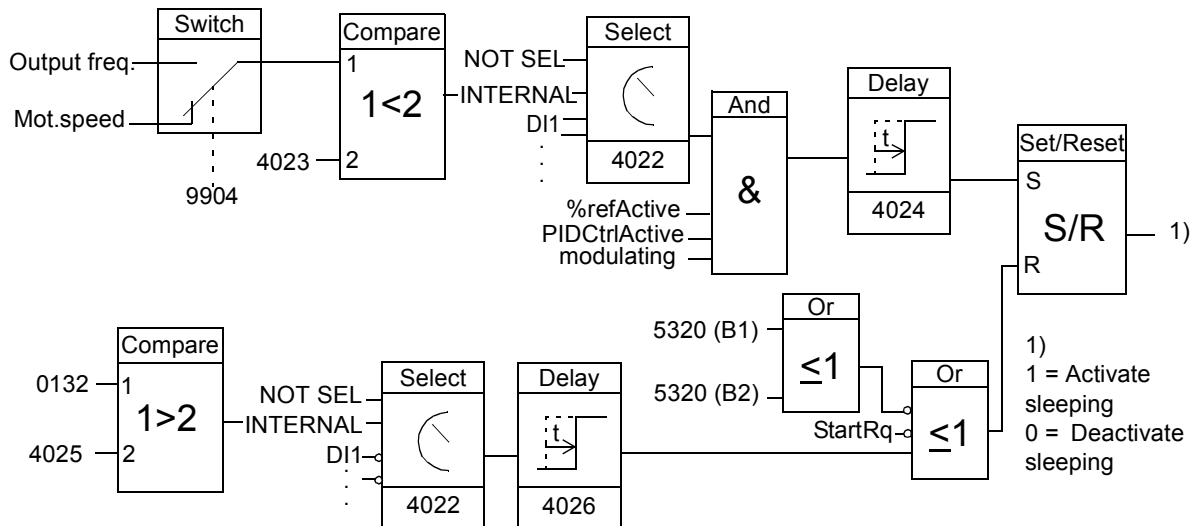

Mot.speed: Actual speed of the motor

%refActive: The % reference (EXT REF2) is in use. See parameter 1102.

PIDCtrlActive: 9902 is PID CTRL.

modulating: The inverter IGBT control is operating.

Example

The time scheme below visualises the operation of the sleep function.

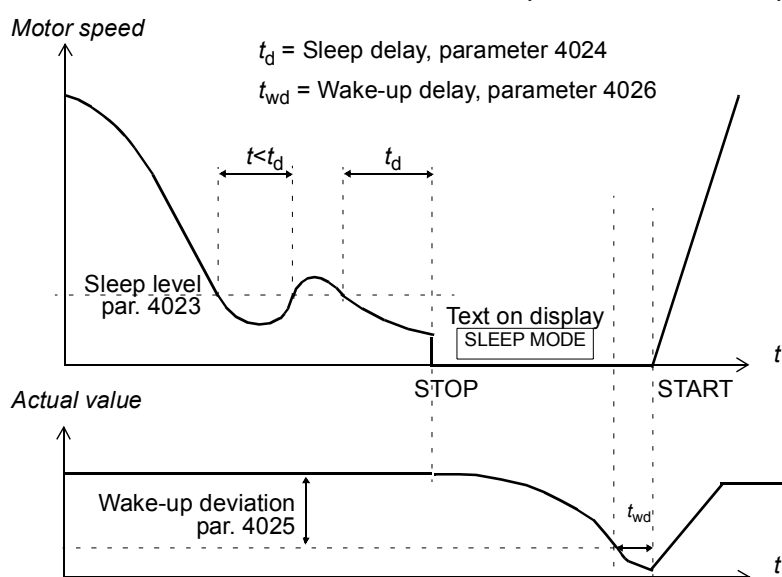

Sleep function for a PID controlled pressure boost pump (when parameter 4022 is set to INTERNAL): The water consumption falls at night. As a consequence, the PID process controller decreases the motor speed. However, due to natural losses in the pipes and the low efficiency of the centrifugal pump at low speeds, the motor does not stop but keeps rotating. The sleep function detects the slow rotation, and stops the unnecessary pumping after the sleep delay has passed. The drive shifts into sleep mode, still monitoring the pressure. The pumping restarts when the pressure falls under the allowed minimum level and the wake-up delay has passed.

Settings

Parameter	Additional information
9902	PID control activation
4022...4026, 4122...4126	Sleep function settings

Diagnostics

Alarm	Additional information
PID SLEEP	Sleep mode
Parameter	Additional information
1401	PID sleep function status through RO

Motor temperature measurement through the standard I/O

This section describes the temperature measurement of one motor when the drive I/O terminals are used as the connection interface.

Motor temperature can be measured using PT100 or PTC sensors connected to analog input and output.

One sensor

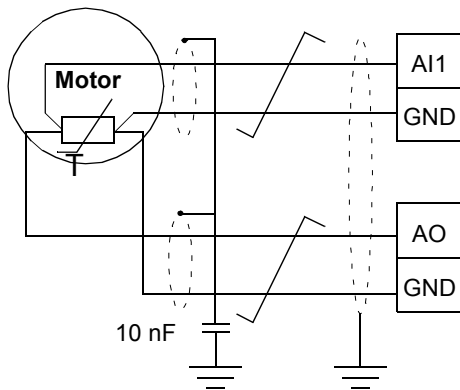

Three sensors

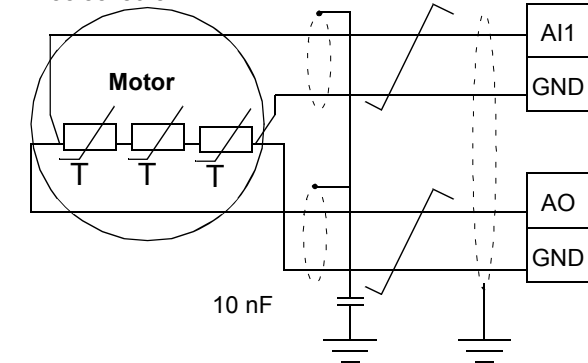

WARNING! According to IEC 664, the connection of the motor temperature sensor requires double or reinforced insulation between motor live parts and the sensor. Reinforced insulation entails a clearance and creepage distance of 8 mm (400 / 500 VAC equipment). If the assembly does not fulfill the requirement

- the I/O board terminals must be protected against contact and they may not be connected to other equipment

or

- the temperature sensor must be isolated from the I/O terminals.

It is also possible to monitor motor temperature by connecting a PTC sensor and a thermistor relay between the +24 VDC voltage supply offered by the drive and digital input. The figure below displays the connection.

Par. 3501 = THERM(0) or THERM(1)

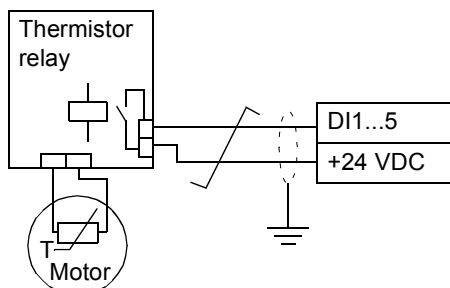

WARNING! According to IEC 664, the connection of the motor thermistor to the digital input requires double or reinforced insulation between motor live parts and the thermistor. Reinforced insulation entails a clearance and creeping distance of 8 mm (400 / 500 VAC equipment).

If the thermistor assembly does not fulfill the requirement, the other I/O terminals of the drive must be protected against contact, or a thermistor relay must be used to isolate the thermistor from the digital input.

Settings

Parameter	Additional information
13 ANALOGUE INPUTS	Analog input settings
15 ANALOGUE OUTPUTS	Analog output settings
35 MOTOR TEMP MEAS	Motor temperature measurement settings
Other	
At the motor end the cable shield should be earthed through a 10 nF capacitor. If this is not possible, the shield is to be left unconnected.	

Diagnostics

Actual values	Additional information
0145	Motor temperature
Alarm/Fault	Additional information
MOTOR TEMP/MOT OVERTEMP	Excessive motor temp

Control of a mechanical brake

The mechanical brake is used for holding the motor and driven machinery at zero speed when the drive is stopped, or not powered.

Example

The figure below shows a brake control application example.



WARNING! Make sure that the machinery into which the drive with brake control function is integrated fulfills the personnel safety regulations. Note that the frequency converter (a Complete Drive Module or a Basic Drive Module, as defined in IEC 61800-2), is not considered as a safety device mentioned in the European Machinery Directive and related harmonised standards. Thus, the personnel safety of the complete machinery must not be based on a specific frequency converter feature (such as the brake control function), but it has to be implemented as defined in the application specific regulations.

Brake control logic is integrated in the drive application program. The power supply and wirings needs to be done by the user.

- Brake on/off control through relay output RO

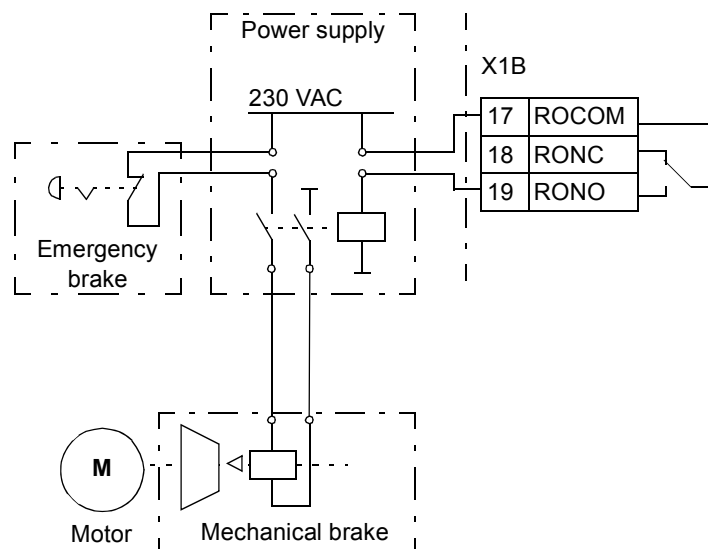

Operation time scheme

The time scheme below illustrates the operation of the brake control function. See also section [State shifts](#) on page 128.

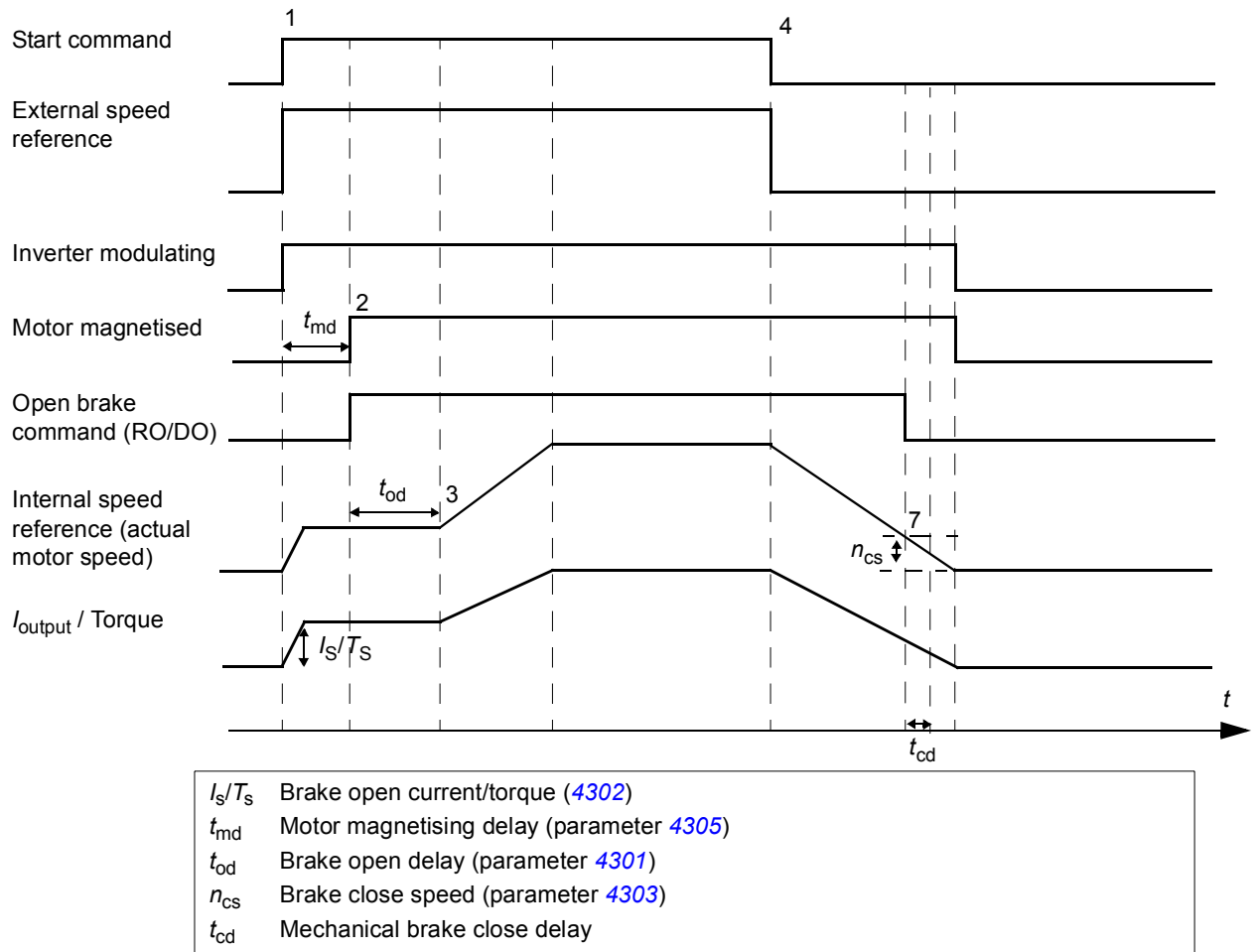

State shifts

RFG = Ramp Function Generator in the speed control loop (reference handling).

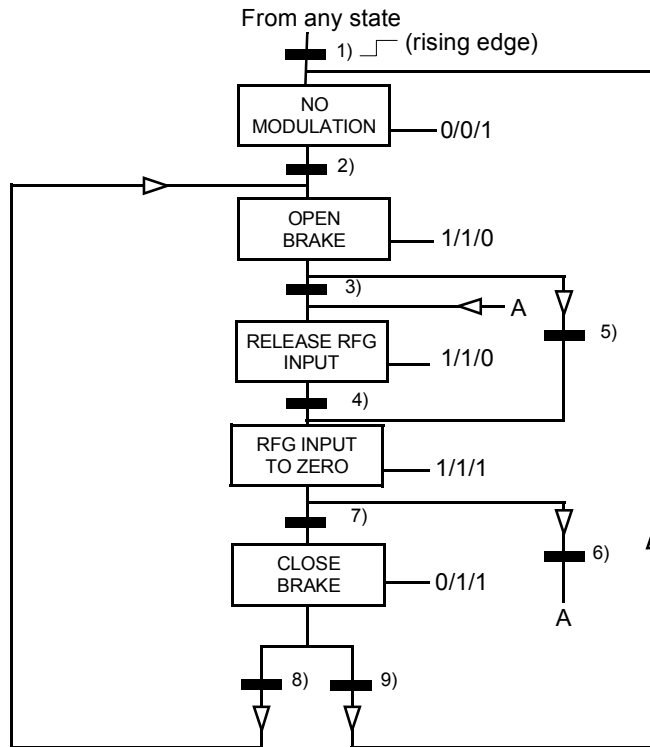

State (Symbol NN — X/Y/Z)

- NN: State name

- X/Y/Z: State outputs/operations

X = 1 Open the brake. The relay output set to brake on/off control energises.

Y = 1 Forced start. The function keeps the internal Start on until the brake is closed in spite of the status of the external Start signal.

Z = 1 Ramp in zero. Forces the used speed reference (internal) to zero along a ramp.

State change conditions (Symbol)

1) Brake control active 0 -> 1 OR Inverter is modulating = 0

2) Motor magnetised = 1 AND Drive running = 1

3) Brake is open AND Brake open delay passed AND Start = 1

4) Start = 0

5) Start = 0

6) Start = 1

7) | Actual motor speed | < Brake close speed AND Start = 0

8) Start = 1

9) Brake is closed AND Brake close delay passed = 1 AND Start = 0

Settings

Parameter	Additional information
1401/1805	Mechanical brake activation through RO/DO
2112	Zero speed delay
Group 43 MECH BRK CONTROL	Brake function settings

Jogging

The jogging function is typically used to control a cyclical movement of a machine section. One push button controls the drive through the whole cycle: When it is on, the drive starts, accelerates to a preset speed at a preset rate. When it is off, the drive decelerates to zero speed at a preset rate.

The figure and table below describe the operation of the drive. They also represent how the drive shifts to normal operation (= jogging inactive) when the drive start command is switched on. Jog cmd = State of the jogging input, Start cmd = State of the drive start command.

The function operates on a 2 ms time level.

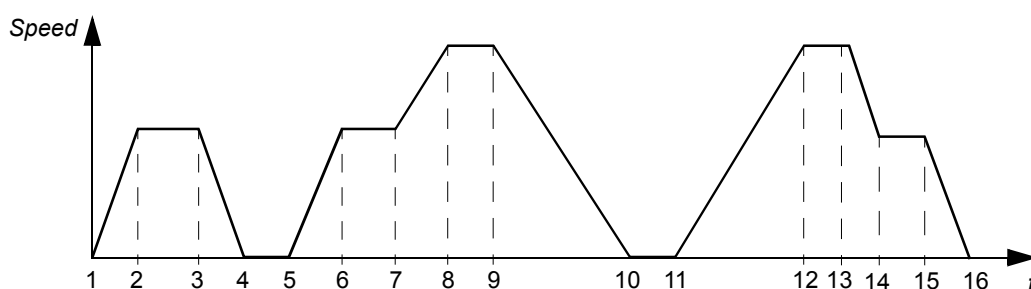

Phase	Jog cmd	Start cmd	Description
1-2	1	0	Drive accelerates to the jogging speed along the acceleration ramp of the jogging function.
2-3	1	0	Drive runs at the jogging speed.
3-4	0	0	Drive decelerates to zero speed along the deceleration ramp of the jogging function.
4-5	0	0	Drive is stopped.
5-6	1	0	Drive accelerates to the jogging speed along the acceleration ramp of the jogging function.
6-7	1	0	Drive runs at the jogging speed.
7-8	x	1	Normal operation overrides the jogging. Drive accelerates to the speed reference along the active acceleration ramp.
8-9	x	1	Normal operation overrides the jogging. Drive follows the speed reference.
9-10	0	0	Drive decelerates to zero speed along the active deceleration ramp.
10-11	0	0	Drive is stopped.
11-12	x	1	Normal operation overrides the jogging. Drive accelerates to the speed reference along the active acceleration ramp.
12-13	x	1	Normal operation overrides the jogging. Drive follows the speed reference.
13-14	1	0	Drive decelerates to the jogging speed along the deceleration ramp of the jogging function.
14-15	1	0	Drive runs at the jogging speed.
15-16	0	0	Drive decelerates to zero speed along the deceleration ramp of the jogging function.

x = state can be either 1 or 0.

Note: The jogging is not operational when the drive start command is on.

Note: The jogging speed overrides the constant speeds.

Note: The jogging uses ramp stop even if parameter [2102](#) STOP FUNCTION selection is COAST.

Note: The ramp shape time is set to zero during the jogging (i.e. linear ramp).

Jogging function uses constant speed 7 as jogging speed and acceleration/ deceleration ramp pair 2.

It is also possible to activate jogging function 1 or 2 through fieldbus. Jogging function 1 uses constant speed 7 and jogging function 2 uses constant speed 6. Both functions use acceleration/deceleration ramp pair 2.

Settings

Parameter	Additional information
1010	Jogging activation
1208	Jogging speed
1208 / 1207	Jogging speed for jogging function 1/2 activated through fieldbus
2112	Zero speed delay
2205, 2206	Acceleration and deceleration times
2207	Acceleration and deceleration ramp shape time: Set to zero during the jogging (i.e. linear ramp).

Diagnostics

Actual values	Additional information
0302	Jogging 1/2 activation through fieldbus
1401	Jogging function status through RO
1805	Jogging function status through DO

Timed functions

A variety of drive functions can be time controlled, e.g. start/stop and EXT1/EXT2 control. The drive offers

- four start and stop times (START TIME 1...4, STOP TIME 1...4)
- four start and stop days (START DAY 1...4, STOP DAY 1...4)
- four timed functions for collecting the selected time periods 1...4 together (TIMED FUNC 1...4)
- booster time (an additional booster time connected to timed functions).

A timed function can be connected to multiple time periods:

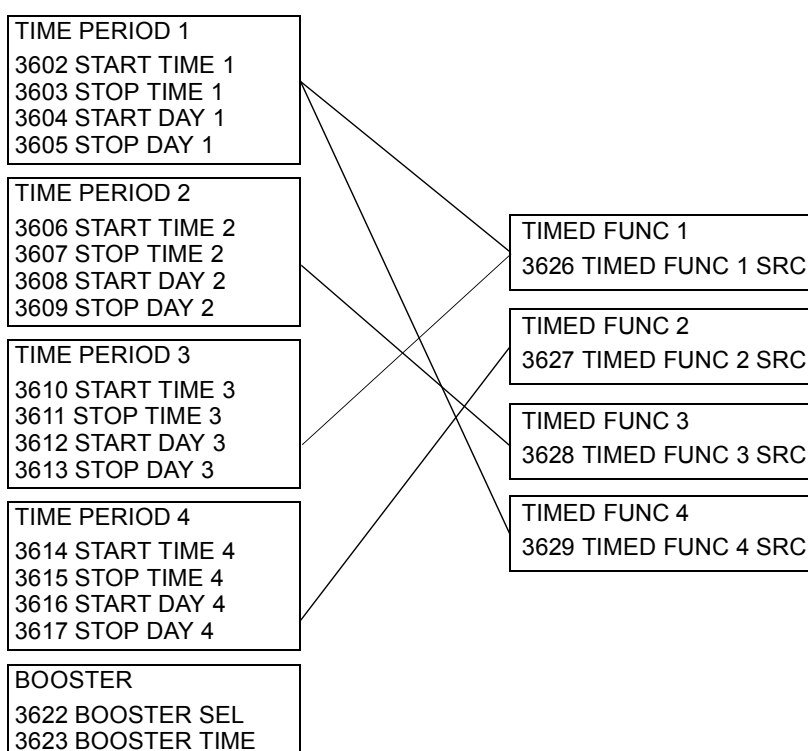

A parameter which is triggered by a timed function can be connected to only one timed function at a time.

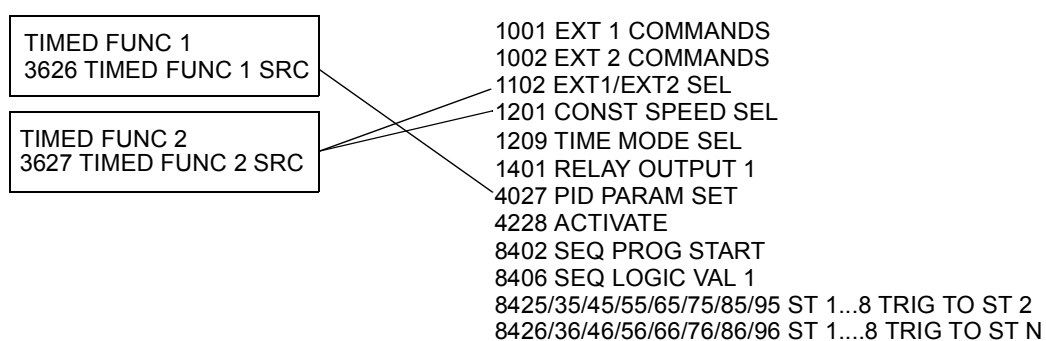

Example

Air conditioning is active on weekdays from 8:00 to 15:30 (8 a.m to 3:30 p.m) and on Sundays from 12:00 to 15:00 (12 to 3 p.m). By pressing the extension time switch, the air-conditioning is on for an extra hour.

Parameter	Setting
3602 START TIME 1	08:00:00
3603 STOP TIME 1	15:30:00
3604 START DAY 1	MONDAY
3605 STOP DAY 1	FRIDAY
3606 START TIME 2	12:00:00
3607 STOP TIME 2	15:00:00
3608 START DAY 2	SUNDAY
3609 STOP DAY 2	SUNDAY
3623 BOOSTER TIME	01:00:00

Settings

Parameter	Additional information
36 <i>TIMED FUNCTIONS</i>	Timed functions settings
1001, 1002	Timed start/stop control
1102	Timed EXT1/EXT2 selection
1201	Timed constant speed 1 activation
1209	Timed speed selection
1401	Timed function status indicated through relay output RO
1805	Timed function status indicated through digital output DO
4027	Timed PID1 parameter set 1/2 selection
4228	Timed external PID2 activation
8402	Timed sequence programming activation
8425/8435/.../8495	Sequence programming state change trigger with timed function
8426/8436/.../8496	

Timer

Drive start and stop can be controlled with timer functions.

Settings

Parameter	Additional information
1001, 1002	Start/Stop signal sources
19 <i>TIMER & COUNTER</i>	Timer for start and stop

Diagnostics

Actual value	Additional information
0165	Start/stop control time count

Counter

Drive start and stop can be controlled with counter functions. The counter function can also be used as state change trigger signal in sequence programming. See section [Sequence programming](#) on page 133.

Settings

Parameter	Additional information
1001 , 1002	Start/Stop signal sources
19 TIMER & COUNTER	Counter for start and stop
8425 , 8426 / 8435 , 8436 /.../ 8495 , 8496	Counter signal as state change trigger in sequence programming

Diagnostics

Actual value	Additional information
0166	Start/stop control pulse count

Sequence programming

The drive can be programmed to perform a sequence where the drive shifts typically through 1 to 8 states. User defines the operation rules for the whole sequence and for each state. The rules of a particular state are effective when the sequence program is active and the program has entered the state. The rules to be defined for each state are:

- Run, stop and direction commands for the drive (forward/reverse/stop)
- Acceleration and deceleration ramp time for the drive
- Source for the drive reference value
- State duration
- RO/DO/AO status
- Signal source for triggering the shift to next state
- Signal source for triggering the shift to any state (1...8).

Every state can also activate drive outputs to give an indication to external devices.

Sequence programming allows state transitions either to the next state or to a selected state. State change can be activated with e.g. timed functions, digital inputs and supervision functions.

Sequence programming can be applied in simple mixer applications as well as in more complicated traverse applications.

The programming can be done with control panel or with a PC tool. ACS350 is supported by version 2.50 (or later version) of the DriveWindow Light PC tool which includes a graphical Sequence Programming Tool.

Note: As default all sequence programming parameters can be changed even when the sequence programming is active. It is recommended, that after the sequence programming parameters are set, parameters are locked by parameter [1602](#) PARAMETER LOCK.

Settings

Parameter	Additional information
1001/1002	Start, stop and direction commands for EXT1/EXT2
1102	EXT1/EXT2 selection
1106	REF2 source
1201	Constant speed deactivation. Constant speed always overrides the sequence programming reference.
1401	Sequence programming output through RO
1501	Sequence programming output through AO
1601	Run Enable activation/deactivation
1805	Sequence programming output through DO
19 TIMER & COUNTER	State change according to counter limit
36 TIMED FUNCTIONS	Timed state change
2201.....2207	Acceleration/deceleration and ramp time settings
32 SUPERVISION	Supervision settings
4010/4110/4210	Sequence programming output as PID reference signal
84 SEQUENCE PROG	Sequence programming settings

Diagnostics

Actual value	Additional information
0167	Sequence programming status
0168	Sequence programming active state
0169	Current state time counter
0170	Analog output PID reference control values
0171	Executed sequence counter

The state diagram below presents the state shift in sequence programming.

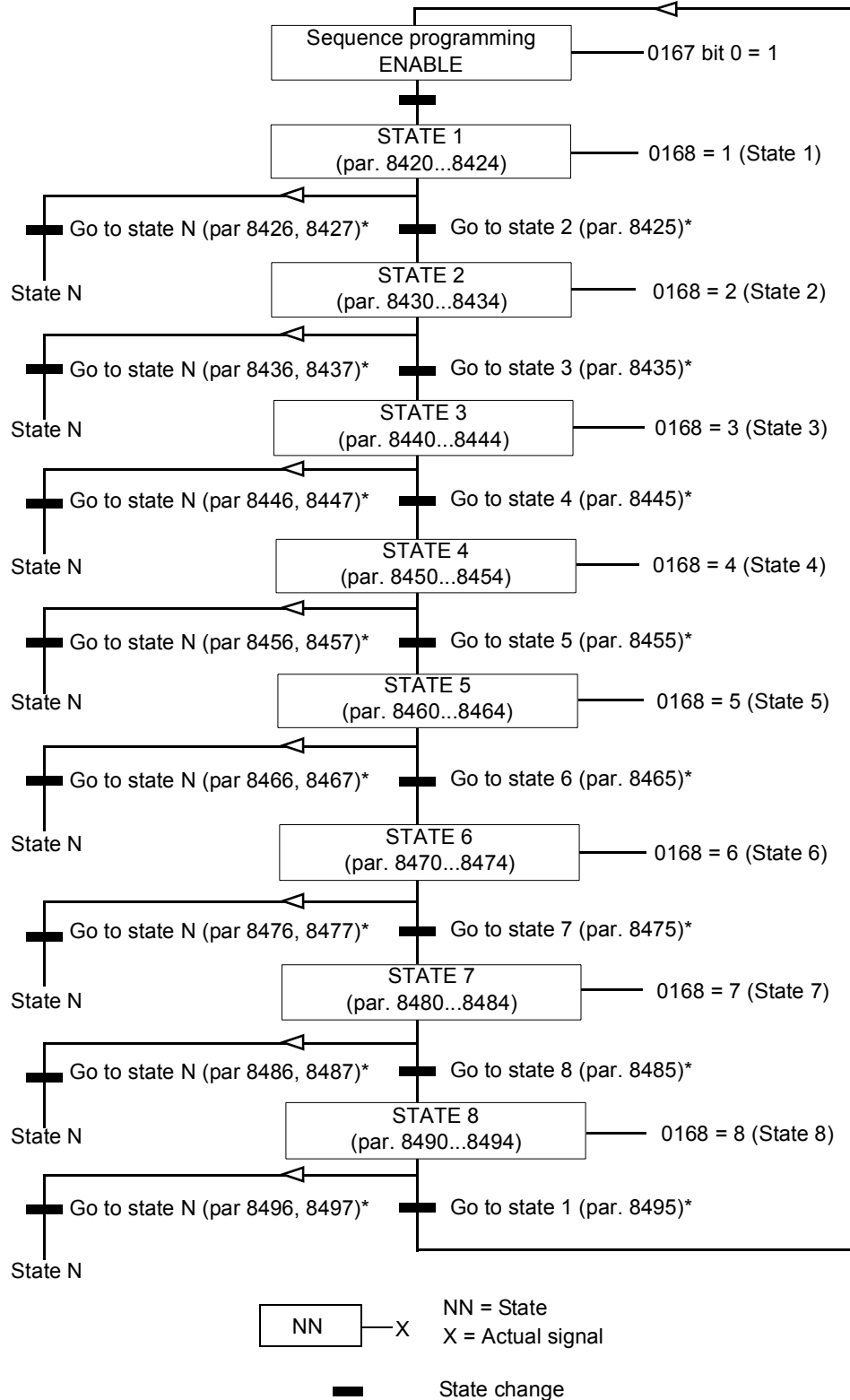

*State change to state N has a higher priority than state change to the next state.

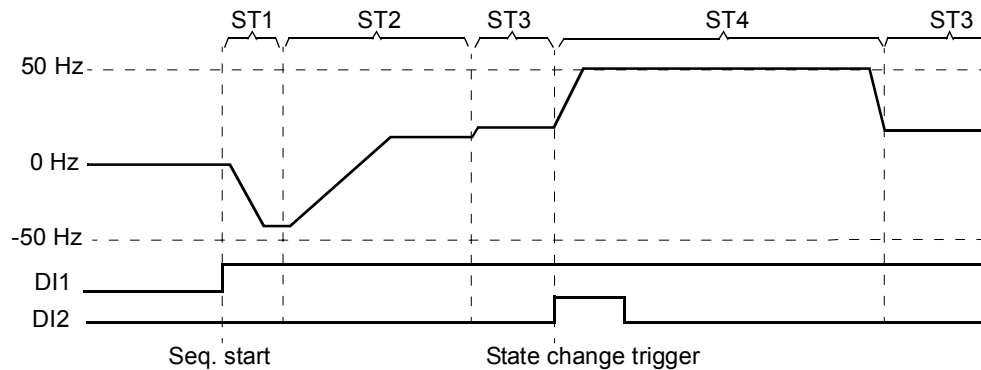
Example 1

Sequence programming is activated by digital input DI1.

ST1: Drive is started in reverse direction with -50 Hz reference and 10 s ramp time. State 1 is active for 40 s.

ST2: Drive is accelerated to 20 Hz with 60 s ramp time. State 2 is active for 120 s.

ST3: Drive is accelerated to 25 Hz with 5 s ramp time. State 3 is active until the sequence programming is disabled or until booster start is activated by DI2.

ST4: Drive is accelerated to 50 Hz with 5 s ramp time. State 4 is active for 200 s and after that the state shifts back to state 3.

Parameter	Setting	Additional information
1002 EXT2 COMMANDS	SEQ PROG	Start, stop, direction commands for EXT2
1102 EXT1/EXT2 SEL	EXT2	EXT2 activation
1106 REF2 SELECT	SEQ PROG	Sequence programming output as REF2
1601 RUN ENABLE	NOT SEL	Deactivation of Run Enable
2102 STOP FUNCTION	RAMP	Ramp stop
2201 ACC/DEC 1/2 SEL	SEQ PROG	Ramp as defined by parameter 8422/.../8452.
8401 SEQ PROG ENABLE	ALWAYS	Sequence programming enabled
8402 SEQ PROG START	DI1	Sequence programming activation through digital input (DI1)
8404 SEQ PROG RESET	DI1(INV)	Sequence programming reset (i.e. reset to state 1, when DI1 signal is lost (1 -> 0))

ST1		ST2		ST3		ST4		Additional information
Par.	Setting	Par.	Setting	Par.	Setting	Par.	Setting	
8420 ST1 REF SEL	100%	8430	40%	8440	50%	8450	100%	State reference
8421 ST1 COMMANDS	START REV	8431	START FRW	8441	START FRW	8451	START FRW	Run, direction and stop command
8422 ST1 RAMP	10 s	8432	60 s	8442	5 s	8452	5 s	Ramp time
8424 ST1 CHANGE DLY	40 s	8434	120 s	8444		8454	200 s	State change delay
8425 ST1 TRIG TO ST 2	CHANGE DLY	8435	CHANGE DLY	8445	DI2	8455		State change trigger
8426 ST1 TRIG TO ST N	NOT SEL	8436	NOT SEL	8446	NOT SEL	8456	CHANGE DLY	
8427 ST1 STATE N	-	8437	-	8447	-	8457	3	

Example 2:

Drive is programmed for traverse control with 30 sequences.

Sequence programming is activated by digital input DI1.

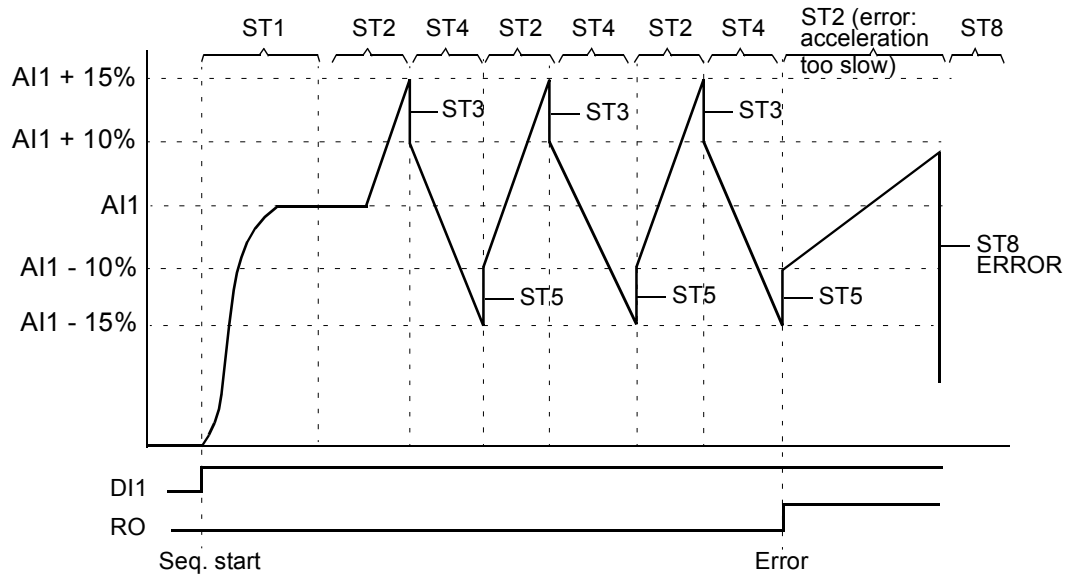

ST1: Drive is started in forward direction with AI1 (AI1 + 50% - 50%) reference and ramp pair 2. State shifts to the next state when reference is reached. All relay and analog outputs are cleared.

ST2: Drive is accelerated with AI1 + 15% (AI1 + 65% - 50%) reference and 1.5 s ramp time. State shifts to the next state when reference is reached. If reference is not reached within 2 s, state shifts to state 8 (error state).

ST3: Drive is decelerated with AI1 + 10% (AI1 + 60% - 50%) reference and 0 s ramp time ¹⁾. State shifts to the next state when reference is reached. If reference is not reached within 0.2 s, state shifts to state 8 (error state).

ST4: Drive is decelerated with AI1 - 15% (AI1 + 35% - 50%) reference and 1.5 s ramp time. State shifts to the next state when reference is reached. If reference is not reached within 2 s, state shifts to state 8 (error state). ²⁾

ST5: Drive is accelerated with AI1 - 10% (AI1 + 40% - 50%) reference and 0 s ramp time ¹⁾. State shifts to the next state when reference is reached. Sequence counter value is increased by 1. If sequence counter elapses, state shifts to state 7 (sequence completed).

ST6: Drive reference and ramp times are the same as in state 2. Drive state shifts immediately to state 2 (delay time is 0 s).

ST7 (sequence completed): Drive is stopped with ramp pair 1. Digital output DO is activated. If sequence programming is deactivated by falling edge of digital input DI1, state machine is reset to state 1. New start command can be activated by digital input DI1 or by digital inputs DI4 and DI5 (both inputs DI4 and DI5 must be simultaneously active).

ST8 (error state): Drive is stopped with ramp pair 1. Relay output RO is activated. If sequence programming is deactivated by falling edge of digital input DI1, state machine is reset to state 1. New start command can be activated by digital input DI1 or by digital inputs DI4 and DI5 (both inputs DI4 and DI5 must be simultaneously active).

1) 0 second ramp time = drive is accelerated/decelerated as rapidly as possible.

2) State reference must be between 0...100%, i.e scaled AI1 value must be between 15...85%. If AI1 = 0 reference = 0% + 35% -50% = -15% < 0%.

Parameter	Setting	Additional information
1002 EXT2 COMMANDS	SEQ PROG	Start, stop, direction commands for EXT2
1102 EXT1/EXT2 SEL	EXT2	EXT2 activation
1106 REF2 SELECT	AI1+SEQ PROG	Addition of analog input AI1 and sequence programming output as REF2
1201 CONST SPEED SEL	NOT SEL	Deactivation of constant speeds
1401 RELAY OUTPUT 1	SEQ PROG	Relay output RO control as defined by parameter 8423/.../8493
1601 RUN ENABLE	NOT SEL	Deactivation of Run Enable
1805 DO SIGNAL	SEQ PROG	Digital output DO control as defined by parameter 8423/.../8493
2102 STOP FUNCTION	RAMP	Ramp stop
2201 ACC/DEC 1/2 SEL	SEQ PROG	Ramp as defined by parameter 8422/.../8492
2202 ACCELER TIME 1	1 s	Acceleration/deceleration ramp pair 1
2203 DECELER TIME 1	0 s	
2205 ACCELER TIME 2	20 s	Acceleration/deceleration ramp pair 2
2206 DECELER TIME 2	20 s	
2207 RAMP SHAPE 2	5 s	Shape of the acceleration/deceleration ramp 2
3201 SUPERV 1 PARAM	171	Sequence counter (signal 0171 SEQ CYCLE CNTR) supervision
3202 SUPERV 1 LIM LO	30	Supervision low limit
3203 SUPERV 1 LIM HI	30	Supervision high limit
8401 SEQ PROG ENABLE	EXT2	Sequence programming enabled in EXT2
8402 SEQ PROG START	DI1	Sequence programming activation through digital input (DI1)
8404 SEQ PROG RESET	DI1(INV)	Sequence programming reset through inverted digital input DI1(INV)
8406 SEQ LOGIC VAL 1	DI4	Logic value 1
8407 SEQ LOGIC OPER 1	AND	Operation between logic value 1 and 2
8408 SEQ LOGIC VAL 2	DI5	Logic value 2
8415 CYCLE CNT LOC	ST5 TO NEXT	Sequence counter activation, i.e. sequence count increases every time the state changes from state 5 to state 6.
8416 CYCLE CNT RST	STATE 1	Sequence counter reset during state transition to state 1

ST1		ST2		ST3		ST4		Additional information
Par.	Setting	Par.	Setting	Par.	Setting	Par.	Setting	
8420 ST1 REF SEL	50%	8430	65%	8440	60%	8450	35%	State reference
8421 ST1 COMMANDS	START FRW	8431	START FRW	8441	START FRW	8451	START FRW	Start, stop and direction commands
8422 ST1 RAMP	-0.2 (ramp pair 2)	8432	1.5 s	8442	0 s	8452	1.5 s	Acceleration/ deceleration ramp time
8423 ST1 OUT CONTROL	R=0,D=0, AO=0	8433	AO=0	8443	AO=0	8453	AO=0	Relay, digital and analog output control
8424 ST1 CHANGE DLY	0 s	8434	2 s	8444	0.2 s	8454	2 s	State change delay
8425 ST1 TRIG TO ST 2	ENTER SETPNT	8435	ENTER SETPNT	8445	ENTER SETPNT	8455	ENTER SETPNT	State change trigger
8426 ST1 TRIG TO ST N	NOT SEL	8436	CHANGE DLY	8446	CHANGE DLY	8456	CHANGE DLY	
8427 ST1 STATE N	STATE 1	8437	STATE 8	8447	STATE 8	8457	STATE 8	

ST5		ST6		ST7		ST8		Additional information
Par.	Setting	Par.	Setting	Par.	Setting	Par.	Setting	
8460 ST5 REF SEL	40%	8470	65%	8480	0%	8490	0%	State reference
8461 ST5 COMMANDS	START FRW	8471	START FRW	8481	DRIVE STOP	8491	DRIVE STOP	Start, stop and direction commands
8462 ST5 RAMP	0 s	8472	1.5 s	8482	-0.1 (ramp pair 1)	8492	-0.1 (ramp pair 1)	Acceleration/ deceleration ramp time
8463 ST5 OUT CONTROL	AO=0	8473	AO=0	8483	DO=1	8493	RO=1	Relay, digital and analog output control
8464 ST5 CHANGE DLY	0.2 s	8474	0 s	8484	0 s	8494	0 s	State change delay
8465 ST5 TRIG TO ST6	ENTER SETPNT	8475	NOT SEL	8485	NOT SEL	8495	LOGIC VAL	State change trigger
8466 ST5 TRIG TO ST N	SUPRV1 OVER	8476	CHANGE DLY	8486	LOGIC VAL	8496	NOT SEL	
8467 ST5 STATE N	STATE 7	8477	STATE 2	8487	STATE 1	8497	STATE 1	

Actual signals and parameters

What this chapter contains

The chapter describes the actual signals and parameters and gives the fieldbus equivalent values for each signal/parameter.

Terms and abbreviations

Term	Definition
Actual signal	Signal measured or calculated by the drive. Can be monitored by the user. No user setting possible. Groups 01...04 contain actual signals.
Def	Parameter default value
Parameter	A user-adjustable operation instruction of the drive. Groups 10...99 contain parameters. Note: Parameter selections are shown on the basic control panel as integer values. E.g. parameter 1001 EXT1 COMMANDS selection COMM is shown as value 10 (which is equal to the fieldbus equivalent FbEq).
FbEq	Fieldbus equivalent: The scaling between the value and the integer used in serial communication.

Fieldbus addresses

For FPBA-01 Profibus Adapter, FDNA-01 DeviceNet Adapter and FCAN-01 CANopen Adapter, see the fieldbus adapter user's manual.

Fieldbus equivalent

Example: If **2017** MAX TORQ 1 is set from external control system, an integer value of 1 corresponds to 0.1%. All the read and sent values are limited to 16 bits (-32768...32767).

Default values with different macros

When application macro is changed (9902 APPLIC MACRO), the software updates the parameter values to their default values. The following table includes the parameter default values for different macros. For other parameters, the default values are the same for all macros. See the following parameter list.

Index	Name/Selection	ABB STANDARD	3-WIRE	ALTERNATE	MOTOR POT	HAND/AUTO	PID CONTROL	TORQ CTRL
1001	EXT1 COMMANDS	DI1,2	DI1P,2P,3	DI1F,2R	DI1,2	DI1,2	DI1	DI1,2
1002	EXT2 COMMANDS	NOT SEL	NOT SEL	NOT SEL	NOT SEL	DI5,4	DI5	DI1,2
1003	DIRECTION	REQUEST	REQUEST	REQUEST	REQUEST	REQUEST	FORWARD	REQUEST
1102	EXT1/EXT2 SEL	EXT1	EXT1	EXT1	EXT1	DI3	DI2	DI3
1103	REF1 SELECT	AI1	AI1	AI1	DI3U,4D(NC)	AI1	AI1	AI1
1106	REF2 SELECT	AI2	AI2	AI2	AI2	AI2	PID1OUT	AI2
1201	CONST SPEED SEL	DI3,4	DI4,5	DI3,4	DI5	NOT SEL	DI3	DI4
1304	MINIMUM AI2	0	0	0	0	20	20	20
1501	AO1 CONTENT SEL	103	102	102	102	102	102	102
1601	RUN ENABLE	NOT SEL	NOT SEL	NOT SEL	NOT SEL	NOT SEL	DI4	NOT SEL
2201	ACC/DEC 1/2 SEL	DI5	NOT SEL	DI5	NOT SEL	NOT SEL	NOT SEL	DI5
3201	SUPERV 1 PARAM	103	102	102	102	102	102	102
3401	SIGNAL1 PARAM	103	102	102	102	102	102	102
9902	APPLIC MACRO	ABB STANDARD	3-WIRE	ALTERNATE	MOTOR POT	HAND/AUTO	PID CTRL	TORQUE CTRL
9904	MOTOR CTRL MODE	SCALAR: FREQ	VECTOR: SPEED	VECTOR: SPEED	VECTOR: SPEED	VECTOR: SPEED	VECTOR: SPEED	VECTOR: TORQ

Actual signals

Actual signals			
No.	Name/Value	Description	FbEq
01 OPERATING DATA		Basic signals for monitoring the drive (read-only)	
0101	SPEED & DIR	Calculated motor speed in rpm. A negative value indicates reverse direction.	1 = 1 rpm
0102	SPEED	Calculated motor speed in rpm	1 = 1 rpm
0103	OUTPUT FREQ	Calculated drive output frequency in Hz. (Shown by default on the panel Output mode display.)	1 = 0.1 Hz
0104	CURRENT	Measured motor current in A. (Shown by default on the panel Output mode display.)	1 = 0.1 A
0105	TORQUE	Calculated motor torque in percent of the motor nominal torque	1 = 0.1%
0106	POWER	Measured motor power in kW	1 = 0.1 kW
0107	DC BUS VOLTAGE	Measured intermediate circuit voltage in VDC	1 = 1 V
0109	OUTPUT VOLTAGE	Calculated motor voltage in VAC	1 = 1 V
0110	DRIVE TEMP	Measured IGBT temperature in °C	1 = 0.1°C
0111	EXTERNAL REF 1	External reference REF1 in rpm or Hz. Unit depends on parameter 9904 MOTOR CTRL MODE setting.	1 = 0.1 Hz / 1 rpm
0112	EXTERNAL REF 2	External reference REF2 in percent. Depending on the use, 100% equals the maximum motor speed, nominal motor torque, or maximum process reference.	1 = 0.1%
0113	CTRL LOCATION	Active control location. (0) LOCAL; (1) EXT1; (2) EXT2. See section Local control vs. external control on page 97 .	1 = 1
0114	RUN TIME (R)	Elapsed drive running time counter (hours). The counter can be reset by pressing the UP and DOWN buttons simultaneously when the control panel is in Parameter mode.	1 = 1 h
0115	KWH COUNTER (R)	kWh counter. The counter can be reset by pressing UP and DOWN buttons simultaneously when the control panel is in Parameter mode.	1 = 1 kWh
0120	AI1	Relative value of analog input AI1 in percent	1 = 0.1%
0121	AI2	Relative value of analog input AI2 in percent	1 = 0.1%
0124	AO1	Value of analog output AO in mA	1 = 0.1 mA
0126	PID 1 OUTPUT	Output value of the process PID1 controller in percent	1 = 0.1%
0127	PID 2 OUTPUT	Output value of the PID2 controller in percent	1 = 0.1%
0128	PID 1 SETPNT	Setpoint signal (reference) for the process PID1 controller. Unit depends on parameter 4006 UNIT, 4007 UNIT SCALE and 4027 PID 1 PARAM SET settings.	-
0129	PID 2 SETPNT	Setpoint signal (reference) for the PID2 controller. Unit depends on parameter 4106 UNIT and 4107 UNIT SCALE settings.	-
0130	PID 1 FBK	Feedback signal for the process PID1 controller. Unit depends on parameter 4006 UNIT, 4007 UNIT SCALE and 4027 PID 1 PARAM SET settings.	-
0131	PID 2 FBK	Feedback signal for the PID2 controller. Unit depends on parameter 4106 UNIT and 4107 UNIT SCALE settings.	-
0132	PID 1 DEVIATION	Deviation of the process PID1 controller, i.e. the difference between the reference value and the actual value. Unit depends on parameter 4006 UNIT, 4007 UNIT SCALE and 4027 PID 1 PARAM SET settings.	-

Actual signals			
No.	Name/Value	Description	FbEq
0133	PID 2 DEVIATION	Deviation of the PID2 controller, i.e. the difference between the reference value and the actual value. Unit depends on parameter 4106 UNIT and 4107 UNIT SCALE settings.	-
0134	COMM RO WORD	Relay output Control Word through fieldbus (decimal). See parameter 1401 RELAY OUTPUT 1.	1 = 1
0135	COMM VALUE 1	Data received from fieldbus	1 = 1
0136	COMM VALUE 2	Data received from fieldbus	1 = 1
0137	PROCESS VAR 1	Process variable 1 defined by parameter group 34 PANEL DISPLAY	-
0138	PROCESS VAR 2	Process variable 2 defined by parameter group 34 PANEL DISPLAY	-
0139	PROCESS VAR 3	Process variable 3 defined by parameter group 34 PANEL DISPLAY	-
0140	RUN TIME	Elapsed time counter (thousands of hours). Runs when the drive is running. Counter cannot be reset.	1 = 0.01 kh
0141	MWH COUNTER	MWH counter. Counter cannot be reset.	1 = 1 MWh
0142	REVOLUTION CNTR	Motor revolution counter (millions of revolutions). The counter can be reset by pressing UP and DOWN buttons simultaneously when the control panel is in Parameter mode.	1 = 1 Mrev
0143	DRIVE ON TIME HI	Drive control board power-on time in days. Counter cannot be reset.	1 = 1 days
0144	DRIVE ON TIME LO	Drive control board power-on time in 2 second ticks (30 ticks = 60 seconds). Counter cannot be reset.	
0145	MOTOR TEMP	Measured motor temperature. Unit depends on the sensor type selected by group 35 MOTOR TEMP MEAS parameters.	1 = 1
0146	MECH ANGLE	Calculated mechanical angle	1 = 1
0147	MECH REVS	Mechanical revolutions, i.e. the motor shaft revolutions calculated by the encoder	1 = 1
0148	Z PLS DETECTED	Encoder zero pulse detector. 0 = not detected, 1 = detected.	1 = 1
0158	PID COMM VALUE 1	Data received from fieldbus for PID control (PID1 and PID2)	1 = 1
0159	PID COMM VALUE 2	Data received from fieldbus for PID control (PID1 and PID2)	1 = 1
0160	DI 1-5 STATUS	Status of digital inputs. Example: 10000 = DI1 is on, DI2...DI5 are off.	
0161	PULSE INPUT FREQ	Value of frequency input in Hz	1 = 1 Hz
0162	RO STATUS	Status of relay output. 1 = RO is energised, 0 = RO is de-energised.	1 = 1
0163	TO STATUS	Status of transistor output, when transistor output is used as a digital output.	1 = 1
0164	TO FREQUENCY	Transistor output frequency, when transistor output is used as a frequency output.	1 = 1 Hz
0165	TIMER VALUE	Timer value of timed start/stop. See parameter group 19 TIMER & COUNTER.	1 = 0.01 s
0166	COUNTER VALUE	Pulse counter value of counter start/stop. See parameter group 19 TIMER & COUNTER.	1 = 1
0167	SEQ PROG STS	Status Word of the sequence programming: Bit 0 = ENABLED (1 = enabled) Bit 1 = STARTED Bit 2 = PAUSED Bit 3 = LOGIC VALUE (logic operation defined by parameters 8406 ... 8410).	1 = 1
0168	SEQ PROG STATE	Active state of the sequence programming. 1...8 = state 1...8.	1 = 1

Actual signals			
No.	Name/Value	Description	FbEq
0169	SEQ PROG TIMER	Current state time counter of the sequence programming	
0170	SEQ PROG AO VAL	Analog output control values defined by sequence programming. See parameter 8423 ST1 OUT CONTROL.	1 = 0.1%
0171	SEQ CYCLE CNTR	Executed sequence counter of the sequence programming. See parameters 8415 CYCLE CNT LOC and 8416 CYCLE CNT RST.	1 = 1
0172	ABS TORQUE	Calculated absolute value of the motor torque in percent of the motor nominal torque	1 = 0.1%
03 FB ACTUAL SIGNALS		Data words for monitoring the fieldbus communication (read-only). Each signal is a 16-bit data word. Data words are displayed on the panel in hexadecimal format.	
0301	FB CMD WORD 1	A 16-bit data word. See section DCU communication profile on page 262 .	
0302	FB CMD WORD 2	A 16-bit data word. See section DCU communication profile on page 262	
0303	FB STS WORD 1	A 16-bit data word. See section DCU communication profile on page 262 .	
0304	FB STS WORD 2	A 16-bit data word. See section DCU communication profile on page 262	
0305	FAULT WORD 1	A 16-bit data word. For the possible causes and remedies and fieldbus equivalents, see chapter Fault tracing .	
		Bit 0 = OVERCURRENT	
		Bit 1 = DC OVERVOLT	
		Bit 2 = DEV OVERTEMP	
		Bit 3 = SHORT CIRC	
		Bit 4 = Reserved	
		Bit 5 = DC UNDERVOLT	
		Bit 6 = AI1 LOSS	
		Bit 7 = AI2 LOSS	
		Bit 8 = MOT OVERTEMP	
		Bit 9 = PANEL LOSS	
		Bit 10 = ID RUN FAIL	
		Bit 11 = MOTOR STALL	
		Bit 12 = Reserved	
		Bit 13 = EXT FAULT 1	
		Bit 14 = EXT FAULT 2	
		Bit 15 = EARTH FAULT	
0306	FAULT WORD 2	A 16-bit data word. For the possible causes and remedies and fieldbus equivalents, see chapter Fault tracing .	
		Bit 0 = UNDERLOAD	
		Bit 1 = THERM FAIL	
		Bit 2...3 = Reserved	
		Bit 4 = CURR MEAS	
		Bit 5 = SUPPLY PHASE	
		Bit 6 = ENCODER ERR	
		Bit 7 = OVERSPEED	
		Bit 8 = Reserved	

Actual signals			
No.	Name/Value	Description	FbEq
		Bit 9 = DRIVE ID	
		Bit 10 = CONFIG FILE	
		Bit 11 = SERIAL 1 ERR	
		Bit 12 = EFB CON FILE. Configuration file reading error.	
		Bit 13 = FORCE TRIP	
		Bit 14 = MOTOR PHASE	
		Bit 15 = OUTP WIRING	
0307	FAULT WORD 3	A 16-bit data word. For the possible causes and remedies and fieldbus equivalents, see chapter Fault tracing .	
		Bit 0...2 = Reserved	
		Bit 3 = INCOMPATIBLE SW	
		Bit 4...10 = Reserved	
		Bit 11 = MMIO ID ERROR	
		Bit 12 = DSP STACK ERROR	
		Bit 13 = DSP T1...T3 OVERLOAD	
		Bit 14 = SERF CORRUPT /SERF MACRO	
		Bit 15 = PAR PCU 1/2 / PAR HZRPM / PAR AI SCALE / PAR AO SCALE / PAR FBUS MISS / PAR CUSTOM U/F	
0308	ALARM WORD 1	A 16-bit data word. For the possible causes and remedies and fieldbus equivalents, see chapter Fault tracing . An alarm can be reset by resetting the whole alarm word: Write zero to the word.	
		Bit 0 = OVERCURRENT	
		Bit 1 = OVERVOLTAGE	
		Bit 2 = UNDERVOLTAGE	
		Bit 3 = DIRLOCK	
		Bit 4 = IO COMM	
		Bit 5 = AI1 LOSS	
		Bit 6 = AI2 LOSS	
		Bit 7 = PANEL LOSS	
		Bit 8 = DEVICE OVERTEMP	
		Bit 9 = MOTOR TEMP	
		Bit 10 = UNDERLOAD	
		Bit 11 = MOTOR STALL	
		Bit 12 = AUTORESET	
		Bit 13...15 = Reserved	
0309	ALARM WORD 2	A 16-bit data word. For the possible causes and remedies and fieldbus equivalents, see chapter Fault tracing . An alarm can be reset by resetting the whole alarm word: Write zero to the word.	
		Bit 0 = Reserved	
		Bit 1 = PID SLEEP	
		Bit 2 = ID RUN	

Actual signals			
No.	Name/Value	Description	FbEq
		Bit 3 = Reserved	
		Bit 4 = START ENABLE 1 MISSING	
		Bit 5 = START ENABLE 2 MISSING	
		Bit 6 = EMERGENCY STOP	
		Bit 7 = ENCODER ERROR	
		Bit 8 = FIRST START	
		Bit 9 = INPUT PHASE LOSS	
		Bit 10...15 = Reserved	
04 FAULT HISTORY		Fault history (read-only)	
0401	LAST FAULT	Code of the latest fault. See chapter Fault tracing for the codes. 0 = Fault history is clear (on panel display = NO RECORD).	1 = 1
0402	FAULT TIME 1	Day on which the latest fault occurred. Format: Date if the real time clock is operating. / The number of days elapsed after the power-on if the real time clock is not used, or was not set.	1 = 1 days
0403	FAULT TIME 2	Time at which the latest fault occurred. Format on the assistant panel: Real time (hh:mm:ss) if the real time clock is operating. / Time elapsed after the power-on (hh:mm:ss minus the whole days stated by signal 0402 FAULT TIME 1) if real time clock is not used, or was not set. Format on the basic panel: Time elapsed after power-on in 2 second ticks (minus the whole days stated by signal 0402 FAULT TIME 1). 30 ticks = 60 seconds. E.g. Value 514 equals 17 minutes and 8 seconds (= 514/30).	
0404	SPEED AT FLT	Motor speed in rpm at the time the latest fault occurred	1 = 1 rpm
0405	FREQ AT FLT	Frequency in Hz at the time the latest fault occurred	1 = 0.1 Hz
0406	VOLTAGE AT FLT	Intermediate circuit voltage in VDC at the time the latest fault occurred	1 = 0.1 V
0407	CURRENT AT FLT	Motor current in A at the time the latest fault occurred	1 = 0.1 A
0408	TORQUE AT FLT	Motor torque in percent of the motor nominal torque at the time the latest fault occurred	1 = 0.1%
0409	STATUS AT FLT	Drive status in hexadecimal format at the time the latest fault occurred	
0412	PREVIOUS FAULT 1	Fault code of the 2nd latest fault. See chapter Fault tracing for the codes.	1 = 1
0413	PREVIOUS FAULT 2	Fault code of the 3rd latest fault. See chapter Fault tracing for the codes.	1 = 1
0414	DI 1-5 AT FLT	Status of digital inputs DI1...5 at the time the latest fault occurred (binary)	

Parameters – short form list

Parameters – short form list				
Index	Name/Selection	Description	Def	Custom
10	START/STOP/DIR	The sources for external start, stop and direction control		
1001	EXT1 COMMANDS	Defines the connections and the source for the start, stop and direction commands for external control location 1 (EXT1).	DI1,2	
1002	EXT2 COMMANDS	Defines the connections and the source for the start, stop and direction commands for external control location 2 (EXT2).	NOT SEL	
1003	DIRECTION	Enables the control of rotation direction of the motor, or fixes the direction.	REQUEST	
1010	JOGGING SEL	Defines the signal that activates the jogging function.	NOT SEL	
11	REFERENCE SELECT	Panel reference type, external control location selection and external reference sources and limits		
1101	KEYPAD REF SEL	Selects the type of the reference in local control mode.	REF1	
1102	EXT1/EXT2 SEL	Defines the source from which the drive reads the signal that selects between the two external control locations, EXT1 or EXT2.	EXT1	
1103	REF1 SELECT	Selects the signal source for external reference REF1.	AI1	
1104	REF1 MIN	Defines the minimum value for external reference REF1.	0	
1105	REF1 MAX	Defines the maximum value for external reference REF1.	Eur: 50 / US: 60	
1106	REF2 SELECT	Selects the signal source for external reference REF2.	AI2	
1107	REF2 MIN	Defines the minimum value for external reference REF2.	0	
1108	REF2 MAX	Defines the maximum value for external reference REF2.	100	
12	CONSTANT SPEEDS	Constant speed selection and values.		
1201	CONST SPEED SEL	Activates the constant speeds or selects the activation signal.	DI3,4	
1202	CONST SPEED 1	Defines constant speed (or drive output frequency) 1.	Eur: 5 / US: 6	
1203	CONST SPEED 2	Defines constant speed (or drive output frequency) 2.	Eur: 10 / US: 12	
1204	CONST SPEED 3	Defines constant speed (or drive output frequency) 3.	Eur: 15 / US: 18	
1205	CONST SPEED 4	Defines constant speed (or drive output frequency) 4.	Eur: 20 / US: 24	
1206	CONST SPEED 5	Defines constant speed (or drive output frequency) 5.	Eur: 25 / US: 30	
1207	CONST SPEED 6	Defines constant speed (or drive output frequency) 6.	Eur: 40 / US: 48	
1208	CONST SPEED 7	Defines constant speed (or drive output frequency) 7.	Eur: 50 / US: 60	
1209	TIMED MODE SEL	Selects timed function activated speed into use when parameter 1201 CONST SPEED SEL selection is TIMED FUN1&2.	CS1/2/3/4	
13	ANALOGUE INPUTS	Analog input signal processing		
1301	MINIMUM AI1	Defines the minimum %-value that corresponds to minimum mA(V) signal for analog input AI1.	0,01	
1302	MAXIMUM AI1	Defines the maximum %-value that corresponds to maximum mA(V) signal for analog input AI1.	100	
1303	FILTER AI1	Defines the filter time constant for analog input AI1, i.e the time within 63% of a step change is reached.	0.1	
1304	MINIMUM AI2	Defines the minimum %-value that corresponds to minimum mA(V) signal for analog input AI2.	0,01	
1305	MAXIMUM AI2	Defines the maximum %-value that corresponds to maximum mA(V) signal for analog input AI2.	100	
1306	FILTER AI2	Defines the filter time constant for analog input AI2.	0.1	
14	RELAY OUTPUTS	Status information indicated through relay output, and relay operating delays		
1401	RELAY OUTPUT 1	Selects a drive status indicated through relay output RO.	FAULT(-1)	
1404	RO 1 ON DELAY	Defines the operation delay for relay output RO.	0	
1405	RO 1 OFF DELAY	Defines the release delay for relay output RO.	0	
15	ANALOGUE OUTPUTS	Selection of the actual signals to be indicated through analog output and output signal processing		
1501	AO1 CONTENT SEL	Connects a drive signal to analog output AO.	103	

Parameters – short form list				
Index	Name/Selection	Description	Def	Custom
1502	AO1 CONTENT MIN	Defines the minimum value for signal selected with parameter 1501 AO1 CONTENT SEL.	-	
1503	AO1 CONTENT MAX	Defines the maximum value for signal selected with parameter 1501 AO1 CONTENT SEL.	-	
1504	MINIMUM AO1	Defines the minimum value for the analog output signal AO.	0	
1505	MAXIMUM AO1	Defines the maximum value for the analog output signal AO.	20	
1506	FILTER AO1	Defines the filter time constant for analog output AO, i.e the time within 63% of a step change is reached.	0.1	
16	SYSTEM CONTROLS	Run Enable, parameter lock etc.		
1601	RUN ENABLE	Selects a source for the external Run Enable signal.	NOT SEL	
1602	PARAMETER LOCK	Selects the state of the parameter lock.	OPEN	
1603	PASS CODE	Selects the pass code for the parameter lock.	0	
1604	FAULT RESET SEL	Selects the source for the fault reset signal.	KEYPAD	
1605	USER PAR SET CHG	Enables the change of the User Parameter Set through a digital input.	NOT SEL	
1606	LOCAL LOCK	Disables entering local control mode or selects the source for the local control mode lock signal.	NOT SEL	
1607	PARAM SAVE	Saves the valid parameter values to the permanent memory.	DONE	
1608	START ENABLE 1	Selects the source for the Start Enable 1 signal.	NOT SEL	
1609	START ENABLE 2	Selects the source for the Start Enable 2 signal.	NOT SEL	
1610	DISPLAY ALARMS	Activates/deactivates alarms.	NO	
1611	PARAMETER VIEW	Selects the parameter view, i.e which parameters are shown.	DEFAULT	
18	FREQ IN & TRAN OUT	Frequency input and transistor output signal processing.		
1801	FREQ INPUT MIN	Defines the minimum input value when DI5 is used as a frequency input.	0	
1802	FREQ INPUT MAX	Defines the maximum input value when DI5 is used as a frequency input.	1000	
1803	FILTER FREQ IN	Defines the filter time constant for frequency input.	0.1	
1804	TO MODE	Selects the operation mode for the transistor output TO.	DIGITAL	
1805	DO SIGNAL	Selects a drive status indicated through digital output DO.	FAULT(-1)	
1806	DO ON DELAY	Defines the operation delay for digital output DO.	0	
1807	DO OFF DELAY	Defines the release delay for digital output DO.	0	
1808	FO CONTENT SEL	Selects a drive signal to be connected to frequency output FO.	104	
1809	FO CONTENT MIN	Defines the minimum frequency output FO signal value.	-	
1810	FO CONTENT MAX	Defines the maximum frequency output FO signal value.	-	
1811	MINIMUM FO	Defines the minimum value for frequency output FO.	10	
1812	MAXIMUM FO	Defines the maximum value for frequency output FO.	1000	
1813	FILTER FO	Defines the filter time constant for frequency output FO.	0.1	
19	TIMER & COUNTER	Timer and counter for start and stop control		
1901	TIMER DELAY	Defines the time delay for the timer.	10	
1902	TIMER START	Selects the source for the timer start signal.	NOT SEL	
1903	TIMER RESET	Selects the source for the timer reset signal.	NOT SEL	
1904	COUNTER ENABLE	Selects the source for the counter enable signal.	DISABLED	
1905	COUNTER LIMIT	Defines the counter limit.	1000	
1906	COUNTER INPUT	Selects the input signal source for the counter.	PLS IN(DI5)	
1907	COUNTER RESET	Selects the source for the counter reset signal.	NOT SEL	
1908	COUNTER RES VAL	Defines the value for the counter after reset.	0	
1909	COUNT DIVIDER	Defines the divider for the pulse counter.	0	
1910	COUNT DIRECTION	Defines the source for the counter direction selection.	UP	
1911	CNTR S/S COMMAND	Selects the source for the drive start/stop command when parameter 1001 EXT1 COMMANDS value is set to COUNTER START / COUNTER STOP.	NOT SEL	

Parameters – short form list				
Index	Name/Selection	Description	Def	Custom
20	LIMITS	Drive operation limits.		
2001	MINIMUM SPEED	Defines the allowed minimum speed.	0	
2002	MAXIMUM SPEED	Defines the allowed maximum speed.	Eur: 1500 / US: 1800	
2003	MAX CURRENT	Defines the allowed maximum motor current.	1.8 ² I2N	
2005	OVERVOLT CTRL	Activates or deactivates the overvoltage control of the intermediate DC link.	ENABLE	
2006	UNDERVOLT CTRL	Activates or deactivates the undervoltage control of the intermediate DC link.	ENABLE(TIME)	
2007	MINIMUM FREQ	Defines the minimum limit for the drive output frequency.	0	
2008	MAXIMUM FREQ	Defines the maximum limit for the drive output frequency.	Eur: 50 / US: 60	
2013	MIN TORQUE SEL	Selects the minimum torque limit for the drive.	MIN TORQUE 1	
2014	MAX TORQUE SEL	Selects the maximum torque limit for the drive.	MAX TORQUE 1	
2015	MIN TORQUE 1	Defines minimum torque limit 1 for the drive.	-300	
2016	MIN TORQUE 2	Defines minimum torque limit 2 for the drive.	-300	
2017	MAX TORQUE 1	Defines maximum torque limit 1 for the drive.	300	
2018	MAX TORQUE 2	Defines maximum torque limit 2 for the drive.	300	
2019	BRAKE CHOPPER	Phased out parameter in sw version 2.51b and later.		
2020	BRAKE CHOPPER	Selects the brake chopper control.	INBUILT	
21	START/STOP	Start and stop modes of the motor		
2101	START FUNCTION	Selects the motor starting method.	AUTO	
2102	STOP FUNCTION	Selects the motor stop function.	COAST	
2103	DC MAGN TIME	Defines the pre-magnetising time.	0.3	
2104	DC HOLD CTL	Activates the DC Hold or DC braking function.	NOT SEL	
2105	DC HOLD SPEED	Defines the DC hold speed.	5	
2106	DC CURR REF	Defines the DC hold current.	30	
2107	DC BRAKE TIME	Defines the DC brake time.	0	
2108	START INHIBIT	Enables the start inhibit function.	OFF	
2109	EMER STOP SEL	Selects the source for the external emergency stop command.	NOT SEL	
2110	TORQ BOOST CURR	Defines the maximum supplied current during torque boost.	100	
2111	STOP SIGNAL DLY	Defines the stop signal delay time when parameter 2102 STOP FUNCTION is set to SPEED COMP.	0	
2112	ZERO SPEED DELAY	Defines the delay for the Zero Speed Delay function.	0	
22	ACCEL/DECEL	Acceleration and deceleration times		
2201	ACC/DEC 1/2 SEL	Defines the source from which the drive reads the signal that selects between the two ramp pairs.	DI5	
2202	ACCELER TIME 1	Defines the acceleration time 1.	5	
2203	DECELER TIME 1	Defines the deceleration time 1.	5	
2204	RAMP SHAPE 1	Selects the shape of the acceleration/deceleration ramp 1.	0	
2205	ACCELER TIME 2	Defines the acceleration time 2.	60	
2206	DECELER TIME 2	Defines the deceleration time 2.	60	
2207	RAMP SHAPE 2	Selects the shape of the acceleration/deceleration ramp 2.	0	
2208	EMER DEC TIME	Defines the time within the drive is stopped if an emergency stop is activated.	1	
2209	RAMP INPUT 0	Defines the source for forcing the ramp input to zero.	NOT SEL	
23	SPEED CONTROL	Speed controller variables.		
2301	PROP GAIN	Defines a relative gain for the speed controller.	10	
2302	INTEGRATION TIME	Defines an integration time for the speed controller.	39204	
2303	DERIVATION TIME	Defines the derivation time for the speed controller.	0	
2304	ACC COMPENSATION	Defines the derivation time for acceleration/(deceleration) compensation.	0	
2305	AUTOTUNE RUN	Start automatic tuning of the speed controller.	OFF	

Parameters – short form list				
Index	Name/Selection	Description	Def	Custom
24	TORQUE CONTROL	Torque control variables		
2401	TORQ RAMP UP	Defines the torque reference ramp up time.	0	
2402	TORQ RAMP DOWN	Defines the torque reference ramp down time.	0	
25	CRITICAL SPEEDS	Speed bands within which the drive is not allowed to operate.		
2501	CRIT SPEED SEL	Activates/deactivates the critical speeds function.	OFF	
2502	CRIT SPEED 1 LO	Defines the minimum limit for critical speed/frequency range 1.	0	
2503	CRIT SPEED 1 HI	Defines the maximum limit for critical speed/frequency range 1.	0	
2504	CRIT SPEED 2 LO	See parameter 2502 CRIT SPEED 1 LO.	0	
2505	CRIT SPEED 2 HI	See parameter 2503 CRIT SPEED 1 HI.	0	
2506	CRIT SPEED 3 LO	See parameter 2502 CRIT SPEED 1 LO.	0	
2507	CRIT SPEED 3 HI	See parameter 2503 CRIT SPEED 1 HI.	0	
26	MOTOR CONTROL	Motor control variables		
2601	FLUX OPT ENABLE	Activates/deactivates the flux optimisation function.	OFF	
2602	FLUX BRAKING	Activates/deactivates the Flux Braking function.	OFF	
2603	IR COMP VOLT	Defines the output voltage boost at zero speed (IR compensation).	Varies	
2604	IR COMP FREQ	Defines the frequency at which the IR compensation is 0 V.	80	
2605	U/F RATIO	Selects the voltage to frequency (U/f) ratio below the field weakening point.	LINEAR	
2606	SWITCHING FREQ	Defines the switching frequency of the drive.	4	
2607	SWITCH FREQ CTRL	Activates the switching frequency control.	ON	
2608	SLIP COMP RATIO	Defines the slip gain for the motor slip compensation control.	0	
2609	NOISE SMOOTHING	Enables the noise smoothing function.	DISABLE	
2610	USER DEFINED U1	Defines the first voltage point of the custom U/f curve at the frequency defined by parameter 2611.	USER DEFINED F1.	
2611	USER DEFINED F1	Defines the first frequency point of the custom U/f curve.	10	
2612	USER DEFINED U2	Defines the second voltage point of the custom U/f curve at the frequency defined by parameter 2613.	USER DEFINED F2.	
2613	USER DEFINED F2	Defines the second frequency point of the custom U/f curve.	20	
2614	USER DEFINED U3	Defines the third voltage point of the custom U/f curve at the frequency defined by parameter 2615	USER DEFINED F3.	
2615	USER DEFINED F3	Defines the third frequency point of the custom U/f curve.	25	
2616	USER DEFINED U4	Defines the fourth voltage point of the custom U/f curve at the frequency defined by parameter 2617	USER DEFINED F4.	
2617	USER DEFINED F4	Defines the fourth frequency point of the custom U/f curve.	40	
2618	FW VOLTAGE	Defines the voltage of the U/f curve when frequency is equal to or exceeds the motor nominal frequency (9907 MOTOR NOM FREQ).	95% of UN	
29	MAINTENANCE TRIG	Maintenance triggers		
2901	COOLING FAN TRIG	Defines the trigger point for the drive cooling fan run time counter.	0	
2902	COOLING FAN ACT	Defines the actual value for the cooling fan run time counter.	0	
2903	REVOLUTION TRIG	Defines the trigger point for the motor revolution counter.	0	
2904	REVOLUTION ACT	Defines the actual value for the motor revolution counter.	0	
2905	RUN TIME TRIG	Defines the trigger point for the drive run time counter.	0	
2906	RUN TIME ACT	Defines the actual value for the drive run time counter.	0	
2907	USER MWh TRIG	Defines the trigger point for the drive power consumption counter.	0	
2908	USER MWh ACT	Defines the actual value of the drive power consumption counter.	0	
30	FAULT FUNCTIONS	Programmable protection functions		
3001	AI<MIN FUNCTION	Selects how the drive reacts when an analog input signal falls below the set minimum limit.	NOT SEL	

Parameters – short form list				
Index	Name/Selection	Description	Def	Custom
3002	PANEL COMM ERR	Selects how the drive reacts to a control panel communication break.	FAULT	
3003	EXTERNAL FAULT 1	Selects an interface for an external fault 1 signal.	NOT SEL	
3004	EXTERNAL FAULT 2	Selects an interface for an external fault 2 signal.	NOT SEL	
3005	MOT THERM PROT	Selects how the drive reacts when the motor overtemperature is detected.	FAULT	
3006	MOT THERM TIME	Defines the thermal time constant for the motor thermal model.	500	
3007	MOT LOAD CURVE	Defines the load curve together with parameters 3008 ZERO SPEED LOAD and 3009 BREAK POINT FREQ.	100	
3008	ZERO SPEED LOAD	Defines the load curve together with parameters 3007 MOT LOAD CURVE and 3009 BREAK POINT FREQ.	70	
3009	BREAK POINT FREQ	Defines the load curve together with parameters 3007 MOT LOAD CURVE and 3008 ZERO SPEED LOAD.	35	
3010	STALL FUNCTION	Selects how the drive reacts to a motor stall condition.	NOT SEL	
3011	STALL FREQUENCY	Defines the frequency limit for the stall function.	20	
3012	STALL TIME	Defines the time for the stall function.	20	
3013	UNDERLOAD FUNC	Selects how the drive reacts to underload.	NOT SEL	
3014	UNDERLOAD TIME	Defines the time limit for the underload function.	20	
3015	UNDERLOAD CURVE	Selects the load curve for the underload function.	1	
3016	SUPPLY PHASE	Selects how the drive reacts to supply phase loss, i.e. when DC voltage ripple is excessive.	FAULT	
3017	EARTH FAULT	Selects how the drive reacts when an earth (ground) fault is detected in the motor or the motor cable.	ENABLE	
3018	COMM FAULT FUNC	Selects how the drive reacts in a fieldbus communication break.	NOT SEL	
3019	COMM FAULT TIME	Defines the time delay for the fieldbus communication break supervision.	3	
3021	AI1 FAULT LIMIT	Defines a fault level for analog input AI1.	MINIMUM AI1.	
3022	AI2 FAULT LIMIT	Defines a fault level for analog input AI2.	MINIMUM AI2.	
3023	WIRING FAULT	Selects how the drive reacts when incorrect input power and motor cable connection is detected.	ENABLE	
31	AUTOMATIC RESET	Automatic fault reset.		
3101	NR OF TRIALS	Defines the number of automatic fault resets the drive performs within the time defined by parameter 3102 TRIAL TIME.	0	
3102	TRIAL TIME	Defines the time for the automatic fault reset function.	30	
3103	DELAY TIME	Defines the time that the drive will wait after a fault before attempting an automatic reset.	0	
3104	AR OVERCURRENT	Activates/deactivates the automatic reset for the overcurrent fault.	DISABLE	
3105	AR OVERVOLTAGE	Activates/deactivates the automatic reset for the intermediate link overvoltage fault.	DISABLE	
3106	AR UNDERVOLTAGE	Activates/deactivates the automatic reset for the intermediate link undervoltage fault.	DISABLE	
3107	AR AI<MIN	Activates/deactivates the automatic reset for fault AI<MIN.	DISABLE	
3108	AR EXTERNAL FLT	Activates/deactivates the automatic reset for the EXTERNAL FAULT 1/2.	DISABLE	
32	SUPERVISION	Signal supervision. Supervision status can be monitored with relay or transistor output.		
3201	SUPERV 1 PARAM	Selects the first supervised signal.	103	
3202	SUPERV 1 LIM LO	Defines the low limit for the first supervised signal selected by parameter 3201 SUPERV 1 PARAM.	-	
3203	SUPERV 1 LIM HI	Defines the high limit for the first supervised signal selected by parameter 3201 SUPERV 1 PARAM.	-	
3204	SUPERV 2 PARAM	Selects the second supervised signal.	104	
3205	SUPERV 2 LIM LO	Defines the low limit for the second supervised signal selected by parameter 3204 SUPERV 2 PARAM.	-	

Parameters – short form list				
Index	Name/Selection	Description	Def	Custom
3206	SUPERV 2 LIM HI	Defines the high limit for the second supervised signal selected by parameter 3204 SUPERV 2 PARAM.	-	
3207	SUPERV 3 PARAM	Selects the third supervised signal.	105	
3208	SUPERV 3 LIM LO	Defines the low limit for the third supervised signal selected by parameter 3207 SUPERV 3 PARAM.	-	
3209	SUPERV 3 LIM HI	Defines the high limit for the third supervised signal selected by parameter 3207 SUPERV 3 PARAM.	-	
33	INFORMATION	Firmware package version, test date etc.		
3301	FIRMWARE	Displays the version of the firmware package.		
3302	LOADING PACKAGE	Displays the version of the loading package.	type dependent	
3303	TEST DATE	Displays the test date.	00.00	
3304	DRIVE RATING	Displays the drive current and voltage ratings.	0x0000	
3305	PARAMETER TABLE	Displays the version of the parameter table used in the drive.		
34	PANEL DISPLAY	Selection of actual signals to be displayed on the panel		
3401	SIGNAL1 PARAM	Selects the first signal to be displayed on the control panel in display mode.	103	
3402	SIGNAL1 MIN	Defines the minimum value for the signal selected by parameter 3401 SIGNAL1 PARAM.	-	
3403	SIGNAL1 MAX	Defines the maximum value for the signal selected by parameter 3401 SIGNAL1 PARAM.	-	
3404	OUTPUT1 DSP FORM	Defines the format for the displayed signal (selected by par. 3401 SIGNAL1 PARAM).	DIRECT	
3405	OUTPUT1 UNIT	Selects the unit for the for the displayed signal selected by parameter 3401 SIGNAL1 PARAM.	Hz	
3406	OUTPUT1 MIN	Sets the minimum display value for the signal selected by parameter 3401 SIGNAL1 PARAM.	-	
3407	OUTPUT1 MAX	Sets the maximum display value for the signal selected by parameter 3401 SIGNAL1 PARAM.	-	
3408	SIGNAL2 PARAM	Selects the second signal to be displayed on the control panel in display mode.	104	
3409	SIGNAL2 MIN	Defines the minimum value for the signal selected by parameter 3408 SIGNAL2 PARAM.	-	
3410	SIGNAL2 MAX	Defines the maximum value for the signal selected by parameter 3408 SIGNAL2 PARAM.	-	
3411	OUTPUT2 DSP FORM	Defines the format for the displayed signal selected by par. 3408 SIGNAL2 PARAM.	DIRECT	
3412	OUTPUT2 UNIT	Selects the unit for the for the displayed signal selected by parameter 3408 SIGNAL2 PARAM.	-	
3413	OUTPUT2 MIN	Sets the minimum display value for the signal selected by parameter 3408 SIGNAL2 PARAM.	-	
3414	OUTPUT2 MAX	Sets the maximum display value for the signal selected by parameter 3408 SIGNAL2 PARAM.	-	
3415	SIGNAL3 PARAM	Selects the third signal to be displayed on the control panel in display mode.	105	
3416	SIGNAL3 MIN	Defines the minimum value for the signal selected by parameter 3415.	-	
3417	SIGNAL3 MAX	Defines the maximum value for the signal selected by parameter 3415 SIGNAL3 PARAM.	-	
3418	OUTPUT3 DSP FORM	Defines the format for the displayed signal selected by par. 3415 SIGNAL3 PARAM.	DIRECT	
3419	OUTPUT3 UNIT	Selects the unit for the for the displayed signal selected by parameter 3415 SIGNAL3 PARAM.	-	
3420	OUTPUT3 MIN	Sets the minimum display value for the signal selected by parameter 3415 SIGNAL3 PARAM.	-	

Parameters – short form list				
Index	Name/Selection	Description	Def	Custom
3421	OUTPUT3 MAX	Sets the maximum display value for the signal selected by parameter 3415 SIGNAL3 PARAM.	-	
35	MOTOR TEMP MEAS	Motor temperature measurement.		
3501	SENSOR TYPE	Activates the motor temperature measurement function and selects the sensor type.	NONE	
3502	INPUT SELECTION	Selects the source for the motor temperature measurement signal.	A11	
3503	ALARM LIMIT	Defines the alarm limit for motor temperature measurement.	0	
3504	FAULT LIMIT	Defines the fault trip limit for motor temperature measurement.	0	
3505	AO EXCITATION	Enables current feed from analog output AO.	DISABLE	
36	TIMED FUNCTIONS	Time periods 1 to 4 and booster signal.		
3601	TIMERS ENABLE	Selects the source for the timed function enable signal.	NOT SEL	
3602	START TIME 1	Defines the daily start time 1.	0	
3603	STOP TIME 1	Defines the daily stop time 1.	0	
3604	START DAY 1	Defines the start day 1.	MONDAY	
3605	STOP DAY 1	Defines the stop day 1.	MONDAY	
3606	START TIME 2	See parameter 3602 START TIME 1.		
3607	STOP TIME 2	See parameter 3603 STOP TIME 1.		
3608	START DAY 2	See parameter 3604 START DAY 1.		
3609	STOP DAY 2	See parameter 3605 STOP DAY 1.		
3610	START TIME 3	See parameter 3602 START TIME 1.		
3611	STOP TIME 3	See parameter 3603 STOP TIME 1.		
3612	START DAY 3	See parameter 3604 START DAY 1.		
3613	STOP DAY 3	See parameter 3605 STOP DAY 1.		
3614	START TIME 4	See parameter 3602 START TIME 1.		
3615	STOP TIME 4	See parameter 3603 STOP TIME 1.		
3616	START DAY 4	See parameter 3604 START DAY 1.		
3617	STOP DAY 4	See parameter 3605 STOP DAY 1.		
3622	BOOSTER SEL	Selects the source for the booster activation signal.	NOT SEL	
3623	BOOSTER TIME	Defines the time inside which the booster is deactivated after the booster activation signal is switched off.	0	
3626	TIMED FUNC 1 SRC	Selects the time periods for TIMED FUNC 1 SRC.	NOT SEL	
3627	TIMED FUNC 2 SRC	See parameter 3626 TIMED FUNC 1 SRC.		
3628	TIMED FUNC 3 SRC	See parameter 3626 TIMED FUNC 1 SRC.		
3629	TIMED FUNC 4 SRC	See parameter 3626 TIMED FUNC 1 SRC.		
40	PROCESS PID SET 1	Process PID (PID1) control parameter set 1.		
4001	GAIN	Defines the gain for the process PID controller.	1	
4002	INTEGRATION TIME	Defines the integration time for the process PID1 controller.	60	
4003	DERIVATION TIME	Defines the derivation time for the process PID controller.	0	
4004	PID DERIV FILTER	Defines the filter time constant for the derivative part of the process PID controller.	1	
4005	ERROR VALUE INV	Selects the relationship between the feedback signal and drive speed.	NO	
4006	UNITS	Selects the unit for PID controller actual values.	%	
4007	UNIT SCALE	Defines the decimal point location for the display parameter selected by parameter 4006 UNITS.	1	
4008	0% VALUE	Defines together with parameter 4009 100% VALUE the scaling applied to the PID controller's actual values.	0	
4009	100% VALUE	Defines together with parameter 4008 0% VALUE the scaling applied to the PID controller's actual values.	100	
4010	SET POINT SEL	Selects the source for the process PID controller reference signal.	A11	

Parameters – short form list				
Index	Name/Selection	Description	Def	Custom
4011	INTERNAL SETPNT	Selects a constant value as process PID controller reference, when parameter 4010 SET POINT SEL value is set to INTERNAL.	40	
4012	SETPOINT MIN	Defines the minimum value for the selected PID reference signal source.	0	
4013	SETPOINT MAX	Defines the maximum value for the selected PID reference signal source.	100	
4014	FBK SEL	Selects the process actual value (feedback signal) for the process PID controller.	ACT1	
4015	FBK MULTIPLIER	Defines an extra multiplier for the value defined by parameter 4014 FBK SEL.	0	
4016	ACT1 INPUT	Defines the source for actual value 1 (ACT1).	A12	
4017	ACT2 INPUT	Defines the source for actual value ACT2.	A12	
4018	ACT1 MINIMUM	Sets the minimum value for ACT1.	0	
4019	ACT1 MAXIMUM	Defines the maximum value for the variable ACT1 if an analog input is selected as a source for ACT1.	100	
4020	ACT2 MINIMUM	See parameter 4018 ACT1 MINIMUM.	0	
4021	ACT2 MAXIMUM	See parameter 4019 ACT1 MAXIMUM.	100	
4022	SLEEP SELECTION	Activates the sleep function and selects the source for the activation input.	NOT SEL	
4023	PID SLEEP LEVEL	Defines the start limit for the sleep function.	0	
4024	PID SLEEP DELAY	Defines the delay for the sleep start function.	60	
4025	WAKE-UP DEV	Defines the wake-up deviation for the sleep function.	0	
4026	WAKE-UP DELAY	Defines the wake-up delay for the sleep function.	0.5	
4027	PID 1 PARAM SET	Defines the source from which the drive reads the signal that selects between PID parameter set 1 and 2.	SET1	
41	PROCESS PID SET 2	Process PID (PID1) control parameter set 2.		
4101	GAIN	See parameter 4001 GAIN.		
4102	INTEGRATION TIME	See parameter 4002 INTEGRATION TIME.		
4103	DERIVATION TIME	See parameter 4003 DERIVATION TIME.		
4104	PID DERIV FILTER	See parameter 4004 PID DERIV FILTER.		
4105	ERROR VALUE INV	See parameter 4005 ERROR VALUE INV.		
4106	UNITS	See parameter 4006 UNITS.		
4107	UNIT SCALE	See parameter 4007 UNIT SCALE.		
4108	0% VALUE	See parameter 4008 0% VALUE.		
4109	100% VALUE	See parameter 4009 100% VALUE.		
4110	SET POINT SEL	See parameter 4010 SET POINT SEL.		
4111	INTERNAL SETPNT	See parameter 4011 INTERNAL SETPNT.		
4112	SETPOINT MIN	See parameter 4012 SETPOINT MIN.		
4113	SETPOINT MAX	See parameter 4013 SETPOINT MAX.		
4114	FBK SEL	See parameter 4014 FBK SEL.		
4115	FBK MULTIPLIER	See parameter 4015 FBK MULTIPLIER.		
4116	ACT1 INPUT	See parameter 4016 ACT1 INPUT.		
4117	ACT2 INPUT	See parameter 4017 ACT2 INPUT.		
4118	ACT1 MINIMUM	See parameter 4018 ACT1 MINIMUM.		
4119	ACT1 MAXIMUM	See parameter 4018 ACT1 MAXIMUM.		
4120	ACT2 MINIMUM	See parameter 4020 ACT2 MINIMUM.		
4121	ACT2 MAXIMUM	See parameter 4021 ACT2 MAXIMUM.		
4122	SLEEP SELECTION	See parameter 4022 SLEEP SELECTION.		
4123	PID SLEEP LEVEL	See parameter 4023 PID SLEEP LEVEL.		
4124	PID SLEEP DELAY	See parameter 4024 PID SLEEP DELAY.		
4125	WAKE-UP DEV	See parameter 4025 WAKE-UP DEV.		
4126	WAKE-UP DELAY	See parameter 4026 WAKE-UP DELAY.		

Parameters – short form list				
Index	Name/Selection	Description	Def	Custom
42	EXT / TRIM PID	External/Trim PID (PID2) control.		
4201	GAIN	See parameter 4001 GAIN.		
4202	INTEGRATION TIME	See parameter 4002 INTEGRATION TIME.		
4203	DERIVATION TIME	See parameter 4003 DERIVATION TIME.		
4204	PID DERIV FILTER	See parameter 4004 PID DERIV FILTER.		
4205	ERROR VALUE INV	See parameter 4005 ERROR VALUE INV.		
4206	UNITS	See parameter 4006 UNITS.		
4207	UNIT SCALE	See parameter 4007 UNIT SCALE.		
4208	0% VALUE	See parameter 4008 0% VALUE.		
4209	100% VALUE	See parameter 4009 100% VALUE.		
4210	SET POINT SEL	See parameter 4010 SET POINT SEL.		
4211	INTERNAL SETPNT	See parameter 4011 INTERNAL SETPNT.		
4212	SETPOINT MIN	See parameter 4012 SETPOINT MIN.		
4213	SETPOINT MAX	See parameter 4013 SETPOINT MAX.		
4214	FBK SEL	See parameter 4014 FBK SEL.		
4215	FBK MULTIPLIER	See parameter 4015 FBK MULTIPLIER.		
4216	ACT1 INPUT	See parameter 4016 ACT1 INPUT.		
4217	ACT2 INPUT	See parameter 4017 ACT2 INPUT.		
4218	ACT1 MINIMUM	See parameter 4018 ACT1 MINIMUM.		
4219	ACT1 MAXIMUM	See parameter 4018 ACT1 MAXIMUM.		
4220	ACT2 MINIMUM	See parameter 4020 ACT2 MINIMUM.		
4221	ACT2 MAXIMUM	See parameter 4021 ACT2 MAXIMUM.		
4228	ACTIVATE	Selects the source for the external PID function activation signal.	NOT SEL	
4229	OFFSET	Defines the offset for the external PID controller output.	0	
4230	TRIM MODE	Activates the trim function and selects between the direct and proportional trimming.	NOT SEL	
4231	TRIM SCALE	Defines the multiplier for the trimming function.	0	
4232	CORRECTION SRC	Selects the trim reference.	PID2REF	
4233	TRIM SELECTION	Selects whether the trimming is used for correcting the speed or torque reference.	SPEED/FREQ	
43	MECH BRK CONTROL	Control of a mechanical brake.		
4301	BRAKE OPEN DLY	Defines the brake open delay (= the delay between the internal open brake command and the release of the motor speed control).	0.20	
4302	BRAKE OPEN LVL	Defines the motor starting torque/current at brake release.	1	
4303	BRAKE CLOSE LVL	Defines the brake close speed.	4.0%	
4304	FORCED OPEN LVL	Defines the speed at brake release.	0	
4305	BRAKE MAGN DELAY	Defines motor magnetising time.	0	
4306	RUNTIME FREQ LVL	Defines the brake close speed.	0	
50	ENCODER	Encoder connection.		
5001	PULSE NR	States the number of encoder pulses per one revolution.	1024	
5002	ENCODER ENABLE	Enables the encoder.	DISABLE	
5003	ENCODER FAULT	Defines the operation of the drive if a failure is detected in communication between the pulse encoder and the pulse encoder interface module, or between the module and the drive.	FAULT	
5010	Z PLS ENABLE	Enables the encoder zero (Z) pulse. Zero pulse is used for position reset.	DISABLE	
5011	POSITION RESET	Enables the position reset.	DISABLE	
51	EXT COMM MODULE	Fieldbus adapter module parameters.		
5101	FBA TYPE	Displays the type of the connected fieldbus adapter module.		
5102	FB PAR 2	These parameters are adapter module-specific.		
...			
5126	FB PAR 26			

Parameters – short form list				
Index	Name/Selection	Description	Def	Custom
5127	FBA PAR REFRESH	Validates any changed adapter module configuration parameter settings.		
52	PANEL COMM	Communication settings for the control panel port on the drive		
5201	STATION ID	Defines the address of the drive.	1	
5202	BAUD RATE	Defines the transfer rate of the link.	39242	
5203	PARITY	Defines the use of parity and stop bit(s).	8 NONE 1	
5204	OK MESSAGES	Number of valid messages received by the drive.	0	
5205	PARITY ERRORS	Number of characters with a parity error received from the Modbus link.	0	
5206	FRAME ERRORS	Number of characters with a framing error received by the Modbus link.	0	
5207	BUFFER OVERRUNS	Number of characters which overflow the buffer, i.e. number of characters which exceed the maximum message length, 128 bytes.	0	
5208	CRC ERRORS	Number of messages with an CRC (cyclic redundancy check) error received by the drive.	0	
53	EFB PROTOCOL	Embedded fieldbus link settings.		
5302	EFB STATION ID	Defines the address of the device.	1	
5303	EFB BAUD RATE	Defines the transfer rate of the link.	39242	
5304	EFB PARITY	Defines the use of parity and stop bit(s) and the data length.	8 NONE 1	
5305	EFB CTRL PROFILE	Selects the communication profile.	ABB DRV LIM	
5306	EFB OK MESSAGES	Number of valid messages received by the drive.	0	
5307	EFB CRC ERRORS	Number of messages with an CRC (cyclic redundancy check) error received by the drive.	0	
5310	EFB PAR 10	Selects an actual value to be mapped to Modbus register 40005.	0	
5311	EFB PAR 11	Selects an actual value to be mapped to Modbus register 40006.	0	
5312	EFB PAR 12	Selects an actual value to be mapped to Modbus register 40007.	0	
5313	EFB PAR 13	Selects an actual value to be mapped to Modbus register 40008.	0	
5314	EFB PAR 14	Selects an actual value to be mapped to Modbus register 40009.	0	
5315	EFB PAR 15	Selects an actual value to be mapped to Modbus register 40010.	0	
5316	EFB PAR 16	Selects an actual value to be mapped to Modbus register 40011.	0	
5317	EFB PAR 17	Selects an actual value to be mapped to Modbus register 40012.	0	
5318	EFB PAR 18	Reserved	0	
5319	EFB PAR 19	ABB Drives profile (ABB DRV LIM or ABB DRV FULL) Control Word. Read only copy of the Fieldbus Control Word.	0x0000	
5320	EFB PAR 20	ABB Drives profile (ABB DRV LIM or ABB DRV FULL) Status Word. Read only copy of the Fieldbus Status Word.	0x0000	
54	FBA DATA IN	Data from drive to fieldbus controller.		
5401	FBA DATA IN 1	Selects data to be transferred from the drive to the fieldbus controller.		
5402	FBA DATA IN 2	See 5401 FBA DATA IN 1.		
....		
5410	FBA DATA IN 10	See 5401 FBA DATA IN 1.		
55	FBA DATA OUT	Data from fieldbus controller to drive.		
5501	FBA DATA OUT 1	Selects data to be transferred from the fieldbus controller to the drive.		
5502	FBA DATA OUT 2	See 5501 FBA DATA OUT 1.		
...		
5510	FBA DATA OUT 10	See 5501 FBA DATA OUT 1.		
84	SEQUENCE PROG	Sequence programming.		
8401	SEQ PROG ENABLE	Enables sequence programming.	DISABLED	
8402	SEQ PROG START	Selects the source for the sequence programming activation signal.	NOT SEL	

Parameters – short form list				
Index	Name/Selection	Description	Def	Custom
8403	SEQ PROG PAUSE	Selects the source for the sequence programming pause signal.	NOT SEL	
8404	SEQ PROG RESET	Selects the source for the sequence programming reset signal.	NOT SEL	
8405	SEQ ST FORCE	Forces the sequence programming to a selected state.	STATE1	
8406	SEQ LOGIC VAL 1	Defines the source for the logic value 1.	NOT SEL	
8407	SEQ LOGIC OPER 1	Selects the operation between logic value 1 and 2.	NOT SEL	
8408	SEQ LOGIC VAL 2	See parameter 8406 SEQ LOGIC VAL 1.	NOT SEL	
8409	SEQ LOGIC OPER 2	Selects the operation between logic value 3 and the result of the first logic operation defined by parameter 8407 SEQ LOGIC OPER 1.	NOT SEL	
8410	SEQ LOGIC VAL 3	See parameter 8406 SEQ LOGIC VAL 1.	NOT SEL	
8411	SEQ VAL 1 HIGH	Defines the high limit for the state change when parameter 8425 ST1 TRIG TO ST 2 is set to e.g. AI1 HIGH 1.	0	
8412	SEQ VAL 1 LOW	Defines the low limit for the state change when parameter 8425 ST1 TRIG TO ST 2 is set to e.g. AI1 LOW 1.	0	
8413	SEQ VAL 2 HIGH	Defines the high limit for the state change when parameter 8425 ST1 TRIG TO ST 2 is set to e.g. AI2 HIGH 1.	0	
8414	SEQ VAL 2 LOW	Defines the low limit for the state change when parameter 8425 ST1 TRIG TO ST 2 is set to e.g. AI2 LOW 2.	0	
8415	CYCLE CNT LOC	Activates the cycle counter for sequence programming.	NOT SEL	
8416	CYCLE CNT RST	Selects the source for the cycle counter reset signal (0171 SEQ CYCLE CNTR).	NOT SEL	
8420	ST1 REF SEL	Selects the source for the sequence programming state 1 reference.	0	
8421	ST1 COMMANDS	Selects the start, stop and direction for state 1.	DRIVE STOP	
8422	ST1 RAMP	Selects the acceleration/deceleration ramp time for sequence programming state 1, i.e. defines the rate of the reference change.	0	
8423	ST1 OUT CONTROL	Selects the relay, transistor and analog output control for sequence programming state 1.	AO=0	
8424	ST1 CHANGE DLY	Defines the delay time for state 1.	0	
8425	ST1 TRIG TO ST 2	Selects the source for the trigger signal which changes the state from state 1 to state 2.	NOT SEL	
8426	ST1 TRIG TO ST N	Selects the source for the trigger signal which changes the state from state 1 to state N.	NOT SEL	
8427	ST1 STATE N	Defines the state N. See parameter 8426 ST1 TRIG TO ST N.	STATE 1	
8430	ST2 REF SEL	See parameters 8420...8427.		
...				
8497	ST8 STATE N			
98	OPTIONS	External serial communication activation		
9802	COMM PROT SEL	Activates the external serial communication.	NOT SEL	
99	START-UP DATA	Language selection. Definition of motor set-up data.		
9901	LANGUAGE	Selects the display language.	ENGLISH	
9902	APPLIC MACRO	Selects the application macro.	ABB STANDARD	
9904	MOTOR CTRL MODE	Selects the motor control mode.	SCALAR:FREQ	
9905	MOTOR NOM VOLT	Defines the nominal motor voltage.	230, 400 or 460	
9906	MOTOR NOM CURR	Defines the nominal motor current.	I2N	
9907	MOTOR NOM FREQ	Defines the nominal motor frequency.	Eur: 50 / US: 60	
9908	MOTOR NOM SPEED	Defines the nominal motor speed.	Type dependent	
9909	MOTOR NOM POWER	Defines the nominal motor power.	PN	
9910	ID RUN	Controls a self-calibration process called the Motor ID Run.	OFF/DMAGN	
9912	MOTOR NOM TORQUE	Calculated motor nominal torque in Nm.	0	
9913	MOTOR POLE PAIRS	Calculated motor pole pair number.	0	

Parameters – complete descriptions

Parameters – complete descriptions																		
Index	Name/Selection	Description	Def, FbEq															
10	START/STOP/DIR	The sources for external start, stop and direction control																
1001	EXT1 COMMANDS	Defines the connections and the source for the start, stop and direction commands for external control location 1 (EXT1).	DI1,2															
	NOT SEL	No start, stop and direction command source	0															
	DI1	Start and stop through digital input DI1. 0 = stop, 1 = start. Direction is fixed according to parameter 1003 DIRECTION (setting REQUEST = FORWARD).	1															
	DI1,2	Start and stop through digital input DI1. 0 = stop, 1 = start. Direction through digital input DI2. 0 = forward, 1 = reverse. To control direction, parameter 1003 DIRECTION setting must be REQUEST.	2															
	DI1P,2P	Pulse start through digital input DI1. 0 -> 1: Start. (In order to start the drive, digital input DI2 must be activated prior to the pulse fed to DI1.) Pulse stop through digital input DI2. 1 -> 0: Stop. Direction of rotation is fixed according to parameter 1003 DIRECTION (setting REQUEST = FORWARD).	3															
	DI1P,2P,3	Pulse start through digital input DI1. 0 -> 1: Start. (In order to start the drive, digital input DI2 must be activated prior to the pulse fed to DI1.) Pulse stop through digital input DI2. 1 -> 0: Stop. Direction through digital input DI3. 0 = forward, 1 = reverse. To control direction, parameter 1003 DIRECTION setting must be REQUEST.	4															
	DI1P,2P,3P	Pulse start forward through digital input DI1. 0 -> 1: Start forward. Pulse start reverse through digital input DI2. 0 -> 1: Start reverse. (In order to start the drive, digital input DI3 must be activated prior to the pulse fed to DI1/DI2). Pulse stop through digital input DI3. 1 -> 0: Stop. To control the direction, parameter 1003 DIRECTION setting must be REQUEST.	5															
	KEYPAD	Start, stop and direction commands through control panel when EXT1 is active. To control the direction, parameter 1003 DIRECTION setting must be REQUEST.	8															
	DI1F,2R	Start, stop and direction commands through digital inputs DI1 and DI2. <table border="1" data-bbox="534 1283 1337 1440"> <thead> <tr> <th>DI1</th> <th>DI2</th> <th>Operation</th> </tr> </thead> <tbody> <tr> <td>0</td> <td>0</td> <td>Stop</td> </tr> <tr> <td>1</td> <td>0</td> <td>Start forward</td> </tr> <tr> <td>0</td> <td>1</td> <td>Start reverse</td> </tr> <tr> <td>1</td> <td>1</td> <td>Stop</td> </tr> </tbody> </table> Parameter 1003 DIRECTION setting must be REQUEST.	DI1	DI2	Operation	0	0	Stop	1	0	Start forward	0	1	Start reverse	1	1	Stop	9
DI1	DI2	Operation																
0	0	Stop																
1	0	Start forward																
0	1	Start reverse																
1	1	Stop																
	COMM	Fieldbus interface as the source for the start and stop commands, i.e. control word 0301 FB CMD WORD 1 bits 0...1. The control word is sent by the fieldbus controller via the fieldbus adapter or embedded fieldbus (modbus) to the drive. For the control word bits, see section DCU communication profile on page 262 .	10															
	TIMED FUNC 1	Timed start/stop control. Timed function 1 active = start, timed function 1 inactive = stop. See parameter group 36 TIMED FUNCTIONS.	11															
	TIMED FUNC 2	See selection TIMED FUNC 1.	12															
	TIMED FUNC 3	See selection TIMED FUNC 1.	13															
	TIMED FUNC 4	See selection TIMED FUNC 1.	14															
	DI5	Start and stop through digital input DI5. 0 = stop, 1 = start. Direction is fixed according to parameter 1003 DIRECTION (setting REQUEST = FORWARD).	20															

Parameters – complete descriptions			
Index	Name/Selection	Description	Def, FbEq
	DI5,4	Start and stop through digital input DI5. 0 = stop, 1 = start. Direction through digital input DI4. 0 = forward, 1 = reverse. To control direction, parameter 1003 DIRECTION must be REQUEST.	21
	TIMER STOP	Stop when timer delay defined by parameter 1901 TIMER DELAY has passed. Start with timer start signal. Source for the signal is selected by parameter 1902 TIMER START.	22
	TIMER START	Start when timer delay defined by parameter 1901 TIMER DELAY has passed. Stop when timer is reset by parameter 1903 TIMER RESET.	23
	COUNTER STOP	Stop when counter limit defined by parameter 1905 COUNTER LIMIT has been exceeded. Start with counter start signal. Source for the signal is selected by parameter 1911 CNTR S/S COMMAND.	24
	COUNTER START	Start when counter limit defined by parameter 1905 COUNTER LIMIT has been exceeded. Stop with counter stop signal. Source for the signal is selected by parameter 1911 CNTR S/S COMMAND.	25
	SEQ PROG	Start, stop and direction commands through sequence programming. See parameter group 84 SEQUENCE PROG .	26
1002	EXT2 COMMANDS	Defines the connections and the source for the start, stop and direction commands for external control location 2 (EXT2).	NOT SEL
		See parameter 1001 EXT1 COMMANDS.	
1003	DIRECTION	Enables the control of rotation direction of the motor, or fixes the direction.	REQUEST
	FORWARD	Fixed to forward	1
	REVERSE	Fixed to reverse	2
	REQUEST	Direction of rotation control allowed	3
1010	JOGGING SEL	Defines the signal that activates the jogging function. See section Jogging on page 129 .	NOT SEL
	DI1	Digital input DI1. 0 = jogging inactive, 1 = jogging active.	1
	DI2	See selection DI1.	2
	DI3	See selection DI1.	3
	DI4	See selection DI1.	4
	DI5	See selection DI1.	5
	COMM	Fieldbus interface as the source for jogging 1 or 2 activation, i.e. control word 0302 FB CMD WORD 2 bits 20 and 21. The control word is sent by the fieldbus controller via the fieldbus adapter or embedded fieldbus (modbus) to the drive. For the control word bits, see section DCU communication profile on page 262 .	6
	NOT SEL	Not selected	0
	DI1(INV)	Inverted digital input DI1. 1 = jogging inactive, 0 = jogging active.	-1
	DI2(INV)	See selection DI1(INV).	-2
	DI3(INV)	See selection DI1(INV).	-3
	DI4(INV)	See selection DI1(INV).	-4
	DI5(INV)	See selection DI1(INV).	-5

Parameters – complete descriptions			
Index	Name/Selection	Description	Def, FbEq
11	REFERENCE SELECT	Panel reference type, external control location selection and external reference sources and limits	
1101	KEYPAD REF SEL	Selects the type of the reference in local control mode.	REF1
	REF1(Hz/rpm)	Speed reference in rpm. Frequency reference (Hz) if parameter 9904 MOTOR CTRL MODE setting is SCALAR:FREQ.	1
	REF2(%)	%-reference	2
1102	EXT1/EXT2 SEL	Defines the source from which the drive reads the signal that selects between the two external control locations, EXT1 or EXT2.	EXT1
	EXT1	EXT1 active. The control signal sources are defined by parameters 1001 EXT1 COMMANDS and 1103 REF1 SELECT.	0
	DI1	Digital input DI1. 0 = EXT1, 1 = EXT2.	1
	DI2	See selection DI1.	2
	DI3	See selection DI1.	3
	DI4	See selection DI1.	4
	DI5	See selection DI1.	5
	EXT2	EXT2 active. The control signal sources are defined by parameters 1002 EXT2 COMMANDS and 1106 REF2 SELECT.	7
	COMM	Fieldbus interface as the source for EXT1/EXT2 selection, i.e. control word 0301 FB CMD WORD 1 bit 5 (with ABB Drives profile 5319 EFB PAR 19 bit 11). The control word is sent by the fieldbus controller via the fieldbus adapter or embedded fieldbus (modbus) to the drive. For the control word bits, see sections DCU communication profile on page 262 and ABB Drives communication profile on page 258 .	8
	TIMED FUNC 1	Timed EXT1/EXT2 control selection. Timed function 1 active = EXT2, timed function 1 inactive = EXT1. See parameter group 36 TIMED FUNCTIONS .	9
	TIMED FUNC 2	See selection TIMED FUNC 1.	10
	TIMED FUNC 3	See selection TIMED FUNC 1.	11
	TIMED FUNC 4	See selection TIMED FUNC 1.	12
	DI1(INV)	Inverted digital input DI1. 1 = EXT1, 0 = EXT2.	-1
	DI2(INV)	See selection DI1(INV).	-2
	DI3(INV)	See selection DI1(INV).	-3
	DI4(INV)	See selection DI1(INV).	-4
	DI5(INV)	See selection DI1(INV).	-5
1103	REF1 SELECT	Selects the signal source for external reference REF1. See section Block diagram: Reference source for EXT1 on page 99 .	AI1
	KEYPAD	Control panel	0
	AI1	Analog input AI1	1
	AI2	Analog input AI2	2

Parameters – complete descriptions			
Index	Name/Selection	Description	Def, FbEq
AI1/JOYST		<p>Analog input AI1 as joystick. The minimum input signal runs the motor at the maximum reference in the reverse direction, the maximum input at the maximum reference in the forward direction. Minimum and maximum references are defined by parameters 1104 REF1 MIN and 1105 REF1 MAX.</p> <p>Note: Parameter 1003 DIRECTION must be set to REQUEST.</p> <p>Speed ref. (REF1)</p> <p>par. 1301 = 20%, par 1302 = 100%</p> <p>1105 1104 0 -1104 -1105</p> <p>2 V / 4 mA 6 10 V / 20 mA</p> <p>AI1</p> <p>1104 - 1104</p> <p>-2% +2%</p> <p>Hysteresis 4% of full scale</p> <p>WARNING! If parameter 1301 MINIMUM AI1 is set to 0 V and analog input signal is lost (i.e. 0 V), the rotation of the motor is reversed to the maximum reference. Set the following parameters to activate a fault when analog input signal is lost: Set parameter 1301 MINIMUM AI1 to 20% (2 V or 4 mA). Set parameter 3021 AI1 FAULT LIMIT to 5% or higher. Set parameter 3001 AI<MIN FUNCTION to FAULT.</p>	3
AI2/JOYST		See selection AI1/JOYST.	4
DI3U,4D(R)		Digital input 3: Reference increase. Digital input DI4: Reference decrease. Stop command resets the reference to zero. Parameter 2205 ACCELER TIME 2 defines the rate of the reference change.	5
DI3U,4D		Digital input 3: Reference increase. Digital input DI4: Reference decrease. The program stores the active speed reference (not reset by a stop command). When the drive is restarted, the motor ramps up at the selected acceleration rate to the stored reference. Parameter 2205 ACCELER TIME2 defines the rate of the reference change.	6
COMM		Fieldbus reference REF1	8
COMM+AI1		Summation of fieldbus reference REF1 and analog input AI. See section Reference selection and correction on page 249 .	9
COMM*AI1		Multiplication of fieldbus reference REF1 and analog input AI1. See section Reference selection and correction on page 249 .	10
DI3U,4D(RNC)		Digital input 3: Reference increase. Digital input DI4: Reference decrease. Stop command resets the reference to zero. The reference is not saved if the control source is changed (from EXT1 to EXT2, from EXT2 to EXT1 or from LOC to REM). Parameter 2205 ACCELER TIME 2 defines the rate of the reference change.	11
DI3U,4D(NC)		Digital input 3: Reference increase. Digital input DI4: Reference decrease. The program stores the active speed reference (not reset by a stop command). The reference is not saved if the control source is changed (from EXT1 to EXT2, from EXT2 to EXT1 or from LOC to REM). When the drive is restarted, the motor ramps up at the selected acceleration rate to the stored reference. Parameter 2205 ACCELER TIME 2 defines the rate of the reference change.	12
AI1+AI2		Reference is calculated with the following equation: $REF = AI1(\%) + AI2(\%) - 50\%$	14

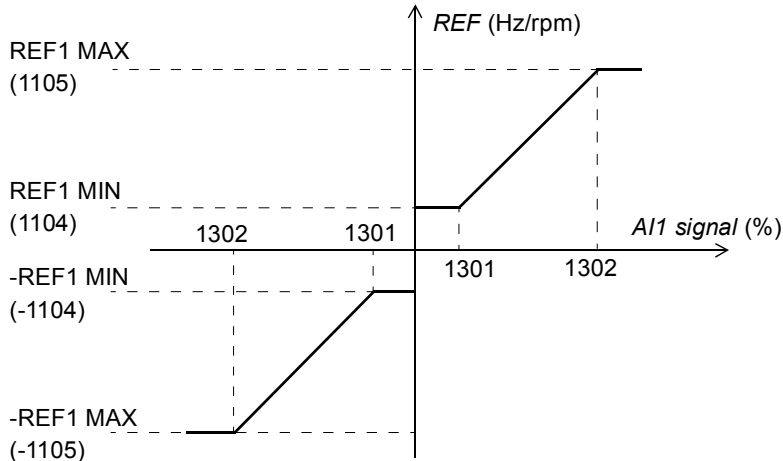
Parameters – complete descriptions			
Index	Name/Selection	Description	Def, FbEq
	AI1*AI2	Reference is calculated with the following equation: $REF = AI1(\%) \cdot (AI2(\%) / 50\%)$	15
	AI1-AI2	Reference is calculated with the following equation: $REF = AI1(\%) + 50\% - AI2(\%)$	16
	AI1/AI2	Reference is calculated with the following equation: $REF = AI1(\%) \cdot (50\% / AI2(\%))$	17
	DI4U,5D	See selection DI3U,4D.	30
	DI4U,5D(NC)	See selection DI3U,4D(NC).	31
	FREQ INPUT	Frequency input	32
	SEQ PROG	Sequence programming output. See parameter 8420 ST1 REF SEL.	33
	AI1+SEQ PROG	Addition of analog input AI1 and sequence programming output	34
	AI2+SEQ PROG	Addition of analog input AI2 and sequence programming output	35
1104	REF1 MIN	Defines the minimum value for external reference REF1. Corresponds to the minimum setting of the used source signal.	0
	0.0...500.0 Hz / 0...30000 rpm	Minimum value in rpm. Hz if parameter 9904 MOTOR CTRL MODE setting is SCALAR:FREQ. Example: Analog input AI1 is selected as the reference source (value of parameter 1103 is AI1). The reference minimum and maximum correspond to the 1301 MINIMUM AI1 and 1302 MAXIMUM AI1 settings as follows: 	1 = 0.1 Hz / 1 rpm
1105	REF1 MAX	Defines the maximum value for external signal reference REF1. Corresponds to the maximum setting of the used source signal.	Eur: 50 / US: 60
	0.0...500.0 Hz / 0...30000 rpm	Maximum value in rpm. Hz if parameter 9904 MOTOR CTRL MODE setting is SCALAR:FREQ. See example in parameter 1104 REF1 MIN.	1 = 0.1 Hz / 1 rpm
1106	REF2 SELECT	Selects the signal source for external reference REF2.	AI2
	KEYPAD	See parameter 1103 REF1 SELECT.	0
	AI1	See parameter 1103 REF1 SELECT.	1
	AI2	See parameter 1103 REF1 SELECT.	2
	AI1/JOYST	See parameter 1103 REF1 SELECT.	3
	AI2/JOYST	See parameter 1103 REF1 SELECT.	4
	DI3U,4D(R)	See parameter 1103 REF1 SELECT.	5
	DI3U,4D	See parameter 1103 REF1 SELECT.	6

Parameters – complete descriptions			
Index	Name/Selection	Description	Def, FbEq
	COMM	See parameter 1103 REF1 SELECT.	8
	COMM+AI1	See parameter 1103 REF1 SELECT.	9
	COMM*AI1	See parameter 1103 REF1 SELECT.	10
	DI3U,4D(RNC)	See parameter 1103 REF1 SELECT.	11
	DI3U,4D(NC)	See parameter 1103 REF1 SELECT.	12
	AI1+AI2	See parameter 1103 REF1 SELECT.	14
	AI1*AI2	See parameter 1103 REF1 SELECT.	15
	AI1-AI2	See parameter 1103 REF1 SELECT.	16
	AI1/AI2	See parameter 1103 REF1 SELECT.	17
	PID1OUT	PID controller 1 output. See parameter groups 40 PROCESS PID SET 1 and 41 PROCESS PID SET 2 .	19
	DI4U,5D	See parameter 1103 REF1 SELECT.	30
	DI4U,5D(NC)	See parameter 1103 REF1 SELECT.	31
	FREQ INPUT	See parameter 1103 REF1 SELECT.	32
	SEQ PROG	See parameter 1103 REF1 SELECT.	33
	AI1+SEQ PROG	See parameter 1103 REF1 SELECT.	34
	AI2+SEQ PROG	See parameter 1103 REF1 SELECT.	35
1107	REF2 MIN	Defines the minimum value for external reference REF2. Corresponds to the minimum setting of the used source signal.	0
	0.0...100.0%	Value in percent of the maximum frequency / maximum speed / nominal torque. See example in parameter 1104 REF1 MIN for correspondence to the source signal limits.	1 = 0.1%
1108	REF2 MAX	Defines the maximum value for external reference REF2. Corresponds to the maximum setting of the used source signal.	100
	0.0...100.0%	Value in percent of the maximum frequency / maximum speed / nominal torque. See example in parameter 1104 REF1 MIN for correspondence to the source signal limits.	1 = 0.1%
12 CONSTANT SPEEDS		Constant speed selection and values. See section Constant speeds on page 111 .	
1201	CONST SPEED SEL	Activates the constant speeds or selects the activation signal.	DI3,4
	NOT SEL	No constant speed in use	0
	DI1	Speed defined by parameter 1202 CONST SPEED 1 is activated through digital input DI1. 1 = active, 0 = inactive.	1
	DI2	Speed defined by parameter 1202 CONST SPEED 1 is activated through digital input DI2. 1 = active, 0 = inactive.	2
	DI3	Speed defined by parameter 1202 CONST SPEED 1 is activated through digital input DI3. 1 = active, 0 = inactive.	3
	DI4	Speed defined by parameter 1202 CONST SPEED 1 is activated through digital input DI4. 1 = active, 0 = inactive.	4
	DI5	Speed defined by parameter 1202 CONST SPEED 1 is activated through digital input DI5. 1 = active, 0 = inactive.	5

Parameters – complete descriptions																																							
Index	Name/Selection	Description	Def, FbEq																																				
	DI1,2	Constant speed selection through digital inputs DI1 and DI2. 1 = DI active, 0 = DI inactive. <table border="1"> <thead> <tr> <th>DI1</th> <th>DI2</th> <th>Operation</th> </tr> </thead> <tbody> <tr> <td>0</td> <td>0</td> <td>No constant speed</td> </tr> <tr> <td>1</td> <td>0</td> <td>Speed defined by parameter 1202 CONST SPEED 1</td> </tr> <tr> <td>0</td> <td>1</td> <td>Speed defined by parameter 1203 CONST SPEED 2</td> </tr> <tr> <td>1</td> <td>1</td> <td>Speed defined by parameter 1204 CONST SPEED 3</td> </tr> </tbody> </table>	DI1	DI2	Operation	0	0	No constant speed	1	0	Speed defined by parameter 1202 CONST SPEED 1	0	1	Speed defined by parameter 1203 CONST SPEED 2	1	1	Speed defined by parameter 1204 CONST SPEED 3	7																					
DI1	DI2	Operation																																					
0	0	No constant speed																																					
1	0	Speed defined by parameter 1202 CONST SPEED 1																																					
0	1	Speed defined by parameter 1203 CONST SPEED 2																																					
1	1	Speed defined by parameter 1204 CONST SPEED 3																																					
	DI2,3	See selection DI1,2.	8																																				
	DI3,4	See selection DI1,2.	9																																				
	DI4,5	See selection DI1,2.	10																																				
	DI1,2,3	Constant speed selection through digital inputs DI1, DI2 and DI3. 1 = DI active, 0 = DI inactive. <table border="1"> <thead> <tr> <th>DI1</th> <th>DI2</th> <th>DI3</th> <th>Operation</th> </tr> </thead> <tbody> <tr> <td>0</td> <td>0</td> <td>0</td> <td>No constant speed</td> </tr> <tr> <td>1</td> <td>0</td> <td>0</td> <td>Speed defined by parameter 1202 CONST SPEED 1</td> </tr> <tr> <td>0</td> <td>1</td> <td>0</td> <td>Speed defined by parameter 1203 CONST SPEED 2</td> </tr> <tr> <td>1</td> <td>1</td> <td>0</td> <td>Speed defined by parameter 1204 CONST SPEED 3</td> </tr> <tr> <td>0</td> <td>0</td> <td>1</td> <td>Speed defined by parameter 1205 CONST SPEED 4</td> </tr> <tr> <td>1</td> <td>0</td> <td>1</td> <td>Speed defined by parameter 1206 CONST SPEED 5</td> </tr> <tr> <td>0</td> <td>1</td> <td>1</td> <td>Speed defined by parameter 1207 CONST SPEED 6</td> </tr> <tr> <td>1</td> <td>1</td> <td>1</td> <td>Speed defined by parameter 1208 CONST SPEED 7</td> </tr> </tbody> </table>	DI1	DI2	DI3	Operation	0	0	0	No constant speed	1	0	0	Speed defined by parameter 1202 CONST SPEED 1	0	1	0	Speed defined by parameter 1203 CONST SPEED 2	1	1	0	Speed defined by parameter 1204 CONST SPEED 3	0	0	1	Speed defined by parameter 1205 CONST SPEED 4	1	0	1	Speed defined by parameter 1206 CONST SPEED 5	0	1	1	Speed defined by parameter 1207 CONST SPEED 6	1	1	1	Speed defined by parameter 1208 CONST SPEED 7	12
DI1	DI2	DI3	Operation																																				
0	0	0	No constant speed																																				
1	0	0	Speed defined by parameter 1202 CONST SPEED 1																																				
0	1	0	Speed defined by parameter 1203 CONST SPEED 2																																				
1	1	0	Speed defined by parameter 1204 CONST SPEED 3																																				
0	0	1	Speed defined by parameter 1205 CONST SPEED 4																																				
1	0	1	Speed defined by parameter 1206 CONST SPEED 5																																				
0	1	1	Speed defined by parameter 1207 CONST SPEED 6																																				
1	1	1	Speed defined by parameter 1208 CONST SPEED 7																																				
	DI3,4,5	See selection DI1,2,3.	13																																				
	TIMED FUNC 1	Speed defined by parameter 1202 CONST SPEED 1 is activated by timed function. Timed function 1 active = CONST SPEED 1. See parameter group 36 TIMED FUNCTIONS .	15																																				
	TIMED FUNC 2	See selection TIMED FUNC 1.	16																																				
	TIMED FUNC 3	See selection TIMED FUNC 1.	17																																				
	TIMED FUNC 4	See selection TIMED FUNC 1.	18																																				
	TIMED FUN1&2	Speed selection with TIMED FUNC 1 and TIMED FUNC 2. See parameter 1209 TIMED MODE SEL.	19																																				
	DI1(INV)	Speed defined by parameter 1202 CONST SPEED 1 is activated through inverted digital input DI1. 0 = active, 1 = inactive.	-1																																				
	DI2(INV)	Speed defined by parameter 1202 CONST SPEED 1 is activated through inverted digital input DI2. 0 = active, 1 = inactive.	-2																																				
	DI3(INV)	Speed defined by parameter 1202 CONST SPEED 1 is activated through inverted digital input DI3. 0 = active, 1 = inactive.	-3																																				
	DI4(INV)	Speed defined by parameter 1202 CONST SPEED 1 is activated through inverted digital input DI4. 0 = active, 1 = inactive.	-4																																				
	DI5(INV)	Speed defined by parameter 1202 CONST SPEED 1 is activated through inverted digital input DI5. 0 = active, 1 = inactive.	-5																																				
	DI1,2(INV)	Constant speed selection through inverted digital inputs DI1 and DI2. 1 = DI active, 0 = DI inactive. <table border="1"> <thead> <tr> <th>DI1</th> <th>DI2</th> <th>Operation</th> </tr> </thead> <tbody> <tr> <td>1</td> <td>1</td> <td>No constant speed</td> </tr> <tr> <td>0</td> <td>1</td> <td>Speed defined by parameter 1202 CONST SPEED 1</td> </tr> <tr> <td>1</td> <td>0</td> <td>Speed defined by parameter 1203 CONST SPEED 2</td> </tr> <tr> <td>0</td> <td>0</td> <td>Speed defined by parameter 1204 CONST SPEED 3</td> </tr> </tbody> </table>	DI1	DI2	Operation	1	1	No constant speed	0	1	Speed defined by parameter 1202 CONST SPEED 1	1	0	Speed defined by parameter 1203 CONST SPEED 2	0	0	Speed defined by parameter 1204 CONST SPEED 3	-7																					
DI1	DI2	Operation																																					
1	1	No constant speed																																					
0	1	Speed defined by parameter 1202 CONST SPEED 1																																					
1	0	Speed defined by parameter 1203 CONST SPEED 2																																					
0	0	Speed defined by parameter 1204 CONST SPEED 3																																					

Parameters – complete descriptions																																							
Index	Name/Selection	Description	Def, FbEq																																				
	DI2,3(INV)	See selection DI1,2(INV).	-8																																				
	DI3,4(INV)	See selection DI1,2(INV).	-9																																				
	DI4,5(INV)	See selection DI1,2(INV).	-10																																				
	DI1,2,3(INV)	Constant speed selection through inverted digital inputs DI1, DI2 and DI3. 1 = DI active, 0 = DI inactive. <table border="1"> <thead> <tr> <th>DI1</th> <th>DI2</th> <th>DI3</th> <th>Operation</th> </tr> </thead> <tbody> <tr> <td>1</td> <td>1</td> <td>1</td> <td>No constant speed</td> </tr> <tr> <td>0</td> <td>1</td> <td>1</td> <td>Speed defined by parameter 1202 CONST SPEED 1</td> </tr> <tr> <td>1</td> <td>0</td> <td>1</td> <td>Speed defined by parameter 1203 CONST SPEED 2</td> </tr> <tr> <td>0</td> <td>0</td> <td>1</td> <td>Speed defined by parameter 1204 CONST SPEED 3</td> </tr> <tr> <td>1</td> <td>1</td> <td>0</td> <td>Speed defined by parameter 1205 CONST SPEED 4</td> </tr> <tr> <td>0</td> <td>1</td> <td>0</td> <td>Speed defined by parameter 1206 CONST SPEED 5</td> </tr> <tr> <td>1</td> <td>0</td> <td>0</td> <td>Speed defined by parameter 1207 CONST SPEED 6</td> </tr> <tr> <td>0</td> <td>0</td> <td>0</td> <td>Speed defined by parameter 1208 CONST SPEED 7</td> </tr> </tbody> </table>	DI1	DI2	DI3	Operation	1	1	1	No constant speed	0	1	1	Speed defined by parameter 1202 CONST SPEED 1	1	0	1	Speed defined by parameter 1203 CONST SPEED 2	0	0	1	Speed defined by parameter 1204 CONST SPEED 3	1	1	0	Speed defined by parameter 1205 CONST SPEED 4	0	1	0	Speed defined by parameter 1206 CONST SPEED 5	1	0	0	Speed defined by parameter 1207 CONST SPEED 6	0	0	0	Speed defined by parameter 1208 CONST SPEED 7	-12
DI1	DI2	DI3	Operation																																				
1	1	1	No constant speed																																				
0	1	1	Speed defined by parameter 1202 CONST SPEED 1																																				
1	0	1	Speed defined by parameter 1203 CONST SPEED 2																																				
0	0	1	Speed defined by parameter 1204 CONST SPEED 3																																				
1	1	0	Speed defined by parameter 1205 CONST SPEED 4																																				
0	1	0	Speed defined by parameter 1206 CONST SPEED 5																																				
1	0	0	Speed defined by parameter 1207 CONST SPEED 6																																				
0	0	0	Speed defined by parameter 1208 CONST SPEED 7																																				
	DI3,4,5(INV)	See selection DI1,2,3(INV).	-13																																				
1202	CONST SPEED 1	Defines constant speed (or drive output frequency) 1.	Eur: 5 / US: 6																																				
	0.0...500.0 Hz / 0...30000 rpm	Speed in rpm. Output frequency in Hz if parameter 9904 MOTOR CTRL MODE setting is SCALAR:FREQ.	1 = 0.1 Hz / 1 rpm																																				
1203	CONST SPEED 2	Defines constant speed (or drive output frequency) 2.	Eur: 10 / US: 12																																				
	0.0...500.0 Hz / 0...30000 rpm	Speed in rpm. Output frequency in Hz if parameter 9904 MOTOR CTRL MODE setting is SCALAR:FREQ.	1 = 0.1 Hz / 1 rpm																																				
1204	CONST SPEED 3	Defines constant speed (or drive output frequency) 3.	Eur: 15 / US: 18																																				
	0.0...500.0 Hz / 0...30000 rpm	Speed in rpm. Output frequency in Hz if parameter 9904 MOTOR CTRL MODE setting is SCALAR:FREQ.	1 = 0.1 Hz / 1 rpm																																				
1205	CONST SPEED 4	Defines constant speed (or drive output frequency) 4.	Eur: 20 / US: 24																																				
	0.0...500.0 Hz / 0...30000 rpm	Speed in rpm. Output frequency in Hz if parameter 9904 MOTOR CTRL MODE setting is SCALAR:FREQ.	1 = 0.1 Hz / 1 rpm																																				
1206	CONST SPEED 5	Defines constant speed (or drive output frequency) 5.	Eur: 25 / US: 30																																				
	0.0...500.0 Hz / 0...30000 rpm	Speed in rpm. Output frequency in Hz if parameter 9904 MOTOR CTRL MODE setting is SCALAR:FREQ.	1 = 0.1 Hz / 1 rpm																																				
1207	CONST SPEED 6	Defines constant speed (or drive output frequency) 6.	Eur: 40 / US: 48																																				
	0.0...500.0 Hz / 0...30000 rpm	Speed in rpm. Output frequency in Hz if parameter 9904 MOTOR CTRL MODE setting is SCALAR:FREQ. Constant speed 6 is used also as jogging speed. See section Jogging on page 129 .	1 = 0.1 Hz / 1 rpm																																				
1208	CONST SPEED 7	Defines constant speed (or drive output frequency) 7. Constant speed 7 is used also as jogging speed (see section Jogging on page 129) or with fault functions (3001 AI<MIN FUNCTION and 3002 PANEL COMM ERR).	Eur: 50 / US: 60																																				
	0...500 Hz / 0...30000 rpm	Speed in rpm. Output frequency in Hz if parameter 9904 MOTOR CTRL MODE setting is SCALAR:FREQ. Constant speed 7 is used also as jogging speed. See section Jogging on page 129 .	1 = 0.1 Hz / 1 rpm																																				

Parameters – complete descriptions																		
Index	Name/Selection	Description	Def, FbEq															
1209	TIMED MODE SEL	Selects timed function activated speed into use when parameter 1201 CONST SPEED SEL selection is TIMED FUN1&2.	CS1/2/3/4															
	EXT/CS1/2/3	External speed reference or constant speed selection with TIMED FUNC 1 and TIMED FUNC 2. 1 = timed function active, 0 = timed function inactive. <table border="1"> <thead> <tr> <th>TIMED FUNC 1</th> <th>TIMED FUNC 2</th> <th>Operation</th> </tr> </thead> <tbody> <tr> <td>0</td> <td>0</td> <td>External reference</td> </tr> <tr> <td>1</td> <td>0</td> <td>Speed defined by parameter 1202 CONST SPEED 1</td> </tr> <tr> <td>0</td> <td>1</td> <td>Speed defined by parameter 1203 CONST SPEED 2</td> </tr> <tr> <td>1</td> <td>1</td> <td>Speed defined by parameter 1204 CONST SPEED 3</td> </tr> </tbody> </table>	TIMED FUNC 1	TIMED FUNC 2	Operation	0	0	External reference	1	0	Speed defined by parameter 1202 CONST SPEED 1	0	1	Speed defined by parameter 1203 CONST SPEED 2	1	1	Speed defined by parameter 1204 CONST SPEED 3	1
TIMED FUNC 1	TIMED FUNC 2	Operation																
0	0	External reference																
1	0	Speed defined by parameter 1202 CONST SPEED 1																
0	1	Speed defined by parameter 1203 CONST SPEED 2																
1	1	Speed defined by parameter 1204 CONST SPEED 3																
	CS1/2/3/4	Constant speed selection with TIMED FUNC 1 and TIMED FUNC 2. 1 = timed function active, 0 = timed function inactive. <table border="1"> <thead> <tr> <th>TIMED FUNC 1</th> <th>TIMED FUNC 2</th> <th>Operation</th> </tr> </thead> <tbody> <tr> <td>0</td> <td>0</td> <td>Speed defined by parameter 1202 CONST SPEED 1</td> </tr> <tr> <td>1</td> <td>0</td> <td>Speed defined by parameter 1203 CONST SPEED 2</td> </tr> <tr> <td>0</td> <td>1</td> <td>Speed defined by parameter 1204 CONST SPEED 3</td> </tr> <tr> <td>1</td> <td>1</td> <td>Speed defined by parameter 1205 CONST SPEED 4</td> </tr> </tbody> </table>	TIMED FUNC 1	TIMED FUNC 2	Operation	0	0	Speed defined by parameter 1202 CONST SPEED 1	1	0	Speed defined by parameter 1203 CONST SPEED 2	0	1	Speed defined by parameter 1204 CONST SPEED 3	1	1	Speed defined by parameter 1205 CONST SPEED 4	2
TIMED FUNC 1	TIMED FUNC 2	Operation																
0	0	Speed defined by parameter 1202 CONST SPEED 1																
1	0	Speed defined by parameter 1203 CONST SPEED 2																
0	1	Speed defined by parameter 1204 CONST SPEED 3																
1	1	Speed defined by parameter 1205 CONST SPEED 4																
13 ANALOGUE INPUTS Analog input signal processing																		
1301	MINIMUM AI1	Defines the minimum %-value that corresponds to minimum mA(V) signal for analog input AI1. When used as a reference, the value corresponds to the reference minimum setting. 0...20 mA $\hat{=}$ 0...100% 4...20 mA $\hat{=}$ 20...100% -10...10 mA $\hat{=}$ -50...50% Example: If AI1 is selected as the source for external reference REF1, this value corresponds to the value of parameter 1104 REF1 MIN. Note: MINIMUM AI value must not exceed MAXIMUM AI value.	1%															
	-100.0...100.0%	Value in percent of the full signal range. Example: If the minimum value for analog input is 4 mA, the percent value for 0...20 mA range is: $(4 \text{ mA} / 20 \text{ mA}) \cdot 100\% = 20\%$	1 = 0.1%															
1302	MAXIMUM AI1	Defines the maximum %-value that corresponds to maximum mA(V) signal for analog input AI1. When used as a reference, the value corresponds to the reference maximum setting. 0...20 mA $\hat{=}$ 0...100% 4...20 mA $\hat{=}$ 20...100% -10...10 mA $\hat{=}$ -50...50% Example: If AI1 is selected as the source for external reference REF1, this value corresponds to the value of parameter 1105 REF1 MAX.	100															
	-100.0...100.0%	Value in percent of the full signal range. Example: If the maximum value for analog input is 10 mA, the percent value for 0...20 mA range is: $(10 \text{ mA} / 20 \text{ mA}) \cdot 100\% = 50\%$	1 = 0.1%															

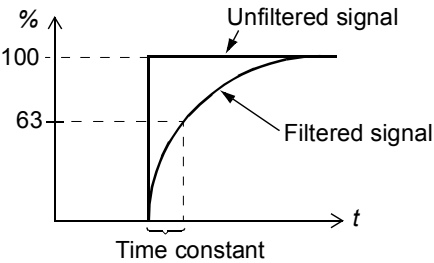
Parameters – complete descriptions			
Index	Name/Selection	Description	Def, FbEq
1303	FILTER AI1	<p>Defines the filter time constant for analog input AI1, i.e the time within 63% of a step change is reached.</p> 	0.1
	0.0...10.0 s	Filter time constant	1 = 0.1 s
1304	MINIMUM AI2	Defines the minimum %-value that corresponds to minimum mA/(V) signal for analog input AI2. See parameter 1301 MINIMUM AI1.	1%
	-100.0...100.0%	See parameter 1301 MINIMUM AI1.	1 = 0.1%
1305	MAXIMUM AI2	Defines the maximum %-value that corresponds to maximum mA/(V) signal for analog input AI2. See parameter 1302 MAXIMUM AI1.	100
	-100.0...100.0%	See parameter 1302 MAXIMUM AI1.	1 = 0.1%
1306	FILTER AI2	Defines the filter time constant for analog input AI2. See parameter 1303 FILTER AI1.	0.1
	0.0...10.0 s	Filter time constant	1 = 0.1 s
14 RELAY OUTPUTS		Status information indicated through relay output, and relay operating delays	
1401	RELAY OUTPUT 1	Selects a drive status indicated through relay output RO. The relay energises when the status meets the setting.	FAULT(-1)
	NOT SEL	Not used	0
	READY	Ready to function: Run Enable signal on, no fault, supply voltage within acceptable range and emergency stop signal off.	1
	RUN	Running: Start signal on, Run Enable signal on, no active fault.	2
	FAULT(-1)	Inverted fault. Relay is de-energised on a fault trip.	3
	FAULT	Fault	4
	ALARM	Alarm	5
	REVERSED	Motor rotates in reverse direction.	6
	STARTED	The drive has received start command. Relay is energized even if Run Enable signal is off. Relay is de-energized when drive receives a stop command or a fault occurs.	7
	SUPRV1 OVER	Status according to supervision parameters 3201...3203 . See parameter group 32 SUPERVISION .	8
	SUPRV1 UNDER	See selection SUPRV1 OVER.	9
	SUPRV2 OVER	Status according to supervision parameters 3204...3206 . See parameter group 32 SUPERVISION .	10
	SUPRV2 UNDER	See selection SUPRV2 OVER.	11
	SUPRV3 OVER	Status according to supervision parameters 3207...3209 . See parameter group 32 SUPERVISION .	12
	SUPRV3 UNDER	See selection SUPRV3 OVER.	13
	AT SET POINT	Output frequency is equal to the reference frequency.	14

Parameters – complete descriptions																							
Index	Name/Selection	Description	Def, FbEq																				
	FAULT(RST)	Fault. Automatic reset after the autoreset delay. See parameter group 31 AUTOMATIC RESET .	15																				
	FLT/ALARM	Fault or alarm	16																				
	EXT CTRL	Drive is under external control.	17																				
	REF 2 SEL	External reference REF 2 is in use.	18																				
	CONST FREQ	A constant speed is in use. See parameter group 12 CONSTANT SPEEDS .	19																				
	REF LOSS	Reference or active control location is lost.	20																				
	OVERCURRENT	Alarm/Fault by overcurrent protection function	21																				
	OVERVOLTAGE	Alarm/Fault by overvoltage protection function	22																				
	DRIVE TEMP	Alarm/Fault by drive overtemperature protection function	23																				
	UNDERVOLTAGE	Alarm/Fault by undervoltage protection function	24																				
	AI1 LOSS	Analog input AI1 signal is lost.	25																				
	AI2 LOSS	Analog input AI2 signal is lost.	26																				
	MOTOR TEMP	Alarm/Fault by motor overtemperature protection function. See parameter 3005 MOT THERM PROT .	27																				
	STALL	Alarm/Fault by stall protection function. See parameter 3010 STALL FUNCTION .	28																				
	UNDERLOAD	Alarm/Fault by underload protection function. See parameter 3013 UNDERLOAD FUNC	29																				
	PID SLEEP	PID sleep function. See parameter group 40 PROCESS PID SET 1/ 41 PROCESS PID SET 2 .	30																				
	FLUX READY	Motor is magnetized and able to supply nominal torque.	33																				
	USER MACRO 2	User Macro 2 is active.	34																				
	COMM	Fieldbus control signal 0134 COMM RO WORD . 0 = de-energize output, 1 = energize output. <table border="1" data-bbox="536 1272 1011 1429"> <thead> <tr> <th>0134 value</th> <th>Binary</th> <th>DO</th> <th>RO</th> </tr> </thead> <tbody> <tr> <td>0</td> <td>000000</td> <td>0</td> <td>0</td> </tr> <tr> <td>1</td> <td>000001</td> <td>0</td> <td>1</td> </tr> <tr> <td>2</td> <td>000010</td> <td>1</td> <td>0</td> </tr> <tr> <td>3</td> <td>000011</td> <td>1</td> <td>1</td> </tr> </tbody> </table>	0134 value	Binary	DO	RO	0	000000	0	0	1	000001	0	1	2	000010	1	0	3	000011	1	1	35
0134 value	Binary	DO	RO																				
0	000000	0	0																				
1	000001	0	1																				
2	000010	1	0																				
3	000011	1	1																				
	COMM(-1)	Fieldbus control signal 0134 COMM RO WORD . 0 = de-energize output, 1 = energize output <table border="1" data-bbox="536 1509 1011 1666"> <thead> <tr> <th>0134 value</th> <th>Binary</th> <th>DO</th> <th>RO</th> </tr> </thead> <tbody> <tr> <td>0</td> <td>000000</td> <td>1</td> <td>1</td> </tr> <tr> <td>1</td> <td>000001</td> <td>1</td> <td>0</td> </tr> <tr> <td>2</td> <td>000010</td> <td>0</td> <td>1</td> </tr> <tr> <td>3</td> <td>000011</td> <td>0</td> <td>0</td> </tr> </tbody> </table>	0134 value	Binary	DO	RO	0	000000	1	1	1	000001	1	0	2	000010	0	1	3	000011	0	0	36
0134 value	Binary	DO	RO																				
0	000000	1	1																				
1	000001	1	0																				
2	000010	0	1																				
3	000011	0	0																				
	TIMED FUNC 1	Timed function 1 is active. See parameter group 36 TIMED FUNCTIONS .	37																				
	TIMED FUNC 2	Timed function 2 is active. See parameter group 36 TIMED FUNCTIONS .	38																				
	TIMED FUNC 3	Timed function 3 is active. See parameter group 36 TIMED FUNCTIONS .	39																				
	TIMED FUNC 4	Timed function 4 is active. See parameter group 36 TIMED FUNCTIONS .	40																				
	M.TRIG FAN	Cooling fan running time counter is triggered. See parameter group 29 MAINTENANCE TRIG .	41																				
	M.TRIG REV	Revolutions counter is triggered. See parameter group 29 MAINTENANCE TRIG .	42																				

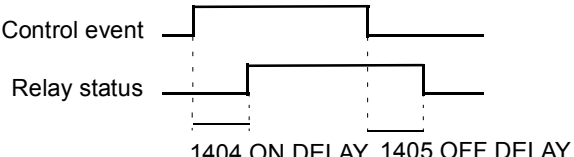
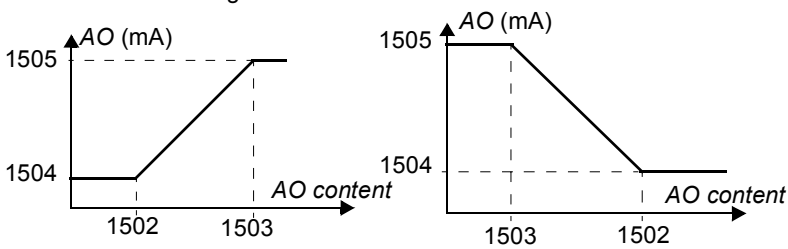
Parameters – complete descriptions			
Index	Name/Selection	Description	Def, FbEq
	M.TRIG RUN	Run time counter is triggered. See parameter group 29 MAINTENANCE TRIG .	43
	M.TRIG MWH	MWh counter is triggered. See parameter group 29 MAINTENANCE TRIG .	44
	SEQ PROG	Relay output control with sequence programming. See parameter 8423 ST1 OUT CONTROL .	50
	MBRK	On/Off control of a mechanical brake. See parameter group 43 MECH BRK CONTROL .	51
	JOG ACTIVE	Jogging function active. See parameter 1010 JOGGING SEL .	52
1404	RO 1 ON DELAY	Defines the operation delay for relay output RO.	0
	0.0...3600.0 s	Delay time. The figure below illustrates the operation (on) and release (off) delays for relay output RO. 	1 = 0.1 s
1405	RO 1 OFF DELAY	Defines the release delay for relay output RO.	0
	0.0...3600.0 s	Delay time. See figure in parameter 1404 RO 1 ON DELAY .	1 = 0.1 s
15 ANALOGUE OUTPUTS		Selection of the actual signals to be indicated through analog output and output signal processing	
1501	AO1 CONTENT SEL	Connects a drive signal to analog output AO.	103
	x...x	Parameter index in group 01 OPERATING DATA . E.g. 102 = 0102 SPEED.	
1502	AO1 CONTENT MIN	Defines the minimum value for signal selected with parameter 1501 AO1 CONTENT SEL . AO minimum and maximum correspond the 1504 MINIMUM AO1 and 1505 MAXIMUM AO1 settings as follows: 	-
	x...x	Setting range depends on parameter 1501 AO1 CONTENT SEL setting.	-
1503	AO1 CONTENT MAX	Defines the maximum value for signal selected with parameter 1501 AO1 CONTENT SEL . See figure in parameter 1502 AO1 CONTENT MIN .	-
	x...x	Setting range depends on parameter 1501 AO1 CONTENT SEL setting.	-
1504	MINIMUM AO1	Defines the minimum value for the analog output signal AO. See figure in parameter 1502 AO1 CONTENT MIN .	0
	0.0...20.0 mA	Minimum value	1 = 0.1 mA
1505	MAXIMUM AO1	Defines the maximum value for the analog output signal AO. See figure in parameter 1502 AO1 CONTENT MIN .	20
	0.0...20.0 mA	Maximum value	1 = 0.1 mA

Parameters – complete descriptions			
Index	Name/Selection	Description	Def, FbEq
1506	FILTER AO1	Defines the filter time constant for analog output AO, i.e the time within 63% of a step change is reached. See figure in parameter 1303 FILTER AI1.	0.1
	0.0...10.0 s	Filter time constant	1 = 0.1 s
16 SYSTEM CONTROLS		Run Enable, parameter lock etc.	
1601	RUN ENABLE	Selects a source for the external Run Enable signal.	NOT SEL
	NOT SEL	Allows the drive to start without an external Run Enable signal.	0
	DI1	External signal required through digital input DI1. 1 = Run Enable. If Run Enable signal is switched off, the drive will not start or coasts to stop if it is running.	1
	DI2	See selection DI1.	2
	DI3	See selection DI1.	3
	DI4	See selection DI1.	4
	DI5	See selection DI1.	5
	COMM	Fieldbus interface as the source for inverted Run Enable signal (Run Disable), i.e. control word 0301 FB CMD WORD 1 bit 6 (with ABB drives profile 5319 EFB PAR 19 bit 3). The control word is sent by the fieldbus controller via the fieldbus adapter or embedded fieldbus (modbus) to the drive. For the control word bits, see sections DCU communication profile on page 262 and ABB Drives communication profile on page 258 .	7
	DI1(INV)	External signal required through inverted digital input DI1. 0 = Run Enable. If Run Enable signal is switched on, the drive will not start or coasts to stop if it is running.	-1
	DI2(INV)	See selection DI1(INV)	-2
	DI3(INV)	See selection DI1(INV)	-3
	DI4(INV)	See selection DI1(INV)	-4
	DI5(INV)	See selection DI1(INV)	-5
1602	PARAMETER LOCK	Selects the state of the parameter lock. The lock prevents parameter changing from control panel.	OPEN
	LOCKED	Parameter values cannot be changed from the control panel. The lock can be opened by entering the valid code to parameter 1603 PASS CODE. The lock does not prevent parameter changes made by macros or fieldbus.	0
	OPEN	The lock is open. Parameter values can be changed.	1
	NOT SAVED	Parameter changes made by control panel are not stored into the permanent memory. To store changed parameter values, set parameter 1607 PARAM SAVE value to SAVE.	2
1603	PASS CODE	Selects the pass code for the parameter lock (see parameter 1602 PARAMETER LOCK).	0
	0...65535	Pass code. Setting 358 opens the lock. The value reverts back to 0 automatically.	1 = 1
1604	FAULT RESET SEL	Selects the source for the fault reset signal. The signal resets the drive after a fault trip if the cause of the fault no longer exists.	KEYPAD
	KEYPAD	Fault reset only from the control panel	0
	DI1	Reset through digital input DI1 (reset by a rising edge of DI1) or by control panel	1
	DI2	See selection DI1.	2

Parameters – complete descriptions															
Index	Name/Selection	Description	Def, FbEq												
	DI3	See selection DI1.	3												
	DI4	See selection DI1.	4												
	DI5	See selection DI1.	5												
	START/STOP	Reset along with the stop signal received through a digital input, or by control panel. Note: Do not use this option when start, stop and direction commands are received through fieldbus communication.	7												
	COMM	Fieldbus interface as the source for the fault reset signal, i.e. control word 0301 FB CMD WORD 1 bit 4 (with ABB drives profile 5319 EFB PAR 19 bit 7). The control word is sent by the fieldbus controller via the fieldbus adapter or embedded fieldbus (modbus) to the drive. For the control word bits, see sections <i>DCU communication profile</i> on page 262 and <i>ABB Drives communication profile</i> on page 258.	8												
	DI1(INV)	Reset through inverted digital input DI1 (reset by a falling edge of DI1) or by control panel	-1												
	DI2(INV)	See selection DI1(INV).	-2												
	DI3(INV)	See selection DI1(INV).	-3												
	DI4(INV)	See selection DI1(INV).	-4												
	DI5(INV)	See selection DI1(INV).	-5												
1605	USER PAR SET CHG	Enables the change of the User Parameter Set through a digital input. See parameter 9902 APPLIC MACRO. The change is only allowed when the drive is stopped. During the change, the drive will not start. Note: Always save the User Parameter Set by parameter 9902 after changing any parameter setting, or reperforming the motor identification. The last settings saved by the user are loaded into use whenever the power is switched off and on again or the parameter 9902 setting is changed. Any unsaved changes will be lost. Note: The value of this parameter is not included in the User Parameter Sets. A setting once made remains despite User Parameter Set change. Note: Selection of User Parameter Set 2 can be supervised via relay output RO. See parameter 1401 RELAY OUTPUT 1.	NOT SEL												
	NOT SEL	User Parameter Set change is not possible through a digital input. Parameter Sets can be changed only from control panel.	0												
	DI1	User Parameter Set control through digital input DI1. Falling edge of digital input DI1: User Parameter Set 1 is loaded into use. Rising edge of digital input DI1: User Parameter Set 2 is loaded into use.	1												
	DI2	See selection DI1.	2												
	DI3	See selection DI1.	3												
	DI4	See selection DI1.	4												
	DI5	See selection DI1.	5												
	DI1,2	User Parameter Set selection through digital inputs DI1 and DI2. 1 = DI active, 0 = DI inactive. <table border="1" data-bbox="443 1787 1241 1912"> <thead> <tr> <th>DI1</th> <th>DI2</th> <th>User Parameter Set</th> </tr> </thead> <tbody> <tr> <td>0</td> <td>0</td> <td>User Parameter Set 1</td> </tr> <tr> <td>1</td> <td>0</td> <td>User Parameter Set 2</td> </tr> <tr> <td>0</td> <td>1</td> <td>User Parameter Set 3</td> </tr> </tbody> </table>	DI1	DI2	User Parameter Set	0	0	User Parameter Set 1	1	0	User Parameter Set 2	0	1	User Parameter Set 3	7
DI1	DI2	User Parameter Set													
0	0	User Parameter Set 1													
1	0	User Parameter Set 2													
0	1	User Parameter Set 3													
	DI2,3	See selection DI1,2.	8												

Parameters – complete descriptions															
Index	Name/Selection	Description	Def, FbEq												
	DI3,4	See selection DI1,2.	9												
	DI4,5	See selection DI1,2.	10												
	DI1(INV)	User Parameter Set control through inverted digital input DI1. Falling edge of inverted digital input DI1: User Parameter Set 2 is loaded into use. Rising edge of inverted digital input DI1: User Parameter Set 1 is loaded into use.	-1												
	DI2(INV)	See selection DI1(INV).	-2												
	DI3(INV)	See selection DI1(INV).	-3												
	DI4(INV)	See selection DI1(INV).	-4												
	DI5(INV)	See selection DI1(INV).	-5												
	DI1,2(INV)	User Parameter Set selection through inverted digital inputs DI1 and DI2. 1 = DI inactive, 0 =DI active. <table border="1" data-bbox="528 734 1331 864"> <thead> <tr> <th>DI1</th> <th>DI2</th> <th>User Parameter Set</th> </tr> </thead> <tbody> <tr> <td>1</td> <td>1</td> <td>User Parameter Set 1</td> </tr> <tr> <td>0</td> <td>1</td> <td>User Parameter Set 2</td> </tr> <tr> <td>1</td> <td>0</td> <td>User Parameter Set 3</td> </tr> </tbody> </table>	DI1	DI2	User Parameter Set	1	1	User Parameter Set 1	0	1	User Parameter Set 2	1	0	User Parameter Set 3	-7
DI1	DI2	User Parameter Set													
1	1	User Parameter Set 1													
0	1	User Parameter Set 2													
1	0	User Parameter Set 3													
	DI2,3(INV)	See selection DI1,2(INV).	-8												
	DI3,4(INV)	See selection DI1,2(INV).	-9												
	DI4,5(INV)	See selection DI1,2(INV).	-10												
1606	LOCAL LOCK	Disables entering local control mode or selects the source for the local control mode lock signal. When local lock is active, entering the local control mode is disabled (LOC/REM key of the panel).	NOT SEL												
	NOT SEL	Local control is allowed.	0												
	DI1	Local control mode lock signal through digital input DI1. Rising edge of digital input DI1: Local control disabled. Falling edge of digital input DI1: Local control allowed.	1												
	DI2	See selection DI1.	2												
	DI3	See selection DI1.	3												
	DI4	See selection DI1.	4												
	DI5	See selection DI1.	5												
	ON	Local control is disabled.	7												
	COMM	Fieldbus interface as the source for the local lock, i.e. control word 0301 FB CMD WORD 1 bit 14. The control word is sent by the fieldbus controller via the fieldbus adapter or embedded fieldbus (modbus) to the drive. For the control word bits, see section DCU communication profile on page 262 . Note: This setting applies only for the DCU profile!	8												
	DI1(INV)	Local lock through inverted digital input DI1. Rising edge of inverted digital input DI1: Local control allowed. Falling edge of inverted digital input DI1: Local control disabled.	-1												
	DI2(INV)	See selection DI1(INV).	-2												
	DI3(INV)	See selection DI1(INV).	-3												
	DI4(INV)	See selection DI1(INV).	-4												
	DI5(INV)	See selection DI1(INV).	-5												

Parameters – complete descriptions			
Index	Name/Selection	Description	Def, FbEq
1607	PARAM SAVE	Saves the valid parameter values to the permanent memory. Note: A new parameter value of a standard macro is saved automatically when changed from the panel but not when altered through a fieldbus connection.	DONE
	DONE	Saving completed	0
	SAVE...	Saving in progress	1
1608	START ENABLE 1	Selects the source for the Start Enable 1 signal. Note: Functionality of the Start Enable signal is different from the Run Enable signal. Example: External damper control application using Start Enable and Run Enable. Motor can start only after the damper is fully open.	NOT SEL
		<p>The diagram illustrates the sequence of events for a damper-controlled motor start. It shows the timing of various signals and states:</p> <ul style="list-style-type: none"> Start/Stop command (group 10): A pulse that initiates the drive start. Start Enable signals (1608 and 1609): A signal that must be active for the drive to start. Relay energized: Occurs when the drive starts, leading to the started output status (group 14). Relay de-energized: Occurs when the drive stops. Damper closed: The initial state of the damper. Damper opening time: The time taken for the damper to move from closed to fully open. Damper open: The state reached after the opening time. Damper closing time: The time taken for the damper to move from open back to closed. Damper closed: The state reached after the closing time. Damper status: A signal that indicates the current damper position. Run Enable signal from the damper end switch (1601): A signal that becomes active when the damper is fully open. Motor speed: Shows the motor accelerating during the damper opening time and decelerating during the damper closing time. Motor status: Shows the motor's operational state, including acceleration time (2202) and deceleration time (2203). 	
	NOT SEL	Start Enable signal is on.	0
	DI1	External signal required through digital input DI1. 1 = Start Enable. If Start Enable signal is switched off, the drive will not start or it coasts to stop if it is running and alarm START ENABLE 1 MISSING is activated.	1
	DI2	See selection DI1.	2
	DI3	See selection DI1.	3
	DI4	See selection DI1.	4
	DI5	See selection DI1.	5

Parameters – complete descriptions			
Index	Name/Selection	Description	Def, FbEq
	COMM	Fieldbus interface as the source for the inverted Start Enable (Start Disable) signal, i.e. control word 0302 FB CMD WORD 2 bit 18 (bit 19 for Start Enable 2). The control word is sent by the fieldbus controller via the fieldbus adapter or embedded fieldbus (modbus) to the drive. For the control word bits, see section DCU communication profile on page 262 . Note: This setting applies only for the DCU profile!	7
	DI1(INV)	External signal required through inverted digital input DI1. 0 = Start Enable. If Start Enable signal is switched off, the drive will not start or it coasts to stop if it is running and alarm START ENABLE 1 MISSING is activated.	-1
	DI2(INV)	See selection DI1(INV).	-2
	DI3(INV)	See selection DI1(INV).	-3
	DI4(INV)	See selection DI1(INV).	-4
	DI5(INV)	See selection DI1(INV).	-5
1609	START ENABLE 2	Selects the source for the Start Enable 2 signal. See parameter 1608 START ENABLE 1. See parameter 1608 .	NOT SEL
1610	DISPLAY ALARMS	Activates/deactivates alarms OVERCURRENT (2001), OVERVOLTAGE (2002), UNDERVOLTAGE (2003) and DEVICE OVERTEMP (2009). For more information see chapter Fault tracing .	NO
	NO	Alarms are inactive.	0
	YES	Alarms are active.	1
1611	PARAMETER VIEW	Selects the parameter view, i.e which parameters are shown. Note: This parameter is visible only when it is activated by the optional FlashDrop device. FlashDrop is designed for fast copying of parameters to unpowered drives. It allows for easy customisation of the parameter list, e.g. selected parameters can be hidden. For more information, see MFDT-01 FlashDrop User's Manual [3AFE68591074 (English)]. FlashDrop parameter values are activated by setting parameter 9902 APPLIC MACRO to LOAD FD SET.	DEFAULT
	DEFAULT	Complete long and short parameter lists	0
	FLASHDROP	FlashDrop parameter list. Does not include short parameter list. Parameters which are hidden by the FlashDrop device are not visible.	1
18 FREQ IN & TRAN OUT		Frequency input and transistor output signal processing.	
1801	FREQ INPUT MIN	Defines the minimum input value when DI5 is used as a frequency input. See section Frequency input on page 105 .	0
	0...10000 Hz	Minimum frequency	1 = 1 Hz
1802	FREQ INPUT MAX	Defines the maximum input value when DI5 is used as a frequency input. See section Frequency input on page 105 .	1000
	0...10000 Hz	Maximum frequency	1 = 1 Hz
1803	FILTER FREQ IN	Defines the filter time constant for frequency input, i.e the time within 63% of a step change is reached. See section Frequency input on page 105 .	0.1
	0.0...10.0 s	Filter time constant	1 = 0.1 s
1804	TO MODE	Selects the operation mode for the transistor output TO. See section Transistor output on page 105 .	DIGITAL
	DIGITAL	Transistor output is used as a digital output DO.	0

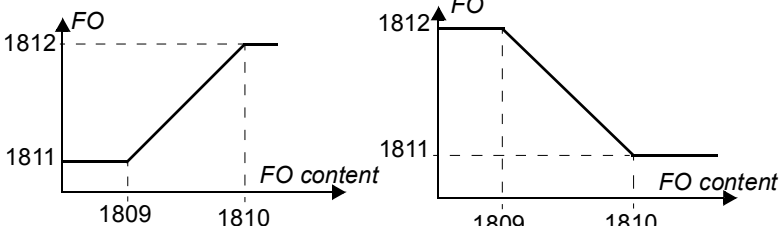
Parameters – complete descriptions			
Index	Name/Selection	Description	Def, FbEq
	FREQUENCY	Transistor output is used as a frequency output FO.	1
1805	DO SIGNAL	Selects a drive status indicated through digital output DO. See parameter 1401 RELAY OUTPUT 1.	FAULT(-1)
1806	DO ON DELAY	Defines the operation delay for digital output DO. Delay time	0 1 = 0.1 s
1807	DO OFF DELAY	Defines the release delay for digital output DO. Delay time	0 1 = 0.1 s
1808	FO CONTENT SEL	Selects a drive signal to be connected to frequency output FO.	104
	x...x	Parameter index in group 01 OPERATING DATA . E.g. 102 = 0102 SPEED.	
1809	FO CONTENT MIN	Defines the minimum frequency output FO signal value. Signal is selected with parameter 1808 FO CONTENT SEL. FO minimum and maximum correspond to 1811 MINIMUM FO and 1812 MAXIMUM FO settings as follows: 	-
	x...x	Setting range depends on parameter 1808 FO CONTENT SEL setting.	-
1810	FO CONTENT MAX	Defines the maximum frequency output FO signal value. Signal is selected with parameter 1808 FO CONTENT SEL. See parameter 1809 FO CONTENT MIN.	-
	x...x	Setting range depends on parameter 1808 FO CONTENT SEL setting.	-
1811	MINIMUM FO	Defines the minimum value for frequency output FO. Minimum frequency. See parameter 1809 FO CONTENT MIN.	10 1 = 1 Hz
1812	MAXIMUM FO	Defines the maximum value for frequency output FO. Maximum frequency. See parameter 1809 FO CONTENT MIN.	1000 1 = 1 Hz
1813	FILTER FO	Defines the filter time constant for frequency output FO, i.e the time within 63% of a step change is reached. Filter time constant	0.1 1 = 0.1 s
19 TIMER & COUNTER		Timer and counter for start and stop control	
1901	TIMER DELAY	Defines the time delay for the timer. Delay time	10 1 = 0.01 s
1902	TIMER START	Selects the source for the timer start signal.	NOT SEL
	DI1(INV)	Timer start through inverted digital input DI1. Timer start by a falling edge of digital input DI1. Note: Timer start is not possible when reset is active (parameter 1903 TIMER RESET).	-1
	DI2(INV)	See selection DI1(INV).	-2
	DI3(INV)	See selection DI1(INV).	-3
	DI4(INV)	See selection DI1(INV).	-4

Parameters – complete descriptions			
Index	Name/Selection	Description	Def, FbEq
	DI5(INV)	See selection DI1(INV).	-5
	NOT SEL	No start signal	0
	DI1	Timer start through digital input DI1. Timer start by rising edge of digital input DI1. Note: Timer start is not possible when reset is active (parameter 1903 TIMER RESET).	1
	DI2	See selection DI1.	2
	DI3	See selection DI1.	3
	DI4	See selection DI1.	4
	DI5	See selection DI1.	5
	START	External start signal, e.g. start signal through fieldbus	6
1903	TIMER RESET	Selects the source for the timer reset signal.	NOT SEL
	DI1(INV)	Timer reset through inverted digital input DI1. 0 = active, 1 = inactive.	-1
	DI2(INV)	See selection DI1(INV).	-2
	DI3(INV)	See selection DI1(INV).	-3
	DI4(INV)	See selection DI1(INV).	-4
	DI5(INV)	See selection DI1(INV).	-5
	NOT SEL	No reset signal	0
	DI1	Timer reset through digital input DI1. 1 = active, 0 = inactive.	1
	DI2	See selection DI1.	2
	DI3	See selection DI1.	3
	DI4	See selection DI1.	4
	DI5	See selection DI1.	5
	START	Timer reset at start. Start signal source is selected by parameter 1902 TIMER START.	6
	START (INV)	Time reset at start (inverted), i.e. timer is reset when start signal is deactivated. Start signal source is selected by parameter 1902 TIMER START.	7
	RESET	External reset, e.g. reset through fieldbus	8
1904	COUNTER ENABLE	Selects the source for the counter enable signal.	DISABLED
	DI1(INV)	Counter enable signal through inverted digital input DI1. 0 = active, 1 = inactive.	-1
	DI2(INV)	See selection DI1(INV).	-2
	DI3(INV)	See selection DI1(INV).	-3
	DI4(INV)	See selection DI1(INV).	-4
	DI5(INV)	See selection DI1(INV).	-5
	DISABLED	No counter enable	0
	DI1	Counter enable signal through digital input DI1. 1 = active, 0 = inactive.	1
	DI2	See selection DI1.	2
	DI3	See selection DI1.	3
	DI4	See selection DI1.	4
	DI5	See selection DI1.	5

Parameters – complete descriptions			
Index	Name/Selection	Description	Def, FbEq
	ENABLED	Counter enabled	6
1905	COUNTER LIMIT	Defines the counter limit.	1000
	0...65535	Limit value	1 = 1
1906	COUNTER INPUT	Selects the input signal source for the counter.	PLS IN(DI5)
	PLS IN(DI 5)	Digital input DI5 pulses. When a pulse is detected, the counter value increases by 1.	1
	ENC W/O DIR	Encoder pulse edges. When a rising or a falling edge is detected, the counter value increases by 1.	2
	ENC WITH DIR	Encoder pulse edges. The direction of rotation is taken into account. When a rising or a falling edge is detected and the direction of rotation is forward, the counter value increases by 1. When the direction of rotation is reverse, the counter value decreases by 1.	3
	FILTERED DI5	Filtered digital input DI5 pulses. When a pulse is detected, the counter value increases by 1. Note: Due to filtering, the maximum input signal frequency is 50 Hz.	4
1907	COUNTER RESET	Selects the source for the counter reset signal.	NOT SEL
	DI1(INV)	Counter reset through inverted digital input DI1. 0 = active, 1 = inactive.	-1
	DI2(INV)	See selection DI1(INV).	-2
	DI3(INV)	See selection DI1(INV).	-3
	DI4(INV)	See selection DI1(INV).	-4
	DI5(INV)	See selection DI1(INV).	-5
	NOT SEL	No reset signal	0
	DI1	Counter reset through digital input DI1. 1 = active, 0 = inactive.	1
	DI2	See selection DI1.	2
	DI3	See selection DI1.	3
	DI4	See selection DI1.	4
	DI5	See selection DI1.	5
	AT LIMIT	Reset at the limit defined by parameter 1905 COUNTER LIMIT	6
	STRT/STP CMD	Counter reset at start/stop command. Source for the start/stop is selected by parameter 1911 CNTR S/S COMMAND.	7
	S/S CMD(INV)	Counter reset at start/stop command (inverted), i.e. counter is reset when start/stop command is deactivated. Start signal source is selected by parameter 1902 TIMER START.	8
	RESET	Reset enabled	9
1908	COUNTER RES VAL	Defines the value for the counter after reset.	0
	0...65535	Counter value	1 = 1
1909	COUNT DIVIDER	Defines the divider for the pulse counter.	0
	0...12	Pulse counter divider N. Every 2^N bit is counted.	1 = 1
1910	COUNT DIRECTION	Defines the source for the counter direction selection.	UP
	DI1(INV)	Counter direction selection through inverted digital input DI1. 1 = counts up, 0 = counts down.	-1
	DI2(INV)	See selection DI1(INV).	-2
	DI3(INV)	See selection DI1(INV).	-3
	DI4(INV)	See selection DI1(INV).	-4

Parameters – complete descriptions			
Index	Name/Selection	Description	Def, FbEq
	DI5(INV)	See selection DI1(INV).	-5
	UP	Counts up	0
	DI1	Counter direction selection through digital input DI1. 0 = counts up, 1 = counts down.	1
	DI2	See selection DI1.	2
	DI3	See selection DI1.	3
	DI4	See selection DI1.	4
	DI5	See selection DI1.	5
	DOWN	Counts down	6
1911	CNTR S/S COMMAND	Selects the source for the drive start/stop command when parameter 1001 EXT1 COMMANDS value is set to COUNTER START / COUNTER STOP.	NOT SEL
	DI1(INV)	Start/stop command through inverted digital input DI1. When par. 1001 value is COUNTER STOP: 0 = start. Stop when counter limit defined by parameter 1905 COUNTER LIMIT has been exceeded. When par. 1001 value is COUNTER START: 0 = stop. Start when counter limit defined by parameter 1905 has been exceeded.	-1
	DI2(INV)	See selection DI1(INV).	-2
	DI3(INV)	See selection DI1(INV).	-3
	DI4(INV)	See selection DI1(INV).	-4
	DI5(INV)	See selection DI1(INV).	-5
	NOT SEL	Not start/stop command source	0
	DI1	Start/stop command through digital input DI1. When par. 1001 value is COUNTER STOP: 1 = start. Stop when counter limit defined by parameter 1905 COUNTER LIMIT has been exceeded. When par. 1001 value is COUNTER START: 1 = stop. Start when counter limit defined by parameter 1905 has been exceeded.	1
	DI2	See selection DI1.	2
	DI3	See selection DI1.	3
	DI4	See selection DI1.	4
	DI5	See selection DI1.	5
	ACTIVATE	External start/stop command, e.g. through fieldbus	6

Parameters – complete descriptions			
Index	Name/Selection	Description	Def, FbEq
20 LIMITS		Drive operation limits. Speed values are used with vector control and frequency values are used with scalar control. The control mode is selected by parameter 9904 MOTOR CTRL MODE.	
2001	MINIMUM SPEED	<p>Defines the allowed minimum speed. A positive (or zero) minimum speed value defines two ranges, one positive and one negative. A negative minimum speed value defines one speed range.</p>	0
	-30000...30000 rpm	Minimum speed	1 = 1 rpm
2002	MAXIMUM SPEED	Defines the allowed maximum speed. See parameter 2001 MINIMUM SPEED.	Eur: 1500 / US: 1800
	0...30000 rpm	Maximum speed	1 = 1 rpm
2003	MAX CURRENT	Defines the allowed maximum motor current.	$1.8 \cdot I_{2N}$
	0.0... $1.8 \cdot I_{2N}$ A	Current	1 = 0.1 A
2005	OVERVOLT CTRL	<p>Activates or deactivates the overvoltage control of the intermediate DC link. Fast braking of a high inertia load causes the voltage to rise to the overvoltage control limit. To prevent the DC voltage from exceeding the limit, the overvoltage controller automatically decreases the braking torque. Note: If a brake chopper and resistor are connected to the drive, the controller must be off (selection DISABLE) to allow chopper operation.</p>	ENABLE
	DISABLE	Overvoltage control deactivated	0
	ENABLE	Overvoltage control activated	1
2006	UNDERVOLT CTRL	<p>Activates or deactivates the undervoltage control of the intermediate DC link. If the DC voltage drops due to input power cut off, the undervoltage controller will automatically decrease the motor speed in order to keep the voltage above the lower limit. By decreasing the motor speed, the inertia of the load will cause regeneration back into the drive, keeping the DC link charged and preventing an undervoltage trip until the motor coasts to stop. This will act as a power-loss ride-through functionality in systems with a high inertia, such as a centrifuge or a fan. See section Power loss ride-through on page 107.</p>	ENABLE (TIME)
	DISABLE	Undervoltage control deactivated	0
	ENABLE(TIME)	Undervoltage control activated. The undervoltage control is active for 500 ms.	1
	ENABLE	Undervoltage control activated. No operation time limit.	2

Parameters – complete descriptions			
Index	Name/Selection	Description	Def, FbEq
2007	MINIMUM FREQ	<p>Defines the minimum limit for the drive output frequency. A positive (or zero) minimum frequency value defines two ranges, one positive and one negative. A negative minimum frequency value defines one speed range.</p> <p>Note: MINIMUM FREQ ≤ MAXIMUM FREQ.</p>	0
	-500.0...500.0 Hz	Minimum frequency	1 = 0.1 Hz
2008	MAXIMUM FREQ	Defines the maximum limit for the drive output frequency.	Eur: 50 / US: 60
	0.0...500.0 Hz	Maximum frequency	1 = 0.1 Hz
2013	MIN TORQUE SEL	Selects the minimum torque limit for the drive.	MIN TORQUE 1
	MIN TORQUE 1	Value defined by parameter 2015 MIN TORQUE 1	0
	DI1	Digital input DI1. 0 = parameter 2015 MIN TORQUE 1 value. 1 = parameter 2016 MIN TORQUE 2 value.	1
	DI2	See selection DI1.	2
	DI3	See selection DI1.	3
	DI4	See selection DI1.	4
	DI5	See selection DI1.	5
	COMM	<p>Fieldbus interface as the source for the torque limit 1/2 selection, i.e. control word 0301 FB CMD WORD 1 bit 15. The control word is sent by the fieldbus controller via the fieldbus adapter or embedded fieldbus (modbus) to the drive. For the control word bits, see section DCU communication profile on page 262.</p> <p>Minimum torque limit 1 is defined by parameter 2015 MIN TORQUE 1 and minimum torque limit 2 is defined by parameter 2016 MIN TORQUE 2.</p> <p>Note: This setting applies only for the DCU profile!</p>	7
	DI1(INV)	Inverted digital input DI1. 1 = value of parameter 2015 MIN TORQUE 1. 0 = value of parameter 2016 MIN TORQUE 2.	-1
	DI2(INV)	See selection DI1(INV).	-2
	DI3(INV)	See selection DI1(INV).	-3
	DI4(INV)	See selection DI1(INV).	-4
	DI5(INV)	See selection DI1(INV).	-5
2014	MAX TORQUE SEL	Selects the maximum torque limit for the drive.	MAX TORQUE 1
	MAX TORQUE 1	Value of parameter 2017 MAX TORQUE 1	
	DI1	Digital input DI1. 0 = parameter 2017 MAX TORQUE 1 value. 1 = parameter 2018 MAX TORQUE 2 value.	1

Parameters – complete descriptions			
Index	Name/Selection	Description	Def, FbEq
	DI2	See selection DI1.	2
	DI3	See selection DI1.	3
	DI4	See selection DI1.	4
	DI5	See selection DI1.	5
	COMM	Fieldbus interface as the source for the torque limit 1/2 selection, i.e. control word 0301 FB CMD WORD 1 bit 15. The control word is sent by the fieldbus controller via the fieldbus adapter or embedded fieldbus (modbus) to the drive. For the control word bits, see section <i>DCU communication profile</i> on page 262. Maximum torque limit 1 is defined by parameter 2017 MAX TORQUE 1 and maximum torque limit 2 is defined by parameter 2018 MAX TORQUE 2. Note: This setting applies only for the DCU profile!	7
	DI1(INV)	Inverted digital input DI1. 1 = parameter 2017 MAX TORQUE 1 value. 0 = parameter 2018 MAX TORQUE 2 value.	-1
	DI2(INV)	See selection DI1(INV).	-2
	DI3(INV)	See selection DI1(INV).	-3
	DI4(INV)	See selection DI1(INV).	-4
	DI5(INV)	See selection DI1(INV).	-5
2015	MIN TORQUE 1	Defines minimum torque limit 1 for the drive. See parameter 2013 MIN TORQUE SEL.	-300
	-600.0...0.0%	Value in percent of the motor nominal torque	1 = 0.1%
2016	MIN TORQUE 2	Defines minimum torque limit 2 for the drive. See parameter 2013 MIN TORQUE SEL.	-300
	-600.0...0.0%	Value in percent of the motor nominal torque	1 = 0.1%
2017	MAX TORQUE 1	Defines maximum torque limit 1 for the drive. See parameter 2014 MAX TORQUE SEL.	300
	0.0...600.0%	Value in percent of the motor nominal torque	1 = 0.1%
2018	MAX TORQUE 2	Defines maximum torque limit 2 for the drive. See parameter 2014 MAX TORQUE SEL.	300
	0.0...600.0%	Value in percent of the motor nominal torque	1 = 0.1%
2019	BRAKE CHOPPER	Old parameter. Left out in sw version 2.51b and later. See parameter 2202 .	
2020	BRAKE CHOPPER	Selects the brake chopper control. (Only in sw version 2.51b or later).	INBUILT
	INBUILT	Internal brake chopper control. Note: Ensure the brake resistor(s) is installed and the overvoltage control is switched off by setting parameter 2005 OVERVOLT CTRL to selection DISABLE.	0
	EXTERNAL	External brake chopper control. Note: The drive is compatible only with ABB ACS-BRK-X brake units. Note: Ensure the brake unit is installed and the overvoltage control is switched off by setting parameter 2005 OVERVOLT CTRL to selection DISABLE.	1

Parameters – complete descriptions			
Index	Name/Selection	Description	Def, FbEq
21 START/STOP		Start and stop modes of the motor	
2101	START FUNCTION	Selects the motor starting method.	AUTO
	AUTO	The drive starts the motor instantly from zero frequency if parameter 9904 MOTOR CTRL MODE setting is SCALAR:FREQ. If flying start is required use selection SCAN START. If parameter 9904 MOTOR CTRL MODE value is VECTOR:SPEED/ VECTOR:TORQ, the drive pre-magnetises the motor with DC current before the start. The pre-magnetising time is defined by parameter 2103 DC MAGN TIME. See selection DC MAGN.	1
	DC MAGN	The drive pre-magnetises the motor with DC current before the start. The pre-magnetising time is defined by parameter 2103 DC MAGN TIME. If parameter 9904 MOTOR CTRL MODE value is VECTOR:SPEED/ VECTOR:TORQ, DC magnetising guarantees the highest possible break-away torque when the pre-magnetising is set long enough. Note: Starting to a rotating machine is not possible when DC MAGN is selected. WARNING! The drive will start after the set pre-magnetising time has passed even if the motor magnetisation is not completed. Ensure always in applications where a full break-away torque is essential, that the constant magnetising time is long enough to allow generation of full magnetisation and torque.	2
	TORQ BOOST	Torque boost should be selected if a high break-away torque is required. Used only when parameter 9904 MOTOR CTRL MODE setting is SCALAR:FREQ. The drive pre-magnetises the motor with DC current before the start. The pre-magnetising time is defined by parameter 2103 DC MAGN TIME. Torque boost is applied at start. Torque boost is stopped when output frequency exceeds 20 Hz or when it is equal to the reference value. See parameter 2110 TORQ BOOST CURR. Note: Starting to a rotating machine is not possible when TORQ BOOST is selected. WARNING! The drive will start after the set pre-magnetising time has passed although the motor magnetisation is not completed. Ensure always in applications where a full break-away torque is essential, that the constant magnetising time is long enough to allow generation of full magnetisation and torque.	4
	SCAN START	Frequency scanning flying start (starting to a rotating machine). Based on frequency scanning (interval 2008 MAXIMUM FREQ... 2007 MINIMUM FREQ) to identify the frequency. If frequency identification fails, DC magnetisation is used (see selection DC MAGN).	6
	SCAN + BOOST	Combines scanning start (starting to a rotating machine) and torque boost. See selections SCANSTART and TORQ BOOST. If frequency identification fails, torque boost is used. Used only when parameter 9904 MOTOR CTRL MODE setting is SCALAR:FREQ.	7
2102	STOP FUNCTION	Selects the motor stop function.	COAST
	COAST	Stop by cutting off the motor power supply. The motor coasts to a stop.	1
	RAMP	Stop along a ramp. See parameter group 22 ACCEL/DECEL .	2

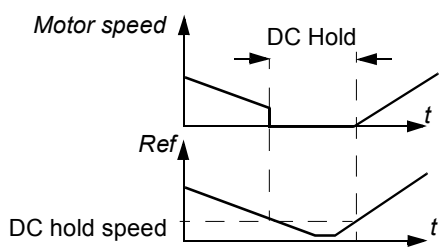
Parameters – complete descriptions			
Index	Name/Selection	Description	Def, FbEq
	SPEED COMP	Speed compensation is used for constant distance braking. Speed difference (between used speed and maximum speed) is compensated by running the drive with current speed before the motor is stopped along a ramp. See section Speed compensated stop on page 108.	3
	SPD COMP FWD	Speed compensation is used for constant distance braking if the direction of rotation is forward. Speed difference (between used speed and maximum speed) is compensated by running the drive with current speed before the motor is stopped along a ramp. See section Speed compensated stop on page 108. If the direction of rotation is reverse, the drive is stopped along a ramp.	4
	SPD COMP REV	Speed compensation is used for constant distance braking if the direction of rotation is reverse. Speed difference (between used speed and maximum speed) is compensated by running the drive with current speed before the motor is stopped along a ramp. See section Speed compensated stop on page 108. If the direction of rotation is forward, the drive is stopped along a ramp.	5
2103	DC MAGN TIME	Defines the pre-magnetising time. See parameter 2101 START FUNCTION. After the start command, the drive automatically pre-magnetises the motor the set time.	0.3
	0.00...10.00 s	Magnetising time. Set this value long enough to allow full motor magnetization. Too long time heats the motor excessively.	1 = 0.01 s
2104	DC HOLD CTL	Activates the DC Hold or DC braking function.	NOT SEL
	NOT SEL	Inactive	0
	DC HOLD	DC Hold function active. DC Hold is not possible if parameter 9904 MOTOR CTRL MODE setting is SCALAR:FREQ. When both the reference and the motor speed drop below the value of parameter 2105 DC HOLD SPEED, the drive will stop generating sinusoidal current and start to inject DC into the motor. The current is set by parameter 2106 DC CURR REF. When the reference speed exceeds parameter 2105 value, normal drive operation continues.  Note: DC Hold has no effect if the start signal is switched off. Note: Injecting DC current into the motor causes the motor to heat up. In applications where long DC hold times are required, externally ventilated motors should be used. If the DC hold period is long, the DC hold cannot prevent the motor shaft from rotating if a constant load is applied to the motor.	1
	DC BRAKING	DC current braking function active. If parameter 2102 STOP FUNCTION is set to COAST, DC braking is applied after the start command is removed. If parameter 2102 STOP FUNCTION is set to RAMP, DC braking is applied after the ramp.	2
2105	DC HOLD SPEED	Defines the DC hold speed. See parameter 2104 DC HOLD CTL.	5
	0...360 rpm	Speed	1 = 1 rpm

Parameters – complete descriptions			
Index	Name/Selection	Description	Def, FbEq
2106	DC CURR REF	Defines the DC hold current. See parameter 2104 DC HOLD CTL.	30
	0...100%	Value in percent of the motor nominal current (parameter 9906 MOTOR NOM CURR)	1 = 1%
2107	DC BRAKE TIME	Defines the DC brake time.	0
	0.0...250.0 s	Time	1 = 0.1 s
2108	START INHIBIT	Enables the start inhibit function. Drive start is inhibited if, <ul style="list-style-type: none"> - fault is reset. - Run Enable signal activates while the start command is active. See parameter 1601 RUN ENABLE. - control mode changes from local to remote. - external control mode switches from EXT1 to EXT2 or from EXT2 to EXT1. 	OFF
	OFF	Disabled	0
	ON	Enabled	1
2109	EMERG STOP SEL	Selects the source for the external emergency stop command. The drive cannot be restarted before the emergency stop command is reset. Note: The installation must include emergency stop devices and any other safety equipment that may be needed. Pressing STOP on the drive's control panel does NOT: <ul style="list-style-type: none"> - generate an emergency stop of the motor - separate the drive from dangerous potential. 	NOT SEL
	NOT SEL	Emergency stop function is not selected	0
	DI1	Digital input DI1. 1 = stop along the emergency stop ramp. See parameter 2208 EMER DEC TIME. 0 = emergency stop command reset.	1
	DI2	See selection DI1.	2
	DI3	See selection DI1.	3
	DI4	See selection DI1.	4
	DI5	See selection DI1.	5
	DI1(INV)	Inverted digital input DI. 0 = stop along the emergency stop ramp. See parameter 2208 EMER DEC TIME. 1 = emergency stop command reset	-1
	DI2(INV)	See selection DI1(INV).	-2
	DI3(INV)	See selection DI1(INV).	-3
	DI4(INV)	See selection DI1(INV).	-4
	DI5(INV)	See selection DI1(INV).	-5
2110	TORQ BOOST CURR	Defines the maximum supplied current during torque boost. See parameter 2101 START FUNCTION.	100
	15...300%	Value in percent	1 = 1%
2111	STOP SIGNAL DLY	Defines the stop signal delay time when parameter 2102 STOP FUNCTION is set to SPEED COMP.	0
	0...10000 ms	Delay time	1 = 1 ms

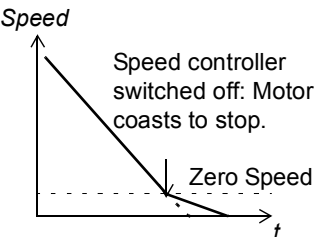
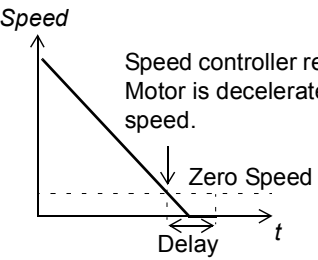
Parameters – complete descriptions			
Index	Name/Selection	Description	Def, FbEq
2112	ZERO SPEED DELAY	<p>Defines the delay for the Zero Speed Delay function. The function is useful in applications where a smooth and quick restarting is essential. During the delay the drive knows accurately the rotor position.</p> <div style="display: flex; justify-content: space-around;"> <div style="text-align: center;"> <p>No Zero Speed Delay</p>  </div> <div style="text-align: center;"> <p>With Zero Speed Delay</p>  </div> </div> <p>Zero speed delay can be used e.g. with jogging function or mechanical brake.</p> <p>No Zero Speed Delay</p> <p>The drive receives a stop command and decelerates along a ramp. When the motor actual speed falls below an internal limit (called Zero Speed), the speed controller is switched off. The inverter modulation is stopped and the motor coasts to standstill.</p> <p>With Zero Speed Delay</p> <p>The drive receives a stop command and decelerates along a ramp. When the actual motor speed falls below an internal limit (called Zero Speed), the zero speed delay function activates. During the delay the functions keeps the speed controller live: The inverter modulates, motor is magnetised and the drive is ready for a quick restart.</p>	0
	0.0...60.0 s	Delay time. If parameter value is set to zero, zero speed delay function is disabled.	1 = 0.1 s
22 ACCEL/DECEL		Acceleration and deceleration times	
2201	ACC/DEC 1/2 SEL	Defines the source from which the drive reads the signal that selects between the two ramp pairs, acceleration/deceleration pair 1 and 2. Ramp pair 1 is defined by parameters 2202...2204 . Ramp pair 2 is defined by parameters 2205...2207 .	D15
	NOT SEL	Ramp pair 1 is used.	0
	DI1	Digital input DI1. 1 = ramp pair 2, 0 = ramp pair 1.	1
	DI2	See selection DI1.	2
	DI3	See selection DI1.	3
	DI4	See selection DI1.	4
	DI5	See selection DI1.	5
	COMM	Fieldbus interface as the source for ramp pair 1/2 selection, i.e. control word 0301 FB CMD WORD 1 bit 10. The control word is sent by the fieldbus controller via the fieldbus adapter or embedded fieldbus (modbus) to the drive. For the control word bits, see section DCU communication profile on page 262 . Note: This setting applies only for the DCU profile!	7
	SEQ PROG	Sequence programming ramp defined by parameter 8422 ST1 RAMP (or 8432/.../8492)	10
	DI1(INV)	Inverted digital input DI1. 0 = ramp pair 2, 1 = ramp pair 1.	-1
	DI2(INV)	See selection DI1(INV).	-2

Parameters – complete descriptions			
Index	Name/Selection	Description	Def, FbEq
	DI3(INV)	See selection DI1(INV).	-3
	DI4(INV)	See selection DI1(INV).	-4
	DI5(INV)	See selection DI1(INV).	-5
2202	ACCELER TIME 1	<p>Defines the acceleration time 1 i.e. the time required for the speed to change from zero to the speed defined by parameter 2008 MAXIMUM FREQ (with scalar control) / 2002 MAXIMUM SPEED (with vector control). The control mode is selected by parameter 9904 MOTOR CTRL MODE.</p> <ul style="list-style-type: none"> - If the speed reference increases faster than the set acceleration rate, the motor speed will follow the acceleration rate. - If the speed reference increases slower than the set acceleration rate, the motor speed will follow the reference signal. - If the acceleration time is set too short, the drive will automatically prolong the acceleration in order not to exceed the drive operating limits. <p>Actual acceleration time depends on parameter 2204 RAMP SHAPE 1 setting.</p>	5
	0.0...1800.0 s	Time	1 = 0.1 s
2203	DECELER TIME 1	<p>Defines the deceleration time 1 i.e. the time required for the speed to change from the value defined by parameter 2008 MAXIMUM FREQ (with scalar control) / 2002 MAXIMUM SPEED (with vector control) to zero. The control mode is selected by parameter 9904 MOTOR CTRL MODE.</p> <ul style="list-style-type: none"> - If the speed reference decreases slower than the set deceleration rate, the motor speed will follow the reference signal. - If the reference changes faster than the set deceleration rate, the motor speed will follow the deceleration rate. - If the deceleration time is set too short, the drive will automatically prolong the deceleration in order not to exceed drive operating limits. <p>If a short deceleration time is needed for a high inertia application, the drive should be equipped with a brake resistor.</p> <p>Actual deceleration time depends on parameter 2204 RAMP SHAPE 1 setting.</p>	5
	0.0...1800.0 s	Time	1 = 0.1 s

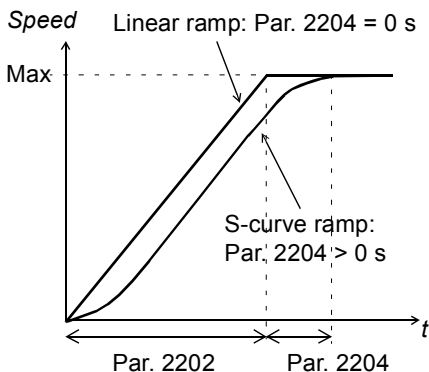
Parameters – complete descriptions			
Index	Name/Selection	Description	Def, FbEq
2204	RAMP SHAPE 1	Selects the shape of the acceleration/deceleration ramp 1. The function is deactivated during emergency stop and jogging.	0
	0.0...1000.0 s	<p>0.00 s: Linear ramp. Suitable for steady acceleration or deceleration and for slow ramps.</p> <p>0.01 ... 1000.00 s: S-curve ramp. S-curve ramps are ideal for conveyors carrying fragile loads, or other applications where a smooth transition is required when changing from one speed to another. The S-curve consists of symmetrical curves at both ends of the ramp and a linear part in between.</p> <p>A rule of thumb A suitable relation between the ramp shape time and the acceleration ramp time is 1/5.</p> 	1 = 0.1 s
2205	ACCELER TIME 2	<p>Defines the acceleration time 2 i.e. the time required for the speed to change from zero to the speed defined by parameter 2008 MAXIMUM FREQ (with scalar control) / 2002 MAXIMUM SPEED (with vector control). The control mode is selected by parameter 9904 MOTOR CTRL MODE.</p> <p>See parameter 2202 ACCELER TIME 1.</p> <p>Acceleration time 2 is used also as jogging acceleration time. See parameter 1010 JOGGING SEL.</p>	60
	0.0...1800.0 s	Time	1 = 0.1 s
2206	DECELER TIME 2	<p>Defines the deceleration time 2 i.e. the time required for the speed to change from the value defined by parameter 2008 MAXIMUM FREQ (with scalar control) / 2002 MAXIMUM SPEED (with vector control) to zero. The control mode is selected by parameter 9904 MOTOR CTRL MODE.</p> <p>See parameter 2203 DECELER TIME 1.</p> <p>Deceleration time 2 is used also as jogging deceleration time. See parameter 1010 JOGGING SEL.</p>	60
	0.0...1800.0 s	Time	1 = 0.1 s
2207	RAMP SHAPE 2	<p>Selects the shape of the acceleration/deceleration ramp 2. The function is deactivated during emergency stop.</p> <p>During jogging, parameter value is set to zero (i.e. linear ramp). See 1010 JOGGING SEL.</p>	0
	0.0...1000.0 s	See parameter 2204 RAMP SHAPE 1.	1 = 0.1 s
2208	EMER DEC TIME	<p>Defines the time within the drive is stopped if an emergency stop is activated. See parameter 2109 EMER STOP SEL.</p>	1
	0.0...1800.0 s	Time	1 = 0.1 s
2209	RAMP INPUT 0	Defines the source for forcing the ramp input to zero.	NOT SEL
	NOT SEL	Not selected	0
	DI1	Digital input DI1.1 = ramp input is forced to zero. Ramp output will ramp to zero according to the used ramp time.	1

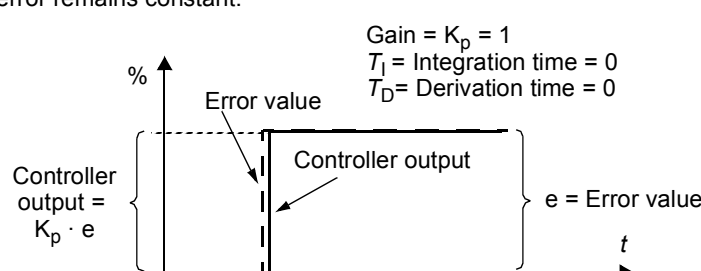
Parameters – complete descriptions			
Index	Name/Selection	Description	Def, FbEq
	DI2	See selection DI1.	2
	DI3	See selection DI1.	3
	DI4	See selection DI1.	4
	DI5	See selection DI1.	5
	COMM	Fieldbus interface as the source for forcing ramp input to zero, i.e. control word 0301 FB CMD WORD 1 bit 13 (with ABB drives profile 5319 EFB PAR 19 bit 6). The control word is sent by the fieldbus controller via the fieldbus adapter or embedded fieldbus (modbus) to the drive. For the control word bits, see sections DCU communication profile on page 262 and ABB Drives communication profile on page 258 .	7
	DI1(INV)	Inverted digital input DI1.0 = ramp input is forced to zero. Ramp output will ramp to zero according to the used ramp time.	-1
	DI2(INV)	See selection DI1(INV).	-2
	DI3(INV)	See selection DI1(INV).	-3
	DI4(INV)	See selection DI1(INV).	-4
	DI5(INV)	See selection DI1(INV).	-5
23 SPEED CONTROL		Speed controller variables. See section Speed controller tuning on page 115 .	
2301	PROP GAIN	<p>Defines a relative gain for the speed controller. Great gain may cause speed oscillation.</p> <p>The figure below shows the speed controller output after an error step when the error remains constant.</p>  <p>Note: For automatic setting of the gain, use autotune run (parameter 2305 AUTOTUNE RUN).</p>	10
	0.00...200.00	Gain	1 = 0.01

Parameters – complete descriptions

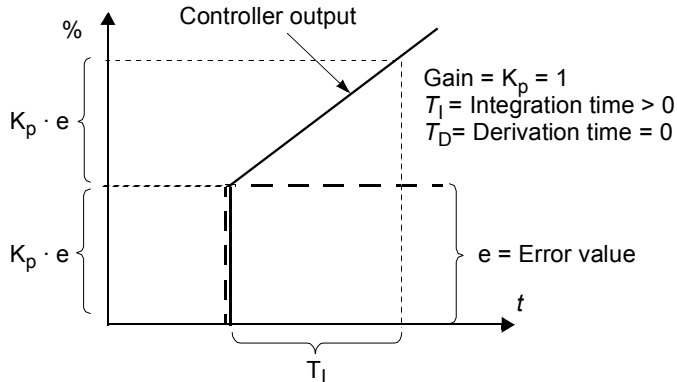
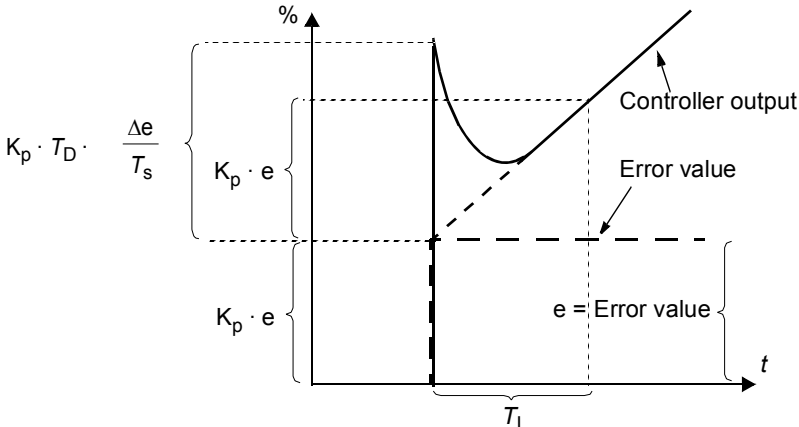
Index	Name/Selection	Description	Def, FbEq
2302	INTEGRATION TIME	<p>Defines an integration time for the speed controller. The integration time defines the rate at which the controller output changes when the error value is constant. The shorter the integration time, the faster the continuous error value is corrected. Too short an integration time makes the control unstable.</p> <p>The figure below shows the speed controller output after an error step when the error remains constant.</p>  <p>Note: For automatic setting of the integration time, use autotune run (parameter 2305 AUTOTUNE RUN).</p>	2.5
	0.00...600.00 s	Time	1 = 0.01 s
2303	DERIVATION TIME	<p>Defines the derivation time for the speed controller. Derivative action boosts the controller output if the error value changes. The longer the derivation time, the more the speed controller output is boosted during the change. If the derivation time is set to zero, the controller works as a PI controller, otherwise as a PID controller.</p> <p>The derivation makes the control more responsive for disturbances.</p> <p>The figure below shows the speed controller output after an error step when the error remains constant.</p>  <p>Gain = $K_p = 1$ T_i = Integration time > 0 T_D = Derivation time > 0 T_s = Sample time period = 2 ms Δe = Error value change between two samples</p>	0
	0....10000 ms	Time	1 = 1 ms



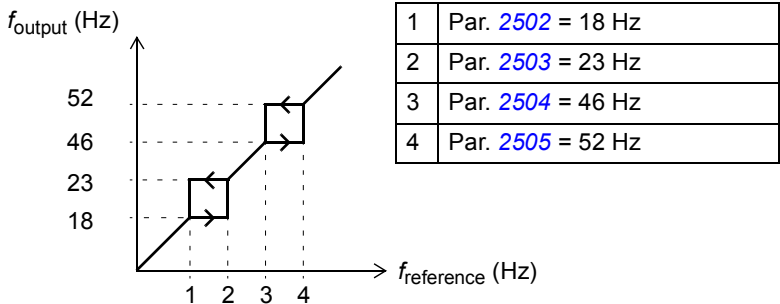

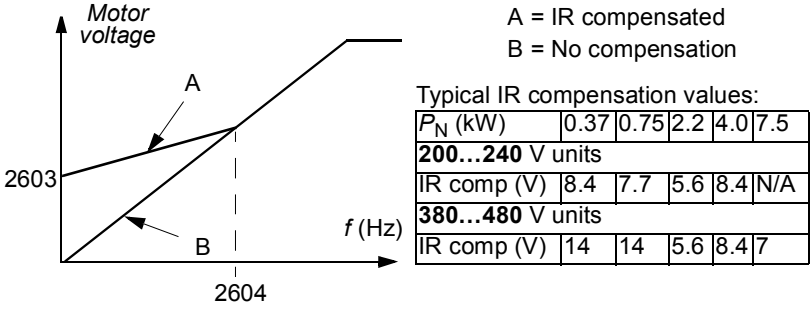
Parameters – complete descriptions			
Index	Name/Selection	Description	Def, FbEq
2304	ACC COMPENSATION	<p>Defines the derivation time for acceleration/(deceleration) compensation. In order to compensate inertia during acceleration a derivative of the reference is added to the output of the speed controller. The principle of a derivative action is described for parameter 2303 DERIVATION TIME.</p> <p>Note: As a general rule, set this parameter to the value between 50 and 100% of the sum of the mechanical time constants of the motor and the driven machine. (The speed controller Autotune Run does this automatically, see parameter 2305 AUTOTUNE RUN.)</p> <p>The figure below shows the speed responses when a high inertia load is accelerated along a ramp.</p> <p>* No acceleration compensation Acceleration compensation</p>	0
	0.00...600.00 s	Time	1 = 0.01 s
2305	AUTOTUNE RUN	<p>Start automatic tuning of the speed controller. Instructions:</p> <ul style="list-style-type: none"> - Run the motor at a constant speed of 20 to 40% of the rated speed. - Change the autotuning parameter 2305 to ON. <p>Note: The motor load must be connected to the motor.</p>	OFF
	OFF	No autotuning	0
	ON	<p>Activates the speed controller autotuning. The drive</p> <ul style="list-style-type: none"> - accelerates the motor. - calculates values for proportional gain, integration time and acceleration compensation (parameter 2301 PROP GAIN, 2302 INTEGRATION TIME and 2304 ACC COMPENSATION values). <p>Setting is automatically reverted to OFF.</p>	1
24 TORQUE CONTROL		Torque control variables	
2401	TORQ RAMP UP	Defines the torque reference ramp up time, i.e the minimum time for the reference to increase from zero to the nominal motor torque.	0
	0.00...120.00 s	Time	1 = 0.01 s
2402	TORQ RAMP DOWN	Defines the torque reference ramp down time, i.e the minimum time for the reference to decrease from the nominal motor torque to zero.	0
	0.00...120.00 s	Time	1 = 0.01 s

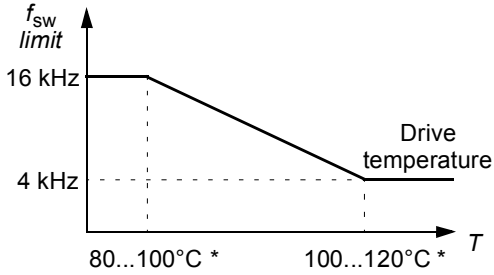
Parameters – complete descriptions											
Index	Name/Selection	Description	Def, FbEq								
25 CRITICAL SPEEDS		Speed bands within which the drive is not allowed to operate.									
2501	CRIT SPEED SEL	<p>Activates/deactivates the critical speeds function. The critical speed function avoids specific speed ranges.</p> <p>Example: A fan has vibrations in the range of 18 to 23 Hz and 46 to 52 Hz. To make the drive to jump over the vibration speed ranges:</p> <ul style="list-style-type: none"> - Activate the critical speeds function. - Set the critical speed ranges as in the figure below.  <table border="1" data-bbox="837 611 1225 772"> <tr> <td>1</td> <td>Par. 2502 = 18 Hz</td> </tr> <tr> <td>2</td> <td>Par. 2503 = 23 Hz</td> </tr> <tr> <td>3</td> <td>Par. 2504 = 46 Hz</td> </tr> <tr> <td>4</td> <td>Par. 2505 = 52 Hz</td> </tr> </table>	1	Par. 2502 = 18 Hz	2	Par. 2503 = 23 Hz	3	Par. 2504 = 46 Hz	4	Par. 2505 = 52 Hz	OFF
1	Par. 2502 = 18 Hz										
2	Par. 2503 = 23 Hz										
3	Par. 2504 = 46 Hz										
4	Par. 2505 = 52 Hz										
	OFF	Inactive	0								
	ON	Active	1								
2502	CRIT SPEED 1 LO	Defines the minimum limit for critical speed/frequency range 1.	0								
	0.0...500.0 Hz / 0...30000 rpm	Limit in rpm. Limit in Hz if parameter 9904 MOTOR CTRL MODE setting is SCALAR:FREQ. The value cannot be above the maximum (parameter 2503 CRIT SPEED 1 HI).	1 = 0.1 Hz / 1 rpm								
2503	CRIT SPEED 1 HI	Defines the maximum limit for critical speed/frequency range 1.	0								
	0.0...500.0 Hz / 0...30000 rpm	Limit in rpm. Limit in Hz if parameter 9904 MOTOR CTRL MODE setting is SCALAR:FREQ. The value cannot be below the minimum (parameter 2502 CRIT SPEED 1 LO).	1 = 0.1 Hz / 1 rpm								
2504	CRIT SPEED 2 LO	See parameter 2502 CRIT SPEED 1 LO.	0								
	0.0...500.0 Hz / 0...30000 rpm	See parameter 2502.	1 = 0.1 Hz / 1 rpm								
2505	CRIT SPEED 2 HI	See parameter 2503 CRIT SPEED 1 HI.	0								
	0.0...500.0 Hz / 0...30000 rpm	See parameter 2503.	1 = 0.1 Hz / 1 rpm								
2506	CRIT SPEED 3 LO	See parameter 2502 CRIT SPEED 1 LO.	0								
	0.0...500.0 Hz / 0...30000 rpm	See parameter 2502.	1 = 0.1 Hz / 1 rpm								
2507	CRIT SPEED 3 HI	See parameter 2503 CRIT SPEED 1 HI.	0								
	0.0...500.0 Hz / 0...30000 rpm	See parameter 2503.	1 = 0.1 Hz / 1 rpm								
26 MOTOR CONTROL		Motor control variables									
2601	FLUX OPT ENABLE	<p>Activates/deactivates the flux optimisation function. Flux optimisation reduces the total energy consumption and motor noise level when the drive operates below the nominal load. The total efficiency (motor and the drive) can be improved by 1% to 10%, depending on the load torque and speed. The disadvantage of this function is that the dynamic performance of the drive is weakened.</p>	OFF								

Parameters – complete descriptions																																	
Index	Name/Selection	Description	Def, FbEq																														
	OFF	Inactive	0																														
	ON	Active	1																														
2602	FLUX BRAKING	Activates/deactivates the Flux Braking function. See section Flux Braking on page 108 .	OFF																														
	OFF	Inactive	0																														
	ON	Active	1																														
2603	IR COMP VOLT	<p>Defines the output voltage boost at zero speed (IR compensation). The function is useful in applications with high break-away torque when vector control cannot be applied. To prevent overheating, set IR compensation voltage as low as possible. The figure below illustrates the IR compensation.</p> <p>Note: The function can be used only when parameter 9904 MOTOR CTRL MODE setting is SCALAR:FREQ.</p>  <p style="text-align: right;">A = IR compensated B = No compensation</p> <p style="text-align: center;">Typical IR compensation values:</p> <table border="1" style="margin-left: auto; margin-right: auto;"> <thead> <tr> <th>P_N (kW)</th> <th>0.37</th> <th>0.75</th> <th>2.2</th> <th>4.0</th> <th>7.5</th> </tr> </thead> <tbody> <tr> <td colspan="6">200...240 V units</td> </tr> <tr> <td>IR comp (V)</td> <td>8.4</td> <td>7.7</td> <td>5.6</td> <td>8.4</td> <td>N/A</td> </tr> <tr> <td colspan="6">380...480 V units</td> </tr> <tr> <td>IR comp (V)</td> <td>14</td> <td>14</td> <td>5.6</td> <td>8.4</td> <td>7</td> </tr> </tbody> </table>	P_N (kW)	0.37	0.75	2.2	4.0	7.5	200...240 V units						IR comp (V)	8.4	7.7	5.6	8.4	N/A	380...480 V units						IR comp (V)	14	14	5.6	8.4	7	Type dependent
P_N (kW)	0.37	0.75	2.2	4.0	7.5																												
200...240 V units																																	
IR comp (V)	8.4	7.7	5.6	8.4	N/A																												
380...480 V units																																	
IR comp (V)	14	14	5.6	8.4	7																												
	0.0...100.0 V	Voltage boost	1 = 0.1 V																														
2604	IR COMP FREQ	<p>Defines the frequency at which the IR compensation is 0 V. See figure in parameter 2603 IR COMP VOLT.</p> <p>Note: If parameter 2605 U/F RATIO is set to USER DEFINED, this parameter is not active. The IR compensation frequency is set by parameter 2610 USER DEFINED U1.</p>	80																														
	0...100%	Value in percent of the motor frequency	1 = 1%																														
2605	U/F RATIO	Selects the voltage to frequency (U/f) ratio below the field weakening point.	LINEAR																														
	LINEAR	Linear ratio for constant torque applications.	1																														
	SQUARED	Squared ratio for centrifugal pump and fan applications. With squared U/f ratio the noise level is lower for most operating frequencies.	2																														
	USER DEFINED	Custom ratio defined by parameters 2610...2618 . See section Custom U/f ratio on page 112 .	3																														
2606	SWITCHING FREQ	Defines the switching frequency of the drive. Higher switching frequency results in lower acoustic noise. See also parameter 2607 SWITC FREQ CTRL and Switching frequency derating on page 291 .	4																														
	4 kHz	Can be used with scalar and vector control. The control mode is selected by parameter 9904 MOTOR CTRL MODE.	1 = 1 kHz																														
	8 kHz	Can be used with scalar and vector control. The control mode is selected by parameter 9904 MOTOR CTRL MODE.																															
	12 kHz	Can be used with scalar and vector control. The control mode is selected by parameter 9904 MOTOR CTRL MODE.																															
	16 kHz	Can be used only with scalar control (i.e. when parameter 9904 MOTOR CTRL MODE setting is SCALAR:FREQ).																															

Parameters – complete descriptions			
Index	Name/Selection	Description	Def, FbEq
2607	SWITCH FREQ CTRL	<p>Activates the switching frequency control. When active, the selection of parameter 2606 SWITCHING FREQ is limited when the drive internal temperature increases. See the figure below. This function allows the highest possible switching frequency at a specific operation point.</p> <p>Higher switching frequency results in lower acoustic noise, but higher internal losses.</p>  <p style="text-align: center;">* Temperature depends on the drive output frequency.</p>	ON
	OFF	Inactive	0
	ON	Active	1
2608	SLIP COMP RATIO	<p>Defines the slip gain for the motor slip compensation control. 100% means full slip compensation, 0% means no slip compensation. Other values can be used if a static speed error is detected despite of the full slip compensation.</p> <p>Can be used only with scalar control (i.e. when parameter 9904 MOTOR CTRL MODE setting is SCALAR:FREQ).</p> <p>Example: 35 Hz constant speed reference is given to the drive. Despite of the full slip compensation (SLIP COMP RATIO = 100%), a manual tachometer measurement from the motor axis gives a speed value of 34 Hz. The static speed error is 35 Hz - 34 Hz = 1 Hz. To compensate the error, the slip gain should be increased.</p>	0
	0...200%	Slip gain	1 = 1%
2609	NOISE SMOOTHING	<p>Enables the noise smoothing function. Noise smoothing distributes the acoustic motor noise over a range of frequencies instead of a single tonal frequency resulting in lower peak noise intensity. A random component with an average of 0 Hz is added to the switching frequency set by parameter 2606 SWITCHING FREQ.</p> <p>Note: Parameter has no effect if parameter 2606 SWITCHING FREQ is set to 16 kHz.</p>	DISABLE
	DISABLE	Disabled	0
	ENABLE	Enabled	1
2610	USER DEFINED U1	Defines the first voltage point of the custom U/f curve at the frequency defined by parameter 2611 USER DEFINED F1. See section Custom U/f ratio on page 112 .	19% of U_N
	0...120% of U_N V	Voltage	1 = 1 V
2611	USER DEFINED F1	Defines the first frequency point of the custom U/f curve.	10
	0.0...500.0 Hz	Frequency	1 = 0.1 Hz
2612	USER DEFINED U2	Defines the second voltage point of the custom U/f curve at the frequency defined by parameter 2613 USER DEFINED F2. See section Custom U/f ratio on page 112 .	38% of U_N
	0...120% of U_N V	Voltage	1 = 1 V

Parameters – complete descriptions			
Index	Name/Selection	Description	Def, FbEq
2613	USER DEFINED F2	Defines the second frequency point of the custom U/f curve.	20
	0.0...500.0 Hz	Frequency	1 = 0.1 Hz
2614	USER DEFINED U3	Defines the third voltage point of the custom U/f curve at the frequency defined by parameter 2615 USER DEFINED F3. See section <i>Custom U/f ratio</i> on page 112.	47.5% of U_N
	0...120% of U_N V	Voltage	1 = 1 V
2615	USER DEFINED F3	Defines the third frequency point of the custom U/f curve.	25
	0.0...500.0 Hz	Frequency	1 = 0.1 Hz
2616	USER DEFINED U4	Defines the fourth voltage point of the custom U/f curve at the frequency defined by parameter 2617 USER DEFINED F4. See section <i>Custom U/f ratio</i> on page 112.	76% of U_N
	0...120% of U_N V	Voltage	1 = 1 V
2617	USER DEFINED F4	Defines the fourth frequency point of the custom U/f curve.	40
	0.0...500.0 Hz	Frequency	1 = 0.1 Hz
2618	FW VOLTAGE	Defines the voltage of the U/f curve when frequency is equal to or exceeds the motor nominal frequency (9907 MOTOR NOM FREQ). See section <i>Custom U/f ratio</i> on page 112.	95% of U_N
	0...120% of U_N V	Voltage	1 = 1 V
29 MAINTENANCE TRIG		Maintenance triggers	
2901	COOLING FAN TRIG	Defines the trigger point for the drive cooling fan run time counter. Value is compared to parameter 2902 COOLING FAN ACT value.	0
	0.0...6553.5 kh	Time. If parameter value is set to zero, the trigger is disabled.	1 = 0.1 kh
2902	COOLING FAN ACT	Defines the actual value for the cooling fan run time counter. When parameter 2901 COOLING FAN TRIG has been set to a non zero value, the counter starts. When the actual value of the counter exceeds the value defined by parameter 2901, a maintenance notice is displayed on the panel.	0
	0.0...6553.5 kh	Time. Parameter is reset by setting it to zero.	1 = 0.1 kh
2903	REVOLUTION TRIG	Defines the trigger point for the motor revolution counter. Value is compared to parameter 2904 REVOLUTION ACT value.	0
	0...65535 Mrev	Millions of revolutions. If parameter value is set to zero, the trigger is disabled.	1 = 1 Mrev
2904	REVOLUTION ACT	Defines the actual value for the motor revolution counter. When parameter 2903 REVOLUTION TRIG has been set to a non zero value, the counter starts. When the actual value of the counter exceeds the value defined by parameter 2903, a maintenance notice is displayed on the panel.	0
	0...65535 Mrev	Millions of revolutions. Parameter is reset by setting it to zero.	1 = 1 Mrev
2905	RUN TIME TRIG	Defines the trigger point for the drive run time counter. Value is compared to parameter 2906 RUN TIME ACT value.	0
	0.0...6553.5 kh	Time. If parameter value is set to zero, the trigger is disabled.	1 = 0.1 kh
2906	RUN TIME ACT	Defines the actual value for the drive run time counter. When parameter 2905 RUN TIME TRIG has been set to a non zero value, the counter starts. When the actual value of the counter exceeds the value defined by parameter 2905, a maintenance notice is displayed on the panel.	0
	0.0...6553.5 kh	Time. Parameter is reset by setting it to zero.	1 = 0.1 kh

Parameters – complete descriptions			
Index	Name/Selection	Description	Def, FbEq
2907	USER MWh TRIG	Defines the trigger point for the drive power consumption counter. Value is compared to parameter 2908 USER MWh ACT value.	0
	0.0...6553.5 MWh	Megawatt hours. If parameter value is set to zero, the trigger is disabled.	1 = 0.1 MWh
2908	USER MWh ACT	Defines the actual value of the drive power consumption counter. When parameter 2907 USER MWh TRIG has been set to a non zero value, the counter starts. When the actual value of the counter exceeds the value defined by parameter 2907 , a maintenance notice is displayed on the panel.	0
	0.0...6553.5 MWh	Megawatt hours. Parameter is reset by setting it to zero.	1 = 0.1 MWh
30 FAULT FUNCTIONS		Programmable protection functions	
3001	AI<MIN FUNCTION	Selects how the drive reacts when an analog input signal falls below the set minimum limit.	NOT SEL
	NOT SEL	Protection is inactive.	0
	FAULT	The drive trips on fault AI1/AI2 LOSS and the motor coasts to stop. Fault limit is defined by parameter 3021/3022 AI1/AI2 FAULT LIMIT.	1
	CONST SP 7	The drive generates alarm AI1/AI2 LOSS and sets the speed to the value defined by parameter 1208 CONST SPEED 7. Alarm limit is defined by parameter 3021/3022 AI1/AI2 FAULT LIMIT.  WARNING! Make sure that it is safe to continue operation in case the analog input signal is lost.	2
	LAST SPEED	The drive generates alarm AI1/AI2 LOSS and freezes the speed to the level the drive was operating at. The speed is determined by the average speed over the previous 10 seconds. Alarm limit is defined by parameter 3021/3022 AI1/AI2 FAULT LIMIT.  WARNING! Make sure that it is safe to continue operation in case the analog input signal is lost.	3
3002	PANEL COMM ERR	Selects how the drive reacts to a control panel communication break.	FAULT
	FAULT	Drive trips on fault PANEL LOSS and the motor coasts to stop.	1
	CONST SP 7	The drive generates alarm PANEL LOSS and sets the speed to the speed defined by parameter 1208 CONST SPEED 7.  WARNING! Make sure that it is safe to continue operation in case of a panel communication break.	2
	LAST SPEED	The drive generates alarm PANEL LOSS and freezes the speed to the level the drive was operating at. The speed is determined by the average speed over the previous 10 seconds.  WARNING! Make sure that it is safe to continue operation in case of a panel communication break.	3
3003	EXTERNAL FAULT 1	Selects an interface for an external fault 1 signal.	NOT SEL
	NOT SEL	Not selected	0
	DI1	External fault indication through digital input DI1. 1: Fault trip (EXT FAULT 1). Motor coasts to stop. 0: No external fault.	1
	DI2	See selection DI1.	2
	DI3	See selection DI1.	3
	DI4	See selection DI1.	4

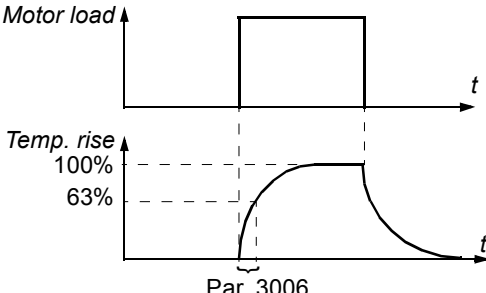
Parameters – complete descriptions			
Index	Name/Selection	Description	Def, FbEq
	DI5	See selection DI1.	5
	DI1(INV)	External fault indication through inverted digital input DI1. 0: Fault trip (EXT FAULT 1). Motor coasts to stop. 1: No external fault.	-1
	DI2(INV)	See selection DI1(INV).	-2
	DI3(INV)	See selection DI1(INV).	-3
	DI4(INV)	See selection DI1(INV).	-4
	DI5(INV)	See selection DI1(INV).	-5
3004	EXTERNAL FAULT 2	Selects an interface for an external fault 2 signal.	NOT SEL
		See parameter 3003 EXTERNAL FAULT 1.	
3005	MOT THERM PROT	Selects how the drive reacts when the motor overtemperature is detected.	FAULT
	NOT SEL	Protection is inactive.	0
	FAULT	The drive trips on fault MOT OVERTEMP when the temperature exceeds 110°C, and the motor coasts to a stop.	1
	ALARM	The drive generates alarm MOTOR TEMP when the motor temperature exceeds 90°C.	2
3006	MOT THERM TIME	<p>Defines the thermal time constant for the motor thermal model, i.e. the time within the motor temperature has reached 63% of the nominal temperature with steady load.</p> <p>For thermal protection according to UL requirements for NEMA class motors, use the rule of thumb: Motor thermal time = 35 · t₆. t₆ (in seconds) is specified by the motor manufacturer as the time the motor can safely operate at six times its rated current.</p> <p>Thermal time for a Class 10 trip curve is 350 s, for a Class 20 trip curve 700 s, and for a Class 30 trip curve 1050 s.</p> 	500
	256...9999 s	Time constant	1 = 1 s

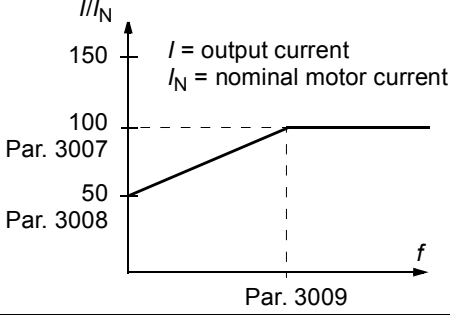
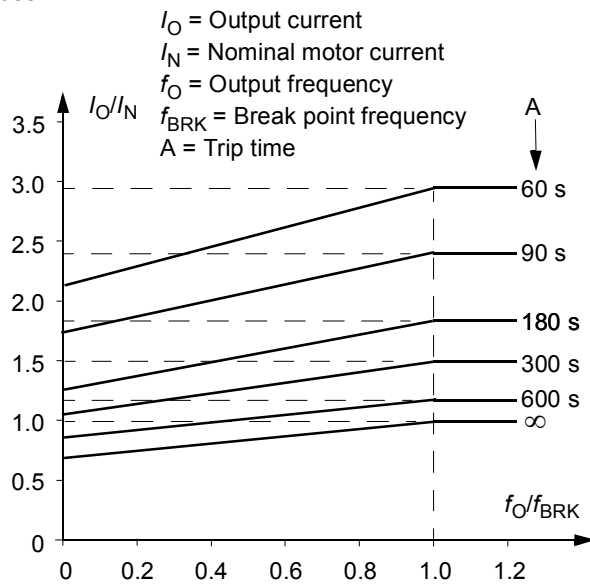
Parameters – complete descriptions			
Index	Name/Selection	Description	Def, FbEq
3007	MOT LOAD CURVE	<p>Defines the load curve together with parameters 3008 ZERO SPEED LOAD and 3009 BREAK POINT FREQ. If value is set to 100%, the maximum allowed load is equal to parameter 9906 MOTOR NOM CURR value.</p> <p>Load curve should be adjusted, if the ambient temperature differs from nominal temperature.</p> 	100
	50....150%	Allowed continuous motor load in percent of the nominal motor current	1 = 1%
3008	ZERO SPEED LOAD	Defines the load curve together with parameters 3007 MOT LOAD CURVE and 3009 BREAK POINT FREQ.	70
	25....150%	Allowed continuous motor load at zero speed in percent of the nominal motor current	1 = 1%
3009	BREAK POINT FREQ	<p>Defines the load curve together with parameters 3007 MOT LOAD CURVE and 3008 ZERO SPEED LOAD.</p> <p>Example: Thermal protection trip times when parameters 3006...3008 have default values.</p> 	35
	1...250 Hz	Drive output frequency at 100% load	1 = 1 Hz

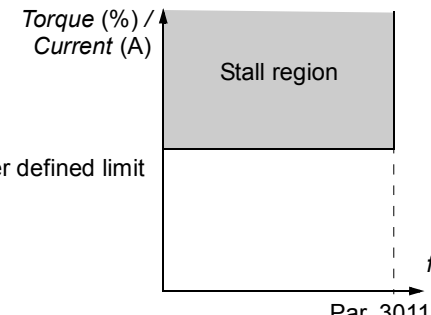
Parameters – complete descriptions			
Index	Name/Selection	Description	Def, FbEq
3010	STALL FUNCTION	<p>Selects how the drive reacts to a motor stall condition. The protection wakes up if the drive has operated in a stall region (see figure below) longer than the time set by parameter 3012 STALL TIME.</p> <p>With vector control user defined limit = 2017 MAX TORQUE 1 / 2018 MAX TORQUE 2 / (applies for positive and negative torques) $0.95 \cdot \text{user defined limit}$</p> <p>With scalar control user defined limit = 2003 MAX CURRENT</p> <p>The control mode is selected by parameter 9904 MOTOR CTRL MODE.</p> 	NOT SEL
	NOT SEL	Protection is inactive.	0
	FAULT	The drive trips on fault MOTOR STALL and the motor coast to a stop.	1
	ALARM	The drive generates alarm MOTOR STALL.	2
3011	STALL FREQUENCY	Defines the frequency limit for the stall function. See parameter 3010 STALL FUNCTION.	20
	0.5...50.0 Hz	Frequency	1 = 0.1 Hz
3012	STALL TIME	Defines the time for the stall function. See parameter 3010 STALL FUNCTION.	20
	10...400 s	Time	1 = 1 s
3013	UNDERLOAD FUNC	<p>Selects how the drive reacts to underload. The protection wakes up if:</p> <ul style="list-style-type: none"> - the motor torque falls below the curve selected by parameter 3015 UNDERLOAD CURVE, - output frequency is higher than 10% of the nominal motor frequency and - the above conditions have been valid longer than the time set by parameter 3014 UNDERLOAD TIME. 	NOT SEL
	NOT SEL	Protection is inactive.	0
	FAULT	<p>The drive trips on fault UNDERLOAD and the motor coasts to a stop.</p> <p>Note: Set parameter value to FAULT only after the drive ID run is performed! If FAULT is selected, the drive may generate an UNDERLOAD fault during ID run.</p>	1
	ALARM	The drive generates alarm UNDERLOAD.	2
3014	UNDERLOAD TIME	Defines the time limit for the underload function. See parameter 3013 UNDERLOAD FUNC.	20
	10...400 s	Time limit	1 = 1 s

Parameters – complete descriptions			
Index	Name/Selection	Description	Def, FbEq
3015	UNDERLOAD CURVE	<p>Selects the load curve for the underload function. See parameter 3013 UNDERLOAD FUNC.</p> <p>T_M = nominal torque of the motor f_N = nominal frequency of the motor (9907)</p> <p>Underload curve types</p>	1
	1...5	Number of the load curve	1 = 1
3016	SUPPLY PHASE	Selects how the drive reacts to supply phase loss, i.e. when DC voltage ripple is excessive.	FAULT
	FAULT	The drive trips on fault SUPPLY PHASE and the motor coasts to a stop when the DC voltage ripple exceeds 14% of the nominal DC voltage.	0
	LIMIT/ALARM	Drive output current is limited and alarm INPUT PHASE LOSS is generated when the DC voltage ripple exceeds 14% of the nominal DC voltage. There is a 10 s delay between the activation of the alarm and the output current limitation. The current is limited until the ripple drops under the minimum limit, $0.3 \cdot I_{hd}$.	1
	ALARM	The drive generates alarm INPUT PHASE LOSS when the DC ripple exceeds 14% of the nominal DC voltage.	2
3017	EARTH FAULT	Selects how the drive reacts when an earth (ground) fault is detected in the motor or the motor cable. Note: Changing this parameter setting is not recommended.	ENABLE
	DISABLE	No action	0
	ENABLE	The drive trips on fault EARTH FAULT.	1
3018	COMM FAULT FUNC	Selects how the drive reacts in a fieldbus communication break. The time delay is defined by parameter 3019 COMM FAULT TIME.	NOT SEL
	NOT SEL	Protection is inactive.	0
	FAULT	Protection is active. The drive trips on fault SERIAL 1 ERR and coasts to stops.	1
	CONST SP 7	Protection is active. The drive generates alarm IO COMM and sets the speed to the value defined by parameter 1208 CONST SPEED 7. WARNING! Make sure that it is safe to continue operation in case of a communication break.	2

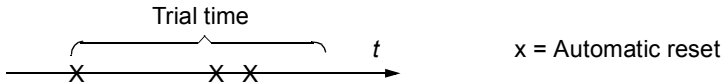
Parameters – complete descriptions			
Index	Name/Selection	Description	Def, FbEq
	LAST SPEED	Protection is active. The drive generates alarm IO COMM and freezes the speed to the level the drive was operating at. The speed is determined by the average speed over the previous 10 seconds.  WARNING! Make sure that it is safe to continue operation in case of a communication break.	3
3019	COMM FAULT TIME	Defines the time delay for the fieldbus communication break supervision. See parameter 3018 COMM FAULT FUNC.	3
	0.0...60.0 s	Delay time	1 = 0.1 s
3021	AI1 FAULT LIMIT	Defines a fault level for analog input AI1. If parameter 3001 AI<MIN FUNCTION is set to FAULT, the drive trips on fault AI1 LOSS, when the analog input signal falls below the set level. Do not set this limit below the level defined by parameter 1301 MINIMUM AI1.	0
	0.0...100.0%	Value in percent of the full signal range	1 = 0.1%
3022	AI2 FAULT LIMIT	Defines a fault level for analog input AI2. If parameter 3001 AI<MIN FUNCTION is set to FAULT, the drive trips on fault AI2 LOSS, when the analog input signal falls below the set level. Do not set this limit below the level defined by parameter 1304 MINIMUM AI2.	0
	0.0...100.0%	Value in percent of the full signal range	1 = 0.1%
3023	WIRING FAULT	Selects how the drive reacts when incorrect input power and motor cable connection is detected (i.e. the input power cable is connected to the motor connection of the drive). Note: Changing this parameter setting is not recommended in normal use. The protection is to be disabled only with corner-grounded delta power systems and very long cables.	ENABLE
	DISABLE	No action	0
	ENABLE	The drive trips on fault OUPW WIRING.	1
31 AUTOMATIC RESET		Automatic fault reset. Automatic resets are possible only for certain fault types and when the automatic reset function is activated for that fault type.	
3101	NR OF TRIALS	Defines the number of automatic fault resets the drive performs within the time defined by parameter 3102 TRIAL TIME. If the number of automatic resets exceeds the set number (within the trial time), the drive prevents additional automatic resets and remains stopped. The drive must be reset from control panel or from a source selected by parameter 1604 FAULT RESET SEL. Example: Three faults have occurred during the trial time defined by parameter 3102 . Last fault is reset only if the number defined by parameter 3101 is 3 or more. 	0
	0...5	Number of the automatic resets	1 = 1
3102	TRIAL TIME	Defines the time for the automatic fault reset function. See parameter 3101 NR OF TRIALS.	30
	1.0...600.0 s	Time	1 = 0.1 s

Parameters – complete descriptions			
Index	Name/Selection	Description	Def, FbEq
3103	DELAY TIME	Defines the time that the drive will wait after a fault before attempting an automatic reset. See parameter 3101 NR OF TRIALS. If delay time is set to zero, the drive resets immediately.	0
	0.0...120.0 s	Time	1 = 0.1 s
3104	AR OVERCURRENT	Activates/deactivates the automatic reset for the overcurrent fault. Automatically resets the fault (OVERCURRENT) after the delay set by par. 3103 DELAY TIME.	DISABLE
	DISABLE	Inactive	0
	ENABLE	Active	1
3105	AR OVERVOLTAGE	Activates/deactivates the automatic reset for the intermediate link overvoltage fault. Automatically resets the fault (DC OVERVOLT) after the delay set by par. 3103 DELAY TIME.	DISABLE
	DISABLE	Inactive	0
	ENABLE	Active	1
3106	AR UNDERVOLTAGE	Activates/deactivates the automatic reset for the intermediate link undervoltage fault. Automatically resets the fault (DC UNDERVOLTAGE) after the delay set by par. 3103 DELAY TIME.	DISABLE
	DISABLE	Inactive	0
	ENABLE	Active	1
3107	AR AI<MIN	Activates/deactivates the automatic reset for fault AI<MIN (analog input signal under the allowed minimum level). Automatically resets the fault after the delay set by par. 3103 DELAY TIME.	DISABLE
	DISABLE	Inactive	0
	ENABLE	Active  WARNING! The drive may restart even after a long stop if the analog input signal is restored. Ensure that the use of this feature will not cause danger.	1
3108	AR EXTERNAL FLT	Activates/deactivates the automatic reset for the EXTERNAL FAULT 1/2. Automatically resets the fault after the delay set by par. 3103 DELAY TIME.	DISABLE
	DISABLE	Inactive	0
	ENABLE	Active	1

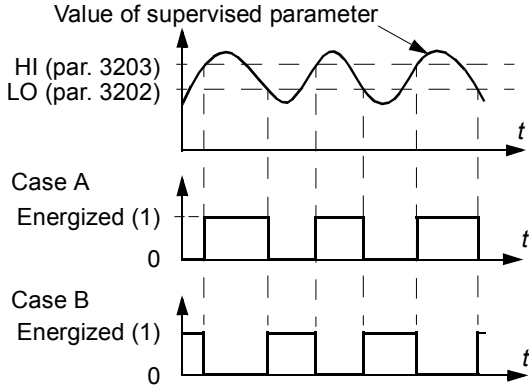
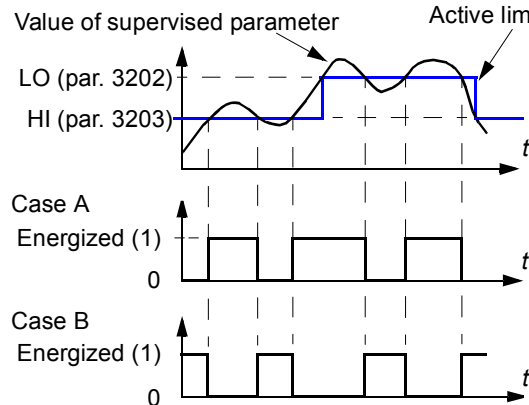
Parameters – complete descriptions			Def, FbEq
Index	Name/Selection	Description	
32 SUPERVISION		Signal supervision. Supervision status can be monitored with relay or transistor output. See parameter groups 14 RELAY OUTPUTS and 18 FREQ IN & TRAN OUT .	
3201	SUPERV 1 PARAM	<p>Selects the first supervised signal. Supervision limits are defined by parameters 3202 SUPERV 1 LIM LO and 3203 SUPERV 1 LIM HI.</p> <p>Example 1: If 3202 SUPERV 1 LIM LO ≤ 3203 SUPERV 1 LIM HI</p> <p>Case A = 1401 RELAY OUTPUT 1 value is set to SUPRV1 OVER. Relay energises when value of the signal selected with 3201 SUPERV 1 PARAM exceeds the supervision limit defined by 3203 SUPERV 1 LIM HI. The relay remains active until the supervised value drops below the low limit defined by 3202 SUPERV 1 LIM LO.</p> <p>Case B = 1401 RELAY OUTPUT 1 value is set to SUPRV1 UNDER. Relay energises when value of the signal selected with 3201 SUPERV 1 PARAM drops below the supervision limit defined by 3202 SUPERV 1 LIM LO. The relay remains active until the supervised value rises above the high limit defined by 3203 SUPERV 1 LIM HI.</p>  <p>Example 2: If 3202 SUPERV 1 LIM LO > 3203 SUPERV 1 LIM HI</p> <p>The lower limit 3203 SUPERV 1 LIM HI remains active until the supervised signal exceeds the higher limit 3202 SUPERV 1 LIM LO, making it the active limit. The new limit remains active until the supervised signal drops below the lower limit 3203 SUPERV 1 LIM HI, making it the active limit.</p> <p>Case A = 1401 RELAY OUTPUT 1 value is set to SUPRV1 OVER. Relay is energized whenever the supervised signal exceeds the active limit.</p> <p>Case B = 1401 RELAY OUTPUT 1 value is set to SUPRV1 UNDER. Relay is de-energized whenever the supervised signal drops below the active limit.</p> 	103

Parameters – complete descriptions			
Index	Name/Selection	Description	Def, FbEq
	0, x...x	Parameter index in group <i>01 OPERATING DATA</i> . E.g. 102 = <i>0102</i> SPEED. 0 = not selected.	1 = 1
3202	SUPERV 1 LIM LO	Defines the low limit for the first supervised signal selected by parameter <i>3201</i> SUPERV 1 PARAM. Supervision wakes up if the value is below the limit.	-
	x...x	Setting range depends on parameter <i>3201</i> setting.	-
3203	SUPERV 1 LIM HI	Defines the high limit for the first supervised signal selected by parameter <i>3201</i> SUPERV 1 PARAM. Supervision wakes up if the value is above the limit.	-
	x...x	Setting range depends on parameter <i>3201</i> setting.	-
3204	SUPERV 2 PARAM	Selects the second supervised signal. Supervision limits are defined by parameters <i>3205</i> SUPERV 2 LIM LO and <i>3206</i> SUPERV 2 LIM HI. See parameter <i>3201</i> SUPERV 1 PARAM.	104
	x...x	Parameter index in group <i>01 OPERATING DATA</i> . E.g. 102 = <i>0102</i> SPEED	1 = 1
3205	SUPERV 2 LIM LO	Defines the low limit for the second supervised signal selected by parameter <i>3204</i> SUPERV 2 PARAM. Supervision wakes up if the value is below the limit.	-
	x...x	Setting range depends on parameter <i>3204</i> setting.	-
3206	SUPERV 2 LIM HI	Defines the high limit for the second supervised signal selected by parameter <i>3204</i> SUPERV 2 PARAM. Supervision wakes up if the value is above the limit.	-
	x...x	Setting range depends on parameter <i>3204</i> setting.	-
3207	SUPERV 3 PARAM	Selects the third supervised signal. Supervision limits are defined by parameters <i>3208</i> SUPERV 3 LIM LO and <i>3209</i> SUPERV 3 LIM HI. See parameter <i>3201</i> SUPERV 1 PARAM.	105
	x...x	Parameter index in group <i>01 OPERATING DATA</i> . E.g. 102 = <i>0102</i> SPEED	1 = 1
3208	SUPERV 3 LIM LO	Defines the low limit for the third supervised signal selected by parameter <i>3207</i> SUPERV 3 PARAM. Supervision wakes up if the value is below the limit.	-
	x...x	Setting range depends on parameter <i>3207</i> setting.	-
3209	SUPERV 3 LIM HI	Defines the high limit for the third supervised signal selected by parameter <i>3207</i> SUPERV 3 PARAM. Supervision wakes up if the value is above the limit.	-
	x...x	Setting range depends on parameter <i>3207</i> setting.	-
33 INFORMATION		Firmware package version, test date etc.	
3301	FIRMWARE	Displays the version of the firmware package.	
	0.0000...FFFF (hex)	E.g. 241A	
3302	LOADING PACKAGE	Displays the version of the loading package.	type dependent
	0x2001...0x20FF (hex)	0x2001 = ACS350-0x (Eur GMD)	
3303	TEST DATE	Displays the test date.	00.00
		Date value in format YY.WW (year, week)	

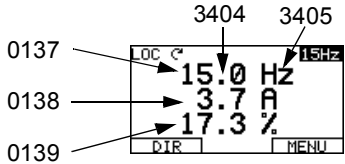
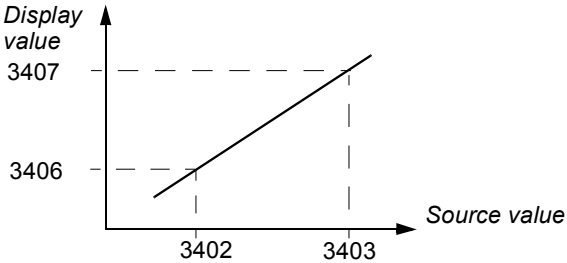
Parameters – complete descriptions			
Index	Name/Selection	Description	Def, FbEq
3304	DRIVE RATING	Displays the drive current and voltage ratings.	0x0000
	0x0000...0xFFFF (hex)	Value in format XXXY: XXX = Nominal current of the drive in Amperes. An “A” indicates decimal point. For example if XXX is 8A8, nominal current is 8.8 A. Y = Nominal voltage of the drive: 1 = 1-phase 200...240 V 2 = 3-phase 200...240 V 4 = 3-phase 380...480 V	
3305	PARAMETER TABLE	Displays the version of the parameter table used in the drive.	
34 PANEL DISPLAY			
Selection of actual signals to be displayed on the panel			
3401	SIGNAL1 PARAM	Selects the first signal to be displayed on the control panel in display mode.	103
		 <p>Assistant panel</p>	
	0, 101...172	Parameter index in group 01 OPERATING DATA . E.g. 102 = 0102 SPEED . If value is set to 0, no signal is selected.	1 = 1
3402	SIGNAL1 MIN	Defines the minimum value for the signal selected by parameter 3401 SIGNAL1 PARAM.	-
		 <p>Note: Parameter is not effective if parameter 3404 OUTPUT1 DSP FORM setting is DIRECT.</p>	
	x...x	Setting range depends on parameter 3401 setting.	-
3403	SIGNAL1 MAX	Defines the maximum value for the signal selected by parameter 3401 SIGNAL1 PARAM. See figure in parameter 3402 SIGNAL1 MIN.	-
	x...x	Setting range depends on parameter 3401 setting.	-

Parameters – complete descriptions																										
Index	Name/Selection	Description	Def, FbEq																							
3404	OUTPUT1 DSP FORM	Defines the format for the displayed signal (selected by par. 3401 SIGNAL1 PARAM).	DIRECT																							
	+/-0	Signed/Unsigned value. Unit is selected by parameter 3405 OUTPUT 1 UNIT. Example PI (3.14159): <table border="1" data-bbox="443 517 1241 792"> <thead> <tr> <th>3404 value</th> <th>Display</th> <th>Range</th> </tr> </thead> <tbody> <tr> <td>+/-0</td> <td>± 3</td> <td rowspan="5">-32768...+32767</td> </tr> <tr> <td>+/-0.0</td> <td>± 3.1</td> </tr> <tr> <td>+/-0.00</td> <td>± 3.14</td> </tr> <tr> <td>+/-0.000</td> <td>± 3.142</td> </tr> <tr> <td>+0</td> <td>3</td> </tr> <tr> <td>+0.0</td> <td>3.1</td> <td rowspan="4">0...65535</td> </tr> <tr> <td>+0.00</td> <td>3.14</td> </tr> <tr> <td>+0.000</td> <td>3.142</td> </tr> <tr> <td></td> <td></td> </tr> </tbody> </table>	3404 value	Display	Range	+/-0	± 3	-32768...+32767	+/-0.0	± 3.1	+/-0.00	± 3.14	+/-0.000	± 3.142	+0	3	+0.0	3.1	0...65535	+0.00	3.14	+0.000	3.142			0
3404 value	Display		Range																							
+/-0	± 3		-32768...+32767																							
+/-0.0	± 3.1																									
+/-0.00	± 3.14																									
+/-0.000	± 3.142																									
+0	3																									
+0.0	3.1		0...65535																							
+0.00	3.14																									
+0.000	3.142																									
	+/-0.0	1																								
	+/-0.00	2																								
	+/-0.000	3																								
	+0	4																								
	+0.0	5																								
	+0.00	6																								
	+0.000	7																								
	BAR METER	Bar graph	8																							
	DIRECT	Direct value. Decimal point location and units of measure are identical to the source signal. Note: Parameters 3402 , 3403 and 3405...3407 are not effective.	9																							
3405	OUTPUT1 UNIT	Selects the unit for the for the displayed signal selected by parameter 3401 SIGNAL1 PARAM. Note: Parameter is not effective if parameter 3404 OUTPUT1 DSP FORM setting is DIRECT. Note: Unit selection does not convert values.	Hz																							
	NO UNIT	No unit selected	0																							
	A	ampere	1																							
	V	volt	2																							
	Hz	hertz	3																							
	%	percent	4																							
	s	second	5																							
	h	hour	6																							
	rpm	revolutions per minute	7																							
	kh	kilohour	8																							
	°C	celsius	9																							
	lb ft	pounds per foot	10																							
	mA	milliampere	11																							
	mV	millivolt	12																							
	kW	kilowatt	13																							
	W	watt	14																							
	kWh	kilowatt hour	15																							
	°F	fahrenheit	16																							
	hp	horsepower	17																							
	MWh	megawatt hour	18																							
	m/s	meters per second	19																							
	m ³ /h	cubic metres per hour	20																							

Parameters – complete descriptions			
Index	Name/Selection	Description	Def, FbEq
	dm ³ /s	cubic decimetres per second	21
	bar	bar	22
	kPa	kilopascal	23
	GPM	gallons per minute	24
	PSI	pounds per square inch	25
	CFM	cubic feet per minute	26
	ft	foot	27
	MGD	millions of gallons per day	28
	inHg	inches of mercury	29
	FPM	feet per minute	30
	kb/s	kilobytes per second	31
	kHz	kilohertz	32
	ohm	ohm	33
	ppm	pulses per minute	34
	pps	pulses per second	35
	l/s	litres per second	36
	l/min	litres per minute	37
	l/h	litres per hour	38
	m ³ /s	cubic metres per second	39
	m ³ /m	cubic meters per minute	40
	kg/s	kilograms per second	41
	kg/m	kilograms per minute	42
	kg/h	kilograms per hour	43
	mbar	millibar	44
	Pa	pascal	45
	GPS	gallons per second	46
	gal/s	gallons per second	47
	gal/m	gallons per minute	48
	gal/h	gallons per hour	49
	ft ³ /s	cubic feet per second	50
	ft ³ /m	cubic feet per minute	51
	ft ³ /h	cubic feet per hour	52
	lb/s	pounds per second	53
	lb/m	pounds per minute	54
	lb/h	pounds per hour	55
	FPS	feet per second	56
	ft/s	feet per second	57
	inH ₂ O	inches of water	58
	in wg	inches of water gauge	59
	ft wg	feet on water gauge	60
	lbsi	pounds per squared inch	61

Parameters – complete descriptions			
Index	Name/Selection	Description	Def, FbEq
	ms	millisecond	62
	Mrev	millions of revolutions	63
	d	days	64
	inWC	inches of water column	65
	m/min	meters per minute	66
	N·m	Newton meter	67
	%ref	reference in percentage	117
	%act	actual value in percentage	118
	%dev	deviation in percentage	119
	% LD	load in percentage	120
	% SP	set point in percentage	121
	%FBK	feedback in percentage	122
	Iout	output current (in percentage)	123
	Vout	output voltage	124
	Fout	output frequency	125
	Tout	output torque	126
	Vdc	DC voltage	127
3406	OUTPUT1 MIN	Sets the minimum display value for the signal selected by parameter 3401 SIGNAL1 PARAM. See par. 3402 SIGNAL1 MIN. Note: Parameter is not effective if parameter 3404 OUTPUT1 DSP FORM setting is DIRECT.	-
	x...x	Setting range depends on parameter 3401 setting.	-
3407	OUTPUT1 MAX	Sets the maximum display value for the signal selected by parameter 3401 SIGNAL1 PARAM. See par. 3402 SIGNAL1 MIN. Note: Parameter is not effective if parameter 3404 OUTPUT1 DSP FORM setting is DIRECT.	-
	x...x	Setting range depends on parameter 3401 setting.	-
3408	SIGNAL2 PARAM	Selects the second signal to be displayed on the control panel in display mode. See par. 3401 SIGNAL1 PARAM.	104
	0, 101...172	Parameter index in group 01 OPERATING DATA . E.g. 102 = 0102 SPEED. If value is set to 0, no signal is selected.	1 = 1
3409	SIGNAL2 MIN	Defines the minimum value for the signal selected by parameter 3408 SIGNAL2 PARAM. See par. 3402 SIGNAL1 MIN.	-
	x...x	Setting range depends on parameter 3408 setting.	-
3410	SIGNAL2 MAX	Defines the maximum value for the signal selected by parameter 3408 SIGNAL2 PARAM. See par 3402 SIGNAL1 MIN.	-
	x...x	Setting range depends on parameter 3408 setting.	-
3411	OUTPUT2 DSP FORM	Defines the format for the displayed signal selected by par. 3408 SIGNAL2 PARAM.	DIRECT
		See parameter 3404 OUTPUT1 DSP FORM.	-
3412	OUTPUT2 UNIT	Selects the unit for the for the displayed signal selected by parameter 3408 SIGNAL2 PARAM.	-
		See parameter 3405 OUTPUT1 UNIT.	-

Parameters – complete descriptions			
Index	Name/Selection	Description	Def, FbEq
3413	OUTPUT2 MIN	Sets the minimum display value for the signal selected by parameter 3408 SIGNAL2 PARAM. See par. 3402 SIGNAL1 MIN.	-
	x...x	Setting range depends on parameter 3408 setting.	-
3414	OUTPUT2 MAX	Sets the maximum display value for the signal selected by parameter 3408 SIGNAL2 PARAM. See par. 3402 SIGNAL1 MIN.	-
	x...x	Setting range depends on parameter 3408 setting.	-
3415	SIGNAL3 PARAM	Selects the third signal to be displayed on the control panel in display mode. See par 3401 SIGNAL1 PARAM.	105
	0, 101...172	Parameter index in group 01 OPERATING DATA . E.g. 102 = 0102 SPEED. If value is set to 0, no signal is selected.	1 = 1
3416	SIGNAL3 MIN	Defines the minimum value for the signal selected by parameter 3415 . See par. 3402 SIGNAL1 MIN.	-
	x...x	Setting range depends on parameter 3415 SIGNAL 3 PARAM setting.	-
3417	SIGNAL3 MAX	Defines the maximum value for the signal selected by parameter 3415 SIGNAL3 PARAM. See par. 3402 SIGNAL1 MIN.	-
	x...x	Setting range depends on parameter 3415 SIGNAL3 PARAM setting.	-
3418	OUTPUT3 DSP FORM	Defines the format for the displayed signal selected by par. 3415 SIGNAL3 PARAM.	DIRECT
		See parameter 3404 OUTPUT1 DSP FORM.	-
3419	OUTPUT3 UNIT	Selects the unit for the for the displayed signal selected by parameter 3415 SIGNAL3 PARAM.	-
		See parameter 3405 OUTPUT1 UNIT.	-
3420	OUTPUT3 MIN	Sets the minimum display value for the signal selected by parameter 3415 SIGNAL3 PARAM. See par. 3402 SIGNAL1 MIN.	-
	x...x	Setting range depends on parameter 3415 SIGNAL3 PARAM setting.	-
3421	OUTPUT3 MAX	Sets the maximum display value for the signal selected by parameter 3415 SIGNAL3 PARAM. See par. 3402 SIGNAL1 MIN.	-
	x...x	Setting range depends on parameter 3415 setting.	-
35 MOTOR TEMP MEAS		Motor temperature measurement. See section Motor temperature measurement through the standard I/O on page 124 .	
3501	SENSOR TYPE	Activates the motor temperature measurement function and selects the sensor type. See also parameter group 15 ANALOGUE OUTPUTS .	NONE
	NONE	The function is inactive.	0
	1 x PT100	The function is active. The temperature is measured with one Pt 100 sensor. Analog output AO feeds constant current through the sensor. The sensor resistance increases as the motor temperature rises, as does the voltage over the sensor. The temperature measurement function reads the voltage through analog input AI1/2 and converts it to degrees centigrade.	1
	2 x PT100	The function is active. Temperature is measured using two Pt 100 sensors. See selection 1 x PT100.	2
	3 x PT100	The function is active. Temperature is measured using three Pt 100 sensors. See selection 1 x PT100.	3

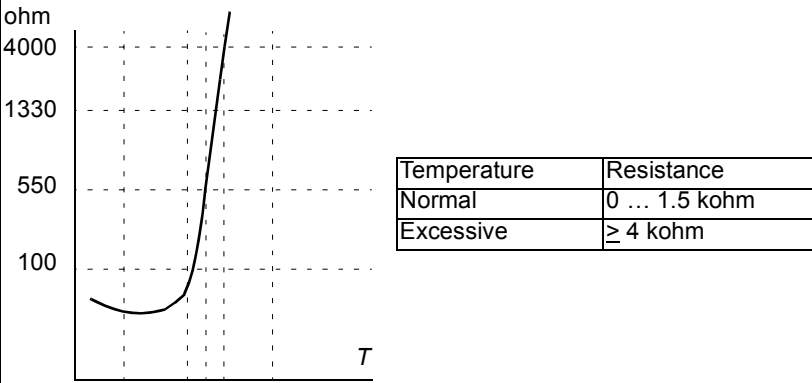
Parameters – complete descriptions									
Index	Name/Selection	Description	Def, FbEq						
	PTC	<p>The function is active. The temperature is supervised using PTC sensor. Analog output AO feeds constant current through the sensor. The resistance of the sensor increases sharply as the motor temperature rises over the PTC reference temperature (Tref), as does the voltage over the resistor. The temperature measurement function reads the voltage through analog input AI1/2 and converts it into ohms. The figure below shows typical PTC sensor resistance values as a function of the motor operating temperature.</p>  <table border="1" data-bbox="821 712 1241 801"> <thead> <tr> <th>Temperature</th> <th>Resistance</th> </tr> </thead> <tbody> <tr> <td>Normal</td> <td>0 ... 1.5 kohm</td> </tr> <tr> <td>Excessive</td> <td>≥ 4 kohm</td> </tr> </tbody> </table>	Temperature	Resistance	Normal	0 ... 1.5 kohm	Excessive	≥ 4 kohm	4
Temperature	Resistance								
Normal	0 ... 1.5 kohm								
Excessive	≥ 4 kohm								
	THERM(0)	The function is active. Motor temperature is monitored using a PTC sensor (see selection PTC) connected to drive via a normally closed thermistor relay connected to a digital input. 0 = motor overtemperature.	5						
	THERM(1)	The function is active. Motor temperature is monitored using a PTC sensor (see selection PTC) connected to drive via a normally open thermistor relay connected to a digital input. 1 = motor overtemperature.	6						
3502	INPUT SELECTION	Selects the source for the motor temperature measurement signal.	AI1						
	AI1	Analog input AI1. Used when PT100 or PTC sensor is selected for the temperature measurement.	1						
	AI2	Analog input AI2. Used when PT100 or PTC sensor is selected for the temperature measurement	2						
	DI1	Digital input DI1. Used when par. 3501 SENSOR TYPE value is set to THERMI(0)/(1).	3						
	DI2	Digital input DI2. Used when par. 3501 SENSOR TYPE value is set to THERMI(0)/(1).	4						
	DI3	Digital input DI3. Used when par. 3501 SENSOR TYPE value is set to THERMI(0)/(1).	5						
	DI4	Digital input DI4. Used when par. 3501 SENSOR TYPE value is set to THERMI(0)/(1).	6						
	DI5	Digital input DI5. Used when par. 3501 SENSOR TYPE value is set to THERMI(0)/(1).	7						
3503	ALARM LIMIT	Defines the alarm limit for motor temperature measurement. Alarm MOTOR TEMP indication is given when the limit is exceeded. When par. 3501 SENSOR TYPE value is set to THERMI(0)/(1): 1 = alarm.	0						
	x...x	Alarm limit	-						
3504	FAULT LIMIT	Defines the fault trip limit for motor temperature measurement. The drive trips on fault MOT OVERTEMP when the limit is exceeded. When par. 3501 SENSOR TYPE value is set to THERMI(0)/(1): 1 = fault.	0						
	x...x	Fault limit	-						

Parameters – complete descriptions			
Index	Name/Selection	Description	Def, FbEq
3505	AO EXCITATION	Enables current feed from analog output AO. Parameter setting overrides parameter group 15 ANALOGUE OUTPUTS settings. With PTC the output current is 1.6 mA. With Pt 100 the output current is 9.1 mA.	DISABLE
	DISABLE	Disabled	0
	ENABLE	Enabled	1
36 TIMED FUNCTIONS		Time periods 1 to 4 and booster signal. See section Timed functions on page 131 .	
3601	TIMERS ENABLE	Selects the source for the timed function enable signal.	NOT SEL
	NOT SEL	Timed function is not selected.	0
	DI1	Digital input DI. Timed function enable by a rising edge of DI1.	1
	DI2	See selection DI1.	2
	DI3	See selection DI1.	3
	DI4	See selection DI1.	4
	DI5	See selection DI1.	5
	ACTIVE	Timed function is always enabled.	7
	DI1(INV)	Inverted digital input DI1. Timed function enable by a falling edge of DI1.	-1
	DI2(INV)	See selection DI1(INV).	-2
	DI3(INV)	See selection DI1(INV).	-3
	DI4(INV)	See selection DI1(INV).	-4
	DI5(INV)	See selection DI1(INV).	-5
3602	START TIME 1	Defines the daily start time 1. The time can be changed in 2 second steps.	00:00:00
	00:00:00...23:59:58	hours:minutes:seconds. Example: If parameter value is set to 07:00:00, the timed function is activated at 7:00 (7 a.m).	
3603	STOP TIME 1	Defines the daily stop time 1. The time can be changed in 2 second steps.	00:00:00
	00:00:00...23:59:58	hours:minutes:seconds. Example: If parameter value is set to 18:00:00, the timed function is deactivated at 18:00 (6 p.m).	
3604	START DAY 1	Defines the start day 1.	MONDAY
	MONDAY	Example: If parameter value is set to MONDAY, timed function 1 is active from Monday midnight (00:00:00).	1
	TUESDAY		2
	WEDNESDAY		3
	THURSDAY		4
	FRIDAY		5
	SATURDAY		6
	SUNDAY		7
3605	STOP DAY 1	Defines the stop day 1.	MONDAY
	See parameter 3604 .	If parameter is set to FRIDAY, timed function 1 is deactivated on Friday midnight (23:59:58).	
3606	START TIME 2	See parameter 3602 START TIME 1.	
		See parameter 3602 START TIME 1.	
3607	STOP TIME 2	See parameter 3603 STOP TIME 1.	
		See parameter 3603 STOP TIME 1.	

Parameters – complete descriptions			
Index	Name/Selection	Description	Def, FbEq
3608	START DAY 2	See parameter 3604 START DAY 1.	
		See parameter 3604 START DAY 1.	
3609	STOP DAY 2	See parameter 3605 STOP DAY 1.	
		See parameter 3605 STOP DAY 1.	
3610	START TIME 3	See parameter 3602 START TIME 1.	
		See parameter 3602 START TIME 1.	
3611	STOP TIME 3	See parameter 3603 STOP TIME 1.	
		See parameter 3603 STOP TIME 1.	
3612	START DAY 3	See parameter 3604 START DAY 1.	
		See parameter 3604 START DAY 1.	
3613	STOP DAY 3	See parameter 3605 STOP DAY 1.	
		See parameter 3605 STOP DAY 1.	
3614	START TIME 4	See parameter 3602 START TIME 1.	
		See parameter 3602 START TIME 1.	
3615	STOP TIME 4	See parameter 3603 STOP TIME 1.	
		See parameter 3603 STOP TIME 1.	
3616	START DAY 4	See parameter 3604 START DAY 1.	
		See parameter 3604 START DAY 1.	
3617	STOP DAY 4	See parameter 3605 STOP DAY 1.	
		See parameter 3605 STOP DAY 1.	
3622	BOOSTER SEL	Selects the source for the booster activation signal.	NOT SEL
	NOT SEL	No booster activation signal	0
	DI1	Digital input DI1. 1 = active, 0 = inactive.	1
	DI2	See selection DI1.	2
	DI3	See selection DI1.	3
	DI4	See selection DI1.	4
	DI5	See selection DI1.	5
	DI1(INV)	Inverted digital input DI1. 0 = active, 1 = inactive.	-1
	DI2(INV)	See selection DI1(INV).	-2
	DI3(INV)	See selection DI1(INV).	-3
DI4(INV)	See selection DI1(INV).	-4	
DI5(INV)	See selection DI1(INV).	-5	

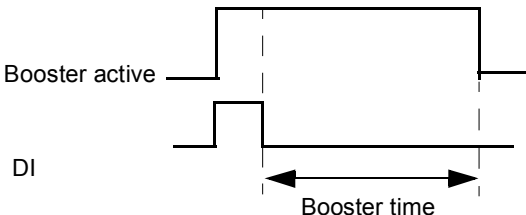
Parameters – complete descriptions			
Index	Name/Selection	Description	Def, FbEq
3623	BOOSTER TIME	Defines the time inside which the booster is deactivated after the booster activation signal is switched off.	00:00:00
	00:00:00...23:59:58	<p>hours:minutes:seconds</p> <p>Example: If parameter 3622 BOOSTER SEL is set to DI1 and 3623 BOOSTER TIME is set to 01:30:00, the booster is active for 1 hour and 30 minutes after digital input DI is deactivated.</p> 	
3626	TIMED FUNC 1 SRC	Selects the time periods for TIMED FUNC 1 SCR. Timed function can consist of 0...4 time periods and a booster.	NOT SEL
	NOT SEL	No time periods selected	0
	T1	Time period 1	1
	T2	Time period 2	2
	T1+T2	Time periods 1 and 2	3
	T3	Time period 3	4
	T1+T3	Time periods 1 and 3	5
	T2+T3	Time periods 2 and 3	6
	T1+T2+T3	Time periods 1, 2 and 3	7
	T4	Time period 4	8
	T1+T4	Time periods 1 and 4	9
	T2+T4	Time periods 2 and 4	10
	T1+T2+T4	Time periods 1, 2 and 4	11
	T3+T4	Time periods 4 and 3	12
	T1+T3+T4	Time periods 1, 3 and 4	13
	T2+T3+T4	Time periods 2, 3 and 4	14
	T1+T2+T3+T4	Time periods 1, 2, 3 and 4	15
	BOOSTER	Booster	16
	T1+B	Booster and time period 1	17
	T2+B	Booster and time period 2	18
	T1+T2+B	Booster and time periods 1 and 2	19
	T3+B	Booster and time period 3	20
	T1+T3+B	Booster and time periods 1 and 3	21
	T2+T3+B	Booster and time periods 2 and 3	22
	T1+T2+T3+B	Booster and time periods 1, 2 and 3	23
	T4+B	Booster and time period 4	24
	T1+T4+B	Booster and time periods 1 and 4	25
	T2+T4+B	Booster and time periods 2 and 4	26
	T1+T2+T4+B	Booster and time periods 1, 2 and 4	27

Parameters – complete descriptions			
Index	Name/Selection	Description	Def, FbEq
	T3+T4+B	Booster and time periods 3 and 4	28
	T1+T3+T4+B	Booster and time periods 1, 3 and 4	29
	T2+T3+T4+B	Booster and time periods 2, 3 and 4	30
	T1+2+3+4+B	Booster and time periods 1, 2, 3 and 4	31
3627	TIMED FUNC 2 SRC	See parameter 3626 TIMED FUNC 1 SRC.	
		See parameter 3626 TIMED FUNC 1 SRC.	
3628	TIMED FUNC 3 SRC	See parameter 3626 TIMED FUNC 1 SRC.	
		See parameter 3626 TIMED FUNC 1 SRC.	
3629	TIMED FUNC 4 SRC	See parameter 3626 TIMED FUNC 1 SRC.	
		See parameter 3626 TIMED FUNC 1 SRC.	
40 PROCESS PID SET 1		Process PID (PID1) control parameter set 1. See section <i>PID control</i> on page 120.	
4001	GAIN	Defines the gain for the process PID controller. Great gain may cause speed oscillation.	1
	0.1...100.0	Gain. When value is set to 0.1, the PID controller output changes one-tenth as much as the error value. When value is set to 100, the PID controller output changes one hundred times as much as the error value.	1 = 0.1
4002	INTEGRATION TIME	Defines the integration time for the process PID1 controller. The integration time defines the rate at which the controller output changes when the error value is constant. The shorter the integration time, the faster the continuous error value is corrected. Too short an integration time makes the control unstable.	60
		<p>A = Error B = Error value step C = Controller output with gain = 1 D = Controller output with gain = 10</p>	
	0.0...3600.0 s	Integration time. If parameter value is set to zero, integration (I-part of the PID controller) is disabled.	1 = 0.1 s

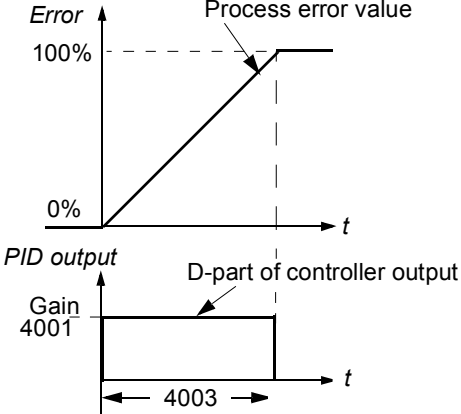
Parameters – complete descriptions																		
Index	Name/Selection	Description	Def, FbEq															
4003	DERIVATION TIME	<p>Defines the derivation time for the process PID controller. Derivative action boosts the controller output if the error value changes. The longer the derivation time, the more the speed controller output is boosted during the change. If the derivation time is set to zero, the controller works as a PI controller, otherwise as a PID controller.</p> <p>The derivation makes the control more responsive for disturbances.</p> <p>The derivative is filtered with a 1-pole filter. Filter time constant is defined by parameter 4004 PID DERIV FILTER.</p> 	0															
	0.0...10.0 s	Derivation time. If parameter value is set to zero, the derivative part of the PID controller is disabled.	1 = 0.1 s															
4004	PID DERIV FILTER	Defines the filter time constant for the derivative part of the process PID controller. Increasing the filter time smooths the derivative and reduces noise.	1															
	0.0...10.0 s	Filter time constant. If parameter value is set to zero, the derivative filter is disabled.	1 = 0.1 s															
4005	ERROR VALUE INV	Selects the relationship between the feedback signal and drive speed.	NO															
	NO	Normal: A decrease in feedback signal increases drive speed. Error = Ref - Fbk	0															
	YES	Inverted: A decrease in feedback signal decreases drive speed. Error = Fbk - Ref	1															
4006	UNITS	Selects the unit for PID controller actual values.	%															
		See parameter 3405 OUTPUT1 UNIT selections NO UNIT...Mrev.	0...63															
4007	UNIT SCALE	Defines the decimal point location for the display parameter selected by parameter 4006 UNITS.	1															
	0...3	<p>Example PI (3.14159)</p> <table border="1" data-bbox="539 1621 970 1778"> <thead> <tr> <th>4007 value</th> <th>Entry</th> <th>Display</th> </tr> </thead> <tbody> <tr> <td>0</td> <td>0003</td> <td>3</td> </tr> <tr> <td>1</td> <td>0031</td> <td>3.1</td> </tr> <tr> <td>2</td> <td>0314</td> <td>3.14</td> </tr> <tr> <td>3</td> <td>3142</td> <td>3.142</td> </tr> </tbody> </table>	4007 value	Entry	Display	0	0003	3	1	0031	3.1	2	0314	3.14	3	3142	3.142	1 = 1
4007 value	Entry	Display																
0	0003	3																
1	0031	3.1																
2	0314	3.14																
3	3142	3.142																

Parameters – complete descriptions			
Index	Name/Selection	Description	Def, FbEq
4008	0% VALUE	Defines together with parameter 4009 100% VALUE the scaling applied to the PID controller's actual values. 	0
x...x		Unit and range depend on the unit and scale defined by parameters 4006 UNITS and 4007 UNIT SCALE.	
4009	100% VALUE	Defines together with parameter 4008 0% VALUE the scaling applied to the PID controller's actual values.	100
x...x		Unit and range depend on the unit and scale defined by parameters 4006 UNITS and 4007 UNIT SCALE.	
4010	SET POINT SEL	Selects the source for the process PID controller reference signal.	AI1
	KEYPAD	Control panel	0
	AI1	Analog input AI1	1
	AI2	Analog input AI2	2
	COMM	Fieldbus reference REF2	8
	COMM+AI1	Summation of fieldbus reference REF2 and analog input AI1. See section Reference selection and correction on page 249.	9
	COMM*AI1	Multiplication of fieldbus reference REF2 and analog input AI1. See section Reference selection and correction on page 249.	10
	DI3U,4D(RNC)	Digital input 3: Reference increase. Digital input DI4: Reference decrease. Stop command resets the reference to zero. The reference is not saved if the control source is changed from EXT1 to EXT2, from EXT2 to EXT1 or from LOC to REM.	11
	DI3U,4D(NC)	Digital input 3: Reference increase. Digital input DI4: Reference decrease. The program stores the active reference (not reset by a stop command). The reference is not saved if the control source is changed from EXT1 to EXT2, from EXT2 to EXT1 or from LOC to REM.	12
	AI1+AI2	Reference is calculated with the following equation: $REF = AI1(\%) + AI2(\%) - 50\%$	14
	AI1*AI2	Reference is calculated with the following equation: $REF = AI1(\%) \cdot (AI2(\%) / 50\%)$	15
	AI1-AI2	Reference is calculated with the following equation: $REF = AI1(\%) + 50\% - AI2(\%)$	16
	AI1/AI2	Reference is calculated with the following equation: $REF = AI1(\%) \cdot (50\% / AI2(\%))$	17
	INTERNAL	A constant value defined by parameter 4011 INTERNAL SETPNT	19
	DI4U,5D(NC)	See selection DI3U,4D(NC).	31
	FREQ INPUT	Frequency input	32

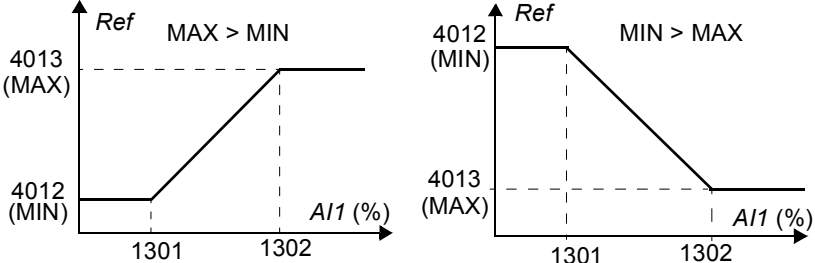
Parameters – complete descriptions			
Index	Name/Selection	Description	Def, FbEq
	SEQ PROG OUT	Sequence programming output. See parameter group 84 SEQUENCE PROG.	33
4011	INTERNAL SETPNT	Selects a constant value as process PID controller reference, when parameter 4010 SET POINT SEL value is set to INTERNAL.	40
	x...x	Unit and range depend on the unit and scale defined by parameters 4006 UNITS and 4007 UNIT SCALE.	
4012	SETPOINT MIN	Defines the minimum value for the selected PID reference signal source. See parameter 4010 SET POINT SEL	0
	-500.0...500.0%	Value in percent. Example: Analog input AI1 is selected as the PID reference source (value of parameter 4010 is AI1). The reference minimum and maximum correspond the 1301 MINIMUM AI1 and 1302 MAXIMUM AI1 settings as follows: 	1 = 0.1%
4013	SETPOINT MAX	Defines the maximum value for the selected PID reference signal source. See parameters 4010 SET POINT SEL and 4012 SETPOINT MIN.	100
	-500.0...500.0%	Value in percent	1 = 0.1%
4014	FBK SEL	Selects the process actual value (feedback signal) for the process PID controller: The sources for the variables ACT1 and ACT2 are further defined by parameters 4016 ACT1 INPUT and 4017 ACT2 INPUT.	ACT1
	ACT1	ACT1	1
	ACT1-ACT2	Subtraction of ACT1 and ACT 2	2
	ACT1+ACT2	Addition of ACT1 and ACT2	3
	ACT1*ACT2	Multiplication of ACT1 and ACT2	4
	ACT1/ACT2	Division of ACT1 and ACT2	5
	MIN(ACT1,2)	Selects the smaller of ACT1 and ACT2	6
	MAX(ACT1,2)	Selects the higher of ACT1 and ACT2	7
	sqrt(ACT1-2)	Square root of the subtraction of ACT1 and ACT2	8
	sqA1+sqA2	Addition of the square root of ACT1 and the square root of ACT2	9
	sqrt(ACT1)	Square root of ACT1	10
	COMM FBK 1	Signal 0158 PID COMM VALUE 1 value	11
	COMM FBK 2	Signal 0159 PID COMM VALUE 2 value	12
4015	FBK MULTIPLIER	Defines an extra multiplier for the value defined by parameter 4014 FBK SEL. Parameter is used mainly in applications where feedback value is calculated from a other variable (e.g. flow from pressure difference).	0
	-32.768...32.767	Multiplier. If parameter value is set to zero, no multiplier is used.	1 = 0.001
4016	ACT1 INPUT	Defines the source for actual value 1 (ACT1). See also parameter 4018 ACT1 MINIMUM.	AI2
	AI1	Uses analog input 1 for ACT1	1

Parameters – complete descriptions																											
Index	Name/Selection	Description	Def, FbEq																								
	AI2	Uses analog input 2 for ACT2	2																								
	CURRENT	Uses current for ACT1	3																								
	TORQUE	Uses torque for ACT1	4																								
	POWER	Uses power for ACT1	5																								
	COMM ACT 1	Uses value of signal 0158 PID COMM VALUE 1 for ACT1	6																								
	COMM ACT 2	Uses value of signal 0159 PID COMM VALUE 2 for ACT1	7																								
	FREQ INPUT	Frequency input	8																								
4017	ACT2 INPUT	Defines the source for actual value ACT2. See also parameter 4020 ACT2 MINIMUM.	AI2																								
		See parameter 4016 ACT1 INPUT.																									
4018	ACT1 MINIMUM	<p>Sets the minimum value for ACT1.</p> <p>Scales the source signal used as the actual value ACT1 (defined by parameter 4016 ACT1 INPUT). For parameter values 6 (COMM ACT 1) and 7 (COMM ACT 2) scaling is not done.</p> <table border="1"> <thead> <tr> <th>Par 4016</th> <th>Source</th> <th>Source min.</th> <th>Source max.</th> </tr> </thead> <tbody> <tr> <td>1</td> <td>Analog input 1</td> <td>1301 MINIMUM AI1</td> <td>1302 MAXIMUM AI1</td> </tr> <tr> <td>2</td> <td>Analog input 2</td> <td>1301 MINIMUM AI2</td> <td>1302 MAXIMUM AI2</td> </tr> <tr> <td>3</td> <td>Current</td> <td>0</td> <td>2 - nominal current</td> </tr> <tr> <td>4</td> <td>Torque</td> <td>-2 - nominal torque</td> <td>2 - nominal torque</td> </tr> <tr> <td>5</td> <td>Power</td> <td>-2 - nominal power</td> <td>2 - nominal power</td> </tr> </tbody> </table> <p>The ACT minimum and maximum correspond the 1301 MINIMUM AI1 and 1302 MAXIMUM AI1 settings as follows.</p> <p>A= Normal; B = Inversion (ACT1 minimum > ACT1 maximum)</p>	Par 4016	Source	Source min.	Source max.	1	Analog input 1	1301 MINIMUM AI1	1302 MAXIMUM AI1	2	Analog input 2	1301 MINIMUM AI2	1302 MAXIMUM AI2	3	Current	0	2 - nominal current	4	Torque	-2 - nominal torque	2 - nominal torque	5	Power	-2 - nominal power	2 - nominal power	0
Par 4016	Source	Source min.	Source max.																								
1	Analog input 1	1301 MINIMUM AI1	1302 MAXIMUM AI1																								
2	Analog input 2	1301 MINIMUM AI2	1302 MAXIMUM AI2																								
3	Current	0	2 - nominal current																								
4	Torque	-2 - nominal torque	2 - nominal torque																								
5	Power	-2 - nominal power	2 - nominal power																								
		-1000...1000%	Value in percent	1 = 1%																							
4019	ACT1 MAXIMUM	Defines the maximum value for the variable ACT1 if an analog input is selected as a source for ACT1. See parameter 4016 ACT1 INPUT. The minimum (4018 ACT1 MINIMUM) and maximum settings of ACT1 define how the voltage/current signal received from the measuring device is converted to a percentage value used by the process PID controller. See parameter 4018 ACT1 MINIMUM.	100																								
		-1000...1000%	Value in percent	1 = 1%																							
4020	ACT2 MINIMUM	See parameter 4018 ACT1 MINIMUM.	0																								
		-1000...1000%	See parameter 4018 .	1 = 1%																							
4021	ACT2 MAXIMUM	See parameter 4019 ACT1 MAXIMUM.	100																								
		-1000...1000%	See parameter 4019 .	1 = 1%																							

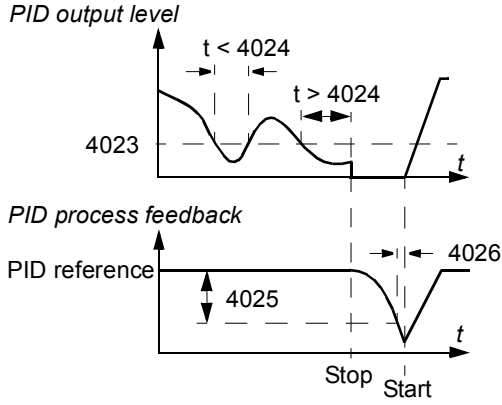
Parameters – complete descriptions			
Index	Name/Selection	Description	Def, FbEq
4022	SLEEP SELECTION	Activates the sleep function and selects the source for the activation input. See section <i>Sleep function for the process PID (PID1) control</i> on page 122.	NOT SEL
	NOT SEL	No sleep function selected	0
	DI1	The function is activated/deactivated through digital input DI1.1 = activation, 0 = deactivation. The internal sleep criteria set by parameters 4023 PID SLEEP LEVEL and 4025 WAKE-UP DEV are not effective. The sleep start and stop delay parameters 4024 PID SLEEP DELAY and 4026 WAKE-UP DELAY are effective.	1
	DI2	See selection DI1.	2
	DI3	See selection DI1.	3
	DI4	See selection DI1.	4
	DI5	See selection DI1.	5
	INTERNAL	Activated and deactivated automatically as defined by parameters 4023 PID SLEEP LEVEL and 4025 WAKE-UP DEV.	7
	DI1(INV)	The function is activated/deactivated through inverted digital input DI1. 1 = deactivation, 0 = activation. The internal sleep criteria set by parameters 4023 PID SLEEP LEVEL and 4025 WAKE-UP DEV are not effective. The sleep start and stop delay parameters 4024 PID SLEEP DELAY and 4026 WAKE-UP DELAY are effective.	-1
	DI2(INV)	See selection DI1(INV).	-2
	DI3(INV)	See selection DI1(INV).	-3
	DI4(INV)	See selection DI1(INV).	-4
	DI5(INV)	See selection DI1(INV).	-5
4023	PID SLEEP LEVEL	Defines the start limit for the sleep function. If the motor speed is below a set level (4023) longer than the sleep delay (4024), the drive shifts to the sleeping mode: The motor is stopped and the control panel shows alarm message PID SLEEP. Parameter 4022 SLEEP SELECTION must be set to INTERNAL. 	0
	0.0...500.0 Hz / 0...30000 rpm	Sleep start level	1 = 0.1 Hz / 1 rpm

Parameters – complete descriptions			
Index	Name/Selection	Description	Def, FbEq
4024	PID SLEEP DELAY	Defines the delay for the sleep start function. See parameter 4023 PID SLEEP LEVEL. When the motor speed falls below the sleep level, the counter starts. When the motor speed exceeds the sleep level, the counter is reset.	60
	0.0...3600.0 s	Sleep start delay	1 = 0.1 s
4025	WAKE-UP DEV	Defines the wake-up deviation for the sleep function. The drive wakes up if the process actual value deviation from the PID reference value exceeds the set wake-up deviation (4025) longer than the wake-up delay (4026). Wake-up level depends on parameter 4005 ERROR VALUE INV settings. If parameter 4005 is set 0: Wake-up level = PID reference (4010) - Wake-up deviation (4025). If parameter 4005 is set to 1: Wake-up level = PID reference (4010) + Wake-up deviation (4025)	0
		<p>See also figures in parameter 4023 PID SLEEP LEVEL.</p>	
	x...x	Unit and range depend on the unit and scale defined by parameters 4026 WAKE-UP DELAY and 4007 UNIT SCALE.	
4026	WAKE-UP DELAY	Defines the wake-up delay for the sleep function. See parameter 4023 PID SLEEP LEVEL.	0.5
	0.00...60.00 s	Wake-up delay	1 = 0.01 s
4027	PID 1 PARAM SET	Defines the source from which the drive reads the signal that selects between PID parameter set 1 and 2. PID parameter set 1 is defined by parameters 4001 ... 4026 . PID parameter set 2 is defined by parameters 4101 ... 4126 .	SET1
	SET 1	PID SET 1 is active.	0
	DI1	Digital input DI1. 1 = PID SET 2, 0 = PID SET 1.	1
	DI2	See selection DI1.	2
	DI3	See selection DI1.	3
	DI4	See selection DI1.	4
	DI5	See selection DI1.	5
	SET 2	PID SET 2 is active.	7
	TIMED FUNC 1	Timed PID SET 1/2 control. Timed function 1 inactive = PID SET 1, timed function 1 active = PID SET 2. See parameter group 36 TIMED FUNCTIONS.	8
	TIMED FUNC 2	See selection TIMED FUNC 1.	9
	TIMED FUNC 3	See selection TIMED FUNC 1.	10
	TIMED FUNC 4	See selection TIMED FUNC 1.	11
	DI1(INV)	Inverted digital input DI1. 0 = PID SET 2, 1 = PID SET 1.	-1
	DI2(INV)	See selection DI1(INV).	-2
	DI3(INV)	See selection DI1(INV).	-3
	DI4(INV)	See selection DI1(INV).	-4
	DI5(INV)	See selection DI1(INV).	-5

Parameters – complete descriptions			
Index	Name/Selection	Description	Def, FbEq
41 PROCESS PID SET 2		Process PID (PID1) control parameter set 2. See section PID control on page 120 .	
4101	GAIN	See parameter 4001 GAIN.	
4102	INTEGRATION TIME	See parameter 4002 INTEGRATION TIME.	
4103	DERIVATION TIME	See parameter 4003 DERIVATION TIME.	
4104	PID DERIV FILTER	See parameter 4004 PID DERIV FILTER.	
4105	ERROR VALUE INV	See parameter 4005 ERROR VALUE INV.	
4106	UNITS	See parameter 4006 UNITS.	
4107	UNIT SCALE	See parameter 4007 UNIT SCALE.	
4108	0% VALUE	See parameter 4008 0% VALUE.	
4109	100% VALUE	See parameter 4009 100% VALUE.	
4110	SET POINT SEL	See parameter 4010 SET POINT SEL.	
4111	INTERNAL SETPNT	See parameter 4011 INTERNAL SETPNT.	
4112	SETPOINT MIN	See parameter 4012 SETPOINT MIN.	
4113	SETPOINT MAX	See parameter 4013 SETPOINT MAX.	
4114	FBK SEL	See parameter 4014 FBK SEL.	
4115	FBK MULTIPLIER	See parameter 4015 FBK MULTIPLIER.	
4116	ACT1 INPUT	See parameter 4016 ACT1 INPUT.	
4117	ACT2 INPUT	See parameter 4017 ACT2 INPUT.	
4118	ACT1 MINIMUM	See parameter 4018 ACT1 MINIMUM.	
4119	ACT1 MAXIMUM	See parameter 4018 ACT1 MAXIMUM.	
4120	ACT2 MINIMUM	See parameter 4020 ACT2 MINIMUM.	
4121	ACT2 MAXIMUM	See parameter 4021 ACT2 MAXIMUM.	
4122	SLEEP SELECTION	See parameter 4022 SLEEP SELECTION.	
4123	PID SLEEP LEVEL	See parameter 4023 PID SLEEP LEVEL.	
4124	PID SLEEP DELAY	See parameter 4024 PID SLEEP DELAY.	
4125	WAKE-UP DEV	See parameter 4025 WAKE-UP DEV.	
4126	WAKE-UP DELAY	See parameter 4026 WAKE-UP DELAY.	
42 EXT / TRIM PID		External/Trim PID (PID2) control. See section PID control on page 120 .	
4201	GAIN	See parameter 4001 GAIN.	
4202	INTEGRATION TIME	See parameter 4002 INTEGRATION TIME.	
4203	DERIVATION TIME	See parameter 4003 DERIVATION TIME.	
4204	PID DERIV FILTER	See parameter 4004 PID DERIV FILTER.	
4205	ERROR VALUE INV	See parameter 4005 ERROR VALUE INV.	
4206	UNITS	See parameter 4006 UNITS.	
4207	UNIT SCALE	See parameter 4007 UNIT SCALE.	
4208	0% VALUE	See parameter 4008 0% VALUE.	
4209	100% VALUE	See parameter 4009 100% VALUE.	
4210	SET POINT SEL	See parameter 4010 SET POINT SEL.	
4211	INTERNAL SETPNT	See parameter 4011 INTERNAL SETPNT.	
4212	SETPOINT MIN	See parameter 4012 SETPOINT MIN.	

Parameters – complete descriptions			
Index	Name/Selection	Description	Def, FbEq
4213	SETPOINT MAX	See parameter 4013 SETPOINT MAX.	
4214	FBK SEL	See parameter 4014 FBK SEL.	
4215	FBK MULTIPLIER	See parameter 4015 FBK MULTIPLIER.	
4216	ACT1 INPUT	See parameter 4016 ACT1 INPUT.	
4217	ACT2 INPUT	See parameter 4017 ACT2 INPUT.	
4218	ACT1 MINIMUM	See parameter 4018 ACT1 MINIMUM.	
4219	ACT1 MAXIMUM	See parameter 4018 ACT1 MAXIMUM.	
4220	ACT2 MINIMUM	See parameter 4020 ACT2 MINIMUM.	
4221	ACT2 MAXIMUM	See parameter 4021 ACT2 MAXIMUM.	
4228	ACTIVATE	Selects the source for the external PID function activation signal. Parameter 4230 TRIM MODE must be set to NOT SEL.	NOT SEL
	NOT SEL	No external PID control activation selected	0
	DI1	Digital input DI1. 1 = active, 0 = inactive.	1
	DI2	See selection DI1.	2
	DI3	See selection DI1.	3
	DI4	See selection DI1.	4
	DI5	See selection DI1.	5
	DRIVE RUN	Activation at drive start. Start (drive running) = active.	7
	ON	Activation at drive power-up. Power-up (drive powered) = active.	8
	TIMED FUNC 1	Activation by a timed function. Timed function 1 active = PID control active. See parameter group 36 <i>TIMED FUNCTIONS</i> .	9
	TIMED FUNC 2	See selection TIMED FUNC 1.	10
	TIMED FUNC 3	See selection TIMED FUNC 1.	11
	TIMED FUNC 4	See selection TIMED FUNC 1.	12
	DI1(INV)	Inverted digital input DI1. 0 = active, 1 = inactive.	-1
	DI2(INV)	See selection DI1(INV).	-2
	DI3(INV)	See selection DI1(INV).	-3
	DI4(INV)	See selection DI1(INV).	-4
	DI5(INV)	See selection DI1(INV).	-5
4229	OFFSET	Defines the offset for the external PID controller output. When PID controller is activated, controller output starts from the offset value. When PID controller is deactivated, controller output is reset to the offset value. Parameter 4230 TRIM MODE must be set to NOT SEL.	0
	0.0...100.0%	Value in percent	1 = 0.1%
4230	TRIM MODE	Activates the trim function and selects between the direct and proportional trimming. With trimming it is possible to combine a corrective factor to the drive reference. See section Reference trimming on page 101 .	NOT SEL
	NOT SEL	No trim function selected	0
	PROPORTIONAL	Active. The trimming factor is proportional to the rpm/Hz reference before trimming (REF1).	1
	DIRECT	Active. The trimming factor is relative to a fixed maximum limit used in the reference control loop (maximum speed, frequency or torque).	2

Parameters – complete descriptions			
Index	Name/Selection	Description	Def, FbEq
4231	TRIM SCALE	Defines the multiplier for the trimming function. See section Reference trimming on page 101.	0
	-100.0...100.0%	Multiplier	1 = 0.1%
4232	CORRECTION SRC	Selects the trim reference. See section Reference trimming on page 101.	PID2REF
	PID2REF	PID2 reference selected by parameter 4210 (i.e. signal 0129 PID 2 SETPNT value)	1
	PID2OUTPUT	PID2 output i.e. signal 0127 PID 2 OUTPUT value	2
4233	TRIM SELECTION	Selects whether the trimming is used for correcting the speed or torque reference. See section Reference trimming on page 101.	SPEED/ FREQ
	SPEED/FREQ	Speed reference trimming	0
	TORQUE	Torque reference trimming (only for REF2 (%))	1
43 MECH BRK CONTROL		Control of a mechanical brake. See section Control of a mechanical brake on page 126.	
4301	BRAKE OPEN DLY	Defines the brake open delay (= the delay between the internal open brake command and the release of the motor speed control). The delay counter starts when the motor current/torque/speed has risen to the level required at brake release (parameter 4302 BRAKE OPEN LVL or 4304 FORCED OPEN LVL) and the motor has been magnetised. Simultaneously with the start of the counter, the brake function energises the relay output controlling the brake and the brake starts opening.	0.20
	0.00...2.50 s	Delay time	1 = 0.01 s
4302	BRAKE OPEN LVL	Defines the motor starting torque/current at brake release. After start the drive current/torque is frozen to the set value, until the motor is magnetised.	100%
	0.0...180.0%	Value in percent of the nominal torque T_N (with vector control) or the nominal current I_{2N} (with scalar control). The control mode is selected by parameter 9904 MOTOR CTRL MODE.	1 = 0.1%
4303	BRAKE CLOSE LVL	Defines the brake close speed. After stop the brake is closed when drive speed falls below the set value.	4.0%
	0.0...100.0%	Value in percent of the nominal speed (with vector control) or the nominal frequency (with scalar control). The control mode is selected by parameter 9904 MOTOR CTRL MODE.	1 = 0.1%
4304	FORCED OPEN LVL	Defines the speed at brake release. Parameter setting overrides parameter 4302 BRAKE OPEN LVL setting. After start, the drive speed is frozen to the set value, until the motor is magnetised. The purpose of this parameter is to generate enough start torque to prevent the motor rotating into the wrong direction because of the motor load.	0
	0.0...100%	Value in percent of the maximum frequency (with scalar control) or the maximum speed (with vector control). If parameter value is set to zero, the function is disabled. The control mode is selected by parameter 9904 MOTOR CTRL MODE.	1 = 0.1%
4305	BRAKE MAGN DELAY	Defines motor magnetising time. After start drive current/torque/speed is frozen to the value defined by parameter 4302 BRAKE OPEN LVL or 4304 FORCED OPEN LVL for the set time.	0
	0...10000 ms	Magnetising time. If parameter value is set to zero, the function is disabled.	1 = 1 ms

Parameters – complete descriptions			
Index	Name/Selection	Description	Def, FbEq
4306	RUNTIME FREQ LVL	Defines the brake close speed. When frequency falls below the set level during run, the brake is closed. The brake is re-opened when the requirements set by parameters 4301...4305 are met.	0
	0.0...100.0%	Value in percent of the maximum frequency (with scalar control) or the maximum speed (with vector control). If parameter value is set to zero, the function is disabled. The control mode is selected by parameter 9904 MOTOR CTRL MODE.	1 = 0.1%
50 ENCODER		Encoder connection. For more information, see <i>MTAC-01 Pulse Encoder Interface Module User's Manual</i> [3AFE68591091 (English)].	
5001	PULSE NR	States the number of encoder pulses per one revolution.	1024
	32...16384 ppr	Pulse number in pulses per round (ppr)	1 = 1
5002	ENCODER ENABLE	Enables the encoder.	DISABLE
	DISABLE	Disabled	0
	ENABLE	Enabled	1
5003	ENCODER FAULT	Defines the operation of the drive if a failure is detected in communication between the pulse encoder and the pulse encoder interface module, or between the module and the drive.	FAULT
	FAULT	The drive trips on fault ENCODER ERR.	1
	ALARM	The drive generates alarm ENCODER ERROR.	2
5010	Z PLS ENABLE	Enables the encoder zero (Z) pulse. Zero pulse is used for position reset.	DISABLE
	DISABLE	Disabled	0
	ENABLE	Enabled	1
5011	POSITION RESET	Enables the position reset.	DISABLE
	DISABLE	Disabled	0
	ENABLE	Enabled	1
51 EXT COMM MODULE		The parameters need to be adjusted only when a fieldbus adapter module (optional) is installed and activated by parameter 9802 COMM PROT SEL. For more details on the parameters, refer to the manual of the fieldbus module and chapter <i>Fieldbus control with fieldbus adapter</i> . These parameter settings will remain the same even though the macro is changed. Note: In adapter module the parameter group number is 1.	
5101	FBA TYPE	Displays the type of the connected fieldbus adapter module.	
	NOT DEFINED	Fieldbus module is not found, or it is not properly connected, or parameter 9802 COMM PROT SEL setting is not EXT FBA.	0
	PROFIBUS-DP	Profibus adapter module	1
	CANopen	CANopen adapter module	32
	DEVICENET	DeviceNet adapter module	37
5102	FB PAR 2	These parameters are adapter module-specific. For more information, see the module manual. Note that not all of these parameters are necessarily visible.	
...		
5126	FB PAR 26		
5127	FBA PAR REFRESH	Validates any changed adapter module configuration parameter settings. After refreshing, the value reverts automatically to DONE.	
	DONE	Refreshing done	0
	REFRESH	Refreshing	1

Parameters – complete descriptions			
Index	Name/Selection	Description	Def, FbEq
52 PANEL COMM		Communication settings for the control panel port on the drive	
5201	STATION ID	Defines the address of the drive. Two units with the same address are not allowed on-line.	1
	1...247	Address	1 = 1
5202	BAUD RATE	Defines the transfer rate of the link.	9.6
	9.6 kbit/s	9.6 kbit/s	1 = 0.1 kbit/s
	19.2 kbit/s	19.2 kbit/s	
	38.4 kbit/s	38.4 kbit/s	
	57.6 kbit/s	57.6 kbit/s	
	115.2 kbit/s	115.2 kbit/s	
5203	PARITY	Defines the use of parity and stop bit(s). The same setting must be used in all on-line stations.	8 NONE 1
	8 NONE 1	No parity bit, one stop bit	0
	8 NONE 2	No parity bit, two stop bits	1
	8 EVEN 1	Even parity indication bit, one stop bit	2
	8 ODD 1	Odd parity indication bit, one stop bit	3
5204	OK MESSAGES	Number of valid messages received by the drive. During normal operation, this number increases constantly.	0
	0...65535	Number of messages	1 = 1
5205	PARITY ERRORS	Number of characters with a parity error received from the Modbus link. If the number is high, check that the parity settings of the devices connected on the bus are the same. Note: High electromagnetic noise levels generate errors.	0
	0...65535	Number of characters	1 = 1
5206	FRAME ERRORS	Number of characters with a framing error received by the Modbus link. If the number is high, check that the communication speed settings of the devices connected on the bus are the same. Note: High electromagnetic noise levels generate errors.	0
	0...65535	Number of characters	1 = 1
5207	BUFFER OVERRUNS	Number of characters which overflow the buffer, i.e. number of characters which exceed the maximum message length, 128 bytes.	0
	0...65535	Number of characters	1 = 1
5208	CRC ERRORS	Number of messages with an CRC (cyclic redundancy check) error received by the drive. If the number is high, check CRC calculation for possible errors. Note: High electromagnetic noise levels generate errors.	0
	0...65535	Number of messages	1 = 1
53 EFB PROTOCOL		Embedded fieldbus link settings. See chapter Fieldbus control with embedded fieldbus .	
5302	EFB STATION ID	Defines the address of the device. Two units with the same address are not allowed on-line.	1
	0...247	Address	1 = 1

Parameters – complete descriptions			
Index	Name/Selection	Description	Def, FbEq
5303	EFB BAUD RATE	Defines the transfer rate of the link.	9.6
	9.6	9.6 kbit/s	1 = 0.1 kbit/s
	19.2	19.2 kbit/s	
	38.4	38.4 kbit/s	
	57.6	57.6 kbit/s	
	115.2	115.2 kbit/s	
5304	EFB PARITY	Defines the use of parity and stop bit(s) and the data length. The same setting must be used in all on-line stations.	8 NONE 1
	8 NONE 1	No parity bit, one stop bit, 8 data bits	0
	8 NONE 2	No parity bit, two stop bits, 8 data bits	1
	8 EVEN 1	Even parity indication bit, one stop bit, 8 data bits	2
	8 ODD 1	Odd parity indication bit, one stop bit, 8 data bits	3
5305	EFB CTRL PROFILE	Selects the communication profile. See section Communication profiles on page 258.	ABB DRV LIM
	ABB DRV LIM	ABB Drive limited profile	0
	DCU PROFILE	DCU profile	1
	ABB DRV FULL	ABB Drives profile	2
5306	EFB OK MESSAGES	Number of valid messages received by the drive. During normal operation, this number increases constantly.	0
	0...65535	Number of messages	1 = 1
5307	EFB CRC ERRORS	Number of messages with an CRC (cyclic redundancy check) error received by the drive. If the number is high, check CRC calculation for possible errors. Note: High electromagnetic noise levels generate errors.	0
	0...65535	Number of messages	1 = 1
5310	EFB PAR 10	Selects an actual value to be mapped to Modbus register 40005.	0
	0...65535	Parameter index	1 = 1
5311	EFB PAR 11	Selects an actual value to be mapped to Modbus register 40006.	0
	0...65535	Parameter index	1 = 1
5312	EFB PAR 12	Selects an actual value to be mapped to Modbus register 40007.	0
	0...65535	Parameter index	1 = 1
5313	EFB PAR 13	Selects an actual value to be mapped to Modbus register 40008.	0
	0...65535	Parameter index	1 = 1
5314	EFB PAR 14	Selects an actual value to be mapped to Modbus register 40009.	0
	0...65535	Parameter index	1 = 1
5315	EFB PAR 15	Selects an actual value to be mapped to Modbus register 40010.	0
	0...65535	Parameter index	1 = 1
5316	EFB PAR 16	Selects an actual value to be mapped to Modbus register 40011.	0
	0...65535	Parameter index	1 = 1
5317	EFB PAR 17	Selects an actual value to be mapped to Modbus register 40012.	0
	0...65535	Parameter index	1 = 1

Parameters – complete descriptions																	
Index	Name/Selection	Description	Def, FbEq														
5318	EFB PAR 18	Reserved	0														
5319	EFB PAR 19	ABB Drives profile (ABB DRV LIM or ABB DRV FULL) Control Word. Read only copy of the Fieldbus Control Word.	0x0000														
	0x0000...0xFFFF (hex)	Control Word															
5320	EFB PAR 20	ABB Drives profile (ABB DRV LIM or ABB DRV FULL) Status Word. Read only copy of the Fieldbus Status Word.	0x0000														
	0x0000...0xFFFF (hex)	Status Word															
54 FBA DATA IN		Data from drive to fieldbus controller via a fieldbus adapter. See chapter Fieldbus control with fieldbus adapter . Note: In adapter module the parameter group number is 3.															
5401	FBA DATA IN 1	Selects data to be transferred from the drive to the fieldbus controller.															
	0	Not in use															
	1...6	Control and status data words <table border="1" style="margin-left: 20px;"> <thead> <tr> <th>5401 setting</th> <th>Data word</th> </tr> </thead> <tbody> <tr> <td>1</td> <td>Control Word</td> </tr> <tr> <td>2</td> <td>REF1</td> </tr> <tr> <td>3</td> <td>REF2</td> </tr> <tr> <td>4</td> <td>Status Word</td> </tr> <tr> <td>5</td> <td>Actual value 1</td> </tr> <tr> <td>6</td> <td>Actual value 2</td> </tr> </tbody> </table>	5401 setting	Data word	1	Control Word	2	REF1	3	REF2	4	Status Word	5	Actual value 1	6	Actual value 2	
5401 setting	Data word																
1	Control Word																
2	REF1																
3	REF2																
4	Status Word																
5	Actual value 1																
6	Actual value 2																
	101...9999	Parameter index															
5402	FBA DATA IN 2	See 5401 FBA DATA IN 1.															
....															
5410	FBA DATA IN 10	See 5401 FBA DATA IN 1.															
55 FBA DATA OUT		Data from fieldbus controller to drive via a fieldbus adapter. See chapter Fieldbus control with fieldbus adapter . Note: In adapter module the parameter group number is 2.															
5501	FBA DATA OUT 1	Selects data to be transferred from the fieldbus controller to the drive.															
	0	Not in use															
	1...6	Control and status data words <table border="1" style="margin-left: 20px;"> <thead> <tr> <th>5501 setting</th> <th>Data word</th> </tr> </thead> <tbody> <tr> <td>1</td> <td>Control Word</td> </tr> <tr> <td>2</td> <td>REF1</td> </tr> <tr> <td>3</td> <td>REF2</td> </tr> <tr> <td>4</td> <td>Status Word</td> </tr> <tr> <td>5</td> <td>Actual value 1</td> </tr> <tr> <td>6</td> <td>Actual value 2</td> </tr> </tbody> </table>	5501 setting	Data word	1	Control Word	2	REF1	3	REF2	4	Status Word	5	Actual value 1	6	Actual value 2	
5501 setting	Data word																
1	Control Word																
2	REF1																
3	REF2																
4	Status Word																
5	Actual value 1																
6	Actual value 2																
	101...9999	Drive parameter															
5502	FBA DATA OUT 2	See 5501 FBA DATA OUT 1.															
...															
5510	FBA DATA OUT 10	See 5501 FBA DATA OUT 1.															

Parameters – complete descriptions			
Index	Name/Selection	Description	Def, FbEq
84	SEQUENCE PROG	Sequence programming. See section Sequence programming on page 133.	
8401	SEQ PROG ENABLE	Enables sequence programming. If sequence programming enable signal is lost, the sequence programming is stopped, sequence programming state (0168 SEQ PROG STATE) is set to 1 and all timers and outputs (RO/TO/AO) are set to zero.	DISABLED
	DISABLED	Disabled	0
	EXT2	Enabled in external control location 2 (EXT2)	1
	EXT1	Enabled in external control location 1 (EXT1)	2
	EXT1&EXT2	Enabled in external control locations 1 and 2 (EXT1 and EXT2)	3
	ALWAYS	Enabled in external control locations 1 and 2 (EXT1 and EXT2) and in local control (LOCAL)	4
8402	SEQ PROG START	Selects the source for the sequence programming activation signal. When sequence programming is activated, the programming starts from the previously used state. If sequence programming activation signal is lost, the sequence programming is stopped and all timers and outputs (RO/TO/AO) are set to zero. Sequence programming state (0168 SEQ PROG STATE) remains unchanged. If start from the first sequence programming state is required, the sequence programming must be reset by parameter 8404 SEQ PROG RESET. If start from the first sequence programming state is always required, reset and start signal sources must be through the same digital input (8404 and 8402 SEQ PROG START). Note: The drive will not start if no Run Enable signal is received (1601 RUN ENABLE).	NOT SEL
	DI1(INV)	Sequence programming activation through inverted digital input DI1. 0 = active, 1 = inactive.	-1
	DI2(INV)	See selection DI1(INV).	-2
	DI3(INV)	See selection DI1(INV).	-3
	DI4(INV)	See selection DI1(INV).	-4
	DI5(INV)	See selection DI1(INV).	-5
	NOT SEL	No sequence programming activation signal	0
	DI1	Sequence programming activation through digital input DI1. 1 = active, 0 = inactive.	1
	DI2	See selection DI1.	2
	DI3	See selection DI1.	3
	DI4	See selection DI1.	4
	DI5	See selection DI1.	5
	DRIVE START	Sequence programming activation at drive start	6
	TIMED FUNC 1	Sequence programming is activated by time function 1. See parameter group 36 TIMED FUNCTIONS .	7
	TIMED FUNC 2	See selection TIMED FUNC 1.	8
	TIMED FUNC 3	See selection TIMED FUNC 1.	9
	TIMED FUNC 4	See selection TIMED FUNC 1.	10
	RUNNING	Sequence programming is always active.	11

Parameters – complete descriptions				
Index	Name/Selection	Description	Def, FbEq	
8403	SEQ PROG PAUSE	Selects the source for the sequence programming pause signal. When sequence programming pause is activated all timers and outputs (RO/TO/AO) are frozen. Sequence programming state transition is possible only by parameter 8405 SEQ ST FORCE.	NOT SEL	
	DI1(INV)	Pause signal through inverted digital input DI1. 0 = active, 1 = inactive.	-1	
	DI2(INV)	See selection DI1(INV).	-2	
	DI3(INV)	See selection DI1(INV).	-3	
	DI4(INV)	See selection DI1(INV).	-4	
	DI5(INV)	See selection DI1(INV).	-5	
	NOT SEL	No pause signal	0	
	DI1	Pause signal through digital input DI1. 1 = active, 0 = inactive.	1	
	DI2	See selection DI1.	2	
	DI3	See selection DI1.	3	
	DI4	See selection DI1.	4	
	DI5	See selection DI1.	5	
	PAUSED	Sequence programming pause enabled	6	
	8404	SEQ PROG RESET	Selects the source for the sequence programming reset signal. Sequence programming state (0168 SEQ PROG STATE) is set to the first state and all timers and outputs (RO/TO/AO) are set to zero. Reset is possible only when sequence programming is stopped.	NOT SEL
		DI1(INV)	Reset through inverted digital input DI1. 0 = active, 1 = inactive.	-1
		DI2(INV)	See selection DI1(INV).	-2
DI3(INV)		See selection DI1(INV).	-3	
DI4(INV)		See selection DI1(INV).	-4	
DI5(INV)		See selection DI1(INV).	-5	
NOT SEL		No reset signal	0	
DI1		Reset through digital input DI1. 1 = active, 0 = inactive.	1	
DI2		See selection DI1.	2	
DI3		See selection DI1.	3	
DI4		See selection DI1.	4	
DI5		See selection DI1.	5	
RESET		Reset. After reset parameter value is automatically set to NOT SEL.	6	
8405		SEQ ST FORCE	Forces the sequence programming to a selected state. Note: State is changed only when sequence programming is paused by parameter 8403 SEQ PROG PAUSE and this parameter is set to the selected state.	STATE1
		STATE 1	State is forced to state 1.	1
		STATE 2	State is forced to state 2.	2
	STATE 3	State is forced to state 3.	3	
	STATE 4	State is forced to state 4.	4	
	STATE 5	State is forced to state 5.	5	
	STATE 6	State is forced to state 6.	6	
	STATE 7	State is forced to state 7.	7	

Parameters – complete descriptions			
Index	Name/Selection	Description	Def, FbEq
	STATE 8	State is forced to state 8.	8
8406	SEQ LOGIC VAL 1	Defines the source for the logic value 1. Logic value 1 is compared to logic value 2 as defined by parameter 8407 SEQ LOGIC OPER 1. Logic operation values are used in state transitions. See parameter 8425 ST1 TRIG TO ST 2 / 8426 ST1 TRIG TO ST N selection LOGIC VAL.	NOT SEL
	DI1(INV)	Logic value 1 through inverted digital input DI1(INV)	-1
	DI2(INV)	See selection DI1(INV).	-2
	DI3(INV)	See selection DI1(INV).	-3
	DI4(INV)	See selection DI1(INV).	-4
	DI5(INV)	See selection DI1(INV).	-5
	NOT SEL	No logic value	0
	DI1	Logic value 1 through digital input DI1	1
	DI2	See selection DI1.	2
	DI3	See selection DI1.	3
	DI4	See selection DI1.	4
	DI5	See selection DI1.	5
	SUPRV1 OVER	Logic value according to supervision parameters 3201 ... 3203 . See parameter group 32 SUPERVISION .	6
	SUPRV2 OVER	Logic value according to supervision parameters 3204 ... 3206 . See parameter group 32 SUPERVISION .	7
	SUPRV3 OVER	Logic value according to supervision parameters 3207 ... 3209 . See parameter group 32 SUPERVISION .	8
	SUPRV1 UNDER	See selection SUPRV 1OVER.	9
	SUPRV2 UNDER	See selection SUPRV 2OVER.	10
	SUPRV3 UNDER	See selection SUPRV 3OVER.	11
	TIMED FUNC 1	Logic value 1 is activated by timed function 1. See parameter group 36 TIMED FUNCTIONS . 1 = timed function active.	12
	TIMED FUNC 2	See selection TIMED FUNC 1.	13
	TIMED FUNC 3	See selection TIMED FUNC 1.	14
	TIMED FUNC 4	See selection TIMED FUNC 1.	15
8407	SEQ LOGIC OPER 1	Selects the operation between logic value 1 and 2. Logic operation values are used in state transitions. See parameter 8425 ST1 TRIG TO ST 2 / 8426 ST1 TRIG TO ST N selection LOGIC VAL.	NOT SEL
	NOT SEL	Logic value 1 (no logic comparison)	0
	AND	Logic function: AND	1
	OR	Logic function: OR	2
	XOR	Logic function: XOR	3
8408	SEQ LOGIC VAL 2	See parameter 8406 SEQ LOGIC VAL 1.	NOT SEL
		See parameter 8406 .	
8409	SEQ LOGIC OPER 2	Selects the operation between logic value 3 and the result of the first logic operation defined by parameter 8407 SEQ LOGIC OPER 1.	NOT SEL
	NOT SEL	Logic value 2 (no logic comparison)	0
	AND	Logic function: AND	1

Parameters – complete descriptions			
Index	Name/Selection	Description	Def, FbEq
	OR	Logic function: OR	2
	XOR	Logic function: XOR	3
8410	SEQ LOGIC VAL 3	See parameter 8406 SEQ LOGIC VAL 1.	NOT SEL
		See parameter 8406 .	
8411	SEQ VAL 1 HIGH	Defines the high limit for the state change when parameter 8425 ST1 TRIG TO ST 2 is set to e.g. AI1 HIGH 1.	0
	0.0...100.0%	Value in percent	1 = 0.1%
8412	SEQ VAL 1 LOW	Defines the low limit for the state change when parameter 8425 ST1 TRIG TO ST 2 is set to e.g. AI1 LOW 1.	0
	0.0...100.0%	Value in percent	1 = 0.1%
8413	SEQ VAL 2 HIGH	Defines the high limit for the state change when parameter 8425 ST1 TRIG TO ST 2 is set to e.g. AI2 HIGH 1.	0
	0.0...100.0%	Value in percent	1 = 0.1%
8414	SEQ VAL 2 LOW	Defines the low limit for the state change when parameter 8425 ST1 TRIG TO ST 2 is set to e.g. AI2 LOW 2.	0
	0.0...100.0%	Value in percent	1 = 0.1%
8415	CYCLE CNT LOC	Activates the cycle counter for sequence programming. Example: When parameter is set to ST6 TO NEXT, the cycle count (0171 SEQ CYCLE CNTR) increases every time the state changes from state 6 to state 7.	NOT SEL
	NOT SEL	Disabled	0
	ST1 TO NEXT	From state 1 to state 2	1
	ST2 TO NEXT	From state 2 to state 3	2
	ST3 TO NEXT	From state 3 to state 4	3
	ST4 TO NEXT	From state 4 to state 5	4
	ST5 TO NEXT	From state 5 to state 6	5
	ST6 TO NEXT	From state 6 to state 7	6
	ST7 TO NEXT	From state 7 to state 8	7
	ST8 TO NEXT	From state 8 to state 1	8
	ST1 TO N	From state 1 to state n. State n is defined by parameter 8427 ST1 STATE N.	9
	ST2 TO N	From state 2 to state n. State n is defined by parameter 8427 ST1 STATE N.	10
	ST3 TO N	From state 3 to state n. State n is defined by parameter 8427 ST1 STATE N.	11
	ST4 TO N	From state 4 to state n. State n is defined by parameter 8427 ST1 STATE N.	12
	ST5 TO N	From state 5 to state n. State n is defined by parameter 8427 ST1 STATE N.	13
	ST6 TO N	From state 6 to state n. State n is defined by parameter 8427 ST1 STATE N.	14
	ST7 TO N	From state 7 to state n. State n is defined by parameter 8427 ST1 STATE N.	15
	ST8 TO N	From state 8 to state n. State n is defined by parameter 8427 ST1 STATE N.	16
8416	CYCLE CNT RST	Selects the source for the cycle counter reset signal (0171 SEQ CYCLE CNTR).	NOT SEL
	DI5(INV)	Reset through inverted digital input DI1(INV). 0 = active, 1 = inactive.	-5
	DI4(INV)	See selection DI1(INV).	-4
	DI3(INV)	See selection DI1(INV).	-3
	DI2(INV)	See selection DI1(INV).	-2

Parameters – complete descriptions			
Index	Name/Selection	Description	Def, FbEq
	DI1(INV)	See selection DI1(INV).	-1
	NOT SEL	No reset signal	0
	DI1	Reset through digital input DI1. 1 = active, 0 = inactive.	1
	DI2	See selection DI1.	2
	DI3	See selection DI1.	3
	DI4	See selection DI1.	4
	DI5	See selection DI1.	5
	STATE 1	Reset during state transition to state 1. Counter is reset, when the state has been reached.	6
	STATE 2	Reset during state transition to state 2. Counter is reset, when the state has been reached.	7
	STATE 3	Reset during state transition to state 3. Counter is reset, when the state has been reached.	8
	STATE 4	Reset during state transition to state 4. Counter is reset, when the state has been reached.	9
	STATE 5	Reset during state transition to state 5. Counter is reset, when the state has been reached.	10
	STATE 6	Reset during state transition to state 6. Counter is reset, when the state has been reached.	11
	STATE 7	Reset during state transition to state 7. Counter is reset, when the state has been reached.	12
	STATE 8	Reset during state transition to state 8. Counter is reset, when the state has been reached.	13
	SEQ PROG RST	Reset signal source defined by parameter 8404 SEQ PROG RESET	14
8420	ST1 REF SEL	Selects the source for the sequence programming state 1 reference. Parameter is used when parameter 1103/1106 REF1/2 SELECT is set to SEQ PROG / AI1+SEQ PROG / AI2+SEQ PROG. Note: Constant speeds in group 12 CONSTANT SPEEDS overwrite the selected sequence programming reference.	0
	COMM	0136 COMM VALUE 2. For scaling, see Fieldbus reference scaling on page 253 .	-1.3
	AI1/AI2	Reference is calculated with the following equation: $REF = AI1(\%) \cdot (50\% / AI2(\%))$	-1.2
	AI1-AI2	Reference is calculated with the following equation: $REF = AI1(\%) + 50\% - AI2(\%)$	-1.1
	AI1*AI2	Reference is calculated with the following equation: $REF = AI1(\%) \cdot (AI2(\%) / 50\%)$	-1.0
	AI1+AI2	Reference is calculated with the following equation: $REF = AI1(\%) + AI2(\%) - 50\%$	-0.9
	DI4U,5D	Digital input 4: Reference increase. Digital input DI5: Reference decrease.	-0.8
	DI3U,4D	Digital input 3: Reference increase. Digital input DI4: Reference decrease.	-0.7
	DI3U,4DR	Digital input 3: Reference increase. Digital input DI4: Reference decrease.	-0.6

Parameters – complete descriptions			
Index	Name/Selection	Description	Def, FbEq
	AI2 JOY	Analog input AI2 as joystick. The minimum input signal runs the motor at the maximum reference in the reverse direction, the maximum input at the maximum reference in the forward direction. Minimum and maximum references are defined by parameters 1104 REF1 MIN and 1105 REF1 MAX. See parameter 1103 REF1 SELECT selection AI1/JOYST for more information.	-0.5
	AI1 JOY	See selection AI2 JOY.	-0.4
	AI2	Analog input AI2	-0.3
	AI1	Analog input AI1	-0.2
	KEYPAD	Control panel	-0.1
	0.0 ... 100.0%	Constant speed	
8421	ST1 COMMANDS	Selects the start, stop and direction for state 1. Parameter 1002 EXT2 COMMANDS must be set to SEQ PROG. Note: If change of direction of rotation is required, parameter 1003 DIRECTION must be set to REQUEST.	DRIVE STOP
	DRIVE STOP	Drive coast or ramps to stop depending on parameter 2102 STOP FUNCTION setting.	0
	START FRW	Rotation of direction is fixed to forward. If the drive is not already running, it is started according to parameter 2101 START FUNCTION settings.	1
	START REV	Rotation of direction is fixed to reverse. If the drive is not already running, it is started according to parameter 2101 START FUNCTION settings.	2
8422	ST1 RAMP	Selects the acceleration/deceleration ramp time for sequence programming state 1, i.e. defines the rate of the reference change.	0
	-0.2/-0.1/ 0.0...1800.0 s	Time When value is set to -0.2 ramp pair 2 is used. Ramp pair 2 is defined by parameters 2205 ... 2207 . When value is set to -0.1 ramp pair 1 is used. Ramp pair 1 is defined by parameters 2202 ... 2204 . With ramp pair 1/2, parameter 2201 ACC/DEC 1/2 SEL must be set to SEQ PROG. See also parameters 2202 ... 2207 .	1 = 0.1 s
8423	ST1 OUT CONTROL	Selects the relay, transistor and analog output control for sequence programming state 1. The relay/transistor output control must be activated by setting parameter 1401 RELAY OUTPUT 1 / 1805 DO SIGNAL to SEQ PROG. Analog output control must be activated by parameter group 15 ANALOGUE OUTPUTS. Analog output control values can be monitored with signal 0170 SEQ PROG AO VAL.	AO=0
	R=0,D=1,AO=0	Relay output is de-energized (opened), transistor output is energized and analog output is cleared.	-0.7
	R=1,D=0,AO=0	Relay output is energized (closed), transistor output is de-energized and analog output is cleared.	-0.6
	R=0,D=0,AO=0	Relay and transistor outputs are de-energized (opened) and analog output value is set to zero.	-0.5
	RO=0,DO=0	Relay and transistor outputs are de-energized (opened) and analog output control is frozen to the previously set value.	-0.4
	RO=1,DO=1	Relay and transistor outputs are energized (closed) and analog output control is frozen to the previously set value.	-0.3

Parameters – complete descriptions			
Index	Name/Selection	Description	Def, FbEq
	DO=1	Transistor output is energized (closed) and relay output is de-energized. Analog output control is frozen to the previously set value.	-0.2
	RO=1	Transistor output is de-energized (opened) and relay output is energized. Analog output control is frozen to the previously set value.	-0.1
	AO=0	Analog output value is set to zero. Relay and transistor outputs are frozen to the previously set value.	0.0
	0.1...100.0%	Value written to signal 0170 SEQ PROG AO VAL. Value can be connected to control analog output AO by setting parameter 1501 AO1 CONTENT SEL value to 170 (i.e. signal 0170 SEQ PROG AO VAL). AO value is frozen to this value until it is zeroed.	
8424	ST1 CHANGE DLY	Defines the delay time for state 1. When delay has elapsed, state transition is allowed. See parameters 8425 ST1 TRIG TO ST 2 and 8426 ST1 TRIG TO ST N.	0
	0.0...6553.5 s	Delay time	1 = 0.1 s
8425	ST1 TRIG TO ST 2	Selects the source for the trigger signal, which changes the state from state 1 to state 2. Note: State change to state N (8426 ST1 TRIG TO ST N) has a higher priority than state change to the next state (8425 ST1 TRIG TO ST 2).	NOT SEL
	DI5(INV)	Trigger through inverted digital input DI5. 0 = active, 1 = inactive.	-5
	DI4(INV)	See selection DI5(INV).	-4
	DI3(INV)	See selection DI5(INV).	-3
	DI2(INV)	See selection DI5(INV).	-2
	DI1(INV)	See selection DI5(INV).	-1
	NOT SEL	No trigger signal. If parameter 8426 ST1 TRIG TO ST N setting is also NOT SEL, the state is frozen and can be reset only with parameter 8402 SEQ PROG START.	0
	DI1	Trigger through digital input DI1. 1 = active, 0 = inactive.	1
	DI2	See selection DI1.	2
	DI3	See selection DI1.	3
	DI4	See selection DI1.	4
	DI5	See selection DI1.	5
	AI 1 LOW 1	State change when AI1 value < par. 8412 SEQ VAL 1 LOW value.	6
	AI 1 HIGH 1	State change when AI1 value > par. 8411 SEQ VAL 1 HIGH value.	7
	AI 2 LOW 1	State change when AI2 value < par. 8412 SEQ VAL 1 LOW value.	8
	AI 2 HIGH 1	State change when AI2 value > par. 8411 SEQ VAL 1 HIGH value.	9
	AI1 OR 2 LO1	State change when AI1 or AI2 value < par. 8412 SEQ VAL 1 LOW value.	10
	AI1LO1AI2HI1	State change when AI1 value < par. 8412 SEQ VAL 1 LOW value and AI2 value > par. 8411 SEQ VAL 1 HIGH value.	11
	AI1LO1 ORDI5	State change when AI1 value < par. 8412 SEQ VAL 1 LOW value or when DI5 is active.	12
	AI2HI1 ORDI5	State change when AI2 value > par. 8411 SEQ VAL 1 HIGH value or when DI5 is active.	13
	AI 1 LOW 2	State change when AI1 value < par. 8414 SEQ VAL 2 LOW value.	14
	AI 1 HIGH 2	State change when AI1 value > par. 8413 SEQ VAL 2 HIGH value.	15
	AI 2 LOW 2	State change when AI2 value < par. 8414 SEQ VAL 2 LOW value.	16

Parameters – complete descriptions			
Index	Name/Selection	Description	Def, FbEq
	AI 2 HIGH 2	State change when AI2 value > par. 8413 SEQ VAL 2 HIGH value.	17
	AI1 OR 2 LO2	State change when AI1 or AI2 value < par. 8414 SEQ VAL 2 LOW value.	18
	AI1LO2AI2HI2	State change when AI1 value < par. 8414 SEQ VAL 2 LOW value and AI2 value > par. 8413 SEQ VAL 2 HIGH value.	19
	AI1LO2 ORDI5	State change when AI1 value < par. 8414 SEQ VAL 2 LOW value or when DI5 is active.	20
	AI2HI2 ORDI5	State change when AI2 value > par. 8413 SEQ VAL 2 HIGH value or when DI5 is active.	21
	TIMED FUNC 1	Trigger with time function 1. See parameter group 36 <i>TIMED FUNCTIONS</i> .	22
	TIMED FUNC 2	See selection TIMED FUNC 1.	23
	TIMED FUNC 3	See selection TIMED FUNC 1.	24
	TIMED FUNC 4	See selection TIMED FUNC 1.	25
	CHANGE DLY	State change after delay time defined by parameter 8424 ST1 CHANGE DLY has elapsed.	26
	DI1 OR DELAY	State change after DI1 activation or after delay time defined by parameter 8424 ST1 CHANGE DLY has elapsed.	27
	DI2 OR DELAY	See selection DI1 OR DELAY.	28
	DI3 OR DELAY	See selection DI1 OR DELAY.	29
	DI4 OR DELAY	See selection DI1 OR DELAY.	30
	DI5 OR DELAY	See selection DI1 OR DELAY.	31
	AI1HI1 ORDLY	State change when AI1 value > par. 8411 SEQ VAL 1 HIGH value or after delay time defined by parameter 8424 ST1 CHANGE DLY has elapsed.	32
	AI2LO1 ORDLY	State change when AI1 value < par. 8412 SEQ VAL 1 LOW value or after delay time defined by parameter 8424 ST1 CHANGE DLY has elapsed.	33
	AI1HI2 ORDLY	State change when AI1 value > par. 8413 SEQ VAL 2 HIGH value or after delay time defined by parameter 8424 ST1 CHANGE DLY has elapsed.	34
	AI2LO2 ORDLY	State change when AI2 value < par. 8414 SEQ VAL 2 LOW value or after delay time defined by parameter 8424 ST1 CHANGE DLY has elapsed.	35
	SUPRV1 OVER	Logic value according to supervision parameters 3201 ... 3203 . See parameter group 32 <i>SUPERVISION</i> .	36
	SUPRV2 OVER	Logic value according to supervision parameters 3204 ... 3206 . See parameter group 32 <i>SUPERVISION</i> .	37
	SUPRV3 OVER	Logic value according to supervision parameters 3207 ... 3209 . See parameter group 32 <i>SUPERVISION</i> .	38
	SUPRV1 UNDER	See selection SUPRV 1 OVER.	39
	SUPRV2 UNDER	See selection SUPRV 2 OVER.	40
	SUPRV3 UNDER	See selection SUPRV 3 OVER.	41
	SPV1OVRORDLY	State change according to supervision parameters 3201 ... 3203 or when delay time defined by parameter 8424 ST1 CHANGE DLY has elapsed. See parameter group 32 <i>SUPERVISION</i> .	42
	SPV2OVRORDLY	State change according to supervision parameters 3204 ... 3206 or when delay time defined by parameter 8424 ST1 CHANGE DLY has elapsed. See parameter group 32 <i>SUPERVISION</i> .	43
	SPV3OVRORDLY	State change according to supervision parameters 3207 ... 3209 or when delay time defined by parameter 8424 ST1 CHANGE DLY has elapsed. See parameter group 32 <i>SUPERVISION</i> .	44

Parameters – complete descriptions			
Index	Name/Selection	Description	Def, FbEq
	SPV1UNDORDLY	See selection SPV1OVRORDLY.	45
	SPV2UNDORDLY	See selection SPV2OVRORDLY.	46
	SPV3UNDORDLY	See selection SPV3UNDORDLY.	47
	CNTR OVER	State change when counter value exceeds the limit defined by par. 1905 COUNTER LIMIT. See parameters 1904...1911.	48
	CNTR UNDER	State change when counter value is below the limit defined by par. 1905 COUNTER LIMIT. See parameters 1904...1911.	49
	LOGIC VAL	State change according to logic operation defined by parameters 8406...8410	50
	ENTER SETPNT	State change when drive output frequency/speed enters the reference area (i.e the difference is less than or equal to 4% of the maximum reference).	51
	AT SETPOINT	State change when drive output frequency/speed equals the reference value (= is within tolerance limits i.e the error is less than or equal to 1% of the maximum reference).	52
	AI1 L1 & DI5	State change when AI1 value < par. 8412 SEQ VAL 1 LOW value and when DI5 is active.	53
	AI2 L2 & DI5	State change when AI1 value < par. 8414 SEQ VAL 2 LOW value and when DI5 is active.	54
	AI1 H1 & DI5	State change when AI1 value > par. 8411 SEQ VAL 1 HIGH value and when DI5 is active.	55
	AI2 H2 & DI5	State change when AI1 value > par. 8413 SEQ VAL 2 HIGH value and when DI5 is active.	56
	AI1 L1 & DI4	State change when AI1 value < par. 8412 SEQ VAL 1 LOW value and when DI4 is active.	57
	AI2 L2 & DI4	State change when AI1 value < par. 8414 SEQ VAL 2 LOW value and when DI4 is active.	58
	AI1 H1 & DI4	State change when AI1 value > par. 8411 SEQ VAL 1 HIGH value and when DI4 is active.	59
	AI2 H2 & DI4	State change when AI1 value > par. 8413 SEQ VAL 2 HIGH value and when DI4 is active.	60
	DLY AND DI1	State change when delay time defined by parameter 8424 ST1 CHANGE DLY has elapsed and DI1 is active.	61
	DLY AND DI2	State change when delay time defined by parameter 8424 ST1 CHANGE DLY has elapsed and DI2 is active.	62
	DLY AND DI3	State change when delay time defined by parameter 8424 ST1 CHANGE DLY has elapsed and DI3 is active.	63
	DLY AND DI4	State change when delay time defined by parameter 8424 ST1 CHANGE DLY has elapsed and DI4 is active.	64
	DLY AND DI5	State change when delay time defined by parameter 8424 ST1 CHANGE DLY has elapsed and DI5 is active.	65
	DLY & AI2 H2	State change when delay time defined by parameter 8424 ST1 CHANGE DLY has elapsed and AI2 value > par. 8413 SEQ VAL 2 HIGH value.	66
	DLY & AI2 L2	State change when delay time defined by parameter 8424 ST1 CHANGE DLY has elapsed and AI2 value < par. 8414 SEQ VAL 2 LOW value.	67
	DLY & AI1 H1	State change when delay time defined by parameter 8424 ST1 CHANGE DLY has elapsed and AI1 value > par. 8411 SEQ VAL 1 HIGH value.	68
	DLY & AI1 L1	State change when delay time defined by parameter 8424 ST1 CHANGE DLY has elapsed and AI1 value < par. 8412 SEQ VAL 1 LOW value.	69

Parameters – complete descriptions			
Index	Name/Selection	Description	Def, FbEq
	COMM VAL1 #0	0135 COMM VALUE 1 bit 0. 1 = state change.	70
	COMM VAL1 #1	0135 COMM VALUE 1 bit 1. 1 = state change.	71
	COMM VAL1 #2	0135 COMM VALUE 1 bit 2. 1 = state change.	72
	COMM VAL1 #3	0135 COMM VALUE 1 bit 3. 1 = state change.	73
	COMM VAL1 #4	0135 COMM VALUE 1 bit 4. 1 = state change.	74
	COMM VAL1 #5	0135 COMM VALUE 1 bit 5. 1 = state change.	75
	COMM VAL1 #6	0135 COMM VALUE 1 bit 6. 1 = state change.	76
	COMM VAL1 #7	0135 COMM VALUE 1 bit 7. 1 = state change.	77
	AI2H2DI4SV10	State change according to supervision parameters 3201...3203 when AI2 value > par. 8413 SEQ VAL 2 HIGH value and DI4 is active.	78
	AI2H2DI5SV10	State change according to supervision parameters 3201...3203 when AI2 value > par. 8413 SEQ VAL 2 HIGH value and DI5 is active.	79
8426	ST1 TRIG TO ST N	Selects the source for the trigger signal, which changes the state from state 1 to state N. State N is defined with parameter 8427 ST1 STATE N. Note: State change to state N (8426 ST1 TRIG TO ST N) has a higher priority than state change to the next state (8425 ST1 TRIG TO ST 2).	NOT SEL
		See parameter 8425 ST1 TRIG TO ST 2.	
8427	ST1 STATE N	Defines the state N. See parameter 8426 ST1 TRIG TO ST N.	STATE 1
	STATE 1	State 1	1
	STATE 2	State 2	2
	STATE 3	State 3	3
	STATE 4	State 4	4
	STATE 5	State 5	5
	STATE 6	State 6	6
	STATE 7	State 7	7
	STATE 8	State 8	8
8430	ST2 REF SEL	See parameters 8420...8427.	
...			
8497	ST8 STATE N		
98 OPTIONS		External serial communication activation	
9802	COMM PROT SEL	Activates the external serial communication and selects the interface.	NOT SEL
	NOT SEL	No communication	0
	STD MODBUS	Embedded fieldbus. Interface: RS-485 provided by optional FMBA-01 Modbus Adapter connected to drive terminal X3. See chapter <i>Fieldbus control with embedded fieldbus</i> .	1
	EXT FBA	The drive communicates via a fieldbus adapter module connected to drive terminal X3. See also parameter group 51 EXT COMM MODULE. See chapter <i>Fieldbus control with fieldbus adapter</i> .	4
	MODBUS RS232	Embedded fieldbus. Interface: RS-232 (i.e. control panel connector). See chapter <i>Fieldbus control with embedded fieldbus</i> .	10

Parameters – complete descriptions			
Index	Name/Selection	Description	Def, FbEq
99	START-UP DATA	Language selection. Definition of motor set-up data.	
9901	LANGUAGE	Selects the display language. Note: With ACS-CP-D assistant control panel, the following languages are available: English (0), Chinese (1) and Korean (2).	ENGLISH
	ENGLISH	British English. Available with ACS-CP-A and ACS-CP-L assistant control panels.	0
	ENGLISH (AM)	American English. Available with ACS-CP-A assistant control panel.	1
	DEUTSCH	German. Available with ACS-CP-A and ACS-CP-L assistant control panels.	2
	ITALIANO	Italian. Available with ACS-CP-A assistant control panel.	3
	ESPAÑOL	Spanish. Available with ACS-CP-A assistant control panel.	4
	PORTUGUES	Portuguese. Available with ACS-CP-A assistant control panel.	5
	NEDERLANDS	Dutch. Available with ACS-CP-A assistant control panel.	6
	FRANCAIS	French. Available with ACS-CP-A assistant control panel.	7
	DANSK	Danish. Available with ACS-CP-A assistant control panel.	8
	SUOMI	Finnish. Available with ACS-CP-A assistant control panel.	9
	SVENSKA	Swedish. Available with ACS-CP-A assistant control panel.	10
	RUSSKI	Russian. Available with ACS-CP-L assistant control panel.	11
	POLSKI	Polish. Available with ACS-CP-L assistant control panel.	12
	TÜRKÇE	Turkish. Available with ACS-CP-L assistant control panel.	13
	CZECH	Czech. Available with ACS-CP-L assistant control panel.	14
	Magyar	Hungarian. Available with ACS-CP-L assistant control panel. Note: This selection will be added later.	
9902	APPLIC MACRO	Selects the application macro. See chapter Application macros .	ABB STANDARD
	ABB STANDARD	Standard macro for constant speed applications	1
	3-WIRE	3-wire macro for constant speed applications	2
	ALTERNATE	Alternate macro for start forward and start reverse applications	3
	MOTOR POT	Motor potentiometer macro for digital signal speed control applications	4
	HAND/AUTO	Hand/Auto macro to be used when two control devices are connected to the drive: - Device 1 communicates through the interface defined by external control location EXT1. - Device 2 communicates through the interface defined by external control location EXT2. EXT1 or EXT2 is active at a time. Switching between EXT1/2 through digital input.	5
	PID CONTROL	PID control. For application in which the drive controls a process value. E.g. pressure control by the drive running the pressure boost pump. Measured pressure and the pressure reference are connected to the drive.	6
	TORQUE CTRL	Torque control macro	8

Parameters – complete descriptions			
Index	Name/Selection	Description	Def, FbEq
	LOAD FD SET	FlashDrop parameter values as defined by the FlashDrop file. Parameter view is selected by parameter 1611 PARAMETER VIEW. FlashDrop is an optional device for fast copying of parameters to unpowered drives. FlashDrop allows easy customisation of the parameter list, e.g. selected parameters can be hidden. For more information, see <i>MFDT-01 FlashDrop User's Manual</i> [3AFE68591074 (English)].	31
	USER S1 LOAD	User 1 macro loaded into use. Before loading, check that the saved parameter settings and the motor model are suitable for the application.	0
	USER S1 SAVE	Save User 1 macro. Stores the current parameter settings and the motor model.	-1
	USER S2 LOAD	User 2 macro loaded into use. Before loading, check that the saved parameter settings and the motor model are suitable for the application.	-2
	USER S2 SAVE	Save User 2 macro. Stores the current parameter settings and the motor model.	-3
	USER S3 LOAD	User 3 macro loaded into use. Before loading, check that the saved parameter settings and the motor model are suitable for the application.	-4
	USER S3 SAVE	Save User 3 macro. Stores the current parameter settings and the motor model.	-5
9904	MOTOR CTRL MODE	Selects the motor control mode.	SCALAR: FREQ
	VECTOR:SPEED	Sensorless vector control mode. Reference 1 = speed reference in rpm. Reference 2 = speed reference in percent. 100% is the absolute maximum speed, equal to the value of parameter 2002 MAXIMUM SPEED (or 2001 MINIMUM SPEED if the absolute value of the minimum speed is greater than the maximum speed value).	1
	VECTOR:TORQ	Vector control mode. Reference 1 = speed reference in rpm. Reference 2 = torque reference in percent. 100% equals nominal torque.	2
	SCALAR:FREQ	Scalar control mode. Reference 1 = frequency reference in Hz. Reference 2 = frequency reference in percent. 100% is the absolute maximum frequency, equal to the value of parameter 2008 MAXIMUM FREQUENCY (or 2007 MINIMUM FREQUENCY if the absolute value of the minimum speed is greater than the maximum speed value).	3

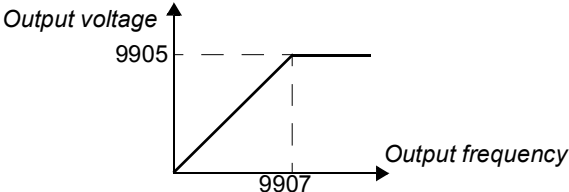
Parameters – complete descriptions			
Index	Name/Selection	Description	Def, FbEq
9905	MOTOR NOM VOLT	<p>Defines the nominal motor voltage. Must be equal to the value on the motor rating plate. The drive cannot supply the motor with a voltage greater than the input power voltage.</p>  <p>WARNING! Never connect a motor to a drive which is connected to power line with voltage level higher than the rated motor voltage.</p>	230 V (200 V units) 400 V (400 V units, Eur) 460 V (400 V units, US)
	115...345 V (200 V units) 200...600 V (400 V units, Eur) 230...690 V (400 V units, US)	Voltage. Note: The stress on the motor insulations is always dependent on the drive supply voltage. This also applies to the case where the motor voltage rating is lower than the rating of the drive and the supply of the drive.	1 = 1 V
9906	MOTOR NOM CURR	Defines the nominal motor current. Must be equal to the value on the motor rating plate.	I_{2N}
	$0.2...2.0 \cdot I_{2N}$	Current	1 = 0.1 A
9907	MOTOR NOM FREQ	<p>Defines the nominal motor frequency, i.e the frequency at which the output voltage equals the motor nominal voltage:</p> <p>Field weakening point = Nom. frequency · Supply voltage / Mot nom. voltage</p>	Eur: 50 / US: 60
	10.0...500.0 Hz	Frequency	1 = 0.1 Hz
9908	MOTOR NOM SPEED	Defines the nominal motor speed. Must be equal to the value on the motor rating plate.	Type dependent
	50...30000 rpm	Speed	1 = 1 rpm
9909	MOTOR NOM POWER	Defines the nominal motor power. Must equal the value on the motor rating plate.	P_N
	$0.2...3.0 \cdot P_N$ kW	Power	1 = 0.1 kW/hp
9910	ID RUN	This parameter controls a self-calibration process called the Motor ID Run. During this process, the drive operates the motor and makes measurements in order to identify motor characteristics and create a model used for internal calculations.	OFF/ IDMAGN
	OFF/IDMAGN	<p>The Motor ID Run process is not run. Identification magnetization is performed, depending on parameter 9904 and 2101 settings. In identification magnetization, the motor model is calculated at first start by magnetizing the motor for 10 to 15 s at zero speed (motor not rotating). The model is recalculated always at start after motor parameter changes.</p> <ul style="list-style-type: none"> - Parameter 9904 = 1 (VECTOR:SPEED) or 2 (VECTOR:TORQ): Identification magnetization is performed. - Parameter 9904 = 3 (SCALAR:FREQ) and parameter 2101 = 3 (SCALAR FLYST) or 5 (FLY + BOOST): Identification magnetization is performed. - Parameter 9904 = 3 (SCALAR:FREQ) and parameter 2101 has other value than 3 (SCALAR FLYST) or 5 (FLY + BOOST): Identification magnetization is not performed. 	0

Parameters – complete descriptions			
Index	Name/Selection	Description	Def, FbEq
	ON	<p>ID Run. Guarantees the best possible control accuracy. The ID Run takes about one minute. An ID Run is especially effective when:</p> <ul style="list-style-type: none"> - vector control mode is used [parameter 9904 = 1 (VECTOR:SPEED) or 2 (VECTOR:TORQ)], and - operation point is near zero speed and/or - operation requires a torque range above the motor nominal torque, over a wide speed range, and without any measured speed feedback (i.e without a pulse encoder). <p>Note: The motor must be de-coupled from the driven equipment.</p> <p>Note: Check the direction of rotation of the motor before starting the ID Run. During the run, the motor will rotate in the forward direction.</p> <p>Note: If motor parameters are changed after ID Run, repeat the ID Run.</p> <p> WARNING! The motor will run at up to approximately 50...80% of the nominal speed during the ID Run. ENSURE THAT IT IS SAFE TO RUN THE MOTOR BEFORE PERFORMING THE ID RUN!</p>	1
9912	MOTOR NOM TORQUE	Calculated motor nominal torque in N·m (calculation is based on parameter 9909 MOTOR NOM POWER and 9908 MOTOR NOM SPEED values).	0
-		Read-only	1 = 0.1 N·m
9913	MOTOR POLE PAIRS	Calculated motor pole pair number (calculation is based on parameter 9907 MOTOR NOM FREQ and 9908 MOTOR NOM SPEED values).	0
-		Read-only	1 = 1

Fieldbus control with embedded fieldbus

What this chapter contains

The chapter describes how the drive can be controlled by external devices over a communication network using embedded fieldbus.

System overview

The drive can be connected to an external control system via a fieldbus adapter or embedded fieldbus. For fieldbus adapter control, see chapter [Fieldbus control with fieldbus adapter](#).

The embedded fieldbus supports Modbus RTU protocol. Modbus is a serial, asynchronous protocol. Transaction is half-duplex.

Embedded fieldbus connection is either RS-232 (control panel connector X2) or RS-485 (terminal X1 of the optional FMBA Modbus Adapter connected to drive terminal X3). The maximum length of the communication cable with RS-232 is restricted to 3 meters. For more information on the FMBA Modbus Adapter module, see *FMBA-01 Modbus Adapter Module User's Manual* [3AFE68586704 (English)].

RS-232 is designed for a point-to-point application (a single master controlling one slave). RS-485 is designed for a multipoint application (a single master controlling one or more slaves).

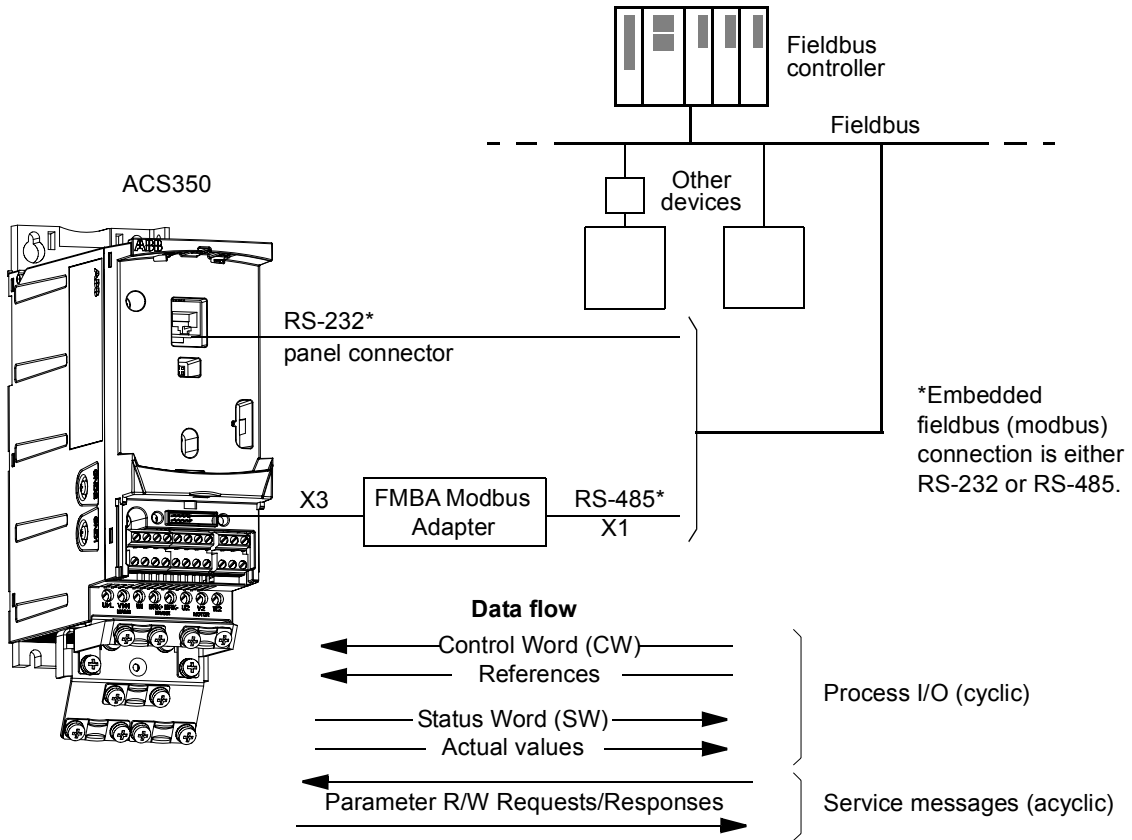

The drive can be set to receive all of its control information through the fieldbus interface, or the control can be distributed between the fieldbus interface and other available sources, e.g. digital and analog inputs.

Setting up communication through the embedded modbus

Before configuring the drive for fieldbus control, the FMBA Modbus adapter (if used) must be mechanically and electrically installed according to the instructions given on page 28 in chapter *Mechanical installation*, and the module manual.

The communication through the fieldbus link is initialised by setting parameter 9802 COMM PROT SEL to STD MODBUS or MODBUS RS232. The communication parameters in group 53 EFB PROTOCOL must also be adjusted. See the table below.

Parameter	Alternative settings	Setting for fieldbus control	Function/Information
COMMUNICATION INITIALISATION			
9802 COMM PROT SEL	NOT SEL STD MODBUS EXT FBA MODBUS RS232	STD MODBUS (with RS-485) MODBUS RS232 (with RS-232)	Initialises embedded fieldbus communication.
ADAPTER MODULE CONFIGURATION			
5302 EFB STATION ID	0...65535	Any	Defines the station ID address of the RS-232/485 link. No two stations on line may have the same address.
5303 EFB BAUD RATE	1.2 kbit/s 2.4 kbit/s 4.8 kbit/s 9.6 kbit/s 19.2 kbit/s 38.4 kbit/s 57.6 kbit/s 76.8 kbit/s		Defines the communication speed of the RS-232/485 link.
5304 EFB PARITY	8 NONE 1 8 NONE 2 8 EVEN 1 8 ODD 1		Selects the parity setting. The same settings must be used in all on-line stations.
5305 EFB CTRL PROFILE	ABB DRV LIM DCU PROFILE ABB DRV FULL	Any	Selects the communication profile used by the drive. See section <i>Communication profiles</i> on page 258.
5310...5317 EFB PAR 10...17	0...65535	Any	Selects an actual value to be mapped to modbus register 400xx.

After the configuration parameters in group 53 EFB PROTOCOL have been set, the *Drive control parameters* on page 246 must be checked and adjusted when necessary.

The new settings will take effect when the drive is next powered up, or when parameter 5302 EFB STATION ID setting is cleared and reset.

Drive control parameters

After the modbus communication has been set up, the drive control parameters listed in the table below should be checked and adjusted when necessary.

The **Setting for fieldbus control** column gives the value to use when the modbus interface is the desired source or destination for that particular signal. The **Function/Information** column gives a description of the parameter.

Parameter	Setting for fieldbus control	Function/Information	Modbus register address	
CONTROL COMMAND SOURCE SELECTION			ABB DRV	DCU
1001 EXT1 COMMANDS	COMM	Enables 0301 FB CMD WORD 1 bits 0...1 (START/STOP) when EXT1 is selected as the active control location.		40031 bits 0...1
1002 EXT2 COMMANDS	COMM	Enables 0301 FB CMD WORD 1 bits 0...1 (START/STOP) when EXT2 is selected as the active control location.		40031 bits 0...1
1003 DIRECTION	FORWARD REVERSE REQUEST	Enables rotation direction control as defined by parameters 1001 and 1002 . The direction control is explained in section Reference handling , on page 254 .		40031 bit 2
1010 JOGGING SEL	COMM	Enables jogging 1 or 2 activation through 0302 FB CMD WORD 2 bits 20 and 21.		40032 bits 20 and 21
1102 EXT1/ EXT2 SEL	COMM	Enables EXT1/EXT2 selection through 0301 FB CMD WORD 1 bit 5 (with ABB Drives profile 5319 EFB PAR 19 bit 11).	40001 bit 11	40031 bit 5
1103 REF1 SELECT	COMM COMM+AI1 COMM*AI1	Fieldbus reference REF1 is used when EXT1 is selected as the active control location. See section Fieldbus references on page 249 for information on the alternative settings.	40002 for REF1	
1106 REF2 SELECT	COMM COMM+AI1 COMM*AI1	Fieldbus reference REF2 is used when EXT2 is selected as the active control location. See section Fieldbus references on page 249 for information on the alternative settings.	40003 for REF2	
OUTPUT SIGNAL SOURCE SELECTION			ABB DRV	DCU
1401 RELAY OUTPUT 1	COMM COMM(-1)	Enables relay output RO control by signal 0134 COMM RO WORD.	40134 for signal 0134	
1501 AO1 CONTENT SEL	135	Directs the contents of fieldbus reference 0135 COMM VALUE 1 to analog output AO.	40135 for signal 0135	
SYSTEM CONTROL INPUTS			ABB DRV	DCU
1601 RUN ENABLE	COMM	Enables the control of the inverted Run Enable signal (Run Disable) through 0301 FB CMD WORD 1 bit 6 (with ABB drives profile 5319 EFB PAR 19 bit 3).	40001 bit 3	40031 bit 6
1604 FAULT RESET SEL	COMM	Enables fault reset through fieldbus 0301 FB CMD WORD 1 bit 4 (with ABB drives profile 5319 EFB PAR 19 bit 7).	40001 bit 7	40031 bit 4
1606 LOCAL LOCK	COMM	Local control mode lock signal through 0301 FB CMD WORD 1 bit 14	-	40031 bit 14
1607 PARAM SAVE	DONE; SAVE	Saves parameter value changes (including those made through fieldbus control) to permanent memory.	41607	

Parameter	Setting for fieldbus control	Function/Information	Modbus register address	
			ABB DRV	DCU
1608 START ENABLE 1	COMM	Inverted Start Enable 1 (Start Disable) through 0302 FB CMD WORD 2 bit 18	-	40032 bit 18
1609 START ENABLE 2	COMM	Inverted Start Enable 2 (Start Disable) through 0302 FB CMD WORD 2 bit 19	-	40032 bit 19
LIMITS			ABB DRV	DCU
2013 MIN TORQUE SEL	COMM	Minimum torque limit 1/2 selection through 0301 FB CMD WORD 1 bit 15	-	40031 bit 15
2014 MAX TORQUE SEL	COMM	Maximum torque limit 1/2 selection through 0301 FB CMD WORD 1 bit 15	-	40031 bit 15
2201 ACC/DEC 1/2 SEL	COMM	ACC/DEC ramp pair selection through 0301 FB CMD WORD 1 bit 10	-	40031 bit 10
2209 RAMP INPUT 0	COMM	Ramp input to zero through 0301 FB CMD WORD 1 bit 13 (with ABB drives profile 5319 EFB PAR 19 bit 6)	40001 bit 6	40031 bit 13
COMMUNICATION FAULT FUNCTIONS			ABB DRV	DCU
3018 COMM FAULT FUNC	NOT SEL FAULT CONST SP 7 LAST SPEED	Determines drive action in case fieldbus communication is lost.	43018	
3019 COMM FAULT TIME	0.1...60.0 s	Defines the time between communication loss detection and the action selected with parameter 3018 COMM FAULT FUNC.	43019	
PID CONTROLLER REFERENCE SIGNAL SOURCE SELECTION			ABB DRV	DCU
4010/4110/ 4210 SET POINT SEL	COMM COMM+AI1 COMM*AI1	PID control reference (REF2)	40003 for REF2	

The fieldbus control interface

The communication between a fieldbus system and the drive consists of 16-bit input and output data words (with ABB Drives profile) and 32-bit input and output words (with DCU profile).

The Control Word and the Status Word

The Control Word (CW) is the principal means of controlling the drive from a fieldbus system. The Control Word is sent by the fieldbus controller to the drive. The drive switches between its states according to the bit-coded instructions of the Control Word.

The Status Word (SW) is a word containing status information, sent by the drive to the fieldbus controller.

References

References (REF) are 16-bit signed integers. A negative reference (e.g. reverse direction of rotation) is formed by calculating the two's complement from the corresponding positive reference value. The contents of each reference word can be used as speed, frequency, torque or process reference.

Actual Values

Actual Values (ACT) are 16-bit words containing selected values of the drive.

Fieldbus references

Reference selection and correction

Fieldbus reference (called COMM in signal selection contexts) is selected by setting a reference selection parameter – [1103](#) or [1106](#) – to COMM, COMM+AI1 or COMM*AI1. When [1103](#) REF1 SELECT or [1106](#) REF2 SELECT is set to COMM, the fieldbus reference is forwarded as such without correction. When parameter [1103](#) or [1106](#) is set to COMM+AI1 or COMM*AI1, the fieldbus reference is corrected using analog input AI1 as shown in the following examples.

Reference correction examples for ABB Drives profile

Setting	When $COMM \geq 0$	When $COMM \leq 0$
COMM+AI1	$COMM(\%) \cdot (MAX-MIN) + MIN + (AI(\%) - 50\%) \cdot (MAX-MIN)$	$COMM(\%) \cdot (MAX-MIN) - MIN + (AI(\%) - 50\%) \cdot (MAX-MIN)$
	<p>Maximum limit is defined by parameter 1105 REF1 MAX / 1108 REF2 MAX. Minimum limit is defined by parameter 1104 REF1 MIN / 1107 REF2 MIN.</p>	

Setting	When $COMM \geq 0$	When $COMM \leq 0$
COMM*AI1	$COMM(\%) \cdot (AI(\%) / 50\%) \cdot (MAX-MIN) + MIN$	$COMM(\%) \cdot (AI(\%) / 50\%) \cdot (MAX-MIN) - MIN$
<p>Maximum limit is defined by parameter 1105 REF1 MAX / 1108 REF2 MAX. Minimum limit is defined by parameter 1104 REF1 MIN / 1107 REF2 MIN.</p>		

Reference correction examples for DCU profile

With DCU profile the fieldbus reference type can be Hz, rpm or percent. In the following examples the reference is in rpm.

Setting	When $COMM \geq 0$ rpm	When $COMM \leq 0$ rpm
COMM+AI1	$COMM/1000 + (AI(\%) - 50\%) \cdot (MAX-MIN)$	$COMM/1000 + (AI(\%) - 50\%) \cdot (MAX-MIN)$
	Maximum limit is defined by parameter 1105 REF1 MAX / 1108 REF2 MAX . Minimum limit is defined by parameter 1104 REF1 MIN / 1107 REF2 MIN .	

Setting	When COMM ≥ 0 rpm	When COMM ≤ 0 rpm
COMM*AI1	$(COMM/1000) \cdot (AI(\%) / 50\%)$	$(COMM(\%)/1000) \cdot (AI(\%) / 50\%)$
<p>Maximum limit is defined by parameter 1105 REF1 MAX / 1108 REF2 MAX. Minimum limit is defined by parameter 1104 REF1 MIN / 1107 REF2 MIN.</p>		

Fieldbus reference scaling

Fieldbus references REF1 and REF2 are scaled as shown in the following tables.

Note: Any correction of the reference (see section [Reference selection and correction](#) on page 253) is applied before scaling.

Fieldbus scaling for ABB Drives profile

Reference	Range	Reference Type	Scaling	Remarks
REF1	-32767 ... +32767	Speed or frequency	-20000 = -(par. 1105) 0 = 0 +20000 = (par. 1105) (20000 corresponds to 100%)	Final reference limited by 1104/1105 . Actual motor speed limited by 2001/2002 (speed) or 2007/2008 (frequency).
REF2	-32767 ... +32767	Speed or frequency	-10000 = -(par. 1108) 0 = 0 +10000 = (par. 1108) (10000 corresponds to 100%)	Final reference limited by 1107/1108 . Actual motor speed limited by 2001/2002 (speed) or 2007/2008 (frequency).
		Torque	-10000 = -(par. 1108) 0 = 0 +10000 = (par. 1108) (10000 corresponds to 100%)	Final reference limited by 2015/2017 (torque1) or 2016/2018 (torque2).
		PID reference	-10000 = -(par. 1108) 0 = 0 +10000 = (par. 1108) (10000 corresponds to 100%)	Final reference limited by 4012/4013 (PID set1) or 4112/4113 (PID set2).

Note: The settings of parameters [1104](#) REF1 MIN and [1107](#) REF2 MIN have no effect on the reference scaling.

Fieldbus scaling for DCU profile

Reference	Range	Reference Type	Scaling	Remarks
REF1	-214783648 ... +214783647	Speed or frequency	1000 = 1 rpm / 1 Hz	Final reference limited by 1104/1105 . Actual motor speed limited by 2001/2002 (speed) or 2007/2008 (frequency).
REF2	-214783648 ... +214783647	Speed or frequency	1000 = 1%	Final reference limited by 1107/1108 . Actual motor speed limited by 2001/2002 (speed) or 2007/2008 (frequency).
		Torque	1000 = 1%	Final reference limited by 2015/2017 (torque1) or 2016/2018 (torque2).
		PID reference	1000 = 1%	Final reference limited by 4012/4013 (PID set1) or 4112/4113 (PID set2).

Note: The settings of parameters [1104](#) REF1 MIN and [1107](#) REF2 MIN have no effect on the reference scaling.

Reference handling

The control of rotation direction is configured for each control location (EXT1 and EXT2) using the parameters in group [10 START/STOP/DIR](#). Fieldbus references are bipolar, i.e. they can be negative or positive. The following diagrams illustrate how group 10 parameters and the sign of the fieldbus reference interact to produce the reference REF1/REF2.

	Direction determined by the sign of COMM	Direction determined by digital command, e.g. digital input, control panel
par. 10.03 DIRECTION = FORWARD	<p>The graph shows the resultant REF1/2 on the vertical axis and Fieldbus Ref. 1/2 on the horizontal axis. The horizontal axis has markers at -163%, -100%, 0, 100%, and 163%. The vertical axis has markers at Max.ref. and -[Max.ref.]. The plot shows a horizontal line at zero for fieldbus references between -100% and 100%. Outside this range, the resultant REF1/2 increases linearly from 0 at 100% to Max.ref. at 163%, and decreases linearly from 0 at -100% to -[Max.ref.] at -163%.</p>	<p>The graph is identical to the one in the 'Direction determined by the sign of COMM' column for the 'DIRECTION = FORWARD' row.</p>
par. 10.03 DIRECTION = REVERSE	<p>The graph shows the resultant REF1/2 on the vertical axis and Fieldbus Ref. 1/2 on the horizontal axis. The horizontal axis has markers at -163%, -100%, 0, 100%, and 163%. The vertical axis has markers at Max.Ref. and -[Max.Ref.]. The plot shows a horizontal line at zero for fieldbus references between -100% and 100%. Outside this range, the resultant REF1/2 decreases linearly from 0 at 100% to -[Max.Ref.] at 163%, and increases linearly from 0 at -100% to Max.Ref. at -163%.</p>	<p>The graph is identical to the one in the 'Direction determined by the sign of COMM' column for the 'DIRECTION = REVERSE' row.</p>
par. 10.03 DIRECTION = REQUEST	<p>The graph is identical to the one in the 'Direction determined by the sign of COMM' column for the 'DIRECTION = FORWARD' row.</p>	<p>The graph is identical to the one in the 'Direction determined by the sign of COMM' column for the 'DIRECTION = FORWARD' row. It includes two additional labels: 'Direction Command: FORWARD' pointing to the upper right quadrant and 'Direction Command: REVERSE' pointing to the lower right quadrant.</p>

Actual value scaling

The scaling of the integers sent to the master as Actual Values depend on the selected function. See chapter [Actual signals and parameters](#).

Modbus mapping

The following modbus function codes are supported by the drive.

Function	Code Hex (dec)	Additional information
Read Multiple Holding Registers	03 (03)	Reads the contents of registers in a slave device. Parameter sets, control, status and reference values are mapped as holding registers.
Write Single Holding Register	06 (06)	Writes to a single register in a slave device. Parameter sets, control, status and reference values are mapped as holding registers.
Diagnostics	08 (08)	Provides a series of tests for checking the communication between the master and the slave devices, or for checking various internal error conditions within the slave. The following subcodes are supported: <u>00 Return Query Data:</u> The data passed in the request data field is to be returned in the response. The entire response message should be identical to the request. <u>01 Restart Communications Option:</u> The slave device serial line port must be initialized and restarted, and all of its communication event counters cleared. If the port is currently in Listen Only Mode, no response is returned. If the port is not currently in Listen Only Mode, a normal response is returned before the restart. <u>04 Force Listen Only Mode:</u> Forces the addressed slave device to Listen Only Mode. This isolates it from the other devices on the network, allowing them to continue communicating without interruption from the addressed remote device. No response is returned. The only function that will be processed after this mode is entered is the Restart Communications Option function (subcode 01).
Write Multiple Holding Registers	10 (16)	Writes to the registers (1 to approximately 120 registers) in a slave device. Parameter sets, control, status and reference values are mapped as holding registers.
Read/Write Multiple Holding Registers	17 (23)	Performs a combination of one read operation and one write operation (function codes 03 and 10) in a single modbus transaction. The write operation is performed before the read operation.

Register mapping

The drive parameters, Control/Status Word, references and actual values are mapped to the area 4xxxx so that:

- 40001...40099 are reserved for drive control/status, reference and actual values.
- 40101...49999 are reserved for drive parameters 0101...9999. (E.g. 40102 is parameter 0102). In this mapping, the thousands and hundreds correspond to the group number, while the tens and ones correspond to the parameter number within a group.

The register addresses that do not correspond with drive parameters are invalid. If there is an attempt to read or write invalid addresses, the modbus interface returns an exception code to the controller. See [Exception codes](#) on page 257.

The following table gives information on the contents of the modbus addresses 40001...40012 and 40031...40034.

Modbus register		Access	Information
40001	Control Word	R/W	Control Word. Supported only by ABB Drives profile, i.e. when 5305 EFB CTRL PROFILE setting is ABB DRV LIM or ABB DRV FULL. Parameter 5319 EFB PAR 19 shows a copy of the Control Word in hexadecimal format.
40002	Reference 1	R/W	External reference REF1. See section Fieldbus references on page 249 .
40003	Reference 2	R/W	External reference REF2. See section Fieldbus references on page 249 .
40004	Status Word	R	Status Word. Supported only by ABB Drives profile, when 5305 EFB CTRL PROFILE setting is ABB DRV LIM or ABB DRV FULL. Parameter 5320 EFB PAR 20 shows a copy of the Control Word in hexadecimal format.
40005 ... 40012	Actual 1...8	R	Actual value 1...8. Use parameter 5310 ... 5317 to selects an actual value to be mapped to modbus register 40005...40012.
40031	Control Word LSW	R/W	0301 FB CMD WORD 1, i.e. the least significant word of the DCU profile 32-bit Control Word. Supported only by DCU profile, i.e. when 5305 EFB CTRL PROFILE setting is DCU PROFILE.
40032	Control Word MSW	R/W	0302 FB CMD WORD 2, i.e. the most significant word of the DCU profile 32-bit Control Word. Supported only by DCU profile, i.e. when 5305 EFB CTRL PROFILE setting is DCU PROFILE.
40033	Status Word LSW	R	0303 FB STS WORD 1, i.e. the least significant word of the DCU profile 32-bit Status Word. Supported only by DCU profile, i.e. when 5305 EFB CTRL PROFILE setting is DCU PROFILE.
40034	ACS350 STATUS WORD MSW	R	0304 FB STS WORD 2, i.e. the most significant word of the DCU profile 32-bit Status Word. Supported only by DCU profile, i.e. when 5305 EFB CTRL PROFILE setting is DCU PROFILE.

Note: Parameter writes through standard Modbus are always volatile i.e. modified values are not automatically stored to permanent memory. Use parameter [1607](#) PARAM SAVE to save all changed values.

Function codes

Supported function codes for the holding 4xxxx register are:

Code Hex (dec)	Function name	Additional information
03 (03)	Read 4X Register	Reads the binary contents of registers (4X references) in a slave device.
06 (06)	Preset single 4X register	Presets a value into a single register (4X reference). When broadcast, the function presets the same register reference in all attached slaves.
10 (16)	Preset multiple 4X registers	Presets values into a sequence of registers (4X references). When broadcast, the function presets the same register references in all attached slaves.
17 (23)	Read/Write 4X registers	Performs a combination of one read operation and one write operation (function codes 03 and 10) in a single modbus transaction. Write operation is performed before the read operation.

Note: In the modbus data message, register 4xxxx is addressed as xxxx -1. For example register 40002 is addressed as 0001.

Exception codes

Exception codes are serial communication responses from the drive. The drive supports the standard Modbus exception codes listed in the following table.

Code	Name	Description
01	Illegal Function	Unsupported command
02	Illegal Data Address	Address does not exist or is read/write protected.
03	Illegal Data Value	Incorrect value for the drive: <ul style="list-style-type: none"> Value is outside minimum or maximum limits. Parameter is read-only. Message is too long. Parameter write is not allowed when start is active. Parameter write is not allowed when factory macro is selected.

Drive parameter [5318](#) EFB PAR 18 holds the most recent exception code.

Communication profiles

The embedded fieldbus supports three communication profiles:

- DCU communication profile
- ABB Drives Limited communication profile
- ABB Drives Full communication profile.

The DCU profile extends the control and status interface to 32 bits, and is the internal interface between the main drive application and the embedded fieldbus environment. The ABB Drives Limited is based on the PROFIBUS interface. ABB Drives Full profile supports two Control Word bits not supported by the ABB DRV LIM implementation.



ABB Drives communication profile

Two implementations of the ABB Drives communication profile are available: ABB Drives Full and ABB Drives Limited. The ABB Drives communication profile is active when parameter **5305** EFB CTRL PROFILE is set to ABB DRV FULL or ABB DRV LIM. The Control Word and Status Word for the profile are described below.

The ABB Drives communication profiles can be used through both EXT1 and EXT2. The Control Word commands are in effect when parameter **1001** EXT1 COMMANDS or **1002** EXT2 COMMANDS (whichever control location is active) is set to COMM.

The following table and the state diagram later in this section describe the Control Word content for the ABB Drives profile. The upper case boldface text refers to the states shown in the following block diagram

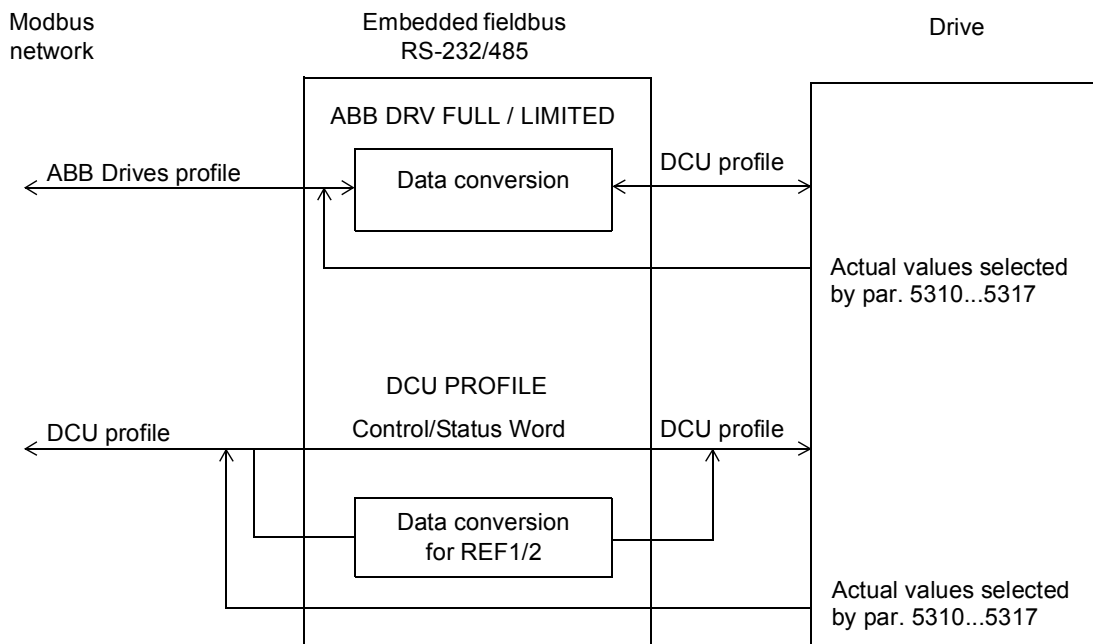
ABB Drives profile Control Word (parameter 5319)			
Bit	Name	Value	Comments
0	OFF1 CONTROL	1	Enter READY TO OPERATE .
		0	Stop along currently active deceleration ramp (2203/2206). Enter OFF1 ACTIVE; proceed to READY TO SWITCH ON unless other interlocks (OFF2, OFF3) are active.
1	OFF2 CONTROL	1	Continue operation (OFF2 inactive).
		0	Emergency OFF, drive coast to stop. Enter OFF2 ACTIVE ; proceed to SWITCH-ON INHIBITED .
2	OFF3 CONTROL	1	Continue operation (OFF3 inactive).
		0	Emergency stop, drive stops within time defined by par. 2208 . Enter OFF3 ACTIVE ; proceed to SWITCH-ON INHIBITED . Warning: Ensure motor and driven machine can be stopped using this stop mode.
3	INHIBIT OPERATION	1	Enter OPERATION ENABLED. (Note: The Run Enable signal must be active; see parameter 1601 . If par. 1601 is set to COMM, this bit also activates the Run Enable signal.)
		0	Inhibit operation. Enter OPERATION INHIBITED .
4	Note: Bit 4 is supported only by ABB DRV FULL profile!		
	RAMP_OUT_ZERO (ABB DRV FULL)	1	Enter RAMP FUNCTION GENERATOR: OUTPUT ENABLED .
5	RAMP_HOLD	0	Force Ramp Function Generator output to zero. Drive ramps to stop (current and DC voltage limits in force).
		1	Enable ramp function. Enter RAMP FUNCTION GENERATOR: ACCELERATOR ENABLED .
6	RAMP_IN_ZERO	0	Halt ramping (Ramp Function Generator output held).
		1	Normal operation. Enter OPERATING .
7	RESET	0=>1	Fault reset if an active fault exists. Enter SWITCH-ON INHIBITED . Effective if par. 1604 is set to COMM.
		0	Continue normal operation.
8...9	Not in use		
10	Note: Bit 10 is supported only by ABB DRV FULL profile!		
	REMOTE_CMD (ABB DRV FULL)	1	Fieldbus control enabled.
11	EXT CTRL LOC	0	Control Word ≠ 0 or Reference ≠ 0: Retain last Control Word and Reference. Control Word = 0 and Reference = 0: Fieldbus control enabled. Reference and deceleration/acceleration ramp are locked.
		1	Select external control location EXT2. Effective if par. 1102 is set to COMM.
12...15	Reserved	0	Select external control location EXT1. Effective if par. 1102 is set to COMM.

The following table and the state diagram later in this section describe the Status Word content for the ABB Drives profile. The upper case boldface text refers to the states shown in the following block diagram

ABB Drives profile (EFB) Status Word (par. 5320)			
Bit	Name	Value	STATE/Description (Correspond to states/boxes in the state diagram)
0	RDY_ON	1	READY TO SWITCH ON
		0	NOT READY TO SWITCH ON
1	RDY_RUN	1	READY TO OPERATE
		0	OFF1 ACTIVE
2	RDY_REF	1	OPERATION ENABLED
		0	OPERATION INHIBITED
3	TRIPPED	0...1	FAULT. See chapter Fault tracing .
		0	No fault
4	OFF_2_STA	1	OFF2 inactive
		0	OFF2 ACTIVE
5	OFF_3_STA	1	OFF3 inactive
		0	OFF3 ACTIVE
6	SWC_ON_INHIB	1	SWITCH-ON INHIBITED
		0	Switch-on inhibit not active
7	ALARM	1	Alarm. See chapter Fault tracing .
		0	No alarm
8	AT_SETPOINT	1	OPERATING. Actual value equals reference value (= is within tolerance limits, i.e in speed control the speed error is less than or equal to 4/1%* of the nominal motor speed). * Asymmetric hysteresis: 4% when speed enters the reference area, 1% when speed exits the reference area.
		0	Actual value differs from reference value (= is outside tolerance limits).
9	REMOTE	1	Drive control location: REMOTE (EXT1 or EXT2)
		0	Drive control location: LOCAL
10	ABOVE_LIMIT	1	Supervised parameter value exceeds the supervision high limit. Bit value is 1 until the supervised parameter value falls below the supervision low limit. See parameter group 32 SUPERVISION .
		0	Supervised parameter value falls below the supervision low limit. Bit value is 0 until the supervised parameter value exceeds the supervision high limit. See parameter group 32 SUPERVISION .
11	EXT CTRL LOC	1	External control location EXT2 selected
		0	External control location EXT1 selected
12	EXT RUN ENABLE	1	External Run Enable signal received
		0	No External Run Enable received
13... 15	Reserved		

The state diagram below describes the start-stop function of Control Word (CW) and Status Word (SW) bits for the ABB Drives profile.

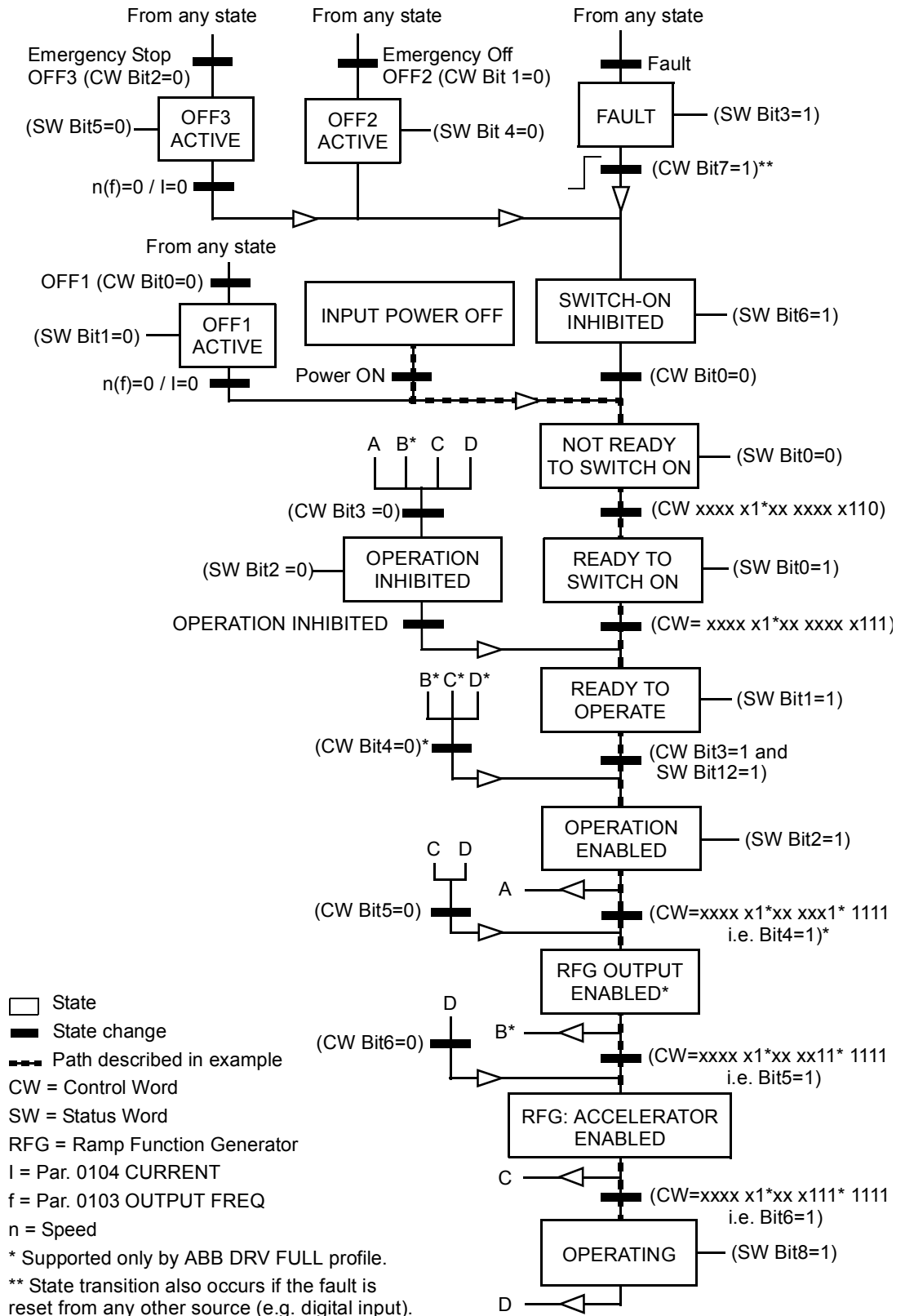

DCU communication profile

Because the DCU profile extends the control and status interface to 32 bits, two different signals are needed for both the control (0301 and 0302) and status (0303 and 0304) words.

The following tables describe the Control Word content for the DCU profile.

DCU Profile Control Word (parameter 0301)			
Bit	Name	Value	Information
0	STOP	1	Stop according to either the stop mode parameter (2102) or the stop mode requests (bits 7 and 8). Note: Simultaneous STOP and START commands result in a stop command.
		0	No operation
1	START	1	Start Note: Simultaneous STOP and START commands result in a stop command.
		0	No operation
2	REVERSE	1	Reverse direction. The direction is defined by using the XOR operation on bit 2 and 31 (=sign of the reference) values.
		0	Forward direction.
3	LOCAL	1	Enter local control mode.
		0	Enter external control mode.
4	RESET	-> 1	Reset.
		other	No operation
5	EXT2	1	Switch to external control EXT2.
		0	Switch to external control EXT1.
6	RUN_DISABLE	1	Activate Run Disable.
		0	Activate Run Enable.
7	STPMODE_R	1	Stop along currently active deceleration ramp (bit 10). Bit 0 value must be 1 (=STOP).
		0	No operation
8	STPMODE_EM	1	Emergency stop. Bit 0 value must be 1 (=STOP).
		0	No operation
9	STPMODE_C	1	Coast to stop. Bit 0 value must be 1 (=STOP).
		0	No operation
10	RAMP_2	1	Use acceleration/deceleration ramp pair 2 (defined by parameters 2205...2207).
		0	Use acceleration/deceleration ramp pair 1 (defined by parameters 2202...2204).
11	RAMP_OUT_0	1	Force ramp output to zero.
		0	No operation
12	RAMP_HOLD	1	Halt ramping (Ramp Function Generator output held).
		0	No operation
13	RAMP_IN_0	1	Force ramp input to zero.
		0	No operation
14	REQ_LOCALLOC	1	Enable local lock. Entering the local control mode is disabled (LOC/REM key of the panel).
		0	No operation
15	TORQLIM2	1	Use minimum/maximum torque limit 2 (defined by parameters 2016 and 2018).
		0	Use minimum/maximum torque limit 1 (defined by parameters 2015 and 2017).

DCU PROFILE Control Word (par. 0302)			
Bit	Name	Value	Information
16	FBLOCAL_CTL	1	Fieldbus local mode for Control Word requested. Example: If the drive is in remote control and the start/stop/direction command source is DI for external control location 1 (EXT1): by setting bit 16 to value 1, the start/stop/direction is controlled by the fieldbus command word.
		0	No fieldbus local mode
17	FBLOCAL_REF	1	Fieldbus local mode Control Word for reference requested. See example in bit 16 FBLOCAL_CTL.
		0	No fieldbus local mode
18	START_DISABLE1	1	No Start Enable
		0	Enable start. Effective if parameter 1608 setting is COMM.
19	START_DISABLE2	1	No Start Enable
		0	Enable start. Effective if parameter 1609 setting is COMM.
20	JOGGING 1	1	Activate jogging 1. Effective if parameter 1010 setting is COMM. See section Jogging on page 129 .
		0	Jogging 1 disabled
21	JOGGING 2	1	Activate jogging 2. Effective if parameter 1010 setting is COMM. See section Jogging on page 129 .
		0	Jogging 2 disabled
22...26	Reserved		
27	REF_CONST	1	Constant speed reference request. This is an internal control bit. Only for supervision.
		0	No operation
28	REF_AVE	1	Average speed reference request. This is an internal control bit. Only for supervision.
		0	No operation
29	LINK_ON	1	Master detected on fieldbus link. This is an internal control bit. Only for supervision.
		0	Fieldbus link is down.
30	REQ_STARTINH	1	Start inhibit
		0	No start inhibit
31	Reserved		

The following tables describe the Status Word content for the DCU profile.

DCU Profile Status Word (par. 0303)			
Bit	Name	Value	Status
0	READY	1	Drive is ready to receive start command.
		0	Drive is not ready.
1	ENABLED	1	External Run Enable signal received.
		0	No external Run Enable signal received.
2	STARTED	1	Drive has received start command.
		0	Drive has not received start command.
3	RUNNING	1	Drive is modulating.
		0	Drive is not modulating.
4	ZERO_SPEED	1	Drive is at zero speed.
		0	Drive has not reached zero speed.
5	ACCELERATE	1	Drive is accelerating.
		0	Drive is not accelerating.
6	DECELERATE	1	Drive is decelerating.
		0	Drive is not decelerating.
7	AT_SETPOINT	1	Drive is at setpoint. Actual value equals reference value (i.e. is within tolerance limits).
		0	Drive has not reached setpoint.
8	LIMIT	1	Operation is limited by group 20 LIMITS settings.
		0	Operation is within group 20 LIMITS settings.
9	SUPERVISION	1	A supervised parameter (group 32 SUPERVISION) is outside its limits.
		0	All supervised parameters are within limits.
10	REV_REF	1	Drive reference is in reverse direction.
		0	Drive reference is in forward direction.
11	REV_ACT	1	Drive is running in reverse direction.
		0	Drive is running in forward direction.
12	PANEL_LOCAL	1	Control is in control panel (or PC tool) local mode.
		0	Control is not in control panel local mode.
13	FIELDBUS_LOCAL	1	Control is in fieldbus local mode
		0	Control is not in fieldbus local mode.
14	EXT2_ACT	1	Control is in EXT2 mode.
		0	Control is in EXT1 mode.
15	FAULT	1	Drive is in a fault state.
		0	Drive is not in a fault state.

DCU Profile Status Word (par. 0304)			
Bit	Name	Value	Status
16	ALARM	1	An alarm is on.
		0	No alarms are on.
17	NOTICE	1	A maintenance request is pending.
		0	No maintenance request
18	DIRLOCK	1	Direction lock is ON. (Direction change is locked.)
		0	Direction lock is OFF.
19	LOCALLOCK	1	Local mode lock is ON. (Local mode is locked.)
		0	Local mode lock is OFF.
20	CTL_MODE	1	Drive is in vector control mode.
		0	Drive is in scalar control mode.
21	JOGGING ACTIVE		Jogging function is active.
22...25	Reserved		
26	REQ_CTL	1	Control Word requested from fieldbus
		0	No operation
27	REQ_REF1	1	Reference 1 requested from fieldbus
		0	Reference 1 is not requested from fieldbus.
28	REQ_REF2	1	Reference 2 requested from fieldbus
		0	Reference 2 is not requested from fieldbus.
29	REQ_REF2EXT	1	External PID reference 2 requested from fieldbus
		0	External PID reference 2 is not requested from fieldbus.
30	ACK_STARTINH	1	Start inhibit from fieldbus
		0	No start inhibit from fieldbus
31	Reserved		

Fieldbus control with fieldbus adapter

What this chapter contains

The chapter describes how the drive can be controlled by external devices over a communication network via fieldbus adapter.

System overview

The drive can be connected to an external control system via a fieldbus adapter or embedded fieldbus. For embedded fieldbus control, see chapter [Fieldbus control with embedded fieldbus](#).

Fieldbus adapter is connected to drive terminal X3.

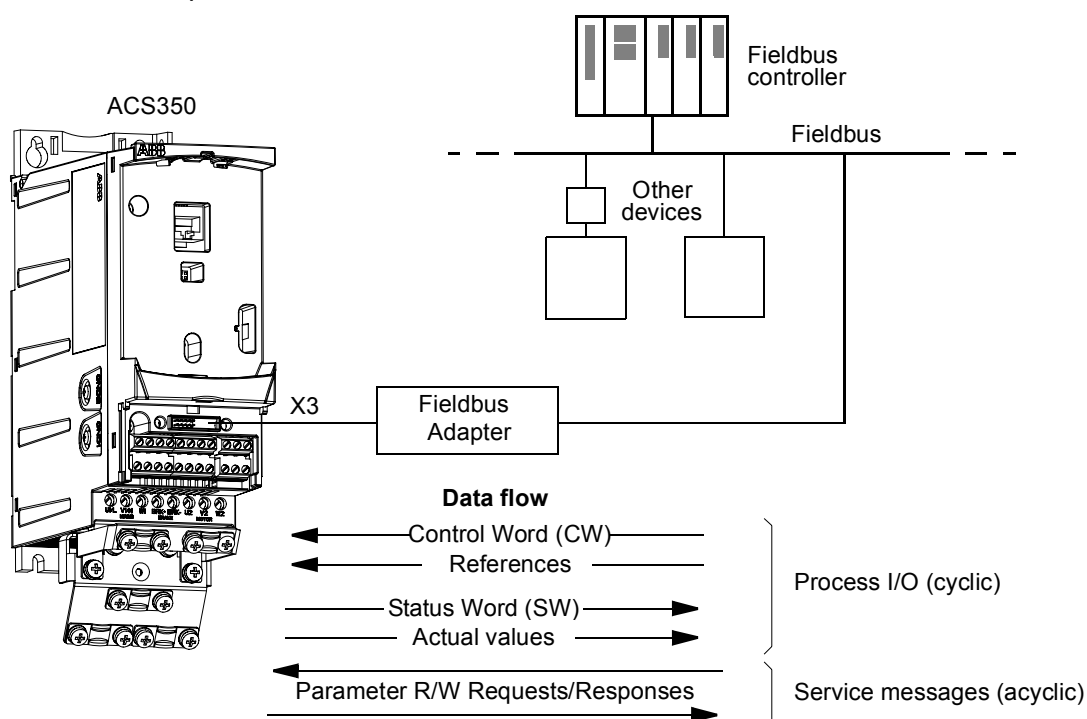

The drive can be set to receive all of its control information through the fieldbus interface, or the control can be distributed between the fieldbus interface and other available sources, e.g. digital and analog inputs

The drive can communicate to a control system via fieldbus adapter using one of the following serial communication protocols:

- PROFIBUS-DP® (FPBA-01 adapter)
- CANopen® (FCAN-01 adapter)
- DeviceNet® (FDNA-01 adapter)
- Modbus® RTU (FMBA-01 adapter. See chapter [Fieldbus control with embedded fieldbus](#).)

The drive detects automatically which fieldbus adapter is connected to drive terminal X3 (exception FMBA-01). DCU profile is always used in communication between the drive and fieldbus adapter (see section [The fieldbus control interface](#) on page 270). The communication profile on the fieldbus network depends on the type of the connected adapter.

The default profile settings are protocol dependent (e.g. vendor specific profile (ABB Drives) for PROFIBUS and industry-standard drive profile (AC/DC Drive) for DeviceNet).

Setting up communication through a fieldbus adapter module

Before configuring the drive for fieldbus control, the adapter module must be mechanically and electrically installed according to the instructions given on page 28 in chapter [Mechanical installation](#), and the module manual.

The communication between the drive and the fieldbus adapter module is activated by setting parameter [9802](#) COMM PROT SEL to EXT FBA. The adapter-specific parameters in group [51 EXT COMM MODULE](#) must also be set. See the table below.

Parameter	Alternative settings	Setting for fieldbus control	Function/Information
COMMUNICATION INITIALISATION			
9802 COMM PROT SEL	NOT SEL STD MODBUS EXT FBA MODBUS RS232	EXT FBA	Initialises communication between drive and fieldbus adapter module.
ADAPTER MODULE CONFIGURATION			
5101 FBA TYPE	–	–	Displays the type of the fieldbus adapter module.
5102 FB PAR 2	These parameters are adapter module-specific. For more information, see the module manual. Note that not all of these parameters are necessarily used.		
...			
5126 FB PAR 26			
5127 FBA PAR REFRESH	(0) DONE; (1) REFRESH	–	Validates any changed adapter module configuration parameter settings.
Note: In adapter module the parameter group number is 1 for 51 EXT COMM MODULE .			
TRANSMITTED DATA SELECTION			
5401...5410 FBA DATA IN 1...10	0 1...6 101...9999		Defines the data transmitted from drive to fieldbus controller.
5501...5510 FBA DATA OUT 1...10	0 1...6 101...9999		Defines the data transmitted from fieldbus controller to drive.
Note: In adapter module the parameter group number is 3 for 54 FBA DATA IN and 2 for 55 FBA DATA OUT .			

After the module configuration parameters in group [51 EXT COMM MODULE](#) have been set, the drive control parameters (shown in section [Drive control parameters](#) on page 269) must be checked and adjusted when necessary.

The new settings will take effect when the drive is next powered up, or when parameter [5127](#) FBA PAR REFRESH is activated.

Drive control parameters

After the fieldbus communication has been set up, the drive control parameters listed in the table below should be checked and adjusted where necessary.

The **Setting for fieldbus control** column gives the value to use when the fieldbus interface is the desired source or destination for that particular signal. The **Function/Information** column gives a description of the parameter.

Parameter	Setting for fieldbus control	Function/Information
CONTROL COMMAND SOURCE SELECTION		
1001 EXT1 COMMANDS	COMM	Selects fieldbus as the source for the start and stop commands when EXT1 is selected as the active control location.
1002 EXT2 COMMANDS	COMM	Selects fieldbus as the source for the start and stop commands when EXT2 is selected as the active control location.
1003 DIRECTION	FORWARD REVERSE REQUEST	Enables rotation direction control as defined by parameters 1001 and 1002 . The direction control is explained in section Reference handling on page 254 .
1010 JOGGING SEL	COMM	Enables jogging 1 or 2 activation through fieldbus.
1102 EXT1/EXT2 SEL	COMM	Enables EXT1/EXT2 selection through fieldbus.
1103 REF1 SELECT	COMM COMM+AI1 COMM*AI1	Fieldbus reference REF1 is used when EXT1 is selected as the active control location. See section Reference selection and correction (for DCU profile) on page 249 .
1106 REF2 SELECT	COMM COMM+AI1 COMM*AI1	Fieldbus reference REF2 is used when EXT2 is selected as the active control location. See section Reference selection and correction (for DCU profile) on page 249 .
OUTPUT SIGNAL SOURCE SELECTION		
1401 RELAY OUTPUT 1	COMM COMM(-1)	Enables relay output RO control by signal 0134 COMM RO WORD.
1501 AO1 CONTENT SEL	135 (i.e 0135 COMM VALUE 1)	Directs the contents of fieldbus reference 0135 COMM VALUE 1 to analog output AO.
SYSTEM CONTROL INPUTS		
1601 RUN ENABLE	COMM	Selects fieldbus interface as the source for the inverted Run Enable signal (Run Disable).
1604 FAULT RESET SEL	COMM	Selects fieldbus interface as the source for the fault reset signal.
1606 LOCAL LOCK	COMM	Selects fieldbus interface as the source for the local lock signal.
1607 PARAM SAVE	DONE; SAVE	Saves parameter value changes (including those made through fieldbus control) to permanent memory.
1608 START ENABLE 1	COMM	Selects fieldbus interface as the source for the inverted Start Enable 1 (Start Disable) signal.
1609 START ENABLE 2	COMM	Selects fieldbus interface as the source for the inverted Start Enable 2 (Start Disable) signal.
LIMITS		
2013 MIN TORQUE SEL	COMM	Selects fieldbus interface as the source for the minimum torque limit 1/2 selection.
2014 MAX TORQUE SEL	COMM	Selects fieldbus interface as the source for the maximum torque limit 1/2 selection.
2201 ACC/DEC 1/2 SEL	COMM	Selects fieldbus interface as the source for acceleration/deceleration ramp pair 1/2 selection
2209 RAMP INPUT 0	COMM	Selects fieldbus interface as the source for forcing ramp input to zero.

Parameter	Setting for fieldbus control	Function/Information
COMMUNICATION FAULT FUNCTIONS		
3018 COMM FAULT FUNC	NOT SEL FAULT CONST SP 7 LAST SPEED	Determines drive action in case fieldbus communication is lost.
3019 COMM FAULT TIME	0.1 ... 60.0 s	Defines the time between communication loss detection and the action selected with parameter 3018 COMM FAULT FUNC.
PID CONTROLLER REFERENCE SIGNAL SOURCE SELECTION		
4010/4110/4210 SET POINT SEL	COMM COMM+AI1 COMM*AI1	PID control reference (REF2)

The fieldbus control interface

The communication between a fieldbus system and the drive consists of 16-bit input and output data words. The drive supports at the maximum the use of 10 data words in each direction.

Data transformed from the drive to the fieldbus controller is defined by parameter group 54 FBA DATA IN and data transformed from the fieldbus controller to the drive is defined by parameter group 55 FBA DATA OUT.

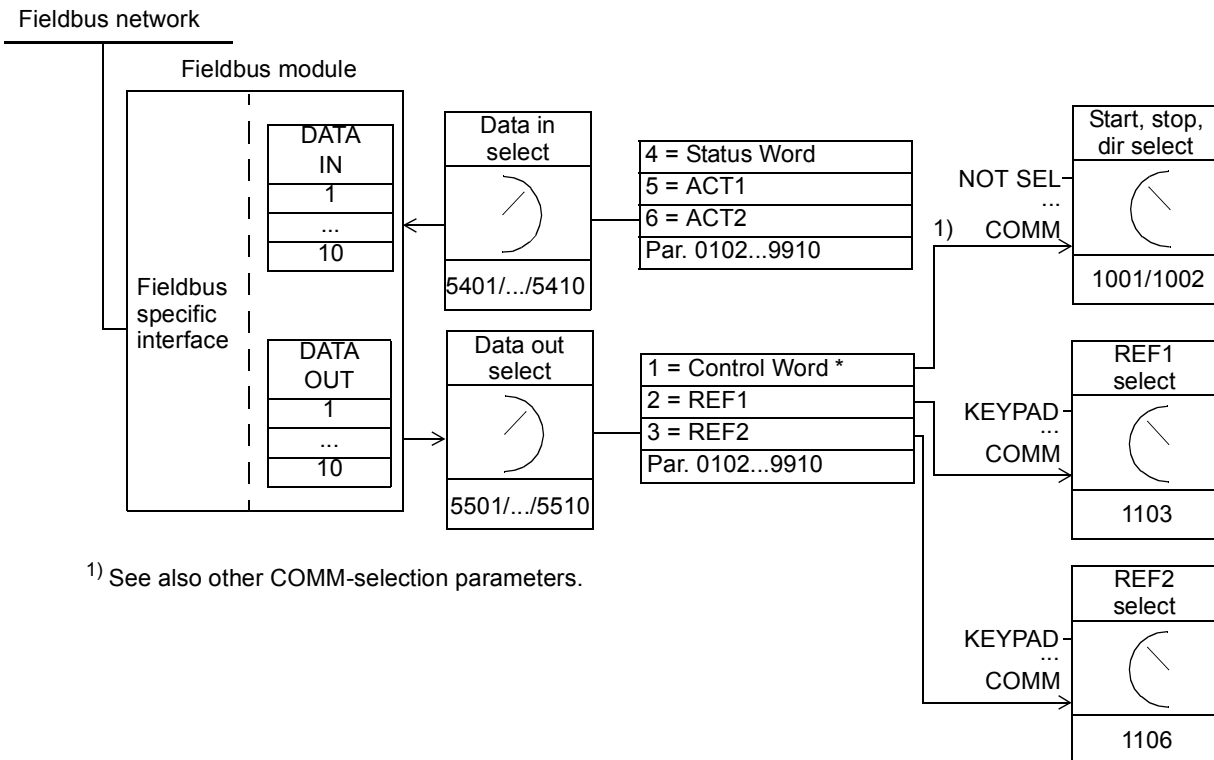

The Control Word and the Status Word

The Control Word (CW) is the principal means of controlling the drive from a fieldbus system. The Control Word is sent by the fieldbus controller to the drive. The drive switches between its states according to the bit-coded instructions of the Control Word.

The Status Word (SW) is a word containing status information, sent by the drive to the fieldbus controller.

References

References (REF) are 16-bit signed integers. A negative reference (indicating reversed direction of rotation) is formed by calculating the two's complement from the corresponding positive reference value. The contents of each reference word can be used, as speed or frequency reference.

Actual Values

Actual Values (ACT) are 16-bit words containing information on selected operations of the drive.

Communication profile

The communication between the drive and the fieldbus adapter supports the DCU communication profile. The DCU profile extends the control and status interface to 32 bits.

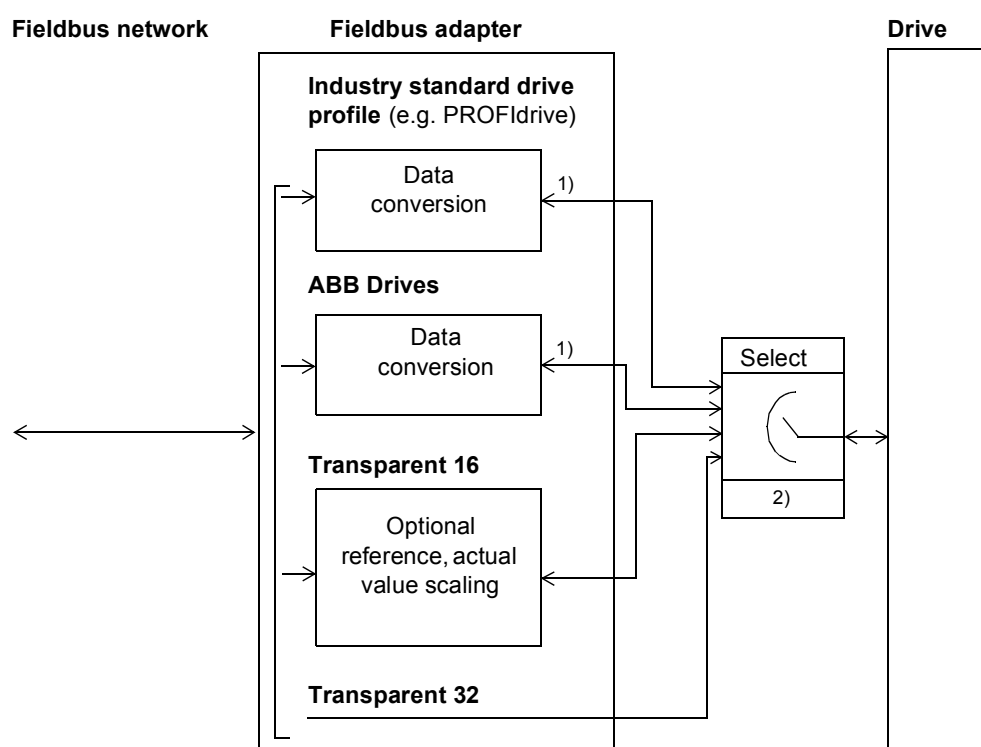

1) DCU profile

2) Selection via fieldbus adapter configuration parameters (parameter group [51 EXT COMM MODULE](#))

For DCU profile Control and Status Word contents, see section [DCU communication profile](#) on page 262.

Fieldbus references

See section [Fieldbus references](#) on page 249 for DCU profile reference selection and correction, reference scaling, reference handling and actual value scaling.

Fault tracing

What this chapter contains

The chapter lists all alarm and fault messages including the possible cause and corrective actions.

Safety



WARNING! Only qualified electricians are allowed to maintain the drive. Read the safety instructions in chapter [Safety](#) on the first pages before you work with the drive.



Alarm and fault indications

Fault is indicated with a red LED. See section [LEDs](#) on page [287](#).

An alarm or fault message on the panel display indicates abnormal drive status. Using the information given in this chapter most alarm and fault causes can be identified and corrected. If not, contact an ABB representative.

The four digit code number in parenthesis after the alarm/fault is for the fieldbus communication. (See chapters [Fieldbus control with embedded fieldbus](#) and [Fieldbus control with fieldbus adapter](#).)

How to reset

The drive can be reset either by pressing the keypad key  (Basic Control Panel) or  (Assistant Control Panel), through digital input or fieldbus, or by switching the supply voltage off for a while. The source for the fault reset signal is selected by parameter [1604](#) FAULT RESET SEL. When the fault has been removed, the motor can be restarted.

Fault history

When a fault is detected, it is stored in the Fault History. The latest faults are stored together with the time stamp.

Parameters [0401](#) LAST FAULT, [0412](#) PREVIOUS FAULT 1 and [0413](#) PREVIOUS FAULT 2 store the most recent faults. Parameters [0404](#)...[0409](#) show drive operation data at the time the latest fault occurred. The Assistant Control Panel provides additional information about the fault history. See section [Fault Logger mode](#) on page [78](#) for more information.

Alarm messages generated by the drive

CODE	ALARM	CAUSE	WHAT TO DO
2001	OVERCURRENT (2310) 0308 bit 0 (programmable fault function 1610)	Output current limit controller is active.	Check motor load. Check acceleration time (2202 and 2205). Check motor and motor cable (including phasing). Check ambient conditions. Load capacity decreases if installation site ambient temperature exceeds 40°C. See section Derating on page 291 .
2002	OVERVOLTAGE (3210) 0308 bit 1 (programmable fault function 1610)	DC overvoltage controller is active.	Check deceleration time (2203 and 2206). Check input power line for static or transient overvoltage.
2003	UNDERVOLTAGE (3220) 0308 bit 2 (programmable fault function 1610)	DC undervoltage controller is active.	Check input power supply.
2004	DIRLOCK 0308 bit 3	Change of direction is not allowed.	Check parameter 1003 DIRECTION settings.
2005	IO COMM (7510) 0308 bit 4 (programmable fault function 3018 , 3019)	Fieldbus communication break	Check status of fieldbus communication. See chapter Fieldbus control with fieldbus adapter/Fieldbus control with embedded fieldbus or appropriate fieldbus adapter manual. Check fault function parameter settings. Check connections. Check if master can communicate.
2006	AI1 LOSS (8110) 0308 bit 5 (programmable fault function 3001 , 3021)	Analog input AI1 signal has fallen below limit defined by parameter 3021 AI1 FAULT LIMIT.	Check fault function parameter settings. Check for proper analog control signal levels. Check connections.
2007	AI2 LOSS (8110) 0308 bit 6 (programmable fault function 3001 , 3022)	Analog input AI2 signal has fallen below limit defined by parameter 3022 AI2 FAULT LIMIT.	Check fault function parameter settings. Check for proper analog control signal levels. Check connections.
2008	PANEL LOSS (5300) 0308 bit 7 (programmable fault function 3002)	Control panel selected as active control location for drive has ceased communicating.	Check panel connection. Check fault function parameters. Check control panel connector. Refit control panel in mounting platform. If drive is external control mode (REM) and is set to accept start/stop, direction commands or references via control panel: Check group 10 START/STOP/DIR and 11 REFERENCE SELECT settings.

CODE	ALARM	CAUSE	WHAT TO DO
2009	DEVICE OVERTEMP (4210) 0308 bit 8	Drive IGBT temperature is excessive. Alarm limit is 120°C.	Check ambient conditions. See also section Derating on page 291 . Check air flow and fan operation. Check motor power against unit power.
2010	MOTOR TEMP (4310) 0305 bit 9 (programmable fault function 3005...3009 / 3503)	Motor temperature is too high (or appears to be too high) due to excessive load, insufficient motor power, inadequate cooling or incorrect start-up data.	Check motor ratings, load and cooling. Check start-up data. Check fault function parameters.
		Measured motor temperature has exceeded alarm limit set by parameter 3503 ALARM LIMIT.	Check value of alarm limit. Check that actual number of sensors corresponds to value set by parameter (3501 SENSOR TYPE). Let motor cool down. Ensure proper motor cooling: Check cooling fan, clean cooling surfaces, etc.
2011	UNDERLOAD (FF6A) 0308 bit 10 (programmable fault function 3013...3015)	Motor load is too low due to e.g. release mechanism in driven equipment.	Check for problem in driven equipment. Check fault function parameters. Check motor power against unit power.
2012	MOTOR STALL (7121) 0308 bit 11 (programmable fault function 3010...3012)	Motor is operating in stall region due to e.g. excessive load or insufficient motor power.	Check motor load and drive ratings. Check fault function parameters.
2013	AUTORESET 0308 bit 12	Automatic reset alarm	Check parameter group 31 AUTOMATIC RESET settings.
2018	PID SLEEP 0309 bit 1	Sleep function has entered sleeping mode.	See parameter groups 40 PROCESS PID SET 1...41 PROCESS PID SET 2 .
2019	ID RUN 0309 bit 2	Motor Identification Run is on.	This alarm belongs to normal start-up procedure. Wait until drive indicates that motor identification is completed.
2021	START ENABLE 1 MISSING 0309 bit 4	No Start Enable 1 signal received	Check parameter 1608 START ENABLE 1 settings. Check digital input connections. Check fieldbus communication settings.
2022	START ENABLE 2 MISSING 0309 bit 5	No Start Enable 2 signal received	Check parameter 1609 START ENABLE 2 settings. Check digital input connections. Check fieldbus communication settings.
2023	EMERGENCY STOP 0309 bit 6	Drive has received emergency stop command and ramps to stop according to ramp time defined by parameter 2208 EMER DEC TIME.	Check that it is safe to continue operation. Return emergency stop push button to normal position.

CODE	ALARM	CAUSE	WHAT TO DO
2024	ENCODER ERR (7301) 0306 bit 6 (programmable fault function 5003)	Communication fault between pulse encoder and pulse encoder interface module or between module and drive.	Check pulse encoder and its wiring, pulse encoder interface module and its wiring and parameter group 50 ENCODER settings.
2025	FIRST START 0309 bit 8	Motor identification magnetisation is on. This alarm belongs to normal start-up procedure.	Wait until drive indicates that motor identification is completed.
2026	INPUT PHASE LOSS (3130) 0306 bit 5 (programmable fault function 3016)	Intermediate circuit DC voltage is oscillating due to missing input power line phase or blown fuse. Alarm is generated when DC voltage ripple exceeds 14% of nominal DC voltage.	Check input power line fuses. Check for input power supply imbalance. Check fault function parameters.

Alarms generated by the Basic Control Panel

The Basic Control Panel indicates Control Panel alarms with a code, A5xxx.

ALARM CODE	CAUSE	WHAT TO DO
5001	Drive is not responding.	Check panel connection.
5002	Incompatible communication profile	Contact your local ABB representative.
5010	Corrupted panel parameter backup file	Retry parameter upload. Retry parameter download.
5011	Drive is controlled from another source.	Change drive control to local control mode.
5012	Direction of rotation is locked.	Enable change of direction. See parameter 1003 DIRECTION.
5013	Panel control is disabled because start inhibit is active.	Deactivate start inhibit and retry. See parameter 2108 START INHIBIT.
5014	Panel control is disabled because of drive fault.	Reset drive fault and retry.
5015	Panel control is disabled because local control mode lock is active.	Deactivate local control mode lock and retry. See parameter 1606 LOCAL LOCK.
5018	Parameter default value is not found.	Contact your local ABB representative.
5019	Writing non-zero parameter value is prohibited.	Only parameter reset is allowed.
5020	Parameter or parameter group does not exist or parameter value is inconsistent.	Contact your local ABB representative.
5021	Parameter or parameter group is hidden.	Contact your local ABB representative.
5022	Parameter is write protected.	Parameter value is read-only and cannot be changed.
5023	Parameter change is not allowed, when drive is running.	Stop drive and change parameter value.
5024	Drive is executing task.	Wait until task is completed.
5025	Software is being uploaded or downloaded.	Wait until upload/download is complete.
5026	Value is at or below minimum limit.	Contact your local ABB representative.
5027	Value is at or above maximum limit.	Contact your local ABB representative.
5028	Invalid value	Contact your local ABB representative.

ALARM CODE	CAUSE	WHAT TO DO
5029	Memory is not ready.	Retry.
5030	Invalid request	Contact your local ABB representative.
5031	Drive is not ready for operation, e.g due to low DC voltage.	Check input power supply.
5032	Parameter error	Contact your local ABB representative.
5040	Parameter download error. Selected parameter set is not in current parameter backup file.	Perform upload function before download.
5041	Parameter backup file does not fit into memory.	Contact your local ABB representative.
5042	Parameter download error. Selected parameter set is not in current parameter backup file.	Perform upload function before download.
5043	No start inhibit	
5044	Parameter backup file restoring error	Check that file is compatible with drive.
5050	Parameter upload aborted	Retry parameter upload.
5051	File error	Contact your local ABB representative.
5052	Parameter upload has failed.	Retry parameter upload.
5060	Parameter download aborted	Retry parameter download.
5062	Parameter download has failed.	Retry parameter download.
5070	Panel backup memory write error	Contact your local ABB representative.
5071	Panel backup memory read error	Contact your local ABB representative.
5080	Operation is not allowed because drive is not in local control mode.	Switch to local control mode.
5081	Operation is not allowed because of active fault.	Check cause of fault and reset fault.
5082	Operation is not allowed because override mode is enabled.	
5083	Operation is not allowed because parameter lock is on.	Check parameter 1602 PARAMETER LOCK setting.
5084	Operation is not allowed because drive is performing task.	Wait until task is completed and retry.
5085	Parameter download from source to destination drive has failed.	Check that source and destination drive types are same, i.e. ACS350. See drive type designation label.
5086	Parameter download from source to destination drive has failed.	Check that source and destination drive type codes are same. See drive type designation label.
5087	Parameter download from source to destination drive has failed because parameter sets are incompatible.	Check that source and destination drive information are same. See parameters in group 33 INFORMATION .
5088	Operation has failed because of drive memory error.	Contact your local ABB representative.
5089	Download has failed because of CRC error.	Contact your local ABB representative.
5090	Download has failed because of data processing error.	Contact your local ABB representative.
5091	Operation has failed because of parameter error.	Contact your local ABB representative.
5092	Parameter download from source to destination drive has failed because parameter sets are incompatible.	Check that source and destination drive information are same. See parameters in group 33 INFORMATION .

Fault messages generated by the drive

CODE	FAULT	CAUSE	WHAT TO DO
0001	OVERCURRENT (2310) 0305 bit 0	Output current has exceeded trip level.	Check motor load. Check acceleration time (2202 and 2205). Check motor and motor cable (including phasing). Check ambient conditions. Load capacity decreases if installation site ambient temperature exceeds 40°C. See section Derating on page 291 .
0002	DC OVERVOLT (3210) 0305 bit 1	Excessive intermediate circuit DC voltage. DC overvoltage trip limit is 420 V for 200 V drives and 840 V for 400 V drives.	Check that overvoltage controller is on (parameter 2005 OVERVOLT CTRL). Check input power line for static or transient overvoltage. Check brake chopper and resistor (if used). DC overvoltage control must be deactivated when brake chopper and resistor is used. Check deceleration time (2203 , 2206). Retrofit frequency converter with brake chopper and brake resistor.
0003	DEV OVERTEMP (4210) 0305 bit 2	Drive IGBT temperature is excessive. Fault trip limit is 135°C.	Check ambient conditions. See also section Derating on page 291 . Check air flow and fan operation. Check motor power against unit power.
0004	SHORT CIRC (2340) 0305 bit 3	Short circuit in motor cable(s) or motor	Check motor and motor cable.
0006	DC UNDERVOLT (3220) 0305 bit 5	Intermediate circuit DC voltage is not sufficient due to missing input power line phase, blown fuse, rectifier bridge internal fault or too low input power.	Check that undervoltage controller is on (parameter 2006 UNDERVOLT CTRL). Check input power supply and fuses.
0007	AI1 LOSS (8110) 0305 bit 6 (programmable fault function 3001 , 3021)	Analog input AI1 signal has fallen below limit defined by parameter 3021 AI1 FAULT LIMIT.	Check fault function parameter settings. Check for proper analog control signal levels. Check connections.
0008	AI2 LOSS (8110) 0305 bit 7 (programmable fault function 3001 , 3022)	Analog input AI2 signal has fallen below limit defined by parameter 3022 AI2 FAULT LIMIT.	Check fault function parameter settings. Check for proper analog control signal levels. Check connections.

CODE	FAULT	CAUSE	WHAT TO DO
0009	MOT OVERTEMP (4310) 0305 bit 8 (programmable fault function 3005...3009 / 3504)	Motor temperature is too high (or appears to be too high) due to excessive load, insufficient motor power, inadequate cooling or incorrect start-up data.	Check motor ratings, load and cooling. Check start-up data. Check fault function parameters.
		Measured motor temperature has exceeded fault limit set by parameter 3504 FAULT LIMIT.	Check value of fault limit. Check that actual number of sensors corresponds to value set by parameter (3501 SENSOR TYPE). Let motor cool down. Ensure proper motor cooling: Check cooling fan, clean cooling surfaces, etc.
0010	PANEL LOSS (5300) 0305 bit 9 (programmable fault function 3002)	Control panel selected as active control location for drive has ceased communicating.	Check panel connection. Check fault function parameters. Check control panel connector. Refit control panel in mounting platform. If drive is external control mode (REM) and is set to accept start/stop, direction commands or references via control panel: Check group 10 START/STOP/DIR and 11 REFERENCE SELECT settings.
0011	ID RUN FAIL (FF84) 0305 bit 10	Motor ID Run is not completed successfully.	Check motor connection. Check start-up data (group 99 START-UP DATA). Check maximum speed (parameter 2002). It should be at least 80% of motor nominal speed (parameter 9908). Ensure ID run has been performed according to instructions in section <i>How to perform the ID Run</i> on page 54.
0012	MOTOR STALL (7121) 0305 bit 11 (programmable fault function 3010...3012)	Motor is operating in stall region due to e.g. excessive load or insufficient motor power.	Check motor load and drive ratings. Check fault function parameters.
0014	EXT FAULT 1 (9000) 0305 bit 13 (programmable fault function 3003)	External fault 1	Check external devices for faults. Check parameter 3003 EXTERNAL FAULT 1 setting.
0015	EXT FAULT 2 (9001) 0305 bit 14 (programmable fault function 3004)	External fault 2	Check external devices for faults. Check parameter 3004 EXTERNAL FAULT 2 setting.
0016	EARTH FAULT (2330) 0305 bit 15 (programmable fault function 3017)	Drive has detected earth (ground) fault in motor or motor cable.	Check motor. Check fault function parameters. Check motor cable. Motor cable length must not exceed maximum specifications. See section <i>Motor connection</i> on page 296.

CODE	FAULT	CAUSE	WHAT TO DO
0017	UNDERLOAD (FF6A) 0306 bit 0 (programmable fault function 3013...3015)	Motor load is too low due to e.g. release mechanism in driven equipment.	Check for problem in driven equipment. Check fault function parameters. Check motor power against unit power.
0018	THERM FAIL (5210) 0306 bit 1	Drive internal fault. Thermistor used for drive internal temperature measurement is open or short-circuited.	Contact your local ABB representative.
0021	CURR MEAS (2211) 0306 bit 4	Drive internal fault. Current measurement is out of range.	Contact your local ABB representative.
0022	SUPPLY PHASE (3130) 0306 bit 5 (programmable fault function 3016)	Intermediate circuit DC voltage is oscillating due to missing input power line phase or blown fuse. Trip occurs when DC voltage ripple exceeds 14% of nominal DC voltage.	Check input power line fuses. Check for input power supply imbalance. Check fault function parameters.
0023	ENCODER ERR (7301) 0306 bit 6 (programmable fault function 5003)	Communication fault between pulse encoder and pulse encoder interface module or between module and drive.	Check pulse encoder and its wiring, pulse encoder interface module and its wiring and parameter group 50 ENCODER settings.
0024	OVERSPEED (7310) 0306 bit 7	Motor is turning faster than highest allowed speed due to incorrectly set minimum/maximum speed, insufficient braking torque or changes in load when using torque reference. Operating range limits are set by parameters 2001 MINIMUM SPEED and 2002 MAXIMUM SPEED (with vector control) or 2007 MINIMUM FREQ and 2008 MAXIMUM FREQ (with scalar control).	Check minimum/maximum speed settings. Check adequacy of motor braking torque. Check applicability of torque control. Check need for brake chopper and resistor(s).
0026	DRIVE ID (5400) 0306 bit 9	Internal drive ID fault	Contact your local ABB representative.
0027	CONFIG FILE (630F) 0306 bit 10	Internal configuration file error	Contact your local ABB representative.

CODE	FAULT	CAUSE	WHAT TO DO
0028	SERIAL 1 ERR (7510) 0306 bit 11 (programmable fault function 3018 , 3019)	Fieldbus communication break	Check status of fieldbus communication. See chapter Fieldbus control with fieldbus adapter/Fieldbus control with embedded fieldbus or appropriate fieldbus adapter manual. Check fault function parameter settings. Check connections. Check if master can communicate.
0030	FORCE TRIP (FF90) 0306 bit 13	Trip command received from fieldbus	See appropriate communication module manual.
0034	MOTOR PHASE (FF56) 0306 bit 14	Motor circuit fault due to missing motor phase or motor thermistor relay (used in motor temperature measurement) fault.	Check motor and motor cable. Check motor thermistor relay (if used).
0035	OUTP WIRING (FF95) 0306 bit 15 (programmable fault function 3023)	Incorrect input power and motor cable connection (i.e. input power cable is connected to drive motor connection).	Check input power connections. Check fault function parameters.
0036	INCOMPATIBLE SW (630F) 0307 bit 3	Loaded software is not compatible.	Contact your local ABB representative.
0101	SERF CORRUPT (FF55) 0307 bit 14	Drive internal error	Write down fault code and contact your local ABB representative.
0103	SERF MACRO (FF55) 0307 bit 14		
0201	DSP T1 OVERLOAD (6100) 0307 bit 13		
0202	DSP T2 OVERLOAD (6100) 0307 bit 13		
0203	DSP T3 OVERLOAD (6100) 0307 bit 13		
0204	DSP STACK ERROR (6100) 0307 bit 12		
0206	MMIO ID ERROR (5000) 0307 bit 11		

CODE	FAULT	CAUSE	WHAT TO DO
1000	PAR HZRPM (6320) <i>0307</i> bit 15	Incorrect speed/frequency limit parameter setting	Check parameter settings. Check that following applies: <i>2001</i> < <i>2002</i> , <i>2007</i> < <i>2008</i> , <i>2001/9908</i> , <i>2002/9908</i> , <i>2007/9907</i> and <i>2008/9907</i> are within range.
1003	PAR AI SCALE (6320) <i>0307</i> bit 15	Incorrect analog input AI signal scaling	Check parameter group <i>13 ANALOGUE INPUTS</i> settings. Check that following applies: <i>1301</i> < <i>1302</i> , <i>1304</i> < <i>1305</i> .
1004	PAR AO SCALE (6320) <i>0307</i> bit 15	Incorrect analog output AO signal scaling	Check parameter group <i>15 ANALOGUE OUTPUTS</i> settings. Check that following applies: <i>1504</i> < <i>1505</i> .
1005	PAR PCU 2 (6320) <i>0307</i> bit 15	Incorrect motor nominal power setting	Check parameter <i>9909</i> setting. Following must apply: $1.1 < (9906 \text{ MOTOR NOM CURR} \cdot 9905 \text{ MOTOR NOM VOLT} \cdot 1.73 / P_N) < 3.0$ Where $P_N = 1000 \cdot 9909 \text{ MOTOR NOM POWER}$ (if units are in kW) or $P_N = 746 \cdot 9909 \text{ MOTOR NOM POWER}$ (if units are in HP).
1007	PAR FBUSMISS (6320) <i>0307</i> bit 15	Fieldbus control has not been activated.	Check fieldbus parameter settings. See chapter <i>Fieldbus control with fieldbus adapter</i> .
1009	PAR PCU 1 (6320) <i>0307</i> bit 15	Incorrect motor nominal speed/frequency setting	Check parameter settings. Following must apply: $1 < (60 \cdot 9907 \text{ MOTOR NOM FREQ} / 9908 \text{ MOTOR NOM SPEED}) < 16$ $0.8 < 9908 \text{ MOTOR NOM SPEED} / (120 \cdot 9907 \text{ MOTOR NOM FREQ} / \text{Motor poles}) < 0.992$
1015	PAR CUSTOM U/F (6320) <i>0307</i> bit 15	Incorrect voltage to frequency (U/f) ratio voltage setting.	Check parameter <i>2610...2617</i> settings.
1017	PAR SETUP 1 (6320) <i>0307</i> bit 15	It is not allowed to use MTAC encoder module, frequency input signal and frequency output signal simultaneously.	Disable frequency output, frequency input or encoder: - change transistor output to digital mode (value of parameter <i>1804</i> = DIGITAL), or - change frequency input selection to other value in parameter groups <i>11 REFERENCE SELECT</i> , <i>40 PROCESS PID SET 1</i> , <i>41 PROCESS PID SET 2</i> and <i>42 EXT / TRIM PID</i> , or - disable (parameter <i>5002</i>) and remove MTAC encoder module.

Embedded fieldbus faults

Embedded fieldbus faults can be traced by monitoring group [53 EFB PROTOCOL](#) parameters. See also fault/alarm [SERIAL 1 ERR](#).

No master device

If there is no master device on line, parameter [5306](#) EFB OK MESSAGES and [5307](#) EFB CRC ERRORS values remain unchanged.

What to do:

- Check that the network master is connected and properly configured.
- Check the cable connection.

Same device address

If two or more devices have the same address, parameter [5307](#) EFB CRC ERRORS value increases with every read/write command.

What to do:

- Check the device addresses. No two devices on line may have the same address.

Incorrect wiring

If the communication wires are swapped (terminal A on one device is connected to terminal B on another device), parameter [5306](#) EFB OK MESSAGES value remains unchanged and parameter [5307](#) EFB CRC ERRORS increases.

What to do:

- Check the RS-232/485 interface connection.

Maintenance and hardware diagnostics

What this chapter contains

The chapter contains preventive maintenance instructions and LED indicator descriptions.

Safety



WARNING! Read the instructions in chapter [Safety](#) on the first pages of this manual before performing any maintenance on the equipment. Ignoring the safety instructions can cause injury or death.

Maintenance intervals

If installed in an appropriate environment, the drive requires very little maintenance. The table lists the routine maintenance intervals recommended by ABB.

Maintenance	Interval	Instruction
Reforming of capacitors	Every two years when stored	See Capacitors on page 286.
Cooling fan replacement (frame sizes R1...R4)	Every three years	See Fan on page 285.
Replacement of the battery in the Assistant Control Panel	Every ten years	See Battery on page 287.

Fan

The drive's cooling fan has a life span of minimum 25 000 operating hours. The actual life span depends on the drive usage and ambient temperature.

When the Assistant Control Panel is in use, the Notice Handler Assistant informs when the definable value of the operating hour counter is reached (see parameter [2901](#)). This information can also be passed to the relay output (see parameter [1401](#)) regardless of the used panel type.

Fan failure can be predicted by the increasing noise from the fan bearings. If the drive is operated in a critical part of a process, fan replacement is recommended once these symptoms start appearing. Replacement fans are available from ABB. Do not use other than ABB specified spare parts.

Fan replacement (R1...R4)

Only frame sizes R1...R4 include a fan; frame size R0 has natural cooling.

1. Stop the drive and disconnect it from the AC power source.
2. Remove the hood if the drive has the NEMA 1 option.
3. Lever the fan holder off the drive frame with e.g. a screwdriver and lift the hinged fan holder slightly upward from its front edge.
4. Free the fan cable from the clip.
5. Disconnect the fan cable.
6. Remove the fan holder from the hinges.
7. Install the new fan holder including the fan in reverse order.
8. Restore power.

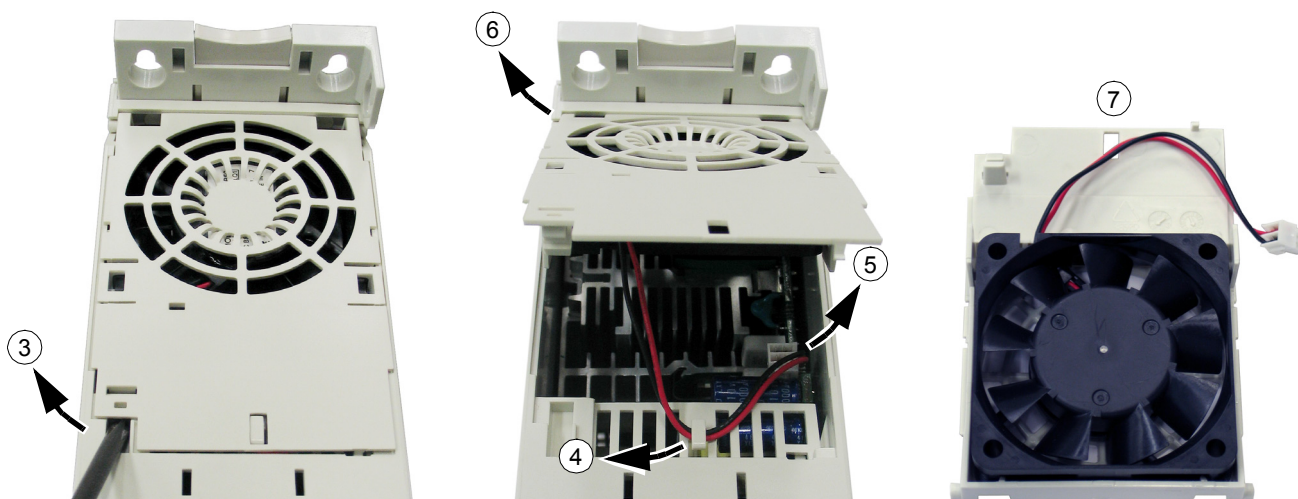

Capacitors

Reforming

The capacitors must be reformed if the drive has been stored for two years. See the table on page 26 for how to find out the manufacturing time from the serial number. For information on reforming the capacitors, refer to *Guide for Capacitor Reforming in ACS50/150/350/550* [3AFE68735190 (English)], available on the Internet (go to <http://www.abb.com> and enter the code in the Search field).

Control panel

Cleaning

Use a soft damp cloth to clean the control panel. Avoid harsh cleaners which could scratch the display window.

Battery

A battery is only used in Assistant Control Panels that have the clock function available and enabled. The battery keeps the clock operating in memory during power interruptions.

The expected life for the battery is greater than ten years. To remove the battery, use a coin to rotate the battery holder on the back of the control panel. Replace the battery with type CR2032.

Note: The battery is NOT required for any control panel or drive functions, except the clock.

LEDs

There is a green and a red LED on the front of the drive. They are visible through the panel cover but invisible if a control panel is attached to the drive. The Assistant Control Panel has one LED. The table below describes the LED indications.

Where	LED off	LED lit and steady		LED blinking	
On the front of the drive. If a control panel is attached to the drive, switch to remote control (otherwise a fault will be generated), and then remove the panel to be able to see the LEDs.	No power	Green	Power supply on the board OK	Green	Drive in an alarm state
		Red	Drive in a fault state. To reset the fault, press RESET from the control panel or switch off the drive power.	Red	Drive in a fault state. To reset the fault, switch off the drive power.
At the top left corner of the Assistant Control Panel	Panel has no power or no drive connection.	Green	Drive in a normal state	Green	Drive in an alarm state
		Red	Drive in a fault state. To reset the fault, press RESET from the control panel or switch off the drive power.	Red	-

Technical data

What this chapter contains

The chapter contains the technical specifications of the drive, e.g. the ratings, sizes and technical requirements as well as provisions for fulfilling the requirements for CE and other marks.

Ratings

Current and power

The current and power ratings are given below. The symbols are described below the table.

Type ACS350- x = E/U ¹⁾	Input I_{1N} A	Output				P_N		Frame size
		I_{2N} A	$I_{2,1min/10min}$ A	I_{2max} A	kW			
1-phase $U_N = 200...240$ V (200, 208, 220, 230, 240 V)								
01x-02A4-2	6.1	2.4	3.6	4.2	0.37	0.5	R0	
01x-04A7-2	11.4	4.7	7.1	8.2	0.75	1	R1	
01x-06A7-2	16.1	6.7	10.1	11.7	1.1	1.5	R1	
01x-07A5-2	16.8	7.5	11.3	13.1	1.5	2	R2	
01x-09A8-2	21.0	9.8	14.7	17.2	2.2	3	R2	
3-phase $U_N = 200...240$ V (200, 208, 220, 230, 240 V)								
03x-02A4-2	4.3	2.4	3.6	4.2	0.37	0.5	R0	
03x-03A5-2	6.1	3.5	5.3	6.1	0.55	0.75	R0	
03x-04A7-2	7.6	4.7	7.1	8.2	0.75	1	R1	
03x-06A7-2	11.8	6.7	10.1	11.7	1.1	1.5	R1	
03x-07A5-2	12.0	7.5	11.3	13.1	1.5	2	R1	
03x-09A8-2	14.3	9.8	14.7	17.2	2.2	3	R2	
03x-13A3-2	21.7	13.3	20.0	23.3	3	3	R2	
03x-17A6-2	24.8	17.6	26.4	30.8	4	5	R2	
03x-24A4-2	41	24.4	36.6	42.7	5.5	7.5	R3	
03x-31A0-2	50	31	46.5	54.3	7.5	10	R4	
03x-46A2-2	69	46.2	69.3 ²⁾	80.9	11.0	15	R4	
3-phase $U_N = 380...480$ V (380, 400, 415, 440, 460, 480 V)								
03x-01A2-4	2.2	1.2	1.8	2.1	0.37	0.5	R0	
03x-01A9-4	3.6	1.9	2.9	3.3	0.55	0.75	R0	
03x-02A4-4	4.1	2.4	3.6	4.2	0.75	1	R1	
03x-03A3-4	6.0	3.3	5.0	5.8	1.1	1.5	R1	
03x-04A1-4	6.9	4.1	6.2	7.2	1.5	2	R1	
03x-05A6-4	9.6	5.6	8.4	9.8	2.2	3	R1	
03x-07A3-4	11.6	7.3	11.0	12.8	3	3	R1	
03x-08A8-4	13.6	8.8	13.2	15.4	4	5	R1	
03x-12A5-4	18.8	12.5	18.8	21.9	5.5	7.5	R3	
03x-15A6-4	22.1	15.6	23.4	27.3	7.5	10	R3	
03x-23A1-4	30.9	23.1	34.7	40.4	11	15	R3	
03x-31A0-4	52	31	46.5	54.3	15	20	R4	
03x-38A0-4	61	38	57	66.5	18.5	25	R4	
03x-44A0-4	67	44	66 ²⁾	77.0	22.0	30	R4	

00353783.xls G

¹⁾ E = EMC filter connected, U = EMC filter disconnected. Metal EMC filter screw is installed in "E" versions and plastic screw in "U" versions.

²⁾ Preliminary value

Symbols

Input	
I_{1N}	continuous rms input current (for dimensioning cables and fuses)
Output	
I_{2N}	continuous rms current. 50% overload is allowed for one minute every ten minutes.
$I_{2,1min/10min}$	maximum (50% overload) current allowed for one minute every ten minutes
I_{2max}	maximum output current. Available for two seconds at start, otherwise as long as allowed by the drive temperature.
P_N	typical motor power. The kilowatt ratings apply to most IEC 4-pole motors. The horsepower ratings apply to most NEMA 4-pole motors.

Sizing

The current ratings are the same regardless of the supply voltage within one voltage range. To achieve the rated motor power given in the table, the rated current of the drive must be higher than or equal to the rated motor current.

Note 1: The maximum allowed motor shaft power is limited to $1.5 \cdot P_N$. If the limit is exceeded, motor torque and current are automatically restricted. The function protects the input bridge of the drive against overload.

Note 2: The ratings apply at ambient temperature of 40°C (104°F).

Derating

The load capacity decreases if the installation site ambient temperature exceeds 40°C (104°F) or if the altitude exceeds 1000 meters (3300 ft).

Temperature derating

In the temperature range +40°C...+50°C (+104°F...+122°F), the rated output current is decreased by 1% for every additional 1°C (1.8°F). The output current is calculated by multiplying the current given in the rating table by the derating factor.

Example If the ambient temperature is 50°C (+122°F), the derating factor is $100\% - 1 \frac{\%}{^{\circ}\text{C}} \cdot 10^{\circ}\text{C} = 90\%$ or 0.90. The output current is then $0.90 \cdot I_{2N}$.

Altitude derating

In altitudes 1000...2000 m (3300...6600 ft) above sea level, the derating is 1% for every 100 m (330 ft).

Switching frequency derating

Derate according to the switching frequency used (see parameter [2606](#)) as follows:

Switching frequency	Drive voltage rating	
	$U_N = 200...240 \text{ V}$	$U_N = 380...480 \text{ V}$
4 kHz	No derating	No derating
8 kHz	Derate I_{2N} to 90%.	Derate I_{2N} to 75% for R0 or to 80% for R1...R4.
12 kHz	Derate I_{2N} to 80%.	Derate I_{2N} to 50% for R0 or to 65% for R1...R4 and derate maximum ambient temperature to 30°C (86°F).
16 kHz	Derate I_{2N} to 75%.	Derate I_{2N} to 50% and derate maximum ambient temperature to 30°C (86°F).

Ensure that parameter [2607](#) SWITCH FREQ CTRL = 1 (ON), which reduces the switching frequency if the drive's internal temperature is too high. See parameter [2607](#) for details.

Cooling air flow requirements

The table below specifies the heat dissipation in the main circuit at nominal load and in the control circuit with minimum load (I/O and panel not in use) and maximum load (all digital inputs in the on state and the panel, fieldbus and fan in use). The total heat dissipation is the sum of the heat dissipation in the main and control circuits.

Type	Heat dissipation						Air flow		
	Main circuit		Control circuit						
	x = E/U	Rated I_{1N} and I_{2N}		Min		Max		m ³ /h	ft ³ /min
	W	BTU/Hr	W	BTU/Hr	W	BTU/Hr			
1-phase $U_N = 200...240$ V (200, 208, 220, 230, 240 V)									
01x-02A4-2	25	85	6.1	21	22.7	78	-	-	
01x-04A7-2	46	157	9.5	32	26.4	90	24	14	
01x-06A7-2	71	242	9.5	32	26.4	90	24	14	
01x-07A5-2	73	249	10.5	36	27.5	94	21	12	
01x-09A8-2	96	328	10.5	36	27.5	94	21	12	
3-phase $U_N = 200...240$ V (200, 208, 220, 230, 240 V)									
03x-02A4-2	19	65	6.1	21	22.7	78	-	-	
03x-03A5-2	31	106	6.1	21	22.7	78	-	-	
03x-04A7-2	38	130	9.5	32	26.4	90	24	14	
03x-06A7-2	60	205	9.5	32	26.4	90	24	14	
03x-07A5-2	62	212	9.5	32	26.4	90	21	12	
03x-09A8-2	83	283	10.5	36	27.5	94	21	12	
03x-13A3-2	112	383	10.5	36	27.5	94	52	31	
03x-17A6-2	152	519	10.5	36	27.5	94	52	31	
03x-24A4-2	250	854	16.6	57	35.4	121	71	42	
03x-31A0-2	270	922	33.4	114	57.8	197	96	57	
03x-46A2-2	430	1469	33.4	114	57.8	197	96	57	
3-phase $U_N = 380...480$ V (380, 400, 415, 440, 460, 480 V)									
03x-01A2-4	11	38	6.6	23	24.4	83	-	-	
03x-01A9-4	16	55	6.6	23	24.4	83	-	-	
03x-02A4-4	21	72	9.8	33	28.7	98	13	8	
03x-03A3-4	31	106	9.8	33	28.7	98	13	8	
03x-04A1-4	40	137	9.8	33	28.7	98	13	8	
03x-05A6-4	61	208	9.8	33	28.7	98	19	11	
03x-07A3-4	74	253	14.1	48	32.7	112	24	14	
03x-08A8-4	94	321	14.1	48	32.7	112	24	14	
03x-12A5-4	130	444	12.0	41	31.2	107	52	31	
03x-15A6-4	173	591	12.0	41	31.2	107	52	31	
03x-23A1-4	266	908	16.6	57	35.4	121	71	42	
03x-31A0-4	350	1195	33.4	114	57.8	197	96	57	
03x-38A0-4	440	1503	33.4	114	57.8	197	96	57	
03x-44A0-4	530	1810	33.4	114	57.8	197	96	57	

00353783.xls G

Power cable sizes and fuses

Cable dimensioning for rated currents (I_{1N}) is shown in the table below together with the corresponding fuse types for short-circuit protection of the input power cable.

The rated fuse currents given in the table are the maxima for the mentioned fuse types. If smaller fuse ratings are used, check that the fuse rms current rating is larger than the rated I_{1N} current given in the rating table on page 290. If 150% output power is needed, multiply current I_{1N} by 1.5. See also section [Selecting the power cables](#) on page 32.

Check that the operating time of the fuse is below 0.5 seconds. The operating time depends on the fuse type, the supply network impedance as well as the cross-sectional area, material and length of the supply cable. In case the 0.5 seconds operating time is exceeded with the gG or T fuses, ultra rapid (aR) fuses will in most cases reduce the operating time to an acceptable level.

Note: Larger fuses must not be used.

Type ACS350- x = E/U	Fuses		Size of CU conductor in cablings							
	gG	UL Class T (600 V)	Supply (U1, V1, W1)		Motor (U2, V2, W2)		PE		Brake (BRK+ and BRK-)	
	A	A	mm ²	AWG	mm ²	AWG	mm ²	AWG	mm ²	AWG
1-phase $U_N = 200...240$ V (200, 208, 220, 230, 240 V)										
01x-02A4-2	10	10	2.5	14	0.75	18	2.5	14	2.5	14
01x-04A7-2	16	20	2.5	14	0.75	18	2.5	14	2.5	14
01x-06A7-2	16/20 ¹⁾	25	2.5	10	1.5	14	2.5	10	2.5	12
01x-07A5-2	20/25 ¹⁾	30	2.5	10	1.5	14	2.5	10	2.5	12
01x-09A8-2	25/35 ¹⁾	35	6	10	2.5	12	6	10	6	12
3-phase $U_N = 200...240$ V (200, 208, 220, 230, 240 V)										
03x-02A4-2	10	10	2.5	14	0.75	18	2.5	14	2.5	14
03x-03A5-2	10	10	2.5	14	0.75	18	2.5	14	2.5	14
03x-04A7-2	10	15	2.5	14	0.75	18	2.5	14	2.5	14
03x-06A7-2	16	15	2.5	12	1.5	14	2.5	12	2.5	12
03x-07A5-2	16	15	2.5	12	1.5	14	2.5	12	2.5	12
03x-09A8-2	16	20	2.5	12	2.5	12	2.5	12	2.5	12
03x-13A3-2	25	30	6	10	6	10	6	10	2.5	12
03x-17A6-2	25	35	6	10	6	10	6	10	2.5	12
03x-24A4-2	63	60	10	8	10	8	10	8	6	10
03x-31A0-2	80	80	16	6	16	6	16	6	10	8
03x-46A2-2	100	100	25	2	25	2	16	4	10	8
3-phase $U_N = 380...480$ V (380, 400, 415, 440, 460, 480 V)										
03x-01A2-4	10	10	2.5	14	0.75	18	2.5	14	2.5	14
03x-01A9-4	10	10	2.5	14	0.75	18	2.5	14	2.5	14
03x-02A4-4	10	10	2.5	14	0.75	18	2.5	14	2.5	14
03x-03A3-4	10	10	2.5	12	0.75	18	2.5	12	2.5	12
03x-04A1-4	16	15	2.5	12	0.75	18	2.5	12	2.5	12
03x-05A6-4	16	15	2.5	12	1.5	14	2.5	12	2.5	12
03x-07A3-4	16	20	2.5	12	1.5	14	2.5	12	2.5	12
03x-08A8-4	20	25	2.5	12	2.5	12	2.5	12	2.5	12
03x-12A5-4	25	30	6	10	6	10	6	10	2.5	12
03x-15A6-4	35	35	6	8	6	8	6	8	2.5	12
03x-23A1-4	50	50	10	8	10	8	10	8	6	10
03x-31A0-4	80	80	16	6	16	6	16	6	10	8
03x-38A0-4	100	100	16	4	16	4	16	4	10	8
03x-44A0-4	100	100	25	4	25	4	16	4	10	8

00353783.xls H

¹⁾ If 50% overload capacity is needed, use the bigger fuse alternative.

Power cables: terminal sizes, maximum cable diameters and tightening torques

Frame size	Max cable diameter for NEMA 1				U1, V1, W1, U2, V2, W2, BRK+ and BRK-				PE			
	U1, V1, W1, U2, V2, W2		BRK+ and BRK-		Terminal size		Tightening torque		Clamp size		Tightening torque	
	mm	in.	mm	in.	mm ²	AWG	N·m	lbf in.	mm ²	AWG	N·m	lbf in.
R0	16	0.63	16	0.63	4.0/6.0	10	0.8	7	25	3	1.2	11
R1	16	0.63	16	0.63	4.0/6.0	10	0.8	7	25	3	1.2	11
R2	16	0.63	16	0.63	4.0/6.0	10	0.8	7	25	3	1.2	11
R3	29	1.14	16	0.63	10.0/16.0	6	1.7	15	25	3	1.2	11
R4	35	1.38	29	1.14	25.0/35.0	2	2.5	22	25	3	1.2	11

00353783.xls G

Dimensions, weights and noise

Frame size	Dimensions and weights												Noise
	IP20 (cabinet) / UL open												
	H1		H2		H3		W		D		Weight		Noise level
mm	in.	mm	in.	mm	in.	mm	in.	mm	in.	kg	lb	dBA	
R0	169	6.65	202	7.95	239	9.41	70	2.76	161	6.34	1.2	2.6	<30
R1	169	6.65	202	7.95	239	9.41	70	2.76	161	6.34	1.2	2.6	50...62
R2	169	6.65	202	7.95	239	9.41	105	4.13	165	6.50	1.5	3.3	50...62
R3	169	6.65	202	7.95	236	9.29	169	6.65	169	6.65	2.5	5.5	50...62
R4	181	7.13	202	7.95	244	9.61	260	10.24	169	6.65	4.4	9.7	<62

00353783.xls G

Frame size	Dimensions and weights										Noise
	IP20 / NEMA 1										
	H4		H5		W		D		Weight		Noise level
mm	in.	mm	in.	mm	in.	mm	in.	kg	lb	dBA	
R0	257	10.12	280	11.02	70	2.76	169	6.65	1.6	3.5	<30
R1	257	10.12	280	11.02	70	2.76	169	6.65	1.6	3.5	50...62
R2	257	10.12	282	11.10	105	4.13	169	6.65	1.9	4.2	50...62
R3	260	10.24	299	11.77	169	6.65	177	6.97	3.1	6.8	50...62
R4	270	10.63	320	12.60	260	10.24	177	6.97	5.0	11.0	<62

00353783.xls G

Symbols

IP20 (cabinet) / UL open

H1 height without fastenings and clamping plate

H2 height with fastenings, without clamping plate

H3 height with fastenings and clamping plate

IP20 / NEMA 1

H4 height with fastenings and connection box

H5 height with fastenings, connection box and hood

Input power connection

Voltage (U_1)	200/208/220/230/240 VAC 1-phase for 200 VAC drives 200/208/220/230/240 VAC 3-phase for 200 VAC drives 380/400/415/440/460/480 VAC 3-phase for 400 VAC drives $\pm 10\%$ variation from converter nominal voltage is allowed as default.
Short-circuit capacity	Maximum allowed prospective short-circuit current at the input power connection as defined in IEC 60439-1 is 100 kA. The drive is suitable for use in a circuit capable of delivering not more than 100 kA rms symmetrical amperes at the drive maximum rated voltage.
Frequency	50/60 Hz $\pm 5\%$, maximum rate of change 17%/s
Imbalance	Max. $\pm 3\%$ of nominal phase to phase input voltage
Fundamental power factor ($\cos \phi_1$)	0.98 (at nominal load)

Motor connection

Voltage (U_2)	0 to U_1 , 3-phase symmetrical, U_{\max} at the field weakening point
Short-circuit protection (IEC 61800-5-1, UL 508C)	The motor output is short-circuit proof by IEC 61800-5-1 and UL 508C.
Frequency	Vector control: 0...max. 150 Hz recommended Scalar control: 0...500 Hz
Frequency resolution	0.01 Hz
Current	See section Ratings on page 290.
Power limit	$1.5 \cdot P_N$
Field weakening point	10...500 Hz
Switching frequency	4, 8, 12 or 16 kHz (in scalar control mode)
Speed control	See section Speed control performance figures on page 114.
Torque control	See section Torque control performance figures on page 114.
Maximum recommended motor cable length	R0: 30 m (100 ft), R1...R4: 50 m (165 ft) With output chokes the motor cable length may be extended to 60 m (195 ft) for R0 and 100 m (330 ft) for R1...R4. To comply with the European EMC Directive, use the cable lengths specified in the table below for 4 kHz switching frequency. The lengths are given for using the drive with the internal EMC filter or an optional external EMC filter.

4 kHz switching frequency	Internal EMC filter	Optional external EMC filter
Second environment (category C3¹⁾)	30 m (100 ft)	30 m (100 ft) minimum
First environment (category C2¹⁾)	-	30 m (100 ft)

¹⁾ See the new terms in section [IEC/EN 61800-3 \(2004\) Definitions](#) on page 301.

Control connections

Analog inputs X1A: 2 and 5	Voltage signal, unipolar	0 (2)...10 V, $R_{in} > 312 \text{ kohm}$
	bipolar	-10...10 V, $R_{in} > 312 \text{ kohm}$
	Current signal, unipolar	0 (4)...20 mA, $R_{in} = 100 \text{ ohm}$
	bipolar	-20...20 mA, $R_{in} = 100 \text{ ohm}$
	Potentiometer reference value (X1A: 4)	10 V \pm 1%, max. 10 mA, $R < 10 \text{ kohm}$
	Resolution	0.1%
	Accuracy	\pm 1%
Analog output X1A: 7		0 (4)...20 mA, load $< 500 \text{ ohm}$
Auxiliary voltage X1A: 9		24 VDC \pm 10%, max. 200 mA
Digital inputs X1A: 12...16 (frequency input X1A: 16)	Voltage	12...24 VDC with internal or external supply
	Type	PNP and NPN
	Frequency input	Pulse train 0...16 kHz (X1A: 16 only)
	Input impedance	2.4 kohm
Relay output X1B: 17...19	Type	NO + NC
	Max. switching voltage	250 VAC / 30 VDC
	Max. switching current	0.5 A / 30 VDC; 5 A / 230 VAC
	Max. continuous current	2 A rms
Digital output X1B: 20...21	Type	Transistor output PNP
	Max. switching voltage	30 VDC
	Max. switching current	100 mA / 30 VDC, short-circuit protected
	Frequency	10 Hz ... 16 kHz
	Resolution	1 Hz
	Accuracy	0.2%
Wire size		1.5...0.25 mm ² 16...24 AWG
Torque		0.5 N·m / 4.4 lbf in.

Brake resistor connection

Short-circuit protection (IEC 61800-5-1, IEC 60439-1, UL 508C)	The brake resistor output is conditionally short-circuit proof by IEC/EN 61800-5-1 and UL 508C. For correct fuse selection, contact your local ABB representative. Rated conditional short-circuit current as defined in IEC 60439-1 and the Short-circuit test current by UL 508C is 100 kA.
---	---

Efficiency

Approximately 95 to 98% at nominal power level, depending on the drive size and options

Cooling

Method	R0: Natural convection cooling. R1...R4: Internal fan, flow direction from bottom to top.
Free space around the drive	See chapter Mechanical installation , page 26.

Degrees of protection

IP20 (cabinet installation) / UL open: Standard enclosure. The drive must be installed in a cabinet to fulfil the requirements for shielding from contact.

IP20 / NEMA 1: Achieved with an option kit including a hood and a connection box.

Ambient conditions

Environmental limits for the drive are given below. The drive is to be used in a heated indoor controlled environment.

	Operation installed for stationary use	Storage in the protective package	Transportation in the protective package
Installation site altitude	0 to 2000 m (6600 ft) above sea level [above 1000 m (3300 ft), see section Derating on page 291]	-	-
Air temperature	-10 to +50°C (14 to 122°F). No frost allowed. See section Derating on page 291.	-40 to +70°C (-40 to +158°F)	-40 to +70°C (-40 to +158°F)
Relative humidity	0 to 95%	Max. 95%	Max. 95%
	No condensation allowed. Maximum allowed relative humidity is 60% in the presence of corrosive gases.		
Contamination levels (IEC 60721-3-3, IEC 60721-3-2, IEC 60721-3-1)	No conductive dust allowed.		
	According to IEC 60721-3-3, chemical gases: Class 3C2 solid particles: Class 3S2. The ACS350 must be installed in clean air according to enclosure classification. Cooling air must be clean, free from corrosive materials and electrically conductive dust.	According to IEC 60721-3-1, chemical gases: Class 1C2 solid particles: Class 1S2	According to IEC 60721-3-2, chemical gases: Class 2C2 solid particles: Class 2S2
Sinusoidal vibration (IEC 60721-3-3)	Tested according to IEC 60721-3-3, mechanical conditions: Class 3M4 2...9 Hz, 3.0 mm (0.12 in.) 9...200 Hz, 10 m/s ² (33 ft/s ²)	-	-
Shock (IEC 60068-2-27, ISTA 1A)	-	According to ISTA 1A. Max. 100 m/s ² (330 ft/s ²), 11 ms.	According to ISTA 1A. Max. 100 m/s ² (330 ft/s ²), 11 ms.
Free fall	Not allowed	76 cm (30 in.)	76 cm (30 in.)

Materials

Drive enclosure

- PC/ABS 2 mm, PC+10%GF 2.5...3 mm and PA66+25%GF 1.5 mm, all in color NCS 1502-Y (RAL 9002 / PMS 420 C)
- hot-dip zinc coated steel sheet 1.5 mm, thickness of coating 20 micrometers
- extruded aluminium AlSi.

Package

Corrugated cardboard.

Disposal

The drive contains raw materials that should be recycled to preserve energy and natural resources. The package materials are environmentally compatible and recyclable. All metal parts can be recycled. The plastic parts can either be recycled or burned under controlled circumstances, according to local regulations. Most recyclable parts are marked with recycling marks.

If recycling is not feasible, all parts excluding electrolytic capacitors and printed circuit boards can be landfilled. The DC capacitors contain electrolyte, which is classified as hazardous waste within the EU. They must be removed and handled according to local regulations.

For further information on environmental aspects and more detailed recycling instructions, please contact your local ABB distributor.

Applicable standards

- IEC/EN 61800-5-1 (2003) The drive complies with the following standards:
Electrical, thermal and functional safety requirements for adjustable frequency a.c. power drives
- IEC/EN 60204-1 (1997) +
Amendment A1 (1999) Safety of machinery. Electrical equipment of machines. Part 1: General requirements.
Provisions for compliance: The final assembler of the machine is responsible for installing
- an emergency-stop device
- a supply disconnecting device.
- IEC/EN 61800-3 (2004) Adjustable speed electrical power drive systems. Part 3: EMC requirements and specific
test methods
- UL 508C UL Standard for Safety, Power Conversion Equipment, third edition

CE marking

The CE mark is attached to the drive to verify that the drive follows the provisions of the European Low Voltage and EMC Directives (Directive 73/23/EEC, as amended by 93/68/EEC, and Directive 89/336/EEC, as amended by 93/68/EEC).

Compliance with the EMC Directive

The EMC Directive defines the requirements for immunity and emissions of electrical equipment used within the European Union. The EMC product standard [EN 61800-3 (2004)] covers requirements stated for drives.

Compliance with EN 61800-3 (2004)

See page [301](#).

C-Tick marking

See the type designation label for the valid markings of your drive.

C-Tick marking is required in Australia and New Zealand. A C-Tick mark is attached to the drive to verify compliance with the relevant standard (IEC 61800-3 (2004) – Adjustable speed electrical power drive systems – Part 3: EMC product standard including specific test methods), mandated by the Trans-Tasman Electromagnetic Compatibility Scheme.

The Trans-Tasman Electromagnetic Compatibility Scheme (EMCS) was introduced by the Australian Communication Authority (ACA) and the Radio Spectrum Management Group (RSM) of the New Zealand Ministry of Economic Development (NZMED) in November 2001. The aim of the scheme is to protect the radio frequency spectrum by introducing technical limits for emission from electrical/electronic products.

Compliance with IEC 61800-3 (2004)

See page [301](#).

RoHS marking

The RoHS mark is attached to the drive to verify that drive follows the provisions of the European RoHS Directive. RoHS = the restriction of the use of certain hazardous substances in electrical and electronic equipment.

UL marking

See the type designation label for the valid markings of your drive.

The UL mark is attached to the drive to verify that it meets UL requirements.

UL checklist

Input power connection – See section [Input power connection](#) on page 296.

Disconnecting device (disconnecting means) – See section [Supply disconnecting device](#) on page 29.

Ambient conditions – The drives are to be used in a heated indoor controlled environment. See section [Ambient conditions](#) on page 298 for specific limits.

Input cable fuses – For installation in the United States, branch circuit protection must be provided in accordance with the National Electrical Code (NEC) and any applicable local codes. To fulfil this requirement, use the UL classified fuses given in section [Power cable sizes and fuses](#) on page 293.

For installation in Canada, branch circuit protection must be provided in accordance with Canadian Electrical Code and any applicable provincial codes. To fulfil this requirement, use the UL classified fuses given in section [Power cable sizes and fuses](#) on page 293.

Power cable selection – See section [Selecting the power cables](#) on page 32.

Power cable connections – For the connection diagram and tightening torques, see section [Connecting the power cables](#) on page 38.

Overload protection – The drive provides overload protection in accordance with the National Electrical Code (US).

Braking – The drive has an internal brake chopper. When applied with appropriately sized brake resistors, the brake chopper will allow the drive to dissipate regenerative energy (normally associated with quickly decelerating a motor). Brake resistor selection is discussed in section [Brake resistors](#) on page 302.

IEC/EN 61800-3 (2004) Definitions

EMC stands for **Electromagnetic Compatibility**. It is the ability of electrical/electronic equipment to operate without problems within an electromagnetic environment. Likewise, the equipment must not disturb or interfere with any other product or system within its locality.

First environment includes establishments connected to a low-voltage network which supplies buildings used for domestic purposes.

Second environment includes establishments connected to a network not directly supplying domestic premises.

Drive of category C2: drive of rated voltage less than 1000 V and intended to be installed and commissioned only by a professional when used in the first environment.

Note: A professional is a person or organisation having necessary skills in installing and/or commissioning power drive systems, including their EMC aspects.

Category C2 has the same EMC emission limits as the earlier class first environment restricted distribution. EMC standard IEC/EN 61800-3 does not any more restrict the distribution of the drive, but the using, installation and commissioning are defined.

Drive of category C3: drive of rated voltage less than 1000 V, intended for use in the second environment and not intended for use in the first environment.

Category C3 has the same EMC emission limits as the earlier class second environment unrestricted distribution.

Compliance with the IEC/EN 61800-3 (2004)

The immunity performance of the drive complies with the demands of IEC/EN 61800-3, second environment (see page 299 for IEC/EN 61800-3 definitions). The emission limits of IEC/EN 61800-3 are complied with the provisions described below.

First environment (drives of category C2)

1. The optional EMC filter is selected according to the ABB documentation and installed as specified in the EMC filter manual.
2. The motor and control cables are selected as specified in this manual.
3. The drive is installed according to the instructions given in this manual.
4. Motor cable length maximum 30 m (100 ft) with 4 kHz switching frequency.

WARNING! In a domestic environment, this product may cause radio interference, in which case supplementary mitigation measures may be required.

Second environment (drives of category C3)

1. The internal EMC filter is connected (the metal screw at EMC is in place) or the optional EMC filter is installed.
2. The motor and control cables are selected as specified in this manual.
3. The drive is installed according to the instructions given in this manual.
4. With the internal EMC filter: motor cable length 30 m (100 ft) with 4 kHz switching frequency.

WARNING! A drive of category C3 is not intended to be used on a low-voltage public network which supplies domestic premises. Radio frequency interference is expected if the drive is used on such a network.

Note: It is not allowed to install a drive with the internal EMC filter connected on IT (ungrounded) systems. The supply network becomes connected to ground potential through the EMC filter capacitors which may cause danger or damage the drive.

Note: It is not allowed to install a drive with the internal EMC filter connected on a corner grounded TN system as this would damage the drive.

Product protection in the USA

This product is protected by one or more of the following US patents:

4,920,306	5,301,085	5,463,302	5,521,483	5,532,568	5,589,754
5,612,604	5,654,624	5,799,805	5,940,286	5,942,874	5,952,613
6,094,364	6,147,887	6,175,256	6,184,740	6,195,274	6,229,356
6,252,436	6,265,724	6,305,464	6,313,599	6,316,896	6,335,607
6,370,049	6,396,236	6,448,735	6,498,452	6,552,510	6,597,148
6,741,059	6,774,758	6,844,794	6,856,502	6,859,374	6,922,883
6,940,253	6,934,169	6,956,352	6,958,923	6,967,453	6,972,976
6,977,449	6,984,958	6,985,371	6,992,908	6,999,329	7,023,160
7,034,510	7,036,223	7,045,987	7,057,908	7,059,390	7,067,997
7,082,374	7,084,604	7,098,623	7,102,325	D503,931	D510,319
D510,320	D511,137	D511,150	D512,026	D512,696	D521,466

Other patents pending.

Brake resistors

ACS350 drives have an internal brake chopper as standard equipment. The brake resistor is selected using the table and equations presented in this section.

Brake resistor selection

1. Determine the required maximum braking power P_{Rmax} for the application. P_{Rmax} must be smaller than P_{BRmax} given in the table on page 303 for the used drive type.
2. Calculate resistance R with Equation 1.
3. Calculate energy E_{Rpulse} with Equation 2.
4. Select the resistor so that the following conditions are met:
 - The rated power of the resistor must be greater than or equal to P_{Rmax} .
 - Resistance R must be between R_{min} and R_{max} given in the table for the used drive type.
 - The resistor must be able to dissipate energy E_{Rpulse} during the braking cycle T .

Equations for selecting the resistor:

$$\text{Eq. 1. } U_N = 200 \dots 240 \text{ V: } R = \frac{150000}{P_{Rmax}}$$

$$U_N = 380 \dots 415 \text{ V: } R = \frac{450000}{P_{Rmax}}$$

$$U_N = 415 \dots 480 \text{ V: } R = \frac{615000}{P_{Rmax}}$$

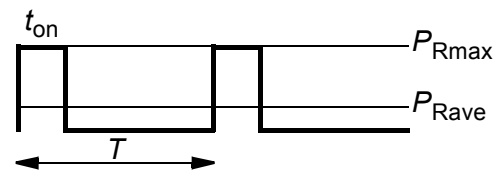

$$\text{Eq. 2. } E_{Rpulse} = P_{Rmax} \cdot t_{on}$$

$$\text{Eq. 3. } P_{Rave} = P_{Rmax} \cdot \frac{t_{on}}{T}$$

For conversion, use 1 HP = 746 W.

where

R = selected brake resistor value (ohm)

P_{Rmax} = maximum power during the braking cycle (W)

P_{Rave} = average power during the braking cycle (W)

E_{Rpulse} = energy conducted into the resistor during a single braking pulse (J)

t_{on} = length of the braking pulse (s)

T = length of the braking cycle (s).

Type ACS350-	R_{\min} ohm	R_{\max} ohm	$P_{BR\max}$	
			kW	HP
1-phase $U_N = 200...240\text{ V}$ (200, 208, 220, 230, 240 V)				
01x-02A4-2	70	390	0.37	0.5
01x-04A7-2	40	200	0.75	1
01x-06A7-2	40	130	1.1	1.5
01x-07A5-2	30	100	1.5	2
01x-09A8-2	30	70	2.2	3
3-phase $U_N = 200...240\text{ V}$ (200, 208, 220, 230, 240 V)				
03x-02A4-2	70	390	0.37	0.5
03x-03A5-2	70	260	0.55	0.75
03x-04A7-2	40	200	0.75	1
03x-06A7-2	40	130	1.1	1.5
03x-07A5-2	30	100	1.5	2
03x-09A8-2	30	70	2.2	3
03x-13A3-2	30	50	3.0	3
03x-17A6-2	30	40	4.0	5
03x-24A4-2	18	25	5.5	7.5
03x-31A0-2	7	19	7.5	10
03x-46A2-2	7	13	11.0	15
3-phase $U_N = 380...480\text{ V}$ (380, 400, 415, 440, 460, 480 V)				
03x-01A2-4	200	1180	0.37	0.5
03x-01A9-4	175	800	0.55	0.75
03x-02A4-4	165	590	0.75	1
03x-03A3-4	150	400	1.1	1.5
03x-04A1-4	130	300	1.5	2
03x-05A6-4	100	200	2.2	3
03x-07A3-4	70	150	3.0	3
03x-08A8-4	70	110	4.0	5
03x-12A5-4	40	80	5.5	7.5
03x-15A6-4	40	60	7.5	10
03x-23A1-4	30	40	11	15
03x-31A0-4	16	29	15	20
03x-38A0-4	13	23	18.5	25
03x-44A0-4	13	19	22.0	30

00353783.xls G

 R_{\min} = minimum allowed brake resistor R_{\max} = maximum allowed brake resistor $P_{BR\max}$ = maximum braking capacity of the drive, must exceed the desired braking power.

WARNING! Never use a brake resistor with a resistance below the minimum value specified for the particular drive. The drive and the internal chopper are not able to handle the overcurrent caused by the low resistance.

Resistor installation and wiring

All resistors must be installed in a place where they will cool.



WARNING! The materials near the brake resistor must be non-flammable. The surface temperature of the resistor is high. Air flowing from the resistor is of hundreds of degrees Celsius. Protect the resistor against contact.

Use a shielded cable with the conductor size specified in section [Power cables: terminal sizes, maximum cable diameters and tightening torques on page 295](#). For short-circuit protection of the brake resistor connection, see [Brake resistor connection on page 297](#). Alternatively, a two-conductor shielded cable with the same cross-sectional area can be used. The maximum length of the resistor cable(s) is 5 m (16 ft). For the connections, see the power connection diagram of the drive on page [38](#).

Mandatory circuit protection

The following setup is essential for safety – it interrupts the main supply in fault situations involving chopper shorts:

- Equip the drive with a main contactor.
- Wire the contactor so that it opens if the resistor thermal switch opens (an overheated resistor opens the contactor).

Below is a simple wiring diagram example.

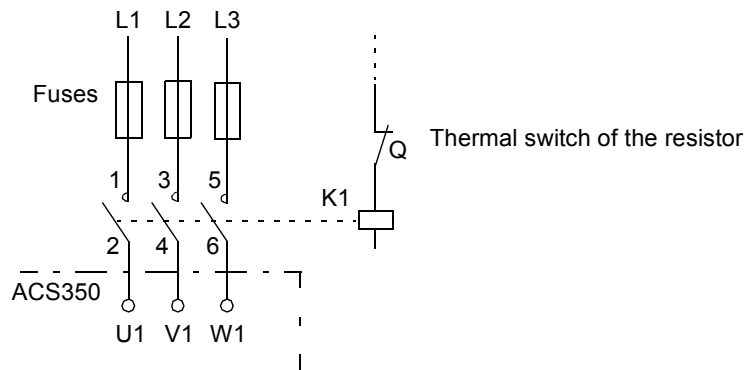

Parameter set-up

To enable resistor braking, switch off the drive's overvoltage control by setting parameter [2005](#) to 0 (DISABLE).

Dimensions

Dimensional drawings of the ACS350 are shown below. The dimensions are given in millimeters and [inches].

Frame sizes R0 and R1, IP20 (cabinet installation) / UL open

R1 and R0 are identical except for the fan at the top of R1.

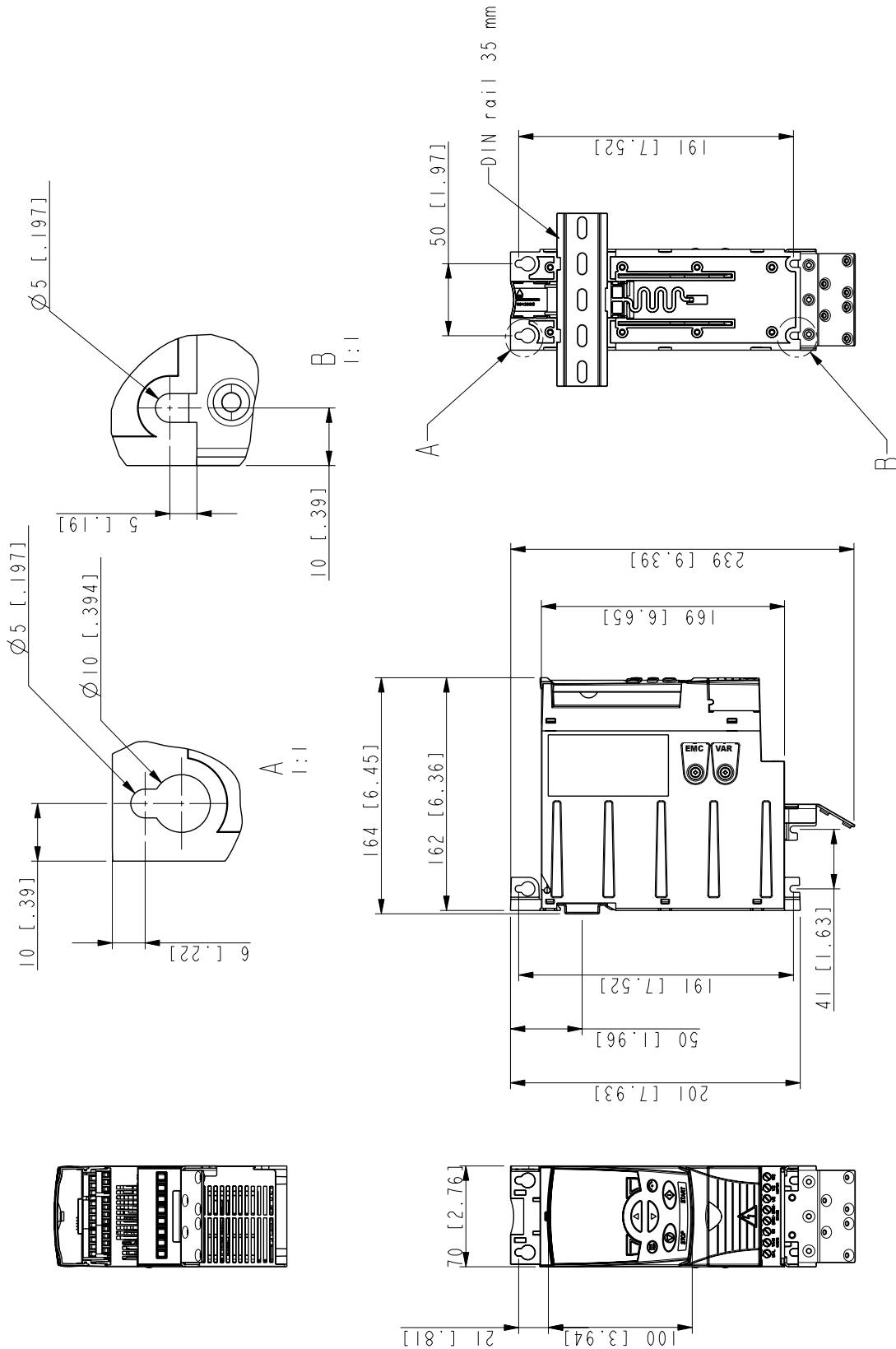

Frame sizes R0 and R1, IP20 (cabinet installation) / UL open

3AFE68488079-B

Frame sizes R0 and R1, IP20 / NEMA 1

R1 and R0 are identical except for the fan at the top of R1.

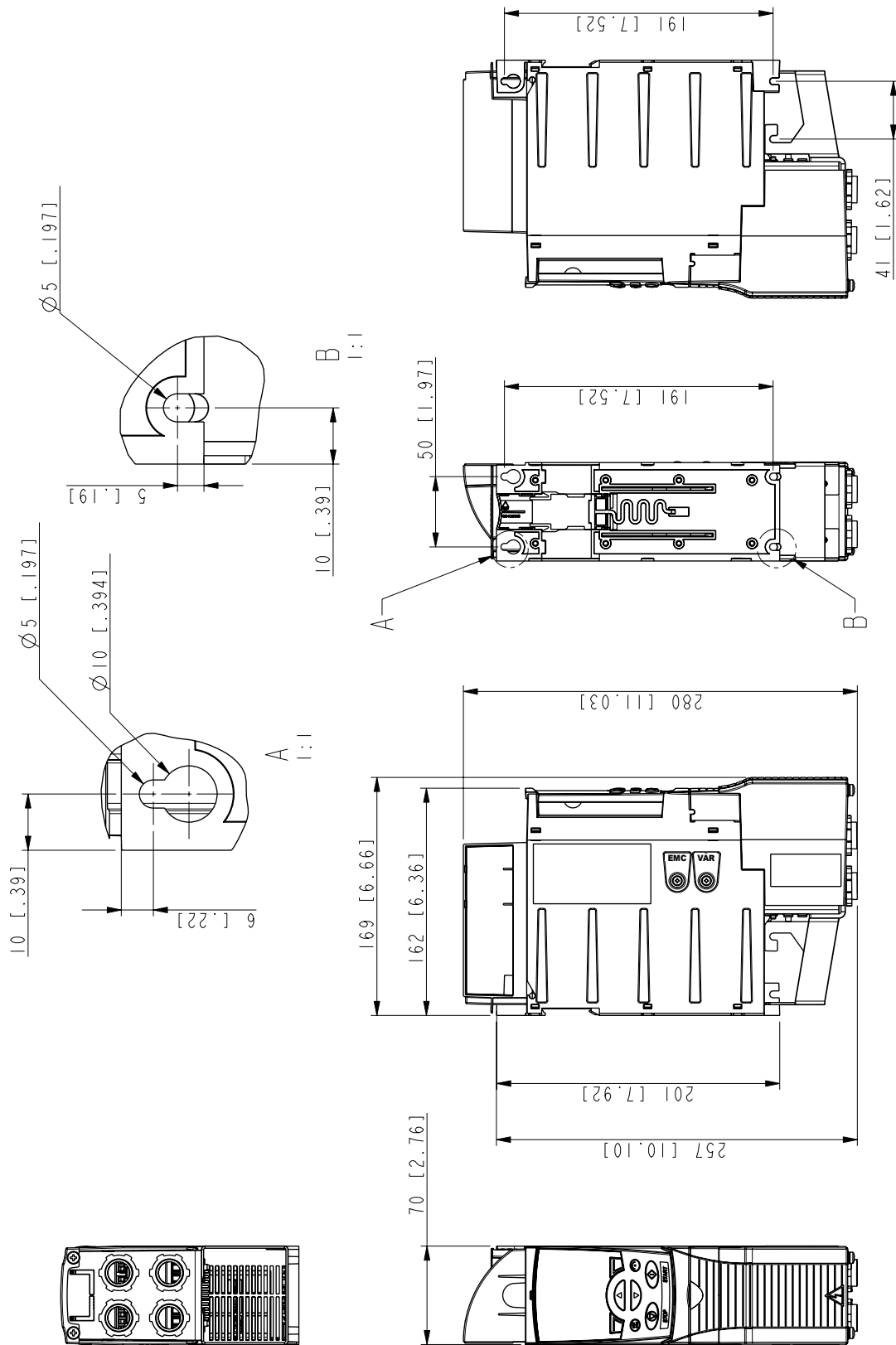

Frame sizes R0 and R1, IP20 / NEMA 1

3AFE6857977-A

Frame size R2, IP20 (cabinet installation) / UL open

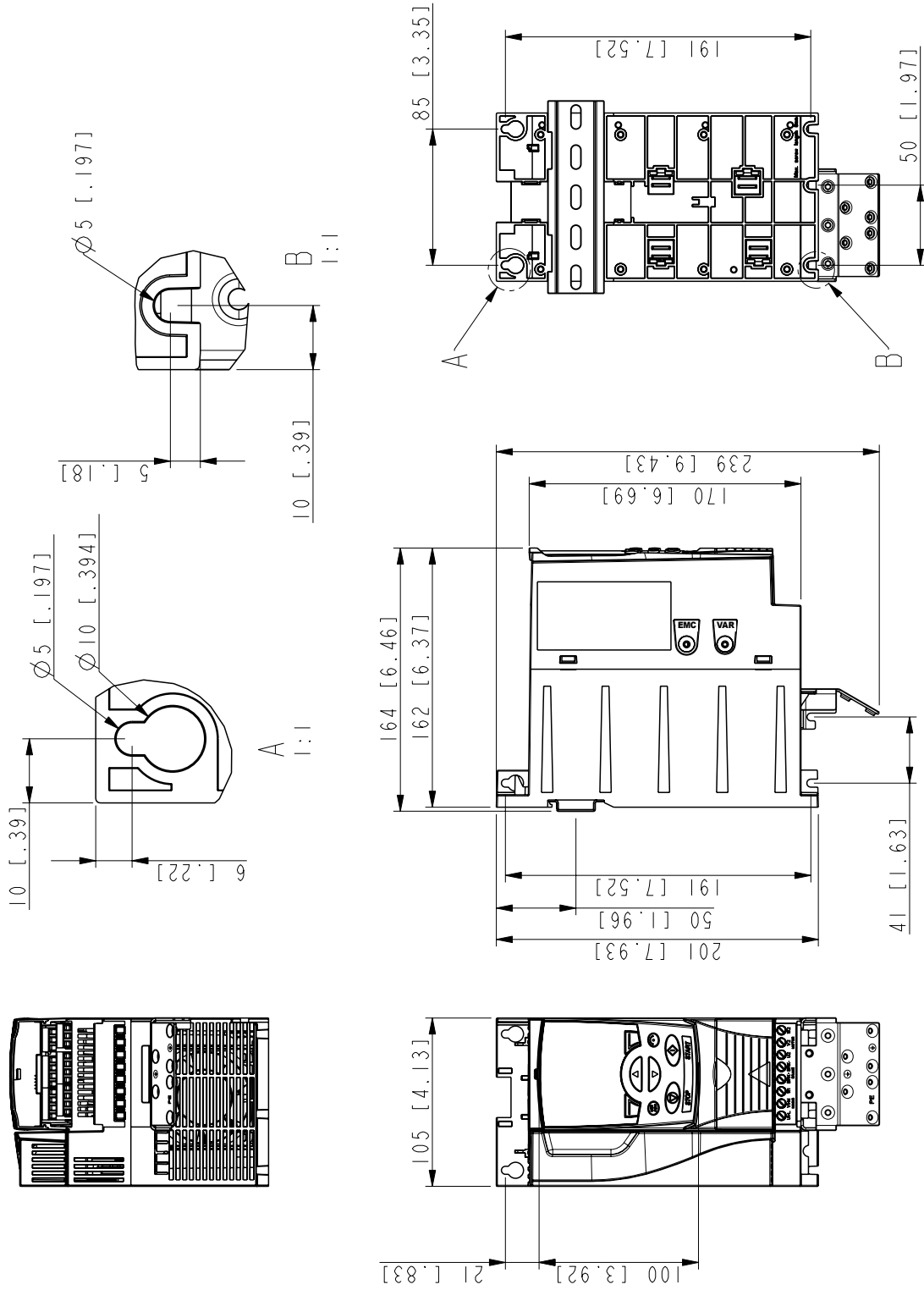

Frame size R2, IP20 (cabinet installation) / UL open

3AFE68585619-A

Frame size R2, IP20 / NEMA 1

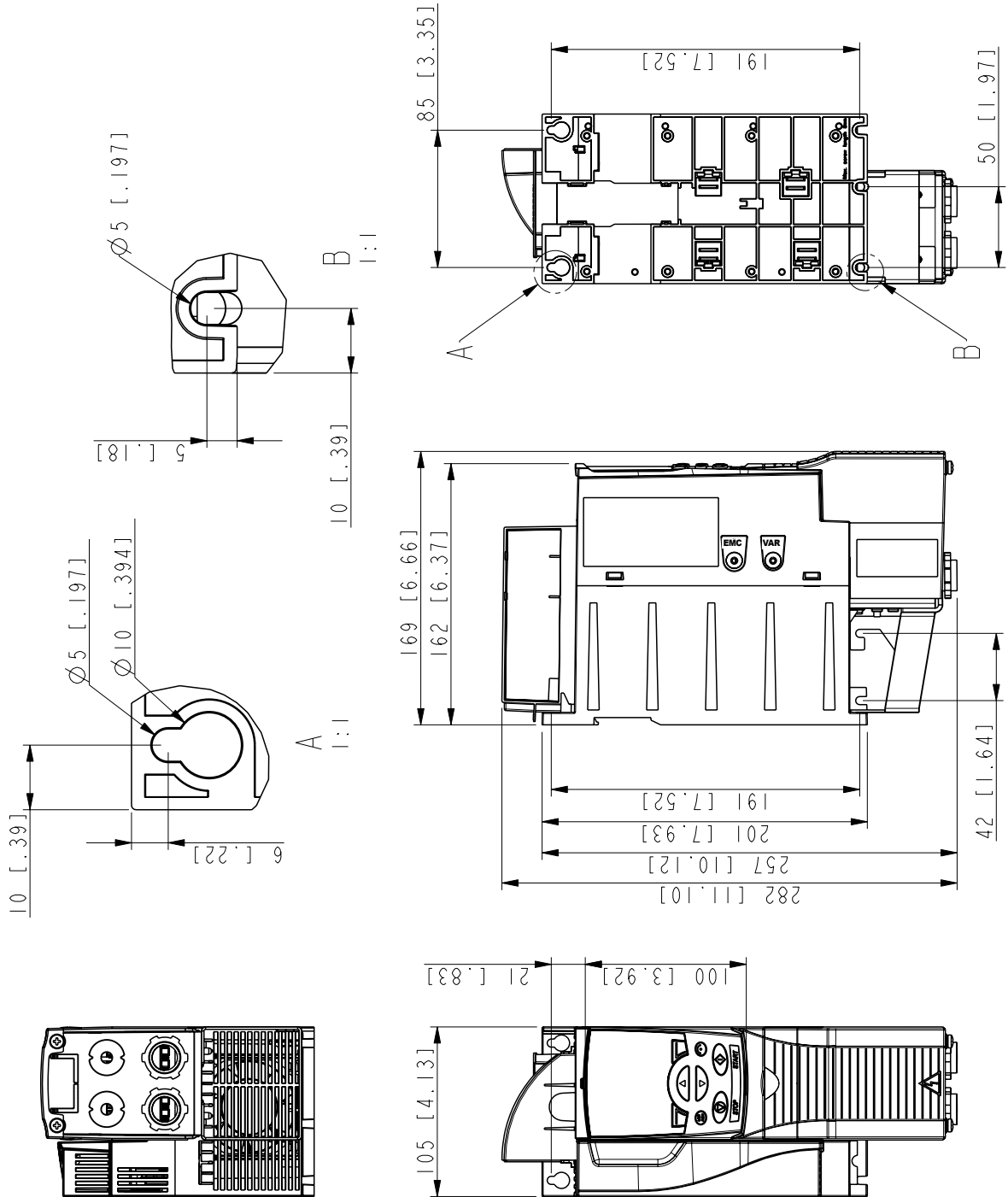

Frame size R2, IP20 / NEMA 1

3AFE68586658-A

Frame size R3, IP20 (cabinet installation) / UL open

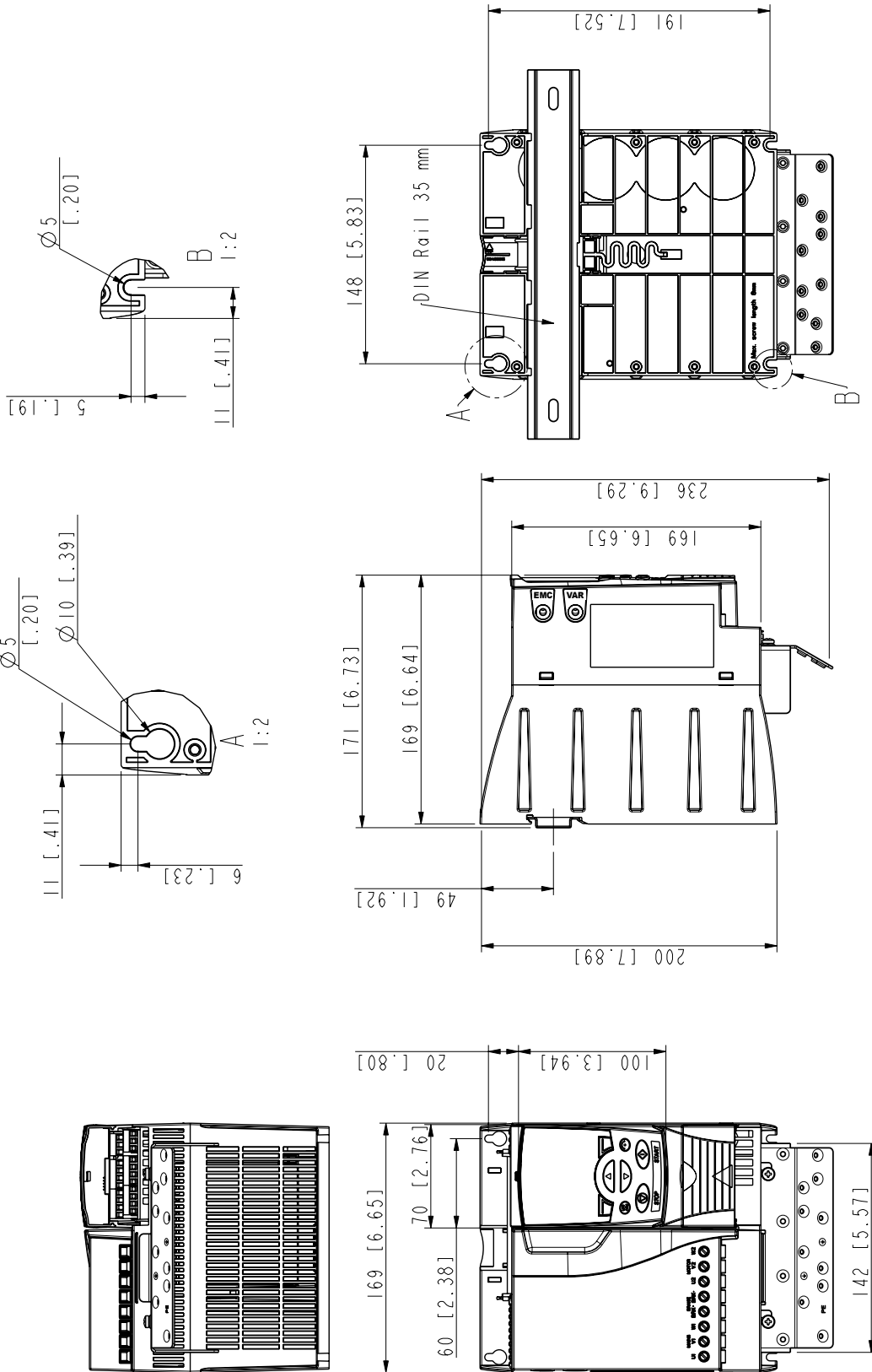

Frame size R3, IP20 (cabinet installation) / UL open

3AFE668487587-B

Frame size R3, IP20 / NEMA 1

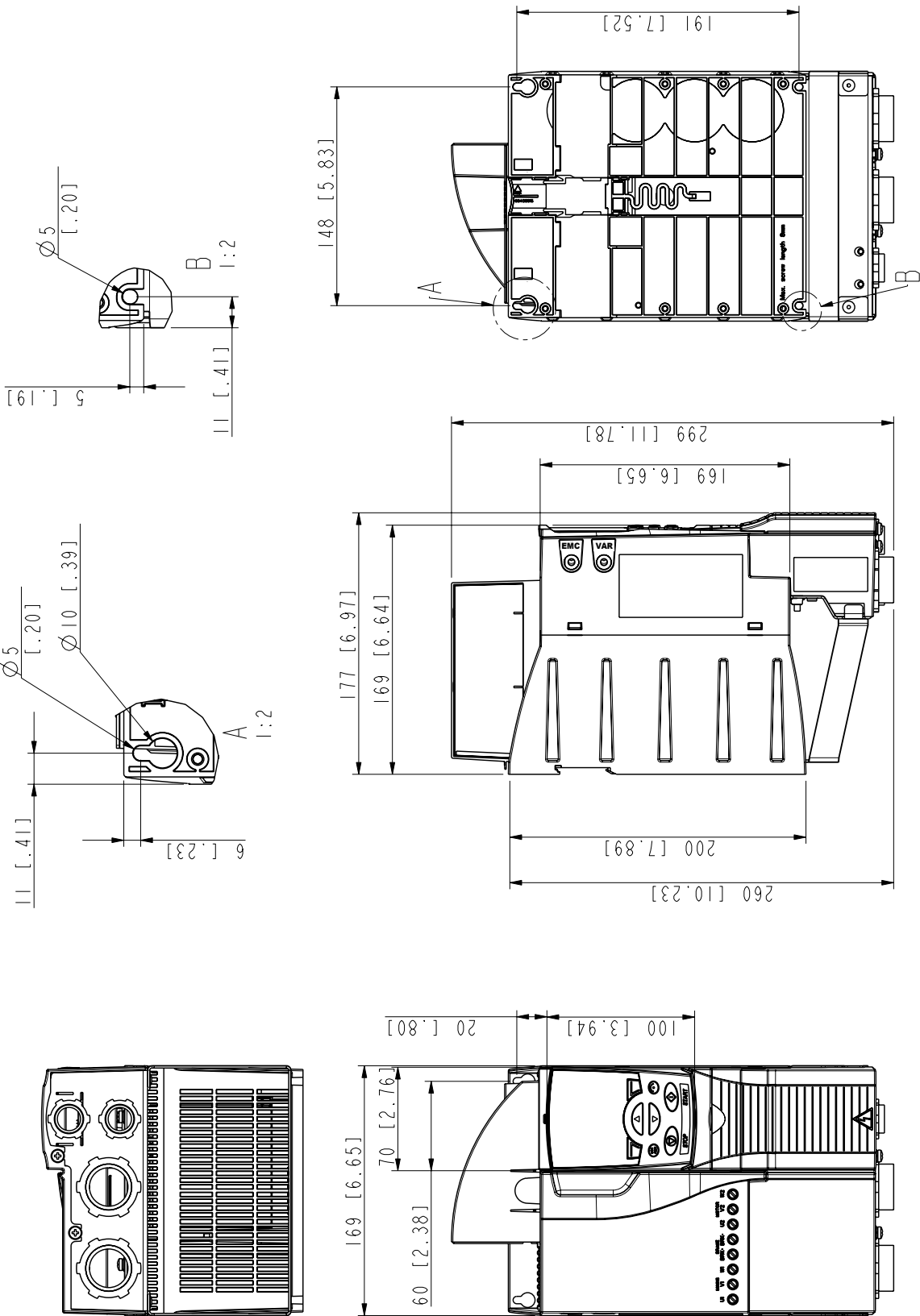

Frame size R3, IP20 / NEMA 1

3AFE68579872-B



ABB Oy
AC Drives
P.O. Box 184
FI-00381 HELSINKI
FINLAND
Telephone +358 10 22 11
Fax +358 10 22 22681
Internet <http://www.abb.com>

ABB Inc.
Automation Technologies
Drives & Motors
16250 West Glendale Drive
New Berlin, WI 53151
USA
Telephone +1 262 785-3200
+1 800-HELP-365
Fax +1 262 780-5135

ABB Limited
Daresbury Park
Daresbury
Warrington
Cheshire
WA4 4BT
UNITED KINGDOM
Telephone +44 1925 741111
Fax +44 1925 741212

ABB Beijing Drive Systems Co. Ltd.
No. 1, Block D, A-10 Jiuxianqiao Beilu
Chaoyang District
Beijing, P.R. China, 100015
Telephone +86 10 5821 7788
Fax +86 10 5821 7618
Internet <http://www.abb.com>

3AFE68462401 Rev D / EN
EFFECTIVE: 30.09.2007