

Motion and Servos

The OMNUC W and SmartStep series are fully digital Servo Drives (servomotor and servo driver) that have been created to meet the most exacting requirements. The servo drivers and servomotors are fully matched and compatible. The Online Auto-tuning function controls the settings of the drive according to the changes of the load.

Features:

- Speed control range >1:5000
- 300% starting torque
- Motors with and without mechanical holding brake
- Easy to wire with prefabricated cable sets
- Can be programmed and optimised with control terminal or computer via an RS-232C port.

Servo Systems

SmartStep

- 230 V system (power range: 30 W..750 W)
- Positioning control with pulse input
- Parameters can be set via DIP switches
- Auto-tuning online feature

OMNUC W Series

- 400 V system (power range: 450 W..15 kW)
- 230 V system (power range: 30 W..1.5 kW)
- Speed and torque control via analogue Input
- Positioning control with pulse input
- Optionally expandable (Networking, Motion Control)

Servo Based Controllers

R88A-MCW151-(DRT)-E Advanced Motion Control Unit

- Easy to program (BASIC)
- Registration, CAM and synchronisation function
- Multitasking
- Supports Host Link protocol and DeviceNet bus

R88A-NCW152 for DeviceNet and Positioning Control

- Up to 63 OMNUC W drives can be networked
- Positioning features and trace function

JUSP-NS500 for PROFIBUS and Positioning Control

- PROFIBUS network connectivity
- Positioning functionality

JUSP-NS600 Indexing Unit

- Versatile point to point Positioning Controller

PLC Based Controllers

A full range of position and motion controllers are available as PLC modules. The functionality extends from single axis point to point control through to multiple axes complex motion control

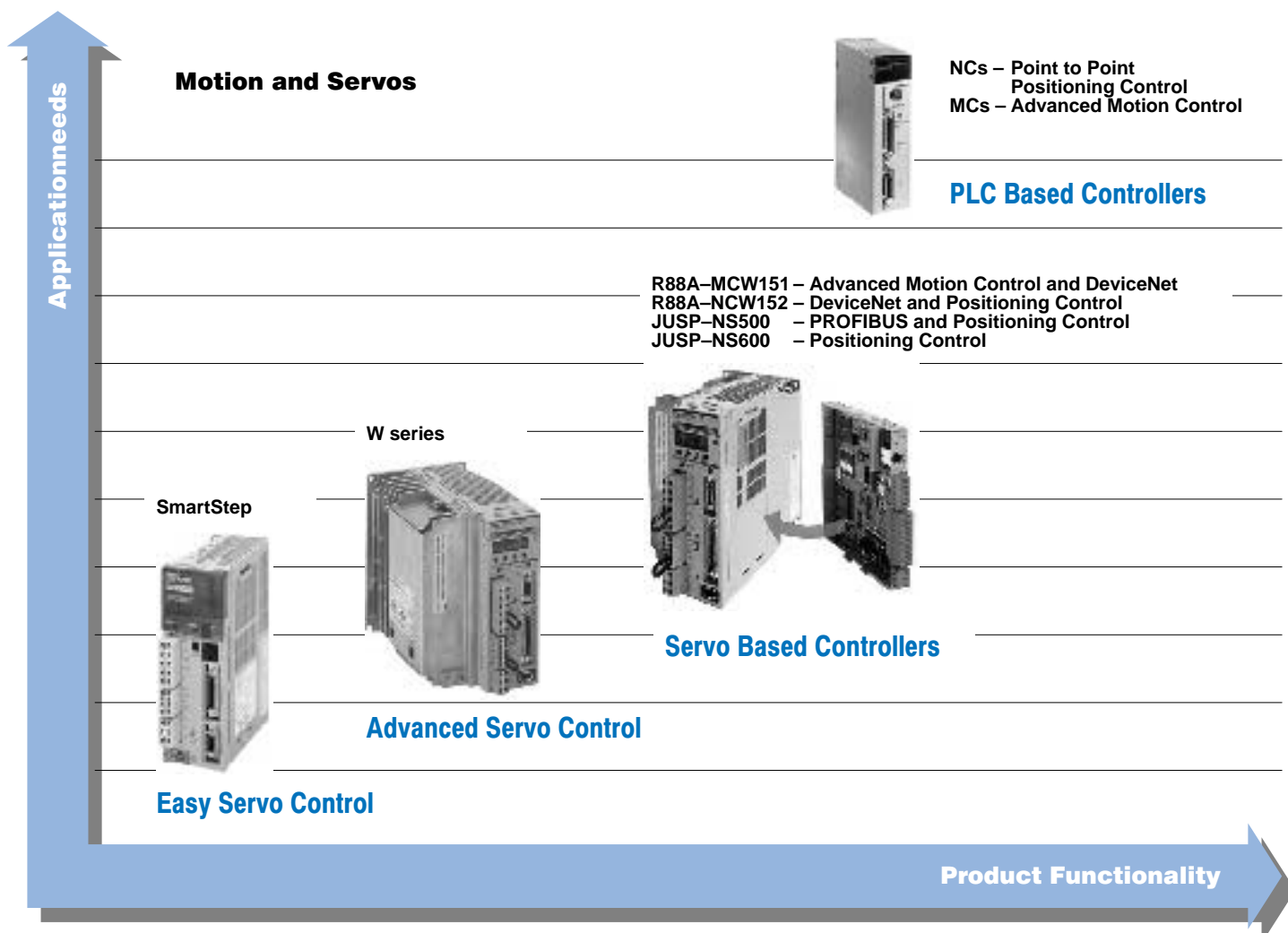

General

The SmartStep series has been designed to address the requirements of the low cost point-to-point motion market. These include fast response, accuracy and reliability. The SmartStep is an ideal alternative to stepper motors.

The controller features Positioning Control with pulse input.

The power range of this series ranges from 30 W..750 W, equivalent to 0.318..2.39 Nm of torque at 3000 rpm. The supply voltage is 230 V (50/60 Hz; single-phase).

Characteristics:

- Very compact design of motor and drive
- Max. motor speed 4500 rpm, speed control range >1:5000
- Rapid commissioning with the Online Autotune function
- Motors available with and without mechanical holding brake
- Parameters can also be set via DIP switches
- 300% acceleration torque
- Easy to wire with prefabricated cable sets
- Low weight
- Convenient to operate from a control terminal
- Computer programmable via RS-232C port



System Configuration

System layout for simple positioning application.

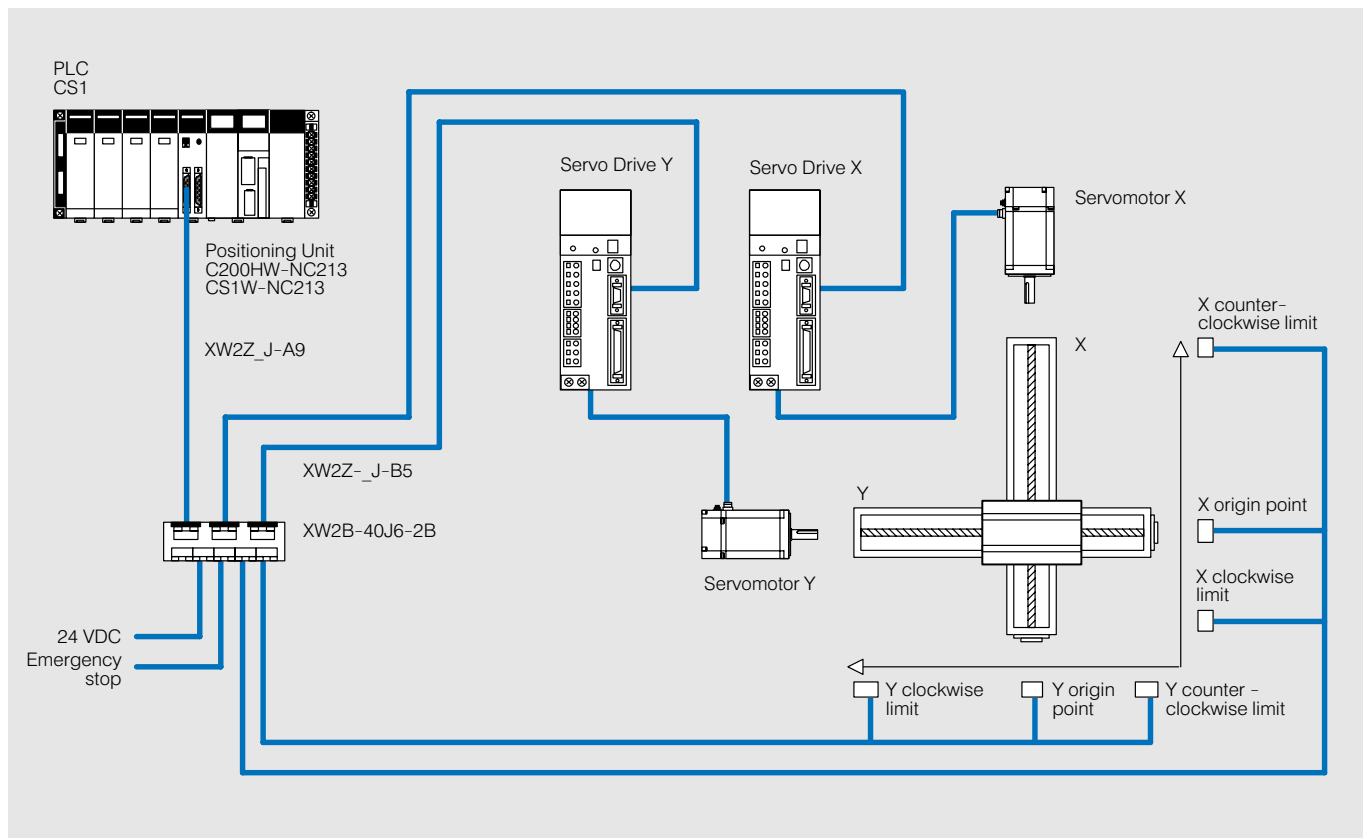

System Configuration (Continued)

Systems without holding brake (3000 rpm motors)

Power	Rated torque	Servomotor	Servo driver	Line filter (footprint)
30 W	0.095 Nm	R7M-A03030-S1	R7D-APA3H	R88A-FIW104-E
50 W	0.159 Nm	R7M-A05030-S1	R7D-APA5H	R88A-FIW104-E
100 W	0.318 Nm	R7M-A10030-S1 R7M-AP10030-S1	R7D-AP01H	R88A-FIW104-E
200 W	0.637 Nm	R7M-A20030-S1 R7M-AP20030-S1	R7D-AP02H	R88A-FIW104-E
400 W	1.27 Nm	R7M-A40030-S1 R7M-AP40030-S1	R7D-AP04H	R88A-FIW107-E
750 W	2.39 Nm	R7M-A75030-S1 R7M-AP75030-S1	R7D-AP08H	R88A-FIW115-E

Systems with holding brake (3000 rpm motors)

Power	Rated torque	Servomotor	Servo driver	Line filter (footprint)
30 W	0.095 Nm	R7M-A03030-BS1	R7D-APA3H	R88A-FIW104-E
50 W	0.159 Nm	R7M-A05030-BS1	R7D-APA5H	R88A-FIW104-E
100 W	0.318 Nm	R7M-A10030-BS1 R7M-AP10030-BS1	R7D-AP01H	R88A-FIW104-E
200 W	0.637 Nm	R7M-A20030-BS1 R7M-AP20030-BS1	R7D-AP02H	R88A-FIW104-E
400 W	1.27 Nm	R7M-A40030-BS1 R7M-AP40030-BS1	R7D-AP04H	R88A-FIW107-E
750 W	2.39 Nm	R7M-A75030-BS1 R7M-AP75030-BS1	R7D-AP08H	R88A-FIW115-E

Encoder cable/motor cable without holding brake: **R7A-CEAxxx-S**

Encoder cable/motor cable with holding brake: **R7A-CEAxxx-B**

xxx = Cable length (see Accessories, page 364).

Specifications

Servo driver	R7D-APA3H	R7D-APA5H	R7D-AP01H	R7D-AP02H	R7D-AP04H	R7D-AP08H
Motor capacity	30 W	50 W	100 W	200 W	400 W	750 W
Main-circuit power supply	Single-phase 200..230 V, -15..+10%, 50/60 Hz (Three-phase 200/230 V can be used with the 750 W model)					
Control power supply	Single-phase 200..230 V, -15..+10%, 50/60 Hz					
Rated output current rms	0.42 A	0.6 A	0.89 A	2.0 A	2.6 A	4.4 A
Max. output current rms	1.3 A	1.9 A	2.8 A	6.0 A	8.0 A	13.9 A
Control method	PWM method based on IGBT					
Input signals	<ul style="list-style-type: none"> - Servo enable - Pulse input (open collector/line driver) - Deviation counter reset - Alarm reset 					
PWM frequency	11.7 kHz					
Command Pulse response	250 kHz					
Motor feedback	Incremental encoder with 2000 pulses/rev.					
Vibration/shock loading	Max. 4.9 m/s ²					
Ambient temperature	0..55 °C					
Storage temperature	-20..+85 °C					
Humidity	<90% (without condensation)					
Weight	Approx. 0.8 kg	Approx. 0.8 kg	Approx. 0.8 kg	Approx. 0.8 kg	Approx. 1.1 kg	Approx. 1.7 kg

Specifications (Continued)

Cylindrical design motors without/with holding brake

Servomotor	R7M–	A03030–S1 A03030–BS1	A05030–S1 A05030–BS1	A10030–S1 A10030–BS1	A20030–S1 A20030–BS1	A40030–S1 A40030–BS1	A75030–S1 A75030–BS1
Rated output		30 W	50 W	100 W	200 W	400 W	750 W
Rated torque		0.095 Nm	0.159 Nm	0.318 Nm	0.637 Nm	1.27 Nm	2.39 Nm
Peak torque		0.29 Nm	0.48 Nm	0.96 Nm	1.91 Nm	3.82 Nm	7.1 Nm
Rated current	rms	0.42 A	0.6 A	0.87 A	2.0 A	2.6 A	4.4 A
Max. current	rms	1.3 A	1.9 A	2.8 A	6.0 A	8.0 A	13.9 A
Rated speed		3000 rpm					
Max. speed		4500 rpm					
Torque constant		0.255 Nm/A	0.286 Nm/A	0.408 Nm/A	0.355 Nm/A	0.533 Nm/A	0.590 Nm/A
Rotor inertia	kgm ²	1.7 x10 ⁻⁶	2.2 x10 ⁻⁶	3.6 x10 ⁻⁶	1.19 x10 ⁻⁵	1.87 x10 ⁻⁵	6.67 x10 ⁻⁵
Max. load inertia	kgm ²	100x rotor inertia					
Power rate		5.31 kW/s	11.5 kW/s	28.1 kW/s	34.1 kW/s	86.3 kW/s	85.6 kW/s
Inertia moment Time constant		1.2 ms	0.8 ms	0.5 ms	0.4 ms	0.2 ms	0.3 ms
Inductive time constant		1.5 ms	1.8 ms	1.9 ms	5.4 ms	6.4 ms	13 ms
Winding resistance		15.8 Ω	9.64 Ω	6.99 Ω	1.34 Ω	1.23 Ω	0.45 Ω
Winding inductivity		23.1 mH	16.9 mH	13.2 mH	7.2 mH	7.9 mH	5.7 mH

Specification for cylindrical design motors with holding brake

Brake holding voltage	24 VDC ±10% (no polarity)						
Brake rating	6 W	6 W	6 W	7.0 W	7.0 W	7.7 W	
Brake inertia	kgm ²	0.85 x10 ⁻⁶	0.85 x10 ⁻⁶	0.85 x10 ⁻⁶	6.4 x10 ⁻⁶	6.4 x10 ⁻⁶	1.7 x10 ⁻⁵
Brake current consumption		0.25 A	0.25 A	0.25 A	0.29 A	0.29 A	0.32 A
Brake holding torque		0.2 Nm	0.2 Nm	min. 0.34 Nm	min. 1.47 Nm	min. 1.47 Nm	min. 2.45 Nm
Brake continuous duty		100% CD	100% CD	100% CD	100% CD	100% CD	100% CD
Brake insulation class		F	F	F	F	F	F
Weight without brake		0.3 kg	0.4 kg	0.5 kg	1.1 kg	1.7 kg	3.4 kg
Weight with brake		0.6 kg	0.7 kg	0.8 kg	1.6 kg	2.2 kg	4.3 kg

Specifications (Continued)

Cube design motors (without/with holding brake)

Servomotor	R7M–	AP10030–S1 AP10030–BS1	AP20030–S1 AP20030–BS1	AP40030–S1 AP40030–BS1	AP75030–S1 AP75030–BS1
Rated output		100 W	200 W	400 W	750 W
Rated torque		0.318 Nm	0.637 Nm	1.27 Nm	2.39 Nm
Peak torque		0.96 Nm	1.91 Nm	3.82 Nm	7.1 Nm
Rated current	rms	0.89 A	2.0 A	2.6 A	4.1 A
Max. current	rms	2.8 A	6.0 A	8.0 A	13.9 A
Rated speed		3000 rpm			
Max. speed		4500 rpm			
Torque constant		0.392 Nm/A	0.345 Nm/A	0.535 Nm/A	0.641 Nm/A
Rotor inertia	kgm ²	6.5 x10 ⁻⁶	2.09 x10 ⁻⁵	3.47 x10 ⁻⁵	2.11 x10 ⁻⁴
Max. load inertia	kgm ²	100x rotor inertia			
Power rate		15.7 kW/s	19.4 kW/s	46.8 kW/s	26.9 kW/s
Inertia moment Time constant		0.7 ms	0.6 ms	0.7 ms	0.7 ms
Inductive time constant		3.7 ms	7.4 ms	8.5 ms	18 ms
Winding resistance		5.53 Ω	1.13 Ω	1.04 Ω	0.43 Ω
Winding inductivity		20.7 mH	8.4 mH	8.9 mH	7.7 mH

Specification for cube design motors with holding brake

Brake holding voltage	24 VDC ±10% (no polarity)				
Brake rating	6 W	5.0 W	7.6 W	7.5 W	
Brake inertia	kgm ²	2.9 x10 ⁻⁶	1.09 x10 ⁻⁵	1.09 x10 ⁻⁵	8.75 x10 ⁻⁵
Brake current consumption		0.25 A	0.21 A	0.32 A	0.31 A
Brake holding torque		min. 0.4 Nm	min. 0.9 Nm	min. 1.9 Nm	min. 3.5 Nm
Brake continuous duty		100% CD	100% CD	100% CD	100% CD
Brake insulation class		F	F	F	F
Weight without brake		0.7 kg	1.4 kg	2.1 kg	4.2 kg
Weight with brake		0.9 kg	1.9 kg	2.6 kg	5.7 kg





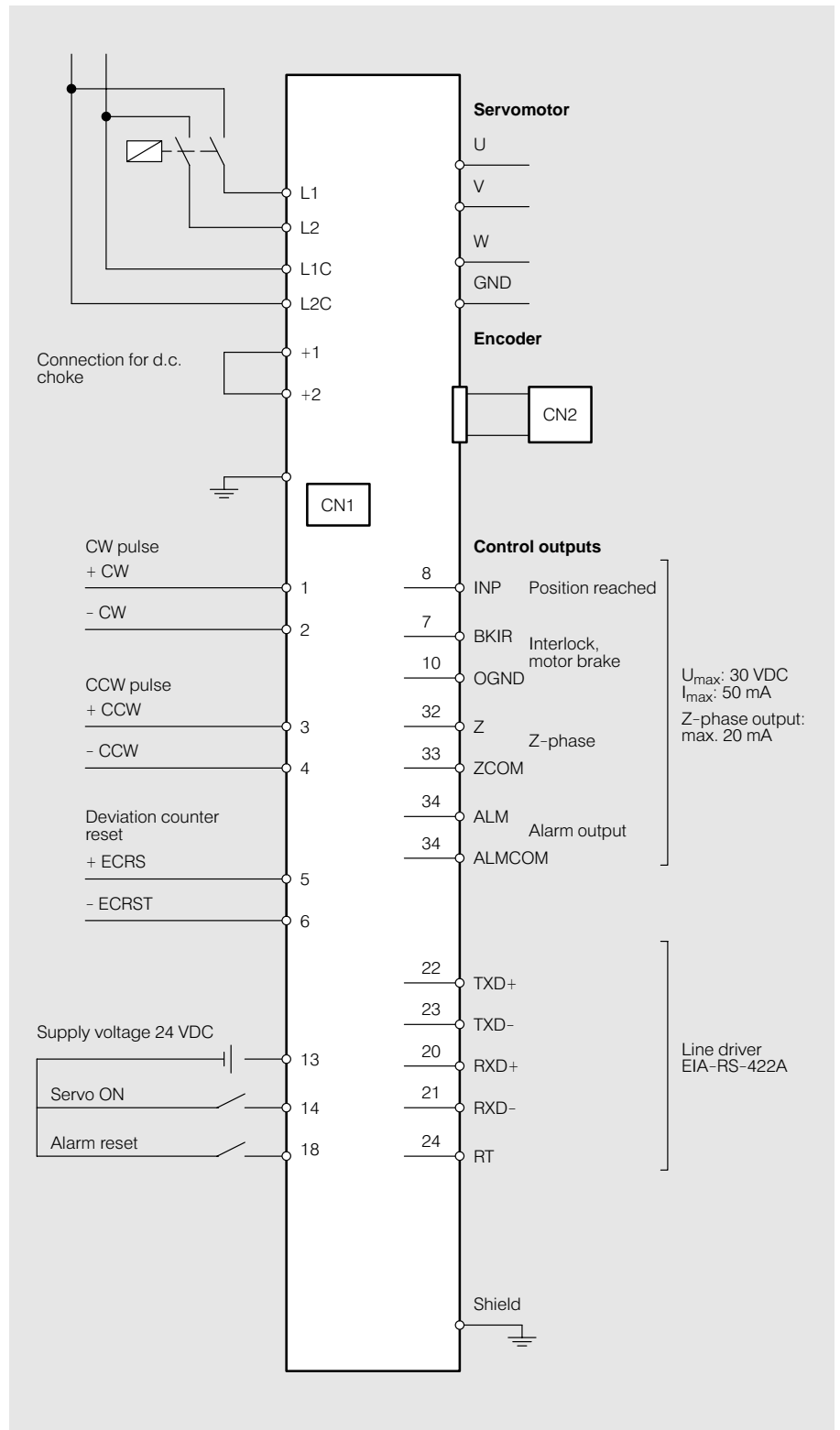





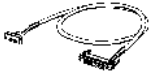



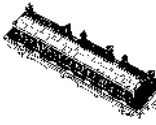
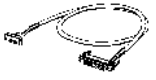

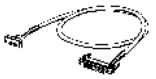
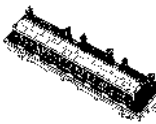



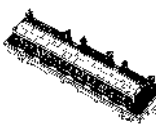

Connection Diagram

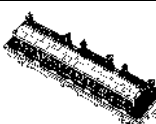
SmartStep

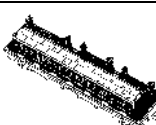

Accessories







Cables and Terminal block connections between SmartStep Servo drive and the PLC Positioning Control Unit.
Without communications support.

PLC Positioning Unit	Cable connection to PLC Unit - 0.5 m = XW2Z-050J-A_ - 1 m = XW2Z-100J-A_	Terminal block	Cable connection to Servo drive (1 cable per servo drive) - 1 m = XW2Z-100J-B_ - 2 m = XW2Z-200J-B_	Servo drive
C200H-NC112	 XW2Z- J-A4	 XW2B-20J6-1B (1 axis)	 XW2Z- J-B5	SmartStep
C200H-NC211	 XW2Z- J-A5	 XW2B-40J6-2B (2 axes)		
C200HW-NC113 CS1W-NC113	 XW2Z- J-A8	 XW2B-20J6-1B (1 axis)		
C200HW-NC213 C200HW-NC413 CS1W-NC213 CS1W-NC413*	 XW2Z- J-A9	 XW2B-40J6-2B (2 axes)		
CS1W-NC133	 XW2Z- J-A12	 XW2B-20J6-1B (1 axis)		
CS1W-NC233 CS1W-NC433*	 XW2Z- J-A13	 XW2B-40J6-2B (2 axes)		
CJ1W-NC113	 XW2Z- J-A16	 XW2B-20J6-1B (1 axis)		
CJ1W-NC213 CJ1W-NC413*	 XW2Z- J-A17	 XW2B-40J6-2B (2 axes)		
CJ1W-NC133	 XW2Z- J-A20	 XW2B-20J6-1B (1 axis)		
CJ1W-NC233 CJ1W-NC433*	 XW2Z- J-A21	 XW2B-40J6-2B (2 axes)		
CQM1H-PLB21 CQM1-CPU43	 XW2Z- J-A3	 XW2B-20J6-3B (1 axis)		
CJ1M-CPU22/23	 XW2Z- J-A26	 XW2B-20J6-8A (1 axis) XW2B-40J6-9A (2 axes)		

* 2 Terminal blocks and 2 Cables to the PLC are required for the C_W-NC4xx Units (4 axes).

Accessories (Continued)

Cables and terminal block connections between SmartStep Servo drive and the PLC Positioning Control Unit.
With communications support.

PLC Positioning Unit	Cable connection to PLC Unit – 0.5 m = XW2Z-050J-A_ – 1 m = XW2Z-100J-A_	Terminal block	Cable connection to Servo drive (1 cable per servo drive) – 1 m = XW2Z-100J-B_ – 2 m = XW2Z-200J-B_	Servo drive
CS1W-NC213 CS1W-NC413*	 XW2Z- J-A9	 XW2B-40J6-4A (2 axes)	 XW2Z- J-B7	SmartStep
CS1W-NC233 CS1W-NC433*	 XW2Z- J-A13			
CJ1W-213 CJ1W-413*	 XW2Z- J-A17			
CJ1W-NC233 CJ1W-NC433*	 XW2Z- J-A21			

* 2 Terminal blocks and 2 Cables to the PLC are required for the C_W-NC4xx Units (4 axes).

Motion and Servos

Other accessories

	Description	Cable length	Model code
Encoder and power cable without brake	From servo drive to motor	3 m	R7A-CEA003S
		5 m	R7A-CEA005S
		10 m	R7A-CEA010S
		15 m	R7A-CEA015S
		20 m	R7A-CEA020S
Encoder and power cable with brake	From servo drive to motor	3 m	R7A-CEA003B
		5 m	R7A-CEA005B
		10 m	R7A-CEA010B
		15 m	R7A-CEA015B
		20 m	R7A-CEA020B
General Control Cable	From servo driver Control I/O to other devices (open end)	1 m	R88A-CPU001-S
		2 m	R88A-CPU002-S
Digital Operator	Parameter copy unit with cable	1 m	R7A-PRO02A
Cable for analogue output	Analogue monitoring	1 m	R88A-CMW001S
External regeneration resistor	For 400 W and 750 W drives	-	R88A-RR22047S

Programming and Documentation

Programming

Description	Cable length	Model code
WmonWin-E. Parameter Setting and monitoring software tool for OMNUC servo systems. For WINDOWS 95/98/2000 or NT4.0/XP (Included in the Motion Tools CD)	-	WmonWin-E
Motion Tools CD. Comprehensive Omron software tools and technical information.	-	MOTION TOOLS
Programming cable	2 m	R7A-CCA002P2

Technical Documentation

English documentation	Product	Title	Model code
	SmartStep	Users Manual	I533-E1
	SmartStep	Operation Manual	I534-E1

Dimensions (mm)

Servo driver, 230 V

W	H	L	Model code
55	160	130	R7D-APA3H
55	160	130	R7D-APA5H
55	160	130	R7D-AP01H
55	160	130	R7D-AP02H
75	160	130	R7D-AP04H
90	160	180	R7D-AP08H

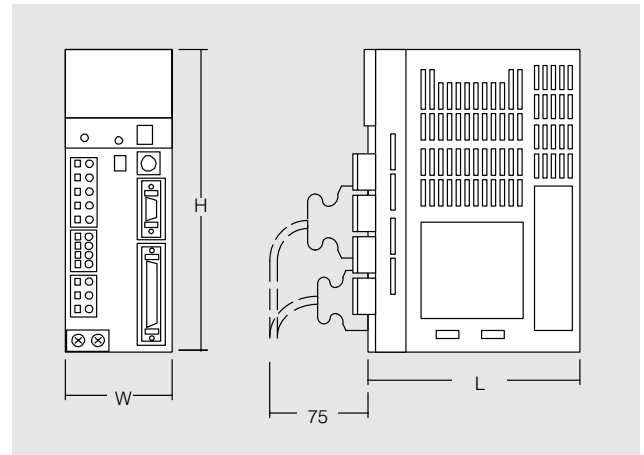

Line filter, footprint, 230 V

A	B	C	D	E	Model code
202	55	33	192	32	R88A-FIW104-E
202	75	50	192	32	R88A-FIW107-E
202	90	60	192	32	R88A-FIW115-E

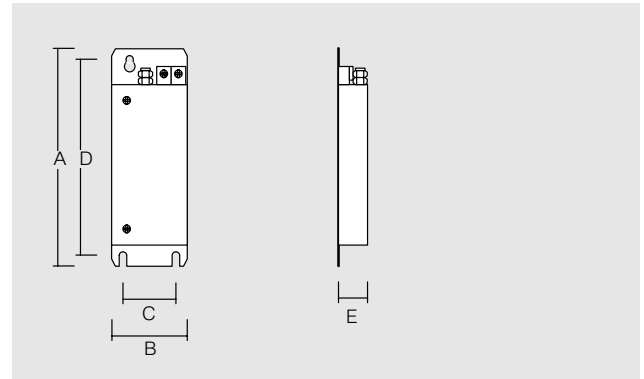

Servomotors, cylindrical design (without brake), 230 V

A	B	C	D	E	L	Model code
25	6	30	46	40	69.5	R7M-A03030-S1
25	6	30	46	40	77	R7M-A05030-S1
25	8	30	46	40	94.5	R7M-A10030-S1
30	14	50	70	60	96.5	R7M-A20030-S1
30	14	50	70	60	124.5	R7M-A40030-S1
40	16	70	90	80	145	R7M-A75030-S1

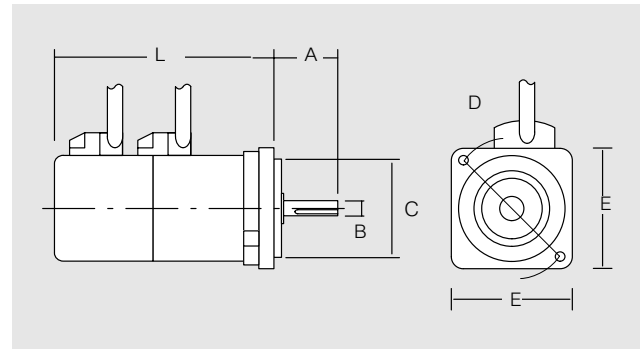

Servomotors, cylindrical design (with brake), 230 V

A	B	C	D	E	L	Model code
25	6	30	46	40	101	R7M-A03030-BS1
25	6	30	46	40	108.5	R7M-A05030-BS1
25	8	30	46	40	135	R7M-A10030-BS1
30	14	50	70	60	136	R7M-A20030-BS1
30	14	50	70	60	164	R7M-A40030-BS1
40	16	70	90	80	189.5	R7M-A75030-BS1

Dimensions (mm) (Continued)

Servomotors, cube design (without brake), 230 V

A	B	C	D	E	L	Model code
25	8	50	70	60	62	R7M-AP10030-S1
30	14	70	90	80	67	R7M-AP20030-S1
30	14	70	90	80	87	R7M-AP40030-S1
40	16	110	145	120	86.5	R7M-AP75030-S1

Servomotors, cube design (with brake), 230 V

A	B	C	D	E	L	Model code
25	8	50	70	60	91	R7M-AP10030-BS1
30	14	70	90	80	98.5	R7M-AP20030-BS1
30	14	70	90	80	118.5	R7M-AP40030-BS1
40	16	110	145	120	120	R7M-AP75030-BS1

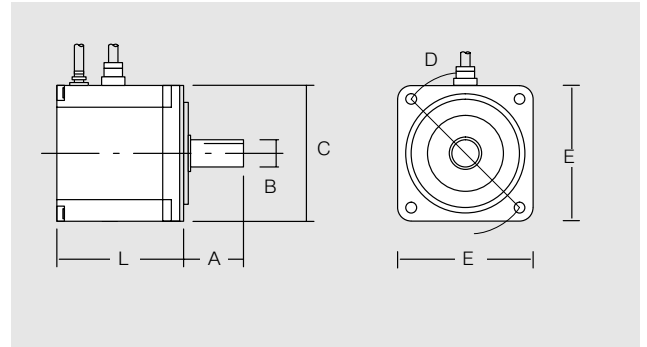

General

The OMNUC W series is an advanced servo system designed to meet the demands of machine design. Motors and drives are fully matched and compatible. The optimum controller setting is continuously computed during operation by an online self-optimising function, so the servo always operates with maximum dynamics irrespective of load.

The OMNUC W Series offers speed/torque and positioning control in a single unit. The servo drivers are available with a three-phase 400 V supply in a power range from 200 W..15 kW or single-phase 230 V supply in a power range from 30 W..1.5 kW.

Characteristics:

- "All-in-One" compact controller with speed/torque and positioning control
- Expandable with optional slot for positioning, advanced Motion control and networking
- Motor protection class:
200V class, IP55
400V class, IP67, optional IP55
- Speeds up to 6000 rpm
- High resolution serial encoder, up to 17 bits
- Extremely short cycle times for speed and position controller, producing maximum dynamic response



System Configuration

Example of a system layout for simple motion control application with one CS1.

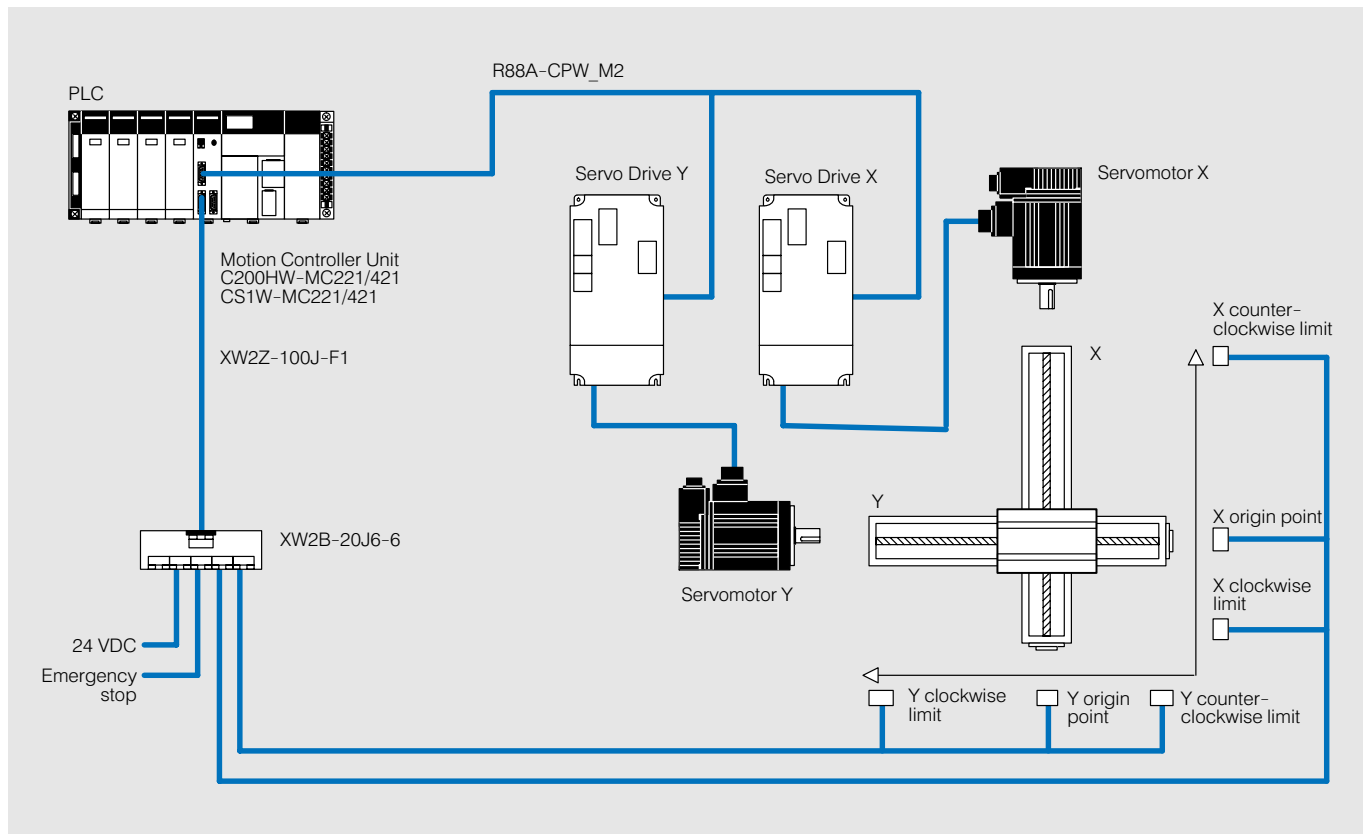

System Configuration (Continued)

230V class

Cylindrical design motors

Systems without holding brake (3000 rpm motors)

Power	Rated torque	Servomotor	Servo driver	Line filter (footprint)	Power cable
30 W	0.0955 Nm	R88M-W03030H-S1-D	R88D-WTA3H	R88A-FIW104-E	R88A-CAWAxxxS-DE
50 W	0.159 Nm	R88M-W05030H-S1-D	R88D-WTA5H	R88A-FIW104-E	R88A-CAWAxxxS-DE
100 W	0.318 Nm	R88M-W10030H-S1-D	R88D-WT01H	R88A-FIW104-E	R88A-CAWAxxxS-DE
200 W	0.637 Nm	R88M-W20030H-S1-D	R88D-WT02H	R88A-FIW104-E	R88A-CAWAxxxS-DE
400 W	1.27 Nm	R88M-W40030H-S1-D	R88D-WT04H	R88A-FIW107-E	R88A-CAWAxxxS-DE
750 W	2.39 Nm	R88M-W75030H-S1-D	R88D-WT08HH	R88A-FIW115-E	R88A-CAWAxxxS-DE

Systems with holding brake (3000 rpm motors)

Power	Rated torque	Servomotor	Servo driver	Line filter (footprint)	Power cable
30 W	0.0955 Nm	R88M-W03030H-BS1-D	R88D-WTA3H	R88A-FIW104-E	R88A-CAWAxxxB-DE
50 W	0.159 Nm	R88M-W05030H-BS1-D	R88D-WTA5H	R88A-FIW104-E	R88A-CAWAxxxB-DE
100 W	0.318 Nm	R88M-W10030H-BS1-D	R88D-WT01H	R88A-FIW104-E	R88A-CAWAxxxB-DE
200 W	0.637 Nm	R88M-W20030H-BS1-D	R88D-WT02H	R88A-FIW104-E	R88A-CAWAxxxB-DE
400 W	1.27 Nm	R88M-W40030H-BS1-D	R88D-WT04H	R88A-FIW107-E	R88A-CAWAxxxB-DE
750 W	2.39 Nm	R88M-W75030H-BS1-D	R88D-WT08HH	R88A-FIW115-E	R88A-CAWAxxxB-DE

Cube design motors

Systems without holding brake (3000 rpm motors)

Power	Rated torque	Servomotor	Servo driver	Line filter (footprint)	Power cable
100 W	0.318 Nm	R88M-WP10030H-S1-D	R88D-WT01H	R88A-FIW104-E	R88A-CAWAxxxS-DE
200 W	0.637 Nm	R88M-WP20030H-S1-D	R88D-WT02H	R88A-FIW104-E	R88A-CAWAxxxS-DE
400 W	1.27 Nm	R88M-WP40030H-S1-D	R88D-WT04H	R88A-FIW107-E	R88A-CAWAxxxS-DE
750 W	2.39 Nm	R88M-WP75030H-S1-D	R88D-WT08HH	R88A-FIW115-E	R88A-CAWAxxxS-DE
1.5 kW	4.9 Nm	R88M-WP1k530H-S1-D	R88D-WT15HH	R88A-FIW125-E	R88A-CAWBxxxS-DE

Systems with holding brake (3000 rpm motors)

Power	Rated torque	Servomotor	Servo driver	Line filter (footprint)	Power cable
100 W	0.318 Nm	R88M-WP10030H-BS1-D	R88D-WT01H	R88A-FIW104-E	R88A-CAWAxxxB-DE
200 W	0.637 Nm	R88M-WP20030H-BS1-D	R88D-WT02H	R88A-FIW104-E	R88A-CAWAxxxB-DE
400 W	1.27 Nm	R88M-WP40030H-BS1-D	R88D-WT04H	R88A-FIW107-E	R88A-CAWAxxxB-DE
750 W	2.39 Nm	R88M-WP75030H-BS1-D	R88D-WT08HH	R88A-FIW115-E	R88A-CAWAxxxB-DE
1.5 kW	4.9 Nm	R88M-WP1k530H-BS1-D	R88D-WT15HH	R88A-FIW125-E	R88A-CAWBxxxB-DE

Encoder cable for 230V class, R88A-CRWAxxxC-DE

xxx = Cable length (see Accessories, page 380)

System Configuration (Continued)

400V class

Cylindrical design motors

Systems without holding brake (1500 rpm motors)

Power	Rated torque	Servomotor	Servo driver	Line filter (footprint)	Power cable
450 W	2.84 Nm	R88M-W45015F-S2	R88D-WT05HF	R88A-FIW4006-E	R88A-CAWCxxxS-E
850 W	5.39 Nm	R88M-W85015F-S2	R88D-WT10HF	R88A-FIW4006-E	R88A-CAWCxxxS-E
1.3 kW	8.34 Nm	R88M-W1k315F-S2	R88D-WT15HF	R88A-FIW4006-E	R88A-CAWCxxxS-E
1.8 kW	11.5 Nm	R88M-W1k815F-S2	R88D-WT20HF	R88A-FIW4010-E	R88A-CAWDxxxS-E
2.9 kW	18.6 Nm	R88M-W2k915F-S2	R88D-WT30HF	R88A-FIW4010-E	R88A-CAWDxxxS-E
4.4 kW	28.4 Nm	R88M-W4k415F-S2	R88D-WT50HF	R88A-FIW4020-SE	R88A-CAWGxxxS-E
5.5 kW	35.0 Nm	R88M-W5k515F-S2	R88D-WT60HF	R88A-FIW4030-SE	R88A-CAWFxxxS-E
7.5 kW	48.0 Nm	R88M-W7k515F-S2	R88D-WT75HF	R88A-FIW4030-SE	R88A-CAWHxxxS-E
11.0 kW	70.0 Nm	R88M-W11k015F-S2	R88D-WT110HF	R88A-FIW4055-SE	R88A-CAWHxxxS-E
15.0 kW	95.4 Nm	R88M-W15k015F-S2	R88D-WT150HF	R88A-FIW4055-SE	R88A-CAWJxxxS-E

Systems with holding brake (1500 rpm motors)

Power	Rated torque	Servomotor	Servo driver	Line filter (footprint)	Power cable
450 W	2.84 Nm	R88M-W45015F-BS2	R88D-WT05HF	R88A-FIW4006-E	R88A-CAWCxxxS-E
850 W	5.39 Nm	R88M-W85015F-BS2	R88D-WT10HF	R88A-FIW4006-E	R88A-CAWCxxxS-E
1.3 kW	8.34 Nm	R88M-W1k315F-BS2	R88D-WT15HF	R88A-FIW4006-E	R88A-CAWCxxxS-E
1.8 kW	11.5 Nm	R88M-W1k815F-BS2	R88D-WT20HF	R88A-FIW4010-E	R88A-CAWDxxxS-E
2.9 kW	18.6 Nm	R88M-W2k915F-BS2	R88D-WT30HF	R88A-FIW4010-E	R88A-CAWDxxxS-E
4.4 kW	28.4 Nm	R88M-W4k415F-BS2	R88D-WT50HF	R88A-FIW4020-SE	R88A-CAWGxxxS-E
5.5 kW	35.0 Nm	R88M-W5k515F-BS2	R88D-WT60HF	R88A-FIW4030-SE	R88A-CAWFxxxS-E
7.5 kW	48.0 Nm	R88M-W7k515F-BS2	R88D-WT75HF	R88A-FIW4030-SE	R88A-CAWHxxxS-E
11.0 kW	70.0 Nm	R88M-W11k015F-BS2	R88D-WT110HF	R88A-FIW4055-SE	R88A-CAWHxxxS-E
15.0 kW	95.4 Nm	R88M-W15k015F-BS2	R88D-WT150HF	R88A-FIW4055-SE	R88A-CAWJxxxS-E

Systems without holding brake (3000 rpm motors)

Power	Rated torque	Servomotor	Servo driver	Line filter (footprint)	Power cable
300 W*	0.955 Nm	R88M-W30030F-S1-D	R88D-WT05HF	R88A-FIW4006-E	R88A-CAWKxxxS-DE
650 W*	2.07 Nm	R88M-W65030F-S1-D	R88D-WT10HF	R88A-FIW4006-E	R88A-CAWKxxxS-DE
1.0 kW	3.18 Nm	R88M-W1k030F-S2	R88D-WT10HF	R88A-FIW4006-E	R88A-CAWCxxxS-E
1.5 kW	4.90 Nm	R88M-W1k530F-S2	R88D-WT15HF	R88A-FIW4006-E	R88A-CAWCxxxS-E
2.0 kW	6.36 Nm	R88M-W2k030F-S2	R88D-WT20HF	R88A-FIW4010-E	R88A-CAWCxxxS-E
3.0 kW	9.80 Nm	R88M-W3k030F-S2	R88D-WT30HF	R88A-FIW4010-E	R88A-CAWDxxxS-E
4.0 kW	12.60 Nm	R88M-W4k030F-S2	R88D-WT50HF	R88A-FIW4020-SE	R88A-CAWDxxxS-E
5.0 kW	15.80 Nm	R88M-W5k030F-S2	R88D-WT50HF	R88A-FIW4020-SE	R88A-CAWFxxxS-E

* Encoder cable for 300 and 650 W motors, R88A-CRWAxxxC-DE

Encoder cable for 400V class, R88A-CRWBxxxN-E

Separate brake cable for 400V class, R88A-CRWCxxxB-E

xxx = Cable length (see Accessories, page 380)

System Configuration (Continued)

400V class

Systems with holding brake (3000 rpm motors)

Power	Rated torque	Servomotor	Servo driver	Line filter (footprint)	Power cable
300 W*	0.955 Nm	R88M-W30030F-BS1-D	R88D-WT05HF	R88A-FIW4006-E	R88A-CAWKxxxB-DE
650 W*	2.07 Nm	R88M-W65030F-BS1-D	R88D-WT10HF	R88A-FIW4006-E	R88A-CAWKxxxB-DE
1.0 kW	3.18 Nm	R88M-W1k030F-BS2	R88D-WT10HF	R88A-FIW4006-E	R88A-CAWCxxxS-E
1.5 kW	4.90 Nm	R88M-W1k530F-BS2	R88D-WT15HF	R88A-FIW4006-E	R88A-CAWCxxxS-E
2.0 kW	6.36 Nm	R88M-W2k030F-BS2	R88D-WT20HF	R88A-FIW4010-E	R88A-CAWCxxxS-E
3.0 kW	9.80 Nm	R88M-W3k030F-BS2	R88D-WT30HF	R88A-FIW4010-E	R88A-CAWDxxxS-E
4.0 kW	12.60 Nm	R88M-W4k030F-BS2	R88D-WT50HF	R88A-FIW4020-SE	R88A-CAWDxxxS-E
5.0 kW	15.80 Nm	R88M-W5k030F-BS2	R88D-WT50HF	R88A-FIW4020-SE	R88A-CAWFxxxS-E

* Encoder cable for 300 and 650 W motors, R88A-CRWAxxxC-DE

A separate brake cable is not required for 300 and 650 W motors.

Systems without holding brake (6000 rpm motors)

Power	Rated torque	Servomotor	Servo driver	Line filter (footprint)	Power cable
1.0 kW	1.59 Nm	R88M-W1k060F-S2	R88D-WT10HF	R88A-FIW4006-E	R88A-CAWCxxxS-E
1.5 kW	2.45 Nm	R88M-W1k560F-S2	R88D-WT15HF	R88A-FIW4006-E	R88A-CAWCxxxS-E
3.0 kW	4.90 Nm	R88M-W3k060F-S2	R88D-WT30HF	R88A-FIW4010-E	R88A-CAWDxxxS-E
4.0 kW	6.30 Nm	R88A-W4k060F-S2	R88D-WT50HF	R88A-FIW4020-SE	R88A-CAWDxxxS-E

Systems with holding brake (6000 rpm motors)

Power	Rated torque	Servomotor	Servo driver	Line filter (footprint)	Power cable
1.0 kW	1.59 Nm	R88M-W1k060F-BS2	R88D-WT10HF	R88A-FIW4006-E	R88A-CAWCxxxS-E
1.5 kW	2.45 Nm	R88M-W1k560F-BS2	R88D-WT15HF	R88A-FIW4006-E	R88A-CAWCxxxS-E
3.0 kW	4.90 Nm	R88M-W3k060F-BS2	R88D-WT30HF	R88A-FIW4010-E	R88A-CAWDxxxS-E
4.0 kW	6.30 Nm	R88M-W4k060F-BS2	R88D-WT50HF	R88A-FIW4020-E	R88A-CAWDxxxS-E

Cube design motors

Systems without holding brake (3000 rpm motors)

Power	Rated torque	Servomotor	Servo driver	Line filter (footprint)	Power cable
200 W**	0.637 Nm	R88M-WP20030F-S1-D	R88D-WT05HF	R88A-FIW4006-E	R88A-CAWKxxxS-DE
400 W**	1.27 Nm	R88M-WP40030F-S1-D	R88D-WT05HF	R88A-FIW4006-E	R88A-CAWKxxxS-DE
750 W**	2.39 Nm	R88M-WP75030F-S1-D	R88D-WT10HF	R88A-FIW4006-E	R88A-CAWKxxxS-DE
1.5 kW**	4.77 Nm	R88M-WP1k530F-S1-D	R88D-WT15HF	R88A-FIW4006-E	R88A-CAWKxxxS-DE

Systems with holding brake (3000 rpm motors)

Power	Rated torque	Servomotor	Servo driver	Line filter (footprint)	Power cable
200 W**	0.637 Nm	R88M-WP20030F-BS1-D	R88D-WT05HF	R88A-FIW4006-E	R88A-CAWKxxxB-DE
400 W**	1.27 Nm	R88M-WP40030F-BS1-D	R88D-WT05HF	R88A-FIW4006-E	R88A-CAWKxxxB-DE
750 W**	2.39 Nm	R88M-WP75030F-BS1-D	R88D-WT10HF	R88A-FIW4006-E	R88A-CAWKxxxB-DE
1.5 kW**	4.77 Nm	R88M-WP1k530F-BS1-D	R88D-WT15HF	R88A-FIW4006-E	R88A-CAWKxxxB-DE

** Encoder cable for cube design motors, R88A-CRWAxxxC-DE

A separate brake cable is not required for cube design motors.

Encoder cable for 400V class, R88A-CRWBxxxN-E

Separate brake cable for 400V class, R88A-CRWCxxxB-E

xxx = Cable length (see Accessories, page 380)

Specifications

230V class

Servo driver

Servo driver	R88D-	WTA3H	WTA5H	WT01H	WT02H	WT04H	WT08HH	WT15HH
Main circuit power supply	200..230 V, -15..+10%, 50/60 Hz, single-phase							
Rated output current	0.44 A	0.64 A	0.91 A	2.1 A	2.8 A	4.4 A	7.5 A	
Max. output current	1.3 A	2.0 A	2.8 A	6.5 A	8.5 A	13.4 A	23.0 A	
Control method	PWM method based on IGBT							
Motor feedback	Serial encoder, 13 bit incremental or 16 bit absolute							
Ambient temperature	0..55 °C							
Storage temperature	-20..+85 °C							
Humidity	<90% (without condensation)							
Vibration/shock loading	4.9 g/19.6 g							

Type coding

Servomotors 200 V

R88M-WP100 30 H-B O S2-D

Shaft end:
 []: Straight shaft without slot and key
 S1: Straight shaft with slot and key
 S2: Straight shaft with key and axial tapped hole

Shaft seal:
 []: No seal
 S1: Shaft packing, oil tight
 S2: Watertight

Motor brake:
 []: No brake
 S1: 24 VDC brake

Encoder type
 H: Incremental, 13 bit
 T: Absolute, 16 bit

Rated speed:
 30: 3000 (5000) rpm

Motor output:
 030: 30 W 050: 50 W
 100: 100 W 200: 200 W
 400: 400 W 750: 750 W
 1k5: 1.5 kW

Type:
 P: Cube design
 []: Long model (Low Inertia)

Specifications (Continued)

230V class

Servomotor, rated speed 3000 rpm (cylindrical design)

Type	R88M–	W03030H	W05030H	W10030H	W20030H	W40030H	W75030H
Motor output		30 W	50 W	100 W	200 W	400 W	750 W
Rated torque		0.0955 Nm	0.159 Nm	0.318 Nm	0.637 Nm	1.27 Nm	2.39 Nm
Peak torque		0.286 Nm	0.477 Nm	0.955 Nm	1.91 Nm	3.82 Nm	7.16 Nm
Rated current		0.44 A	0.64 A	0.91 A	2.1 A	2.8 A	4.4 A
Max. current		1.3 A	2.0 A	2.8 A	6.5 A	8.5 A	13.4 A
Max. speed		5000 rpm					
Torque constant		0.238 Nm/A	0.268 Nm/A	0.378 Nm/A	0.327 Nm/A	0.498 Nm/A	0.590 Nm/A
Rotor inertia	kgm ²	1.66 x10 ⁻⁶	2.20 x10 ⁻⁶	3.64 x10 ⁻⁶	1.06 x10 ⁻⁵	1.73 x10 ⁻⁵	6.72 x10 ⁻⁵
Max. load inertia	kgm ²	30x rotor inertia				20x rotor inertia	
Encoder resolution		13 bit					
Power rate		5.49 kW/s	11.5 kW/s	27.8 kW/s	38.2 kW/s	93.7 kW/s	84.8 kW/s

Servomotor, rated speed 3000 rpm (cube design)

Type	R88M–	WP10030H	WP20030H	WP40030H	WP75030H	WP1k530H
Motor output		100 W	200 W	400 W	750 W	1.5 W
Rated torque		0.318 Nm	0.637 Nm	1.27 Nm	2.39 Nm	4.77 Nm
Peak torque		0.955 Nm	1.91 Nm	3.82 Nm	7.16 Nm	14.3 Nm
Rated current		0.89 A	2.0 A	2.6 A	4.1 A	7.5 A
Max. current		2.8 A	6.0 A	8.0 A	13.9 A	23 A
Max. speed		5000 rpm				
Torque constant		0.392 Nm/A	0.349 Nm/A	0.535 Nm/A	0.691 Nm/A	0.687 Nm/A
Rotor inertia	kgm ²	4.91 x10 ⁻⁶	1.93 x10 ⁻⁵	3.31 x10 ⁻⁵	2.1 x10 ⁻⁴	4.02 x10 ⁻⁴
Max. load inertia	kgm ²	25x rotor inertia	15x rotor inertia	10x rotor inertia	10x rotor inertia	
Encoder resolution		13 bit				
Power rate		20.6 kW/s	21.0 kW/s	49.0 kW/s	27.1 kW/s	56.7 kW/s

Motors with absolute encoder and special models are available. Please, contact your local Omron Office.

400V class

Servo driver

Servo driver	R88D–WT05HF	R88D–WT10HF	R88D–WT15HF	R88D–WT20HF	R88D–WT30HF
Main circuit power supply	3x380..480 V, -15..+10%, 50/60 Hz, three-phase				
Rated output current	1.9 A	3.5 A	5.4 A	8.4 A	11.9 A
Max. output current	5.5 A	8.5 A	14 A	20 A	28 A
Control method	PWM method based on IGBT				
Motor feedback	Serial encoder, incremental or absolute max. 17 bit				
Ambient temperature	0..55 °C				
Storage temperature	-20..+85 °C				
Humidity	<90% (without condensation)				
Vibration/shock loading	4.9 g/19.6 g				

Specifications (Continued)

400V class

Servo driver

Servo driver	R88D-WT50HF	R88D-WT60HF	R88D-WT75HF	R88D-WT110HF	R88D-WT150HF
Main-circuit power supply	3x 380..480 V, -15..+10%, 50/60 Hz, three-phase				
Rated output current	16.5 A	20.8 A	25.4 A	28.1 A	37.29 A
Max. output current	40.5 A	55.0 A	65.0 A	70.0 A	85.0 A
Control method	PWM method based on IGBT				
Motor feedback	Serial encoder, incremental or absolute 17 bit				
Ambient temperature	0..55 °C				
Storage temperature	-20..+85 °C				
Humidity	<90% (without condensation)				
Vibration/shock loading	4.9 g/19.6 g				

Type coding

Servomotors 400 V

R88M-WP450 15 F-B O S2

Shaft end:
 []: Straight shaft
 S1: Straight shaft with key and axial tapped hole
 S4: Taper shaft with slot and key

Shaft seal:
 []: No seal
 O: Shaft packing, oil tight

Motor brake:
 []: No brake
 B: 24 VDC brake

Encoder type:
 F: Incremental
 C: Absolute

Rated speed:
 15: 1500 rpm
 30: 3000 rpm
 60: 6000 rpm

Motor output:

200: 200 W	300: 300 W	400: 400 W
450: 450 W	650: 650 W	850: 850 W
1k0: 1.0 kW	1k3: 1.3 kW	1k8: 1.8 kW
2k0: 2.0 kW	2k9: 2.9 kW	3k0: 3.0 kW
4k0: 4.0 kW	4k4: 4.4 kW	5k0: 5.0 kW
5k5: 5.5 kW	7k5: 7.5 kW	11k0: 11.0 kW
15k0: 15.0 kW		

Type:
 P: Cube design
 []: Long model (Low Inertia)

Motion and Servos

Servomotor, rated speed 1500 rpm (cylindrical design)

Type	R88M-	W45015F	W85015F	W1k315F	W1k815F	W2k915F
Motor output		0.45 kW	0.85 kW	1.3 kW	1.8 kW	2.9 kW
Rated torque		2.84 Nm	5.39 Nm	8.34 Nm	11.5 Nm	18.6 Nm
Peak torque		8.92 Nm	13.8 Nm	23.3 Nm	28.7 Nm	45.1 Nm
Rated current		1.9 A	3.5 A	5.4 A	8.4 A	11.9 A
Max. current		5.5 A	8.5 A	14 A	20 A	28 A
Max. speed		3000 rpm				
Torque constant		1.64 Nm/A	1.65 Nm/A	1.68 Nm/A	1.46 Nm/A	1.66 Nm/A
Rotor inertia	kgm ²	7.24 x10 ⁻⁴	13.9 x10 ⁻⁴	20.5 x10 ⁻⁴	31.7 x10 ⁻⁴	46 x10 ⁻⁴
Max. load inertia	kgm ²	5x rotor inertia				
Encoder resolution		17 bit				
Power rate		11.2 kW/s	20.9 kW/s	33.8 kW/s	41.5 kW/s	75.3 kW/s

Specifications (Continued)

400V class

Servomotor, rated speed 1500 rpm (cylindrical design)

Type	R88M–	W4k415F	W5k515F	W7k515F	W11k015F	W15k015F
Motor output		4.4 kW	5.5 kW	7.5 kW	11.0 kW	15.0 kW
Rated torque		28.4 Nm	35.0 Nm	48.0 Nm	70.0 Nm	95.4 Nm
Peak torque		71.1 Nm	90.7 Nm	123.0 Nm	175.0 Nm	221.0 Nm
Rated current		16.5 A	20.8 A	25.5 A	28.1 A	37.2 A
Max. current		40.5 A	55.5 A	65.0 A	70.0 A	85.0 A
Max. speed		3000 rpm			2000 rpm	
Torque constant	Nm/A	1.82	1.79	2.0	2.56	2.64
Rotor inertia	kgm ²	67.5 x10 ⁻⁴	89.0 x10 ⁻⁴	125.0 x10 ⁻⁴	281.0 x10 ⁻⁴	315.0 x10 ⁻⁴
Max. load inertia	kgm ²	5x rotor inertia				
Encoder resolution		17 bit				
Power rate		120 kW/s	137 kW/s	184 kW/s	174 kW/s	289 kW/s

Servomotor, rated speed 3000 rpm (cylindrical design)

Type	R88M–	W30030F	W65030F	W1k030F	W1k530F	W2k030F
Motor output		0.30 kW	0.65 kW	1.0 kW	1.5 kW	2.0 kW
Rated torque		0.955 Nm	2.07 Nm	3.18 Nm	4.9 Nm	6.36 Nm
Peak torque		3.82 Nm	7.16 Nm	9.45 Nm	14.7 Nm	19.1 Nm
Rated current		1.3 A	2.2 A	2.8 A	4.7 A	6.2 A
Max. current		5.1 A	7.7 A	8.5 A	14 A	19.5 A
Max. speed		5000 rpm				
Torque constant		0.837 Nm/A	1.02 Nm/A	1.27 Nm/A	1.15 Nm/A	1.12 Nm/A
Rotor inertia	kgm ²	0.173 x10 ⁻⁴	0.672 x10 ⁻⁴	1.74 x10 ⁻⁴	2.47 x10 ⁻⁴	3.19 x10 ⁻⁴
Max. load inertia	kgm ²	20x rotor inertia		5x rotor inertia		
Encoder resolution		13 bit	13 bit	17 bit		
Power rate		52.9 kW/s	63.8 kW/s	57.9 kW/s	97.2 kW/s	127.0 kW/s

Type	R88M–	W3k030F	W4k030F	W5k030F
Motor output		3.0 kW	4.0 kW	5.0 kW
Rated torque		9.8 Nm	12.6 Nm	15.8 Nm
Peak torque		29.4 Nm	37.8 Nm	47.6 Nm
Rated current		8.9 A	12.5 A	13.8 A
Max. current		28 A	38 A	42 A
Max. speed		5000 rpm		
Torque constant		1.19 Nm/A	1.07 Nm/A	1.24 Nm/A
Rotor inertia	kgm ²	7 x10 ⁻⁴	9.7 x10 ⁻⁴	12.3 x10 ⁻⁴
Max. load inertia	kgm ²	5x rotor inertia		
Encoder resolution		17 bit		
Power rate		137.0 kW/s	166.0 kW/s	202.0 kW/s

Specifications (Continued)

400V class

Servomotor, rated speed 6000 rpm (cylindrical design)

Type	R88M–	W1k060F	W1k560F	W3k060F	W4k060F
Motor output		1.0 kW	1.5 kW	3.0 kW	4.0 kW
Rated torque		1.59 Nm	2.45 Nm	4.9 Nm	6.3 Nm
Peak torque		6.5 Nm	11.0 Nm	21.5 Nm	29.0 Nm
Rated current		2.7 A	4.1 A	8.1 A	9.6 A
Max. current		8.5 A	14 A	28 A	38.5 A
Max. speed		6000 rpm			
Torque constant		0.81 Nm/A	0.83 Nm/A	0.81 Nm/A	0.80 Nm/A
Rotor inertia	kgm ²	1.74 x10 ⁻⁴	2.47 x10 ⁻⁴	7 x10 ⁻⁴	9.6 x10 ⁻⁴
Max. load inertia	kgm ²	5x inertia moment of motor			
Encoder resolution		17 bit			
Power rate		14.5 kW/s	24.3 kW/s	34.3 kW/s	41.0 kW/s

Servomotor, rated speed 3000 rpm (cube design)

Type	R88M–	WP20030F	WP40030F	WP75030F	WP1k530F
Motor output		0.20 kW	0.40 kW	0.75 kW	1.5 kW
Rated torque		0.637 Nm	1.27 Nm	2.39 Nm	4.77 Nm
Peak torque		1.91 Nm	3.82 Nm	7.16 Nm	14.3 Nm
Rated current		1.4 A	1.4 A	2.6 A	4.5 A
Max. current		4.6 A	4.4 A	7.8 A	13.7 A
Max. speed		5000 rpm			
Torque constant		0.481 Nm/A	0.963 Nm/A	0.994 Nm/A	1.135 Nm/A
Rotor inertia	kgm ²	0.193 x10 ⁻⁴	0.331 x10 ⁻⁴	2.1 x10 ⁻⁴	4.02 x10 ⁻⁴
Max. load inertia	kgm ²	15x rotor inertia	7x rotor inertia	5x rotor inertia	
Encoder resolution		13 bit			
Power rate		21 kW/s	49 kW/s	27.1 kW/s	56.7 kW/s

Motors with absolute encoder and special models are available. Please, contact your local Omron Office.

Connection Diagram

OMNUC W for Positioning Control

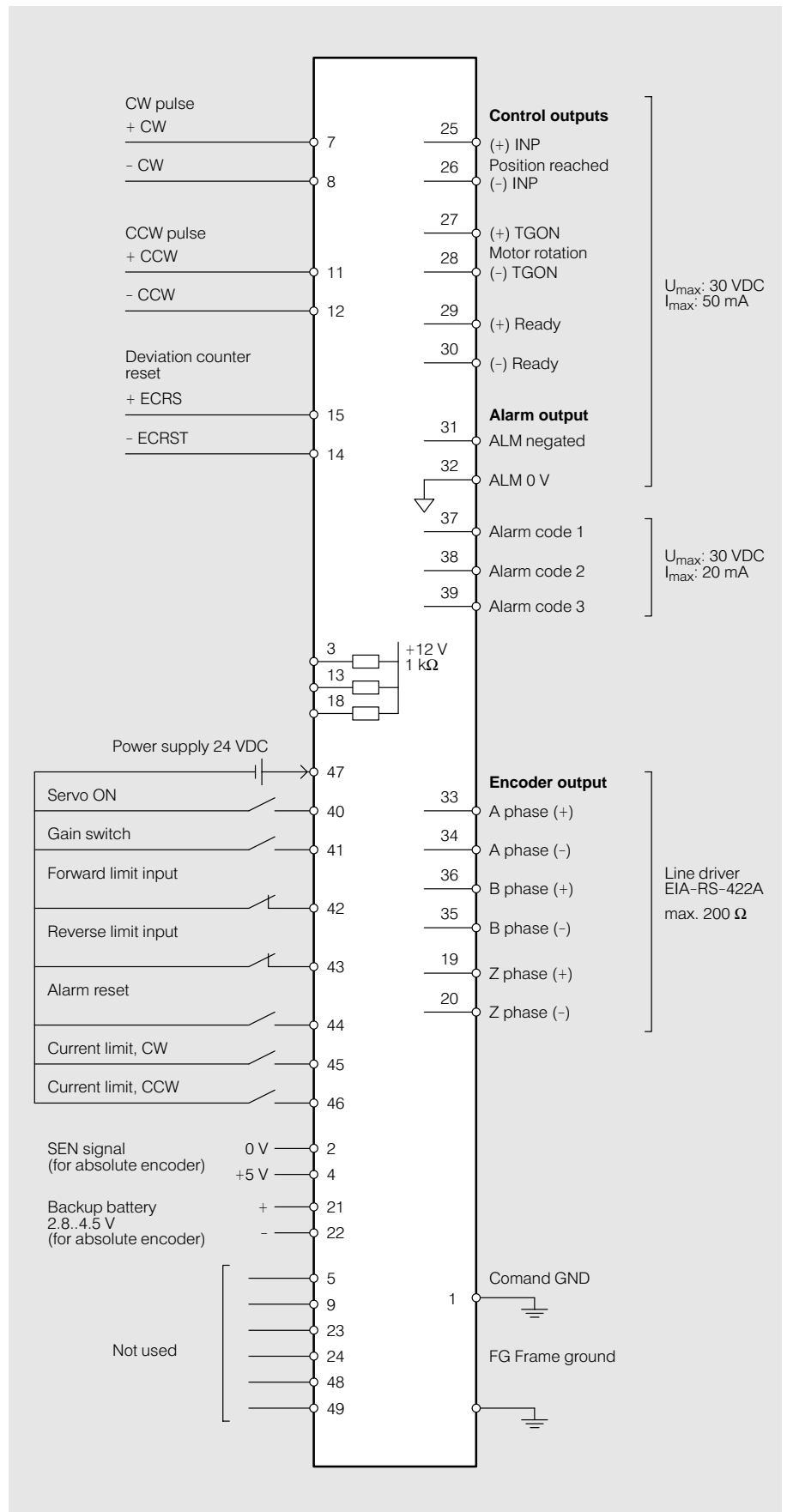

Connection Diagram (Continued)



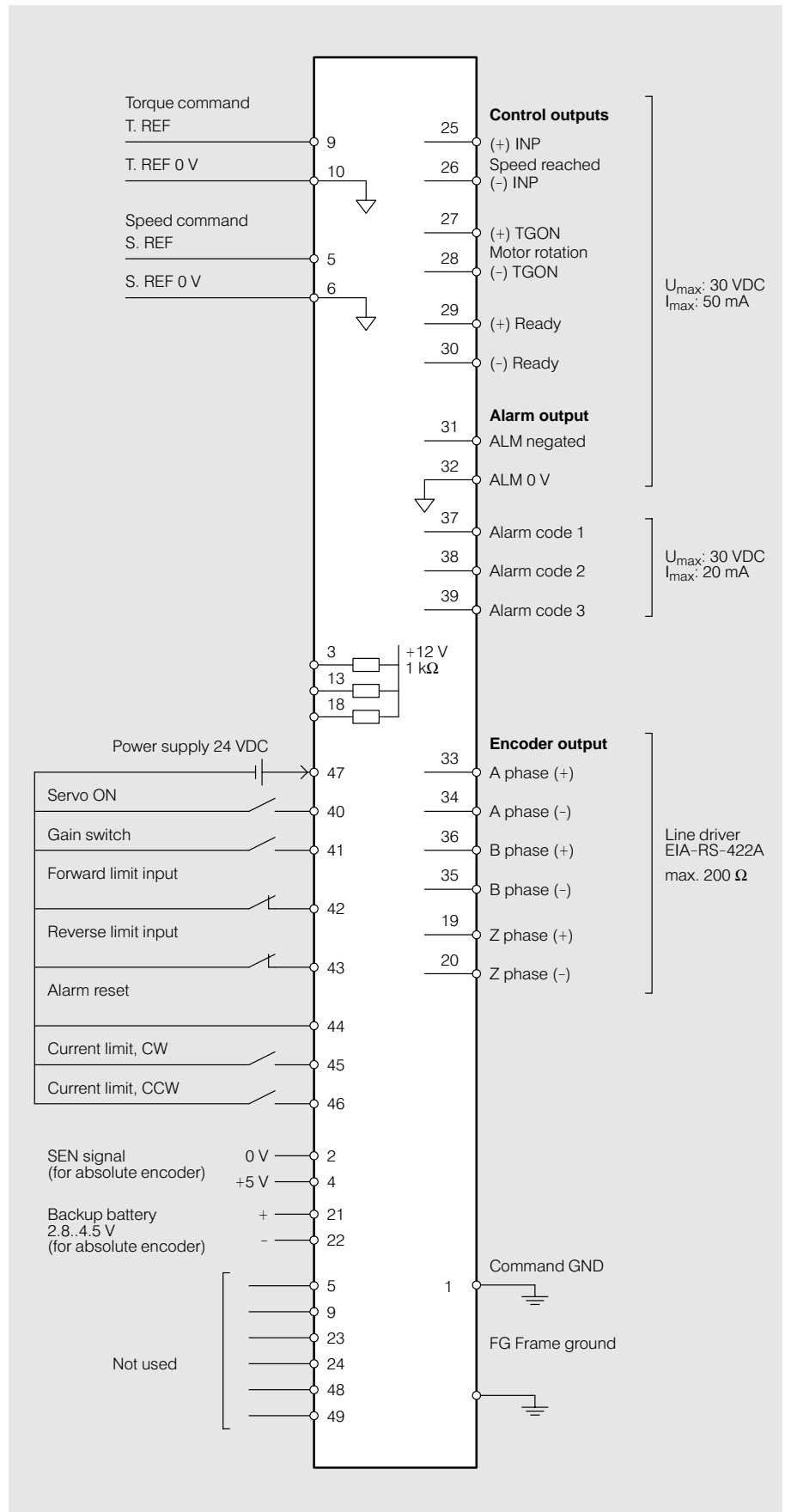

















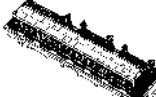

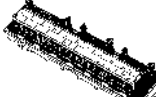

OMNUC W for Speed/Torque Control

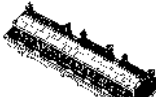

Motion and Servos

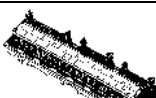
Accessories



Cable and Terminal block connections between OMNUC W Servo drive and te PLC Positioning Control Unit.

PLC Unit	Cable connection to PLC Unit – 0.5 m = XW2Z-050J-A_ – 1 m = XW2Z-100J-A_	Terminal block	Cable connection to Servo drive – 1 m = XW2Z-100J-B_ – 2 m = XW2Z-200J-B_	Servo drive
C200H-NC112	 XW2Z- J-A1	 XW2B-20J6-1B (1 axis)	 XW2Z- J-B4	R88D-W_
C200H-NC211	 XW2Z- J-A2	 XW2B-40J6-2B (2 axes)		
C200HW-NC113 CS1W-NC113	 XW2Z- J-A6	 XW2B-20J6-1B (1 axis)		
CS1W-NC133	 XW2Z- J-A10	 XW2B-20J6-1B (1 axis)		
C200HW-NC213 C200HW-NC413* CS1W-NC213 CS1W-NC413*	 XW2Z- J-A7	 XW2B-40J6-2B (2 axes)		
CS1W-NC233 CS1W-NC433*	 XW2Z- J-A11	 XW2B-40J6-2B (2 axes)		
CJ1W-NC113	 XW2Z- J-A14	 XW2B-20J6-1B (1 axis)		
CJ1W-NC213 CS1W-NC413*	 XW2Z- J-A15	 XW2B-40J6-2B (2 axes)		
CJ1W-NC133	 XW2Z- J-A18	 XW2B-20J6-1B (1 axis)		
CJ1W-NC233 CS1W-NC433*	 XW2Z- J-A19	 XW2B-40J6-2B (2 axes)		
CQM1H-PLB21 CQM1-CP43	 XW2Z- J-A3	 XW2B-20J6-3B (1 axis)		
CJ1M-CPU22/23	 XW2Z- J-A27	 XW2B-20J6-8A (1 axis) XW2B-20J6-9A (2 axes)		

* 2 Terminal blocks and 2 cables to the PLC are required for the C_W-NC4xx Units (4 axes).

Accessories (Continued)

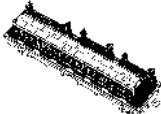

Cable and Terminal block connections between OMNUC W Servo drive and the PLC Motion Controller Units

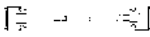
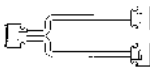
PLC Unit	Cable connection PLC Unit I/O connector	Terminal block I/O signals
2 axes C200H-MC221 CS1W-MC221	 XW2Z-100J-F1	 XW2B-20J6-6 (2 axes)
4 axes CS1W-MC421		 XW2B-40J6-7 (4 axes)

PLC Unit	Cable connection from PLC axes connector to Servo drive – 1 m = R88A-CPW001M_ – 2 m = R88A-CPW002M_	Servo drive
2 axes C200H-MC221 CS1W-MC221	 R88A-CPW_M1 (1 axis)	R88D-W_
4 axes CS1W-MC421*	 R88A-CPW_M2 (2 axes)	

* The CS1W-MC421 Unit (4 axes) requires 2 cables.

Cable and Terminal block connections between OMNUC W Servo drive and the Advanced Motion Controller Unit C200HW-MC402-E

PLC Unit	Cable connection to PLC Unit	Terminal block	Cable connection to Servo drive R88D-W
4 axes C200HW-MC402-E	 I/O cable R88A-CMX001S-E Axis cable R88A-CMX001J1-E	 R88A-TC04-E (4 axes)	R88A-CMUK001J3-E2

Accessories (Continued)

Other accessories

	Description	Cable length	Model code
Power cable without brake, 230Vclass Motor: 30..750 W	From servo drive to motor	3 m	R88A-CAWA003S-DE
		5 m	R88A-CAWA005S-DE
		10 m	R88A-CAWA010S-DE
		15 m	R88A-CAWA015S-DE
		20 m	R88A-CAWA020S-DE
Power cable without brake, 230Vclass Motor: 1.5 kW	From servo drive to motor	3 m	R88A-CAWB003S-DE
		5 m	R88A-CAWB005S-DE
		10 m	R88A-CAWB010S-DE
		15 m	R88A-CAWB015S-DE
		20 m	R88A-CAWB020S-DE
Power cable with brake, 230Vclass Motor: 30..750 W	From servo drive to motor	3 m	R88A-CAWA003B-DE
		5 m	R88A-CAWA005B-DE
		10 m	R88A-CAWA010B-DE
		15 m	R88A-CAWA015B-DE
		20 m	R88A-CAWA020B-DE
Power cable with brake, 230Vclass Motor: 1.5 kW	From servo drive to motor	3 m	R88A-CAWB003B-DE
		5 m	R88A-CAWB005B-DE
		10 m	R88A-CAWB010B-DE
		15 m	R88A-CAWB015B-DE
		20 m	R88A-CAWB020B-DE
Encoder cable, 230V class Motor: 30..1.5 kW	From servo drive to motor	3 m	R88A-CRWA003C-DE
		5 m	R88A-CRWA005C-DE
		10 m	R88A-CRWA010C-DE
		15 m	R88A-CRWA015C-DE
		20 m	R88A-CRWA020C-DE
Encoder cable, 400V class Cylindrical design motors: 3000 rpm, 300 W, 650 W Cube design motors: 3000 rpm, 0.2..1.5 kW	From servo drive to motor	3 m	R88A-CAWK003S-DE
		5 m	R88A-CAWK005S-DE
		10 m	R88A-CAWK010S-DE
		15 m	R88A-CAWK015S-DE
		20 m	R88A-CAWK020S-DE
Power cable without brake, 400Vclass Cylindrical design motors: 3000 rpm, 0.3..0.65 kW Cube design motors: 3000 rpm, 0.2..1.5 kW	From servo drive to motor	3 m	R88A-CAWK003B-DE
		5 m	R88A-CAWK005B-DE
		10 m	R88A-CAWK010B-DE
		15 m	R88A-CAWK015B-DE
		20 m	R88A-CAWK020B-DE
Power cable, 400V class Cylindrical design motors: 1500 rpm, 450 W..1.3 kW 3000 rpm, 1.0..2.0 kW 6000 rpm, 1.0..1.5 kW	From servo drive to motor	3 m	R88A-CAWC003S-E
		5 m	R88A-CAWC005S-E
		10 m	R88A-CAWC010S-E
		15 m	R88A-CAWC015S-E
		20 m	R88A-CAWC020S-E

Accessories (Continued)

Other accessories

Power cable, 400V class Cylindrical design motors: 1500 rpm, 1.8..2.9 kW 3000 rpm, 3.0..4.0 kW 6000 rpm, 3.0..4.0 kW	From servo drive to motor	3 m	R88A-CAWD003S-E
		5 m	R88A-CAWD005S-E
		10 m	R88A-CAWD010S-E
		15 m	R88A-CAWD015S-E
		20 m	R88A-CAWD020S-E
Power cable, 400V class Cylindrical design motors: 1500 rpm, 4.4 kW	From servo drive to motor	3 m	R88A-CAWG003S-E
		5 m	R88A-CAWG005S-E
		10 m	R88A-CAWG010S-E
		15 m	R88A-CAWG015S-E
		20 m	R88A-CAWG020S-E
Power cable, 400V class Cylindrical design motors: 1500 rpm, 5.5 kW 3000 rpm, 5.0 kW	From servo drive to motor	3 m	R88A-CAWF003S-E
		5 m	R88A-CAWF005S-E
		10 m	R88A-CAWF010S-E
		15 m	R88A-CAWF015S-E
		20 m	R88A-CAWF020S-E
Power cable, 400V class Cylindrical design motors: 1500 rpm, 7.5/11 kW	From servo drive to motor	3 m	R88A-CAWH003S-E
		5 m	R88A-CAWH005S-E
		10 m	R88A-CAWH010S-E
		15 m	R88A-CAWH015S-E
		20 m	R88A-CAWH020S-E
Power cable, 400V class Cylindrical design motors: 1500 rpm, 5.0 kW	From servo drive to motor	3 m	R88A-CAWJ003S-E
		5 m	R88A-CAWJ005S-E
		10 m	R88A-CAWJ010S-E
		15 m	R88A-CAWJ015S-E
		20 m	R88A-CAWJ020S-E
Brake cable, 400V class Cylindrical design motors: 1500 rpm, 450 W..15 kW 3000 rpm, 1.0..5.0 kW 6000 rpm, 1.0..4.0 kW	From servo drive to motor	3 m	R88A-CAWC003B-E
		5 m	R88A-CAWC005B-E
		10 m	R88A-CAWC010B-E
		15 m	R88A-CAWC015B-E
		20 m	R88A-CAWC020B-E
Encoder cable, 400V class Cylindrical design motors: 1500 rpm, 450 W..15 kW 3000 rpm, 1.0..5.0 kW 6000 rpm, 1.0..4.0 kW	From servo drive to motor	3 m	R88A-CRWB003N-E
		5 m	R88A-CRWB005N-E
		10 m	R88A-CRWB010N-E
		15 m	R88A-CRWB015N-E
		20 m	R88A-CRWB020N-E

Accessories (Continued)

Other accessories

General Control Cable	From servo drive control I/O connector to other devices (open end)	1 m	R88A-CPW001S
		2 m	R88A-CPW002S
Hand-held Parameter Unit	With cable	1 m	R88A-PR02W
Cable for analogue output	Analog monitoring	1 m	R88A-CMW001S
1.5 axis Advanced Motion Controller	With Host Link Interface (see page 389)	-	R88A-MCW151-E
1.5 axis Advanced Motion Controller	With DeviceNet Interface (see page 389)	-	R88A-MCW151-DRT-E
DeviceNet Interface Unit	With Positioning Functionality (see page 393)	-	R88A-NCW152-DRT-E
PROFIBUS Interface Unit	With Positioning Functionality (see page 395)	-	JUSP-NS500
Indexer Unit	With versatile Point to Point Positioning (see page 397)	-	JUSP-NS600

Programming and Documentation

Programming

Description	Cable length	Model code
WmonWin-E. Parameter Setting and monitoring software tool for OMNUC servo systems. For WINDOWS 95/98 or NT4.0 (Included in the Motion Tools CD)	-	WmonWin-E
Motion Tools CD. Comprehensive Omron software tools and technical information.	-	MOTION TOOLS
Programming cable	2 m	R88A-CCW002P2

Technical Documentation

English documentation	Product	Title	Model code
	OMNUC W	User Manual	I531-E2

Dimensions (mm)

Servo driver, 230 V

W	H	L	Model code
55	160	130	R88D-WTA3H
55	160	130	R88D-WTA5H
55	160	130	R88D-WT01H
55	160	130	R88D-WT02H
75	160	130	R88D-WT04H
90	160	180	R88D-WT08HH
110	1160	180	R88D-WT15HH

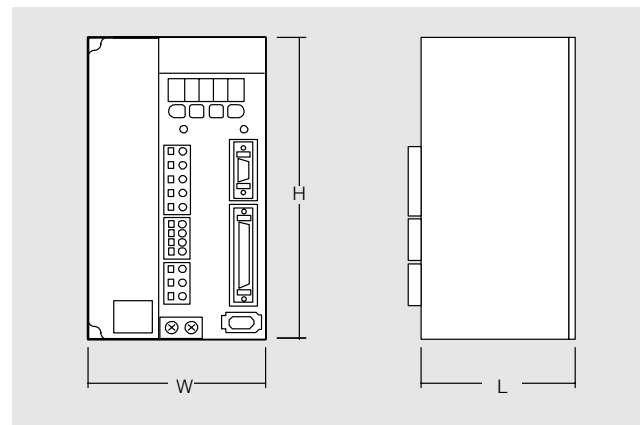

Line filter, footprint, 230 V

A	B	C	D	E	Model code
202	55	33	192	32	R88A-FIW104-E
202	75	50	192	32	R88A-FIW107-E
202	90	60	192	32	R88A-FIW115-E
291	118	80	281	35	R88A-FIW125-E

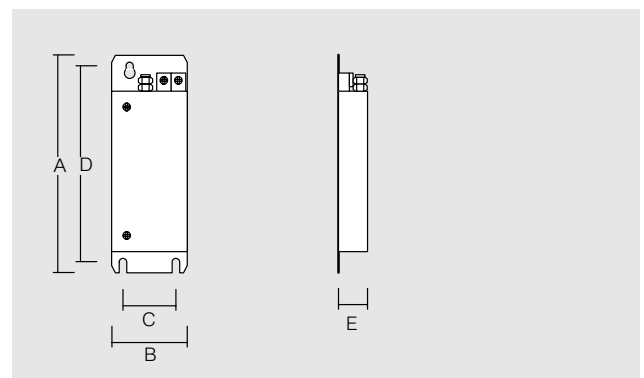

Dimensions (mm) (Continued)

Servomotors, cylindrical design (without brake), 230 V

A	B	C	D	E	L	Model code
25	6	30	46	40	69.5	R88M-W03030H-S1
25	6	30	46	40	77	R88M-W05030H-S1
25	8	30	46	40	94.5	R88M-W10030H-S1
30	14	50	70	60	96.5	R88M-W20030H-S1
30	14	50	70	60	124.5	R88M-W40030H-S1
40	16	70	90	80	145	R88M-W75030H-S1

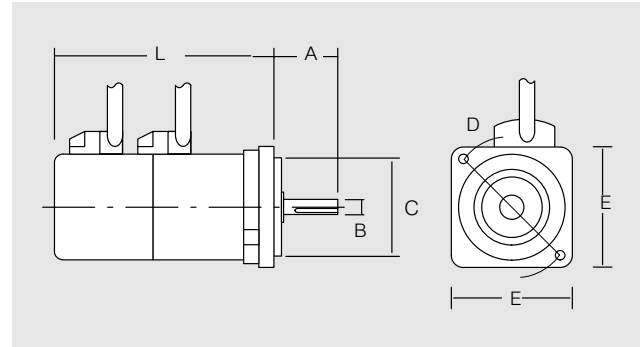

Servomotors, cylindrical design (with brake), 230 V

A	B	C	D	E	L	Model code
25	6	30	46	40	101	R88M-W03030H-BS1
25	6	30	46	40	108.5	R88M-W05030H-BS1
25	8	30	46	40	135	R88M-W10030H-BS1
30	14	50	70	60	136	R88M-W20030H-BS1
30	14	50	70	60	164	R88M-W40030H-BS1
40	16	70	90	80	189.5	R88M-W75030H-BS1

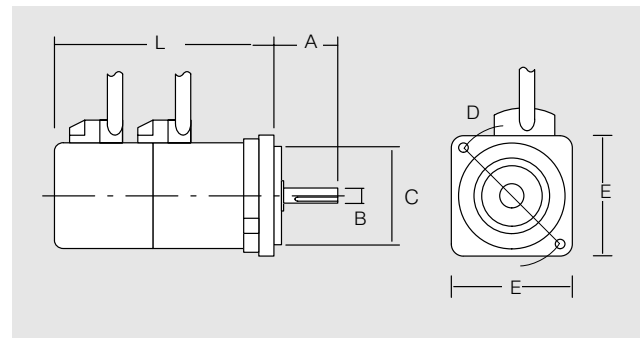

Servomotors, cube design (without brake), 230 V

A	B	C	D	E	L	Model code
25	8	50	70	60	62	R88M-WP10030H-S1
30	14	70	90	80	67	R88M-WP20030H-S1
30	14	70	90	80	87	R88M-WP40030H-S1
40	16	110	145	120	86.5	R88M-WP75030H-S1
40	19	110	145	120	114.5	R88M-WP1k530H-S1

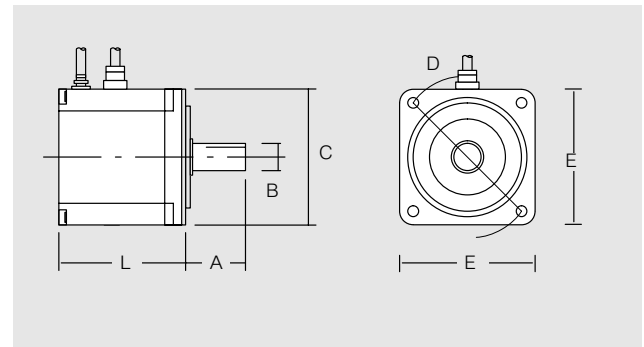

Servomotors, cube design (with brake), 230 V

A	B	C	D	E	L	Model code
25	8	50	70	60	91	R88M-WP10030H-BS1
30	14	70	90	80	98.5	R88M-WP20030H-BS1
30	14	70	90	80	118.5	R88M-WP40030H-BS1
40	16	110	145	120	120	R88M-WP75030H-BS1
40	19	110	145	120	148	R88M-WP1k530H-BS1

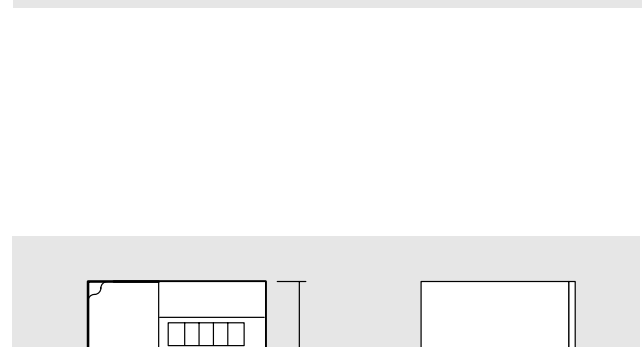

Servo driver, 400 V

W	H	L	Model code
110	160	180	R88D-WT05HF
110	160	180	R88D-WT10HF
110	160	180	R88D-WT15HF
110	250	180	R88D-WT20HF
110	250	180	R88D-WT20HF
135	250	230	R88D-WT50HF
230	350	235	R88D-WT60F
230	350	235	R88D-WT75HF
260	450	285	R88D-WT110HF
260	450	285	R88D-WT150HF

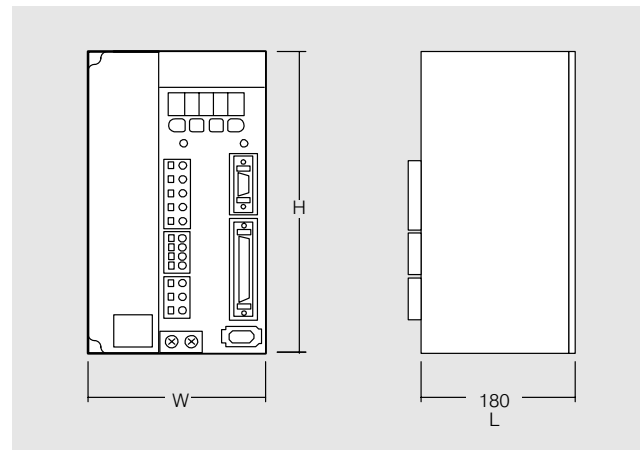

Dimensions (mm) (Continued)

Line filter, footprint, 400 V

A	B	C	D	E	Model code
202	118	80	192	32	R88A-FIW4006-E
291	118	80	281	35	R88A-FIW4010-E
302	140	114	285	40	R88A-FIW4020-E
405	230	200	386	50	R88A-FIW4030-E
505	260	220	487	65	R88A-FIW4055-E

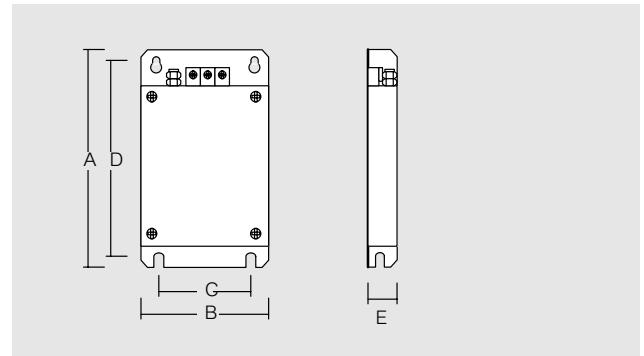

Servomotors, 1500 rpm, cylindrical design (without brake), 400 V

A	B	C	D	E	L	Model code
58	19	110	145	130	138	R88M-W45015F-S2
58	19	110	145	130	161	R88M-W85015F-S2
58	22	110	145	130	185	R88M-W1k315F-S2
79	35	114.3	200	180	166	R88M-W1k815F-S2
79	35	114.3	200	180	192	R88M-W2k915F-S2
79	35	114.3	200	180	226	R88M-W4k415F-S2
113	42	114.3	200	180	260	R88M-W5k515F-S2
113	42	114.3	200	180	334	R88M-W7k515F-S2
116	42	200	235	220	338	R88M-W11k015F-S2
116	55	200	235	220	457	R88M-W15k015F-S2

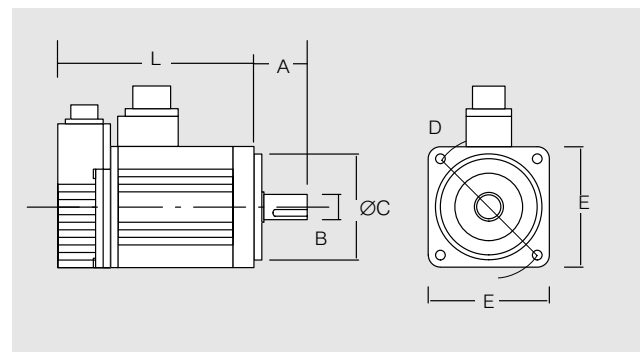

Servomotors, 3000 rpm, cylindrical design (without brake), 400 V

30	14	50	70	60	124.5	R88M-W30030F-S1*
40	16	70	90	80	145	R88M-W65030F-S1*
45	24	95	115	100	149	R88M-W1k030F-S2
45	24	95	115	100	175	R88M-W1k530F-S2
45	24	95	115	100	198	R88M-W2k030F-S2
63	28	110	145	130	199	R88M-W3k030F-S2
63	28	110	145	130	236	R88M-W4k030F-S2
63	28	110	145	130	276	R88M-W5k030F-S2

* The 300 and 650 W motors have different connectors than shown in the picture

Servomotors, 6000 rpm, cylindrical design (without brake), 400 V

45	24	110	130	116	149	R88M-W1k060F-S2
45	24	110	130	116	175	R88M-W1k560F-S2
60	28	130	165	155	202	R88M-W3k060F-S2
60	28	130	165	155	267	R88M-W4k060F-S2

Dimensions (mm) (Continued)

Servomotors, 1500 rpm, cylindrical design (with brake), 400 V

A	B	C	D	E	L	Model code
58	19	110	145	130	176	R88M-W45015F-BS2
58	19	110	145	130	199	R88M-W85015F-BS2
58	22	110	145	130	223	R88M-W1k315F-BS2
79	35	114.3	200	180	217	R88M-W1k815F-BS2
79	35	114.3	200	180	243	R88M-W2k915F-BS2
79	35	114.3	200	180	277	R88M-W4k415F-BS2
113	42	114.3	200	180	311	R88M-W5k515F-BS2
113	42	114.3	200	180	385	R88M-W7k515F-BS2
116	42	200	235	220	383	R88M-W11k015F-BS2
116	42	200	235	220	519	R88M-W15k015F-BS2

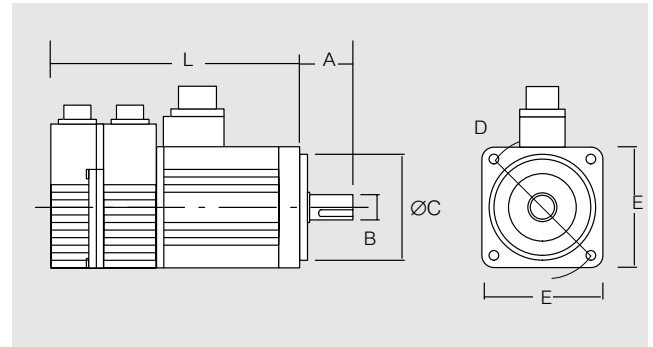

Servomotors, 3000 rpm, cylindrical design (with brake), 400 V

30	14	57	70	60	164	R88M-W30030-BS1*
40	16	70	90	80	189.5	R88M-W65030-BS1*
45	24	95	115	100	193	R88M-W1k030F-BS2
45	24	95	115	100	219	R88M-W1k530F-BS2
45	24	95	115	100	242	R88M-W2k030F-BS2
63	28	110	145	130	237	R88M-W3k030F-BS2
63	28	110	145	130	274	R88M-W4k030F-BS2
63	28	110	145	130	314	5k030F-BS2

* The 300 and 650 W motors have different connectors than shown in the picture

Servomotors, 6000 rpm, cylindrical design (with brake), 400 V

45	24	110	130	116	193	R88M-W1k060F-BS2
45	24	110	130	116	219	R88M-W1k560F-BS2
60	28	130	165	155	237	R88M-W3k060F-BS2
60	28	130	165	155	302	R88M-W4k060F-BS2

Servomotors, 3000 rpm, cube design (without brake), 400 V

A	B	C	D	E	L	Model code
30	14	70	90	80	67	R88M-WP20030F-S1-D
30	14	70	90	80	87	R88M-WP40030F-S1-D
40	16	110	145	120	86.5	R88M-WP75030F-S1-D
40	19	110	145	120	114.5	R88M-WP1k530F-S1-D

Servomotors, 3000 rpm, cube design (with brake), 400 V

30	14	70	90	80	98.5	R88M-WP20030F-BS1-D
30	14	70	90	80	118.5	R88M-WP40030F-BS1-D
40	16	110	145	120	120	R88M-WP75030F-BS1-D
40	19	110	145	120	148	R88M-WP1k530F-BS1-D

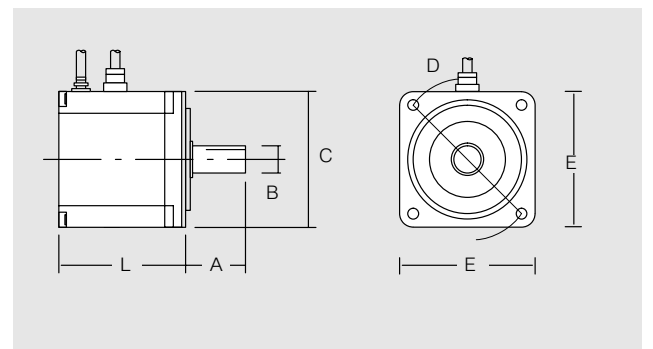

General

The R88A-MCW151 is a 1.5 axis Motion Controller (MC) Unit that connects directly to the W series Servo Drive. The MC Unit provides direct control of the Servo Drive, enables position/speed and torque control, and offers access to detailed servo drive data.

The Multitasking BASIC motion controller language is used to program the MC Unit. A total of up to 14 programs can be stored in the Unit, with up to 3 programs (tasks) running simultaneously. Motion Perfect is the powerful, user-friendly Windows-based software that facilitates highly flexible programming and troubleshooting.

The MC Unit offers functionality including axes synchronisation, various fast registration inputs, electronic CAMs, interpolated movements and built-in general purpose inputs/outputs.

The R88A-MCW151-DRT-E unit includes also DeviceNet connection, providing high system integration.



System Configuration

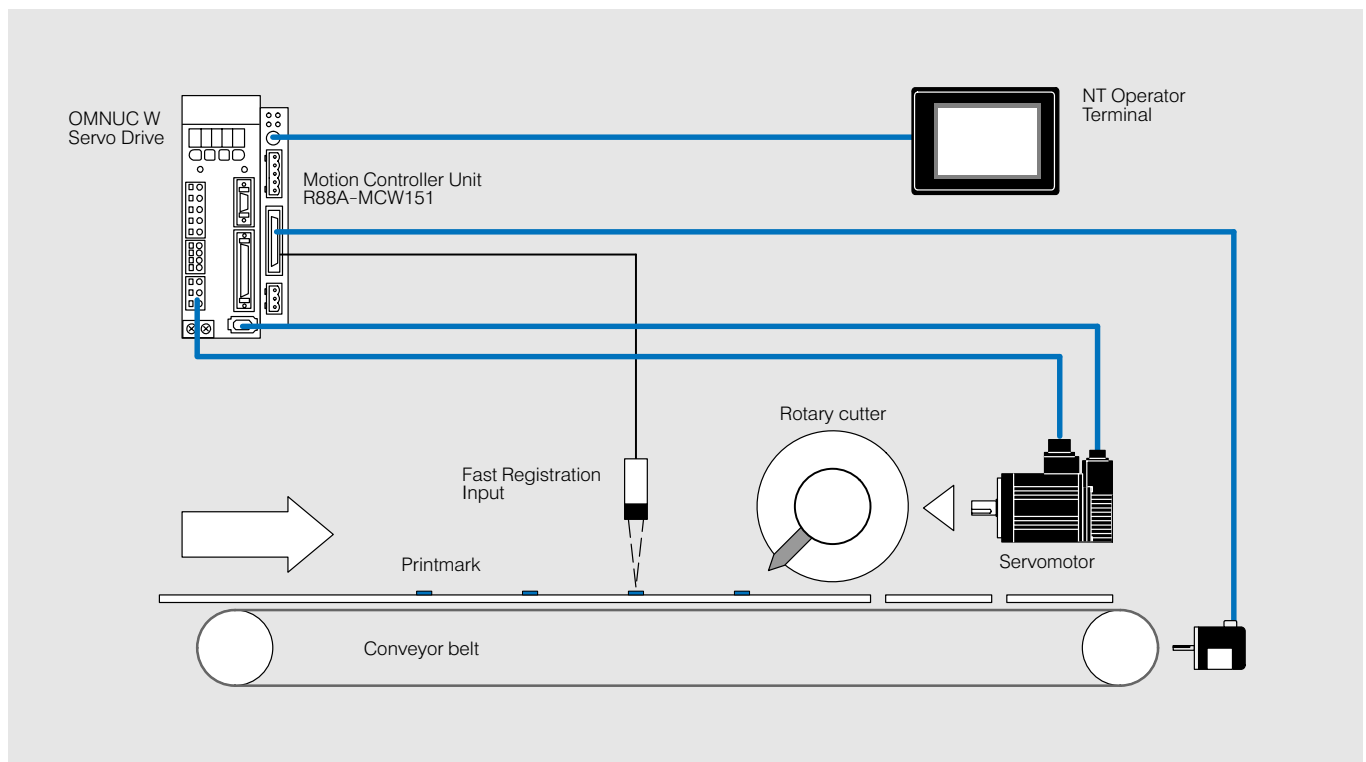

Motion Controller Unit

- 1.5 axes
- Multitasking
- 2x RS-232C communication ports

Communication port

- RS-422A/485 Host Link
- DeviceNet

Model code

- R88A-MCW151-E**
- R88A-MCW151-DRT-E**

Programming, Accessories and Documentation

Programming	Description	Cable length	Model code	
	Motion Perfect Software. Programming, Monitoring and Debugging Software for the R88A-MCW151 and C200HW-MC402 Units. For Windows 95/98/2000 or NT4.0. (Included in the Motion Tools CD)	-	Motion Perfect	
	EDS Files. DeviceNet Electronic Data Sheet. (Included in the Motion Tools CD)	-	_EDS	
	Motion Tools CD. Comprehensive Omron software tools and technical information.	-	MOTION TOOLS	
	Programming cable for R88A-MCW151, port 0 <-> PC (RS-232C)	2 m	R88A-CCM002P4-E	
	Programming and NT monitor cable for R88A-MCW151, ports 0 and 1 <-> PC (RS-232C) and NT monitor	1 m	R88A-CCM001P5-E	
Accessories, cables etc.	Description	Model code		
	I/O connector (included in package)	Weidmüller B2L 3.5/26 SN SW		
	Power connector (included in package)	Phoenix MSTB 2.5/3-ST-5.08		
	Port 2 connector (included in package)	Phoenix MSTB 2.5/5-ST-5.08		
Technical Documentation	English documentation	Product	Title	Model code
		R88A-MCW151-E R88A-MCW151-DRT-E	Operation Manual	I203-E2

Specifications

Number of axes	<ul style="list-style-type: none"> - 1 controlled axis - 1 master axis or encoder output axis or virtual axis - 1 virtual axis
Programming	Multi-Tasking, BASIC type
Communication Interfaces	R88A-MCW151-E <ul style="list-style-type: none"> - 1 RS-232C: Motion Perfect software protocol - 1 RS-232C: Host Link master/slave or ASCII protocol - 1 RS-422: Host Link master/slave or ASCII protocol/RS-485: ASCII protocol R88A-MCW151-DRT-E <ul style="list-style-type: none"> - 1 RS-232C: Motion Perfect software protocol - 1 RS-232C: Host Link master/slave or ASCII protocol - 1 DeviceNet interface
CPU	Texas Instruments TMS320C32, 60 MHz
Available memory	128 kB RAM for programs and data
Drive connection	Connected direct to the DPRAM interface of the W series Servo Drive
Displays	4 LEDs: Controller and Communication status
Commissioning aids	Powerful interactive debugger, monitor and oscilloscope via the Motion Perfect software
Control	Position control in closed loop with encoder feedback (speed and torque control)
Cycle time, position controller	0.5 ms or 1 ms
Positioning functions	<ul style="list-style-type: none"> - Linear interpolation - Circular interpolation - CAM profile - Electronic axes synchronisation - Axes linked CAM profile - Adding profile between axes
Hardware registration inputs	<ul style="list-style-type: none"> - 2 (Master axis registration position on the Unit) - 1 (Servo axis registration position via W series drive registration input)
Digital inputs	<ul style="list-style-type: none"> - 8 (galvanically isolated) - 2 inputs can be used as hardware printmark inputs (delay 15 μs) - Input voltage 24 VDC nominal +10% max - Input impedance 3.3 kΩ - Input current 3.2 mA at 24 VDC - ON level >11 VDC - OFF level <1 VDC - Type: PNP or NPN
Digital outputs	<ul style="list-style-type: none"> - 6 (galvanically isolated) - Overcurrent and overtemperature protection - Current capacity: 100 mA for each output (600 mA total) - Max. voltage: 24 VDC nominal +10% max - Type: PNP
Encoder input (master)	1 Line driver input, max 1500 kpulse/s (6000 kcount/s)
Encoder output	1 Line driver output, max 500 kpulse/s (2000 kcount/s)
Current consumption	170 mA
DeviceNet Features (R88-MCW151-DRT-E only)	<ul style="list-style-type: none"> - Slave messaging: polling adjustable via DIP switches: (4 input words, 4 output words or 2 input words, 2 output words) - Explicit messages supported - Supported baud rates: 125 kbps, 250 kbps, 500 kbps

General

The R88A-NCW152 provides both DeviceNet communication functions and the positioning functions of a positioning controller. These functions can be used very easily in conjunction with the Wseries servo drivers simply by plugging the Option Unit directly into the servo driver.

With the NCW152 Unit it is possible to operate up to 63 W series servo drivers as DeviceNet slaves, allowing a widely distributed control and information management system to be created. The remote I/O commands support positioning commands, parameter read / write and the reading of monitor information. The trace function is available with explicit messages, enabling the user to monitor specific operation in detail and perform failure prediction and diagnostics.

A large number of positioning functions are available, including zero search, point-to-point positioning, multi-speed, indexing, positioning by table entries and step positioning, feed function, backlash compensation and position-based outputs.



System Configuration

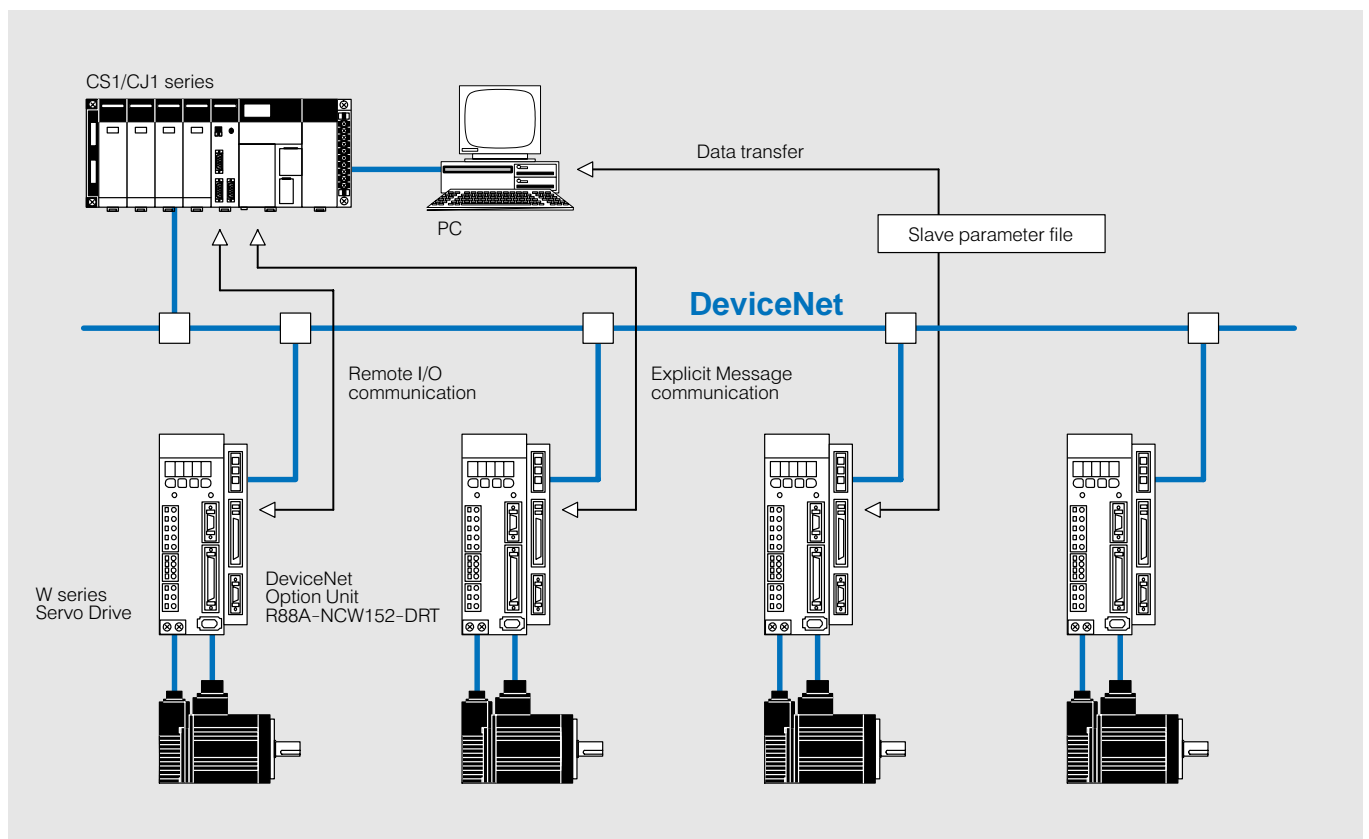

DeviceNet Option Unit

- DeviceNet communication
- Positioning functions

Model code

R88A-NCW152-DRT

Programming, Accessories and Documentation

Programming

Description	Cable length	Model code
NCW152 Setup Tool. WINDOWS-based Software. (Included in the Motion Tools CD)	-	SBCE-011
EDS File. DeviceNet Electronic Data Sheet. (Included in the Motion Tools CD)	-	_EDS
Motion Tools CD. Comprehensive Omron software tool and technical information.	-	MOTION TOOLS
Programming cable for Setup Tool, R88A-NCW152 <-> PC (RS-232C)	2 m	R88A-CCW002P4

Accessories, cables etc.

Description	Model code
External I/O connector (CN4)	R88A-CNU01R
DeviceNet connector with retaining screws	XW4B-05C1-H1-D
DeviceNet connector for Multi-Drop wiring (without screws)	XW4B-05C4-T-D
DeviceNet connector (without screws)	Phoenix MSTB2.5/5-ST-5.08AU

Technical Documentation

English documentation	Product	Title	Model code
	R88A-NCW152-DRT	User Manual	I538-E1

Specifications

Number of axes	1 axis
Regulation	Semi-closed or fully closed control loop
DeviceNet Features	- Slave messaging: Polling explicit messages is supported - Baud rates: 125 kbps, 250 kbps, 500 kbps
RS-232C communication	WINDOWS-based setup tool
Driver connection	Direct connection of the W series Servo driver to the DPRAM interface
Displays	2 LEDs: Module and DeviceNet status
Positioning functions	- 7 origin search modes - 4 types of ramp up/ramp down - 16-stage speed/positioning blocking - Indexing positioning - 50 point tables positioning (speed/position points) - Step positioning - Feeding function
Trace function	Precise monitoring of a specific operation for failure predictions and diagnostics
Digital inputs	- Galvanically isolated - Input voltage: 24 VDC nominal ± 1 V - Input impedance: 3.3 k Ω - Input current: 8 mA max. each - Type: NPN
Digital outputs	- Galvanically isolated - Current capacitance: max. 50 mA - Voltage: max. 30 VDC - Type: NPN
Encoder input	1 Line driver input
Current consumption	250 mA (Power supplied from servo drive)

General

The JUSP-NS500 provides PROFIBUS communications and positioning functionality. These functions can be added to a W-Series Servo Driver simply by mounting the option unit directly to it.

With the PROFIBUS option unit it is possible to operate, from a PROFIBUS master, multiple W-Series Servo Drivers connected as PROFIBUS slaves. The commands from the host controller include positioning commands, reading alarm history and canceling commands.

A variety of positioning functions are available including origin search, point-to-point positioning, point table and step positioning, feeding function, backlash compensation, and two zone signal outputs.



System diagram

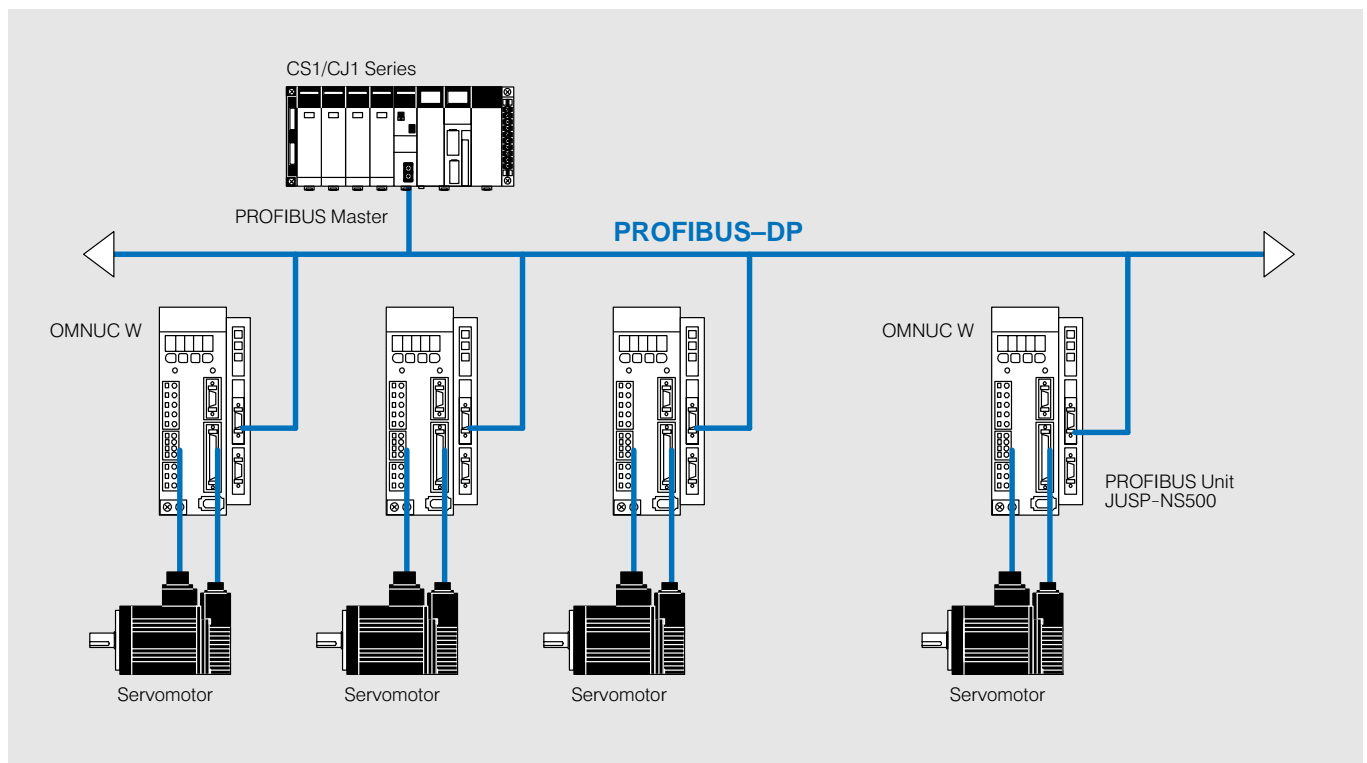

PROFIBUS Interface Unit

- PROFIBUS communications
- Positioning functions

Model number

JUSP-NS500

Programming, Accessories and Documentation

Programming	Discription		Cable length	Model number
	NS Setup Tool For Windows 95/98/2000/NT4.0		-	NS Tool
	Programming cable		2 m	R88A-CCW002P4
Accessories	External I/O connector (CN4)			R88A-CNU01R
Technical Documentation	English Documentation	Model	Title	Model number
		JUSP-NS500	User's Manual	SIE-C718-8

Technical Data/Specifications

Number of axes	1 axis
Regulation	Semi-closed, full-closed loop
PROFIBUS features	PROFIBUS-DP slave: 8 bytes input, 8 bytes output Baud rates: between 9.6 kbps and 12 Mbps
RS-232C communication	Windows-based setup tool
Driver connection	Connected to the W-series servo driver directly to the DPRAM port
Indicators	2 LEDs: Module and PROFIBUS status
Positioning functions	<ul style="list-style-type: none"> - 4 origin search modes - 4 types of acceleration/deceleration - 16-stage speed/position block - Point-to-Point positioning - 50 point table positioning (speed/position points) - Step positioning - Feeding function - 2 zone outputs
Digital inputs	<ul style="list-style-type: none"> - Galvanic isolation - Input voltage: 24 VDC nominal ± 1 V - Input impedance: 3.3 KΩ - Input current: 8 mA max. each - Type: NPN
Digital outputs	<ul style="list-style-type: none"> - Galvanic isolation - Current capacity: 50 mA DC max. - Voltage: 30 VDC max. - Type: NPN
Encoder input	1 Line driver input
Current consumption	Max. operating current 250 mA. (Power supplied from the servo drive)

General

The indexer unit JUSP-NS600 is a servo based positioning controller that connects directly to the W-series Servo Drive and provides direct control of the servo drive eliminating the need of an external axis controller.

Easy setup and maintenance with the Windows based software tool, the system is configured using a fill-in-the-blank style settings and do not requires a specific language programming.

The indexer unit enhances the W-series features with versatile point-to-point positioning, conditional profile execution in response to a registration input, definable zone signal outputs, built-in routines and settable positioning condition outputs. Control can be performed using the built-in I/O and via serial network commands.



System diagram

Serial network control

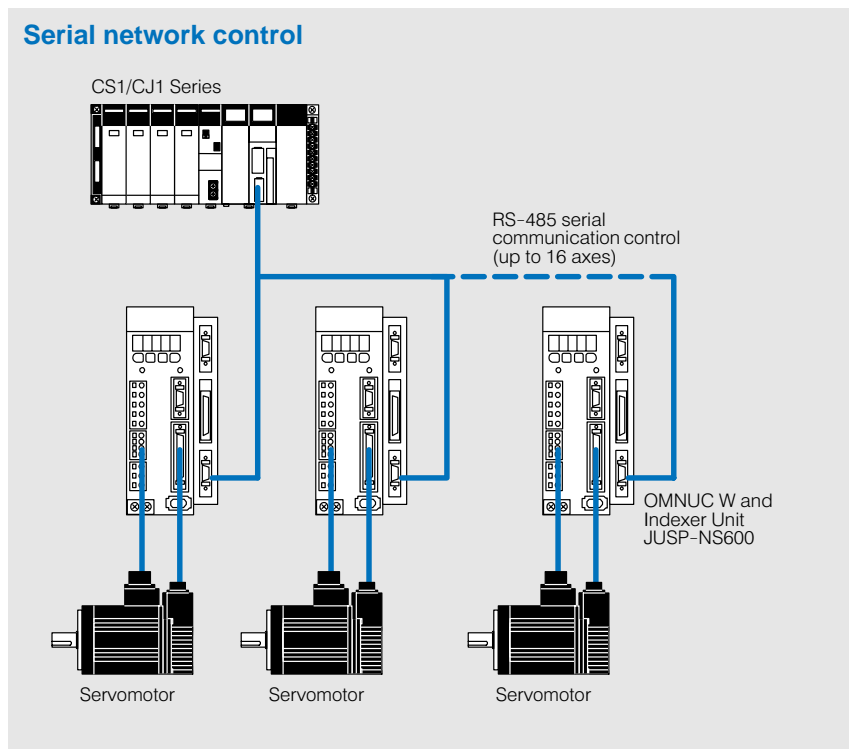

Discrete I/O control

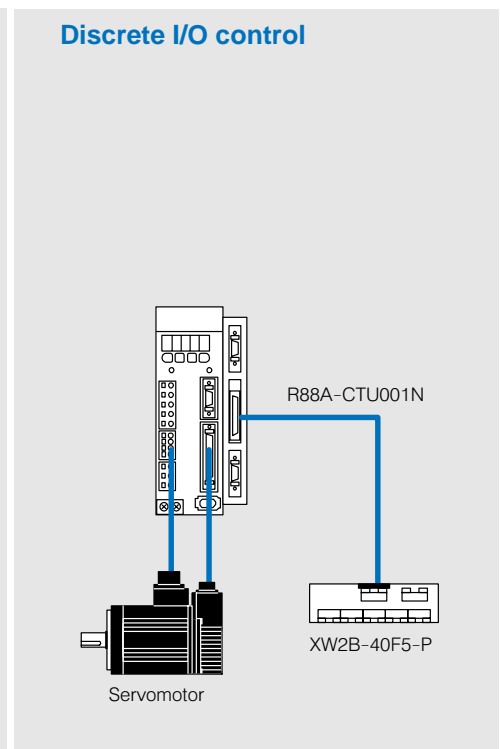

Indexer Unit

- Versatile point-to-point positioning
- Built-in I/O and serial control

Model number

JUSP-NS600

Programming, Accessories and Documentation

	Discription	Cable length	Model number
Programming	Index Works Setup Tool For Windows 95/98/2000/NT4.0	-	Index Works
	Programming cable	2 m	R88A-CCW002P2
Accessories	Terminal Block	-	XW2B-40F5-P
	Connecting cable from NS600 I/O connector to terminal block	1 m	R88A-CTU001N
		2 m	R88A-CTU002N
	Connecting cable to I/O connector with open end	1 m	FND-CCX001S
		2 m	FND-CCX002S
	Indexer digital I/O connector (CN4)	-	R88A-CNU01C
	Serial communications connectors (CN6, CN7)	-	R88A-CNX01C
Technical Documentation	English Documentation	Model JUSP-NS600	Title User's Manual
			Model number SIE-C718-9

Technical Data/Specifications

Number of Axes	1 axis
Regulation	Closed loop using motor feedback encoder (incremental or absolute).
Digital operator interface (CN7)	Full duplex (RS-422 or RS-232C) up to 16 axes.
Serial command interface (CN6)	Full duplex (RS-422, RS-485 or RS-232C) or Half duplex (RS-485), up to 16 axes.
Driver connection	Connected to the W-Series Servo Driver directly to the DPRAM port
Positioning functions	<ul style="list-style-type: none"> - Built-in origin search routines - 16 preset speeds - 128 indexing programmed moves - Indexing moves with or without registration - 32 definable signal output zones - Loop linking of index moves - Linking index moves with a combination of events - Settable positioning condition outputs - Built-in routines for single axis applications
Serial network control	<ul style="list-style-type: none"> - Up to 16 addressable station - Axis set-up, actuation and monitoring - Immediate interpretation of serial positioning commands - Selection of programmable steps - Open ASCII protocol
Digital inputs	<ul style="list-style-type: none"> - Galvanic isolation - Input voltage: 24 VDC nominal $\pm 1V$ - Input Impedance: 3.3 KΩ - Input current: 8 mA max. each - Type: PNP or NPN
Digital outputs	<ul style="list-style-type: none"> - Galvanic isolation - Current capacity: 50 mA DC max. - Voltage: 30 VDC max. - Type: NPN
Current consumption	Max. operating current 500 mA (Power supplied from the servo drive).