

SIEMENS

SIMATIC HMI

HMI device

Industrial Thin Client ITC1200,
ITC1500, ITC1900, ITC2200

Operating Instructions

Preface

Overview

1

Safety instructions

2

Installing and connecting the device

3

Commissioning the device

4

Assigning device parameters

5

Configuring the server

6

Operating the device

7

Device maintenance and repair

8

Technical specifications

9

Technical Support

A

Abbreviations

B

Legal information

Warning notice system

This manual contains notices you have to observe in order to ensure your personal safety, as well as to prevent damage to property. The notices referring to your personal safety are highlighted in the manual by a safety alert symbol, notices referring only to property damage have no safety alert symbol. These notices shown below are graded according to the degree of danger.

DANGER

indicates that death or severe personal injury **will** result if proper precautions are not taken.

WARNING

indicates that death or severe personal injury **may** result if proper precautions are not taken.

CAUTION

indicates that minor personal injury can result if proper precautions are not taken.

NOTICE

indicates that property damage can result if proper precautions are not taken.

If more than one degree of danger is present, the warning notice representing the highest degree of danger will be used. A notice warning of injury to persons with a safety alert symbol may also include a warning relating to property damage.

Qualified Personnel

The product/system described in this documentation may be operated only by **personnel qualified** for the specific task in accordance with the relevant documentation, in particular its warning notices and safety instructions. Qualified personnel are those who, based on their training and experience, are capable of identifying risks and avoiding potential hazards when working with these products/systems.

Proper use of Siemens products

Note the following:

WARNING

Siemens products may only be used for the applications described in the catalog and in the relevant technical documentation. If products and components from other manufacturers are used, these must be recommended or approved by Siemens. Proper transport, storage, installation, assembly, commissioning, operation and maintenance are required to ensure that the products operate safely and without any problems. The permissible ambient conditions must be complied with. The information in the relevant documentation must be observed.

Trademarks

All names identified by ® are registered trademarks of Siemens AG. The remaining trademarks in this publication may be trademarks whose use by third parties for their own purposes could violate the rights of the owner.

Disclaimer of Liability

We have reviewed the contents of this publication to ensure consistency with the hardware and software described. Since variance cannot be precluded entirely, we cannot guarantee full consistency. However, the information in this publication is reviewed regularly and any necessary corrections are included in subsequent editions.

Preface

Purpose of the operating instructions

These operating instructions provide information based on the requirements defined by DIN EN 62079 for mechanical engineering documentation. This information relates to the place of use, transport, storage, mounting, use and maintenance.

These operating instructions are intended for the following user groups:

- Operators

The following chapters are of relevance:

- Overview (Page 9)
- Operating the device (Page 95)

- Administrator

The following chapters are of relevance:

- Overview (Page 9)
- Assigning device parameters (Page 39)
- Configuring the server (Page 85)

- Commissioning engineers

The following chapters are of relevance:

- Overview (Page 9)
- Installing and connecting the device (Page 23)
- Configuring the server (Page 85)

- Maintenance personnel

The following chapters are of relevance:

- Overview (Page 9)
- Device maintenance and repair (Page 105)

Chapter Safety instructions (Page 19) must be particularly observed by all user groups.

Basic knowledge required

General knowledge of automation technology and process communication is needed to understand the operating instructions.

It is also assumed that those using the manual have experience in using personal computers and knowledge of Microsoft operating systems.

Scope of the operating instructions

These operating instructions apply to the following devices:

- SIMATIC ITC1200
- SIMATIC ITC1500
- SIMATIC ITC1900
- SIMATIC ITC2200

The designation "ITC (Industrial Thin Client)" encompasses all of the named devices.

Registered trademarks

The following designations marked with the symbol ® are registered trademarks of Siemens AG:

- HMI®
- SIMATIC®
- WinCC®

Conventions

The following text notation will facilitate reading this manual:

Notation	Scope
"Add screen"	<ul style="list-style-type: none">• Terminology that appears in the user interface, for example dialog names, tabs, buttons, menu commands• Required input, for example, limits, tag values.• Path information
"File > Edit"	Operating sequences, for example, menu commands, shortcut menu commands
<F1>, <Alt+P>	Keyboard operation

Please observe notes labeled as follows:

Note

Notes contain important information concerning the product, its use or a specific section of the documentation to which you should pay particular attention.

Illustrations in this manual

This documentation includes illustrations associated with the product. These illustrations may differ from the factory state of the product.

Recycling and disposal

The HMI devices described in these operating instructions can be recycled due to the low levels of pollutants. Contact a certified disposal service company for environmentally sound recycling and disposal of your old devices.

Table of contents

	Preface	3
1	Overview.....	9
1.1	Product description	9
1.2	Product package	11
1.3	Layout of the devices	12
1.3.1	Interfaces	13
1.4	Accessories.....	14
1.5	Typical applications.....	14
1.6	System requirements	18
2	Safety instructions.....	19
2.1	General safety instructions	19
2.2	Security information	20
3	Installing and connecting the device	23
3.1	Brief instructions - connecting and starting the device	23
3.2	Preparing for installation	23
3.2.1	Checking the package contents.....	24
3.2.2	Checking the operating conditions.....	24
3.2.3	Selecting a mounting position	25
3.2.4	Checking clearances.....	26
3.2.5	Preparing the mounting cutout.....	26
3.3	Mounting the device.....	28
3.4	Connecting the device	30
3.4.1	Overview	30
3.4.2	Connection of equipotential bonding	31
3.4.3	Connecting the power supply	33
3.4.4	Connecting device to the server	34
3.4.5	Connecting a USB device.....	35
3.5	Installing strain relief	35
4	Commissioning the device	37
4.1	Switching on and testing the device	37
4.2	Interrupting and restoring a connection	38
5	Assigning device parameters	39
5.1	Possible applications	39
5.2	Opening the configuration.....	40
5.3	Configuration settings of the device.....	43

5.3.1	Access and structure	43
5.3.2	Device data	45
5.3.3	System settings.....	46
5.3.4	Network settings.....	51
5.3.5	Connections	55
5.3.5.1	Basics.....	55
5.3.5.2	Setting up client-server connections	57
5.3.5.3	Connection settings	58
5.3.5.4	Setting up startup connection	61
5.3.5.5	PROFINET basic functions	62
5.3.6	Password settings.....	63
5.3.7	Desktop settings.....	66
5.3.8	Application settings	69
5.4	Remote configuration of several devices.....	71
5.4.1	Introduction	71
5.4.2	Installation	71
5.4.3	Start.....	73
5.4.4	Operation	74
5.4.4.1	Overview of remote operation.....	74
5.4.4.2	Perform action.....	78
5.4.4.3	Status	79
5.4.4.4	Assigning the IP address	80
5.4.5	Backing up remote configuration	81
5.4.6	Assigning a key	82
5.4.7	Basic settings	83
6	Configuring the server.....	85
6.1	RDP.....	85
6.1.1	RDP overview	85
6.1.2	Administration on the server	86
6.2	Citrix:.....	87
6.2.1	Citrix overview.....	87
6.2.2	Connecting to a Citrix application or a desktop	87
6.2.3	Restrictions	89
6.3	VNC.....	90
6.4	Sm@rtServer	91
6.5	SINUMERIK	92
6.6	WinCC OA.....	93
7	Operating the device.....	95
7.1	Overview	95
7.2	Front operator controls.....	96
7.3	Operating the taskbar	97
7.3.1	Structure and functions of the taskbar	97
7.3.2	Starting a connection	99
7.3.3	Changing from one connection to another.....	100
7.3.4	Terminating a connection.....	101
7.4	Operating the on-screen keyboard	102
7.5	Operating a USB memory device	103

8	Device maintenance and repair	105
8.1	Cleaning the device front	105
8.2	Disabling the touch screen	106
8.3	Calibrating the touch screen	106
8.4	Spare parts and repairs	107
9	Technical specifications	109
9.1	Certificates and approvals	109
9.2	Directives and declarations	111
9.2.1	Electromagnetic compatibility	111
9.2.2	ESD guideline	112
9.3	Dimensional drawings	114
9.3.1	Dimensional drawings of ITC1200	114
9.3.2	Dimensional drawings of ITC1500	115
9.3.3	Dimensional drawings of ITC1900	116
9.3.4	Dimensional drawings of ITC2200	117
9.4	Technical specifications	118
9.4.1	General technical specifications	118
9.4.2	Performance data	120
9.4.3	Ambient conditions	120
9.4.3.1	Transport and storage conditions	120
9.4.3.2	Operating conditions	121
9.4.3.3	Information on insulation tests, protection class and degree of protection	124
9.5	Description of the ports	125
9.5.1	Power supply	125
9.5.2	USB	125
9.5.3	PROFINET (LAN) 10/100/1000 Mb	126
A	Technical Support	127
A.1	Service and support	127
B	Abbreviations	129
	Glossary	131
	Index	135

Overview

1.1 Product description

SIMATIC ITC - the high-performance local thin client solution

Industrial Thin Clients are low-cost HMI terminals that provide local HMI functionality in plants spread over large areas. In this way, Industrial Thin Clients contribute to an improved overview, operability, and productivity of plants. In addition, the Industrial Thin Clients also reduce the total cost of ownership (TCO) by virtue of their extremely easy commissioning, efficient Ethernet networking, reduced software costs, and minimal service costs.

The Industrial Thin Client always communicates with a host, such as an HMI device, industrial PC, or server, via the following connection types:

- Web browser functionality
- SIMATIC WinCC Sm@rtServer
- Standard RDP (Remote Desktop Protocol) from Microsoft
- VNC (Virtual Network Computing)
- SINUMERIK connection
- On-demand application service from Citrix
- WinCC OA

The Industrial Thin Client itself requires no installation and no licenses to operate. For remote configuration, we offer the Management Software Remote Configuration Center at (as of RCC V2.0). You can also bridge greater distances via Ethernet.

You can do the following from the Industrial Thin Client:

- Display and run web-based content from a web server available on the network (e.g., S7 controller, Intranet/Internet) via the integrated web browser.
- Run WinCC projects on other HMI devices or industrial PCs via Sm@rtServer.
- Run HMI applications (e.g., WinCC), Office applications (e.g., Excel), or SAP directly at the machine via RDP.
- Operate a PC remotely with VNC (similar to RDP)
- Use the SINUMERIK connection to make the Industrial Thin Client a SINUMERIK Thin Client Unit (TCU).
- Access a Citrix server as Citrix client.
- Access a WinCC OA server as client.

Hardware equipment

The device is available with 12", 15", 19", or 22" LCD TFT widescreen display with 16 million colors. You operate the device via the touch screen or a keyboard/mouse connected to the two USB ports.

In terms of the mounting cutout (width and height) and design, the Industrial Thin Client built-in units are compatible with the SIMATIC HMI Comfort Panels of the same size.

Easy commissioning



The Industrial Thin Client merely requires an IP address. For fast on-site commissioning and diagnostics, the SIMATIC ITC is equipped with a Setup Wizard optimized for touch operation. Alternatively, the Remote Configuration Center (RCC V2.0 or higher) management software enables easy, efficient remote configuration and diagnostics of one or more devices. Local software installation on the device is not necessary. The display and user interface of the application are provided by the host.

High robustness

As a remote operator terminal without any rotating media (hard drive or fan), you can operate the Industrial Thin Client on machines having stringent requirements for mechanical robustness.

1.2 Product package

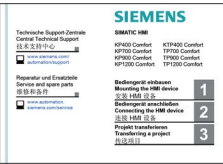
The following components are included in the scope of delivery of the device:

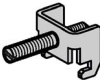
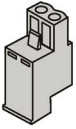
Designation	Figure	Quantity	
HMI device		1	
Installation instructions (Quick Installation Guide)		1	
Remote Configuration Center (RCC).	On CD	1	
Mounting clamps with threaded pin		12	ITC1200
		12	ITC1500 ITC1900 ITC2200
Mains terminal		1	

1.3 Layout of the devices

Front view and side view

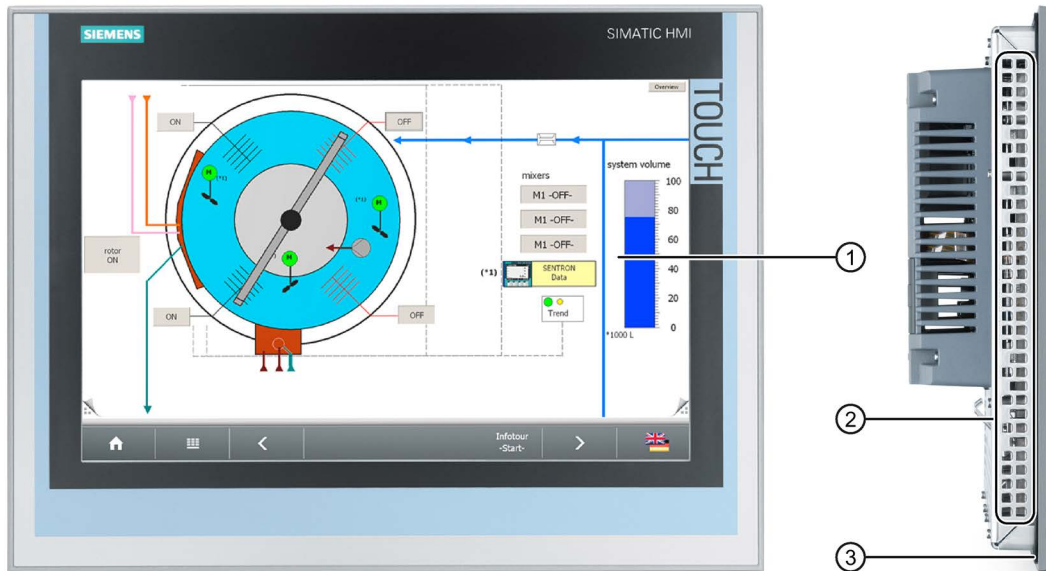

- ① Touch screen
- ② Recesses for mounting clamps
- ③ Mounting seal

Bottom view

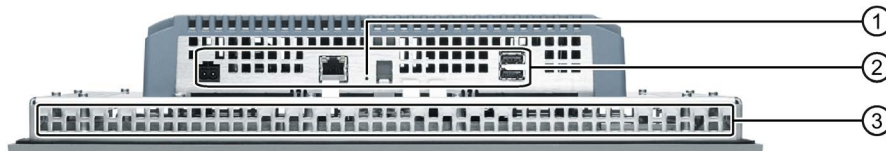

- ① "Factory settings" key
- ② Interfaces
- ③ Recesses for mounting clamps

Rear view

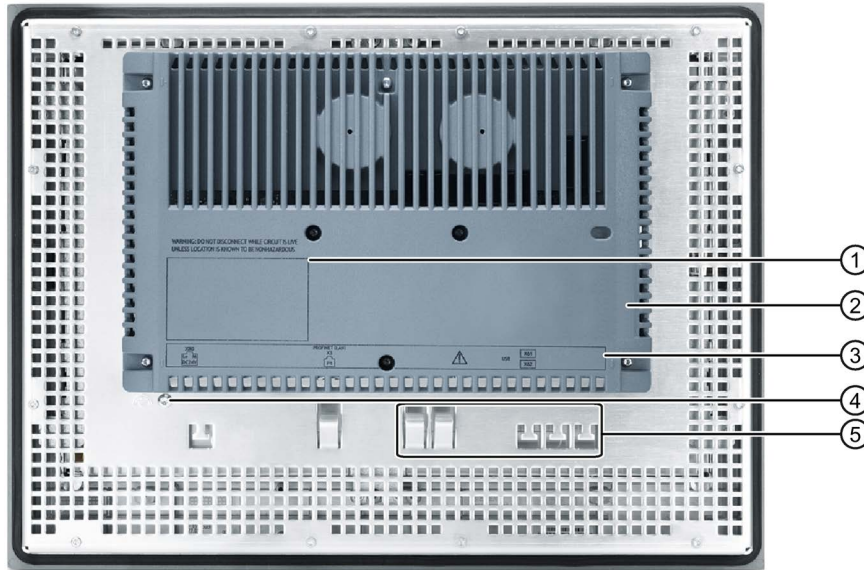

- ① Rating plate
- ② Cover
- ③ Interface designation
- ④ Ground connection
- ⑤ Fixing elements for strain relief

1.3.1 Interfaces

The following figure shows the interfaces on the device.

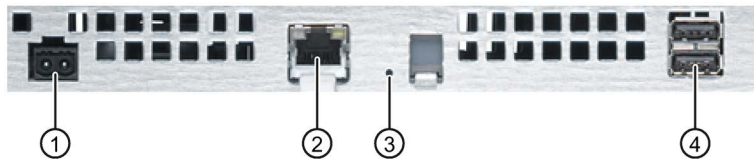

- ① Power supply connector
- ② LAN interface (PROFINET/Ethernet)
- ③ "Factory settings" key
- ④ USB ports

1.4 Accessories

Accessories are not included in the scope of delivery of the HMI device, but can be ordered on the Internet at Industry Mall (<http://mall.automation.siemens.com>).

This section provides information on the scope of accessories available at the time these operating instructions were written.

Protective films

Designation	Order No.
Protective film set for ITC1200	6AV2124-6MJ00-0AX0
Protective film set for ITC1500	6AV2124-6QJ00-0AX0
Protective film set for ITC1900	6AV2124-6UJ00-0AX0
Protective film set for ITC2200	6AV2124-6XJ00-0AX0

Service packages

Designation	Order No.
Set of 20 aluminum mounting clamps for ITC1200	6AV6671-8XK00-0AX0
Set of 20 steel mounting clamps for ITC1500, ITC1900, and ITC2200	6AV6671-8XK00-0AX3
Set of 10 mains terminals	6AV6671-8XA00-0AX0

1.5 Typical applications

Industrial Thin Clients can be used as operator terminals in different scenarios. With the Industrial Thin Client, for example, you can access an HMI device and hence control a work process. You can also use the Industrial Thin Client to run Office applications on a server, for example, on a PC and modern web applications.

Typical applications are presented in the following.

Access to a Sm@rtServer

The Industrial Thin Client accesses an HMI device or industrial PC as a Sm@rtServer client using the SIMATIC WinCC Sm@rtServer option. You are operating and monitoring a WinCC project (TIA Portal). You operate and monitor a WinCC flexible project with the SIMATIC WinCC Sm@rtAccess option in the same way.

The following figure shows one possible configuration.

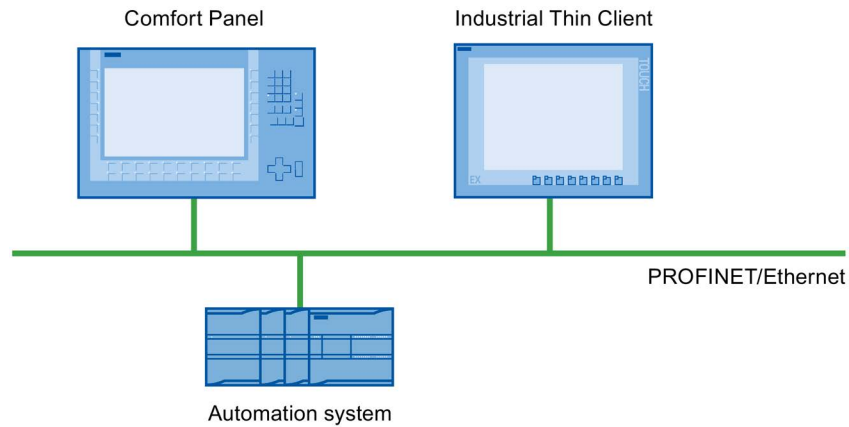

Access to a server via "RDP".

The Industrial Thin Client uses RDP (Remote Desktop Protocol) to access a server, such as an industrial PC or a PC. The following applications are also possible.

- WinCC/Web Navigator

The Industrial Thin Client uses an Internet browser on the server to access the WinCC Web Navigator as a Web Navigator client. In this case, the Windows Server operating system must be installed on the server. For more information, refer to the documentation for the WinCC/Web Navigator option.

- The Industrial Thin Client accesses an Office application (e.g., MS Excel) or SAP application on the server. In contrast to the Windows Server operating systems, you can only operate one screen with Windows 7. The other monitor is always blocked.
- The Industrial Thin Client accesses an Office application, such as MS Excel, running with the Windows Server operating system or a SAP application on the server.

The following figure shows one possible configuration with the Windows Server operating system on an Industrial PC or a PC.

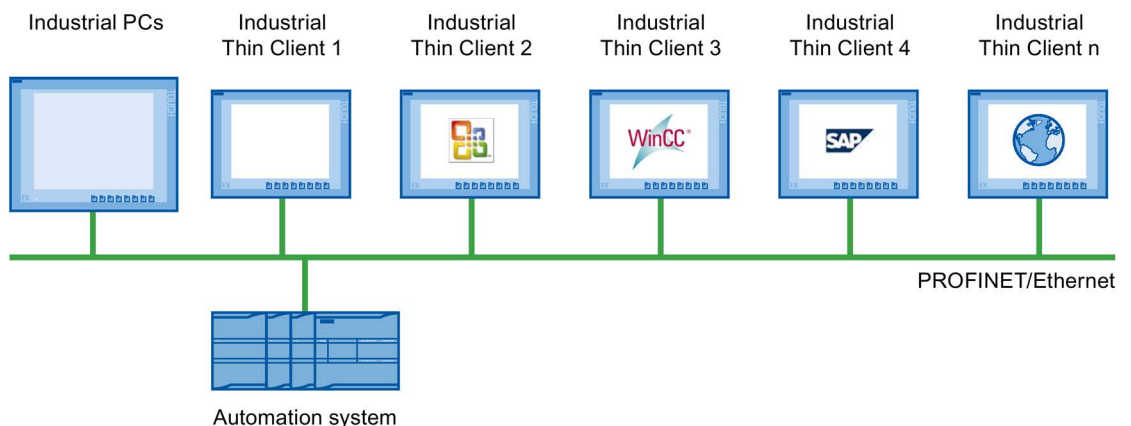

Access to a server via "VNC"

You use VNC in a similar way as RDP to remotely monitor and run a PC and to monitor its screen outputs. In contrast to RDP, all clients display the same server screen.

Access to SINUMERIK

The Industrial Thin Client accesses the SINUMERIK system network through the SINUMERIK connection. The system network configures the Industrial Thin Client to be a SINUMERIK Thin Client Unit (TCU). You use the TCU for operator control and monitoring of a SINUMERIK PCU or SINUMERIK NCU.

Access to a web server via "Web"

The Industrial Thin Client displays applications and the content of a web server using the integrated web browser functionality . Web-based content may be diagnostic or user-specific web pages of an S7 controller (PROFINET), for example, or content from the Intranet/Internet.

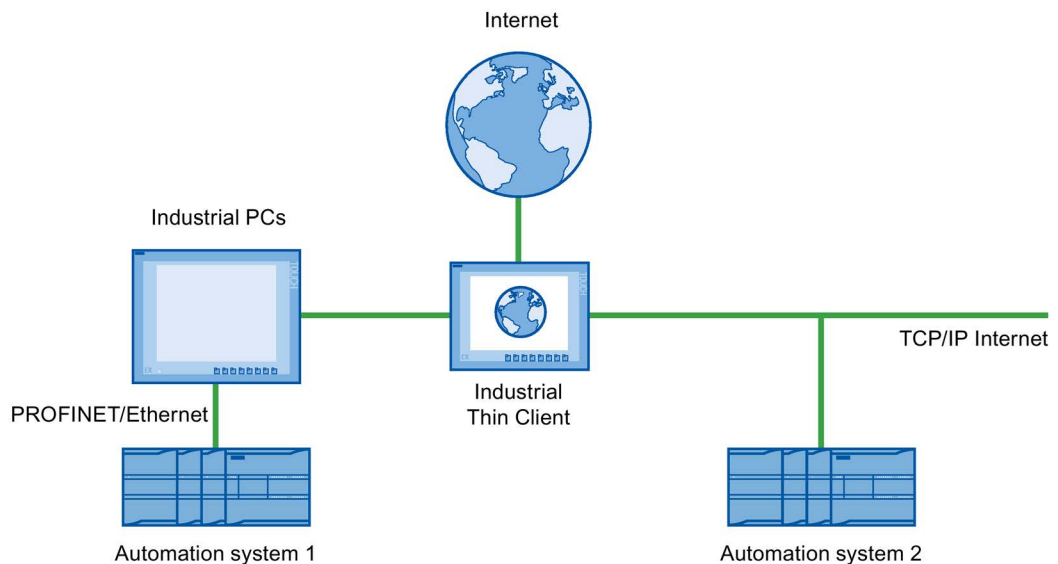

Access to a web server via the "WinCC OA"

The Industrial Thin Client operates similarly to a SIMATIC WinCC OA WebClient. The WinCC OA server makes the client component available to the Industrial Thin Client.

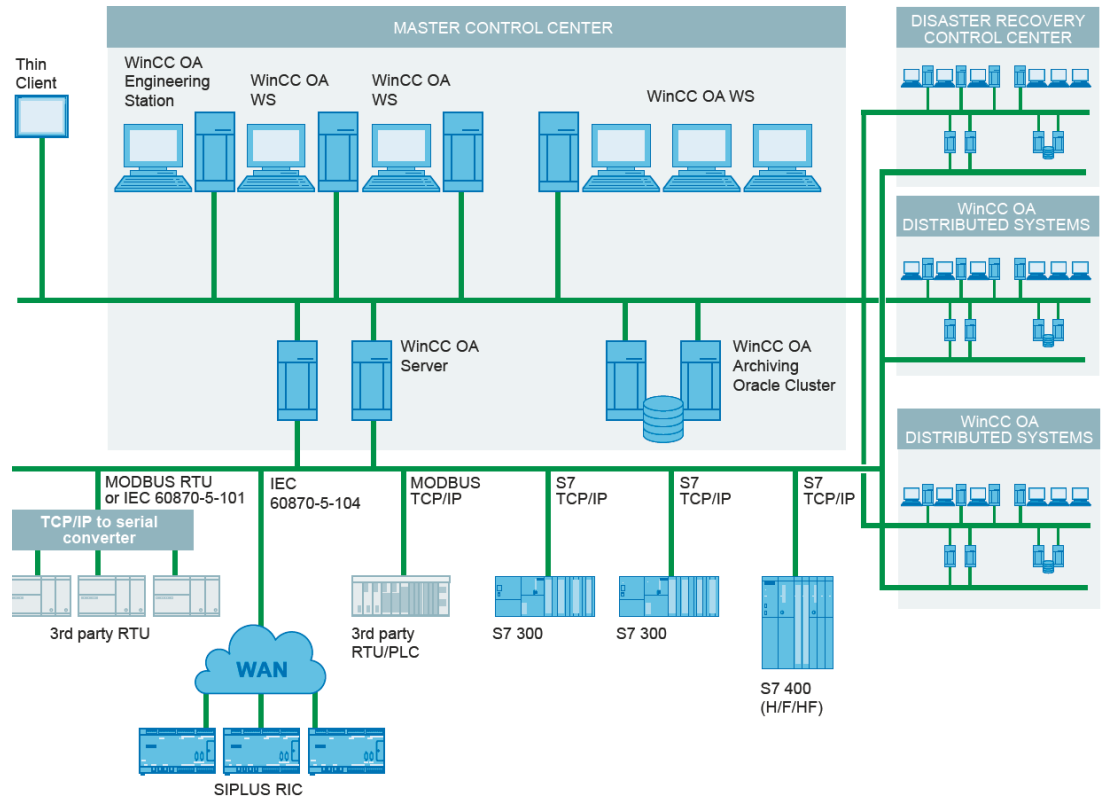

1.6 System requirements

The following list shows the operating system and software requirements depending on the specific type of connection.

- RDPm, Sm@rt Server, Sm@rt Access

RDP	Sm@rt Server	Sm@rt Access	
X			Windows Server 2008 R2 SP1 (64-bit)
X			Windows Server 2012 (64-bit)
X			Windows Server 2012 R2 (64-bit)
X			Microsoft Windows 7 Professional/Enterprise/Ultimate (32-bit and 64-bit)
X			Windows Embedded Standard 7 SP1 (32-bit and 64-bit)
X			Windows Embedded 8 Standard (32-bit and 64-bit)
X			Windows Embedded 8.1 Industry (32-bit and 64-bit) (Pro)
X			Windows 8.1 PRO (32-bit and 64-bit)
	X		As of SIMATIC WinCC V11 (TIA Portal) with the options: <ul style="list-style-type: none"> • SIMATIC WinCC Sm@rtServer for SIMATIC Panels • SIMATIC WinCC Sm@rtServer for Runtime Advanced
		X	SIMATIC WinCC flexible 2008 SP1 with the option: <ul style="list-style-type: none"> • Sm@rtAccess for SIMATIC Panel • Sm@rtAccess for WinCC flexible Runtime

- VNC: TightVNC and UltraVNC, for example, are supported.
- WinCC OA: The connection to WinCC OA is supported with version WinCC OA 3.14. Support with an earlier version can be requested from the WinCC OA team. Additional information can be found on the Internet at the following address: SIMATIC WinCC Open Architecture (<http://w3.siemens.com/mcms/human-machine-interface/en/visualization-software/simatic-wincc-open-architecture/wincc-oa-basic-sw/Pages/default.aspx>).
- Citrix: The current Citrix version is supported. The corresponding system requirements apply. You can find additional information on the Internet at the following address: Citrix product page (<https://www.citrix.com/products.html>)
- SINUMERIK: SINUMERIK is available as of V4.5 SP2. Information on the supported version of SINUMERIK PCU with basic PCU software as well as SINUMERIK NCU with CNC software is available on the Internet at "http://support.industry.siemens.com" (see Service&Support Portal at Technical Support/in short Technical Support (http://www.siemens.de/automation/csi_en_WW)):
 - SINUMERIK Hotline: same "Access channels" as SIMATIC.
 - Online: by "Support Request".

Safety instructions

2.1 General safety instructions

Open equipment and the Machinery Directive

 **WARNING**

The device constitutes open equipment

The device constitutes open equipment. This means that the device may only be installed in enclosures or cabinets which provide front access for operating the device.

Access to the enclosure or cabinet in which the device is installed should only be possible by means of a key or tool and for trained and authorized personnel.

Electrocution risk when control cabinet is open

When you open the control cabinet, there may be a dangerous voltage at certain areas or components.

Touching these areas or components can cause electrocution.

Always disconnect the cabinet from the mains before opening it.

The device may only be used in machines which comply with the Machinery Directive

The Machinery Directive specifies precautions to be taken when commissioning and operating machinery within the European Economic Area.

Failure to follow these precautions is a breach of the Machinery Directive. Such failure may also cause personal injury and damage depending on the machine operated.

The machine in which the HMI device is to be operated must conform to Directive 2006/42/EC.

Hazardous areas

When operating the HMI device in hazardous areas the following warning applies.

 WARNING
Explosion Hazard Do not disconnect while circuit is live unless area is known to be non-hazardous. Substitution of components may impair suitability for Class I, Division 2 or Zone 2. Risque d'Explosion Ne pas déconnecter pendant que le circuit est sous tension, sauf si la zone est non-dangereuse. Le remplacement de composants peut compromettre leur capacité à satisfaire à la Classe I, Division 2 ou Zone 2.

High frequency radiation

NOTICE
Unwanted operating states High-frequency radiation, for example from cellular phones, interferes with device functions and can cause device malfunction. This causes injury and damages the system. Avoid high-frequency radiation: <ul style="list-style-type: none">• Remove the sources of radiation from the vicinity of the device.• Switch off radiating devices.• Reduce the radio output of radiating devices.• Observe the information on electromagnetic compatibility (Page 121).

2.2 Security information

Siemens offers IT security mechanisms for its portfolio of automation and drive products in order to support safe operation of the plant/machine. We recommend that you stay informed about the IT security developments for your products. For information on this topic, refer to: Industry Online Support (http://www.siemens.de/automation/csi_en_WW): You can register for a product-specific newsletter here.

For the safe operation of a plant/machine, however, it is also necessary to integrate the automation components into an overall IT security concept for the entire plant/machine, which corresponds to the state-of-the-art IT technology. You can find information on this under: Industrial Security (<http://www.siemens.com/industrialsecurity>).

Products used from other manufacturers should also be taken into account here.

Remote maintenance is not recommended for production and should be disabled before production is started.

The remote maintenance settings are disabled by default. If you enable them for maintenance purposes, disable the remote maintenance settings once again for production in the start menu "Configuration > System", "Remote maintenance" (see configuration settings, section "System settings").

If you use **Remote configuration** in production, we recommend using your own, private key for security reasons (see section "Remote configuration of several devices", "Key assignment").

If you are using a private key, the remote configuration service is only guaranteed from a PC with installed private key file. Assign a password for logging on to the PC.

The **Remote configuration service (SSH)** is enabled by default. If you do not need remote configuration, disable remote configuration in the system settings of the device during production (see section "Remote configuration of several devices", "Securing remote configuration").

Installing and connecting the device

3.1 Brief instructions - connecting and starting the device

Procedure

Step	See also	
Place the device in the mounting cutout, and fasten the HMI device with the mounting clamps.	Mounting the device (Page 28)	
Connect the equipotential bonding.	Connection of equipotential bonding (Page 31)	
Connect the power supply.	Connecting the power supply (Page 33)	
Connect PROFINET/Ethernet.	Connecting device to the server (Page 34)	
Optional: Connect an external USB device.	Connecting a USB device (Page 35)	
Switch on the power supply.	Switching on and testing the device (Page 37)	
Start the Setup wizard and follow the instructions on the screen. You can also open the configuration settings from the taskbar in the "Configuration" Start menu.	Structure and functions of the taskbar (Page 97)	
	Select the network connection.	Network settings (Page 51)
	Enter the IP addresses and further access parameters of the required server.	Setting up client-server connections (Page 57)
	Create a new administrator password.	Password settings (Page 63)
	Close the dialog with "Save" or "Exit".	
Start the required client-server connection.	Structure and functions of the taskbar (Page 97)	

3.2 Preparing for installation

Select the mounting location of the HMI device

Points to observe when selecting the mounting location:

- Position the HMI device so that it is not subjected to direct sunlight.
- Position the HMI device such that it is ergonomically accessible for the operator.
Choose a suitable mounting height.
- Ensure that the air vents of the HMI device are not covered as a result of the mounting.
- Note the permissible mounting positions.

3.2.1 Checking the package contents

Check the package content for visible signs of transport damage and for completeness.

Note

If a part is damaged

A damaged part will cause the HMI device to malfunction.

Do not install parts damaged during shipment. In the case of damaged parts, contact your Siemens representative.

The following is included in the scope of delivery of the device:

- The device itself
- Accessory kit with mounting clamps and mains terminal
- CD with RCC remote configuration software and the source codes for the open source software
- Additional documents as required

The documentation belongs to the device and is required for subsequent commissioning. Retain all enclosed documentation for the entire service life of the HMI device. You must pass on the enclosed documentation to any subsequent owner or user of the HMI device. Make sure that every supplement to the documentation that you receive is stored together with the operating instructions.

3.2.2 Checking the operating conditions

Note the following aspects before installing the HMI device:

1. Familiarize yourself with the standards, approvals, EMC parameters and technical specifications for operation of the HMI device. This information is available in the following sections:
 - Certificates and approvals (Page 109)
 - Electromagnetic compatibility (Page 111)
2. Check the mechanical and climatic ambient conditions for operation of the HMI device: Ambient conditions (Page 120).

3.2.3 Selecting a mounting position

Mounting position

The device is suitable for installation in:

- Mounting cabinets
- Control cabinets
- Switchboards
- Consoles

In the following, all of these mounting options are referred to by the general term "control cabinet".

The device is self-ventilated and approved for vertical mounting and mounting at an angle in stationary control cabinets.

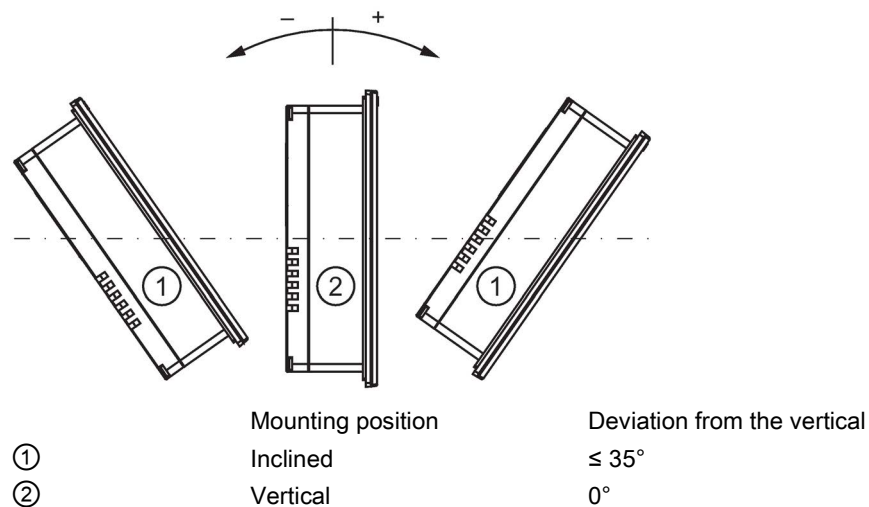

NOTICE

Damage due to overheating

Convection through the device is reduced when it is installed at an angle. This means that the maximum permitted ambient temperature for operation is also reduced.

With sufficient forced ventilation, you can operate the device when installed at an angle up to the maximum permitted ambient temperature for vertical installation.

Otherwise, the approvals and warranty will be voided.

3.2.4 Checking clearances

The following clearances around the device are required:

- Above and below the mounting cutout for ventilation purposes: 50 mm each
- Right and left of the mounting cutout for attaching the mounting clamps:
 - When using metal mounting clamps: 15 mm each
 - When using a clamping frame, independent of the type of mounting clamp used: 25 mm each
- At the rear in addition to the mounting cutout of the device: at least 10 mm

Note

Ensure compliance with the permissible ambient temperature when the device is installed in a cabinet and especially in a closed enclosure.

3.2.5 Preparing the mounting cutout

Note

Stability of the mounting cutout

The material in the area of the mounting cutout must provide sufficient strength to guarantee the enduring and safe mounting of the HMI device.

The force of the clamps or operation of the device may not lead to deformation of the material in order to achieve the degrees of protection described below.

Degrees of protection

The degrees of protection of the HMI device can only be guaranteed if the following requirements are met:

- Material thickness at the mounting cutout for IP65 degree of protection or Front face only Type 4X/Type 12 (indoor use only): 2 mm to 6 mm
- Permitted deviation from plane at the mounting cutout: ≤ 0.5 mm
This condition must be fulfilled for the mounted HMI device.
- Permissible surface roughness in the area of the seal: ≤ 120 μm (R_z 120)

Compatibility of the mounting cutout to other HMI devices

The mounting cutouts of all devices with widescreen display of comparable display size are compatible.

Keep in mind that even though the dimensions of the mounting cutout are identical, the device depth and/or enclosure front dimensions may differ from the corresponding dimensions of the predecessor devices and other widescreen displays.

Dimensions of the mounting cutout

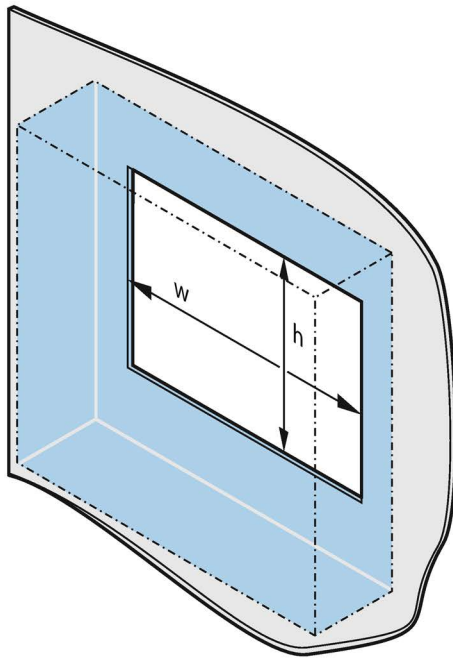

	w_0^{+1}	h_0^{+1}
ITC1200	310	221
ITC1500	396	291
ITC1900	465	319
ITC2200	542	362

3.3 Mounting the device

Position of the mounting clamps

To achieve the degree of protection for the device, you need to comply with the mounting clamp positions listed below.

The positions of the mounting clamps are marked by stamps on the cutouts. Fit mounting clamps in all the stamped cutouts.

The following table shows the type, number and position of mounting clamps needed for the various devices.

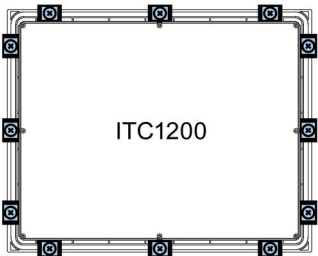
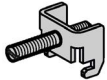
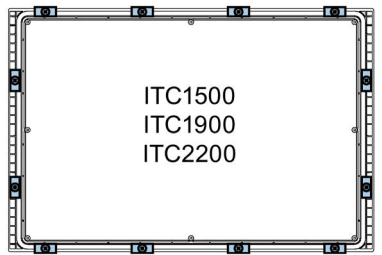
Device	Mounting clamps		
	Type	Quantity	Position on the device
ITC1200	Aluminum mounting clamps 	12	 ITC1200
ITC1500 ITC1900 ITC2200	Steel mounting clamps 	12	 ITC1500 ITC1900 ITC2200

Requirement

- All packaging components and protective films have been removed from the device.
- To install the device, you need the mounting clamps from the accessory kit.
- Ensure that the mounting seal is attached to the device.

Procedure

Note

Risk of guaranteed degree of protection not being met

If the mounting seal is damaged or protrudes beyond the device, the degree of protection is not ensured.

Checking the placement of the mounting seal

To avoid leakage around the mounting cutout, do not install the mounting seal turned inside out. If the mounting seal is damaged, order a replacement seal.

Note

Installing the device

Always mount the device according to the instructions in this manual.

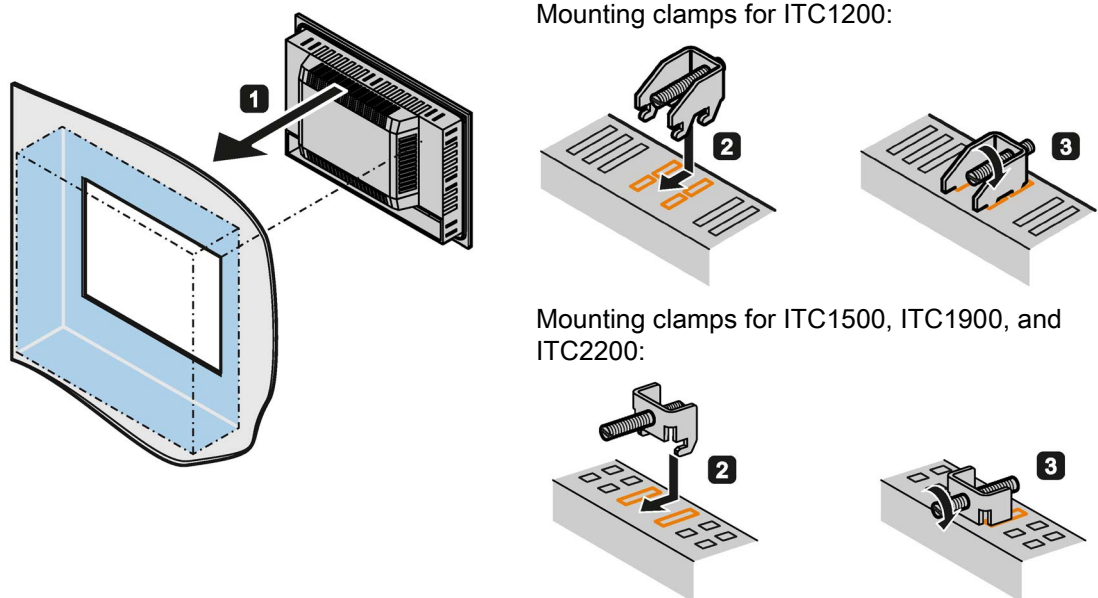

Proceed as follows:

1. Working from the front, insert the device into the mounting cut-out.
2. Insert the mounting clamp into the cutout provided on the device.
3. Secure the mounting clamp by tightening the threaded pin.

Note

Observe a torque of 0.5 Nm when tightening the threaded pins of the mounting clamps:

4. Repeat steps 2 and 3 for all mounting clamps.
5. Check the fit of the mounting seal.

Result

The device is mounted and the degree of protection is ensured at the front.

3.4 Connecting the device

3.4.1 Overview

Requirement

- The device has been installed according to the information provided in these operating instructions.
- Always use shielded standard cables.

For order information please refer to Industry Mall (<http://mall.automation.siemens.com>).

Connection sequence

Connect the device in the following sequence:

1. Equipotential bonding
2. Power supply
3. PROFINET/Ethernet
4. I/Os as necessary

 CAUTION
Damage in case of incorrect connection sequence
You must connect the device in the sequence indicated above.

Disconnect the device by completing the above steps in reverse order.

Connecting the cable

- When connecting the cables, ensure that the contact pins are not bent.
- Secure the cable connector with a cable tie.
- Provide adequate strain relief for all cables.
- The pin assignment of the interfaces is described in the technical specifications.

See also

Power supply (Page 125)

USB (Page 125)

3.4.2 Connection of equipotential bonding

Differences in electrical potential

Differences in electrical potential can develop between spatially separated plant components. Such electrical potential differences can lead to high equalizing currents over the data cables and therefore to the destruction of their interfaces. Equalizing currents can develop if the cable shielding is terminated at both ends and grounded to different plant parts.

Differences in potential may develop when a system is connected to different mains supplies.

General requirements for equipotential bonding

Differences in potential must be reduced by means of equipotential bonding in order to ensure trouble-free operation of the relevant components of the electronic system. The following must therefore be observed when installing the equipotential bonding circuit:

- The effectiveness of equipotential bonding increases as the impedance of the equipotential bonding conductor decreases or as its cross-section increases.
- If two plant parts are interconnected by means of shielded data cables and their shielding is bonded at both ends to the grounding/protective conductor, the impedance of the additionally installed equipotential bonding cable must not exceed 10% of the shielding impedance.
- The cross-section of an equipotential bonding conductor must be capable of handling the maximum equalizing current.
- Use equipotential bonding conductors made of copper or galvanized steel. Establish a large surface contact between the equipotential bonding conductors and the grounding/protective conductor and protect these from corrosion.
- Use a suitable cable clip to clamp the shield of the data cable flush to the equipotential bonding rail. Keep the length of cable between the device and the equipotential bonding rail as short as possible.
- Route the equipotential bonding conductor and data cables in parallel and with minimum clearance between these.

Wiring diagram

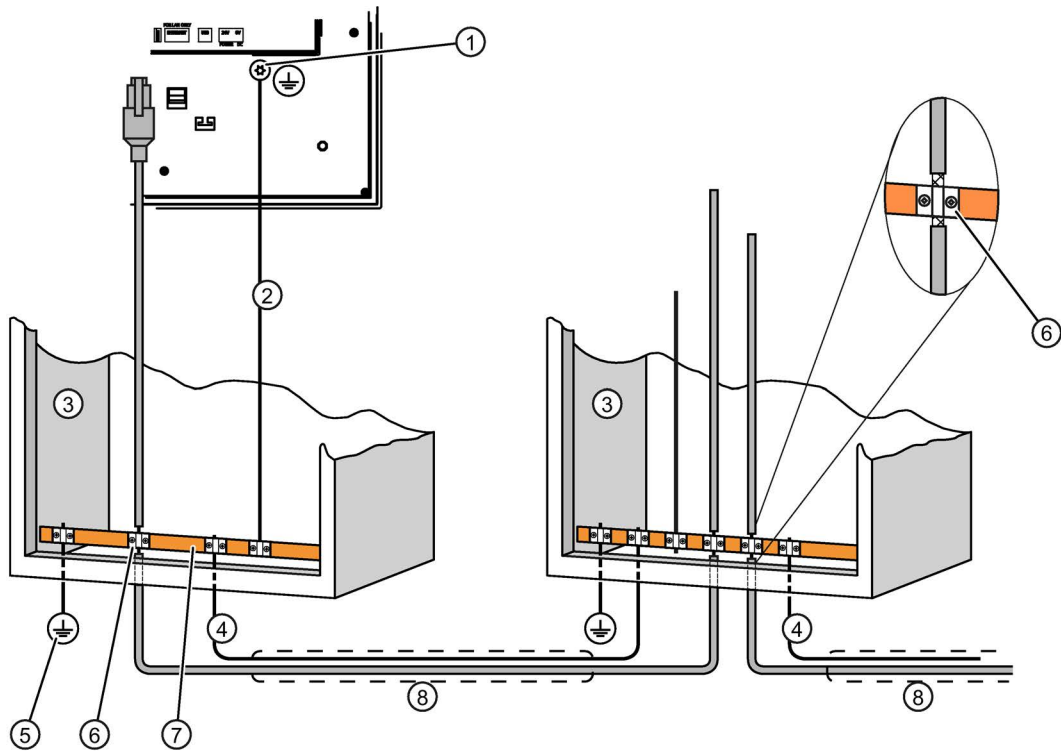

- ① Ground connection on the device, example
- ② Equipotential bonding conductor cross-section: min. 4 mm²
- ③ Control cabinet
- ④ Equipotential bonding conductor cross-section: min. 16 mm²
- ⑤ Ground connection
- ⑥ Cable clip
- ⑦ Equipotential bonding rail
- ⑧ Parallel routing of the equipotential bonding conductor and data cable

NOTICE

Damage to the interface modules possible

Cable shielding is not suitable for equipotential bonding.

Use only the prescribed equipotential bonding conductors. The equipotential bonding conductor ④ must not be less than 16 mm². The interface modules may otherwise be damaged or destroyed.

3.4.3 Connecting the power supply

Configuration graphic

The figure below shows the connection between the device and the power supply.

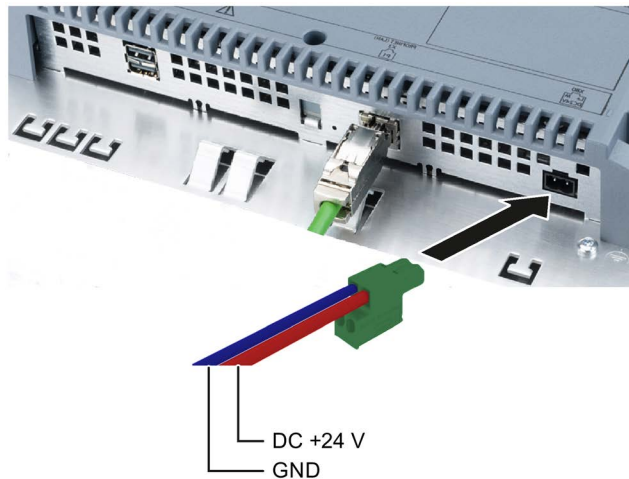

Note when connecting

The mains terminal for connecting the power supply is contained in the accessory kit. The mains terminal is designed for cables with a maximum cross-section of 1.5 mm².

Connecting the mains terminal

NOTICE

Damage to the socket

If you tighten up the screws on the mains terminal while the mains terminal is inserted in the device, then the pressure of the screwdriver on the socket may damage the device.

Only connect the wires when the mains terminal is withdrawn.

1. Connect the power supply terminal to the cables of the power supply as shown in the figure above.
2. Ensure that the cables are connected to the correct terminals. Refer to the label for the contact pins on the rear of the device.

Reverse polarity protection

The device is equipped with reverse polarity protection.

Safe power supply

NOTICE

Device malfunction

If the supply voltage is outside the specified range, device malfunctions cannot be ruled out.

Use only 24 VDC power supply units with safe electrical isolation in accordance with IEC 60364-4-41 or HD 60364-4-41, for example, to SELV / PELV standard.

Applies to non-isolated plant configurations: Connect the "GND" terminal of the 24 VDC power supply to the equipotential bonding. You should always select a central point of termination.

See also

Interfaces (Page 13)

3.4.4 Connecting device to the server

Configuration graphic

The following figure shows the connection between the device and the server via PROFINET/Ethernet.

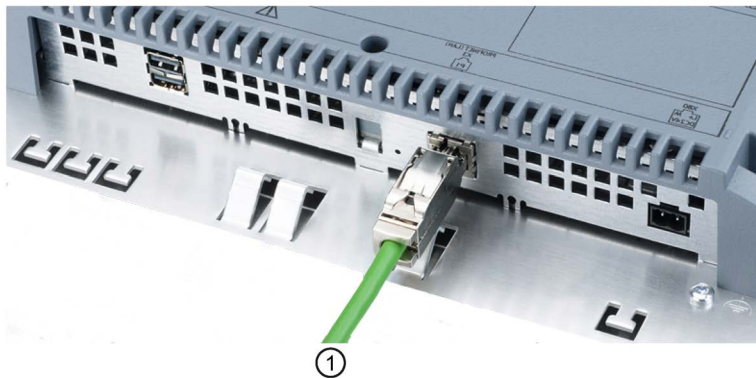

Procedure

1. Connect the PROFINET/Ethernet cable ① to a server.

See also

Interfaces (Page 13)

3.4.5 Connecting a USB device

You can connect the following devices to the USB port:

- Mouse
- Keyboard
- Industrial USB Hub 4
- USB memory devices

The device only supports USB storage devices that have been formatted with the FAT16/FAT32 or NFTS file system.

Note

Malfunction caused by external device

A malfunction may occur if you connect an external device with its own power supply and without equipotential bonding or excessive current load to the USB port.

Ensure a non-insulated installation. Observe the values for maximum load of the USB port (see section "General technical specifications (Page 118)").

See also

Interfaces (Page 13)

USB (Page 125)

SINUMERIK (Page 92)

Operating a USB memory device (Page 103)

3.5 Installing strain relief

After the power-on test, ensure strain relief by using cable ties to secure the connected cables to the marked mounting components ① and ②.



Commissioning the device

4.1 Switching on and testing the device

Procedure

Proceed as follows:

1. Switch on the power supply.

Information regarding the included free software is displayed during startup.

If the device fails to start, you may have crossed the wires on the mains terminal. Check the connected wires and change their connection.

Additional information is available in the configuration settings, Section Basics (Page 55). Make sure that you observe the warning at the end of the section.

Setup Wizard

The first time the device starts up, the Setup Wizard remains open until the configuration settings become valid. The Setup Wizard guides you through the configuration of selected device and network data as well as passwords and connection settings.

The Setup Wizard starts again when the factory settings are restored or the firmware is updated.

Function test

Perform a function test following commissioning. The device is functional if one of the following states occurs:

- The taskbar is displayed.
- The configured startup connections are established.

Procedure - Switching off the device

Proceed as follows:

1. Terminate all client-server connections and close all programs.
2. Switch off the power supply.

Restart

You restart the device, for example, in order to test the startup connections.

When the "Restart" menu command is hidden, select "Permit restart" (see section "Password settings (Page 63)").

1. Choose "Restart" from the task bar in the start menu. A confirmation prompt is displayed first.
2. Click "Yes" to confirm. The device restarts.

4.2 Interrupting and restoring a connection

Introduction

The connection to the server can be interrupted in several ways:

- The server is offline or has not completed its startup sequence.
- The password is incorrect.
- A firewall is blocking server access.
- The SINUMERIK server does not support the Industrial Thin Client, for example, if the firmware on the server is outdated.
- The server has been shut down, for example, for maintenance purposes.
- The PROFINET/Ethernet network cable has been disconnected.
- A connection problem occurred in the network.
- A client-server connection was started on another device which logs onto the server with the same data. The client-server connection running on your device is then terminated.

Note that there can be multiple client-server connections at one time.

Automatic connection establishment

The device tries to re-establish the interrupted connection automatically. There are two basic standard cases for this:

- Initial start of a connection

The connection cannot be established because the server is not ready, for example. The device makes continuous attempts to establish the connection to the server.

- Existing connection

An existing connection to the server is interrupted because the network cable has been removed or the network is faulty, for example.

The device makes continuous attempts to re-establish the connection to the server.

Exception: If the device receives a message via the network, for example when the server is shut down, the device terminates the current client-server connection.

Afterwards, the device will only try to re-establish the interrupted connection to the server if the "Reconnect automatically" option is selected in the configuration settings.

Terminate the active connection in order to cancel the attempts to establish a connection.

Special features

SINUMERIK

Initial start of a connection: Maximum of 40 connection attempts. Then the SINUMERIK connection is terminated and the configuration settings are restored.

Existing connection: Automatic connection establishment. After the connection has been canceled, the message "Waiting for HMI" appears.

Assigning device parameters

5.1 Possible applications

Possible applications

The Industrial Thin Client can fulfill the following functions as an operator terminal:

- Access to an HMI device as a Sm@rtServer client via the WinCC Sm@rtServer option.
- Access as a client via the "RDP" protocol.
- Access as a client via the "VNC" protocol.
- Access a Citrix server as Citrix client.
- Access as a client on a WinCC OA server.
- Access to a SINUMERIK PCU or NCU as a SINUMERIK Thin Client Unit (TCU).
- Access as a web client to a web server, e.g. of an S7 controller or the Intranet.

When the device accesses a server, for example, an HMI device or a PC, as a client, the screen display of the server is shown on the screen of the Industrial Thin Client. The user uses the Industrial Thin Client to access programs or projects on the server.

Note

"Sm@rtServer", "RDP", "VNC", "SINUMERIK" and "Web" are referred to as connection types in this documentation.

Note

The Industrial Thin Client's browser is based on Firefox Version 34.

5.2 Opening the configuration

Introduction

You set the device parameters in the Configuration settings of the device (Page 43).

Note

You can edit the configuration settings of the device as follows:



- Either directly on the device or
- Remotely via PC at your convenience (see section "Remote configuration of several devices (Page 71)"). The settings then appear in a separate configuration window on the right and on the device itself.

In the remote configuration, you can also edit several devices at the same time (see section "Overview of remote operation (Page 74)").

- Restart devices
 - Update firmware
 - Assign IP addresses, etc.
-

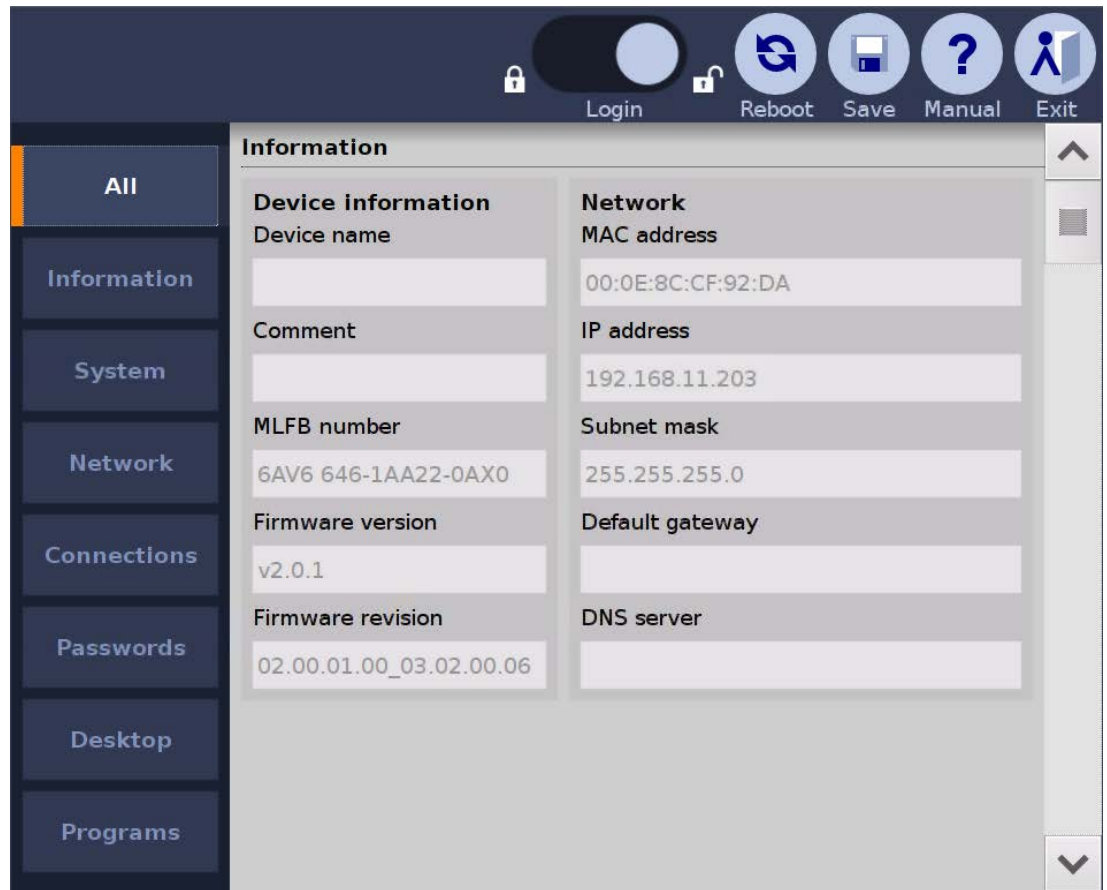
Procedure on the device



1. Press the  "Start menu" symbol in the task bar.
2. Select the menu entry "Configuration". At first, all configuration settings are displayed in the "All" submenu. Detailed information is available in the section "Access and structure (Page 43)".
3. Go left to another submenu, for example "Information". The device information is displayed (see section "Device data (Page 45)").
4. Close the configuration settings with the  "Exit" symbol.

You can find additional menu entries in the Start menu and a description of the task bar in the section "Structure and functions of the taskbar (Page 97)".

NOTICE

Unintended reactions of the device

Two people can edit the configuration settings simultaneously: locally on the device and via remote configuration. The most recently saved settings are the valid settings at any given time (blue "Save" symbol).

Organize access to the configuration settings in such a way that only one person can edit the configuration settings at one time.

Note

Unauthorized access

To prevent unauthorized persons from logging on and gaining free access to the configuration settings and client-server connections, you should immediately assign a new administrator password after first commissioning or restoring of factory settings.

SSH configuration service

Note

Unauthorized access

Certain services are activated with the factory setting, for example, the SSH configuration service which enables remote configuration. This means unauthorized personnel can log on via SSH and have free access to the devices and client-server connections.

If you do not need the remote configuration service, disable it in the System settings (Page 46).

Access without logon

If you are not logged on, you only have read access to the currently valid network settings and the device data such as the IP address and the MLFB of the device (see section "Device data (Page 45)").

See also

Disabling the touch screen (Page 106)

Calibrating the touch screen (Page 106)

Operating a USB memory device (Page 103)

Switching on and testing the device (Page 37)

Starting a connection (Page 99)

Password settings (Page 63)

5.3 Configuration settings of the device

5.3.1 Access and structure

Structure

The following figure shows the configuration settings in the "Configuration" Start menu.

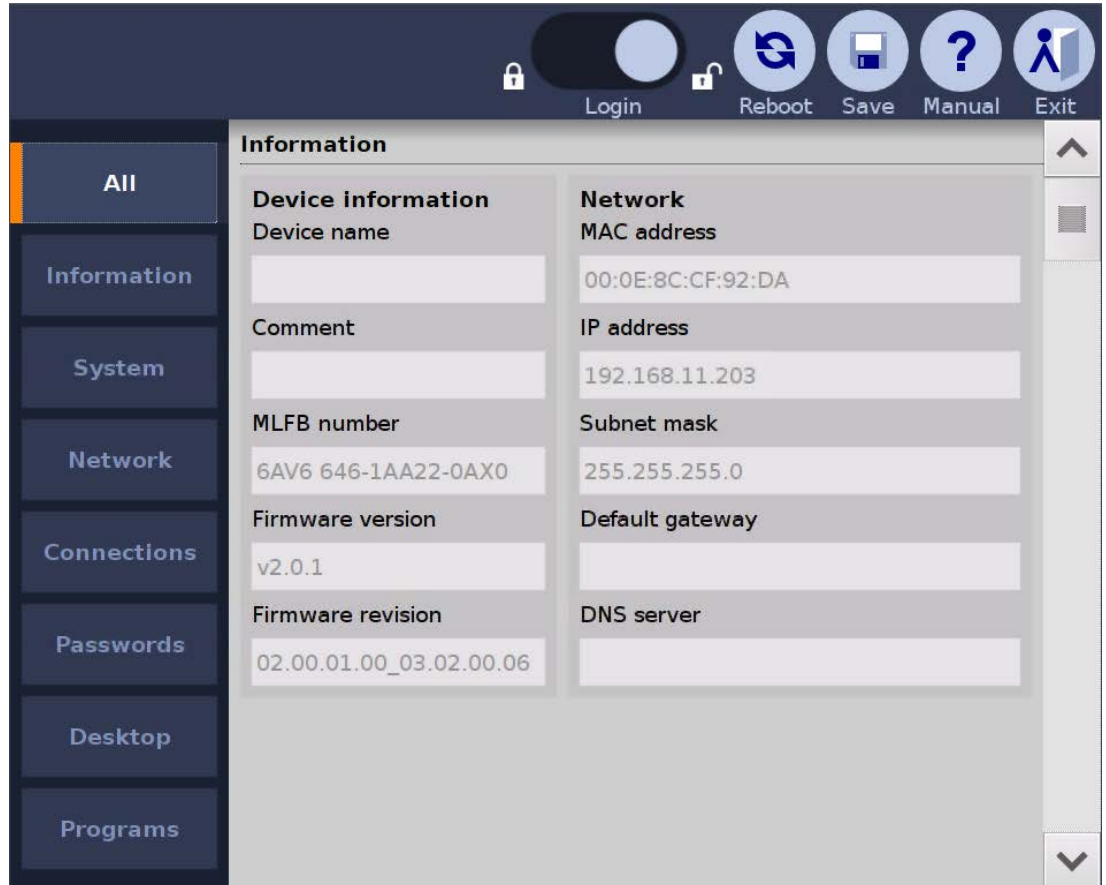

This configuration settings have the following submenus:

- "All": displays all configuration settings in a single window
- System settings under "System":
 - Update firmware
 - Back up and reload the configuration file
 - Restore to factory settings
- Network settings under "Network"
- Connection settings under "Connections":
configures client-server connections for remote access
- Administrator password and connection password under "Passwords"

- Desktop settings under "Desktop":
 - Taskbar
 - On-screen keyboard
 - Background image
- Application settings under "Applications": Web browser settings

Note

Forced termination of connection

When you change and save the configuration settings, all open client-server connections are terminated and all open programs are closed without a confirmation prompt. The autostart connections are re-established afterwards and the new configuration settings are put into effect.

Access without logon

If you open the configuration settings and do not log on as administrator, only "Configuration > Information" is shown in the Start menu with the current network settings and device information.

You have read-only access to the device and network data and cannot make any changes.

Access with logon

In order to view and edit the configuration settings (read and write access), you must log on with a valid administrator password.

Note

Permanent data

Some data cannot be configured, for example, "MLFB number", "Firmware version", "MAC address", etc.

Symbols

Use the symbols above to manipulate the configuration settings.

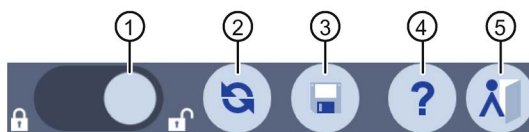

You can

- ① "Log on" as an administrator and "Log off" again
- ② "Restart" the device.
- ③ "Save" the configuration settings
- ④ Open "Help".
- ⑤ "Exit" the configuration.

See also

- Network settings (Page 51)
- System settings (Page 46)
- Password settings (Page 63)
- Setting up startup connection (Page 61)

5.3.2 Device data

The following figure shows the device data in the Start menu "Configuration > Information".

Information	
Device information	Network
Device name	MAC address
<input type="text"/>	00:0E:8C:CF:92:DA
Comment	IP address
<input type="text"/>	192.168.11.203
MLFB number	Subnet mask
6AV6 646-1AA22-0AX0	255.255.255.0
Firmware version	Default gateway
v2.0.1	<input type="text"/>
Firmware revision	DNS server
02.00.01.00_03.02.00.06	<input type="text"/>

The device data identify the device uniquely and are shown here for informational purposes only. You edit the device data in the System settings (Page 46) and Network settings (Page 51). The home page of the web browser also displays device data and network settings.

Note

Information is not displayed.

"Status" and "Status message" are only displayed in the remote configuration and not on the device. If no administrator is logged on, the configuration settings only show the "Information" submenu.

5.3.3 System settings

Introduction

The following figure shows the system settings in the Start menu "Configuration > System".

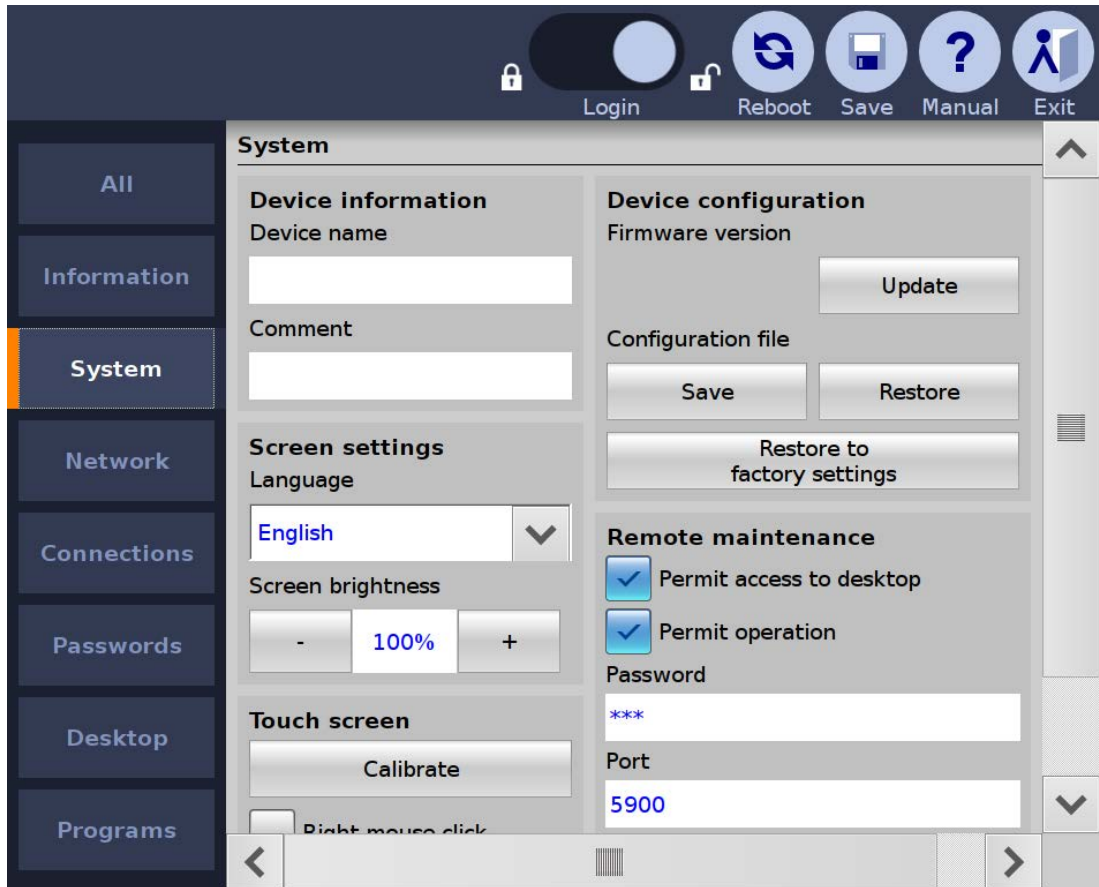

You can perform the following actions:

- Specify device name
- Setting up screen: language, brightness, calibration, right mouse click
- Update firmware
- Save and retrieve the configuration file
- Restore to factory settings
- Define settings for remote maintenance via VNC
- Activate remote configuration (RCC)

Specifying device name

In the "Device information" area, specify a name for the Industrial Thin Client in "Device name". This name will allow the administrator to identify the device. The device name will be displayed at the following places:

- In the title bar of the configuration settings
- In the case of Remote configuration of several devices (Page 71), in the device window that lists the Industrial Thin Clients found in the network.
- As the PROFINET station name in SIMATIC Manager

The device name is also the PROFINET station name and must meet the following conditions:

- One or more identifiers separated by a dot.
- Length of identifier: 1-63 characters
- Length of the device name: 1-255 characters, but only up to 26 characters are displayed on the device
- The identifiers contain lower case letters a-z and numbers 0-9.
- The identifiers cannot start or not end with "-".
- The first identifier does not have the form "port-xyz" or "port-xyz-abcde" where a, b, c, d, e, x, y, z = numbers 0 to 9.
- Identifiers do not start with "xn--" if RFC 3490 is applied.
- The device name may not end with "0".
- The device name does not have the n.n.n.n format, where n = 0 to 999.

Devices with more than one Ethernet interface do not need more than one device name.

Only up to 23 characters of the **comment** are displayed on the device (see above).

Setting up screen

Set the system language that includes the following texts under "Language":

- Start menu and settings
- On-screen keyboard and externally attached USB keyboard
- Messages

 CAUTION
Damage to the machine or plant through operating error The set system language, for example German, also determines the keyboard language of the externally connected USB keyboard. If you then connect an English keyboard, however, such as is the case with a SINUMERIK connection, the keys do not have the same meaning as is printed on them. This may result in operating errors at the machine and personal injury or damage to the machine or plant. To connect an English keyboard, set the system language to English under "Language" in the Start menu "Configuration > System".

Set the "Screen brightness". You can also use the system settings to "Calibrate touch screen" (see section "Calibrating the touch screen (Page 106)").

If you select the "Right mouse click" option, each contact on the touch screen lasting more than 2 seconds will be interpreted as a right-click.

Example: If you touch the "Workstation" icon in Windows for more than 2 seconds, the operating system or application will respond as though you had right-clicked the icon: the context menu is displayed where you can select the "Properties" item, for example.

Update firmware

You update the device firmware either directly on the device via USB or from a PC via Remote configuration of several devices (Page 71).

NOTICE

Data loss during firmware update

All configuration settings are lost during a firmware update. The factory settings are restored after the update, which also resets passwords and calibration information.
--

Save the configuration file before you update the firmware and reload it after the update (see below).
--

NOTICE

Damage to the device

If the power supply or the connection to the device containing the firmware is interrupted during the update process, the device may no longer be functional.

- | |
|---|
| <ul style="list-style-type: none">• Ensure that the power supply and the connection to the device are maintained during the entire updating process.• Make sure that all applications running on the device are closed.• Before updating the firmware, restart the device to prevent memory problems. |
|---|

In the "Device configuration" area, use the "Update" button to select an update file "*.upd". The selected file will be transferred to the device. To determine whether the selected file is suitable for the device, the system checks it against the following criteria, for example:

- The selected file is an update file.
- The selected update file is more current than the version installed on the device.
- The selected update file is suitable for this device.

If all the criteria are met, the selected update file will be run on the device. The device and the Setup Wizard restart automatically.

Note

The progress of the update is displayed on the screen.

Save and retrieve the configuration file

You back up the configuration file of the device either directly on the device via USB or from a PC via Remote configuration of several devices (Page 71).

The configuration file contains all device-specific configuration settings with the exception of the background image and the touch calibration. You can back up the configuration file of a device and reload it to several devices, for example:

- Use the "Save" button to back up the configuration file for the device to the connected USB drive. To do this, you select a folder in the file system and close the dialog with "OK". The configuration file is saved to the folder.
- Use the "Load" button to import the backed up configuration file from the connected USB drive again, for example if the current configuration file has been inadvertently overwritten. To do this, you select a configuration file from a file dialog and close the dialog with "OK".

The syntax within the configuration file is checked. If the syntax is free of errors, the configuration file will be transferred to the device and the old configuration file will be overwritten; otherwise a message will be output.

Note

Saving the configuration file

Configuration files of the older version V1.x are no longer supported. Back up the current configuration file before and after each firmware update.

As of version 2.0.2, you are prompted to enter a password between 8 and 32 characters in length when saving.

Loading the configuration file

Only load configuration files that were created on the device or with the Remote Configuration Center. A configuration file may not be altered after backup, for example, by means of an editor.

As of version 2.0.2, you are prompted during loading to again enter the password you assigned when you performed the save.

IP address conflicts

Do not load configuration files with the same IP addresses on different devices. Reassign the IP addresses.

Restore to factory settings

Restoring factory settings has the following effects:

- The default configuration file overwrites the configuration file. All connection data for the network, remote access and web browser is reset. The language and screen brightness, the settings and position of the taskbar and on-screen keyboard, and the background image are reset.

NOTICE
Data loss restoring the factory settings
Save the configuration file before you restore the factory settings and reload it afterwards (see above).

- The administrator password is deleted and must be reassigned at next restart.
- The SSH password is reset to the default password, which has an effect on the SSH configuration service. Additional information is available in the section "Assigning a key (Page 82)".
- The calibration information is reset.

Note

Faulty touch operation

The touch screen must be recalibrated.

Procedure:

1. Touch the "Restore to factory settings" button. The "Resetting to factory defaults" message is shown on the touch screen. The device reboots automatically if you confirm this message.
2. You can also switch the power off and on again and press the "Factory Settings" hardware button on the device with a pointed object for at least three seconds during the restart. A message is briefly displayed. Then the device restarts automatically.

Service device remotely via VNC

Allows remote access to the device. The device has a VNC server for this purpose. With VNC remote access, you can "Permit access to Desktop" or "Permit operation", in other words, enable operation of the plant or machine from the device. You also set the "Port" for remote access. This functionality has to be protected by a password.

Note

During a SINUMERIK connection, a new IP address is assigned to the device. Remote maintenance of the device is then no longer possible.

For remote maintenance, use the IP address that was assigned by the SINUMERIK connection.

Activate remote configuration via RCC

Remote configuration, which is enabled through SSH, is activated by default. But SSH poses a potential security risk. Detailed information is available in the section "Backing up remote configuration (Page 81)". If you do not need remote configuration, deactivate "SSH"

See also

Opening the configuration (Page 40)

Network settings (Page 51)

Remote configuration of several devices (Page 71)

Layout of the devices (Page 12)

Switching on and testing the device (Page 37)

SIMATIC Thin Client (<http://support.automation.siemens.com/WW/view/en/23910492>)

5.3.4 Network settings

Introduction

The following figure shows the network settings in the Start menu "Configuration > Network".

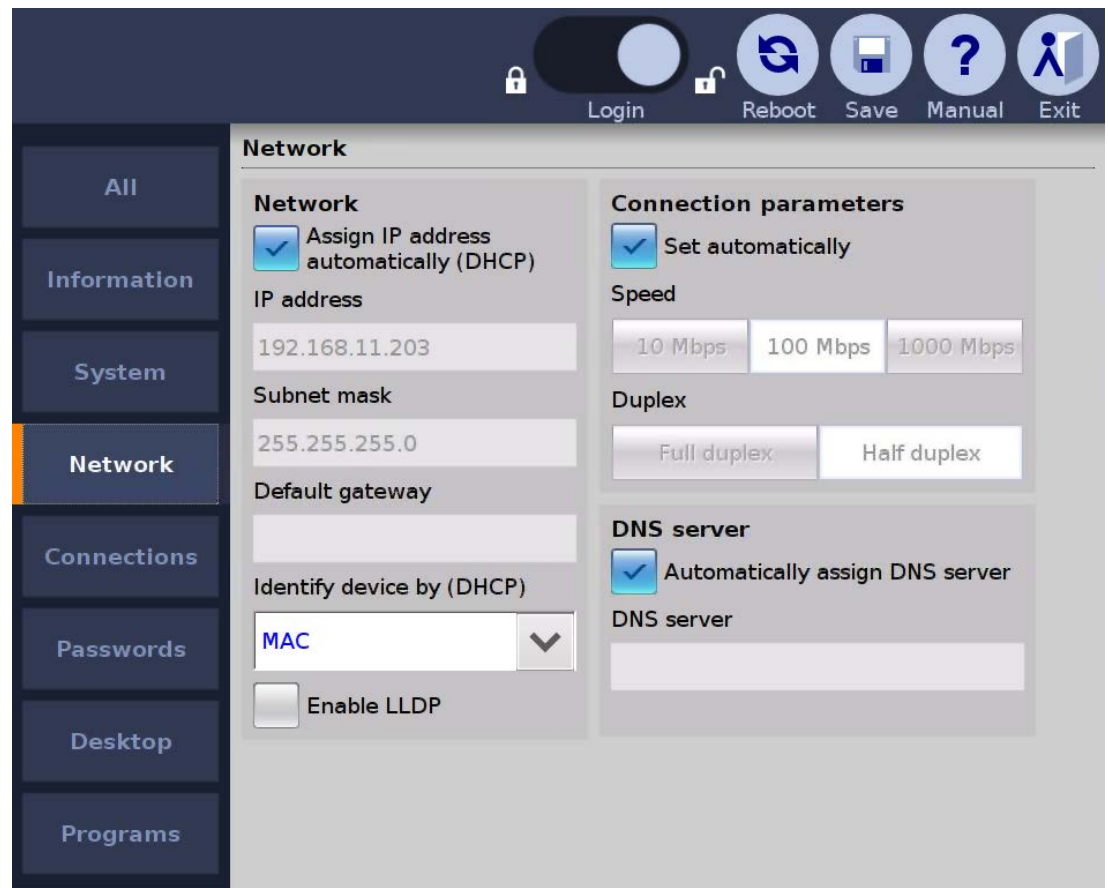

You can perform the following actions:

- Specify network parameters
- Assign network parameters dynamically
- Use DNS server
- Check valid settings
- Specify speed and mode of the connection

Note

These network settings are not relevant for the SINUMERIK connection. The SINUMERIK connection automatically obtains its network settings from the system network.

Note

During a SINUMERIK connection, a new IP address is assigned to the device with the following effect:

- Any active RDP connection is terminated.
- Remote maintenance of the device is no longer possible.

When the SINUMERIK connection is closed, the original IP address is restored.

Specify network parameters

You assign the network parameters either statically or dynamically:

- If "Assign IP address automatically (DHCP)" is not selected, assign a valid static IP address, subnet mask, and default gateway.
- You can also use the "Assign IP address automatically (DHCP)" option to specify that the network parameters will be assigned dynamically by the DHCP server and are therefore not available for assignment (grayed out).

Note

IP address conflicts

Before an IP address is assigned, a check is made to determine whether a device with this IP address already exists in the network. If so, an error message is appears and the address is not assigned. Assign an individual IP address to each device.

The subnet mask specifies the maximum number of nodes, e.g., "255.255.255.0".

Note

Invalid subnet mask

If a subnet mask is invalid, an error message appears and the subnet mask is not assigned. Assign a valid subnet mask.

Activate a PROFINET service under "Enable LLDP" (Link Layer Discovery Protocol) that identifies the Industrial Thin Client in the network as such. If other network components also make their identity known, the management station, such as STEP7, can then detect the network topology automatically.

LLDP is only available and enabled for devices as of version 2.0.1.

Assign network parameters dynamically

The following applies only if the "Assign IP address automatically (DHCP)" option is selected.

The device has two features that identify it uniquely. Under "Device identification (DHCP)", you specify the identification feature that the DHCP server uses to identify the device:

- If you select "Device name", the DHCP server identifies the device on the basis of the name stored in the System settings (Page 46), in the "Device name" field. If configured correspondingly, the DHCP server searches for the device name in its configuration file and transfers the network settings stored there to the Industrial Thin Client.
- If you select the most common identification parameter "MAC address", the DHCP server identifies the device on the basis of its MAC address.

Use DNS server

You can manually enter the IP address of the DNS server under "DNS server". If you select the "Automatically assign DNS server" option, the manual IP address is overwritten by an IP address assigned by the DHCP server. This requires that the "Assign IP address automatically (DHCP)" option is also selected.

Note

No connection between client and server

If you edit the configuration settings from an external PC, take the following into account: The connection can be interrupted as soon as you enter a different IP address in "IP address" or select the "Assign IP address automatically (DHCP)" option.

If you edit the configuration settings locally on the device, the connection to the configuration settings will be maintained even if you change the IP address in the configuration settings.

If the "Assign IP address automatically (DHCP)" option is selected and no DHCP server is available, no IP address will be assigned to the device. Communication between the server and device is not possible.

- Open the configuration settings locally on the device, and assign an IP address that is not already used in the network to the device.
- You can also start remote configuration and open the "IP" tab to assign IP addresses for one or more devices.

Alternatively, you can select the "Assign IP address automatically (DHCP)" option with "Device name".

Note

A maximum of 240 characters is permitted. For connections via RDP, the device name will be automatically truncated to the first 15 characters at logon.

Check valid settings

In the Start menu "Configuration> Information", the network settings that are currently valid are always shown, regardless of whether they were assigned statically or dynamically. Use this approach to check whether the change in the network settings was accepted or not.

Specify speed and mode of the connection

The device detects the data rate and the connection mode of its physical connection partner and adapts itself automatically. The "Set automatically" option is therefore selected by default. The other parts of the dialog are disabled. A switch can also be a connection partner.

You can, however, set the data rate and the connection mode manually.

Note

Disable the automatic setting only if the connection partner requires this.

If the "Set automatically" option is not selected, the following default settings apply:

- "Rate": 100 Mbps
- "Half duplex"

Basic rule for specifying speed and mode: The connection works best if you specify one of the following combinations:

- Automatic detection for both connection partners or
- Same speed and same mode for both connection partners

See also

Calibrating the touch screen (Page 106)

Remote configuration of several devices (Page 71)

Opening the configuration (Page 40)

PROFINET basic functions (Page 62)

5.3.5 Connections

5.3.5.1 Basics

Introduction

Users can connect from the Thin Client to different servers. Example:

- RDP Server 1: Access to office planning documents
- VNC Server 2: Access to Office spreadsheets
- Sm@rtServer 3: Access to WinCC messages at the plant
- SINUMERIK Server 4: Access to a SINUMERIK plant screen
- WinCC OA Server 5: Access to WinCC OA workstations
- Web Server 6: Access to web-based content, for example, of an S7 controller (PROFINET) or Intranet/Internet using the integrated web browser.

Note

Web connection and web browser

You can configure a web connection, for example, the server address, in the Connection settings (Page 58). You configure the web browser itself, for example, its proxy settings, in the Application settings (Page 69).

You can establish up to 5 such client-server connections at the same time. These connections are specified mainly by the following parameters:

- Connection type, e.g., "Sm@rtServer" or "RDP"
- IP address of the server
- Port of the server

The Industrial Thin Client then displays the server screen as a full screen.

This section shows how you configure client-server connections. The connection settings can be found in the configuration settings in the Start menu "Configuration > Connections".

Special features with SINUMERIK

Note

The SINUMERIK connection is configured automatically through the SINUMERIK system network and therefore does not need any connection settings or a connection password.

Note

PROFINET basic functions

The SINUMERIK connection supports only the PROFINET basic services. During a SINUMERIK connection, a new IP address is assigned to the device with the following effect:

- Any active RDP connection is terminated.
- Remote maintenance of the device is no longer possible.

When the SINUMERIK connection is closed, the original IP address is restored.

Screen can no longer be operated

The screen can no longer be operated when you start a second SINUMERIK connection. Close the active SINUMERIK connection before you start a new SINUMERIK connection.

Screen display

The SINUMERIK connection is displayed full-screen on the Industrial Thin Client. In the process, the server adapts its screen resolution to the screen resolution of the client that has the operating rights.

All other connected clients also display the server screen:

- If the clients without operating rights have a lower screen resolution than the server, the clients scale down the server screen that is too large and display it as a full screen.
- If the clients without operating rights have the same or higher screen resolution, the clients display the server screen with reduced size in the center and in the original resolution.

Displaying client-server connections in the taskbar

The "Display connection (favorites)" option is enabled by default so that the client-server connection appears in the start bar (under "Favorites") and can be started from there. The favorites contain a maximum of 10 client-server connections.

It makes sense to disable the "Display connection (favorites)" option in the following situations:

- A server that is regularly used from a client is undergoing maintenance and is therefore not connected.
- A second, redundant server is being set up, for the case that the first server fails.
- A client-server connection that is started automatically as a startup connection does not need to be started from the taskbar.

Factory default settings

- "Obtain IP address automatically (DHCP)"

Note

Unauthorized access

To prevent unauthorized persons from logging on and gaining free access to the configuration settings and client-server connections, you should immediately assign a new administrator password after first commissioning or restoring of factory settings.

Note

Avoiding malfunctions

The factory default is that the IP address is assigned dynamically (DHCP). If you disable the "Obtain IP address automatically (DHCP)" option, there is no static IP address ("0.0.0.0"). Therefore, assign an individual IP address to each device.

Some client-server connections have already been created as examples. Set up client-server connections with valid IP addresses.

See also

PROFINET basic functions (Page 62)

5.3.5.2 Setting up client-server connections

Structure of the tab

The following figure shows the list of client-server connections in the Start menu "Configuration > Connections".



At the bottom are buttons for editing a selected client-server connection.

Buttons

The buttons have the following functions:

- "New": creates a new client-server connection.
- "Edit": opens the connection settings of the client-server connection.
Same dialog as "New" with the only difference that the "Connection type" can no longer be changed.
- "Test": Checks if the server and port can be reached (ping).
- "Delete": deletes the client-server connection.

See also

Opening the configuration (Page 40)

5.3.5.3 Connection settings

By way of example, the following figure shows the connection settings for an RDP connection in the Start menu "Configuration > Connections".

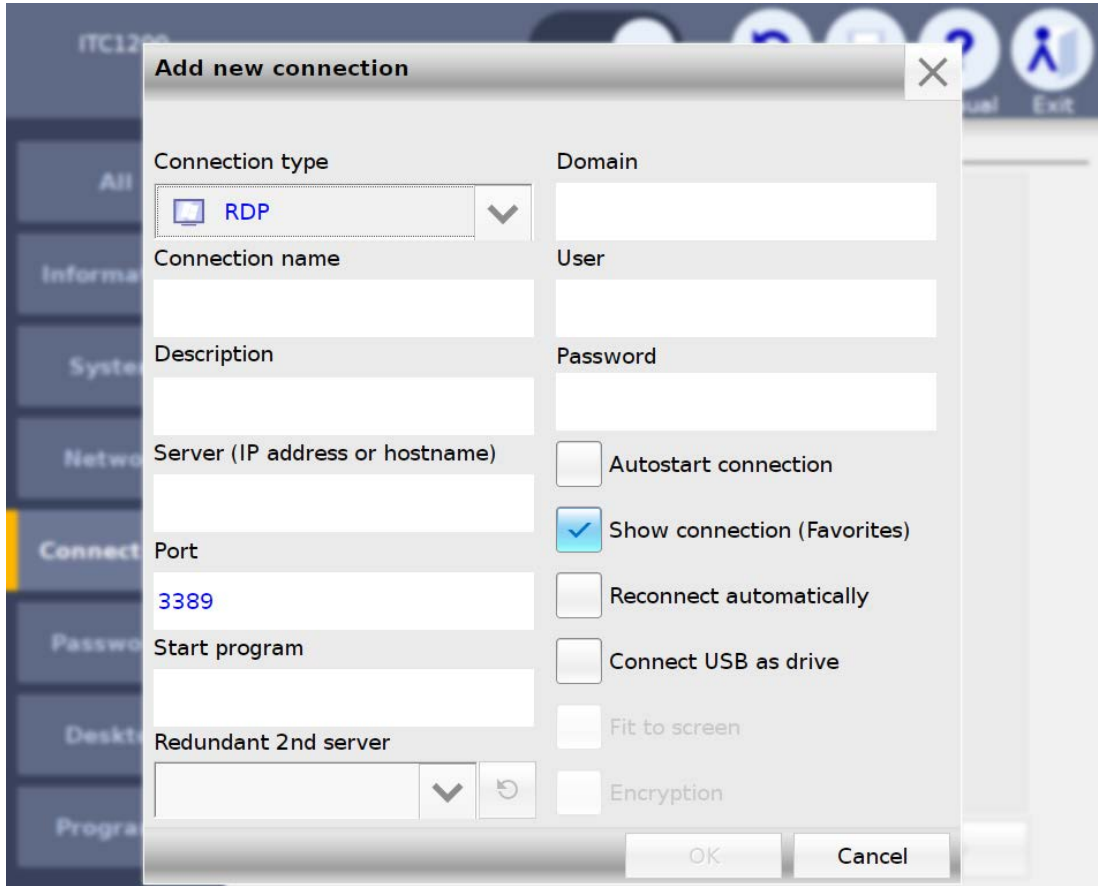

You select a client-server connection, or create a new one. The following connection settings can be specified:

Note

Grayed-out fields

Not all connection settings are available for each type of connection (exception: RDP). Connection settings that are not required are grayed out.

- The "Connection type" specifies the type of client-server connection, e.g., RDP connection, VNC connection, etc.
- In "Connection name", you enter a name for the client-server connection, e.g., "Server screen 1". The client-server connection will then appear with this name in selection menus. If the operator selects "Server screen 1" in the taskbar, for example, the client-server connection configured with this name will be started.
- In "Description", you enter a text for the client-server connection. This description then appears in selection menus under "Connection name".

- Under "Server (IP address)", you specify an IP address or host name at which the server can be reached.
- In "URL" ("Web" connection type only), you specify an Internet address at which the web server can be reached.
- In "Server port", the default port is set. RDP: 3389, Sm@rtServer/VNC: 5900.
- In "Start program" (RDP only), you specify the software program that is automatically started on the server with this RDP connection. For this function, a "Server" type operating system is required on the server PC. The server must be configured accordingly.
- Under "redundant 2nd server" (RDP only), selected a second already configured RDP connection. If the first RDP connection configured here fails, the second RDP connection will be started (fallback). And vice versa: If the second RDP connection fails, the first RDP connection will be restarted.
- You specify the logon information for logging the device onto the server under "Domain" (RDP, Citrix), "User" (RDP, Citrix, WinCC OA), and "Password".

Note

Password length

With the connection to a Sm@rtServer with WinCC Advanced (TIA Portal) V13 or higher, a password length of more than eight characters is supported after the "Encryption" checkbox is selected.

WinCC OA

In WinCC OA, the "User" and "Password" fields are used for HTTP download of Runtime. Logon in the WinCC OA logon screen is therefore not possible. A password is required to assign a user name.

- If you activate "Autostart connection", this client-server connection is automatically established when the device is started or restarted and after the saving of modified configuration settings. "Autostart connection" only works if the flag "Show connection (Favorites)" is also set for the connection.

Note

Limited number of client-server connections

A maximum of 5 client-server connections can be started at the same time. An error message appears when a 6th connection is activated.

Only one SINUMERIK connection can be started at any one time. When a 2nd connection is activated, the screen can no longer be operated.

- If you select "Show connection (favorites)", this client-server connection will appear in the taskbar under "Favorites". If the favorites contain 10 connections, you cannot add an additional connection, and this option is no longer available.

If you deselect the option, the client-server connection is not visible to the operator and can only be started by the administrator in the Start menu "Configuration > Connections" via the "Test" button.

- You use "Reconnect automatically" to specify how the device responds to a message that the existing connection has been disrupted from the outside. If you select this option, the device continually attempts to reconnect to the server, but not when you have closed the connection yourself via the taskbar. For example, you shut down the server for maintenance purposes. A corresponding message is sent to 10 devices, for example, that interrupt the connection. If "Reconnect automatically" is enabled on all devices, the client-server connection is established automatically as soon as the server is ready for operation again.

If "Reconnect automatically" is disabled on all devices, the client-server connection has to be restarted manually on all devices.

Note

Only one user with RDP on Windows operating system

If a second client has established the same RDP connection to the server with the identical logon information, the client-server connection of the first client is interrupted. Even if "Reconnect automatically" is enabled, the device does not try to re-establish the connection to prevent a ping-pong effect between the clients.

- If you select the "Connect USB as drive" option (RDP only), you can access a USB memory device connected to the Industrial Thin Client on the touch screen. The USB data are transferred to the server and displayed there in Windows Explorer for the devices. For additional information, refer to the section "Operating a USB memory device (Page 103)".
-

Note

Security threat to the system

The USB may infect the server with viruses, Trojans, spam, etc.

Use a suitable virus scanner to check the data on the USB memory device, or deselect the "Connect USB as drive" option.

Non-supported operating systems

The "Connect USB as drive" function " is currently not supported for the following operating systems of the connection partner:

- Windows 8.1 Embedded Industrial Pro, 64-bit
 - Windows Server 2012, 64-bit
-

- When "Fit to screen" is activated (only with Sm@rtServer and VNC), the Thin Client scales the server screen to its own display size.
- When "Encryption" is activated (Sm@rt Access only), the data is transferred encrypted between the client and the server. In this case, activate encryption on the server as well.

If the server does not support this function, an error message will be displayed. Depending on the height-to-width ratio, the server screen is displayed within a black bar.

5.3.5.4 Setting up startup connection

Introduction

You can designate each client-server connection as an autostart connection. This means that this client-server connection will also be started every time the device starts. The autostart connections can be restarted even after the configuration settings have been changed.

Note

Limited number of client-server connections

A maximum of 5 client-server connections can be started at the same time. If a sixth connection is activated, an error message appears.

Only one SINUMERIK connection can be started at any one time. The screen can no longer be operated when you activate a second connection.

The order cannot be defined for startup. Therefore, which of the autostart connections will ultimately be displayed on the screen is undefined. However, you can generally switch between the client-server connections.

Procedure

Proceed as follows to identify a client-server connection as an autostart connection:

1. Choose "Configuration > Connections" in the Start menu.
2. Select a client-server connection.
3. Touch the "Edit" button to confirm.
4. Select the "Autostart connection" option.

5.3.5.5 PROFINET basic functions

Introduction

The PROFINET basic functions help to diagnose the device using standard mechanisms. The required diagnostics functions are available, for example, in STEP 7.

Functions

As of SIMATIC Manager V5.4, SP2, the PROFINET basic functions offer the following functions:

- As soon as the device is connected to PROFINET, it is displayed as an available device in the Lifest in SIMATIC Manager. You can view the properties of the device, e.g., IP address.
Additional information from the "Target system" context menu is not supported by the device.
- You can assign a name and an IP address to the device in SIMATIC Manager under "Target system > Edit Ethernet device".
- As of TIA Portal V12: The device can be configured in the topology editor.

See also

PassiveComponentsInstaller.zip
(<http://support.automation.siemens.com/WW/view/en/30840898>)

5.3.6 Password settings

Introduction

The following figure shows the password settings in the Start menu "Configuration > Passwords".

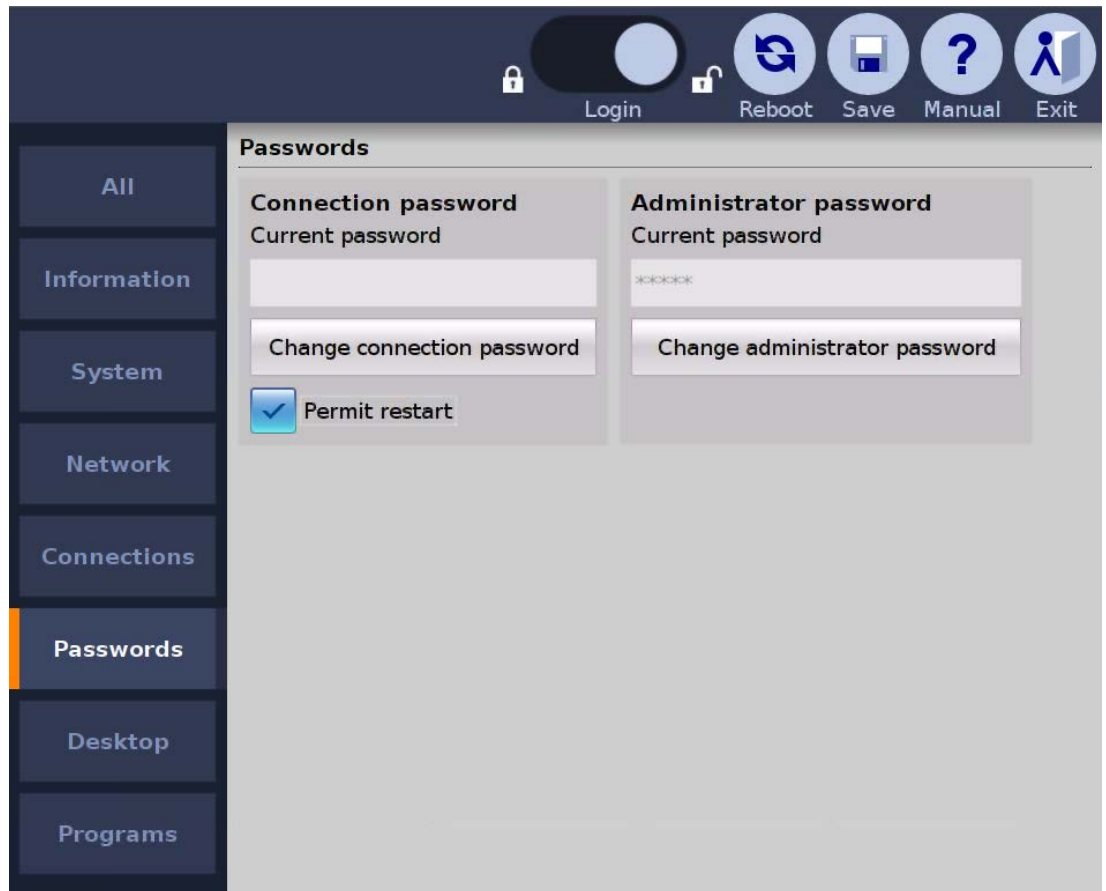

Note

Forced termination of connection

When you save the changed configuration settings, all open client-server connections are terminated and all open programs are closed without a confirmation prompt. The configured autostart connections are re-established.

Logging in as an administrator

A user that is not logged on can operate the Start menu, but only the device data (Page 45) will be visible from the configuration settings ("Configuration > Information").

To edit the configuration settings, follow these steps:

1. Move the blue circle (slider) "Logon" in the toolbar to the right.
2. Enter the administrator password.
3. Click the "Logon" button to close the dialog.

You are logged on as administrator.

Logging off as an administrator

To protect the configuration settings from unauthorized access from the outside, follow these steps:

1. Move the blue circle (slider) "Logon" in the toolbar to the left.

You are logged off as administrator.

Changing the administrator password

During first commissioning or restoring of factory settings, you are prompted to assign a new administrator password.

Note

Unauthorized access

To prevent unauthorized persons from logging on and gaining free access to the configuration settings and client-server connections, you should immediately assign a new administrator password after first commissioning or restoring of factory settings.

The administrator password can be changed in the "Configuration > Passwords" Start menu.

1. Touch the "Change administrator password" button. The "Change password" dialog opens.
2. Enter the old password.
3. Assign a new password.

Note that the number of characters is limited to a minimum of 8 and a maximum of 32. It is possible to enter a blank administrator password, but not a space as the administrator password.

4. Repeat the new password.
5. If you select "Hide passwords", the password is no longer shown when you log on.

Forgetting the administrator password

If you forget your administrator password, you must restore the factory settings.

Note

Losing the current configuration settings

When restoring to factory settings, the current configuration file is overwritten.

After factory settings are restored, a saved configuration file can be transferred back to the device.

Once the configuration file is restored, the password contained therein will be valid after the device is restarted. Change the password if necessary, and make a note of it.

Closing connections with connection password

You can specify a password for terminating a client-server connection in the Start menu "Configuration > Passwords". If the operator wants to terminate a connection, this connection password must be entered (not for a SINUMERIK connection). If the operator enters an incorrect password, the connection will not be terminated.

Note

Misuse

No connection password is assigned in the factory state. Without password protection it is possible for unauthorized persons to terminate client-server connections.

Following initial commissioning and after restoring the factory settings, you should immediately assign a connection password.

Closing Citrix and connection password

When an operator closes a Citrix application program via the user menu or closes the Windows window, Citrix is also terminated without entering the connection password.

The length of the connection password is restricted to a maximum of 30 characters.

Note

If a connection password has been specified, you can alternatively terminate a client-server connection by using the administrator password.

If you select "Allow restart", the menu entry "Restart" will be displayed underneath in the Start menu. The operator can use this entry to restart the device.

Changing the connection password during ongoing operation

Changing the connection password works in the same way as "Changing the administrator password" (see above) , for example from an external PC, while the operator is working on the device. The change of the connection password becomes effective immediately. The operator can then only terminate the current client-server connection with the new connection password.

You can also change the connection password by entering the administrator password instead of the old connection password.

See also

Opening the configuration (Page 40)

System settings (Page 46)

Access and structure (Page 43)

5.3.7 Desktop settings

Introduction

The following figure shows the desktop settings in the Start menu "Configuration > Desktop".

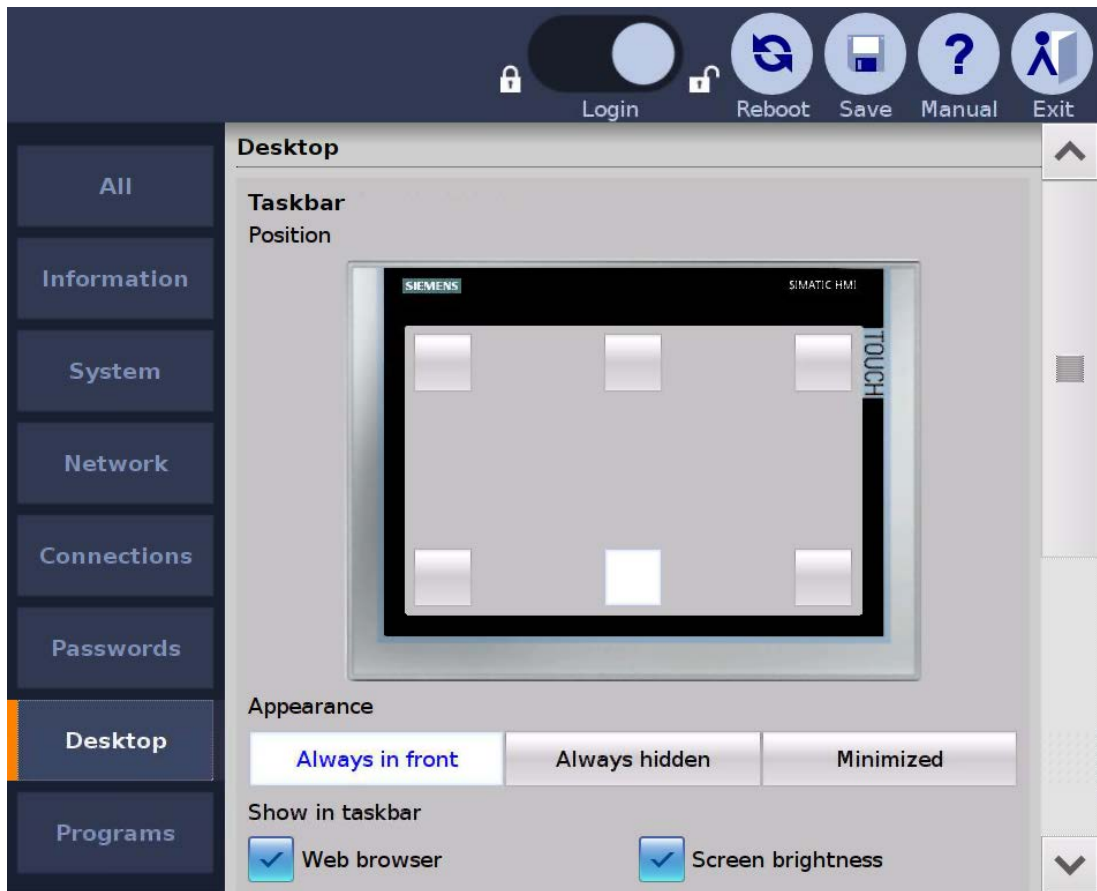

You can make the following settings:

- Position of the taskbar
- Display of the taskbar
- Menu entries in the Start menu
- Size and position of the on-screen keyboard
- Background image

Specifying the position of the taskbar

Touch one of the 6 buttons on the displayed touch screen. The configuration settings will be saved and the taskbar will then be moved to the corresponding position. The taskbar cannot be moved with drag&drop. The default position of the taskbar is "Bottom center".

Specifying the display of the taskbar

Note

Faulty touch calibration

If the touch screen has not been calibrated or has been calibrated improperly, you will only be able to re-display a hidden taskbar by means of a connected external mouse.

Make sure that the touch screen of your HMI device has been calibrated correctly.

- "Always in front" (default setting)

The taskbar is displayed after the device is switched on. The buttons to minimize or maximize the taskbar are not displayed. The operator cannot change the taskbar.

- "Always hidden"

The taskbar is hidden. The operator cannot display the taskbar and, thus, cannot make any changes to the active client-server connections. Because the configuration settings cannot be opened without the taskbar, this setting can only be disabled again with external access (see section "Remote configuration of several devices (Page 71)").

- "Minimized"

The taskbar is minimized in the display. The operator can maximize or minimize the start bar using the appropriate buttons, which are always shown.

Specify size of "Minimize start bar" button

When the "Minimize start bar" option is activated, the height of the "Minimize start bar" button is reduced by half.

Specifying menu entries in the Start menu

The settings show the menu entries of the Start menu in the taskbar.

- Web browser
- Screen brightness
- Clean screen
- Calibration
- USB devices

If you select a menu entry, it will be displayed. If you deselect a menu entry, it will be hidden and can no longer be called.

Specifying the size and position of the on-screen keyboard

In "Position", you can dock the on-screen keyboard at the top or bottom edge of the screen. In "Size", you select one of 5 predefined keyboard sizes.

Setting up a background image

Under "Background image", specify a graphic file to be displayed as the background image. Use the "Browse" button to select a graphic file on the connected USB drive.

Note

Required properties of background images

- Format: PNG, JPG, JPEG
- File size: max. 5 MB
- Resolution: Maximum 1920 x 1080 for ITC2200
- Colors: Maximum 16777216

Display of the background image

- The background image is always stretched to fit the screen resolution, even when this distorts it and grossly enlarges it.
- Therefore, the background image should have exactly the same width x height as the screen resolution, for example 1280 x 800, or at least the same proportions, for example 640 x 400.

Restoring the factory settings

The background image is restored.

See also

Structure and functions of the taskbar (Page 97)

Starting a connection (Page 99)

5.3.8 Application settings

Introduction

Additional, configurable application programs (software applications) can run on the Industrial Thin Client. The web browser is currently the only application.

The following figure shows the web browser settings in the Start menu "Configuration > Applications".

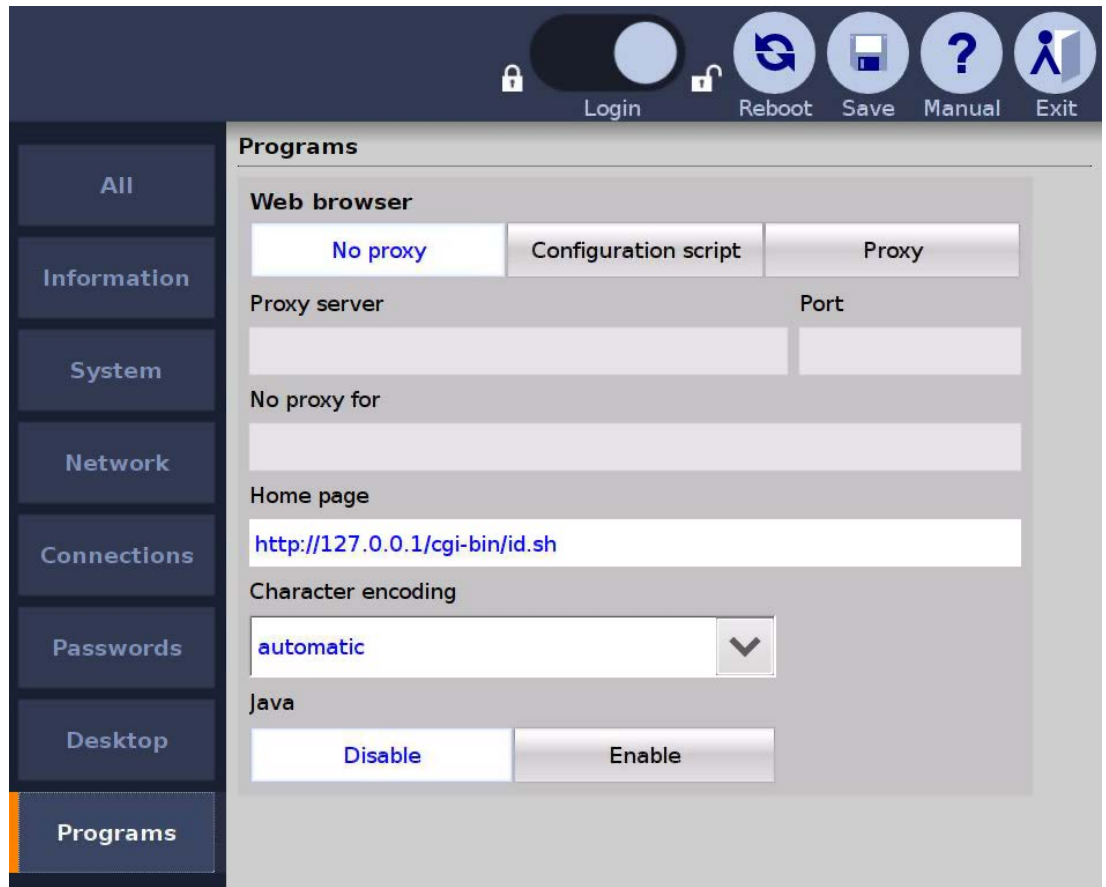

- If "Proxy" is selected: Enter the address of a central connection node in "Proxy" if your network accesses the Internet from this connection node, e.g., in order to filter web contents or make them available in the cache. In case of doubt contact your system administrator.
- If "Configuration script" is selected: In "Configuration script", specify the address of a script that picks out the appropriate proxy server for each web address. The configuration script contains a JavaScript function with proxy specifications, e.g., for the case that a server does not answer. The configuration script is provided by your network administrator.
- For addresses that you enter in "No proxy for", there is no proxy server request, and a direct connection to the Internet or an intranet will be established instead. Use a comma to separate multiple addresses (see "Proxy bypass").
- If "No proxy" is selected, there is no proxy server request, and a direct connection to the Internet or an intranet will be established instead.

- Under "Port", specify the internal port at which the proxy server can be reached: The default is 8080.
- In "Home page", specify an Internet address that will be called automatically when the web browser starts.
- With "Character encoding", you specify the character set that is used by the web browser if a web page does not provide any information about the character set to be used. The character set "UTF-8" is set by default. You can have the appropriate character set determined "automatically". If characters are represented incorrectly, you can also change to "ISO-8859-1".
- You can enable or disable the Java support by the browser with Java. For security reasons, Java is disabled by default.

Proxy bypass

You can make the following entries in the "No proxy for" field:

Object for which no proxy is to be used	Content of the input field "No proxy for"	Example	Comments
Domain	Suffix of the domain	".siemens.com, siemens.com"	Both suffix variants must be entered in order to exclude an entire domain.
Host name (without domain)	Host name only	"MyWinPC"	Excludes "MyWinPC".
Host name (with domain)	Host name and domain	"MyWinPC.siemens.com"	Excludes "MyWinPC".
IP address	IP address	"192.168.1.0"	Excludes the device with the IP address "192.168.1.0".
Network	IP address range	"192.168.1.0/24"	Excludes all devices with an IP address in the range from "192.168.1.0" to "192.168.1.24"

Placeholder characters are not permitted, e.g. "*" or "192.168.*.*".

No entries are set as default.

The "localhost" and "127.0.0.1" objects are always excluded. No proxy is used for these objects.

Adjusting the display in the web browser

You can enlarge or reduce the display in the web browser:

- Use the key combination <CTRL><+> to enlarge the display.
- Use the key combination <CTRL><-> to reduce the display.

Note

Depending on the keyboard you are using, it may be necessary to press the Shift key to access the "+" and "-" keys. In this case, use <Control><Shift><+> to enlarge the display and <Control><Shift><-> to reduce it.

See also

Opening the configuration (Page 40)

5.4 Remote configuration of several devices

5.4.1 Introduction

Introduction

Remote Configuration Center (RCC) enables remote configuration and remote update of SIMATIC Industrial Thin Clients from a PC that is connected to the Industrial Thin Clients via a network. This chapter describes:

- The requirements and mechanisms for remote configuration and remote update
- The operation

Area of application

You can perform the following actions from a central PC for one or more Industrial Thin Clients:

- Edit configuration settings
- Back up and restore the configuration
- Identifying a device
- Change IP addresses
- Update firmware
- Generate a key pair
- Restart devices

5.4.2 Installation

Requirements

The following requirements must be met for operation:

- The Industrial Thin Client is in a PROFINET or Ethernet network.
- At least 1 network adapter is installed in the PC.

- One of the following operating systems is installed on the PC:
 - Windows Server 2008 R2 SP1 (64-bit)
 - Windows Server 2012 (64-bit)
 - Windows Server 2012 R2 (64-bit)
 - Microsoft Windows 7 Professional/Enterprise/Ultimate (32-bit and 64-bit)
 - Windows Embedded Standard 7 SP1 (32-bit and 64-bit)
 - Windows Embedded 8 Standard (32-bit and 64-bit)
 - Windows Embedded 8.1 Industry (32-bit and 64-bit) (Pro)
 - Windows 8.1 PRO (32-bit and 64-bit)
- You need administrator rights on your PC.
- You need a PDF reader compatible with Acrobat 5.0 or higher on the PC to read the documentation.
- For the remote configuration, a screen resolution of 1280 x 1024 is required on the PC.
- The following destination ports must be accessible on the devices:
 - Port 80
 - Port 22

Note

Firewall

The firewall settings are not changed by the installation. You must do this yourself if necessary.

Procedure

To install the Remote Configuration Center, proceed as follows:

1. Double-click on the self-extracting file "Thin_Client_Configuration_Center_V2_SP2.exe" on the supplied CD. A dialog for unzipping the file appears in English.
2. Use the "Browse" button to select a directory for temporarily storing the extracted files and close the dialog using the "Unzip" button.

The files are unzipped. Installation starts automatically.

3. Follow the instructions displayed on the screen. Press "Next" to switch to the next dialog.
4. Accept the license agreement and close the dialog with "Next".

The "Set PG-PC Interface" dialog appears.

5. Select a network adapter for the network, and close the dialog with "OK". The network adapter can be changed later via the Windows system settings.
6. Complete the installation at the end of the installation process with the "Finish" button. We recommended that you reboot the PC.

Result

Remote Configuration Center is installed in the default directory, "C:\Program Files\Siemens\".

See also

Product Support SIMATIC Thin Client
(<http://support.automation.siemens.com/WW/view/en/59368467/130000>)

5.4.3 Start

1. Start Remote Configuration Center via "Start > SIMATIC > Thin Client Configuration Center Vx.y.z > Remote Configuration Center".

A dialog for assigning a master password is shown during initial start. Specify a master password for RCC.

The master password is requested at each RCC start and is valid for the current session.

NOTICE

Access to devices is lost

If the master password has been lost or reset, you can no longer access detected devices.

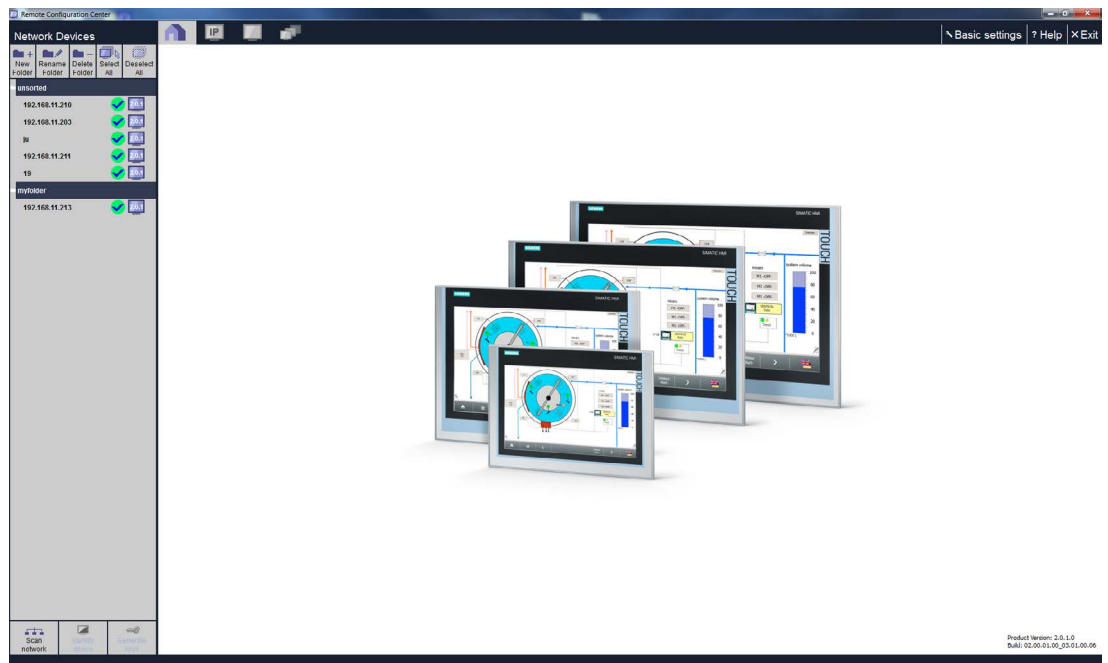

The "Home page" tab is loaded by default following startup, displaying the firmware version and its serial number. If you select "Help" in the menu bar, help is displayed.

5.4.4 Operation

5.4.4.1 Overview of remote operation

User interface

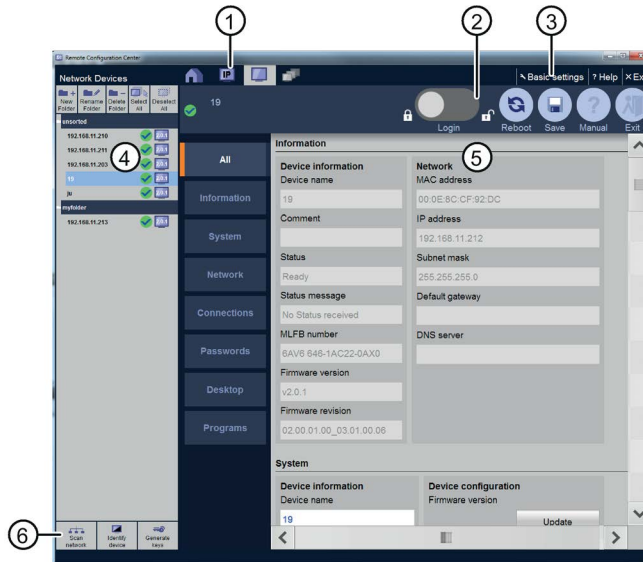

No.	Name	Position	Display
①	Tab	In topmost position	Displays the configuration settings of one or more devices, IP address assignment or home page
②	Toolbar	Top	For editing the configuration settings of one or more devices
③	Menu bar	Top right	Configure and close RCC
④	Device window	Left	Device tree of all devices in the network
⑤	Configuration window	Right	Shows the individual configuration settings
⑥	Action bar	Bottom left	Buttons for performing an action

Basic remote actions on a device

1. Always touch the **"Scan Network"** button first in the action bar ⑥. All Industrial Thin Clients that can be reached via the network adapter, including switches, are added one after the other to the **device tree** ④ with "Device name".
If no device name is available, the IP address is displayed. If no IP address is available, the MAC address is displayed.
2. Touch the **"New folder"** button in the action bar ⑥, and assign a name, e.g., "Machine1". You can "Rename" and "Delete" existing folders.
3. Use **drag-and-drop** to move devices to the new "Machine1" folder in the device tree ④. The folder is saved retentively in the local device memory. As a result, the device is always assigned to this folder.

Note**Devices of earlier versions**

- Firmware versions lower than V2.0.2 do not support folders. Therefore, older devices cannot be assigned and always appear in the "Thin Clients V1.X" folder.
- Devices with firmware version lower than V2.0.2 can no longer be configured. The character "Info" is displayed next to the respective device. The following continues to apply:
 - Thin Client 1.4 devices are shown as existing and cannot be updated.
 - Thin Client 2.0 devices with firmware version lower than V2.0.2 are shown as existing; configuration settings can be shown but not changed. The firmware version can be updated to V2.0.2.

Permanently renaming or deleting the folder

In order to save the folder together with the configuration setting on each device, the configuration settings of all devices in the folder must be changed (see section "Overview of remote operation (Page 74)").

4. Select a device in the device window ④, e.g., from the "Machine1" folder.
5. Click the "**Identify device**" button. The screen of the device flashes at the location on Maschine1.
6. Select several devices. To do this, open the on-screen keyboard and hold down the <Ctrl> key while selecting several devices one after the other in the device window ④.
7. You can select "**Restart devices**" or "**Update firmware**" for the selected devices from the toolbar ②. Note the additional information in the section "System settings (Page 46)".
In both cases, an **action dialog** appears with a progress bar and device list. Based on the **device status**, you see if the configuration settings are being saved ("In progress") or if the device can be restarted ("Ready"). Detailed information is available in the section "Status (Page 79)".

Note**Restrictions for actions**

You can only perform one action after another on a device. Before performing an action on a device, wait until the actions on all selected devices have been completed.

Save the configuration file remotely and reload it

The configuration file contains all device-specific configuration settings with the exception of the background image and the touch calibration. Save the configuration file of a device on the central PC. From there, you can reload the configuration file to a device:

- Use the "Save" button to back up the configuration file for the device on the PC. To do this, you select a folder in the file system and close the dialog with "OK".

A dialog for entering the password for the protected configuration file is shown. This password is required when the configuration file is loaded.

NOTICE**Keeping the password**

If this password is lost, it will no longer be possible to load the configuration file.
Make sure that the password is not lost.

- Use the "Load" button to import the backed up configuration file from the PC again, for example if the current configuration file has been inadvertently overwritten. To do this, you select a configuration file from a file dialog and close the dialog with "OK".

A dialog for assigning a password is shown when a password-protected configuration file is loaded.

Note

Pay attention to all the information in the section "Configuration settings of the device" in the corresponding section of the "System settings".

See also

- Installation (Page 71)
- Perform action (Page 78)
- Opening the configuration (Page 40)
- Assigning the IP address (Page 80)
- Network settings (Page 51)

Editing configuration settings of several devices synchronously

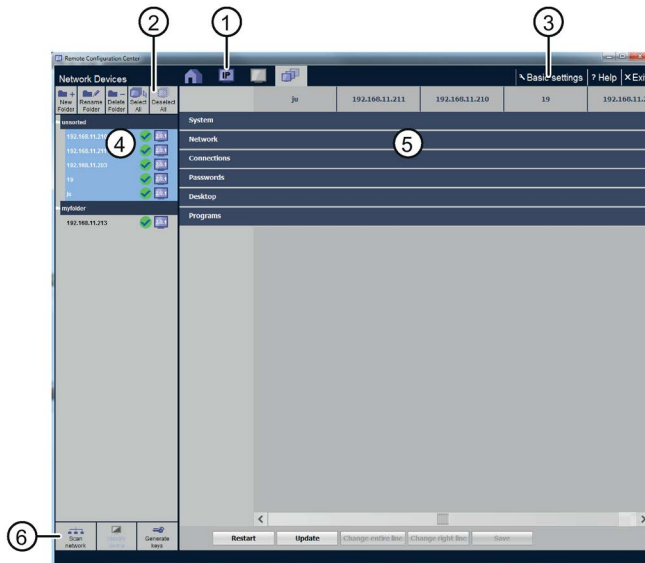

1. Select one or more devices in the device window ④. The configuration window ⑤ then displays the following:
 - **One device** selected: **the same** configuration settings as on the device (see "Opening the configuration (Page 40)"). You navigate via the submenu on the left.
 - **Several devices** selected: configuration settings in a **table**. You navigate via the tree view on the left. Only one setting group is expanded at a time: each row contains a setting, and the columns contain the selected devices.
Click in **one cell**, to change this setting for **one device**.
 - **No device** selected: the **Home page**.

1. Change any settings in the individual cells, for example, the screen brightness.
2. To edit the **IP addresses** of the selected devices at the same time, switch to the "IP" tab ① (see section "Assigning the IP address (Page 80)"). If you change or dynamically assign IP addresses, observe the notes in the section "Network settings (Page 51)".
3. Touch the **"Save"** button in the toolbar ②. If there are IP address conflicts, an error message appears. Otherwise, the modified configuration files are transferred to the selected devices as if the changes were made locally on the device.

Copy button

If you touch the **"Change entire line"** button in the toolbar ②, the last change is transferred to the entire row and is copied to all cells of the row.

Example: You change the value in the "Subnet mask" cell of device "x". The "Change entire line" button transfers the new value to all cells of the line: the same subnet mask appears for all selected devices.

Restriction: The **"Change right line"** button transfers the new value to all cells located to the right of the modified cell. The cells located to the left remain unchanged.

Special features for connections

If you select **"Connections"** in the configuration window ⑤, the currently configured client-server connections for each selected device are transferred one after the other and displayed row-by-row in the configuration window (**complete connection list**).

If a device has exactly the connection displayed in the **row**, the relevant **column** receives a **check mark**. If you select a check mark and save the configuration settings, the connection is copied to the relevant device.

Note

Two connections will only be entered in one row, if all connection settings match exactly, e.g., same connection name, same server (IP address), same description, same options.

If you deselect all check marks for a connection and save, this client-server connection will be deleted on all selected devices.

The toolbar then displays the "New connection" button **instead of the copy buttons**. You use the button to create a new connection that is saved to the devices whose check marks are selected. To the left of each row is the **Edit button**, which can be used to change the connection settings.

Special features for passwords

If you select **"Passwords"** in the configuration window ⑤, the currently configured passwords for each selected device are transferred one after the other and displayed row-by-row in the configuration window (**complete password list**).

If you select a check mark and save the configuration settings, the password is copied to the relevant device. You can also specify whether or not a user can restart the device.

The toolbar displays the "New connection password" and "New administrator password" buttons **instead of the copy buttons**. You use the buttons to create passwords that are saved to the devices whose check marks are selected. To the left of each password is an **Edit** button, which can be used to change the password.

See also

Overview of remote operation (Page 74)

5.4.4.2 Perform action

Procedure

Note

Actions only one after the other

You can only perform one action after another on a device. Before performing an action on a device, wait until the actions on all selected devices have been completed.

Proceed as follows to perform an action:

1. Select one or more devices in the device window. To select all devices, touch the "Select all" icon.
2. Select an available action, for example in the action bar.

Note

Unavailable buttons are grayed-out

Certain actions cannot be performed at every point. The corresponding buttons are then grayed out.

The action is performed on all selected devices. An action dialog with the list of the processed devices and the current status is displayed.

3. Wait until all devices have been processed.
4. Check the status in the device list.
5. Use the "Done" button to close the action dialog if it does not close automatically.

Now you can perform the next action.





Status

The status describes the outcome of the last action that was performed on this device (see section "Status (Page 79)").

5.4.4.3 Status

A status symbol and monitor icon is displayed in the device tree to the right next to the device name.

- The status describes the outcome of the last action for each device.
- The monitor icon displays the firmware version of the device.
- A question mark means no version information is available, for example, if the device cannot be found.

Icon	Designation	Meaning
	Ready	The (latest) action performed on the device was completed successfully. The Industrial Thin Client was found on the network and can be reached via its IP address. The current network settings and the latest device data are displayed.
	Error	The (latest) action performed on the device was not completed successfully. Possible causes: <ul style="list-style-type: none"> • No Industrial Thin Clients were found in the network • The device is not accessible via the private key.
	Info	The Industrial Thin Client cannot be reached in the network via its IP address. The displayed device data may not be current. Possible causes: <ul style="list-style-type: none"> • The device has an incorrect IP address or no IP address. • The device is in a different IP network (subnet). • The network adapter has an incorrect IP address. Or the device's firmware does not support the (last) action, see section "Perform action (Page 78)". You can find additional information in section "Overview of remote operation (Page 74)".
	Restart	The device is restarting.
	In progress	An action (not a restart) is not yet completed on the device.

Note

A status message is shown under "Information" in addition to the general device data under "Status" in the device window of the configuration settings.

5.4.4.4 Assigning the IP address

In the "IP" tab, assign new IP addresses for one or more devices.

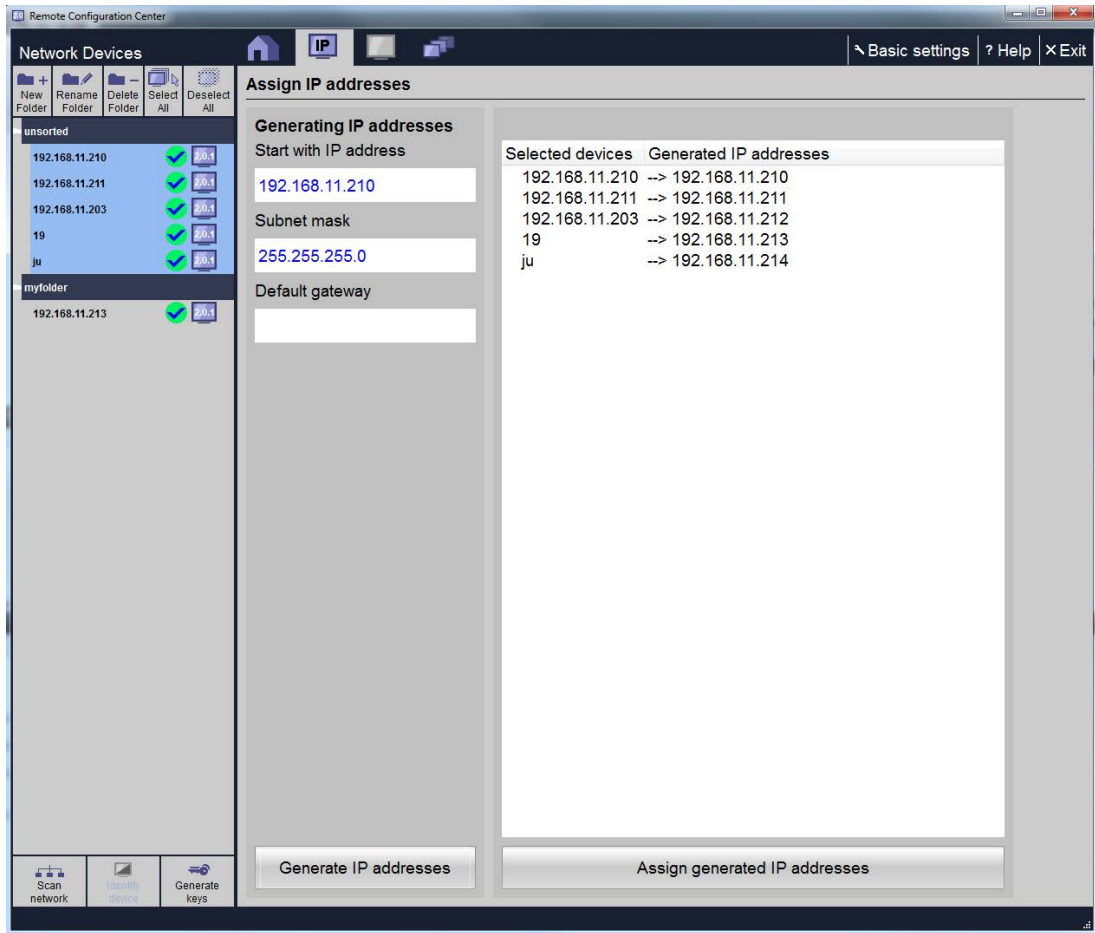

Note

No connection between client and server

If you change the IP address, an RDP, VNC/Sm@rtServer, or SINUMERIK connection may be interrupted. Communication between the device and server is then not possible.

IP address conflicts

If you manually assign IP addresses, make sure that different devices do not have the same IP address. Assign IP addresses that are not yet assigned in the network.

Assign a start address under "Start with IP address" a "Subnet mask" and "Default gateway" for all selected devices. Use the "Generate IP addresses" button to create a sequential IP address for each selected device in the order given in the device window. These addresses appear in the preview window. The "Assign generated IP addresses" button assigns the new IP addresses to the devices. The network is then automatically scanned again.

5.4.5 Backing up remote configuration

SSH configuration service

The device is factory set to be remotely configured via the SSH configuration service, which enables remote configuration.

NOTICE
Impairment of security due to SSH
<p>This means unauthorized personnel can log on via SSH and have free access to the devices and client-server connections. Data security may not be guaranteed in case of inappropriate handling of the SSH configuration service and the security on the machine and in the plant can no longer be guaranteed.</p> <ul style="list-style-type: none">• The SSH configuration service may only be used by qualified personnel. The persons considered as qualified personnel are listed in the paragraph "Qualified Personnel" on page 2.• If you do not need the remote configuration service, disable it in the System settings (Page 46).

Resetting the key

You can reset the key on the device to the default key by restoring the factory settings.

Automatic key assignment

The "Generate key" function is executed automatically during the initial searching of the Remote Configuration Center network. This Remote Configuration Center is then assigned to the Industrial Thin Clients that are found. Other Remote Configuration Centers can no longer access the assigned Industrial Thin Clients.

To maintain access via other Remote Configuration Centers, the keys have to be reset on the device; see previous section "Resetting the key".

5.4.6 Assigning a key

Generating a new key pair

A pair of private and public keys provides security for remote updating and remote configuration. The public key is installed by default on the device. If you install the remote configuration on a PC, the private default key is stored in the device directory.

NOTICE
Danger of data misuse
The default private key file is the same for each device. Generate a new global key pair for each device. Only the new key pair can then be used.

Use the "Generate key" button to generate a new global pair of keys for each selected device: The new public key is always installed on the device. The new private key file is stored on the PC in the device directory. The old key file is backed up.

Restoring keys

Note

No remote access

The remote configuration can no longer be used to access the device in the following cases ("Error" status):

- The public key has been deleted.
- The device was secured on site by a local, individual key pair.
- A new key pair has been generated remotely on another PC.

In this case, restore the factory settings by choosing one of the following procedures:

- On the device on site.
- Via remote configuration in the configuration settings of the device under "System settings (Page 46)".

Additional information is available on the Internet in the product information "Remote configuration and remote update

(<http://support.automation.siemens.com/WW/view/en/35105474>)".

The action contains the "Info" status with a status message prompting you to generate a new global pair of keys using the "Generate key" button.

5.4.7 Basic settings

You make the basic settings for remote configuration via the menu bar and the Windows system settings.

1. Select "Basic Settings" in the menu bar.

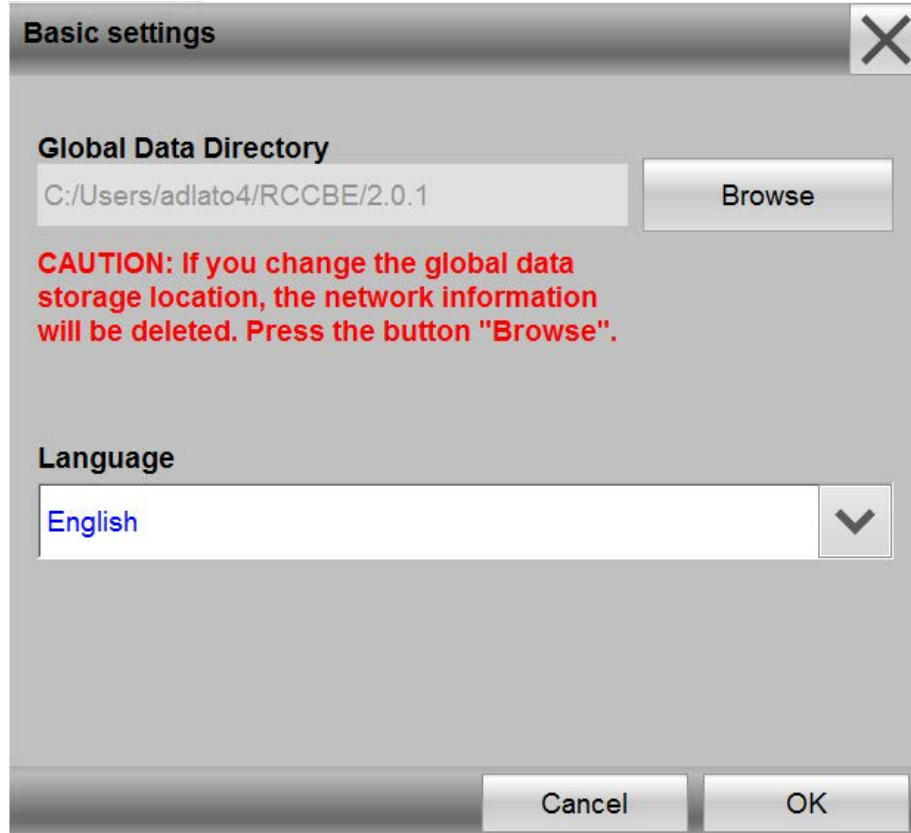

2. Under "Global Data Directory", use the "Browse" button to specify the root directory in which a separate device directory is created for each device. The private key of the respective device is stored in the device directory and its configuration file is saved there.

Note

Changing the path for "Central data storage" later

When you change an existing path and key pairs have already been generated in the previously used folder, you have to copy the content of the previous folder to the newly specified folder.

3. Set the "Language" for the interface of the remote configuration.
4. Close the dialog box with the "OK" button.

The other settings are located in the Windows Control Panel:

1. In the Windows Start menu, select "Start > Settings > Control Panel > Set PG-PC Interface". The "Setting PG-PC Interface" dialog appears.
2. Select a network adapter which has been detected on the PC. Only devices within a PROFINET network can be remotely configured.

Configuring the server

6.1 RDP

6.1.1 RDP overview

Introduction

RDP, "Remote Desktop Protocol", is a protocol that the Industrial Thin Client uses to access a server with a Windows operating system, e.g. Windows Server. The Industrial Thin Client can access all programs running on the server, if the programs have been enabled for remote access. The following statements also apply accordingly to Windows 7.

Licensing the Windows Server

You do not require any licenses on your device to access the server. You require the following server licenses:

- One Windows Server license per server
- One Windows Server Client Access License (CAL) per user
- Additionally, one Terminal Server Client Access License (TS User CAL) per user that can be used independent of the device

Note

TS Device CAL cannot be used

In the case of the "TS Device CAL" license, which can be used on a certain device independently of the user, the device is logged onto the license server using the last four digits of the MAC address. When you replace the device, the license is blocked by the license server and released again after about 3 months.

User CAL and Device CAL licenses are supported for all approved Windows operating systems.

Detailed information on licenses and applicable conditions of use are available on the Internet under "Windows Server 2003 Terminal Server Licensing (<http://www.microsoft.com/windowsserver2003/techinfo/overview/termservlic.mspx>)".

Licensing Windows 7

You do not require any licenses on your device under Windows 7 to access the server. Only one license on the PC for your operating system, e.g. Windows 7.

You do not require any additional licenses on the server for Remote Desktop.

See also

System requirements (Page 18)

6.1.2 Administration on the server

Administration Windows Server

The administration on the server depends on the individual IT infrastructure. Establish the settings for the server configuration under the following menu commands under "Start > Programs > Administrative Tools:"

- Terminal services configuration
- Terminal services administration
- Terminal services licensing

You will find more information on the Internet in the "MSDN Knowledge Base" of the "Microsoft support (<http://support.microsoft.com>)".

You can specify on the server that certain users of the Industrial Thin Client can only access specified programs on the server.

When the device is configured, you assign a password for the connection to the server. If the device establishes a connection to the server, a password will be requested by default irrespective of this. Under "Start > Programs > Administrative Tools > Terminal Service Configuration" you can specify that the password is not requested again.

Administration Windows 7

In order for the Industrial Thin Client to access the server, you must enable remote access on the server. You can enable remote access under "Start > Settings > Control Panel > System > Remote" with the option "Allow users to establish a remote desktop connection." Use the "Select remote users" button to open a dialog in which you select the users that are authorized to access the server.

In addition, you enable the server ports that have been set for remote access in the firewall.

Keyboard language

A German-language on-screen keyboard and an English-language on-screen keyboard are available on the device. Set the keyboard language on the device so that it matches the keyboard language on the server. If the keyboard languages on the device and the server are different, the keys pressed on the device keyboard will not be interpreted correctly on the server.

Configuring double-click

If it is too difficult to double-click the touch screen with your finger or the touch stylus, then make the setting in Windows Explorer on the server that files and folders should open with a single click under "Tools > Folder options > General > Click items as follows".

You have the option to establish a greater range in which two clicks can be detected as a double-click under [HKEY_CURRENT_USER\Control Panel\Mouse] in the Windows registry of the server. Under "DoubleClickHeight" and "DoubleClickWidth" enter 10 pixels, for example.

Windows 8.1

If you connect via RDP to a Windows 8.1 PC on which another user is already logged on, the user must confirm your access to the PC. Alternatively, you can wait 30 seconds to get access automatically. However, the connection is then often interrupted with the misleading error message "Session was disconnected because of unknown error".

6.2 Citrix:

6.2.1 Citrix overview

Introduction

The Citrix Receiver software provides business applications centrally for any terminal devices at all business locations as on-demand service. This may take place in form of hosted applications that are executed on a server in the company data processing center. Rollouts of new applications, updates and patches are thus available immediately to all users.

Citrix server licensing

To access the Citrix server, you do not require any licenses on your device. Depending on your specific requirements, you need a Citrix XenApp or XenDesktop server.

See also

System requirements (Page 18)

6.2.2 Connecting to a Citrix application or a desktop

Connections to a specific application or a desktop can be configured with the help of the Remote Configuration Center on a PC or via the local configuration settings on the Industrial Thin Client.

To access a Citrix application or a desktop, you have the following two options:

- Connection type "Citrix Application List":

You specify all parameters of the Citrix connection with the exception of the application that is to be opened. When the connection is started, the user can select which application is opened.

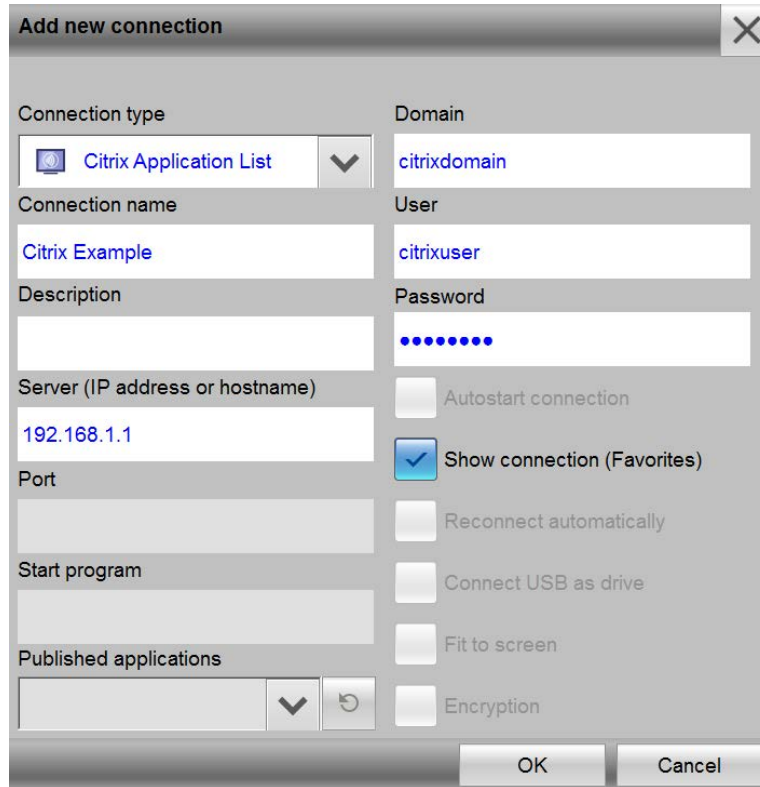

- Connection type "Citrix Application":

You specify all parameters of the Citrix connection including the application that is to be opened when the connection is started.

In order for applications to be shown in the start bar, they have to be configured as favorites on the server.

Depending on the server configuration, you can also access these applications or desktops via the Web browser.

6.2.3 Restrictions

The following restrictions apply to the Citrix client of the HMI device:

- Automatic scaling is not supported.
- Access to USB storage media is not supported.
- Read/write access to the local file system is not supported.
- Only one connection can be active at any given time. A message is displayed if you try to open a Citrix connection while a Citrix connection is already in place. The user is informed that the existing connection must be closed before the new connection can be established.

- The following functions are not available during the configuration of Citrix connections:
 - "Autostart connection"
 - "Reconnect automatically"
- The Citrix client supports the following certificates:

Certificate	Issuer
Class4PCA_G2_v2.pem	VeriSign Trust Network
Class3PCA_G2_v2.pem	VeriSign Trust Network
BTCTRoot.pem	Baltimore Cyber Trust Root
GTECTGlobalRoot.pem	GTE Cyber Trust Global Root
Pcs3ss_v4.pem	Class 3 Public Primary Certification Authority
GeoTrust_Global_CA.pem	GeoTrust

If the Citrix server is configured with secure hypertext transmission protocol "https" and has a certification authority that deviates from the listed issuers, no connection can be established. In this case, a dialog to import certificates via a USB storage medium is shown. The certificate is added to the Citrix certificate folder after it has been imported in .pem format. The connection is restarted after the certificate has been successfully imported.

6.3 VNC

Introduction

Use VNC for remote control of another computer via a network. VNC is the abbreviation for "Virtual Network Computing" and shows the desktop of another computer. In contrast to RDP, all clients display the same server screen.

Requirement

The operating system you use does not play a role because the software is available for all current platforms. The connection via the network uses the TCP/IP protocol and should be configured with a password for security reasons.

Layout

VNC works according to the client-server model. The program consists of the server module VNC server and the client component VNC Viewer. The server program runs on the computer whose screen outputs you want to monitor, whereas the clients receive the screen outputs and in turn send keyboard and mouse inputs to the server.

See also

System requirements (Page 18)

6.4 Sm@rtServer

Introduction

With the SIMATIC WinCC Sm@rtServer option, HMI devices communicate with each other via PROFINET. The WinCC option thus enables client/server configurations for distributed operator stations in a plant.

If the SIMATIC WinCC Sm@rtServer option is installed on an HMI device, for example, on an MP 377 or Comfort Panel, the Industrial Thin Client can access the running project via Ethernet. In this case, the HMI device is the server. The Industrial Thin Client is a client.

A description of the Sm@rtServer configuration can be found in the online help of WinCC or in the "WinCC Getting Started Options" manual.

Sm@rtServer-capable HMI devices

The SIMATIC WinCC Sm@rtServer option can be used for all HMI devices as of device class 177B PN. You can refer to the documentation of your HMI device regarding the number of clients that are possible with an HMI device that is used as a server.

Licensing

You do not require any licenses on the Industrial Thin Client in order to access an HMI device. The licenses are included in the SIMATIC WinCC Sm@rtServer option. The Sm@rtServer license must be installed on the HMI device you are accessing with the Thin Client.

See also

System requirements (Page 18)

6.5 SINUMERIK

Introduction

The DHCP server is enabled on each SINUMERIK server by default. The SINUMERIK system network therefore configures itself dynamically via the DHCP protocol. Additional information is available in the "SINUMERIK manual "Operator components and networking" (6FC5397-1AP10-5AA0) (<http://www.automation.siemens.com/doconweb/>)".

USB stick for commissioning

You use a button on the HMI user interface of the SINUMERIK TCU to access the USB port on the rear of the device. For example, you read in the series startup files on the SINUMERIK USB stick. A maximum of one USB storage device is accessed which is recognized first.

Note

Security threat to the system

The USB may infect the server with viruses, Trojans, spam, etc.

Use a suitable virus scanner to check the data on the USB storage medium or disable the HMI button for access via USB.

The USB port is only available if you make the following settings for the corresponding button in the SINUMERIK menu "Commission > HMI > Logical drive":

- "Type" = "USB local"
- "Connection" = "X204"

Keyboard language with external keyboard

 CAUTION
Damage to the machine or plant through operating error
The set system language, for example German, also determines the keyboard language of the externally connected USB keyboard. If you then connect an English keyboard, however, such as is the case with a SINUMERIK connection, the keys do not have the same meaning as is printed on them.
This may result in operating errors at the machine and personal injury or damage to the machine or plant. To connect an English keyboard, set the system language to English under "Language" in the Start menu "Configuration > System".

See also

System requirements (Page 18)

6.6 WinCC OA

Introduction

SIMATIC WinCC OA (Open Architecture) is a SCADA system for visualizing and operating processes, production work-flows, machines and plants in all industries.

You can find the description of WinCC OA configuration in the online help of WinCC OA under "Special Functions > Industrial Thin Client". You can find additional information on the Internet at SIMATIC WinCC Open Architecture (<http://w3.siemens.com/mcims/human-machine-interface/en/visualization-software/simatic-wincc-open-architecture/wincc-oa-basic-sw/Pages/default.aspx>).

Requirement

A SIMATIC WinCC OA server that supports Industrial Thin Clients is a requirement for operating a SIMATIC WinCC OA connection.

Operating principle

The Industrial Thin Client operates similarly to a SIMATIC WinCC OA WebClient.

The WinCC OA server provides the client components to the Industrial Thin Client.

Licensing

You do not require any licenses on the Industrial Thin Client in order to access WinCC OA. The license is covered by the user interface license on the WinCC OA server. More on this in the online help of WinCC OA.

See also

System requirements (Page 18)

Operating the device

7.1 Overview

Introduction

If you are using the device to access a server, the screen display of the server is shown on the device. You operate the server screen from the device.

Operator input options

The following operator input options are available, depending on the peripherals that are connected to your device:

- Touch screen

You activate operating elements by touching them with your finger.

To double-click them, touch an operating element twice in succession. The server can be configured for opening folders and files with a single click.

- External keyboard, connected via USB
- External mouse, connected via USB

NOTICE

Incorrect operation on the touch screen

The accuracy of the touch touch decreases over time: The position touched for an operation may no longer match the position evaluated by the touch screen. Incorrect operation of the machine and the plant is the result.

Calibrate the touch screen regularly (see section "Calibrating the touch screen (Page 106)").

Unintentional actions

WARNING

Unintentional actions

Always touch only one operating element on the screen Otherwise, you may trigger unintentional actions.

On-screen display for remote access to a server

The server screen is displayed as a full screen.

Additional information is available in the configuration settings, Section "Connections (Page 55)".

Monitoring mode

If you access a device on which only monitoring mode has been configured for Sm@rtServer access, you can only monitor the device; you cannot intervene for control purposes.

Operating right for SINUMERIK and Sm@rtServer

When you access a device, it is possible that this device is being used at the time. In this case, the Industrial Thin Client does not have operating rights.

If you touch the touch screen, a message is displayed stating that no operator input is possible. How you request or force operating rights depends on the configuration on the device you are accessing with the Industrial Thin Client.

In the case of the SINUMERIK connection, you request operating rights by tapping the touch screen.

7.2 Front operator controls

Industrial Thin Client

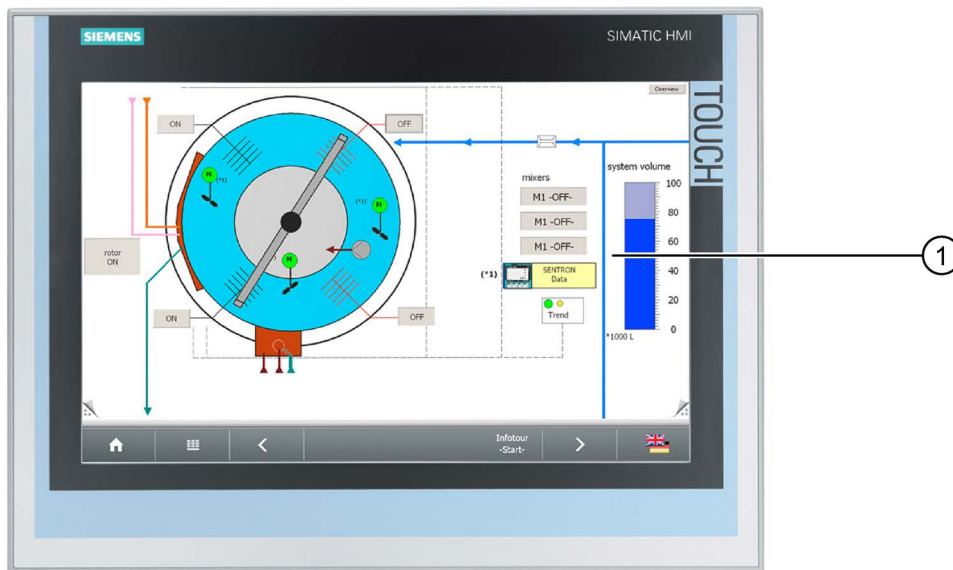

① Display with touch screen

You operate the device with the touch screen. All operating elements required for operator input are displayed on the touch screen once the HMI device has started.

Note when operating

NOTICE

Damage to the touch screen

Operation of the touch screen in the following ways will reduce its service life up to and including total failure:

- Touching it with a pointed or sharp object
- Abrupt impact with solid objects

Use only your finger or a touch pen to touch the touch screen

7.3 Operating the taskbar

7.3.1 Structure and functions of the taskbar

If the taskbar is configured accordingly in the desktop settings (see end of section), the taskbar will be displayed after the device is switched on:



The operator cannot change the position of the taskbar on the touch screen, but the administrator can do so in the desktop settings.

Functions

The following functions can be called from the taskbar.

Start menu

- Web browser: opens the integrated web browser, which displays the Device data (Page 45) as the home page by default. The web browser supports HTML, XML, CSS, JavaScript and Java so that you can establish any type of connection to the Intranet/Internet.
- Screen brightness: adjusts the screen brightness of the background lighting. Two buttons "+" and "-" are displayed on the right for this purpose.
- Clean screen: you use this function to disable the touch screen for inputs for a 15 second period, for example, if the screen is being cleaned (see section "Disabling the touch screen (Page 106)").
- Calibration: calibrates the touch on the touch screen (see section "Calibrating the touch screen (Page 106)").
- USB devices: (see section "Operating a USB memory device (Page 103)").

- Restart: restarts the device (see section "Switching on and testing the device (Page 37)").
- Configuration: central configuration settings of the device.



Connection list, shows the client-server connection that is currently displayed

If you touch the  icon, a list of started client-server connections appears. You use the "Favorites" icon to start a client-server connection. The icons have the following meaning:

- Green check mark: Client-server connection is running.
- Red X: Client-server is interrupted (see section "Interrupting and restoring a connection (Page 38)")

Note

Maximum number of connections

A maximum of 5 client-server connections can be started at the same time, but only one SINUMERIK connection. The screen can no longer be operated when you start a second SINUMERIK connection.

When an attempt is made to start a sixth connection, an error message appears and a selection of started connections is displayed from which a connection can be closed. Close the active SINUMERIK connection before you start a new SINUMERIK connection.

You close a connection using the "X" on the right.



Go to the preceding started client-server connection



Go to the next started client-server connection



Favorites

List of client-server connections selected for the taskbar. If you select a client-server connection from the list, the corresponding connection will be established.



On-screen keyboard

Displays the on-screen keyboard. Use the on-screen keyboard to enter alphanumeric values, special characters and function key commands. The on-screen keyboard is automatically displayed if you edit a field. If you touch the icon again, the on-screen keyboard is hidden.

Taskbar is minimized

If the "Minimized" option is selected in the "Taskbar" area in desktop settings "Configuration > Desktop", the taskbar is only displayed when you touch the button with the "Maximize" arrow on the edge of the screen.

Taskbar is hidden

If the "Always hidden" option is selected in the "Taskbar" area in the desktop settings, the taskbar will always be hidden and cannot be displayed.

Note

If the administrator saves changes of configuration settings, the display and position of the taskbar may be changed.

See also

Desktop settings (Page 66)

7.3.2 Starting a connection

Overview

From the Industrial Thin Client, you can establish a connection to a server with the configured connection settings. The following connection types are supported:

- RDP
- Sm@rtServer/VNC
- SINUMERIK: Bootloader and Viewer are started. A selection menu with the "Open" command is displayed.
- WinCC OA
- Web: besides the web connection, additional web settings are required for the web browser that displays the web connection.

Note

Limited number of client-server connections

A maximum of 5 client-server connections can be started at the same time. If a 6th connection is activated, an error message appears

Only one SINUMERIK connection can be started at any one time. If a 2nd connection is activated, the screen no longer operable.

You can also open the web browser separately in order to connect to the Internet.

Procedure for client-server connection

Proceed as follows to establish a client-server connection:

1. Touch the  "Favorites" icon in the taskbar.
2. Select a client-server connection.

The configured connection to the server or system network will be started.

Procedure for web browser

Proceed as follows to establish a connection to the Internet or an intranet:

1. Select the "Web browser" menu command in the taskbar of the  Start menu. The web browser will open.

The IP address of the device is stored as the home page. The home page displays important device data and network settings.

2. Specify a valid Internet address in the address line of the web browser.

Special features

SINUMERIK

The automatic assignment of the IP address is activated temporarily in the network settings. The SINUMERIK Bootloader briefly displays the IP address of the server currently connected.

The SINUMERIK server first starts the SINUMERIK Bootloader, which loads SINUMERIK Viewer with the configuration file on the Industrial Thin Client. Afterwards the SINUMERIK user interface is displayed on the Industrial Thin Client. For additional information on operation and authorizations, refer to the documentation "SINUMERIK manual "Operator components and networking" (6FC5397-1AP10-5AA0) (<http://www.automation.siemens.com/doconweb/>)".

Note

TCU service menu





To get to the TCU Service menu, close the SINUMERIK Viewer.

See also

Desktop settings (Page 66)

7.3.3 Changing from one connection to another

You can easily change between the started client-server connections.

-  Connection list: Select a different client-server connection using the  icon.
-  Go to the preceding started client-server connection.
-  Go to the next started client-server connection.

7.3.4 Terminating a connection

Introduction

You can terminate a client-server connection as follows:

- Using the "Close" menu command (see below).
- For more options refer to "Special features".

Procedure

Proceed as follows to terminate an active client-server connection:

1. Touch the "Connection list" icon in the taskbar. A list of all started client-server connections opens.
2. Choose the "Close" menu command next to the connection.
3. If required, enter the connection password (see section "Password settings (Page 63)").

Note

Misuse

RDP can be set on the server so that the user stored in the connection settings remains logged in even after an RDP connection has been terminated.

Make sure that only authorized persons have access to the device or log off (see Special features).

Administrator password

You can also enter the administrator password instead of the connection password.

Special features

RDP

Note

Terminate the RDP connection alternatively by using "Start" > "Disconnect". The "RDP session has been terminated by peer!" dialog box will be displayed on the device; acknowledge it with "OK". The connection password is not requested.

You log off from the RDP server with "Start" > "Logoff".

SINUMERIK

The connection to the SINUMERIK system network is terminated. The network settings are reset to the values they had before the SINUMERIK connection was started.

See also

Starting a connection (Page 99)

7.4 Operating the on-screen keyboard

On-screen keyboard

If you have not connected an external keyboard to the device, use the on-screen keyboard for inputs, e.g., in the configuration settings.

The on-screen keyboard is opened automatically provided:

- You activate an entry field in the configuration dialogs of the Thin Client.
- You use the Sm@rtServer connection type and activate an entry field on the server.

Note

On-screen keyboard

A German-language on-screen keyboard and an English-language on-screen keyboard are available on the device. The keyboard language is set in the Start menu "Configuration > System".

Operating the on-screen keyboard

You operate the on-screen keyboard by directly touching the keys of the keyboard on the touch screen. The functions of the keys on the on-screen keyboard are basically the same as those on an external keyboard.



You can move the on-screen keyboard as shown below:

- In the desktop settings, you can position the on-screen keyboard at the top ① or bottom ④ edge of the screen.
- Depending on the position at the screen edge, the buttons ② and ③ on the right change:
- The button ② closes the on-screen keyboard.
- The button ③ moves the on-screen keyboard to the other edge of the screen (top or bottom).

Windows key

The "Win" key corresponds to the Windows key on a mechanical keyboard. You use this key to open the Windows Start menu.

Number pad

The on-screen keyboard has a separate number pad that you open with the "NUM" key. If you have connected an external keyboard, you cannot make any entries via the number pad of the external keyboard.

Latch function

If you keep the buttons <Ctrl>, <Alt>, <AltGr> and <WIN> pressed for some time, they are permanently enabled as though they are being pressed even after you have released them.

7.5 Operating a USB memory device

Introduction

Use the USB port on the back of the device to access connected USB storage devices.

RDP

In the case of an RDP connection you have read and write access to one or several USB storage devices.

With active RDP connection the USB storage devices are exported to the RDP server. A folder with the name "media on <Client hostname>" is created in Windows Explorer, in which a separate subfolder is displayed for each USB storage device. If you change the host name in the configuration settings of the device, the name of the folder is adapted automatically on the RDP server.

SINUMERIK

In case of a SINUMERIK connection you have read and write access to the folder structure of a single (the first) USB storage device through an HMI button. Additional information is available in the SINUMERIK manual "Operator components and networking" (6FC5397-1AP10-5AA0) (<http://www.automation.siemens.com/doconweb/>).

Requirement

- The "Connect USB device as drive" option is selected in the connection settings in "Settings > Configuration > Connections".
- SINUMERIK: The USB port is enabled in the HMI, see Chapter "Configuring a server", Section "SINUMERIK (Page 92)".

Procedure

1. Insert the USB memory device in the USB port on the device.
2. Choose "Settings > USB devices" in the taskbar. A media explorer opens.
3. Touch the "View details" icon in the menu bar.
4. Open the desired folder in the tree menu on the left. Its content is displayed in the window on the right.
5. You can cut, copy, paste, and delete files via the menu bar.
6. You use the navigation buttons to navigate back, up, and to the root directory of the USB drive.

Removing a USB memory device

To remove the USB memory device, proceed as follows:

1. Make sure the device is no longer being accessed.
2. Close the accessing application.
3. Close the media explorer via the connection list in the taskbar.
4. Wait for 5 to 10 seconds.
5. Remove the USB memory device from the USB port of the device.

See also

Connecting a USB device (Page 35)

Device maintenance and repair

8.1 Cleaning the device front

Introduction

The device is designed for low-maintenance operation. Nevertheless, you should clean the touch screen periodically.

Requirement

- Damp cleaning cloth
- Washing up liquid or foaming screen cleaning agent

Procedure

 WARNING
Unintentional response If you clean the touch screen while it is switched on, you could initiate operator controls by mistake. Switch off the device or - if running - clean the touch screen only when it is in the disabled state! Note that the touch screen disable automatically ends after 15 seconds.
Damage caused by unauthorized cleaning products Use of compressed air, steam jets, aggressive solvents, or scouring powder will damage the device. Do not clean the device with compressed air or steam jets. Do not use aggressive solvents or scouring powder.

Proceed as follows:

1. Switch off the device or disable the touch screen.
2. Spray the cleaning solution onto a cleaning cloth.
Do not spray directly onto the device.
3. Clean the device.

When cleaning the display wipe from the screen edge inwards.

8.2 Disabling the touch screen

Cleaning

You can clean the touch screen of the HMI device when it is switched on and a connection is active. To do this you must disable the touch screen.

 **WARNING**

Unintentional response

If you clean the touch screen while it is switched on, you could initiate operator controls by mistake.

Switch off the device or - if running - clean the touch screen only when it is in the disabled state! Note that the touch screen disable automatically ends after 15 seconds.

Procedure

To disable the touch screen, proceed as follows:

1. Choose "Clean screen" in the Start menu in the taskbar.
After 15 seconds the disable automatically ends.
2. Clean the touch screen.
3. If you want to continue cleaning, choose "Clean screen" again in the Start menu.

8.3 Calibrating the touch screen

If the position touched on the touch screen during operation no longer agrees with the position evaluated by the touch screen, the touch screen must be recalibrated.

Procedure

1. Choose "Calibrate" in the Start menu.
2. Start the calibration with the "Yes" button.
3. Touch the crosses displayed on the touch screen for several seconds, until the cross is moved. Several measurements are performed in each case and averaged.

A corresponding message appears when the calibration is finished.

If the touch screen cannot be operated on account of an error during calibration, the following options are available for restarting the calibration:

- Using an external mouse to open the calibration on the device
- Restore to factory settings

8.4 Spare parts and repairs

Repairs

In case of repair, the device must be shipped to the Return Center in Fürth. The address is:

Siemens AG
Industry Sector
Returns Center
Siemensstr. 2-4
90766 Fürth
Germany

For additional information, refer to the Internet at "Spare parts and repairs (<http://support.automation.siemens.com/WW/view/en/16611927>)".

Spare parts

Spare parts and accessories for the HMI device can be found in Chapter Accessories (Page 14).

Technical specifications

9.1 Certificates and approvals

Approvals

NOTICE
<p>Applicability</p> <p>The following overview shows possible approvals. The device itself is certified only as shown on the rear of the device.</p>

CE approval



The device meets the general and safety-related requirements of the EMC Directive (2004/108/EC "Electromagnetic Compatibility") and conforms to the harmonized European standards (EN) for programmable logic controllers published in the official gazettes of the European Union:

- 94/9/EU "Devices and protection systems for use as prescribed in potentially explosive areas" (Guidelines for Explosion Protection)
- **EC Declaration of Conformity**

The EC Declarations of Conformity are available to the relevant authorities at the following address:

Siemens Aktiengesellschaft
 Industry Sector
 I IA AS FA DH AMB
 PO Box 1963
 D-92209 Amberg, Germany

UL approval



Underwriters Laboratories Inc., to

- UL 508 (Industrial Control Equipment)
- CSA C22.2 No. 142 (Process Control Equipment)

or



Underwriters Laboratories Inc., to

- UL 508 (Industrial Control Equipment)
- CSA C22.2 No. 142 (Process Control Equipment)
- ANSI/ISA 12.12.01
- CSA-213 (Hazardous Location)

9.1 Certificates and approvals

Approved for use in

- Class I, Division 2, Group A, B, C, D or
- Class I, Zone 2, Group IIC or
- non-hazardous locations

FM Approval



Factory Mutual Research (FM) conforming to

- Approval Standard Class Number 3611, 3600, 3810
- ANSI/ISA 61010-1
- CSA C22.2 No. 213
- CSA C22.2 No. 1010.1

Approved for use in

- Class I, Division 2, Group A, B, C, D T4
- Class I, Zone 2, Group IIC T4

Ex approval

The following approvals apply to the device in accordance with

- EN 60079-0:2009
- EN 60079-15:2005
- EN 60079-31:2009

valid:

	II 3 G	Ex nA IIC Tx Gc
	II 3 D	Ex tc IIIC T 70 °C Dc IP65 x: Temperature values, see EC design examination certificate

The EC type examination certificates are available on the Internet at:

Technical Support (http://www.siemens.de/automation/csi_en_WW)

Marking for Australia



IEC 61131

The device meets the requirements of standard AS/NZS 2064 (Class A).

The device meets the requirements and criteria of IEC 61131-2, programmable logic controllers, part 2: Operating resource requirements and tests.

KOREA



This product meets the requirements of Korean certification.

This product satisfies the requirement of the Korean Certification (KC Mark).

이 기기는 업무용(A급) 전자파 적합기기로서 판매자 또는 사용자는 이 점을 주의하시기
바라며 가정 외의 지역에서 사용하는 것을 목적으로 합니다.

9.2 Directives and declarations

9.2.1 Electromagnetic compatibility

Introduction

The device fulfills the requirements of the EMC law of the single European market, among others.

EMC-compliant device installation

EMC-compliant installation of the device and the use of interference-proof cables provide the bases for trouble-free operation. The description "Guidelines for Interference-free Setup of PLCs" is also valid for the device installation.

Use in industry

The device is designed for industrial use, Limit Class A. The following standards are met for this:

- Requirements for emitted interference, EN 61000-6-4:2007
- Requirements for immunity to interference, DIN EN 61000-6-2:2005

Residential use

Note

Interference with radio / TV reception

The device is not suitable for use in residential areas.

If the device is used in a residential area, you must take measures to achieve Limit Class B conforming to EN 55016 for RF interference.

A suitable measure for achieving the required RF interference level for Limit Class B includes for example:

- Installation of the device in a grounded control cabinet
- Use of filters in electrical supply lines

Individual acceptance is required.

9.2.2 ESD guideline

What does ESD mean?

An electronic module is equipped with highly integrated components. Due to their design, electronic components are highly sensitive to overvoltage and thus to the discharge of static electricity. Such electronic components or modules are labeled as electrostatic sensitive devices.

The following abbreviations are commonly used for electrostatic sensitive devices:

- ESD – Electrostatic sensitive device
- ESD – Electrostatic Sensitive Device as a common international designation

Electrostatic sensitive devices can be labeled with an appropriate symbol.



NOTICE

Damage to ESD from touch

Electrostatic sensitive devices, ESD, can be destroyed by voltages which are far below the human perception limit. If you touch a component or electrical connections of a module without discharging any electrostatic energy, these voltages may arise.

The damage to a module by an overvoltage can often not be immediately detected and only becomes evident after an extended period of operation. The consequences are incalculable and range from unforeseeable malfunctions to a total failure of the machine or plant.

Avoid touching components directly. Make sure that persons, the workstation and the packaging are properly grounded.

Charge

Every person without a conductive connection to the electrical potential of his/her surroundings can be electrostatically charged.

The material with which this person comes into contact is of particular significance. The figure shows the maximum electrostatic voltages with which a person is charged, depending on humidity and material. These values conform to the specifications of IEC 61000-4-2.

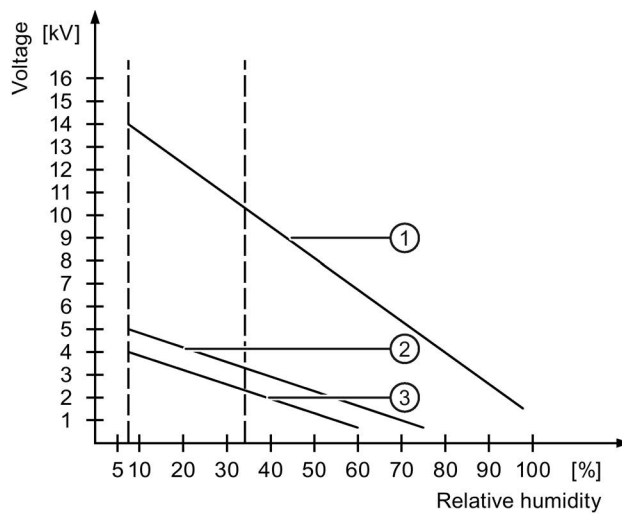

- ① Synthetic materials
- ② Wool
- ③ Antistatic materials such as wood or concrete

NOTICE

Grounding measures

There is no equipotential bonding without grounding. An electrostatic charge is not discharged and may damage the ESD.

Protect yourself against discharge of static electricity. When working with electrostatic sensitive devices, make sure that the person and the workplace are properly grounded.

Protective measures against discharge of static electricity

- Disconnect the power supply before you install or remove modules which are sensitive to ESD.
- Pay attention to good grounding:
 - When handling electrostatic sensitive devices, make sure that persons, the workstation and devices, tools and packaging used are properly grounded. In this manner, you avoid static discharge.
- Avoid direct contact:
 - As a general rule, do not touch electrostatic sensitive devices, except in the case of unavoidable maintenance work.
 - Hold the modules at their edge so that you do not touch the connector pins or conductor paths. In this way, the discharge energy does not reach and damage the sensitive components.
 - Discharge your body electrostatically before you take a measurement at a module. Do so by touching grounded metallic parts. Always use grounded measuring instruments.

9.3 Dimensional drawings

9.3.1 Dimensional drawings of ITC1200

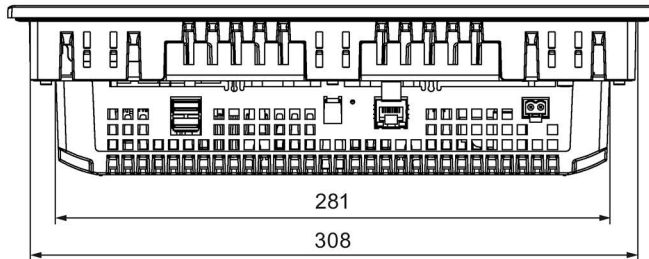

All dimensions in mm.

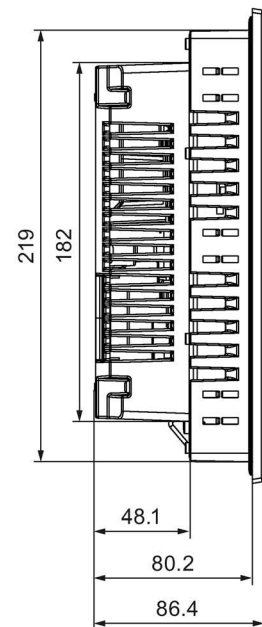
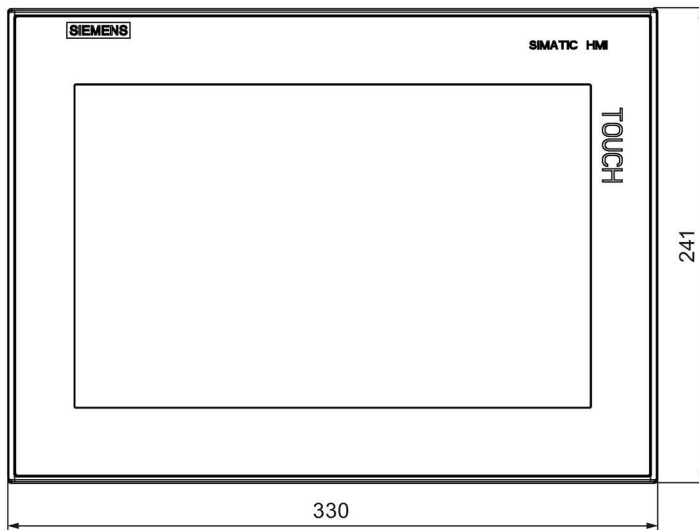

9.3.2 Dimensional drawings of ITC1500

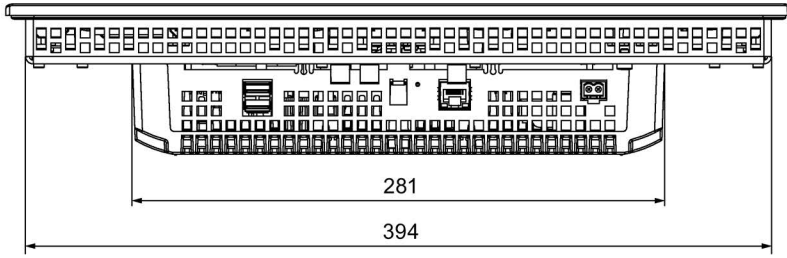

All dimensions in mm.

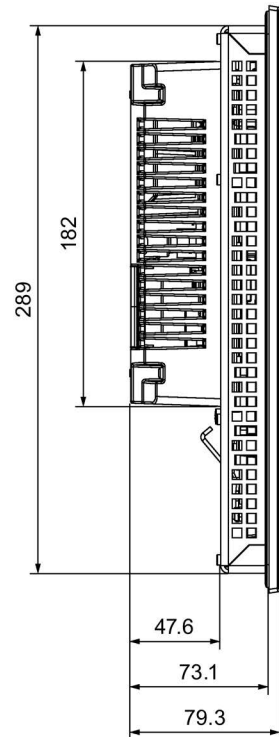
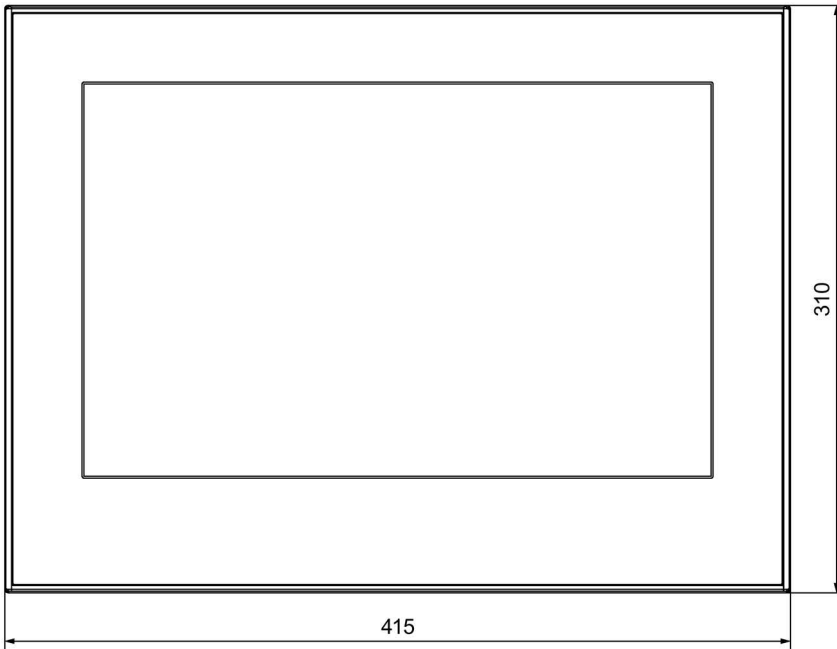

9.3.3 Dimensional drawings of ITC1900

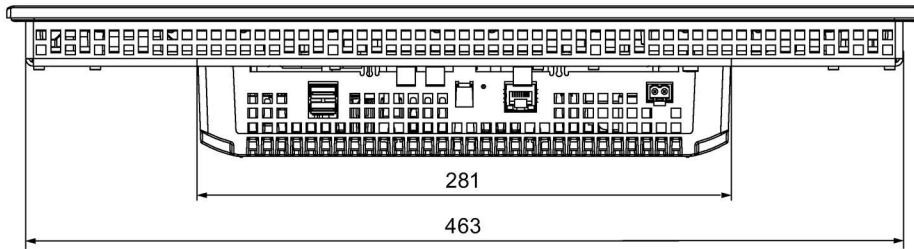

All dimensions in mm.

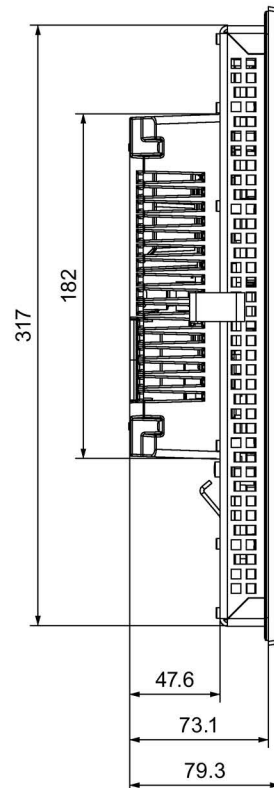

9.3.4 Dimensional drawings of ITC2200

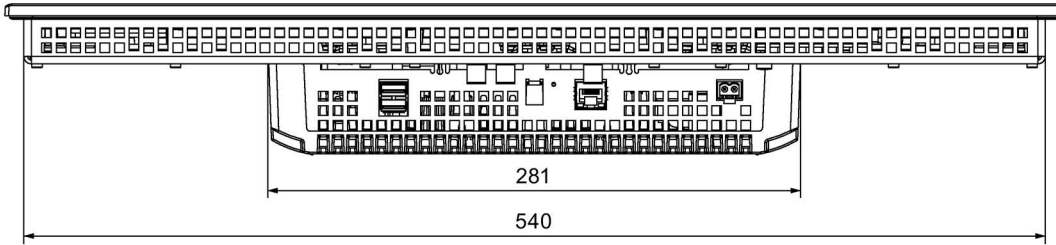

All dimensions in mm.

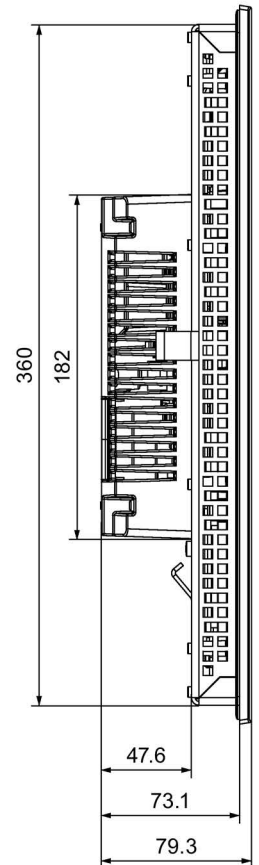
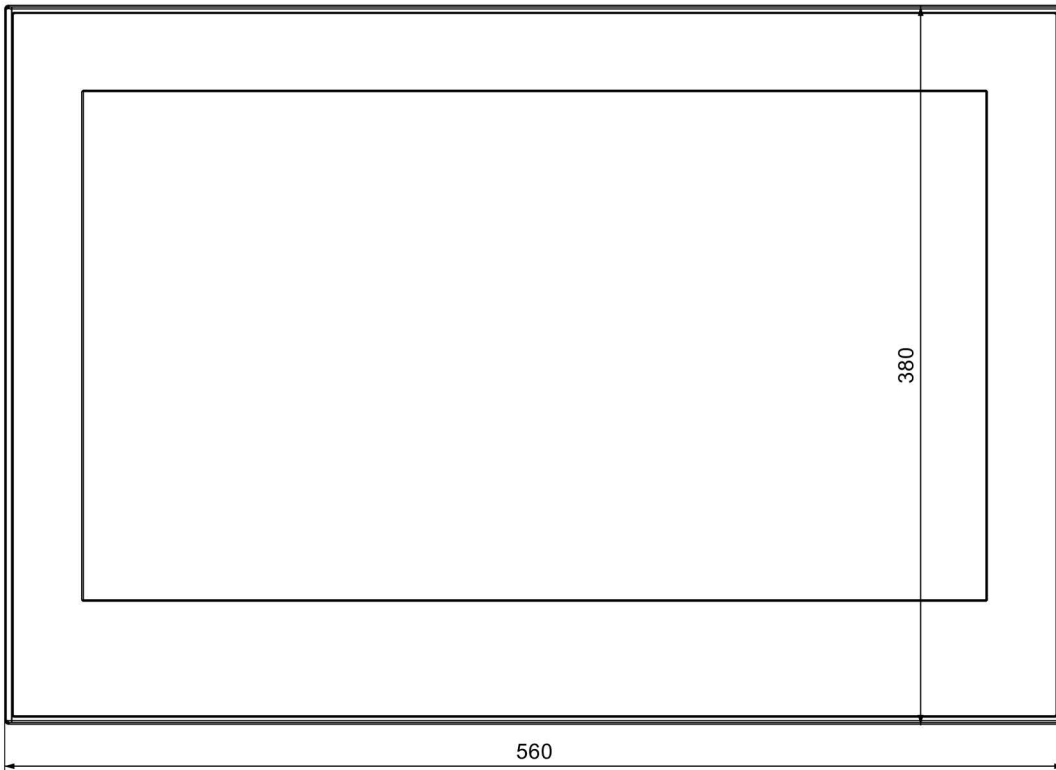

9.4 Technical specifications

9.4.1 General technical specifications

Weight

	HMI devices			
	ITC1200	ITC1500	ITC1900	ITC2200
Weight without packaging	3.4 kg	5.2 kg	6.5 kg	7.1 kg

Display

	HMI devices			
	ITC1200	ITC1500	ITC1900	ITC2200
Type	LCD TFT with extended viewing angle		LCD TFT	LCD TFT with extended viewing angle
Active display area	12.1" 261.1 x 163.2 mm	15.4" 331.2 x 207 mm	18.5" 409.8 x 230.4 mm	21.5" 495.6 x 292.2 mm
Resolution	1280 x 800 pixels		1366 x 768 pixels	1920 x 1080 pixels
Possible colors	Up to 16 million			
Brightness control	Yes, value range 1 to 100			
Backlighting	LED		LED	LED
Half Brightness Life Time (MTBF ¹)	80000 h		50000 h	30000 h
Pixel error class to ISO 9241-307	I			

¹ MTBF: Operating hours after which the maximum screen brightness is reduced by half compared to the original value. MTBF is increased by using the integrated dimming function, for example time-controlled via screen saver or centrally via PROFIenergy.

Input device

	HMI devices			
	ITC1200	ITC1500	ITC1900	ITC2200
Keyboard	Virtual on screen			
Touch screen (analog resistive)	Yes			
Function keys	No			
Labeling strips	No			

Memory

	HMI devices			
	ITC1200	ITC1500	ITC1900	ITC2200
Main memory	512 MB DDR3 SDRAM			
Memory	2 GB SSD			

Interfaces

	HMI devices			
	ITC1200	ITC1500	ITC1900	ITC2200
Ethernet (PROFINET basic functionality)	1 x RJ45 10/100/1000 Mbps			
USB 2.0	2 x Host ¹			

¹ USB type A, maximum load 500 mA, equivalent to USB standard 2.0

Power supply

	HMI devices			
	ITC1200	ITC1500	ITC1900	ITC2200
Rated voltage	24 V DC			
Permissible voltage range	+19.2 V to +28.8 V			
Rated current	1.2 A	1.5 A	1.3 A	2.2 A
Inrush current I ² t	0.5 A ² s			
Power	28.2 W	36 W	32 W	53 W
Maximum permissible transient	35 V (500 ms)			
Minimum time between two transients	50 s			
Internal protection	Electronic			

Miscellaneous

	HMI devices			
	ITC1200	ITC1500	ITC1900	ITC2200
Magnetic field intensity	50/60 Hz; 100 A/m RMS			

9.4.2 Performance data

Performance values

The performance depends on the network capacity in your system. With the SIMATIC WinCC Sm@rtServer option, the performance varies within the values specified in the WinCC documentation.

See also

FAQ 25576569 (<http://support.automation.siemens.com/WW/view/en/25576569>)

9.4.3 Ambient conditions

9.4.3.1 Transport and storage conditions

Mechanical and climatic conditions for transportation and storage

The requirements regarding transport and storage conditions for the device are more stringent than those laid down in IEC 61131-2. The following requirements apply to the transport and storage of the device in its original packaging.

The climatic conditions conform to the following standards:

- IEC 60721-3-2, Class 3K7 for storage
- IEC 60721-3-2, Class 2K4 for transport

The mechanical conditions correspond to IEC 61131-2.

Type of condition	Permitted range
Drop test (in transport package)	≤ 1 m
Temperature	From -20 to +60° C
Atmospheric pressure	From 1080 to 660 hPa, Corresponds to an elevation of -1 000 to 3 500 m
Relative humidity	From 10 to 90%, without condensation
Sinusoidal vibration in accordance with IEC 60068-2-6	5 to 8.4 Hz: 3.5 mm 8.4 to 500 Hz: 9.8 m/s ²
Shock in accordance with IEC 60068-2-29	250 m/s ² , 6 ms, 1000 shocks

Note

Avoid dewing

If the HMI device is subjected to low temperatures or extreme fluctuations in temperature during transportation, moisture could occur on or inside the HMI device. Dewing can occur. This can cause malfunctions.

The device must be brought to room temperature before it is commissioned. Do not expose it to direct heat radiation from a heating device. If there is condensation, wait approximately 4 hours until the device has dried completely before switching it on.

Proper transport and storage, installation and assembly as well as careful operation and maintenance are prerequisites for trouble-free and safe operation of the device.

Non-compliance shall result in the voiding of the device warranty.

9.4.3.2 Operating conditions

Mechanical and climatic conditions of use

The HMI device is intended for use in locations protected from the effects of the weather. The conditions of use meet the requirements for DIN IEC 60721-3-3:

- Class 3M3 (mechanical requirements)
- Class 3K3 (climatic requirements)

Use with additional measures

The device should not be used at the following locations unless additional measures are taken:

- In locations with a high degree of ionizing radiation
- In locations with severe operating conditions, for example, due to:
 - Corrosive vapors, gases, oils or chemicals
 - Electrical or magnetic fields of high intensity
- In plants that require special monitoring - for example:
 - Elevators
 - Systems in especially hazardous rooms

Mechanical ambient conditions

The mechanical ambient conditions for the device are specified in the following table in terms of sinusoidal vibration.

Frequency range f in Hz	Constant	Occasional
$5 \text{ Hz} \leq f \leq 8.4 \text{ Hz}$	Amplitude 0.0375 mm	Amplitude 0.075 mm
$8.4 \text{ Hz} \leq f \leq 150 \text{ Hz}$	Constant acceleration 0.5 g	Constant acceleration 1 g

Reducing vibrations

If the device is subjected to greater shocks or vibrations, you must take appropriate measures to reduce acceleration or amplitudes.

We recommend mounting the device on damping materials, such as rubber-metal vibration dampers.

Testing mechanical ambient conditions

The following table provides information on the type and scope of tests for mechanical ambient conditions.

Tested for	Test standard	Comments
Vibrations	Vibration test in accordance with IEC 60068, part 2-6 (sinusoidal)	Type of vibration: Frequency cycles at a rate of change of 1 octave/minute. 5 Hz ≤ f ≤ 8.4 Hz, constant amplitude 0.075 mm 8.4 Hz ≤ f ≤ 150 Hz, constant acceleration 1 g ¹
		Vibration duration: 10 frequency cycles per axis in each of the three mutually vertical axes
Shock	Shock test in accordance with IEC 60068, Part 2 -27	Type of shock: Half-sine
		Severity of shock: Peak value 15 g, duration 11 ms
		Direction of shock: 3 shocks in ± direction of axis in each of the three axes vertical to each other

Climatic ambient conditions

The following table shows the climatic ambient conditions for operation of the device.

Ambient conditions	Permitted range	Comments
Temperature:		
Vertical mounting	From 0 to 50 °C (horizontal) ¹	
Mounting at an angle	From 0 to 40 °C (horizontal)	Slope angle max. 35°
Relative humidity	10 to 90%, without condensation	
Atmospheric pressure	1 080 to 795 hPa	Corresponds to an elevation of -1000 m to 2000 m
Pollutant concentration	SO ₂ : < 0.5 vpm; Relative humidity < 60%, no condensation	Test: 10 cm ³ /m ³ ; 10 days
	H ₂ S: < 0.1 vpm; Relative humidity < 60%, no condensation	Test: 1 cm ³ /m ³ ; 10 days

¹ ITC1900 and ITC2200: From 0 to 45° C

Pulse-shaped interference

The following table shows the electromagnetic compatibility of modules with regard to pulse-shaped interference. This requires the device to meet the specifications and directives for electrical installation.

Pulse-shaped interference	Test voltage	Degree of severity
Electrostatic discharge in accordance with IEC 61000-4-2	Air discharge: 8 kV Contact discharge: 6 kV	3
Bursts (high-speed transient interference) in accordance with IEC 61000-4-4	2 kV power supply cable 2 kV signal cable, > 30 m 1 kV signal cable, < 30 m	3
High-power surge pulses in accordance with IEC 61000-4-5, external protective circuit required (refer to S7-300 PLC, Installation, chapter "Lightning and overvoltage protection").		
Asymmetrical coupling	2 kV power cable DC voltage with protective elements 2 kV signal/data cable, > 30 m, with protective elements as required	3
Symmetrical coupling	1 kV power cable DC voltage with protective elements 1 kV signal cable, > 30 m, with protective elements as required	3

Sinusoidal interference

The following table shows the EMC behavior of the modules with respect to sinusoidal interference. This requires the HMI device to meet the specifications and directives for electrical installation.

Sinusoidal interference	Test values	Degree of severity
HF radiation (electromagnetic fields) according to IEC 61000-4-3	<ul style="list-style-type: none"> • 80% amplitude modulation at 1 kHz with 10 V/m in the range of 80 MHz to 1 GHz with 3 V/m in the range 1.4 GHz to 2 GHz with 1 V/m the range 2 GHz to 2.7 GHz • 10 V/m with 50% pulse modulation at 900 MHz 10 V/m with 50% pulse modulation at 1.89 GHz 	3
HF power applied to lines and line shields according IEC 61000-4-6	Test voltage 10 V, with 80% amplitude modulation of 1 kHz in the 9 MHz to 80 MHz range	3

Emission of radio interference

The following table shows the unwanted emissions from electromagnetic fields in accordance with EN 55016, Limit Value Class A, Group 1, measured at a distance of 10 m.

From 30 to 230 MHz	< 40 dB (µV/m) quasi-peak
From 230 to 1000 MHz	< 47 dB (µV/m) quasi-peak

Additional measures

Before you connect a device to the public network, ensure that it is compliant with Limit Class B in accordance with EN 55022.

9.4.3.3 Information on insulation tests, protection class and degree of protection

Test voltages

Insulation strength is demonstrated in the type test with the following test voltages in accordance with IEC 61131-2:

Circuits with a nominal voltage of U_n to other circuits or ground	Test voltage
24 V	520 V DC or 370 V AC For Ethernet connector: 1500 V AC

Protection class

Protection Class I in accordance with IEC 61140, i.e. PE/ground terminal to profile rail required!

Protection against foreign objects and water

Degree of protection in accordance with IEC 60529	Explanation
Front	When mounted: <ul style="list-style-type: none"> • IP65 • Front face only Type 4X/Type 12 (indoor use only)
Rear panel	IP20 Touch protection test with standard test probes. There is no protection against ingress by water.

The front protection rating can only be guaranteed if the mounting seal lies flush against the mounting cut-out.

9.5 Description of the ports

9.5.1 Power supply

Plug connector, 2-pin



The following table shows the pin assignment of the power supply.

Pin	Assignment
1	+24 VDC
2	GND 24 V

9.5.2 USB

USB socket

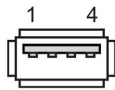

The following table shows the pin assignment of the USB port.

Pin	Assignment
1	+5 VDC, out, max. 500 mA
2	USB-DN
3	USB-DP
4	GND

9.5.3 PROFINET (LAN) 10/100/1000 Mb

Models of 15" and more have this interface. Name of interface on HMI device: X3

RJ45 plug connector

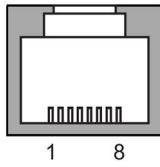

Pin	Assignment
1	D1+
2	D1-
3	D2+
4	D3+
5	D3-
6	D2-
7	D4+
8	D4-

Technical Support

A.1 Service and support

You can find additional information and support for the products described on the Internet at the following addresses:

- Technical support (http://www.siemens.de/automation/csi_en_WW)
- Support request form (<http://www.siemens.com/automation/support-request>)
- After-sales information system for SIMATIC PC / PG (<http://www.siemens.com/asis>)
- SIMATIC Documentation Collection (<http://www.siemens.com/simatic-tech-doku-portal>)
- Your local representative
(<http://www.automation.siemens.com/mcms/aspa-db/en/Pages/default.aspx>)
- Training center (<http://sitrain.automation.siemens.com/sitrainworld/?AppLang=en>)
- Industry Mall (<http://mall.automation.siemens.com>)

When contacting your local representative or Technical Support, please have the following information at hand:

- Order number of the device (MLFB)
- BIOS version (industry PC) or image version (HMI device)
- Installed additional hardware
- Installed additional software

Tools & downloads

Please check regularly if updates and hotfixes are available for download to your device. The downloads are available on the Internet under "After Sales Information System SIMATIC PC/PG" (see above).

Abbreviations

CAL	Client Access License (Windows Server)
DC	Direct Current
DHCP	Dynamic Host Configuration Protocol
DNS	Domain Name System
DP	Distributed I/O
ESD	Components and modules endangered by electrostatic discharge
EMC	Electromagnetic Compatibility
EN	European standard
ESD	Components and modules endangered by electrostatic discharge
GND	Ground
HF	High Frequency
HMI	Human Machine Interface
HTTP	Hypertext Transfer Protocol
IEC	International Electronic Commission
IP	Internet Protocol
MAC	Media Access Control
MPI	Multipoint Interface (SIMATIC S7)
MS	Microsoft
MSDN	Microsoft Developer Network
OP	Operator Panel
PC	Personal Computer
PPI	Point-to-Point Interface (SIMATIC S7)
PELV	Protective Extra Low Voltage
PN	PROFINET
RDP	Remote Desktop Protocol
RJ45	Registered Jack Type 45
TFT	Thin Film Transistor
TP	Touch Panel
TS-CAL	Terminal Server Client Access License (Windows Server)
UL	Underwriter's Laboratory
USB	Universal Serial Bus
VNC	Virtual Network Computing

Glossary

Browser

A browser is a computer program that is used to start Web sites in the Internet.

Client-server system

A client/server system is a network structure in which the resources are offered by a central server that the workstations (clients) can access.

Degree of protection

The degree of protection specifies the suitability of electronic equipment for a variety of ambient conditions – and the protection of persons against potential danger when using this equipment.

The degree of protection specified by IP differs from the protection class. But both involve protection against touching dangerous electric voltage. The degree of protection also classifies the protection of equipment against dirt and moisture.

Domain Name System (DNS)

The DNS is a service in the Internet that converts domain names into IP addresses.

Dynamic Host Configuration Protocol (DHCP)

DHCP enables dynamic assignment of an IP address and additional configuration parameters to computers in a network, via an appropriate server.

Electromagnetic Compatibility (EMC)

Electromagnetic compatibility (EMC) refers to a usually desirable state, in which technical equipment does not disturb one another with unwanted electrical or electromagnetic effects. Electromagnetic compatibility deals with technical and regulatory questions of undesired, mutual influence in electrical engineering.

EMC

Electromagnetic compatibility is the ability of electrical equipment to function properly in its electromagnetic environment without influencing this environment.

Ethernet

Ethernet is a fixed-cable data network technology for local area networks (LANs). Ethernet enables data transfer in the form of data frames between all devices that are connected in a local area network, for example, computers, printers.

HMI device

An HMI device is a device used for the operation and monitoring of machines and plants. The statuses of the machine or plant are indicated by means of graphic elements or by indicator lamps on the HMI device. The operator controls of the HMI device allow the operator to interact with the processes of the machine or plant.

Plant

General term referring to machines, processing centers, systems, plants and processes which are operated and monitored on an HMI device.

PLC

A PLC is a general term for devices and systems with which the HMI device communicates, for example, SIMATIC S7.

Process visualization

Visualization of technical processes by means of text and graphic elements. Configured plant screens allow operator intervention in active plant processes by means of the input and output data.

PROFINET

PROFINET is a standard for an industrial Ethernet in automation systems.

Project

Result of a configuration using a configuration software. The project normally contains several screens with embedded system-specific objects, basic settings and alarms. The project is transferred to an HMI device and monitored and operated with the HMI device.

Protection class

The protection class is used in electrical engineering to classify and identify electrical equipment in relation to existing safety measures designed to prevent electric shock. There are four protection classes for electrical equipment.

Remote Desktop Protocol (RDP)

RDP enables network access to applications that are executed on a Windows Terminal Server. In this process the RDP regulates transmission of screen content and keyboard and mouse inputs over the network.

Screen

Form of the visualization of all logically related process data for a plant. The visualization of the process data can be supported by graphic objects.

Sm@rtAccess/Sm@rtServer

The Sm@rtAccess option from SIMATIC WinCC flexible 2008 and the Sm@rtServer option from SIMATIC WinCC V11 (TIA Portal) enables communication between HMI systems based on Ethernet networks or via the Intranet/Internet. This enables an HMI device to be monitored and remotely controlled by another HMI device.

Virtual Network Computing (VNC)

VNC enables network access to applications that are executed on a remote computer regardless of the platform. In this process the VNC controls transmission of screen content and keyboard and mouse inputs over the network.

Index

A

- Abbreviation, 129
- Administrator, 3, 63, 64
- Administrator password, 44
- Ambient conditions
 - Climatic, 122
 - Mechanical, 121
 - Test, 122
- Application, 14
 - RDP, 15
 - SINUMERIK, 16
 - Sm@rtServer, 14
 - VNC, 16
 - Web, 16
- Application case
 - WinCC OA, 17
- Applications, 69, 69
- Approval for Australia, 110
- Approvals, 109
- Auto-hide the taskbar, 67
- Automatic connection establishment, 38

B

- Background image, 68
- Basic knowledge
 - Required, 3
- Bottom view, 12

C

- Cable
 - Connecting, 30
- Care, 105
- CE approval, 109
- Certificates, 109
- Citrix, 87
- Cleaning, 106, 106
 - Touch screen, 106
- Cleaning product, 105
- Client, 14
 - Application, 14
- Climatic
 - Storage conditions, 120
 - Transport conditions, 120

- Commissioning engineers, 3
- Components sensitive to electrostatic charge, 112
- Computer, (see PC)
- Conductor cross-section, 33
 - Equipotential bonding, 31
- Configuration
 - Server, 86, 86
- Configuration file, 49, 49, 75
 - Loading, 49, 75
 - Saving, 49, 75
- Configuration graphic
 - Power supply, 33
 - PROFINET, 34
- Configuration settings, 40, 44, 45
 - Desktop, 66
 - Multiple access, 41, 41
 - Opening, 41
 - Read access, 42, 44
 - Remote access, 55
 - Write access, 44
- Connecting
 - Cable, 30
 - Equipotential bonding, 31
 - Mains terminal, 33
 - Power supply, 33
 - PROFINET, 34
 - USB device, 35
- Connection, 54
 - Specifying mode, 54
 - Specifying speed, 54
- Connection password, 65
- Connection sequence, 30
- Conventions, 4

D

- Degree of protection, 26
 - Protection against ingress of solid foreign bodies, 124
 - Protection against water, 124
- Desktop
 - Configuration settings, 66
- Device
 - Mounting, 29
 - Switching off, 37
 - Switching on, 37
 - Testing, 37
- Device data, 45

- Device settings, 40
- Dewing, 121
- Disabling, 106
 - Touch screen, 106
- Display
 - HMI devices, 118
- Displaying device data, 45
- Disposal, 4
- Disturbance
 - Pulse-shaped, 123
 - Sinusoidal, 123
- Documentation
 - Enclosed, 24

E

- EC Declaration of Conformity, 109
- Electrical
 - Safe separation, 34
- Electrical potential difference, 31
- Emission, 111, 124
- Equipotential bonding
 - Cable, 32
 - Connecting, 31
 - Requirements, 31
 - Wiring diagram, 32
- Equipotential bonding rail, 32
- ESD, 112
- ESD guidelines, 112
- Establishing the connection, 38
- Expert mode
 - SSH configuration service, 81

F

- Factory settings, 50
- FM Approval, 110
- Front view, 12
- Function test, 37

G

- Guidelines
 - ESD guidelines, 112
- Guidelines for Explosion Protection, 110

H

- Hide the taskbar, 67

- HMI device
 - EMC-compliant installation, 111
 - Interface, 13
 - Operator controls, 96
 - Possible applications, 9
 - Starting, brief instructions, 23
 - Technical specifications, 118
- HMI devices
 - Input device, 118
 - Interfaces, 119
 - Memory, 119
- HMI devices
 - Display, 118
 - Weight, 118

I

- Input device
 - HMI devices, 118
- Insulation test
 - Test voltage, 124
- Interface, 13
- Interfaces
 - HMI devices, 119
- IT Security, 20

K

- Keyboard language, 86
 - External keyboard, 92
 - SINUMERIK, 92
 - Windows XP Professional, 86

L

- Labeling
 - Approvals, 109
 - EC Declaration of Conformity, 109
 - Guidelines for Explosion Protection, 110
- Layout, 12
 - Bottom view, 12
 - Front view, 12
 - In the web browser, 70
 - Rear view, 13
 - Side view, 12

M

- Mains terminal
 - Connecting, 33

Maintenance, 105
 Maintenance personnel, 3
 Mechanical
 Storage conditions, 120
 Transport conditions, 120
 Memory
 HMI devices, 119
 Monitoring mode, 96
 Mounting
 Device, 29
 EMC-compliant, 111
 Mounting clamp
 Mounting, 28, 28
 Mounting cutout
 Compatibility to other HMI devices, 27
 Dimensions, 27
 Preparing, 27
 Mounting location, 23
 Mounting position, 25
 Multiple touch, 95

N

Network settings, 51
 Non-isolated plant configuration, 34

O

On-screen keyboard, 102
 Operating instructions
 Purpose of, 3
 Scope, 4
 Operating right, 96
 Operator controls, 96
 Operators, 3

P

Password, 44, 64
 Changing the administrator password, 64
 Connection password, 65
 Forgetting the administrator password, 64
 PELV, 34
 Peripherals
 Rated load, 35
 Permissible mounting position, 25
 Pin assignment
 Power supply, 125
 USB socket, 125
 Plant configuration
 Non-isolated, 34

Possible applications, 39
 HMI device, 9
 Power supply
 Configuration graphic, 33
 Connecting, 33
 HMI devices, 119
 Pin assignment, 125
 PROFINET
 Configuration graphic, 34
 Connecting, 34
 PROFINET basic functions, 62
 Protection class, 124
 Protective film, 14
 Protective measure
 Static electricity, 113

R

Radiation, 20
 High frequency radiation, 20
 Radio interference, 111
 Emission, 124
 Rated load
 Interface, 35
 RDP, 85
 Application, 15
 Configuration settings, 58
 Interrupting the connection, 38
 Licensing, 85
 Restoring the connection, 38
 Rear view, 13
 Reconnect, 38
 Standard Reconnect, 38
 Recycling, 4
 Registered trademarks, 4, 4
 Remote access, 55
 Repairs, 107
 Restoring, 50
 Factory settings, 50
 Return Center, 107
 Reverse polarity protection, 33

S

Safe electrical isolation, 34
 Safety
 Certificates, 109
 Standards, 109
 Safety instruction, 35
 Connection sequence, 30
 Equipotential bonding cable, 32

- General, 111
- Malfunction, 35
- Mounting at an angle, 25
- Multiple touch, 95
- Preventing inadvertent operation, 105
- Rated load, 35
- Storage, 121
- Touch screen, 97
- Transport, 121
- Unintentional response, 105
- USB port, 35
- Saving, 49, 75
 - Configuration file, 49, 75
- Screen settings, 47
- Security information, 20
- Server, 14
 - Configuration, 14, 86, 86
 - Interrupting the connection, 38
 - Restoring the connection, 38
- Service packages, 14
- Settings
 - Web browser, 69
- Settings, 40, 45
 - Changing the administrator password, 64
 - Check valid settings, 54
 - Displaying device data, 45
 - Editing configuration settings, 63, 64
 - Loading the configuration file, 49, 75
 - Loss of configuration settings, 64
 - Network settings, 51
 - RDP, 58
 - Saving the configuration file, 49, 75
 - Setting up screen, 47
 - Specify network parameters, 52
 - Specifying connection mode, 54
 - Specifying connection speed, 54
 - Specifying device name, 47
 - System settings, 46
 - Update firmware, 48
 - Use DNS server, 53
- Settings
 - Web settings, 69
- Settings
 - Application settings, 69
- Settings
 - Saving the configuration file, 49, 75
- Settings
 - Loading the configuration file, 49, 75
- Show the taskbar, 67
- Side view, 12
- SINUMERIK
 - Application, 16

- Sm@rtAccess
 - Interrupting the connection, 38
 - Licensing, 91
 - Restoring the connection, 38
- Sm@rtServer, 91
 - Application, 14
 - possible HMI devices, 91
- Spare part
 - Mains terminal, 14
- Spare parts, 107
- Specify network parameters, 52
- SSH configuration service, 81
- Standards, 109
- Starting
 - HMI device, brief instructions, 23
- Static electricity
 - Protective measures, 113
- Storage conditions, 120
- Strain relief, 35
- Switching off
 - Device, 37
- Switching on
 - Device, 37
- System settings, 46, 47

T

- Taskbar, 97
 - Maximize, 97
 - Minimize, 97
 - Move, 97
 - Show the taskbar, 97
- Technical specifications
 - Display, 118
 - HMI devices, 118
 - Input device, 118
 - Interfaces, 119
 - Memory, 119
 - Power supply, 119, 125
- Test
 - For ambient conditions, 122
- Testing
 - Device, 37
- Touch screen, 106
 - Cleaning, 106
 - Disabling, 106
 - Safety instruction, 97
- Transport conditions, 120
- Transport damage, 24

U

- UL approval, 109
- Unintentional action, 95
- Update firmware, 48
- USB device
 - Connecting, 35
- USB socket
 - Pin assignment, 125
- Use
 - Conditions, 121
 - In industry, 111
 - In residential areas, 111
 - With additional measures, 121
- Use DNS server, 53

V

- View, (See layout)
- VNC, 90
 - Application, 16

W

- Web
 - Application, 16
- Web browser, 69
 - Layout, 70
- Weight
 - HMI devices, 118
- WinCC OA, 93
 - Application case, 17
- Windows Server, 85
 - Licensing, 85
- Wiring diagram
 - Equipotential bonding, 32

