





## Notice:

OMRON products are manufactured for use according to proper procedures by a qualified operator and only for the purposes described in this manual.

The following conventions are used to indicate and classify warnings in this manual. Always heed the information provided with them.

 **DANGER!** Indicates information that, if not heeded, is likely to result in loss of life or serious injury.

 **WARNING** Indicates information that, if not heeded, could possibly result in loss of life or serious injury.

 **Caution** Indicates information that, if not heeded, could result in relatively serious or minor injury, damage to the product, or faulty operation.

## OMRON Product References

All OMRON products are capitalized in this manual. The word “Unit” is also capitalized when it refers to an OMRON product, regardless of whether or not it appears in the proper name of the product.

The abbreviation “Ch,” which appears in some displays and on some OMRON products, means “word” and is abbreviated “Wd” in documentation.

The abbreviation “PC” means Programmable Controller and is not used as an abbreviation for anything else.

## Visual Aids

The following headings appear in the left column of the manual to help you locate different types of information.

**Note** Indicates information of particular interest for efficient and convenient operation of the product.

**1, 2, 3...** Indicates lists of one sort or another, such as procedures, precautions, etc.

## © OMRON, 1990

All rights reserved. No part of this publication may be reproduced, stored in a retrieval system, or transmitted, in any form, or by any means, mechanical, electronic, photocopying, recording, or otherwise, without the prior written permission of OMRON.

No patent liability is assumed with respect to the use of the information contained herein. Moreover, because OMRON is constantly striving to improve its high-quality products, the information contained in this manual is subject to change without notice. Every precaution has been taken in the preparation of this manual. Nevertheless, OMRON assumes no responsibility for errors or omissions. Neither is any liability assumed for damages resulting from the use of the information contained in this publication.

# TABLE OF CONTENTS

<b>PRECAUTIONS</b> .....	<b>xi</b>
1 Intended Audience .....	xii
2 General Precautions .....	xii
3 Safety Precautions .....	xii
4 Operating Environment Precautions .....	xii
5 Application Precautions .....	xiii
<b>SECTION 1</b>	
<b>Introduction</b> .....	<b>1</b>
1-1 What is a Control System? .....	2
1-2 The Role of the PC .....	2
1-3 How Does a PC Work? .....	3
<b>SECTION 2</b>	
<b>Description of All Components</b> .....	<b>7</b>
2-1 CPU .....	8
2-2 Expansion I/O Unit .....	13
2-3 Memory .....	14
2-4 Memory Installation .....	16
2-5 System Configuration .....	19
<b>SECTION 3</b>	
<b>RS-232C Interface</b> .....	<b>21</b>
3-1 Host Link Mode .....	22
3-2 Application Program Read/Write Mode .....	25
3-3 ASCII I/O Mode .....	25
<b>SECTION 4</b>	
<b>System Memory Allocation</b> .....	<b>27</b>
4-1 DM Word Allocation .....	28
4-2 System Settings Area .....	28
4-3 System Registration Area .....	28
4-4 System Commands .....	30
4-5 System Settings/Registration Area Bit Allocation .....	33
4-6 Error History .....	39
4-7 User Program Header .....	42
<b>SECTION 5</b>	
<b>Installation Environment</b> .....	<b>45</b>
5-1 Ambient Conditions .....	46
5-2 Cooling .....	46
5-3 Mounting Requirements .....	46
5-4 DIN Rail Mounting .....	49
5-5 Duct Work .....	51
5-6 Preventing Noise .....	52
<b>SECTION 6</b>	
<b>Wiring</b> .....	<b>53</b>
6-1 Emergency Stop Circuit .....	54
6-2 Power Failure .....	54
6-3 I/O Connections .....	55
6-4 Wiring the Power Supply .....	56

# TABLE OF CONTENTS

6-5	Grounding .....	57
6-6	I/O Wiring .....	57
<b>SECTION 7</b>		
<b>Safety Considerations .....</b>		<b>61</b>
7-1	Special Wiring Precautions .....	62
7-2	Input Wiring .....	64
7-3	Output Wiring .....	64
7-4	Wiring Examples .....	68
<b>Appendix</b>		
A	Standard Models .....	71
B	Specifications .....	77
C	Inspection and Maintenance .....	83
D	Test Run Procedures .....	87
<b>Glossary .....</b>		<b>91</b>
<b>Index .....</b>		<b>97</b>
<b>Revision History .....</b>		<b>99</b>

## ***About this Manual:***

This manual explains how to install Mini H-type Programmable Controllers. Mini H-type PCs include the C20H, C28H, C40H, and C60H PCs.

**Section 8** is an introduction to Programmable Controllers. General information about what a Programmable Controller can do and how a Programmable Controller works is provided.

**Section 9** provides a description of all the components of the C20H/C28H/C40H/C60H.

**Section 10** illustrates the three modes of the RS-232C Interface.

**Section 11** provides detailed information about the memory allocated as system memory.

**Section 12** contains the requirements for the installation environment.

**Section 13** explains the wiring of power supplies, grounding and I/O connections.

**Section 14** lists safety considerations that should be kept in mind while installing the C20H/C28H/C40H/C60H.

**Appendixes**, a **Glossary**, and an **Index** are also included.



### **Caution**

Static electricity can cause damage to PC components. Your body can carry an electrostatic charge, especially when the humidity is low. Before touching the PC be sure to first touch a grounded metallic object, such as a water pipe, in order to discharge any static build up.

# PRECAUTIONS

This section provides general precautions for using the Programmable Controller (PC) and related devices.

**The information contained in this section is important for the safe and reliable application of the PC. You must read this section and understand the information contained before attempting to set up or operate a PC system.**

1 Intended Audience .....	xii
2 General Precautions .....	xii
3 Safety Precautions .....	xii
4 Operating Environment Precautions .....	xii
5 Application Precautions .....	xiii

## 1 Intended Audience

This manual is intended for the following personnel, who must also have knowledge of electrical systems (an electrical engineer or the equivalent).

- Personnel in charge of installing FA systems.
- Personnel in charge of designing FA systems.
- Personnel in charge of managing FA systems and facilities.

## 2 General Precautions

The user must operate the product according to the performance specifications described in the operation manuals.

Before using the product under conditions which are not described in the manual or applying the product to nuclear control systems, railroad systems, aviation systems, vehicles, combustion systems, medical equipment, amusement machines, safety equipment, and other systems, machines, and equipment that may have a serious influence on lives and property if used improperly, consult your OMRON representative.

Make sure that the ratings and performance characteristics of the product are sufficient for the systems, machines, and equipment, and be sure to provide the systems, machines, and equipment with double safety mechanisms.

This manual provides information for programming and operating OMRON PCs. Be sure to read this manual before attempting to use the software and keep this manual close at hand for reference during operation.

 **WARNING** It is extremely important that the PC be used for the specified purpose and under the specified conditions, especially in applications that can directly or indirectly affect human life. You must consult with your OMRON representative before applying a PC System to the abovementioned applications.

## 3 Safety Precautions

 **WARNING** Never attempt to disassemble the PC while power is being supplied. Doing so may result in serious electrical shock or electrocution.

 **WARNING** Never touch any of the terminals while power is being supplied. Doing so may result in serious electrical shock or electrocution.

## 4 Operating Environment Precautions

Do not operate the control system in the following places.

- Where the PC is exposed to direct sunlight.
- Where the ambient temperature is below 0°C or over 55°C.
- Where the PC may be affected by condensation due to radical temperature changes.
- Where the ambient humidity is below 10% or over 90%.
- Where there is any corrosive or inflammable gas.
- Where there is excessive dust, saline air, or metal powder.
- Where the PC is affected by vibration or shock.
- Where any water, oil, or chemical may splash on the PC.

 **Caution** The operating environment of the PC System can have a large effect on the longevity and reliability of the system. Improper operating environments can lead to malfunction, failure, and other unforeseeable problems with the PC System. Be sure that the operating environment is within the specified conditions at installation and remains within the specified conditions during the life of the system.

## 5 Application Precautions

Observe the following precautions when using the PC.

 **WARNING** Failure to abide by the following precautions could lead to serious or possibly fatal injury. Always heed these precautions.

- Always ground the system to 100  $\Omega$  or less when installing the system to protect against electrical shock.
- Always turn off the power supply to the PC before attempting any of the following. Performing any of the following with the power supply turned on may lead to electrical shock:
  - Assembling any devices or racks.
  - Connecting or disconnecting any cables or wiring.

 **Caution** Failure to abide by the following precautions could lead to faulty operation or the PC or the system or could damage the PC. Always heed these precautions.

- Use the PC only with the power supplies and voltages specified in the operation manuals. Other power supplies and voltages may damage the PC.
- Take measures to stabilize the power supply to conform to the rated supply if it is not stable.
- Provide circuit breakers and other safety measures to provide protection against shorts in external wiring.
- Do not apply voltages exceeding the rated input voltage to the input section. The input section may be destroyed.
- Do not apply voltages exceeding the maximum switching capacity to the output section. The output section may be destroyed.
- Always disconnect the LG terminal when performing withstand voltage tests.
- Install the PC according to instructions in the operation manuals. Improper installation may cause faulty operation.
- Provide proper shielding when installing in the following locations:
  - Locations subject to static electricity or other sources of noise.
  - Locations subject to strong electromagnetic fields.
  - Locations subject to possible exposure to radiation.
  - Locations near to power supply lines.
- Be sure to tighten Backplane screws, terminal screws, and cable connector screws securely.
- Do not attempt to take the PC apart, to repair the PC, or to modify the PC in any way.

 **Caution** The following precautions are necessary to ensure the general safety of the system. Always heed these precautions.

- Provide double safety mechanisms to handle incorrect signals that can be generated by broken signal lines or momentary power interruptions.
- Provide external interlock circuits, limit circuits, and other safety circuits in addition to any provided within the PC to ensure safety.



# SECTION 1

## Introduction

This section provides general information about Programmable Controllers (PCs) and how they fit into a Control System.

1-1	What is a Control System? .....	2
1-2	The Role of the PC .....	2
1-2-1	Input Devices .....	3
1-2-2	Output Devices .....	3
1-3	How Does a PC Work? .....	3

## 1-1 What is a Control System?

A Control System is the electronic equipment needed to control a particular process. It may include everything from a process control computer, if one is used, to the factory computer, down through the PCs (and there may be many of them networked together) and then on down through the network to the control components: the switches, stepping motors, solenoids, and sensors which monitor and control the mechanical operations.

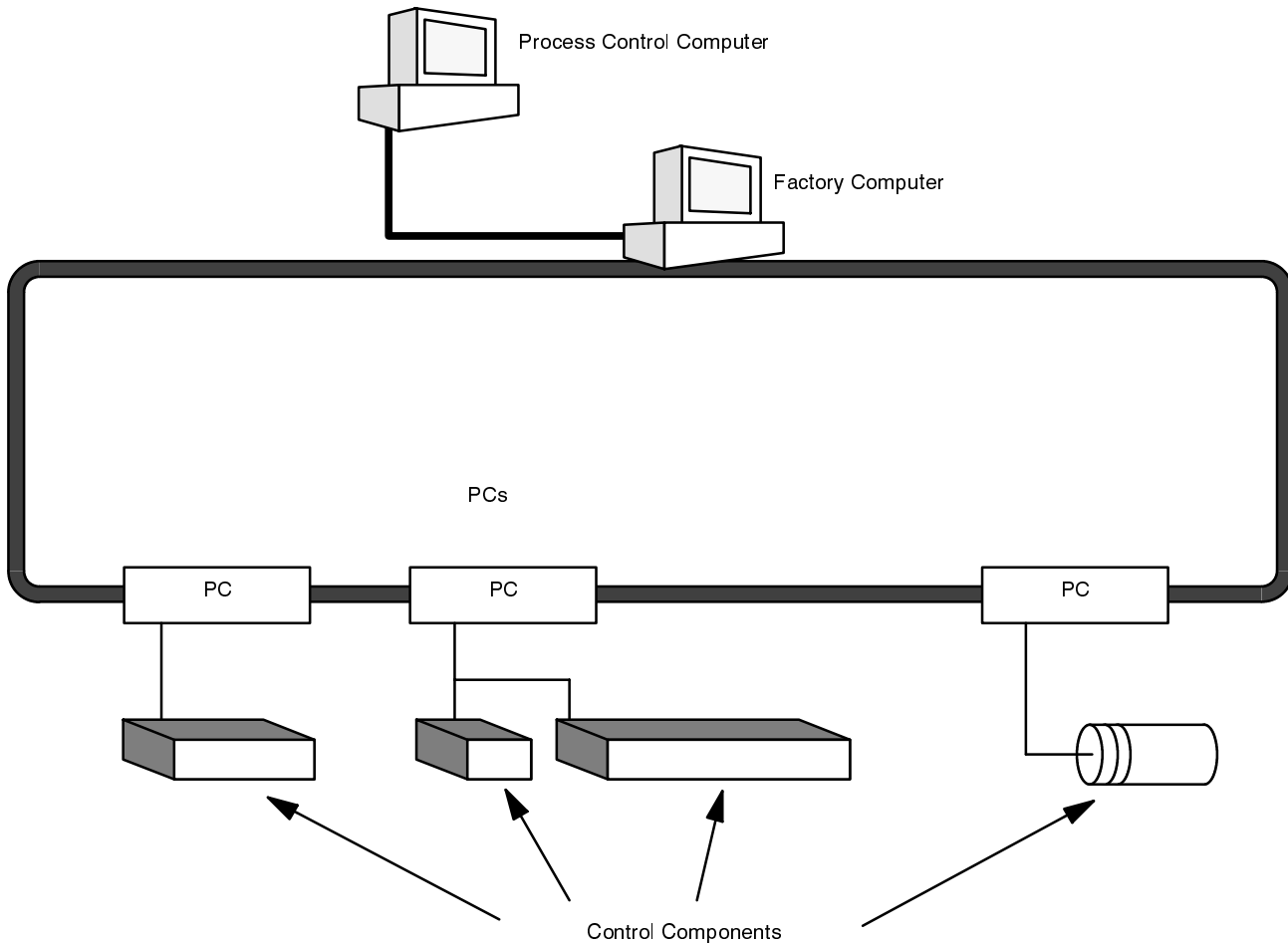

A Control System can involve very large applications where many different models of PCs are networked together or it could be an application as small as a single PC controlling a single output device.

## 1-2 The Role of the PC

The PC is the part of the Control System that directly controls the manufacturing process. According to the program stored in its memory, the PC accepts data from the input devices connected to it and uses this data to monitor the controlled system. When the program calls for some action to take place, the PC sends data to the output devices connected to it to cause that action to take place. The PC may be used to control a simple, repetitive task, or it may be connected to other PCs or to a host computer in order to integrate the control of a complex process.

### 1-2-1 Input Devices

PCs can receive input from either automated or manual devices. The PC could receive data from the user via a pushbutton switch, keyboard, or similar device. Automated input could come from a variety of devices: micro-switches, timers, encoders, photoelectric sensors, and so on. Some devices, like the Limit Switch shown below, turn ON or OFF when the equipment actually makes contact with it. Other devices, like the Photoelectric Sensor and Proximity Sensor shown below, use other means, such as light or inductance, in order to get information about the equipment being monitored.

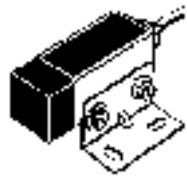

Photoelectric Sensor



Proximity Sensor



Limit Switch

### 1-2-2 Output Devices

A PC can output to a myriad of devices for use in automated control. Almost anything that you can think of could be controlled (perhaps indirectly) by a PC. Some of the most common devices are motors, Solenoids, Servomotors, Stepping Motors, valves, switches, indicator lights, buzzers, and alarms. Some of these output devices, such as the motors, Solenoids, Servomotors, Stepping Motors, and valves, affect the controlled system directly. Others, such as the indicator lights, buzzers, and alarms, provide output to notify personnel.



Solenoid



Stepping Motor



Servomotor

## 1-3 How Does a PC Work?

PCs operate by monitoring input signals and providing output signals. When changes are detected in the signals, the PC reacts, through the user-programmed internal logic, to produce output signals. The PC continually scans the program in its memory to achieve this control.

## Block Diagram of PC

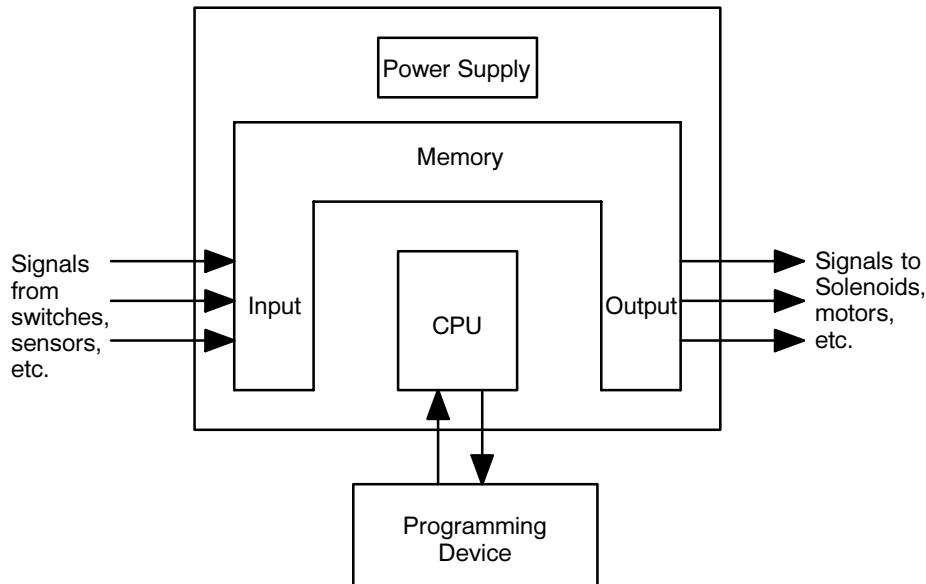

A program for your applications must be designed, and stored in the PC. This program is then executed as part of the cycle of internal operations of the PC.

## Scanning Cycle

When a PC operates, that is, when it executes its program to control an external system, a series of operations are performed inside the PC. These internal operations can be broadly classified into the following four categories:

- 1, 2, 3...**
1. Common (or overseeing) processes, such as watchdog timer operation and testing the program memory.
  2. Data input and output.
  3. Instruction execution.
  4. Peripheral device servicing.

## Scan Time

The total time required for a PC to perform all these internal operations is called the scan time. The flowchart and diagram on the following page illustrate these internal operations for a typical PC.

Timing is one of the most important factors in designing a Control System. For accurate operations, it is necessary to have answers to such questions as these:

- How long does it take for the PC to execute all the instructions in its memory?
- How long does it take for the PC to produce a control output in response to a given input signal?

The scan time of the PC can be automatically calculated and monitored, but it is necessary to have an understanding of the timing relationships within the PC for effective System design and programming.

PC Operation Flowchart

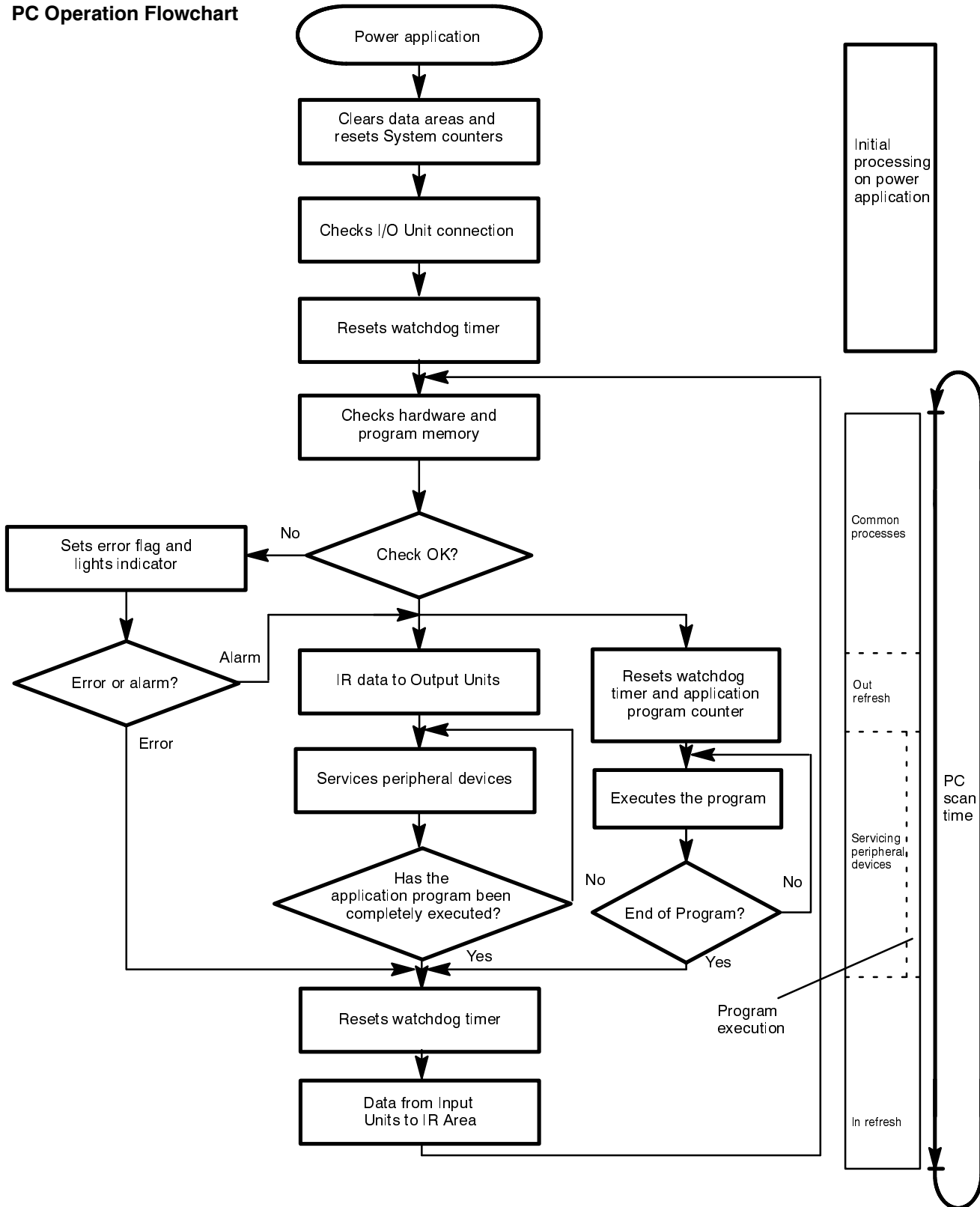

## SECTION 2

# Description of All Components

Before you begin installing your C20H, C28H, C40H, or C60H Programmable Controller, take a few minutes to familiarize yourself with the components of the PC. This section provides information about the individual Units that make up Mini H-type (C20H, C28H, C40H, and C60H) PCs. The C20H is shown as a representative model. Information about memory chips and how to set the PC for the kind of memory you are using is also explained in this section. The specifications and model numbers of the Units are listed in *Appendix A Standard Models* and *Appendix B Specifications*.

2-1	CPU .....	8
2-2	Expansion I/O Unit .....	13
2-3	Memory .....	14
2-4	Memory Installation .....	16
2-5	System Configuration .....	19

## 2-1 CPU

The CPU is available with 20, 28, 40, or 60 I/O points. Each of these Units includes the features shown in the following illustration; the Units differ only in the number of I/O points. Not shown in this illustration are memory chips and the optional realtime clock. When ordering your CPU, specify the type of memory and whether a realtime clock is desired. The realtime clock cannot be installed later.

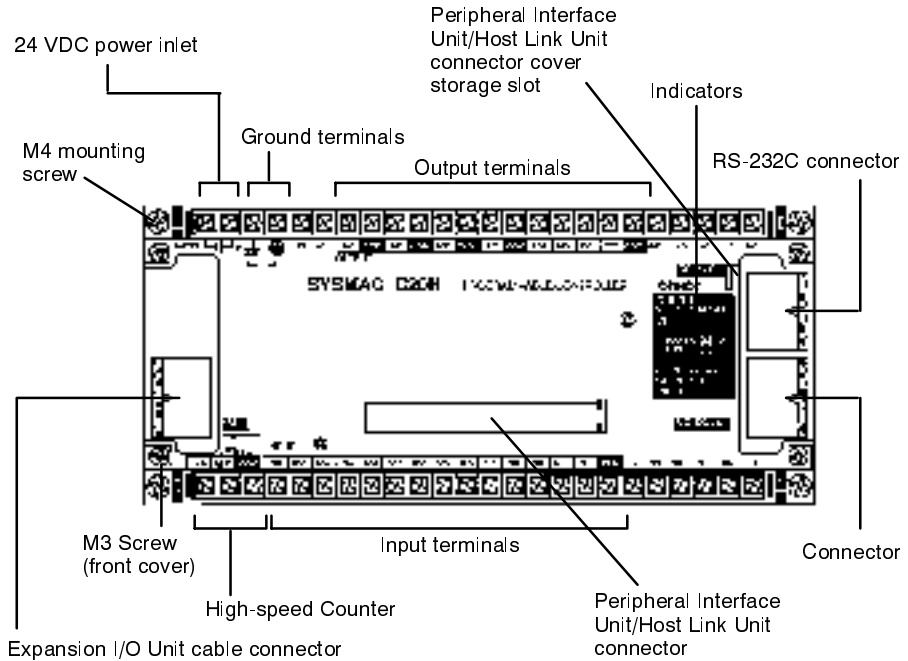

When using the the Peripheral Interface Unit/Host Link Unit connector, store the cover in the storage slot provided.

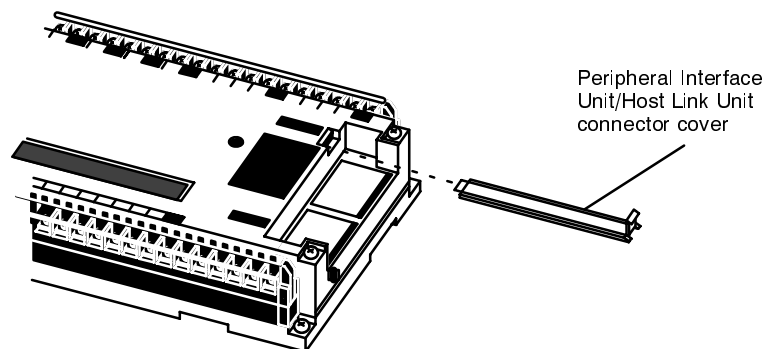

**Indicators**

The following figure shows the indicators located on the front panel of the CPU.

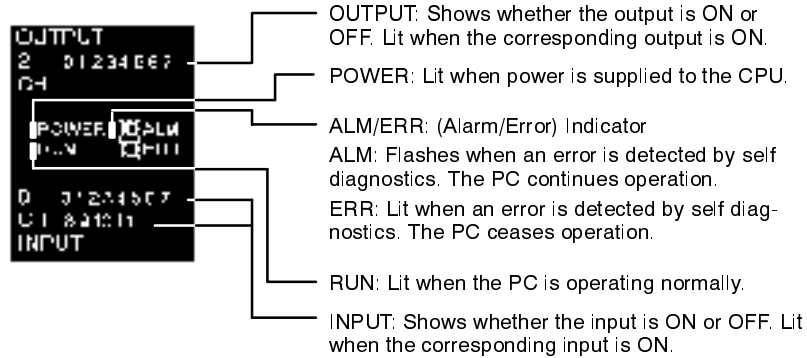

**User Program Write Enable Switch**

A user program written on RAM or EEPROM chips can be edited, written to, or write-protected by setting the DIP switch located in the Peripheral Interface Unit/Host Link Unit connector compartment.

To edit or write to the user program in the CPU, set the DIP switch to ON. Connect a Programming Console or other device to the CPU to write the program. After the program has been completely written or edited, slide the DIP switch to OFF to protect the program from further changes. If an attempt is made to write data to the program while the write enable switch is OFF, "WRITE PROTECTED" will be displayed on the Programming Console.

- Note**
1. When the write enable switch is OFF, DM 1000 through 1999 cannot be edited nor can the realtime clock be adjusted.
  2. Remember that only RAM and EEPROM chips can be edited or written to when the write enable switch is ON. EPROM requires a separate chip that is written to using a PROM Writer and then mounted in the CPU.

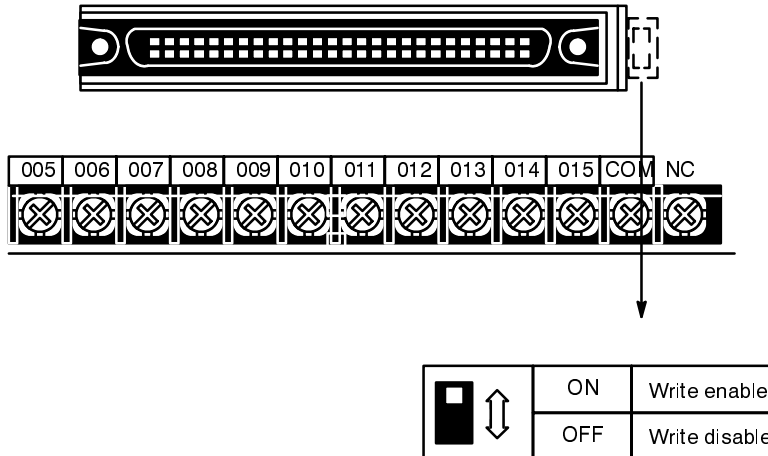



**Console Connector**

Use the connector labeled CONSOLE to connect the CPU to a Programming Console or Data Access Console. To connect the Handheld Programming Console to the CPU, a connecting cable is required as shown in the following diagram.

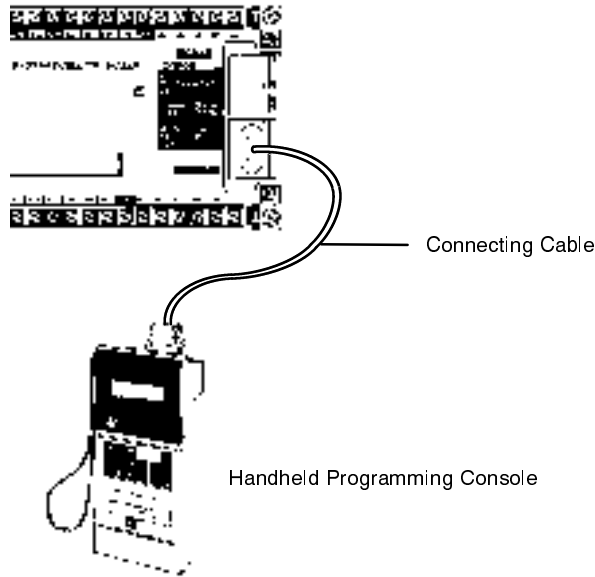
**Peripheral Interface Unit/Host Link Unit Connector**

The Peripheral Interface Unit or Host Link Unit is mounted directly to the CPU with two mounting screws. Two models of Peripheral Interface Units are available. However, when using the 3G2A5-IP004 Peripheral Interface Unit, a Console Adapter is required to ensure a proper connection. The Console Adapter is also required to connect the CPU-mounting Host Link Unit to this connector on C20H or C28H CPUs. For model numbers, refer to *Appendix A Standard Models*.

- Note**
1. The Peripheral Interface Unit or Host Link Unit and Programming Console or Data Access Console cannot be used simultaneously. If both are connected at the same time, the console operation will be ignored.
  2. When using a Peripheral Interface Unit/Host Link Unit and the RS-232C Interface at the same time, the baud rate is decreased to 2,400 bps.
  3. **Do not** mount peripheral devices such as the Programming Console, PROM Writer, Printer Interface Unit, etc. to the Peripheral Interface Unit/Host Link Unit Connector. This connector is provided only for the Peripheral Interface Unit/Host Link Unit.

**How to Mount the Peripheral Interface Unit/Host Link Unit**

- 1, 2, 3... 1. Remove the Peripheral Interface Connector cover, using a standard screwdriver. Turn the cover upside down and slide it into the connector cover storage slot.

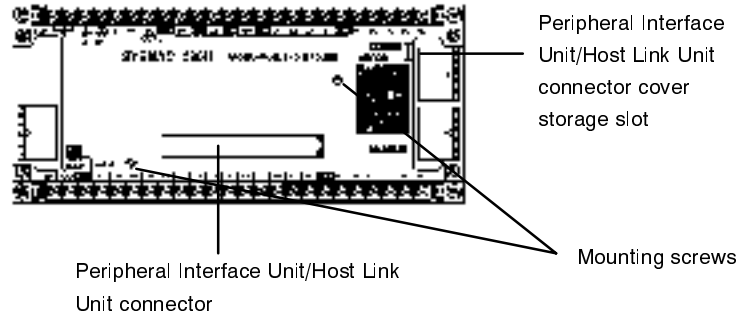

2. Mount the Peripheral Interface Unit/Host Link Unit as shown in the following diagrams. If you are using a Console Adapter, place the Adapter between the Peripheral Interface Unit/Host Link Unit and the CPU.

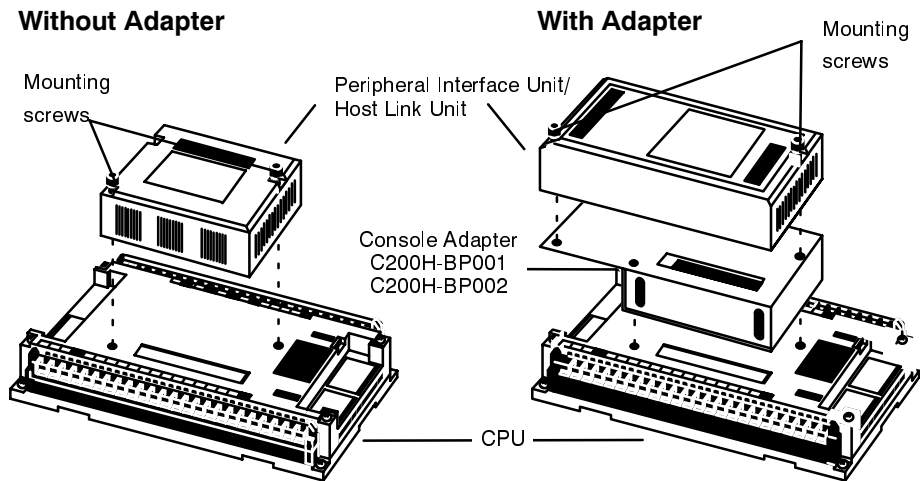

3. Press down on the Peripheral Interface Unit/Host Link Unit until the connectors are completely mated.
4. Attach the Peripheral Interface Unit/Host Link Unit to the CPU by tightening the mounting screws.

## RS-232C Interface

The RS-232C interface can be used to connect a Mini H-type PC to a variety of devices equipped with an RS-232C interface, including computers, display devices (e.g., the C500-DT021/022 Display Terminal or an NT20M-series Programmable Terminal), printers, ROM writers, or another Mini H-type PC.

The following three modes are available with the RS-232C interface:

**SYSMAC WAY Host Link Mode** Connect the PC to a host computer, FIT, etc. via the RS-232C interface connector to monitor PC operations and operation status.

Up to 32 PCs can be connected to a host computer. Use a Link Adapter to convert the signal to RS-422 or optical.

**Application Program Read/Write Mode** Connect the PC to a PROM Writer via the RS-232C interface to read or write data to the ROM. Use one of two transfer formats to read or write data: Intel HEX Format or Motorola S Format.

**ASCII I/O Mode** ASCII I/O mode can be used to communicate from the user program with external devices that are equipped with an RS-232C interface. The following instructions can be used for 2-way half-duplex communications in ASCII I/O mode: LONG MESSAGE – LMSG(47), RS-232C PORT OUTPUT – POUT(63), and RS-232C PORT INPUT – PIN(64).

The pin numbers of the RS-232C interface and the direction of I/O signals are shown in the following figure and table. Signal direction is shown from the PC side.

### Connector Pin Numbers

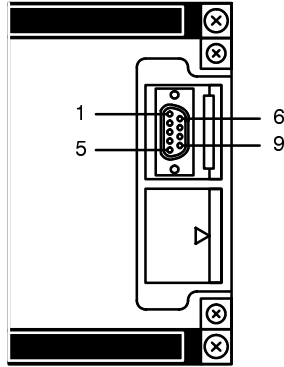

Pin No.	Abbr.	Name	I/O
1	FG	Frame ground	-
2	SD	Send data	Out
3	RD	Receive data	In
4	RS	Request to send	Out
5	CS	Capable of sending	In
6	5V	5 V for optical interface	
7	SG	Signal ground	-
8	-	Not used	-
9	-	Not used	-

**Note** Pin 6, the 5 V terminal, is provided only for the optical interface. When using the optical interface, convert the 9-terminal connector to a 25-terminal connector according to the pin assignments in the table.

Mode selection, baud rate, and communication status are set in the system settings and system registration area. For details about the system settings area and the system registration area, refer to the Mini H-type Operation Manual.

Wiring examples for each RS-232C interface mode can be found in *Section 4 System Connections*.

## 2-2 Expansion I/O Unit

Shown below is an illustration of an Expansion I/O Unit. Four types of Expansion I/O Unit are available: with 20, 28, 40, and 60 I/O points.

Expansion I/O Unit Cable connector

Connects the Expansion I/O Unit to the previous CPU or Expansion I/O Unit.  
Cover with cap when not used.

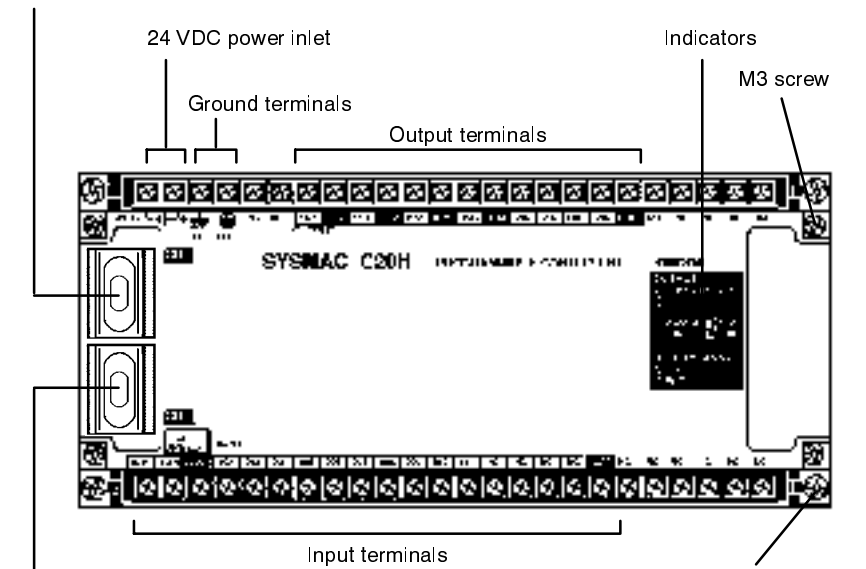

Expansion I/O Unit Cable connector

Connects the Expansion I/O Unit to the next Expansion I/O Unit.  
Cover with cap when not used.

### Indicators

The following figure shows the indicators located on the front panel of the Expansion I/O Unit.

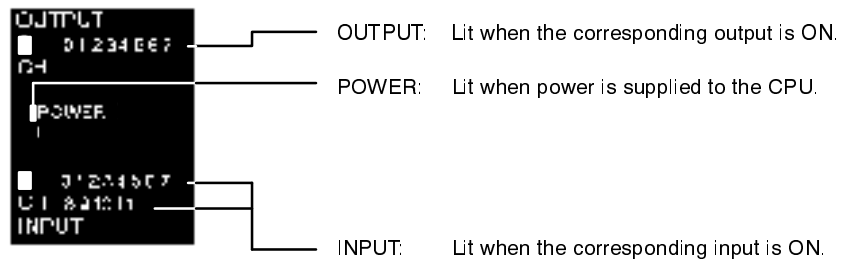

### Expansion I/O Unit Connectors

When a CPU is expanded, all of the Units are mounted and connected vertically, with the CPU first, followed by additional Expansion I/O Units. To ensure proper communication between all of the Units, be sure to connect each Unit to the correct connector. Two connectors are provided on the Expansion I/O Unit. The connector in the upper left hand corner of the Expansion I/O Unit connects the CPU to the Expansion I/O Unit. The connector directly below it connects the Expansion I/O Unit to an additional Expansion I/O Unit. The following diagram shows the proper connection of an expanded PC.

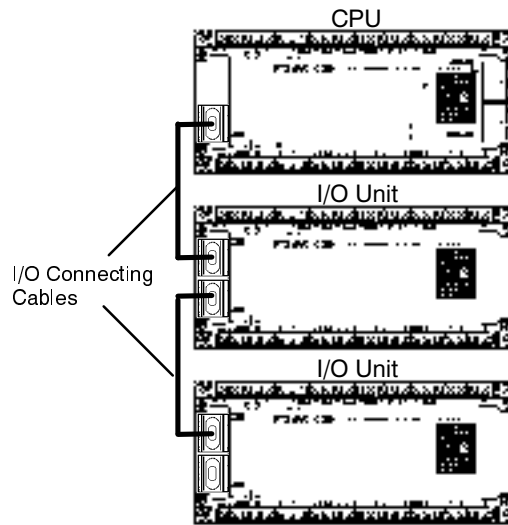

## 2-3 Memory

The user program can be stored in three types of memory: RAM, EPROM, or EEPROM. Depending on the type of memory your application requires, purchase either RAM or ROM CPUs. The RAM CPUs already have RAM or EEPROM chips mounted to the printed circuit board. The ROM CPUs, however, have sockets for mounting EPROM chips. These chips are not included with the Unit and must be purchased separately. Refer to *Appendix A Standard Models* for a list of available models.

The type of memory, either RAM or ROM, is set using jumper pins and DIP switches on the printed circuit board in the CPU. Before using the CPU, make sure the settings correspond with the kind of memory you are using.

- Note**
1. Only the CPUs equipped with an IC socket can be set for the type of memory. CPUs equipped with RAM or EEPROM cannot be set.
  2. When writing ROM from the FIT's PROM writer or via a C500-PRW06 connected to the GPC, only a 27128 or equivalent EPROM chip can be used.

### RAM

Data can be randomly written to and read from a RAM chip, making it possible to enter your own program into the CPU. However, because it is not a fixed program, the memory of the RAM chip is erased when power is not supplied to the CPU or when the RAM chip is removed from the printed circuit board. A battery is connected to the printed circuit board in order to retain data when the power to the PC is OFF. Refer to *Appendix C* for an illustration of the location of the battery and instructions on how to replace it.

### EPROM

Data stored on EPROM chips cannot be altered or erased during the CPU operation. First, data is written to the EPROM chip, using one of the three options that follow. The chip is then mounted to the circuit board inside the CPU. Once data has been written to the chip, it will be retained indefinitely and cannot be changed, even when power to the PC is OFF.

### Writing Data to EPROM Chips

Before writing data to the EPROM chip, confirm that the DIP switch and jumper pin settings on the printed circuit board in the CPU are set correctly.

**Using the C500-PRW06 PROM Writer.** In order to write data to an EPROM chip, the chip must be mounted to the PROM Writer and the PROM Writer mounted to the Graphic Programming Console (GPC). Insert the EPROM

chip into the chip socket provided on the PROM Writer and, using the GPC, write the program to the chip. Choose "C200H" as the model of PC.

**Using the Factory Intelligent Terminal (FIT).** Connect the FIT to the CPU via the RS-232C interface to write data to the RAM CPU. Choose "C200H" as the model of PC.

**Using a PROM Programmer (non-OMRON).** Connect a PROM Programmer with an RS-232C interface to the CPU via the RS-232C interface. Write data to the CPU using the Programming Console.

## EEPROM

The EEPROM chip is already mounted to the printed circuit board in the CPU and can be written to while the chip is mounted in the CPU. The data is retained indefinitely when the power is OFF.

## Memory Switches

The DIP switches and jumper pins used to set the type of memory are shown below.

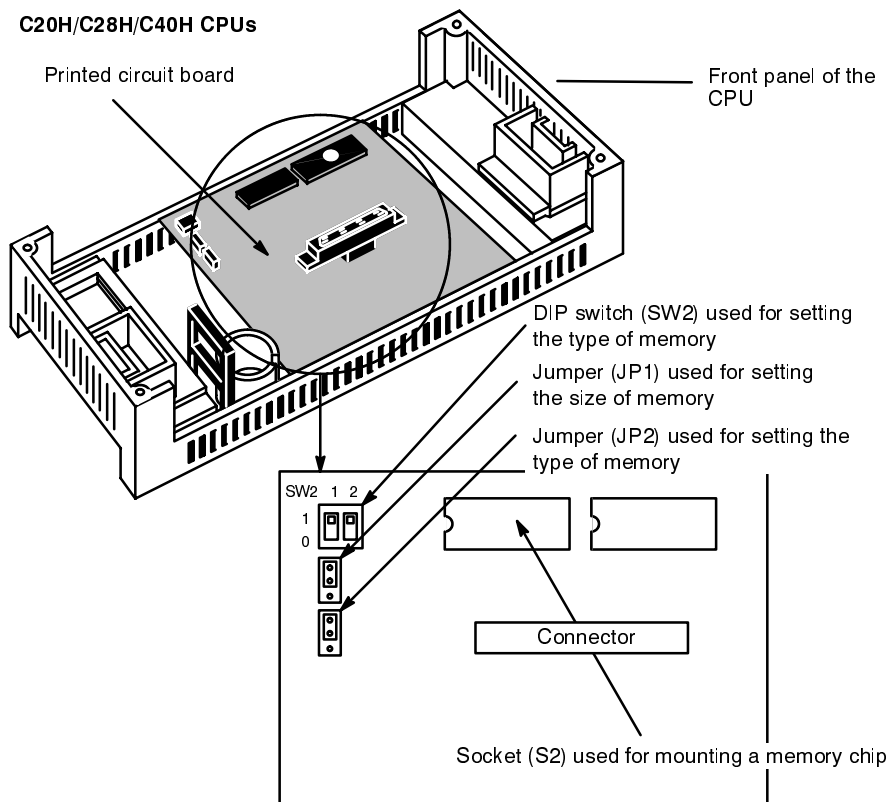

C60H CPUs

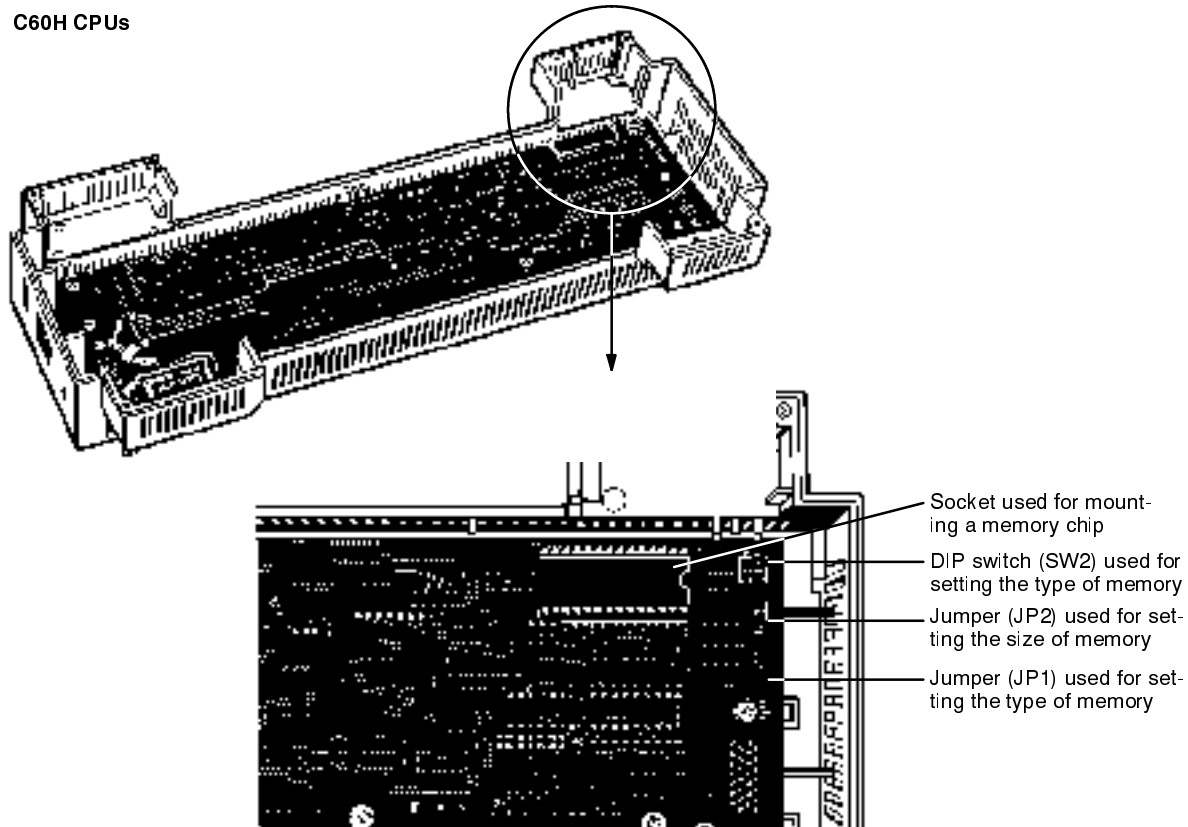















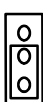





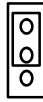

## 2-4 Memory Installation

The CPUs are available in either RAM or ROM models. The RAM CPUs have memory chips already mounted on the printed circuit board in the CPU. The ROM Units, however, use EPROM chips which vary in size and write voltage. These chips are not included with the CPU upon delivery and must be selected from the models available. Refer to *Appendix A Standard Models* for a list of available models. The EPROM chip must be mounted to the PROM Writer in order for the program to be written to it. The EPROM Chip is then mounted to the printed circuit board in the CPU.

The user program in the RAM CPU can be edited, written to, or write-protected by setting the DIP switch located in the Peripheral Interface compartment. To write data to RAM or EEPROM, connect a personal computer running the SSS to the CPU via the RS-232C interface. When using the Hand-held Programming Console connect the CPU via the connector labeled "CONSOLE" to write the program.

**Jumper Pin and DIP Switch Settings**

Before installing the EPROM chip, make sure the DIP switch and the jumper pins are set properly. Refer to the following table for the correct settings.

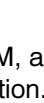
		Type of Memory (SW2)	Memory Size (JP1)	Type of Memory (JP2)
<b>Factory Settings</b>		1 2 1 0 	 EXCEPT 27256  27256	 EPROM/EEPROM  RAM
<b>RAM</b>		1 2 1 0 	 EXCEPT 27256  27256	 EPROM/EEPROM  RAM
<b>ROM</b>	2764 27128	1 2 1 0 	 EXCEPT 27256  27256	 EPROM/EEPROM  RAM
	27256	1 2 1 0 	 EXCEPT 27256  27256	 EPROM/EEPROM  RAM
<b>EEPROM</b>		1 2 1 0 	 EXCEPT 27256  27256	 EPROM/EEPROM  RAM

When the jumper pin is changed from ROM/EEPROM to RAM, a memory error will occur. Execute "Memory All Clear" to resume operation.

 **Caution**

Do not remove or mount chips to the socket while the CPU is set for RAM. Doing this will damage the data in the chip or may cause data to be completely lost.

**How to Mount the Chips**

After writing data to the EPROM Chip, mount it to the printed circuit board of the CPU. Make sure the jumper pins and the DIP switch settings are set properly.

- 1, 2, 3...
1. Turn OFF the power to the PC.
  2. Loosen the four M3 screws on the front cover with a Phillips screwdriver. After all of the screws are loosed, lift the front cover from the Unit, lifting it from the left.

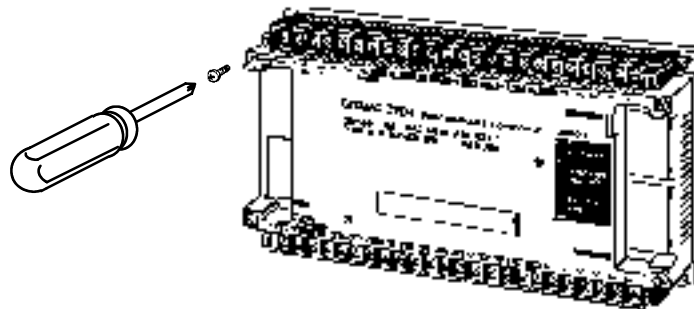



- The DIP switch, jumper pins, and the chip socket are located on the printed circuit board on the reverse side of the case. The jumper pins and the DIP switch should be set for the type and size of ROM you are using.

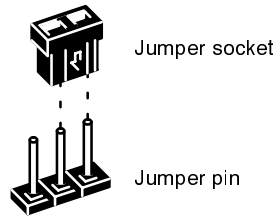

Make sure jumper (JP1) is set to ROM/EEPROM, **before** mounting the chip. If the setting is different, change the jumper pins and DIP switch accordingly.

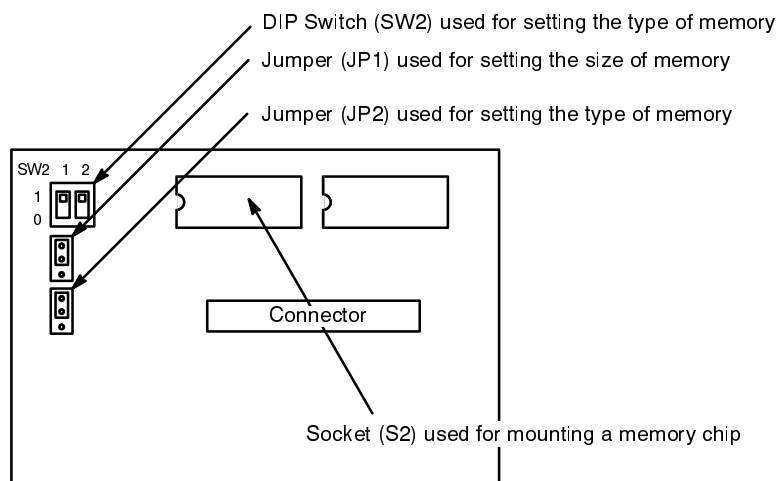

**Caution** If the EEPROM chip is mounted to or removed from the socket while the jumper pin (JP2) is set for RAM, the data in the chip will be damaged or lost.

- Mount the chip to the socket. Be sure to mount the chip with the notched side facing left.
- When replacing the CPU cover, press down on the cover slightly to ensure that the internal connectors are properly connected, and tighten the four screws on the front cover.

## 2-5 System Configuration

A CPU can be used by itself or it can be combined with up to three Expansion I/O Units to increase I/O capacity. Depending on your control requirements, you can thus use a signal C20H CPU for as few as 20 I/O points, or you can combine Units for a maximum of 240 I/O points (C60H CPU plus three C60 Expansion I/O Units).

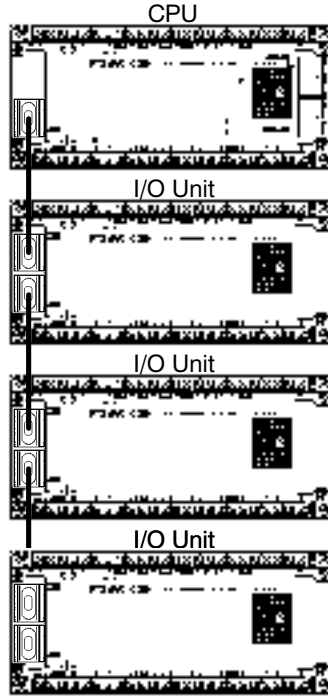

### Unit Combinations

The following table shows the combinations that produce various I/O capacities.

Total I/O	Inputs	Outputs	CPU	I/O Unit	I/O Unit	I/O Unit
20	12	8	C20H	---	---	---
28	16	12	C28H	---	---	---
40	24	16	C40H	---	---	---
48	28	20	C28H	C20H	---	---
56	32	24	C28H	C28H	---	---
60	32	28	C60H	---	---	---
	36	24	C40H	C20H	---	---
68	40	28	C40H	C28H	---	---
76	44	32	C28H	C28H	C20H	---
80	44	36	C60H	C20H	---	---
	48	32	C40H	C40H	---	---
84	48	36	C28H	C28H	C28H	---
88	48	40	C60H	C28H	---	---
	52	36	C40H	C28H	C20H	---
96	56	40	C40H	C28H	C28H	---

Total I/O	Inputs	Outputs	CPU	I/O Unit	I/O Unit	I/O Unit
100	56	44	C60H	C40H	---	---
	60	40	C40H	C40H	C20H	---
104	60	44	C28H	C28H	C28H	C20H
108	60	48	C60H	C28H	C20H	---
	64	44	C40H	C40H	C28H	---
112	64	48	C28H	C28H	C28H	C28H
116	64	52	C60H	C28H	C28H	---
	68	48	C40H	C28H	C28H	C20H
120	64	56	C60H	C60H	---	---
	68	52	C60H	C40H	C20H	---
	72	48	C40H	C40H	C40H	---
124	72	52	C40H	C28H	C28H	C28H
128	72	56	C60H	C40H	C28H	---
	76	52	C40H	C40H	C28H	C20H
136	76	60	C60H	C28H	C28H	C20H
	80	56	C40H	C40H	C28H	C28H
140	76	64	C60H	C60H	C20H	---
	80	60	C60H	C40H	C40H	---
	84	56	C40H	C40H	C40H	C20H
144	80	64	C60H	C28H	C28H	C28H
148	80	68	C60H	C60H	C28H	---
	84	64	C60H	C40H	C28H	C20H
	88	60	C40H	C40H	C40H	C28H
156	88	68	C60H	C60H	C28H	C28H
160	88	72	C60H	C60H	C40H	---
	92	68	C60H	C40H	C40H	C20H
	92	64	C40H	C40H	C40H	C40H
168	96	76	C60H	C60H	C28H	C20H
	96	72	C60H	C40H	C40H	C28H
176	96	80	C60H	C60H	C28H	C28H
180	96	84	C60H	C60H	C60H	---
	100	80	C60H	C60H	C40H	C20H
	104	76	C60H	C40H	C40H	C40H
188	104	84	C60H	C60H	C40H	C28H
200	108	92	C60H	C60H	C60H	C20H
	112	88	C60H	C60H	C40H	C40H
208	112	96	C60H	C60H	C60H	C28H
220	120	100	C60H	C60H	C60H	C40H
240	128	112	C60H	C60H	C60H	C60H

# SECTION 3

## RS-232C Interface

This section explains the wiring and connections for the three modes of the RS-232C interface. For model numbers of the Units and the connecting cables mentioned in this section refer to *Appendix A Standard Models*.

3-1	Host Link Mode .....	22
3-2	Application Program Read/Write Mode .....	25
3-3	ASCII I/O Mode .....	25

### 3-1 Host Link Mode

The CPU can be connected to either one Host Computer or one FIT at one time. The following diagrams show the connections between the CPU and a Host Computer or the FIT. A Host Computer, after it is connected to the CPU, can be connected to up to 32 PCs.

**CPU : Host Computer/FIT**

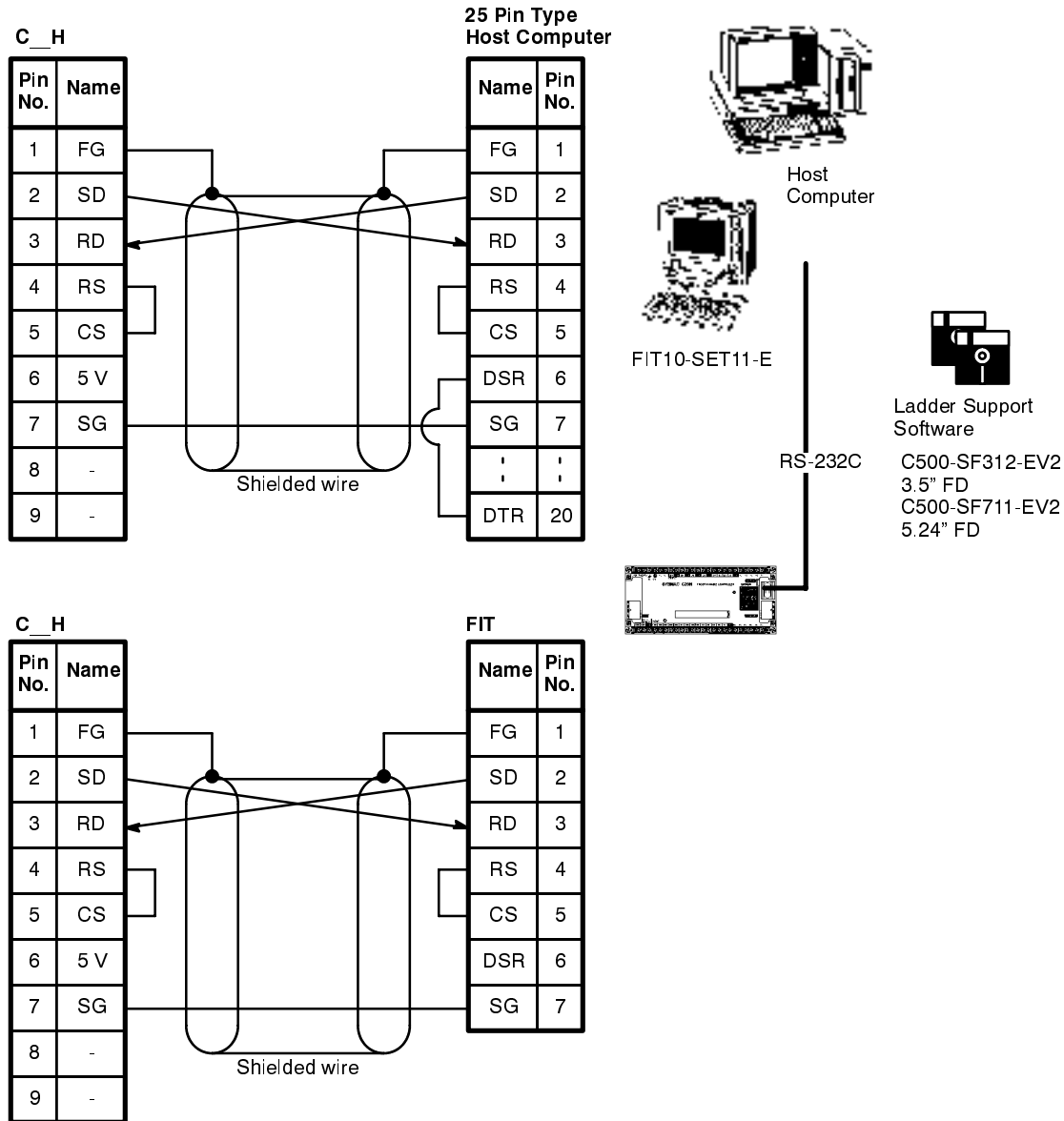

**Connecting Cable** The maximum cable length between the CPU and a Host Computer or the FIT is 15 m.

Host Computer : PCs

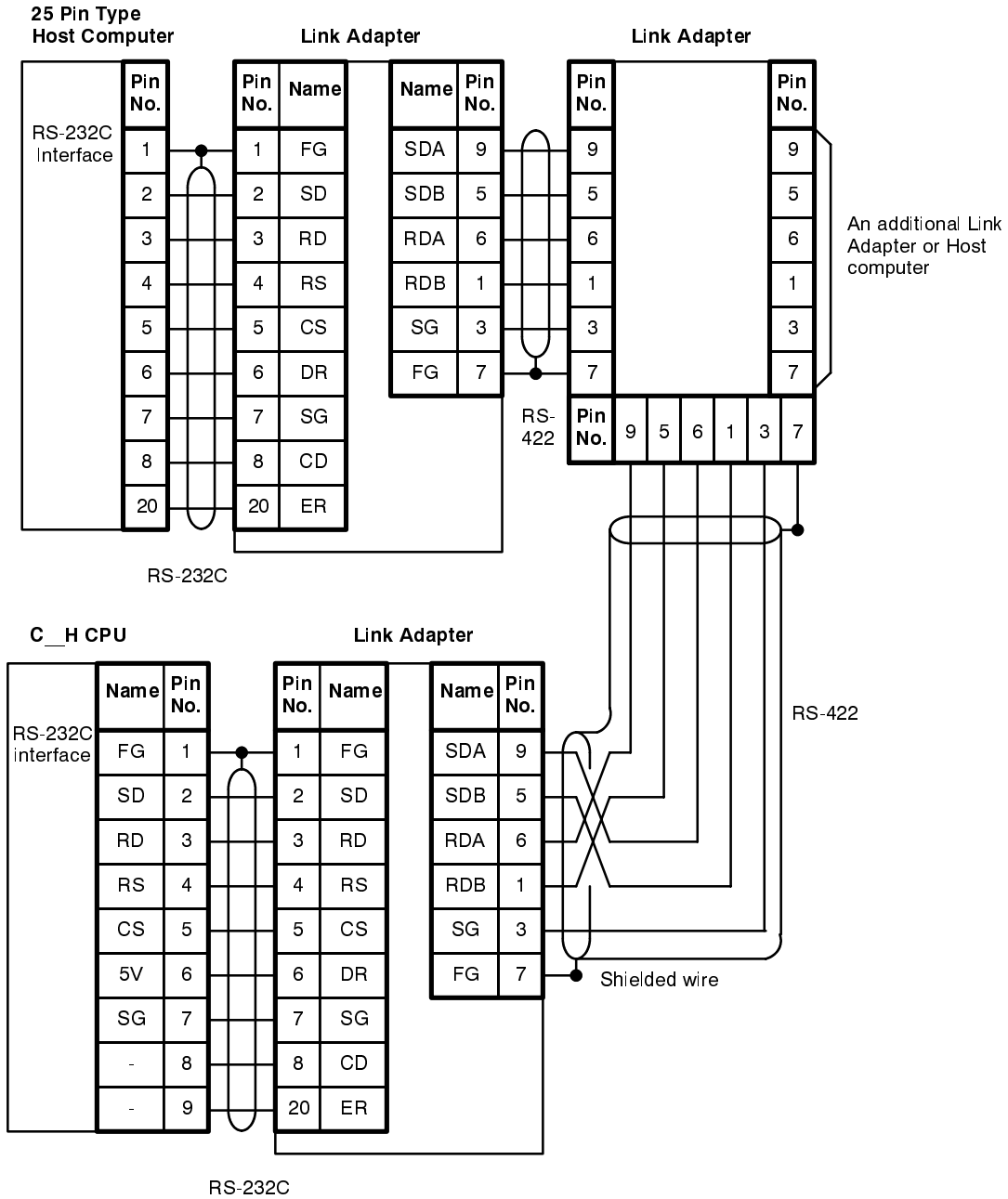

Using a Link Adapter, the Host Computer can be connected to other C-series PCs via a Host Link Unit, or to additional Mini H-type PCs via the RS-232C interface. Up to 32 additional C-series PCs can be connected to the Host Computer. The illustration below illustrates this configuration. For details about the Link Adapter, refer to the Link Adapter Operation Manual and Installation Guide.

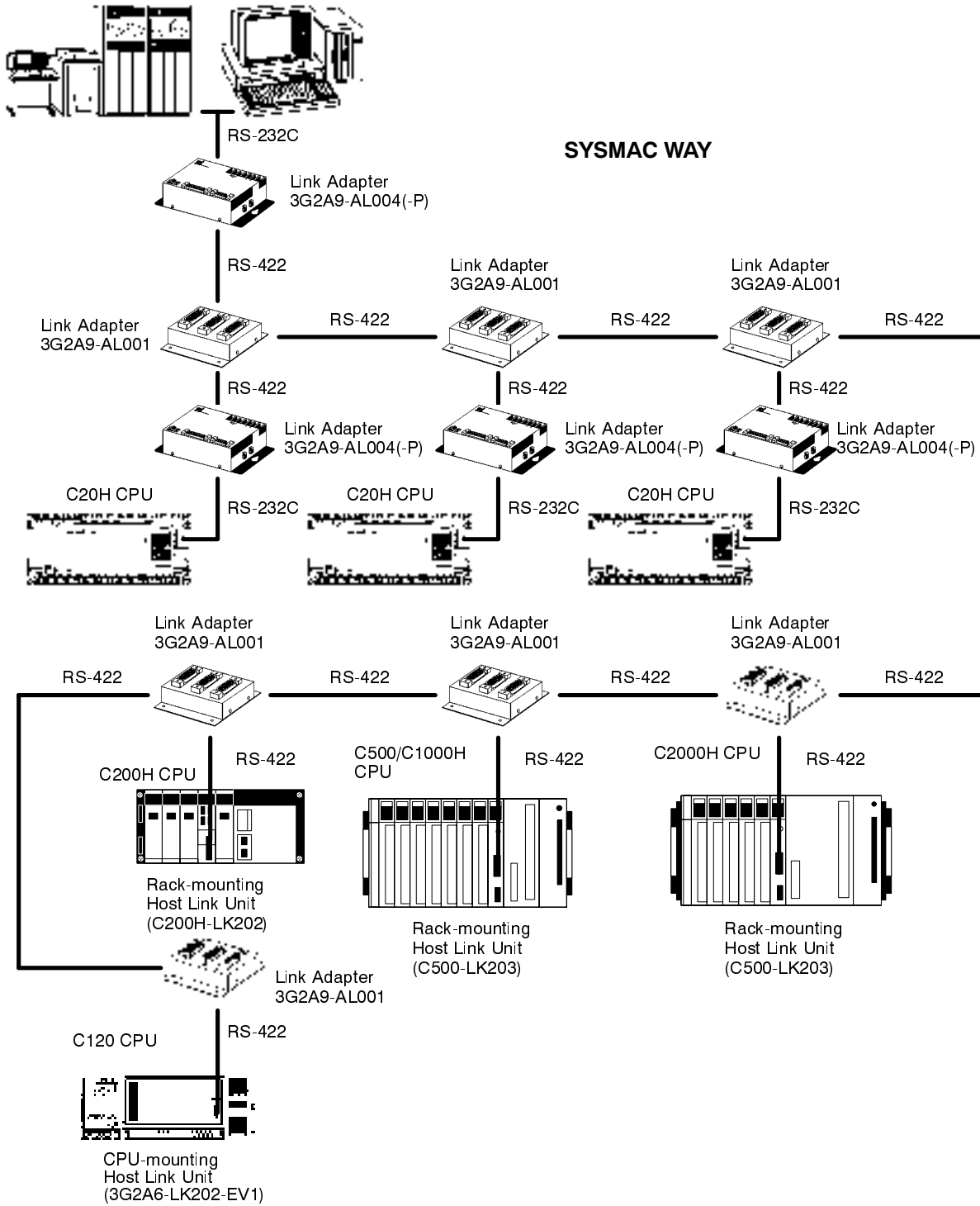

**Connecting Cable** When using the RS-232C interface the maximum cable length is 15 m. When using the RS-422 interface the maximum cable length is extended to 500 m. Each branch cable between the adapter and the Host Link Unit must be less than 10 m.

### 3-2 Application Program Read/Write Mode

The following diagram illustrates the connection between the CPU and the PROM Writer. There is a choice of two transfer formats: Intel HEX format or Motorola S Format.

CPU : PROM Writer

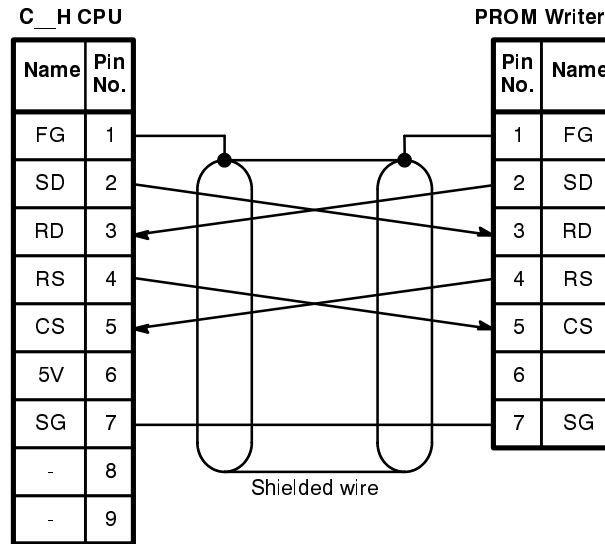

**Connecting Cable** The maximum cable length between the CPU and the PROM Writer is 15 m. Before making or using the cable, verify the pinout of the PROM Writer being used.

### 3-3 ASCII I/O Mode

ASCII I/O mode can be used to communicate from the user program with external devices that are equipped with an RS-232C interface. The following instructions can be used for 2-way half-duplex communications in ASCII I/O mode: LONG MESSAGE - LMSG(47), RS-232C PORT OUTPUT - POUT(63), and RS-232C PORT INPUT - PIN(64).

The following diagrams show the connections between the CPU and the Display Terminal Unit and the connections between the CPU and a printer.



CPU : Display Terminal

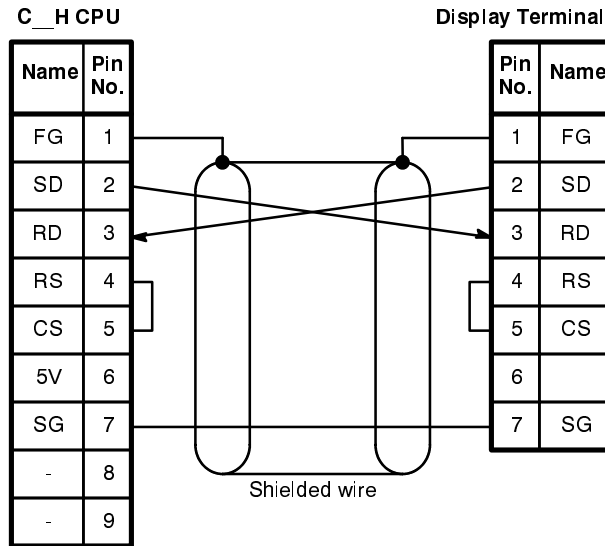

**Connecting Cable** The maximum cable length between the CPU and the Display Terminal Unit or printer is 15 m.

CPU : Printer

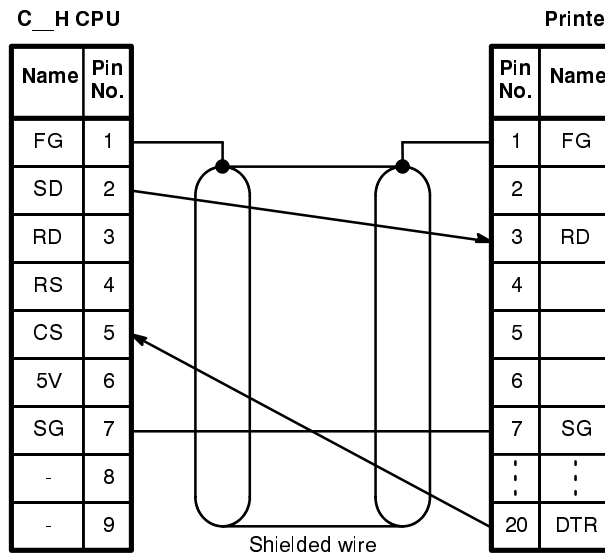

**Connecting Cable** The maximum cable length between the CPU and the Display Terminal Unit or printer is 15 m.

## SECTION 4

# System Memory Allocation

This section provides information about the area in memory allocated to the system for system settings and registration, error history, and information regarding program headers, version numbers, etc. Where specific information is stored and how it can be accessed is also explained.

4-1	DM Word Allocation .....	28
4-2	System Settings Area .....	28
4-3	System Registration Area .....	28
4-4	System Commands .....	30
4-5	System Settings/Registration Area Bit Allocation .....	33
4-6	Error History .....	39
4-7	User Program Header .....	42

## 4-1 DM Word Allocation

Words DM 0900 through 0999 and DM 1900 through 1999 in memory are allocated as the system area for Mini H-series PCs. This area is used to store system settings, error history, the registered system settings, and the application program header. The following table explains the content of the system area. This area in memory cannot be used as data memory.

For details about each data area refer to the Mini H-series Operation Manual.

DM word number	Name	Function
0900 through 0929	System settings area	Sets the operation mode of the PC
0930 through 0968	Not used	–
0969 through 0999	Error history	Stores the error history (time and type of error) of the most recent ten errors. If the CPU does not have a Realtime Clock, the time the error occurred will not be recorded.
1900 through 1929	System registration area	Backs up the system settings area. If EPROM or EEPROM is used, a battery is not needed in order to backup.
1930 through 1989	Not used	–
1990 through 1999	Application program header	Registers the title, version, and the date the program was created by the user.

## 4-2 System Settings Area

The system settings area (DM 0900 through DM 0929) sets the operation mode of the PC and of the RS-232C interface, service times, etc. The following table shows the function of each word in this area. If the setting is incorrect the PC will not operate properly.

Function	Word
CPU settings	DM 0900 through DM 0904
High-speed Counter and data table	DM 0905 through DM 0917
RS-232C interface communication status and operation mode	DM 0920 through DM 0926

After writing or editing the system settings, execute "SYSTEM SETTING". By doing this a sum of the words DM 0900 through DM 0929 is made automatically. When power is supplied to the PC, the sum value made by executing "SYSTEM COMMAND" is used as a checksum to verify that the system settings are free from errors. If an error is found "SYSTEM ERROR FAL 9F" is displayed on the Programming Console.

## 4-3 System Registration Area

The system registration area (DM 1900 through DM 1929) is provided as a backup of the system settings. Note that the word numbers of the system settings area correspond to the word numbers of the system registration area (DM 09XX : DM 19XX). If the setting is incorrect the PC will not operate properly.

Function	Word
Initial operation mode	DM 1900
Scan time exceeded detection	DM 1901
Programming Console service time	DM 1902
RS-232C interface service time	DM 1903
Programming Console message	DM 1904
High-speed Counter and data table	DM 1905 through DM 1917
RS-232C interface communication status and operation mode	DM 1920 through DM 1924

To transfer the system settings to the system registration area, execute "SYSTEM REGISTRATION". By executing "SYSTEM REGISTRATION" the sum of the words DM 1900 through DM 1929 is made automatically. When power is supplied to the PC, the sum value made by executing "SYSTEM REGISTRATION" is used as a checksum to verify that the system settings are free from errors. If an error is found "SYSTEM ERROR FAL 9F" is displayed on the Programming Console. When an error occurs, check the data of both areas and execute "SYSTEM REGISTRATION" again.

Once the system settings are transferred to the system registration area, the PC will operate using the registered settings each time power is supplied to the PC. If the setting is changed but not registered, the PC operates using the edited system setting until the power to the PC is OFF. When power is re-applied to the PC, the PC will operate using the previously registered setting (the setting used before modification). To retain an edited system setting, be sure to register it in the system registration area.

If you have registered a system setting but do not want the system setting to be registered, execute "SYSTEM REGISTRATION RELEASE" to cancel the "SYSTEM REGISTRATION" command.

**Note** "SYSTEM REGISTRATION RELEASE" is not a valid command when an EPROM chip is mounted in the CPU or when the Write Enable Switch is OFF.

## 4-4 System Commands

To execute system commands (“SYSTEM SETTING”, “SYSTEM REGISTRATION”, etc.) enter the proper code through word AR14. In order to enter and execute the commands, bit AR1415 must be turned ON using a forced set operation. A response code tells you whether the system command is free from errors.

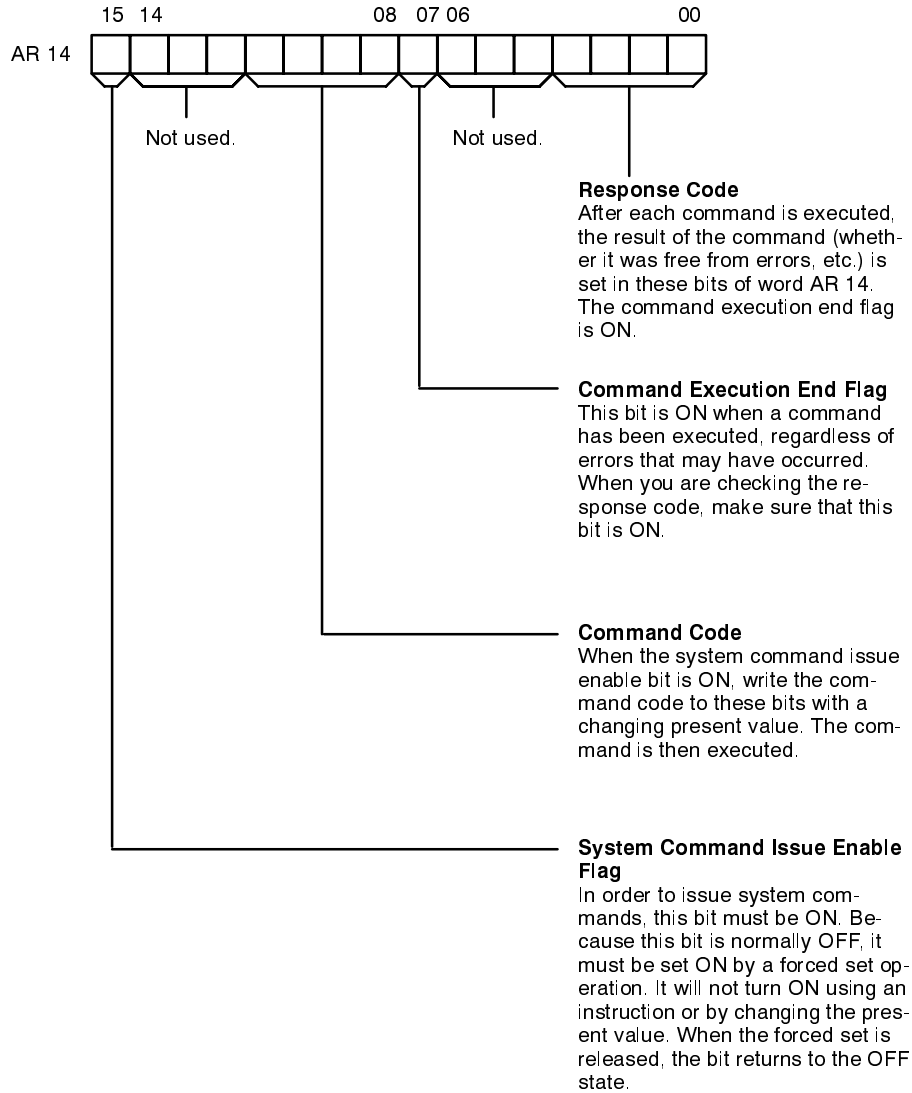

## Command Codes

Command Code	Code Name	Function
1	SYSTEM SETTING	Sets the system settings in the system settings area, DM 0900 through DM 0929. The sum of the words DM 0900 through DM 0929 is made and verified by a checksum when this command is executed.
2	SYSTEM REGISTRATION	Transfers the data in the system settings area to the system registration area. The sum of the words DM 1900 through DM 1929 is made and verified by a checksum when this command is executed. AR 1314 is ON when the command is issued.
3	SYSTEM REGISTRATION RELEASE	Disables system registration. AR 1314 is OFF when this command is issued.
4	SYSTEM SETTING CLEAR	Clears all of the data in the system settings area (DM 0900 through DM 0929) to 0000.
5	SYSTEM SETTING 1	Sets DM 0900 through DM 0904 in the system settings area. DM 0905 through DM 0929 are not set using this code.
6	SYSTEM SETTING 2	Sets DM 0905 through DM 0919 in the system settings area. DM 0900 through DM 0904 and DM 0920 through DM 0929 are not set using this code.
7	SYSTEM SETTING 3	Sets DM 0920 through DM 0929 in the system settings area. DM 0900 through DM 0919 are not set using this code.

## Response Codes

Command Code	Code Name	Remarks
0	COMPLETED	The system command was executed without errors.
1	UNDEFINED COMMAND	The issued command was undefined.
2	WRITE PROTECTED	The user program (application program area, DM 1000 through DM 1999) is write-protected or the memory is EPROM.
3	SYSTEM SETTING ERROR	The sum of the words in the system settings area was not calculated when the "SYSTEM REGISTRATION" was executed.

**How to Execute System Commands**

Before beginning this procedure connect the CPU to a Handheld Programming Console, a Graphic Programming Console, or the FIT.

- 1, 2, 3...**
1. Change the mode of the PC to PROGRAM or MONITOR.
  2. To write the system commands, bit AR 1415 (the System Command Execution Bit) must be ON. However, because this bit is usually OFF, use a forced set to change the status of the bit to ON. (If you are using the Programming Console, change the status of the bit to ON by I/O monitoring the AR 1415 bit and then pressing SHIFT and SET.
  3. Write the system command codes to word AR 14 by changing the present value.
  4. When the command is executed the response code is set. Make sure that the System Command Completion Flag (AR 1407) is ON and that the response code is 0 (meaning no errors). If the response code shows no errors, write the next code.
  5. To continue writing commands, follow steps 3 through 5.
  6. After writing the commands, release the forced set on bit AR 1415 using the Programming Console, Graphic Programming Console, or the FIT.

- Note**
1. System commands cannot be written to AR 14 unless a forced set has been executed to change the status of the bit to ON. If system commands are written without changing the status of AR 14 to ON **or** are written by not changing the present value, the commands are ignored.
  2. When the forced set on bit AR 1415 is released, the bit automatically returns to the OFF status.

System Setting/Registration Process Flowchart

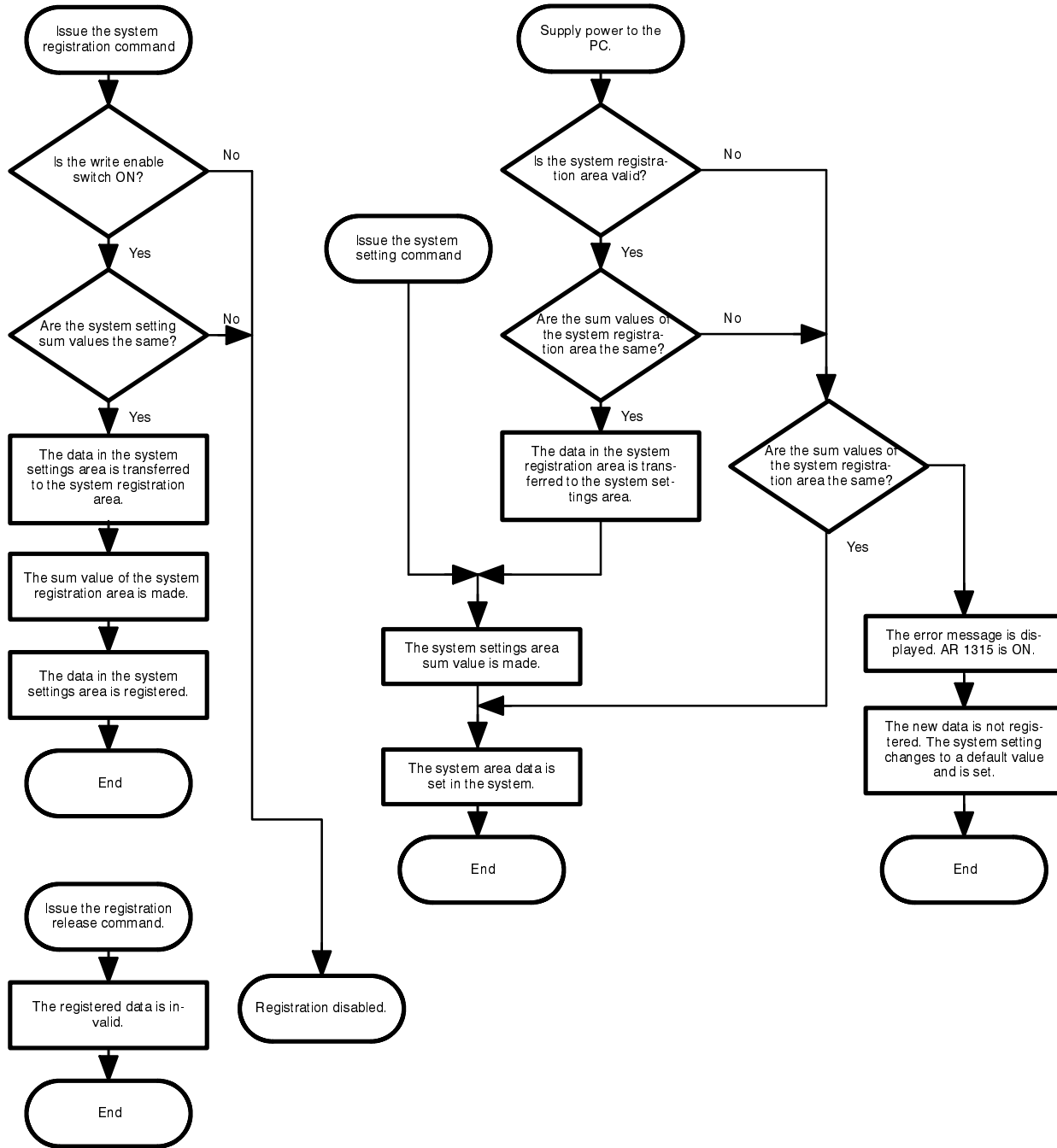

### 4-5 System Settings/Registration Area Bit Allocation

The system settings and a backup of the system settings (in the registration area) are stored in words DM 0900 through DM 0929 and DM 1900 through DM1929 (registration area). The preceding tables explain the function of each word and the settings that can be applied to each word.

After making changes to the system settings, be sure to execute SYSTEM SETTING to set the data in the system settings area. Once the system settings have been tested and debugged, execute SYSTEM REGISTRATION to register the system settings in the system registration area (system setting



backup). By doing this, the system settings will not be lost when the power to the PC is OFF.

When making the system settings, be sure to apply the correct setting to each word. If an incorrect setting is applied, a setting error occurs causing the bits of words AR 12 and AR 13 to turn ON. At this time, the each word in the system settings area is 00.

**Note** The *Default* settings are set at the factory and will be used if the settings are not changed by the user. The system will also revert to these settings if the content of memory is lost, e.g., when an FAL error of 9E is generated.

### Bit Allocation

Word	Bit No.	Function	Default
DM 0900 (DM 1900)	00 through 07	Initial operation mode (Bits 8 through 15 must be 02 to make the initial operation valid.) 00 Program mode 01 Monitor Mode 02 Run mode	Programming Console key switch mode
	08 through 15	Initial operation mode setting Lets you set the operation mode with the Programming Console by default or through the CPU. 00 Programming Console key input 01 Resumes the mode (in AR 15) that was valid before the power was turned OFF 02 The initial operation mode set in bits 0 through 7.	
DM 0901 (DM 1901)	00 through 07	Scan time exceeded detection (In order to set bits 00 through 07, set bits 08 through 15 to 01.) Set the time at which exceeded scan time will be detected. Set the value with BCD. BCD (00 through 99) x 10 ms(0 through 990 ms)	100 ms (fixed)
	08 through 15	Scan time exceeded detection (valid/invalid) 00 Invalid (The time is fixed to 100 ms.) 01 Valid (This time is the value set in bits 00 through 07.)	
DM 0902 (DM 1902)	00 through 07	Programming Console service time (In order to set bits 00 through 07, set bits 08 through 15 to 01.) Enter the Programming Console service time in BCD (00 through 99). This number is the percentage of the scan time that is defined as Programming Console service time. Example: Enter the number 12. If the scan time is 10 ms, the Programming Service time is 1.2 ms (10 ms x 12% = 1.2 ms).	5% (fixed)
	08 through 15	Programming Console service time (valid/invalid) 00 Invalid (The percentage is fixed as 5%. If 5% of the scan time is less than 1 ms, the Programming Console service time is 1 ms. 01 Valid (This percentage is the value set in bits 00 through 07)	
DM 0903 (DM 1903)	00 through 07	RS-232C interface service time (In order to set bits 00 through 07, set bits 08 through 15 to 01.) Enter the RS-232C interface service time in BCD (00 through 99). This number is the percentage of the scan time that is defined as RS-232C interface service time. Example: Enter the number 14. If the scan time is 10 ms, the RS-232C interface service time is 1.4 ms (10 ms x 14% = 1.4 ms).	5% (fixed)
	08 through 15	RS-232C interface service time (valid/invalid) 00 Invalid (The percentage is fixed as 5%. If 5% of the scan time is less than 1 ms, the RS-232C interface service time is 1 ms. 01 Valid (This percentage is the value set in bits 00 through 07)	

Word	Bit No.	Function			Default
DM 0904 (DM 1904)	00 through 07	Not used			English
	08 through 15	Programming Console message 00 English 01 Japanese 02 German 03 French 04 Italian 05 Spanish			
DM 0905 (DM 1905)	00	OUT 00200	Interrupt output valid/invalid = 1/0	High-speed Counter operation mode setting	High-speed Counter is set to 0
	01	OUT 00201			
	02	OUT 00202			
	03	OUT 00203			
	04	OUT 00204			
	05	OUT 00205			
	06	OUT 00206			
	07	OUT 00207			
	08 through 10	Bank 0 last step No. (0 through 7)			
	11 through 13	Bank 1 beginning step No. (0 through 7)			
	14	Hardware reset valid/invalid = 1/0			
	15	High-speed Counter valid/invalid = 1/0			
	DM 0906 (DM 1906)	00	OUT 00200	Step 0 output pattern	
01		OUT 00201			
02		OUT 00202			
03		OUT 00203			
04		OUT 00204			
05		OUT 00205			
06		OUT 00206			
07		OUT 00207			
08		OUT 00200	Step 1 output pattern		
09		OUT 00201			
10		OUT 00202			
11		OUT 00203			
12		OUT 00204			
13		OUT 00205			
14		OUT 00206			
15		OUT 00207			

Word	Bit No.	Function		Default		
DM 0907 (DM 1907)	00	OUT	00200	Step 2 output pattern High-speed Counter interrupt output data table (see note at end of table)	-	
	01	OUT	00201			
	02	OUT	00202			
	03	OUT	00203			
	04	OUT	00204			
	05	OUT	00205			
	06	OUT	00206			
	07	OUT	00207			
	08	OUT	00200			Step 3 output pattern
	09	OUT	00201			
	10	OUT	00202			
	11	OUT	00203			
	12	OUT	00204			
	13	OUT	00205			
	14	OUT	00206			
	15	OUT	00207			
DM 0908 (DM 1908)	00	OUT	00200	Step 4 output pattern High-speed Counter interrupt output data table (see note at end of table)	-	
	01	OUT	00201			
	02	OUT	00202			
	03	OUT	00203			
	04	OUT	00204			
	05	OUT	00205			
	06	OUT	00206			
	07	OUT	00207			
	08	OUT	00200			Step 5 output pattern
	09	OUT	00201			
	10	OUT	00202			
	11	OUT	00203			
	12	OUT	00204			
	13	OUT	00205			
	14	OUT	00206			
	15	OUT	00207			

Word	Bit No.	Function		Default
DM 0909 (DM 1909)	00	OUT 00200	Step 6 output pattern	High-speed Counter interrupt output data table (see note at end of table)
	01	OUT 00201		
	02	OUT 00202		
	03	OUT 00203		
	04	OUT 00204		
	05	OUT 00205		
	06	OUT 00206		
	07	OUT 00207		
	08	OUT 00200	Step 7 output pattern	
	09	OUT 00201		
	10	OUT 00202		
	11	OUT 00203		
	12	OUT 00204		
	13	OUT 00205		
	14	OUT 00206		
15	OUT 00207			
DM 0910 (DM 1910)	00 through 15	Step 0 Set Value	High-speed Counter Step setting table	-
DM 0911 (DM 1911)	00 through 15	Step 1 Set Value		
DM 0912 (DM 1912)	00 through 15	Step 2 Set Value		
DM 0913 (DM 1913)	00 through 15	Step 3 Set Value		
DM 0914 (DM 1914)	00 through 15	Step 4 Set Value		
DM 0915 (DM 1915)	00 through 15	Step 5 Set Value		
DM 0916 (DM 1916)	00 through 15	Step 6 Set Value		
DM 0917 (DM 1917)	00 through 15	Step 7 Set Value		
DM 0918 (DM 1918)	Not used			
DM 0919 (DM 1919)	Not used			

**Note** Set the rightmost two digits of the step patterns to 00 or to 11 or greater. Other values will not produce proper performance for high-frequency input pulses.

Word	Bit No.	Function	Default																													
DM 0920 (DM 1920)	00 through 07	RS-232C interface communication format 00 Standard setting 01 Individual setting Standard setting Start bit 1-bit Length of data 7 bits Parity even Stop bit 2-bit Baud rate 9600 bps	Standard setting																													
	08 through 15	RS-232C interface operation mode 00 Host Link 01 User memory download/upload 02 ASCII I/O	Host Link mode																													
DM 0921 (DM 1921)	00 through 07	RS-232C interface baud rate setting (This setting is valid only when DM 0920/DM 1920 bits 00 through 07 are 01.) 00 300 bps      01 600 bps 02 1200 bps    03 2400 bps* 04 4800 bps*   05 9600 bps*	When DM 0920/DM 1920 is 01 (individual setting) the baud rate is 300 bps.																													
	08 through 15	RS-232C interface frame format (This setting is valid only when DM 0920/DM 1920 bits 00 through 07 is 01.) <table border="1" style="margin: 10px auto;"> <thead> <tr> <th>Value</th> <th>Start bit</th> <th>Length of data</th> <th>Stop bit</th> <th>Parity</th> </tr> </thead> <tbody> <tr> <td>00</td> <td rowspan="6" style="text-align: center;">1 bit</td> <td>7 bits</td> <td>2 bits</td> <td>Even</td> </tr> <tr> <td>01</td> <td>7 bits</td> <td>2 bits</td> <td>Odd</td> </tr> <tr> <td>02</td> <td>8 bits</td> <td>1 bit</td> <td>None</td> </tr> <tr> <td>03</td> <td>8 bits</td> <td>2 bits</td> <td>None</td> </tr> <tr> <td>04</td> <td>8 bits</td> <td>1 bit</td> <td>Even</td> </tr> <tr> <td>05</td> <td>8 bits</td> <td>1 bit</td> <td>Odd</td> </tr> </tbody> </table>	Value	Start bit	Length of data	Stop bit	Parity	00	1 bit	7 bits	2 bits	Even	01	7 bits	2 bits	Odd	02	8 bits	1 bit	None	03	8 bits	2 bits	None	04	8 bits	1 bit	Even	05	8 bits	1 bit	Odd
Value	Start bit	Length of data	Stop bit	Parity																												
00	1 bit	7 bits	2 bits	Even																												
01		7 bits	2 bits	Odd																												
02		8 bits	1 bit	None																												
03		8 bits	2 bits	None																												
04		8 bits	1 bit	Even																												
05		8 bits	1 bit	Odd																												
DM 0922 (DM 1922)	00 through 07	RS-232C interface transfer delay time BCD (00 through 99) x 10 ms(0 through 990 ms)	0 ms																													
	08 through 15	RS-232C interface RS/CS control valid/invalid 00 invalid 01 valid	Invalid																													
DM 0923 (DM 1923)	00 through 07	Not used	0 Unit																													
	08 through 15	Unit number (Host Link mode) Units 0 through 31 are identified in BCD (00 through 31)																														
DM 0924 (DM 1924)	00 through 07	Not used	Intel HEX																													
	08 through 15	Transfer format (Application program mode) 00 Intel HEX format 01 Motorola S format																														
DM 0925 (DM 1925)	00 through 07	Starting Code This byte contains the starting code used in POUT(63) and PIN(64) when bits 08 to 15 contain 01.	No starting code																													
	08 through 15	Starting Code/No Starting Code Selection 00: No starting code 01: Starting code set in bits 00 to 07																														

Word	Bit No.	Function	Default
DM 0926 (DM 1926)	00 through 07	End Code This byte contains the end code used in POUT(63) and PIN(64) when bits 08 to 15 contain 01.	No end code
	08 through 15	<b>End Code/No End Code Selection</b> 00: No end code 01: End code set in bits 00 to 07	
DM 0927 to DM 0929 (DM 1927 to DM 1929)		Not used	-

\*Higher baud rates may produce errors in RS-232C communications if both RS-232C interface and Peripheral Interface Unit are used.

## 4-6 Error History

As an error occurs, information about the error (date, hour, minute, and second the error occurred, type of error, and the number of errors) is stored in the error storage area, words DM 0969 through DM 0999. Ten errors can be stored at a time, the tenth error being the most recent. Word AR 0969 records the number of errors.

Bit AR 0715 determines whether errors are stored or not. When bit AR 0715 is ON, error information is recorded in the error storage area. Because a maximum of ten errors can be stored at a time, the eleventh, twelfth, etc. errors are not recorded, unless the error history shift bit is ON. When this bit is ON, the ten errors are shifted to accommodate the new errors. The oldest error is discarded.

The following tables show the types of errors that occur and two categories of errors; errors and fatal errors. A fatal error refers to an error that has rendered the machine inoperable. At this time the machine must be reset. Errors that are not defined as fatal errors do not require the machine to be reset.

- Note**
1. The date, hour, minute, and second are stored in words AR 18 and 19. However, these words are only available in CPUs that have a realtime clock.
  2. If you are using a CPU with a realtime clock, make sure that the clock is set properly, otherwise the errors (date, hour, minute, and second) will be recorded in the error storage area incorrectly.

Fatal Error	Error Code
Memory error	F1
No END instruction	F0
I/O bus error	C0 through C3
I/O Unit table overflow	E1
System error (FALS)	01 through 99, 9F

Error	Error Code
Scan time overrun	F8
Battery error	F7
Specialized Unit error	D0
System error (FAL)	01 through 99

**Error History Word Allocation**

Access error information through words DM 0969 through DM 0999.

Word	Name	Content
DM 0969	Error counter	Indicates how many times the error occurred 0000 Error not registered or no errors occurred 0001 1 time to 000A 10 times
DM 0970	Error no. 1	Bit 00 through 07 Error code Bit 08 through 15 00 Operation error (not a fatal error) 80 System shutdown error  Example: 80F1 is a memory error The table above shows that the error code F1 is a memory error.
DM 0971		Bits 00 through 07 Second Bits 08 through 15 Minute
DM 0972		Bits 00 through 07 Hour Bits 08 through 15 Day
DM 0973	Error no. 3	same as Error no. 1
DM 0974		
DM 0975		
DM 0976	Error no. 4	same as Error no. 1
DM 0977		
DM 0978		
DM 0979	Error no. 5	same as Error no. 1
DM 0980		
DM 0981		
DM 0982	Error no. 6	same as Error no. 1
DM 0983		
DM 0984		
DM 0985	Error no. 7	same as Error no. 1
DM 0986		
DM 0987		
DM 0988	Error no. 8	same as Error no. 1
DM 0989		
DM 0990		
DM 0991	Error no. 8	same as Error no. 1
DM 0992		
DM 0993		
DM 0994	Error no. 9	same as Error no. 1
DM 0995		
DM 0996		
DM 0997	Error no. 10	same as Error no. 1
DM 0998		
DM 0999		

**Error History Shift Bit (AR 0713)**

The first ten errors that occurred during the operation of the machine are stored in words DM 0969 through DM 0999, error number ten being the most recent. Any errors that occur after the tenth error will not be stored.

By turning bit AR 0713 ON, the errors are shifted to accommodate the most recent error to create a record of the ten most recent errors. As shown in the following diagram, when the most recent error is stored the oldest error is discarded.

**Bit AR 0713**

- OFF The first ten errors are recorded. Any other error (eleventh, twelfth, etc.) are not recorded.
- ON The ten most recent errors are recorded.

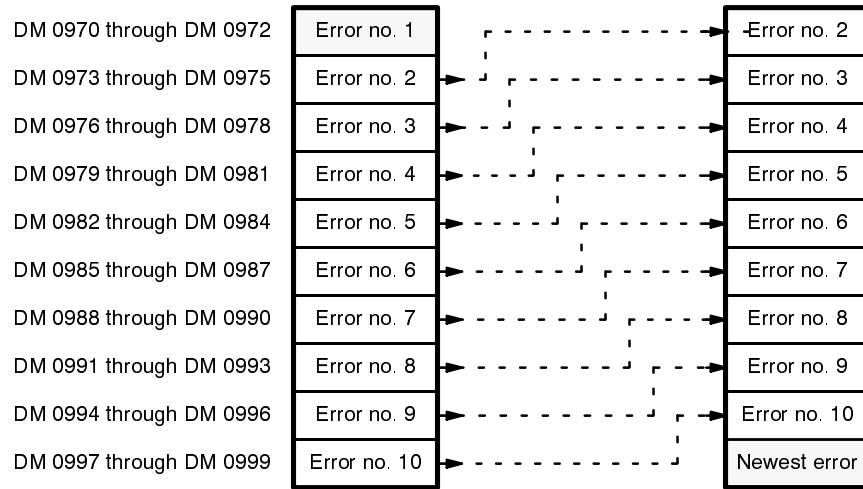

**Error Counter Initialization**

The number of errors that have occurred (up to ten) is stored in word DM 0969. To reset the error counter, turn bit AR 0714 OFF, ON and OFF again. Once AR 0714 is turned OFF, word DM 0969 is reset to 0000 and words DM 0970 through DM 0999 are initialized. Use the following table as a reference for remembering the function of the words and bits described in this section.

Word	Name	Function
AR 0713	Error history shift	OFF The first ten errors are recorded. Any other errors (eleventh, twelfth, etc.) are not recorded. ON The ten most recent errors are recorded.
AR 0714	Error counter initialize	Resets the error counter (DM 0969)
AR 0715	Error history storage initialize	ON Stores error information in word (DM 0970 through DM 0999) OFF Will not store error information
DM 0969	Error counter	Counts the number of errors
DM 0970 through DM 0999	Error history storage	Stores errors (up to ten)



## 4-7 User Program Header

If you are using a CPU with a realtime clock, the data in words DM 1195 through DM 1999 is set automatically if the program is rewritten or deleted.

If you are using a program that was created in a PC other than a Mini H-series PC, the date the program was created will not be renewed when it is transferred to a Mini-H series PC. The date is renewed only when the program is written, edited, or deleted using the Programming Console or when the program is written or deleted using the FIT or the Graphic Programming Console.

Word	Bit No.	Content												
DM 1990	00 through 07	Version number in BCD Example: 12 = Version 1.2												
	08 through 15	Indicates whether the title and version are valid or invalid. 5A valid Other invalid												
DM 1991 through DM 1994	00 through 15	Title of the program in ASCII code (up to eight characters) Example: LIN12-01 <table border="1" style="margin: 10px auto;"> <tr> <td>DM 1991</td> <td>DM 1992</td> <td>DM 1993</td> <td>DM 1994</td> </tr> <tr> <td>H L</td> <td>H L</td> <td>H L</td> <td>H L</td> </tr> <tr> <td>D7 B2</td> <td>DD 31</td> <td>32 2D</td> <td>30 31</td> </tr> </table> For more information about ASCII codes refer to the Mini H-series Operation Manual.	DM 1991	DM 1992	DM 1993	DM 1994	H L	H L	H L	H L	D7 B2	DD 31	32 2D	30 31
DM 1991	DM 1992	DM 1993	DM 1994											
H L	H L	H L	H L											
D7 B2	DD 31	32 2D	30 31											
DM 1995	00 through 07	Second the program was created												
	08 through 15	Minute the program was created												
DM 1996	00 through 07	Hour the program was created												
	08 through 15	Day the program was created												
DM 1997	00 through 07	Month the program was created												
	08 through 15	Year the program was created												
DM 1998 through DM 1999	00 through 15	Not used												

### Displaying the Program Header

Display the program header on Programming Console by pressing CLEAR and SHIFT plus MONITOR. The program header consists of the program title, version number, and date and time the program was created.

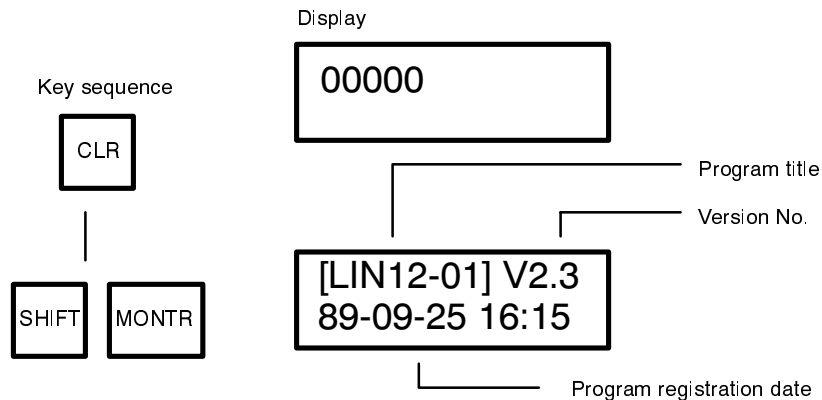

**Program title [LIN12-01]** The title of the program (up to eight characters) is stored in ASCII characters in words DM 1991 through DM 1994. In order to display the title of the program, make sure that the higher eight bits of word DM 1990 are set to 5A. Any setting other than 5A makes the title of the program invalid and displays the title as [\*\*\*\*\*].

**Version number V2.3** The version number is stored in BCD in the lower eight bits of DM 1990. Be sure that the higher eight bits of word DM 1990 are set to 5A, otherwise the version is invalid and displayed as [ - V\*. \*].

**Program registration date 89-09-25 16:15** The year, month, day, hour, minute and second is stored in words DM 1995 through DM 1997. The second, however, is not displayed.

# SECTION 5

## Installation Environment

This section details the necessary environment and conditions for installing the PC. For specific instructions on wiring for I/O and power refer to *Section 4 Wiring*.

5-1	Ambient Conditions .....	46
5-2	Cooling .....	46
5-3	Mounting Requirements .....	46
5-3-1	Peripheral Interface Unit .....	48
5-3-2	RS-232C Interface Connector (C20H/C28H/C40H) .....	48
5-3-3	C60H Mounting Height .....	49
5-4	DIN Rail Mounting .....	49
5-5	Duct Work .....	51
5-6	Preventing Noise .....	52

## 5-1 Ambient Conditions

Do not install the C20H/C28H/C40H/C60H in any of the following locations. Doing so will affect PC life and may affect operating performance.

- Locations subject to ambient temperatures lower than 0°C or higher than 55°C.
- Locations subject to drastic temperature changes or condensation.
- Locations subject to ambient humidity lower than 35% or higher than 85%.
- Locations subject to corrosive or flammable gases.
- Locations subject to excessive dust (especially iron dust) or chloride.
- Locations that would subject the CPU to direct shock or vibration.
- Locations that would subject the PC to water, oil, or chemical reagents.
- Locations exposed to direct sunlight.

## 5-2 Cooling

There are two points to consider in order to ensure that the PC does not overheat. The first is the clearance between Racks, and the second is installation of a cooling fan.

### Clearance Between Racks

The Units need to have sufficient room between them to allow for I/O wiring, and additional room to ensure that the I/O wiring does not hamper cooling. However, the Units must be mounted close enough so that the length of the Connecting Cable between any two Units does not exceed 10 m, and the total length of the Connecting Cables between all Units does not exceed 12 m. As a general rule, about 70 to 120 mm should be left between any two Units.

### Cooling Fan

A cooling fan is not always necessary, but may be needed if the PC is mounted in a warm or enclosed area or over a source of heat. Although it is best to avoid installing the PC in a warm area, use a cooling fan, as shown in the following illustration, to maintain the ambient temperature within specifications. Refer to *Appendix B Specifications* for specified temperatures.

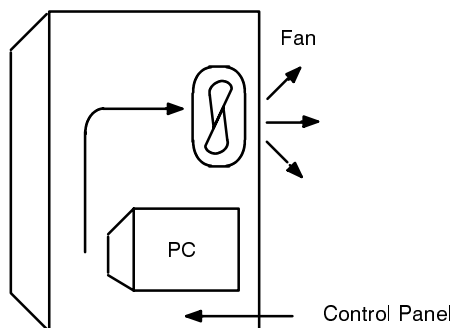

## 5-3 Mounting Requirements

The PC consists of from one to four Units. Mount the Units vertically, one above the other with the CPU uppermost, or horizontally, mounted left to right, as shown in the following illustrations. Do not mount a Unit on its side. The Unit should be mounted with the printing on the front panel oriented as it would normally be read. The PC can be mounted using a DIN Rail or mounted directly to any sturdy support meeting the environmental specifications listed in *Appendix B Specifications*. As you are mounting the Units, be sure to allow sufficient space for ventilation and maintenance.

Vertical Mounting

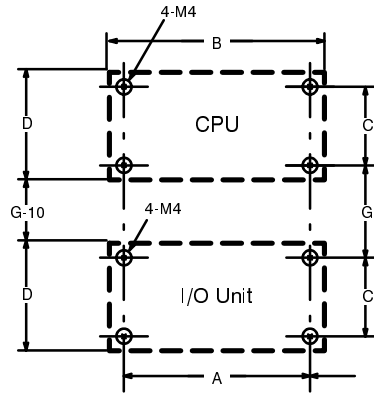

Horizontal Mounting

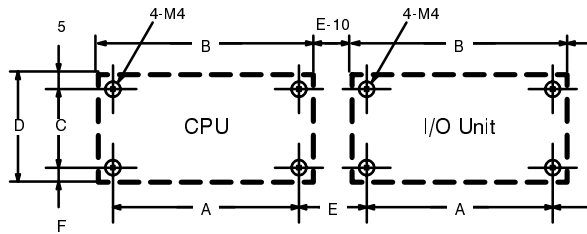

CPU or I/O Unit	A	B	C	D	E	F	G
C20H	240±0.2 mm	250 mm	120±0.2 mm	130 mm	15 to 40 mm	5 mm	80 to 130 mm
C28H	240±0.2 mm	250 mm	120±0.2 mm	130 mm	15 to 40 mm	5 mm	80 to 130 mm
C40H	290±0.2 mm	300 mm	120±0.2 mm	130 mm	15 to 40 mm	5 mm	80 to 130 mm
C60H	340±0.2 mm	350 mm	120±0.2 mm	140 mm	15 to 40 mm	15 mm	80 to 130 mm

Mounted without DIN Rail

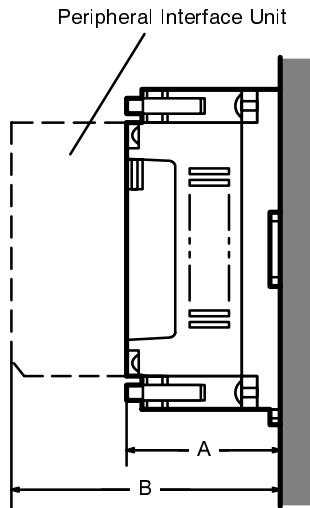

CPU	A	B
C20H/C28H/C40H	64	106
C60H	70	112

**Mounted with DIN Rail**

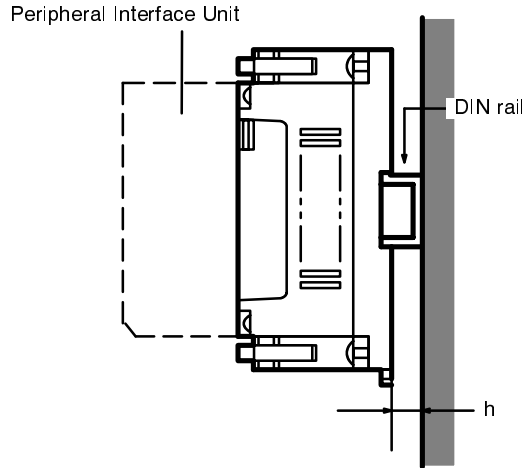

Rail	h
PFP-50N	3.3 mm
PFP-100N	
PFP-100N2	12 mm

**5-3-1 Peripheral Interface Unit**

When mounting the CPU, make sure to leave enough space for the Peripheral Interface Unit and the Console Adapter. The mounting requirements are shown in the following diagram.

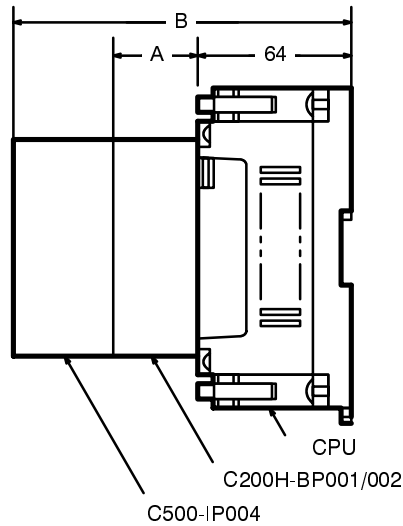

Model No.	A	B
C200H-BP001	30	136
C200H-BP002	50	156

**5-3-2 RS-232C Interface Connector (C20H/C28H/C40H)**

Provide the proper amount of space for the RS-232C connecting cable, as shown in the following diagram.

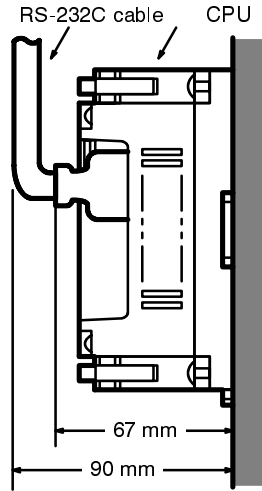

### 5-3-3 C60H Mounting Height

Provide the proper amount of space for the RS-232C connecting cable, Programming Console connecting cable, or the Expansion I/O Unit connecting cable as shown in the following diagram.

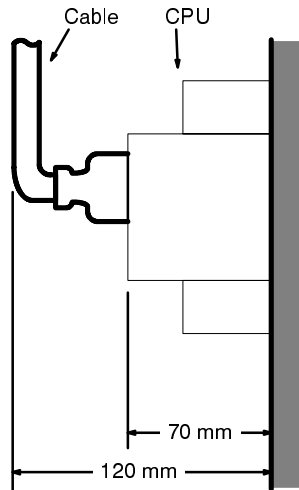

## 5-4 DIN Rail Mounting

All the items needed for mounting the PC using a DIN Rail are shown in the following illustrations. All dimensions are in millimeters unless stated otherwise.

**DIN Rails**  
**PFP-50N/PFP-100N**

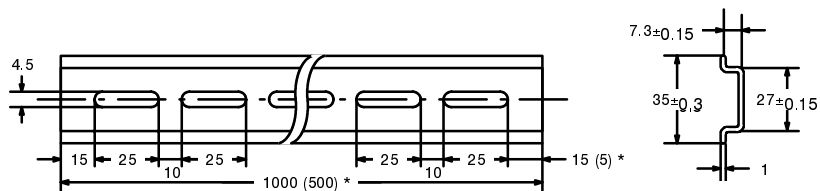

PFP-100N2

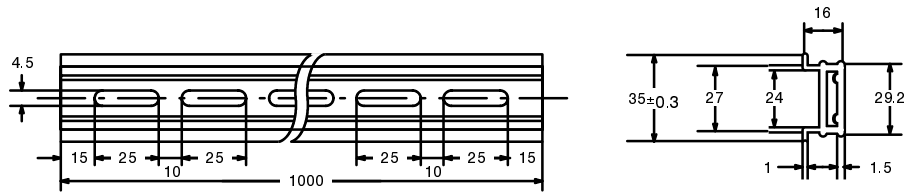

Model	L	*
PFP-50N	50 cm	5
PFP-100N	1 m	15
PFP-100N2	1 m	-

End Plate

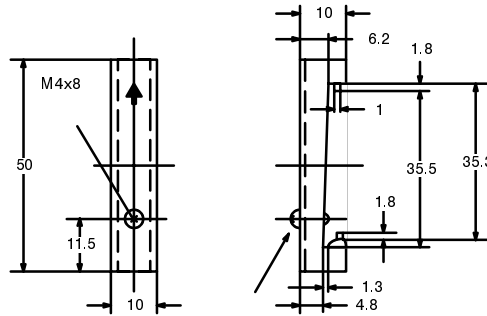

Spacer

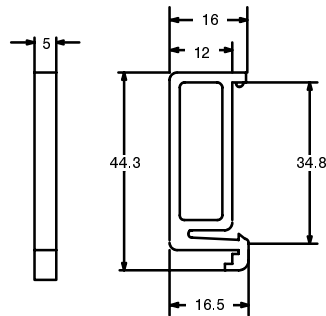

How to Mount Units to the DIN Rail

There is a groove on the back of the Unit that is used to attach the it to the DIN Rail. Attach an End Plate to the left and right sides of the Units. It is recommended that a Spacer be put between the CPU and Expansion I/O Units when they are mounted horizontally.

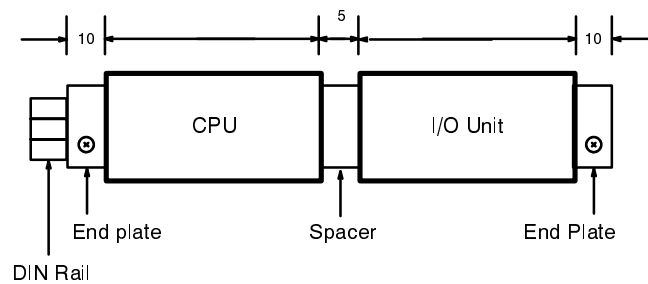

Mounting screws are included with CPUs, Expansion I/O Units, and Analog Timer Units.



## 5-5 Duct Work

If power cables carrying more than 10 A 400 VAC, or 20 A 220 VAC must be run alongside the I/O wiring (that is, parallel to it), allow at least 300 mm between the power cables and the I/O wiring as shown below.

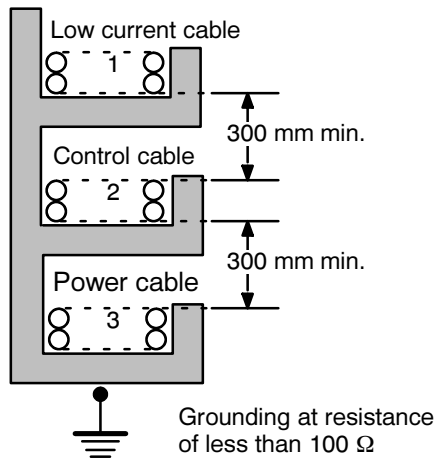

Where: 1 = I/O wiring  
 2 = General control wiring  
 3 = Power cables

If the I/O wiring and power cables must be placed in the same duct (for example, where they are connected to the equipment), they must be shielded from each other using grounded metal plates.

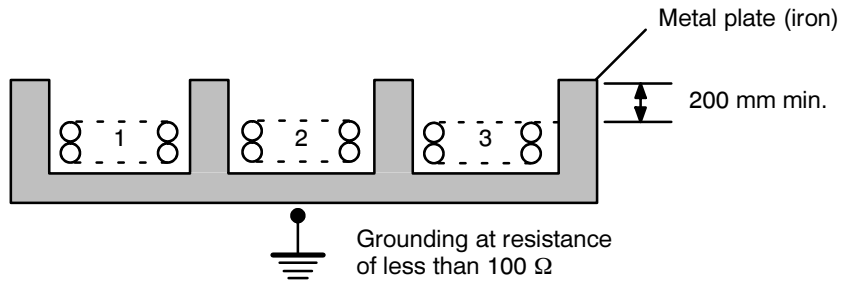

Where: 1 = I/O wiring  
 2 = General control wiring  
 3 = Power cables

## 5-6 Preventing Noise

In order to prevent noise from interfering with the operation of the PC, use AWG 14 twisted-pair cables (cross-sectional area of at least 2 mm<sup>2</sup>). Avoid mounting the PC close to high-power equipment, and make sure the point of installation is at least 200 mm away from power cables, as shown below.

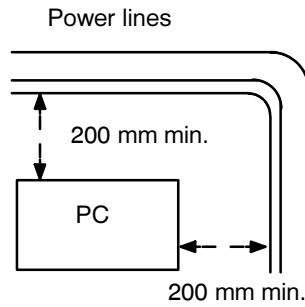

Whenever possible, use wiring conduit to hold the I/O wiring. Standard wiring conduit should be used, and it should be long enough to completely contain the I/O wiring and keep it separated from other cables.

# SECTION 6

## Wiring

This section provides information about wiring power supplies, grounding, and I/O wiring for the CPU and I/O Units. Use a commercially available 24 VDC power source. Expansion I/O Units, like the CPU, must also be connected to a power source.

6-1	Emergency Stop Circuit .....	54
6-2	Power Failure .....	54
6-3	I/O Connections .....	55
6-4	Wiring the Power Supply .....	56
6-5	Grounding .....	57
6-6	I/O Wiring .....	57
	6-6-1 CPUs .....	58
	6-6-2 I/O Units .....	59

## 6-1 Emergency Stop Circuit

Use an external relay to form an emergency stop circuit that turns the power to the PC OFF in the event of an emergency. An emergency stop routine in the PC program is not sufficient to ensure safety.

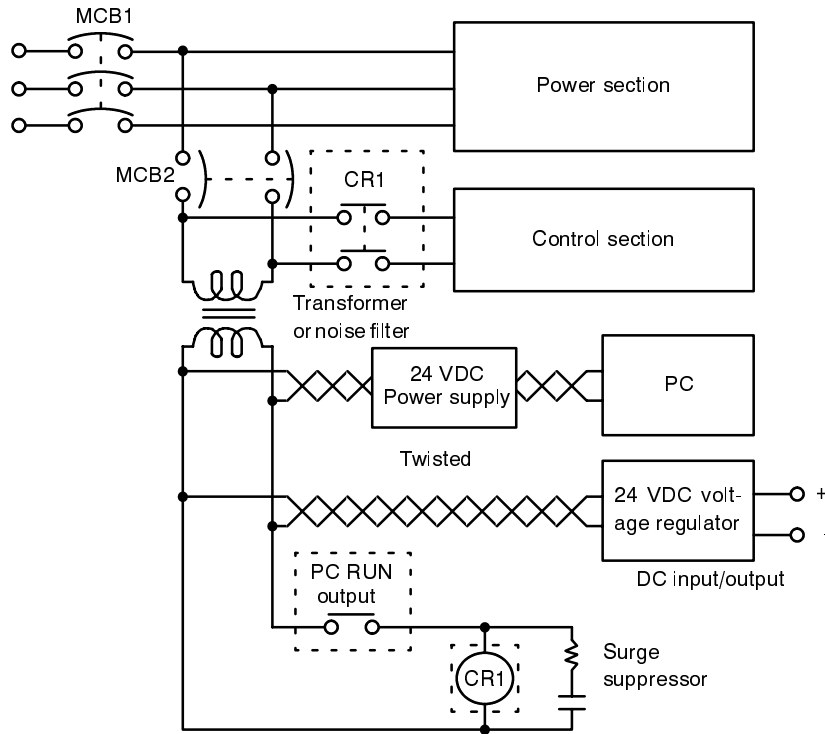

## 6-2 Power Failure

A sequential circuit is built into the PC to handle power interruptions. This circuit prevents malfunctions due to momentary power loss or voltage drops. A timing diagram for the operation of this circuit is shown below.

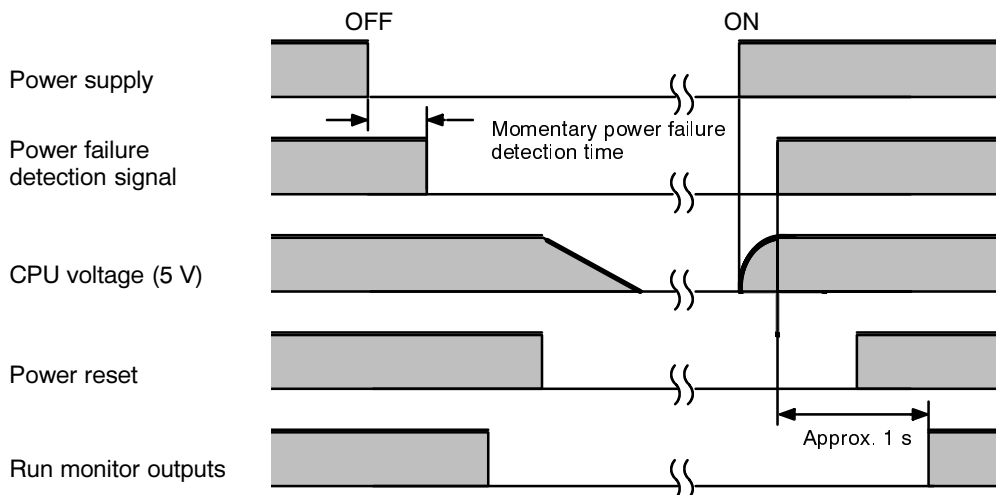

The PC ignores all momentary power failures if the interruption lasts no longer than 0.3 ms. If the interruption is longer than 1 ms, the PC stops operating and the external outputs are automatically turned OFF. Operation resumes automatically when the voltage is restored to more than 85% of the rated value.

## 6-3 I/O Connections

Connect the I/O Devices to the I/O Units using AWG 22 (cross-sectional area of  $0.3 \text{ mm}^2$ ) for 19-terminal terminal blocks and AWG 22 to 18 lead wire (cross-sectional area of  $0.3$  to  $0.75 \text{ mm}^2$ ) for 10 terminal terminal blocks. The terminals have screws with M3.5 heads and pressure plates. Connect the lead wires to the terminals as shown below. Tighten the screws with a torque of 8 kg-cm maximum.

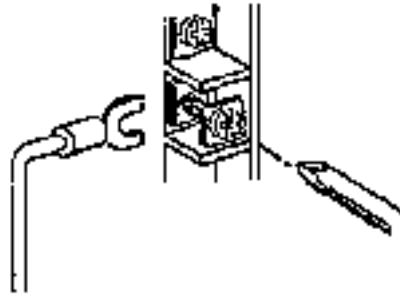

If you wish to attach solderless type terminals to the ends of the lead wires, use terminals having the following dimensions.



### Terminal Block

The terminal blocks located at the top and bottom of the Units are removable. After wiring make sure that the terminal block is securely connected to the Unit.

## 6-4 Wiring the Power Supply

Use a commercially available 24 VDC power source for the CPU. Expansion I/O Units must also be connected to a power source. Where possible use independent power sources for the inputs, the output loads, and the CPU. Use one power supply to supply power to the PC. If the CPU and an I/O Unit are connected to separate power supplies, the CPU (as well as the Programming Console) will not operate unless power is supplied the I/O Unit.

The following illustration shows the proper way to connect a power supply to the PC. Although the power consumption for each Unit is lower than 20 W (25 W for C60H), the rush current is approximately 20 to 30 A when the power is turned OFF and then ON again. When choosing the power supply for your Unit, make sure it can sustain the momentary rush of current.

24 VDC power source  
Be sure to keep the voltage fluctuations within the proper range; 20.4 through 26.4 VDC

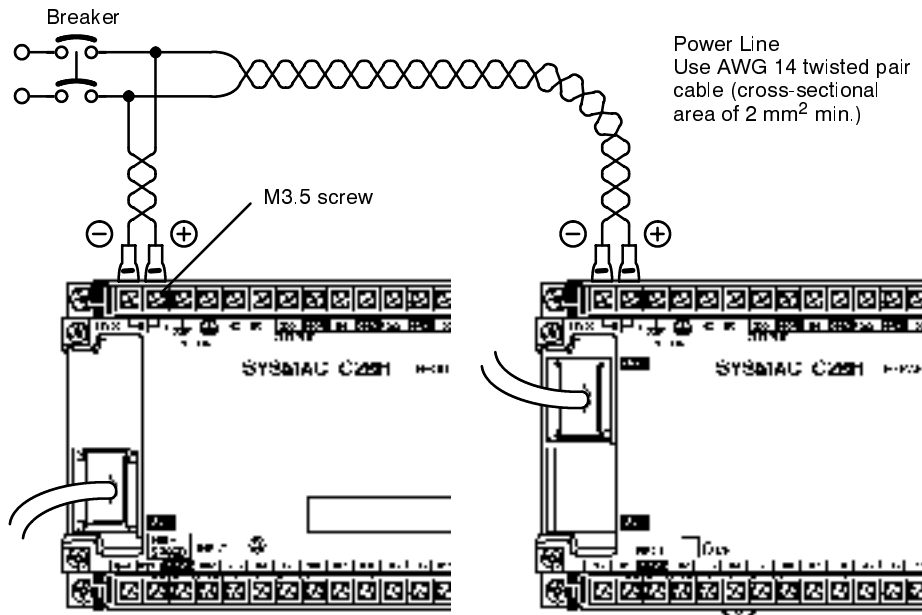

**Note** Do not short the positive and negative lines.

## 6-5 Grounding

The Line Ground (LG) terminal is a noise-filtered neutral terminal that does not normally require grounding. However, if electrical noise is a problem, connect the Line Ground terminal to the Ground (GR) terminal.

To avoid electrical shock, attach a grounded (earth ground) AWG 14 wire (cross-sectional area of at least 2 mm<sup>2</sup>) to the GR terminal. The resistance to ground must be less than 100 Ω. Do not use a wire longer than 20 m. Care must be taken, because ground resistance is affected by environmental conditions such as soil composition, water content, time of year, and the length of time since the wire was laid underground.

PC operation may be adversely affected if the ground wire is shared with other equipment, or if the ground wire is attached to the metal structure of a building. When using an I/O Unit, the Unit must also be grounded to the GR terminal. The same ground can be used for all connections.

**Note** Ground the PC separately from peripheral devices.

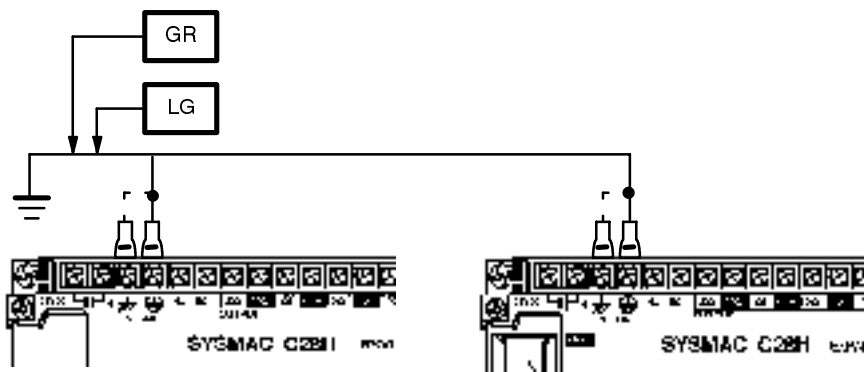

## 6-6 I/O Wiring

The following diagrams show the correct way to wire the terminals on the CPU and the I/O Unit. The C40H CPU and I/O Units are used to show connections for the C20H/C28H/C40H CPU and I/O Units, with differences indicated as necessary. When wiring, work carefully to ensure that all terminals are wired correctly. The DC inputs in the following diagrams are NPN (positive common). Reverse the polarity if PNP (negative common) is used.

The Mini H-type PCs use either relays or transistors for output. Models using relays require a load power supply of 250 VAC/24 VDC maximum; models using transistors require a load power supply of 5 to 24 VDC maximum. Make sure that you do not use more than one relay in the same common circuit, so that the relays work independently of each other and never use different types of relays connected to the same common.

When using the High-speed Counter instruction (HDM(61)), wire input IN/0 as the High-speed Counter input and input RST/1 as the hardware reset input. If the High-speed Counter is not used, inputs IN/0 and RST/1 may be used as general input terminals, however the response time will be shorter than other terminals (0.15 ms).

**Note** Do not wire the terminals marked "NC."

### 6-6-1 CPUs

#### C20H/C28H/C40H (C\_D\_-DE-V1)

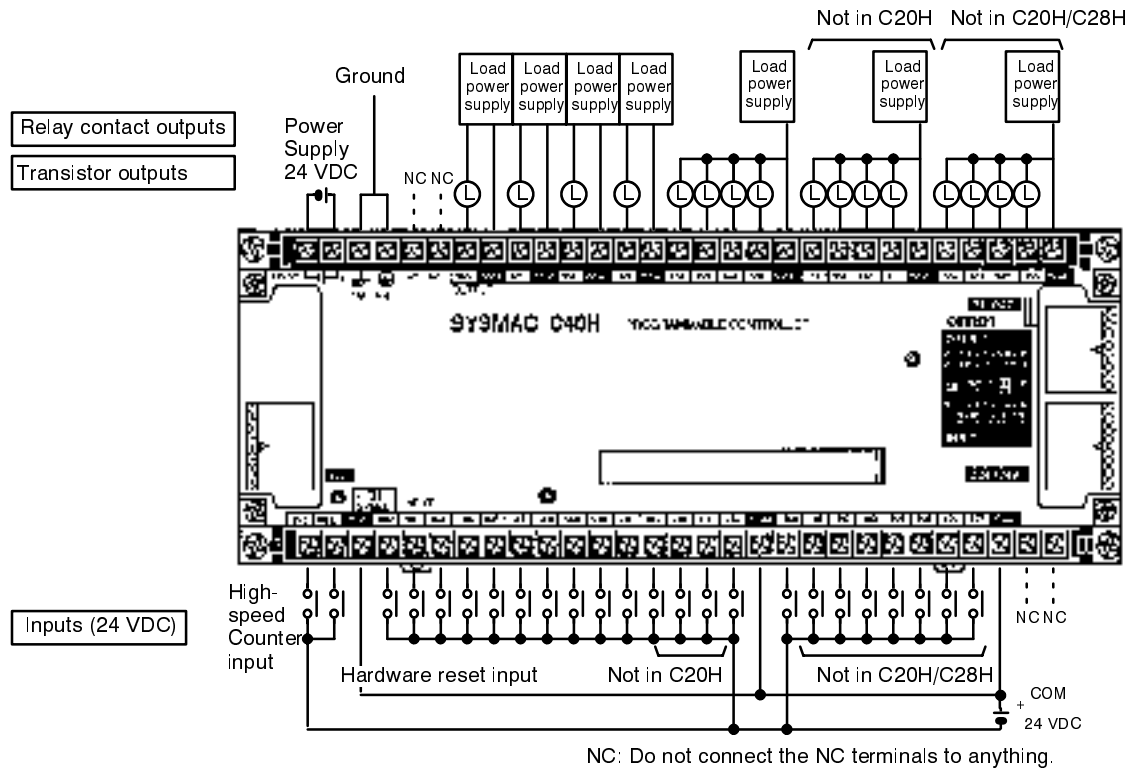

#### C60H (C\_D\_-DE-V1)

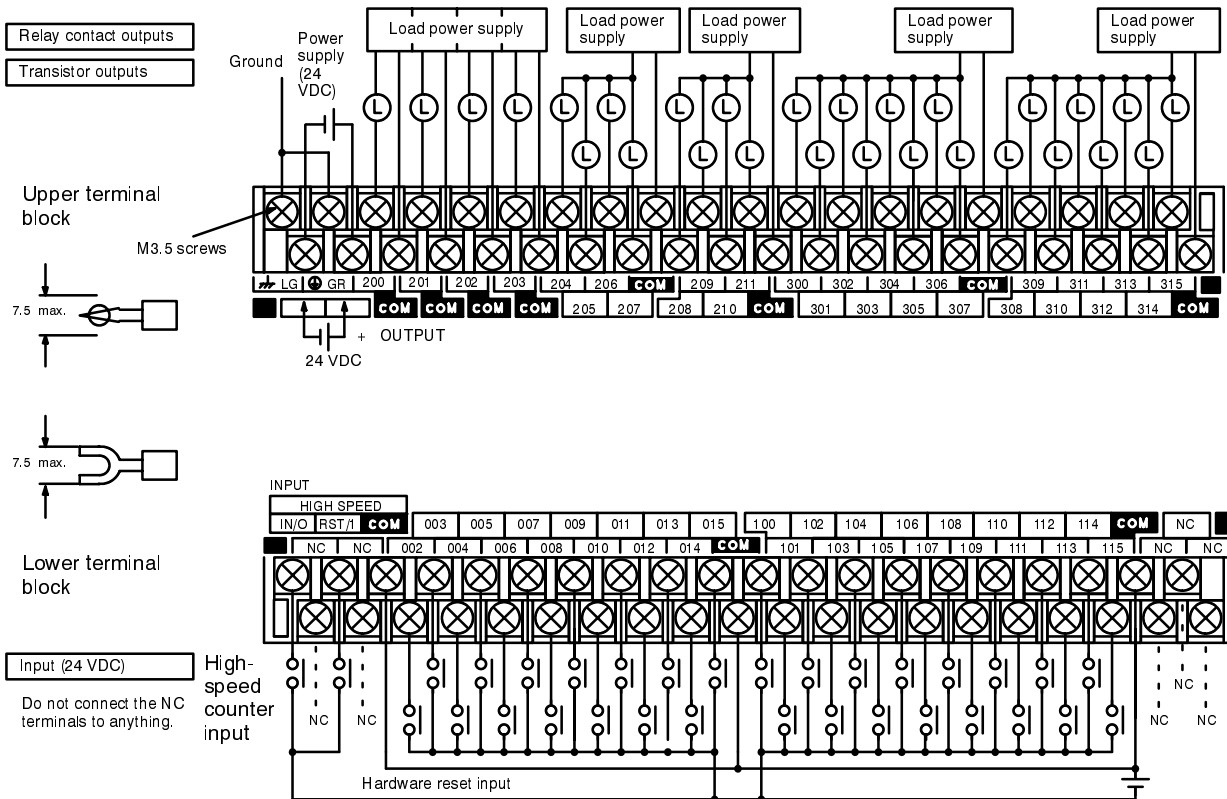





# SECTION 7

## Safety Considerations

There are certain safety requirements to consider when installing the PC, such as the emergency stop circuit, that are part of the initial wiring. This section provides additional items that should be kept in mind when operating the PC and connecting I/O devices.

7-1	Special Wiring Precautions .....	62
7-2	Input Wiring .....	64
7-3	Output Wiring .....	64
7-4	Wiring Examples .....	68

## 7-1 Special Wiring Precautions

### Emergency Stop Circuit

To prevent a CPU breakdown or malfunction from damaging the entire system, construct an external relay circuit so that SR bit 25313 is always open when the CPU is operating. If the program is set up as shown in the following diagram, output 0200 will be ON whenever the CPU is in either RUN or MONITOR mode, and it will function as an output to monitor whether the CPU is operating properly. Refer to *Section 6 Wiring* for a wiring example.

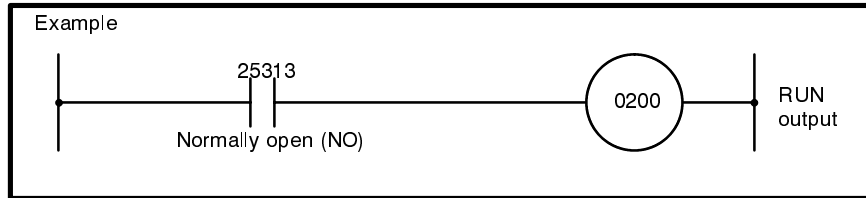

### Interlock Circuits

When the PC controls an operation such as the clockwise and counterclockwise operation of a motor, provide an external interlock such as the one shown below to prevent both the forward and reverse outputs from turning ON at the same time. Even if the PC is programmed improperly or malfunctions, the motor is protected.

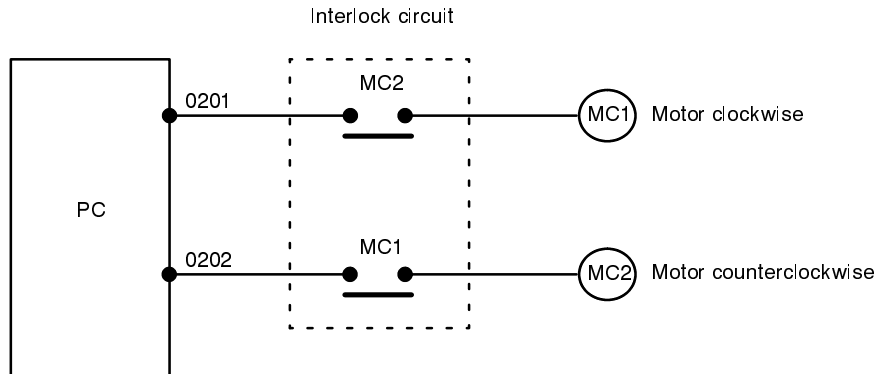

### Electrical Noise

Be sure to take the appropriate measures when any electrical device likely to produce noise is connected to the PC as a load. Any device generating noise of more than 1,200 V (such as electromagnetic relays and valves) requires noise suppression. For noise sources running off of AC power, connect a diode in parallel with the coil of each device.

When mounting Units to the same mounting plate, make sure that the mounting plate is solidly grounded and the mounting plate is plated with a highly conductive surface.

### Precautions for Surge Current

Transistors and triacs are able to withstand a surge of current of ten times the rated current. However, when connecting a resistor or triac output to a device that allows a high surge current to flow, the current may exceed the rated current, causing damage to the triac or transistor. Use one of the circuits shown below to reduce the inrush current.

This circuit allows a slight current (about 1/3 the rated current) to flow through the load (i.e., the lamp), thus eliminating any initial surge of current.

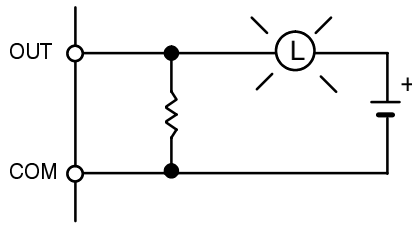

This circuit acts directly on the inrush current to limit it, but also reduces the voltage across the load.

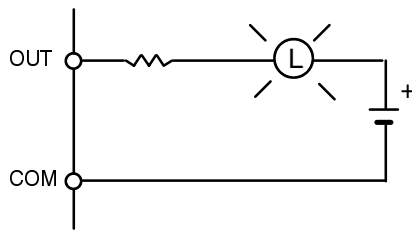

**Transistor Output Residual Voltage**

When connecting TTL circuits to transistor outputs, it is necessary to connect a pull-up resistor and a CMOS IC between the two because of the transistor's residual voltage.

**Inductive Load Surge Suppressors**

When an inductive load is connected to the input or output of the CPU Unit, it is necessary to connect a surge suppressor or a diode in parallel with the load, as shown below, to absorb the counter-electromotive force produced by the load.

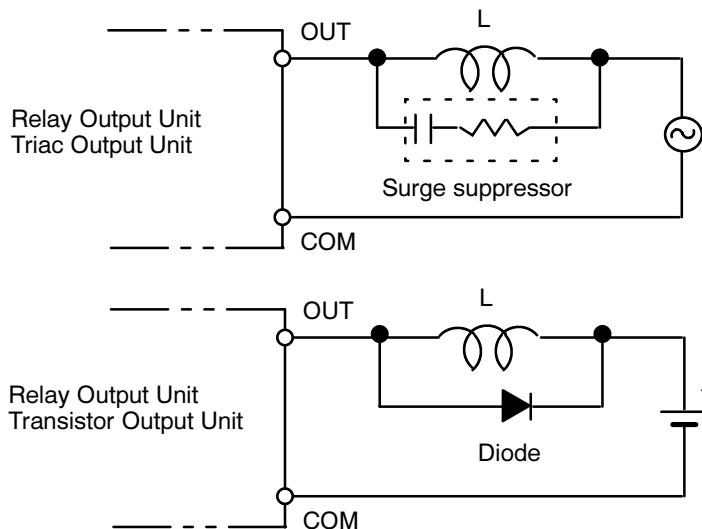

## 7-2 Input Wiring

Either NPN or PNP inputs can be used. Whenever the polarity of the Units is changed, make sure to check the polarity of the input devices.

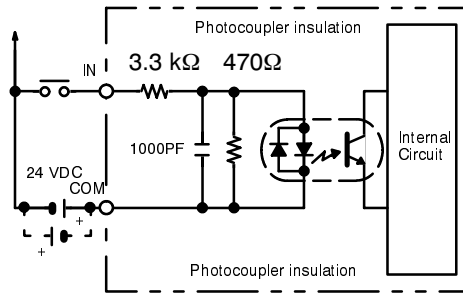

### Input Leakage Current

When two-wire sensors, such as photoelectric sensors, proximity sensors, or limit switches with LEDs, are connected to the PC as input devices, the input bit may be turned ON erroneously by leakage current. In order to prevent this, connect a bleeder resistor across the input as shown below.

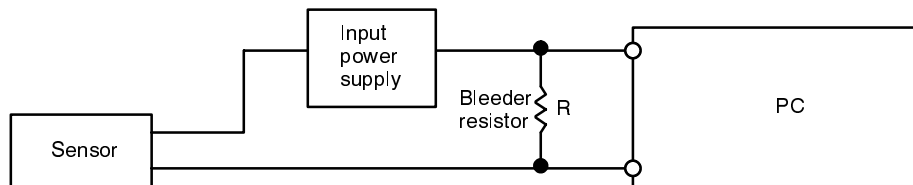

If the leakage current is less than 1.5 mA, there should be no problem. If the leakage current is greater than 1.5 mA, determine the value and rating for the bleeder resistor using the following formulas.

$I$  = leakage current in mA  
 $R$  = Bleeder resistor kW  
 $W$  = Bleeder resistor Watts

$$R = \frac{17.15}{3.43 \times I - 5} \text{ k}\Omega \text{ max.}$$

$$W = \frac{2.3}{R} \text{ W min.}$$

## 7-3 Output Wiring

Listed below are a few items to keep in mind when wiring outputs.

- When connecting the output devices, use a fuse to protect the printed circuit board from a power surge.
- Do not put output wires near high-voltage power lines. Doing so may cause a malfunction or may damage output devices and the Units.
- When using the High-speed Counter, the response time may be delayed up to 15 ms, because of the ON/OFF response time of the relay. If a quicker response is needed, use a transistor relay.
- The durability of a relay depends on the amount of current passing through it, the temperature, and the switching capacity. At higher temperatures and higher switching capacities the durability is lowered by as much as 50 percent.

- If the switching capacity is too high when using a mechanical relay, replace the relay with a transistor or triac relay, as shown in the following diagrams. Each relay is connected to the printed circuit board by a socket. Be sure not to combine different types of relays in the same circuit. Refer to *Appendix B Specifications* for triac and transistor relay specifications
- When connecting TTL circuits to transistor outputs, it is necessary to connect a pull-up resistor and a CMOS IC between the two because of the transistor's residual voltage.

**Output Specifications**

Models are available with either relay contact or transistor output specifications. Either transistor relay or triac relays can be used for models with relay contact outputs, which are equipped with sockets. Refer to *Appendix B Specifications* for details.

**Relay Contact Outputs (With Sockets)**

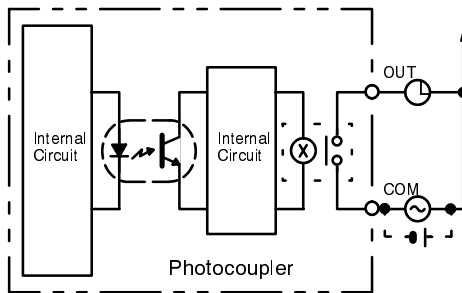

**Transistor Outputs (Without Sockets)**

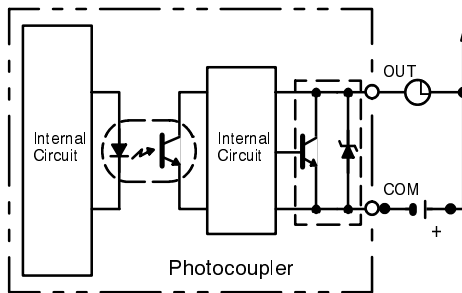

**Transistor Relays**

**NPN (negative common)  
G3SD-Z01P(-PD)-US(24 VDC)**

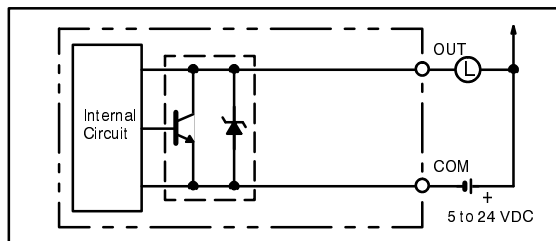

**PNP (positive common)  
G3SD-Z01P-PE-US(24 VDC)**

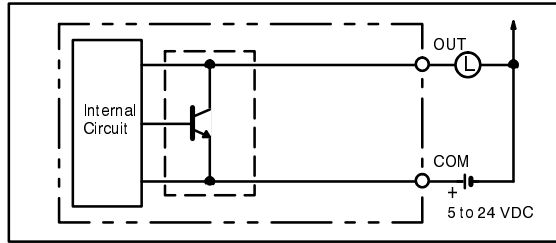

**Triac Relays**

**G3S-201PL(-PD)-US(24 VDC)**

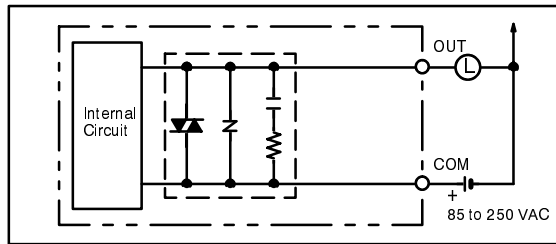

**Transistor Surge Current**

Be sure to stay with half the maximum values shown in the following graph when wiring transistor outputs.

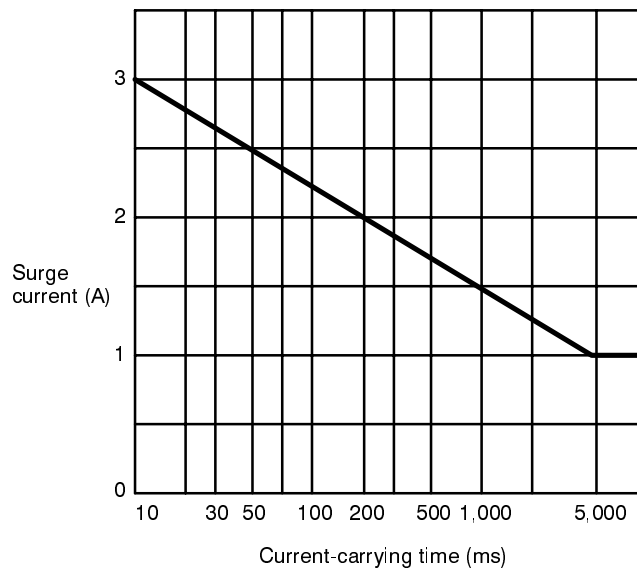

**Triac Surge Current**

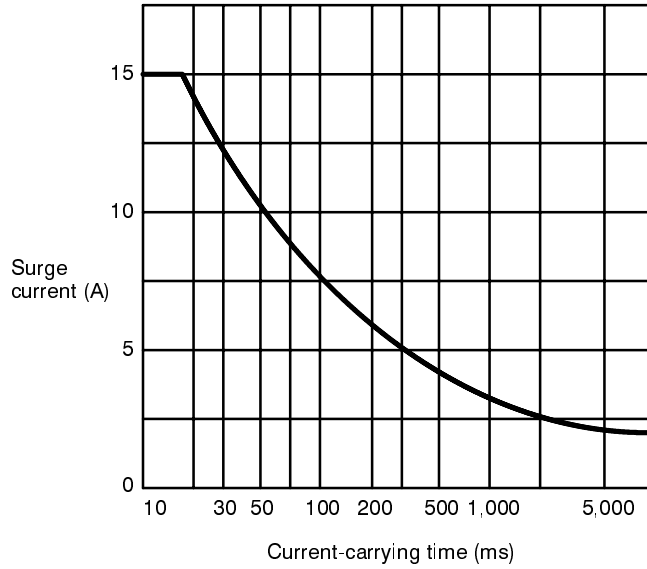

**Transistor and Triac Maximum Switching Capacity**

**G3SD-Z01P-PD-US  
G3S-201PL-PD-US**

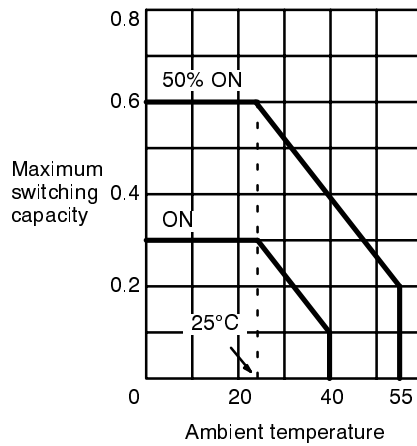

**G3SD-Z01P(-PE)-US  
G3SD-201-PL-US**

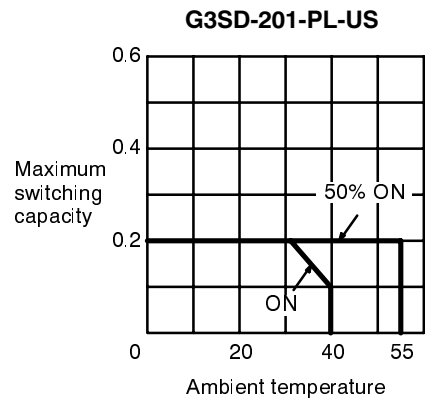
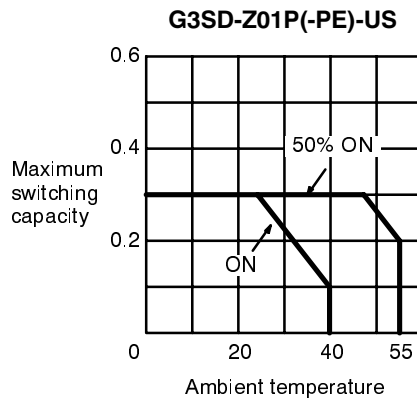



**Output Leakage Current**

If there is a possibility of leakage current causing a transistor or triac to malfunction, connect a bleeder resistor across the output as shown below.

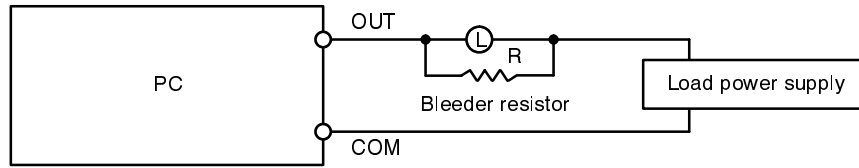

Determine the value and rating for the bleeder resistor using the following formula.

$$R < \frac{E_{on}}{I}$$

Where

$E_{on}$  = ON voltage of the load

$I$  = leakage current in mA

## 7-4 Wiring Examples

The following are examples of how to connect I/O devices to I/O Units. During wiring, work slowly and carefully. If an input device is connected to an Output Unit, damage may result. Check all I/O devices to make sure they meet the specifications (refer to *Appendix B Specifications*).

### DC Input Units

Contact output

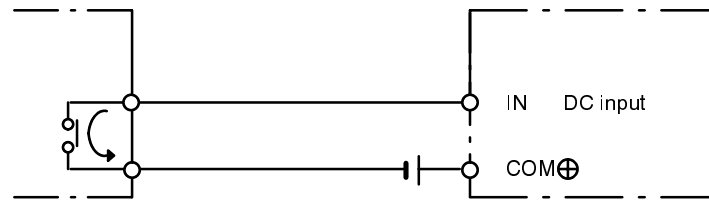

When using the configuration shown below, the sensor and Input Unit should receive their power from the same supply.

NPN current output

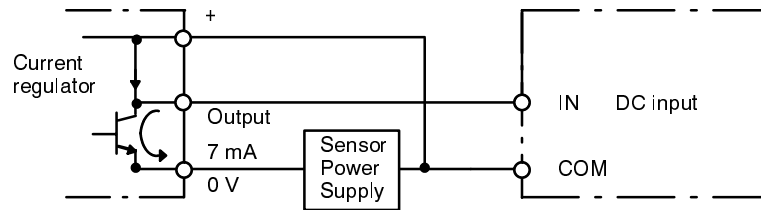

NPN open-collector output

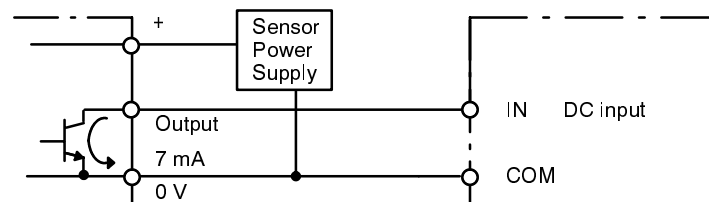

PNP current output

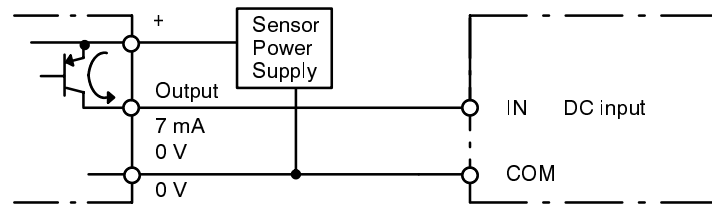

The circuit below should be used for I/O devices having a voltage output.

Voltage output

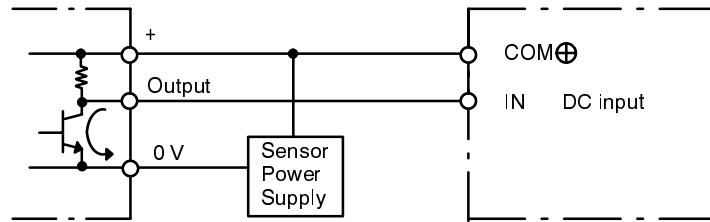

The circuit below should **NOT** be used for I/O devices having a voltage output.

Voltage output

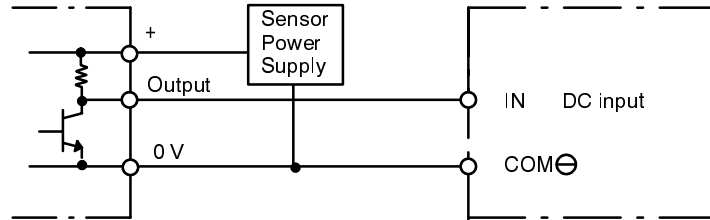

**High-speed Counter Input Devices (Rotary Encoder)**

The High-speed Counter device can be used as incremental rotary encoder. Wiring examples are shown as follows.

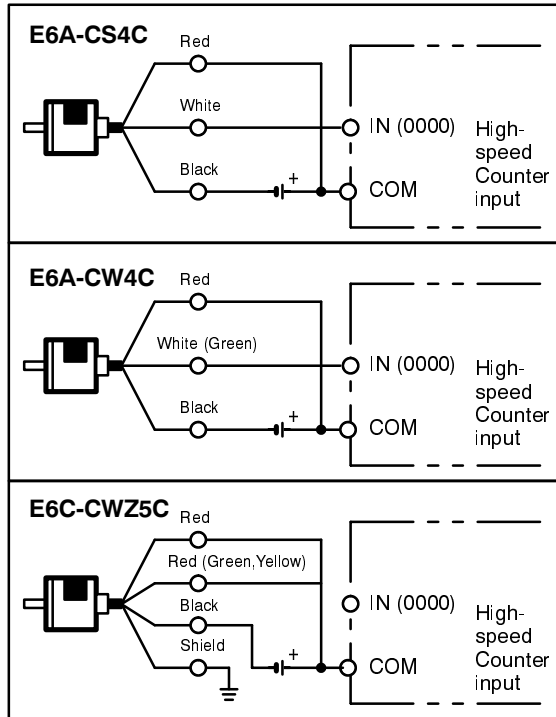

# Appendix A

## Standard Models

### CPUs

Name	Power supply	Inputs	Outputs	Memory*	Clock	Model number				
C20H	24 VDC	12, 24-VDC inputs 2 commons One with 2 pts. One with 10 pts.	8 relay outputs with sockets  5 commons 4 with 1 pt. each 1 with 4 pts.	RAM	None	C20H-C1DR-DE-V1				
				IC socket		C20H-C2DR-DE-V1				
				EEPROM		C20H-C3DR-DE-V1				
				RAM	Built in	C20H-C5DR-DE-V1				
				IC socket		C20H-C6DR-DE-V1				
				EEPROM		C20H-C7DR-DE-V1				
			8 transistor outputs without sockets  5 commons 4 with 1 pt. each 1 with 4 pts.	RAM	None	C20H-C1DT-DE-V1				
				IC socket		C20H-C2DT-DE-V1				
				EEPROM		C20H-C3DT-DE-V1				
				RAM	Built in	C20H-C5DT-DE-V1				
				IC socket		C20H-C6DT-DE-V1				
				EEPROM		C20H-C7DT-DE-V1				
				C28H	24 VDC	16, 24-VDC inputs 2 commons One with 2 pts. One with 14 pts.	12 relay outputs with sockets  6 commons 4 with 1 pt. each 2 with 4 pts.	RAM	None	C28H-C1DR-DE-V1
								IC socket		C28H-C2DR-DE-V1
EEPROM	C28H-C3DR-DE-V1									
RAM	Built in	C28H-C5DR-DE-V1								
IC socket		C28H-C6DR-DE-V1								
EEPROM		C28H-C7DR-DE-V1								
12 transistor outputs without sockets  6 commons 4 with 1 pt. each 2 with 4 pts.	RAM	None	C28H-C1DT-DE-V1							
	IC socket		C28H-C2DT-DE-V1							
	EEPROM		C28H-C3DT-DE-V1							
	RAM	Built in	C28H-C5DT-DE-V1							
	IC socket		C28H-C6DT-DE-V1							
	EEPROM		C28H-C7DT-DE-V1							
	C40H	24 VDC	24, 24-VDC inputs 3 commons One with 2 pts. One with 8 pts. One with 14 pts.				16 relay outputs with sockets  7 commons 4 with 1 pt. each 3 with 4 pts.	RAM	None	C40H-C1DR-DE-V1
								IC socket		C40H-C2DR-DE-V1
EEPROM				C40H-C3DR-DE-V1						
RAM				Built in	C40H-C5DR-DE-V1					
IC socket					C40H-C6DR-DE-V1					
EEPROM					C40H-C7DR-DE-V1					
16 transistor outputs without sockets  7 commons 4 with 1 pt. each 3 with 4 pts.				RAM	None	C40H-C1DT-DE-V1				
				IC socket		C40H-C2DT-DE-V1				
				EEPROM		C40H-C3DT-DE-V1				
				RAM	Built in	C40H-C5DT-DE-V1				
				IC socket		C40H-C6DT-DE-V1				
				EEPROM		C40H-C7DT-DE-V1				

Name	Power supply	Inputs	Outputs	Memory*	Clock	Model number		
C60H	24 VDC	32, 24-VDC inputs 3 commons One with 2 pts. One with 14 pts. One with 16 pts.	28 relay outputs with sockets	RAM	None	C60H-C1DR-DE-V1		
				IC socket		C60H-C2DR-DE-V1		
				EEPROM		C60H-C3DR-DE-V1		
			8 commons	4 with 1 pt. each	2 with 4 pts.	RAM	Built in	C60H-C5DR-DE-V1
						IC socket		C60H-C6DR-DE-V1
						EEPROM		C60H-C7DR-DE-V1
			28 transistor outputs without sockets	8 commons	4 with 1 pt. each	RAM	None	C60H-C1DT-DE-V1
						IC socket		C60H-C2DT-DE-V1
						EEPROM		C60H-C3DT-DE-V1
			4 with 1 pt. each	2 with 4 pts.	2 with 8 pts.	RAM	Built in	C60H-C5DT-DE-V1
						IC socket		C60H-C6DT-DE-V1
						EEPROM		C60H-C7DT-DE-V1

\*CPUs with IC sockets are not provided with Memory Chips; one of those listed in the following table must be ordered separately. The memory in other types of CPUs cannot be changed.

## Memory Chips

Memory chips can be set on on CPU models equipped with I/O sockets.

Name	Specifications	Model number
EPROM Chip	2764, 200 ns, write voltage: 12.5 V	ROM-HB-B
	27128, 200 ns, write voltage: 12.5 V	ROM-IB-B
	27128, 150 ns, write voltage: 12.5 V	ROM-ID-B
	27256, 150 ns, write voltage: 12.5 V	ROM-JD-B
RAM Chip	6264, 150 ns	RAM-H
EEPROM Chip	28C64, 200 ns	EEROM-H

### Note

Only 27128 EPROM chips (ROM-I\_-B) can be used if writing via the FIT's PROM writer or via the C500-PRW06 connected to the GPC.

## I/O Units

Name	Power supply	Inputs	Outputs	Accessories	Model number
C20H	24 VDC	12, 24-VDC inputs 2 commons One with 2 pts. One with 10 pts.	8 relay outputs with sockets 5 commons 4 with 1 pt. each 1 with 4 pts.	C20H-CN311 Connecting Cable included.	C20H-EDR-D
			8 transistor outputs without sockets 5 commons 4 with 1 pt. each 1 with 4 pts.		C20H-EDT-D
C28H	24 VDC	16, 24-VDC inputs 2 commons One with 2 pts. One with 14 pts.	12 relay outputs with sockets 6 commons 4 with 1 pt. each 2 with 4 pts.	C20H-CN311 Connecting Cable included.	C28H-EDR-D
			12 transistor outputs without sockets 6 commons 4 with 1 pt. each 2 with 4 pts.		C28H-EDT-D

Name	Power supply	Inputs	Outputs	Accessories	Model number
C40H	24 VDC	24, 24-VDC inputs 3 commons One with 2 pts. One with 8 pts. One with 14 pts.	16 relay outputs with sockets 7 commons 4 with 1 pt. each 3 with 4 pts.	C20H-CN311 Connecting Cable included.	C40H-EDR-D
			16 transistor outputs without sockets 7 commons 4 with 1 pt. each 3 with 4 pts.		C40H-EDT-D
C60H	24 VDC	32, 24-VDC inputs 3 commons One with 2 pts. One with 14 pts. One with 16 pts.	28 relay outputs with sockets 8 commons 4 with 1 pt. each 2 with 4 pts. 2 with 8 pts.	C20H-CN311 Connecting Cable included.	C60H-EDR-D
			28 transistor outputs without sockets 8 commons 4 with 1 pt. each 2 with 4 pts. 2 with 8 pts.		C60H-EDT-D

## Ordering Information

**Memory Chips** Order the CPU Unit depending on the type of memory your application requires: RAM, EEPROM or EPROM. RAM and EEPROM models are delivered with chips already mounted. If you are ordering a CPU Unit with an IC socket, the memory chip must be ordered separately and mounted by the user.

**CPU** Order the CPU according to the number of I/O points, the type of memory, and the optional realtime clock. CPU are also available with either relay contact outputs (with sockets) or transistor outputs (without sockets). These specifications cannot be changed after the CPU is delivered. Refer to *Appendix B Standard Models* for a list of the models and combinations available.

**Expansion I/O Unit** I/O Units are available with 20, 28, 40, or 60 I/O points. I/O Units are also available with either relay contact outputs (with sockets) or transistor outputs (without sockets). Up to three Expansion I/O Units can be connected to one CPU Unit. Refer to *Appendix B Standard Models* for a list of the models available.

The following figure explains the significance of the numbers and letters in the CPU and I/O Unit model numbers.

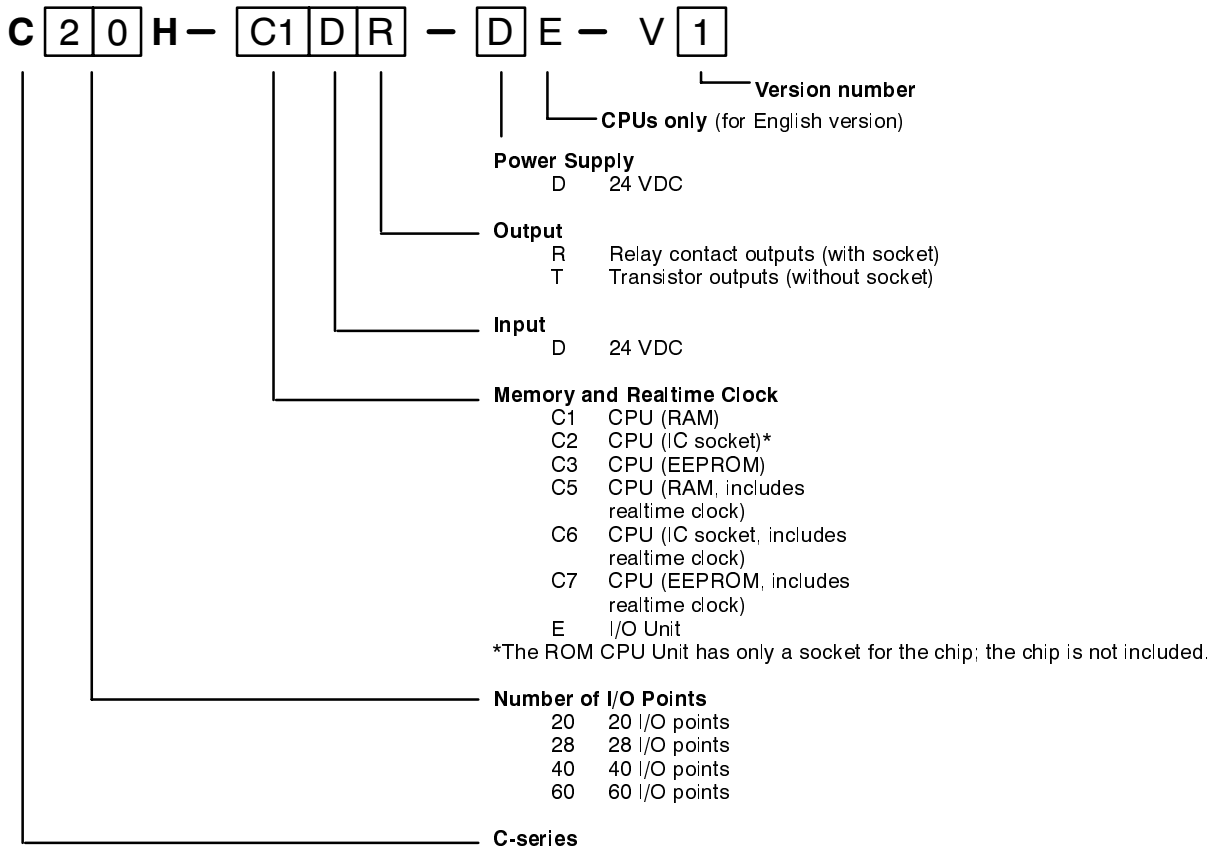

## Optional and Consumable Parts

Name	Specifications	Model No.	
Battery Set	Backup battery for RAM	C200H-BAT09	
Relay	24 VDC	G6B-1174P-FD-US	
Transistor Relay	24 VDC, NPN positive common	0.3 A	G3SD-Z01P-US
		0.6 A	G3SD-Z01P-PD-US
	24 VDC, PNP negative common	0.3 A	G3SD-Z01P-PE-US
Triac Relay	24 VDC	0.2 A	G3S-201PL-US
		0.6 A	G3S-201PL-PD-US
Terminal Block Cover	for C20H and C28H, 10 covers/pack	C20P-COV01	
	for C40H, 10 covers/pack	C40P-COV02	

## DIN Products

Product	Specifications	Model No.
DIN Track Mounting Bracket	1 set (1 bracket included)	C200H-DIN01
DIN Track	Length: 50 cm; height: 7.3 mm	PFP-50N
	Length: 1 mm; height: 7.3 mm	PFP-100N
	Length: 1 m; height: 16 mm	PFP-100N2
End Plate	-	PFP-M
Spacer	-	PFP-S

## Peripheral Devices

Product	Description	Model No.	
Programming Console	Vertical, w/backlight Connecting cable required; sold separately	C200H-PR027-E	
Data Access Console	Vertical, w/backlight Connecting cable required; sold separately	C200H-DAC01	
Programming and Data Access Console Connecting Cable	For Handheld console, 2 m	C200H-CN222	
	For Handheld console, 4 m	C200H-CN422	
Panel Mounting Bracket	For Handheld Programming Console or Data Access Console	C200H-ATT01	
Cassette Tape Recorder Connecting Cable	1 m	SCYP0R-PLG01	
PROM Writer	For C-series PCs (12.5/21 V)	C500-PRW06	
Floppy Disk Interface Unit	For C-series PCs	3G2C5-FDI03	
Printer Interface Unit	For C-series PCs	3G2A5-PRT01-E	
Memory Pack (for Printer Interface)	-	C2000-MP103-EV3	
Printer Connecting Cable	2 m	SCY-CN201	
CPU-mounting Host Link Unit	Connects to optical fiber cable (APF/PCF)	3G2A6-LK101-PEV1	
	Connects to optical fiber cable (PCF)	3G2A6-LK101-EV1	
	RS-232C	3G2A6-LK201-EV1	
	RS-422	3G2A6-LK202-EV1	
Peripheral Interface Unit	For connecting PC to GPC Connecting cable required; sold separately	C200H-IP006	
Connecting Cable	To connect GPC to Peripheral Interface Unit	2 m	3G2A2-CN221
		5 m	C500-CN523
		10 m	C500-CN131
		20 m	C500-CN 231
		30 m	C500-CN331
		40 m	C500-CN431
		50 m	C500-CN531
Graphic Programming Console	100 to 120 VAC, w/comment	3G2C5-GPC03-E	
CRT Interface Unit	For connection between GPC and CRT	3G2C5-GDI01	
Programming Console Base Unit	Required to mount 3G2A6-LK__-(P)EV1 to C20H or C28H CPU.	30 m	C200H-BP001
		50 m	C200H-BP002
FIT	Factory Intelligent Terminal	FIT 10-SET11-E	

## SYSMAC Support Software (SSS)

Name	Specifications	Model number
SYSMAC Support Software	3.5" 2HD floppy disk for IBM PC/AT or compatible	C500-ZL3AT1-E



## I/O Connecting Cables

The connectors may be difficult to attach to the cables. Therefore, always leave a little extra length when cutting the cable. The lengths and models numbers for I/O Connecting Cables are shown in the table below.

Model No.	Cable length
C20H-CN311	30 cm
C20H-CN611	60 cm
C20H-CN121	1 m
C20H-CN221	2 m

When connecting additional I/O Units to the PC, one I/O Connecting Cable is needed to connect one Unit to the next Unit. The total length of connecting cable should not exceed 6 m.

If the cable must go through a hole, for example in through a duct, the hole must be a minimum of 40 mm in diameter.

**Note**

Do not stretch the cable with more than 5 kilograms of force. When pulling the connector from the Unit, do not pull the connector with more than 20 kilograms of force.

# Appendix B Specifications

## General Ratings

Supply voltage		24 VDC	
Operating voltage range		20.4 to 26.4 VDC	
Power consumption		C20H/C28H/C40H: 20 W max.; C60H: 25 W max.	
Insulation resistance		20 M $\Omega$ min. (at 500 VDC) between AC and GR terminals	
Dielectric strength		2,000 VAC 50/60 Hz for 1 minute (between AC and GR terminals) 1,000 VAC 50/60 Hz for 1 minute (between DC and GR terminals)	
Noise immunity		1,000 V p-p, pulse width: 100 ns to 1 $\mu$ s, rise time 1 ns	
Vibration		10 to 35 Hz, 1 mm double amplitude, in X, Y, and Z directions: 2 hours each. (When mounted on a DIN rail: 16.7 Hz, 1 mm double amplitude, in X, Y, and Z directions, 1 hour each.)	
Shock		10 G in X, Y, and Z directions, 3 times each	
Ambient temperature		Operating      0° to 55°C Storage        -20° to 65°C	
Humidity		35% to 85% (non-condensing)	
Grounding		Less than 100 $\Omega$	
Construction		Conforms to IEC IP-30 (when panel-mounted)	
Weight	CPU	C20H/C28H	1.2 kilograms max.
		C40H	1.3 kilograms max.
		C60H	1.8 kilograms max.
	I/O Unit	C20H/C28H	1 kilogram max.
		C40H	1.1 kilograms max.
		C60H	1.6 kilograms max.
Dimensions (CPUs and I/O Units)		C20H/C28H	250 x 130 x 64 mm (WxHxD)
		C40H	300 x 130 x 64 mm (WxHxD)
		C60H	350 x 140 x 70 mm (WxHxD)

# Input/Output Specifications

## CPUs and I/O Units with Relay Contact Outputs (with Sockets)

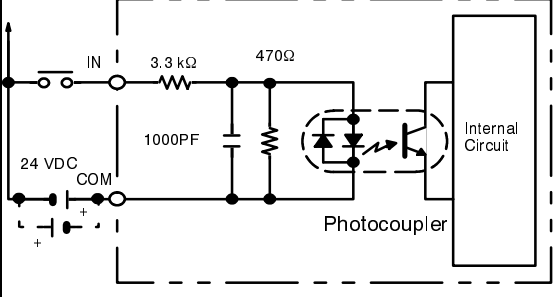
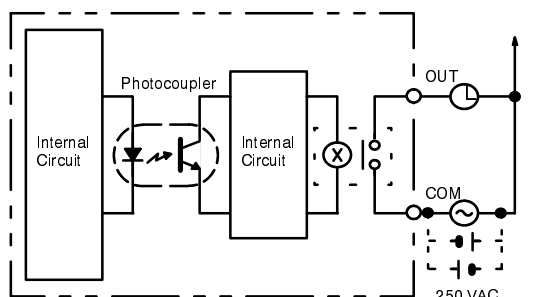
Item	DC Input				Relay Contact Output			
Input voltage	24 VDC +10%/-15%				-			
Input impedance	3.3 kΩ				-			
Input current	7 mA typical at 24 VDC				-			
ON voltage	16 VDC min.				-			
OFF voltage	5 VDC max.				-			
ON delay time	2.5 ms max. (input 00000,00001 on CPUs: 0.15 ms max.)				15 ms max.			
OFF delay time	2.5 ms max. (input 00000,00001 on CPUs: 0.15 ms max.)				15 ms max.			
Number of circuits	C20H	C28H	C40H	C60H	C20H	C28H	C40H	C60H
	12 pts 2 pts/com 10 pts/com 1 circuit each	16 pts 2 pts/com 14 pts/com 1 circuit each	24 pts 2 pts/com 8 pts/com 14 pts/com 1 circuit each	32 pts 2 pts/com 14 pts/com 16 pts/com 1 circuit each	8 pts 1 pt/com 4 circuits 4 pts/com 1 circuit	12 pts 1 pt/com 4 circuits 4 pts/com 2 circuits	16 pts 1 pt/com 4 circuits 4 pts/com 3 circuits	28 pts 1 pt/com 4 circuits 4 pts/com 2 circuits 8 pts/com 2 circuits
	When using the High-speed Counter, the 2 pts per common circuit is used for the High-speed Counter input and Hardware Reset on the CPU.				-			
Maximum switching capacity	-				Resistance load 250 VAC/ 2 A(cos of phase angle = 1) or 24 VDC/ 2 A for each pt, 4 A/common(4 pts/common) Inductive load 250 VAC/0.5 A(cos of phase angle = 0.4)/pt			
Minimum switching capacity	-				5 VDC, 10 mA			
Relay durability	-				Resistance load, Electrical 300,000 times Mechanical 50,000,000 times Inductive load Electrical 100,000 times Mechanical 50,000,000 times Use relay G6B-1174P-FD-US, 24 VDC			
Circuit configuration	 <p>24 V DC power supply can be connected to a positive common or a negative common.</p>				 <p>A separate load power supply is required. Use relay G6B-1174P-FD-US, 24 VDC</p>			

**CPUs and I/O Units with Transistor Outputs (without Sockets)**

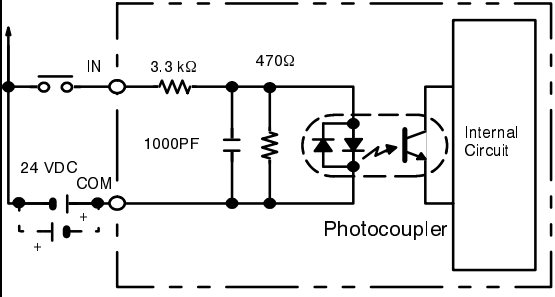
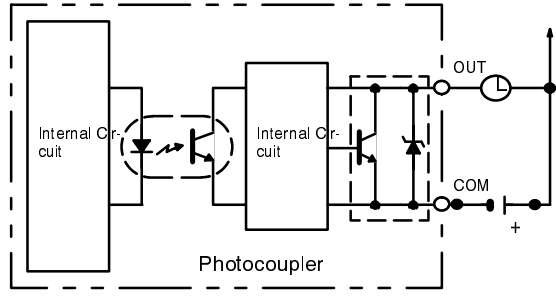
Item	DC Input				Relay Contact Output			
Input voltage	24 VDC +10%/-15%				-			
Input impedance	3.3 kΩ				-			
Input current	7 mA typical at 24 VDC				-			
ON voltage	16 VDC min.				-			
OFF voltage	5 VDC max.				-			
ON delay time	2.5 ms max. (input 00000,00001 on CPUs: 0.15 ms max.)				15 ms max.			
OFF delay time	2.5 ms max. (input 00000,00001 on CPUs: 0.15 ms max.)				15 ms max.			
Number of circuits	C20H	C28H	C40H	C60H	C20H	C28H	C40H	C60H
	12 pts 2 pts/com 10 pts/com 1 circuit each	16 pts 2 pts/com 14 pts/com 1 circuit each	24 pts 2 pts/com 8 pts/com 14 pts/com 1 circuit each	32 pts 2 pts/com 14 pts/com 16 pts/com 1 circuit each	8 pts 1 pt/com 4 circuits 4 pts/com 1 circuit	12 pts 1 pt/com 4 circuits 4 pts/com 2 circuits	16 pts 1 pt/com 4 circuits 14 pts/com 3 circuits	28 pts 1 pt/com 4 circuits 4 pts/com 2 circuits 8 pts/com 2 circuits
	When using the High-speed Counter, the 2 pts per common circuit is used for the High-speed Counter input and Hardware Reset on the CPU.				-			
Maximum switching capacity	-				0.6 A at 5 to 24 VDC (affected by ambient temperature; refer to 7-3 Output Wiring for details)			
Minimum switching capacity	-				5 VDC, 10 mA			
Leakage current	-				0.1 mA max.			
Circuit configuration	 <p>24 V DC power supply can be connected to a positive common or a negative common.</p>				 <p>A separate load power supply is required. Relay G3SD-Z01P (24 VDC) is used (no socket).</p>			

## CPU Specifications

Control Method	Stored program
I/O Control Method	Cyclical scan
Programming method	Ladder diagram
Instruction length	1 address/instruction, 1 to 4 words/instruction
Number of instructions	142 (12 basic instructions, 130 special instructions)
Execution time	Basic instructions 0.75 to 2.25 $\mu$ s
Memory Capacity	2,878 words
I/O bits	20 to 240 (00000 through 03915) The number of I/O bits depends on the number of Units
IR bits	3,472 (0400 through 24615)
SR bits	136 (24700 through 25507) Normally ON, normally OFF, Battery error, 0.1 s clock, 0.2 s clock, 1.0 s clock, etc.
HR bits	1,600 (HR 0000 through 9915)
TR bits	8 (TR 0 through 7)
AR bits	448 (AR 0000 through 2715)
LR bits	1,024 (LR 0000 through 6315)
Timers/Counters	512 (TIM/CNT 000 through 511) TIMs 0 through 999.9 s TIMHs 0 through 99.99 s CNT 0 through 999 counts When using the High-speed Counter, CNT 511 is the present value area.
High-speed Counter	Counter input 00000 Hardware input reset 00001 Maximum response frequency 2 kHz Preset count range 0000 through 9999 Number of outputs 16
DM words	Read/write 1000 words (DM 0000 through DM 0999) Read only 1000 words (DM 1000 through DM 1999) Words DM 0900 through DM 0999 and DM 1900 through DM 1999 are allocated as the system setting area.
Memory protection	The data in HR, AR, CNT, and DM areas is protected by a battery. If the battery is running low, discharged or removed, the data will be lost.
Battery life	5 years at 25°C Battery life is shortened at temperatures higher than 25°C. Replace the battery within one week when the ALM ERR LED blinks.
Self diagnostic features	CPU failure (watchdog timer) I/O bus failure Host Link error Memory error Battery error, etc.
Program check	Program checked (executed at the beginning of a RUN operation) END instruction missing Instruction error The program can also be checked with a Programming Console or GPC. The program can be checked at three levels.
RS-232C interface	Communications: Half-duplex Sync: Start-stop Baud rates: 300, 600, 1200, 2400, 4800, 9600 bps Transmission distance: 15 m max.
Real-time clock (On specific models only)	Provides year, month, date, day, hour, minutes, seconds. Adjusts for leap year and backed up by battery. Accuracy: Within 30 seconds a month at 25°C.

## Transistor and Triac Specifications

Item	Transistor		Triac	
	G3SD-Z01P(-PE)-US	G3SD-Z01P-PD-US	G3S-201PL-US	G3S-201PL-PD-US
Model	G3SD-Z01P(-PE)-US	G3SD-Z01P-PD-US	G3S-201PL-US	G3S-201PL-PD-US
Maximum switching capacity	0.3 A at 5 through 24 VDC	0.6 A at 5 through 24 VDC	0.2 A at 85 through 250 VAC	0.6 A at 85 through 250 VAC
Minimum switching capacity	10 mA at 5 VDC		10 mA at 100 VAC/20 mA at 200 VAC	
Leakage current	100 $\mu$ A max.		2 mA at 100 VAC max/5 mA at 200 VAC max.	
ON response time	1.5 ms max.		1.5 ms max.	
OFF response time	1.5 ms max.		1/2 of load frequency + 1 ms max.	

## Dimensions (mm)

### CPUs

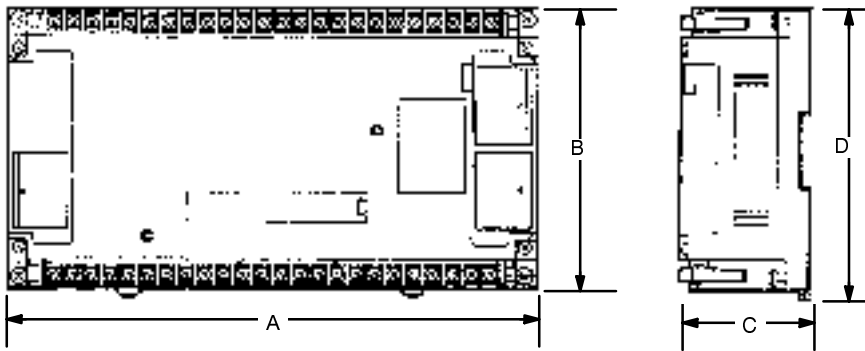

Model	A	B	C	D	Weight
C20H	250 mm	130 mm	64 mm	134 mm	1.2 kilogram
C28H	250 mm	130 mm	64 mm	134 mm	1.2 kilogram
C40H	300 mm	130 mm	64 mm	134 mm	1.3 kilogram
C60H	350 mm	140 mm	70 mm	144 mm	1.8 kilogram

### I/O Units

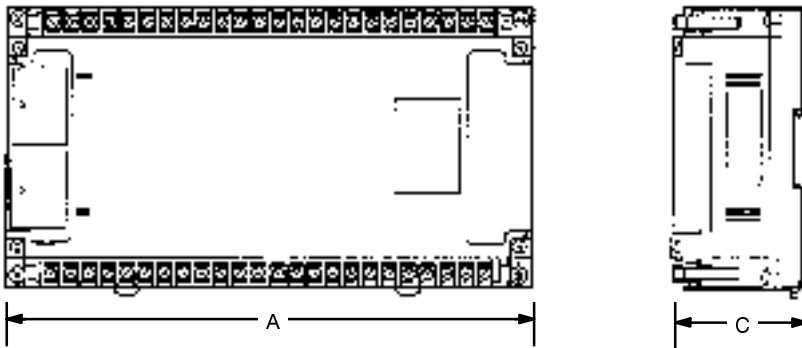

Model	A	B	C	D	Weight
C20H	250 mm	130 mm	64 mm	134 mm	1 kilogram
C28H	250 mm	130 mm	64 mm	134 mm	1 kilogram
C40H	300 mm	130 mm	64 mm	134 mm	1.1 kilogram
C60H	350 mm	140 mm	70 mm	144 mm	1.6 kilogram

I/O Connecting Cables

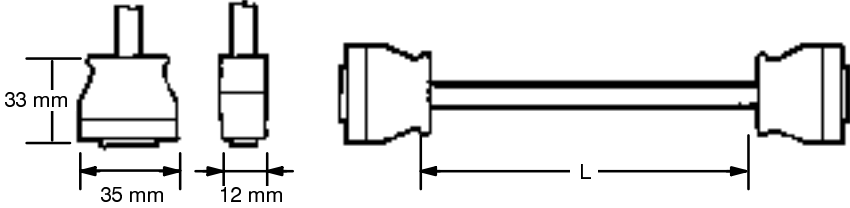

Model	Cable length
C20H-CN311	30 cm
C20H-CN611	60 cm
C20H-CN121	1 m
C20H-CN221	2 m

# Appendix C

## Inspection and Maintenance

Some consumable items in a PC, such as relays and batteries, need occasional replacement. This Appendix provides instructions on how to replace these items. Always keep spare parts on hand for immediate replacement. The specifications for the items mentioned in this section can be found in *Appendix A Specifications*.

### How to Replace Relays

- 1, 2, 3...
1. Turn the power to the PC OFF.
  2. Use a Phillips screwdriver to loosen the four screws on the front panel of the CPU Unit. Remove the cover from the Unit, lifting it from the left.

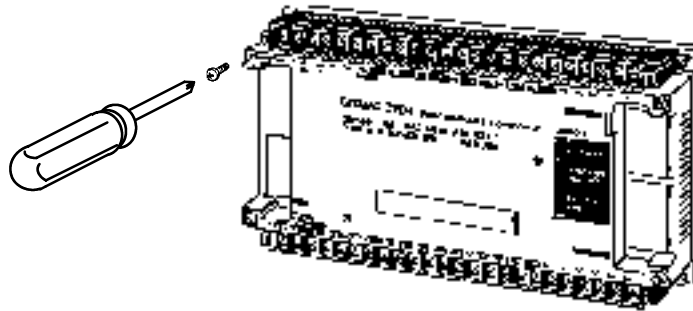

3. Using a relay puller, remove the defective relay and replace it with a new relay. The relay puller is stored on the backside of the front panel of the CPU Unit, near the battery.

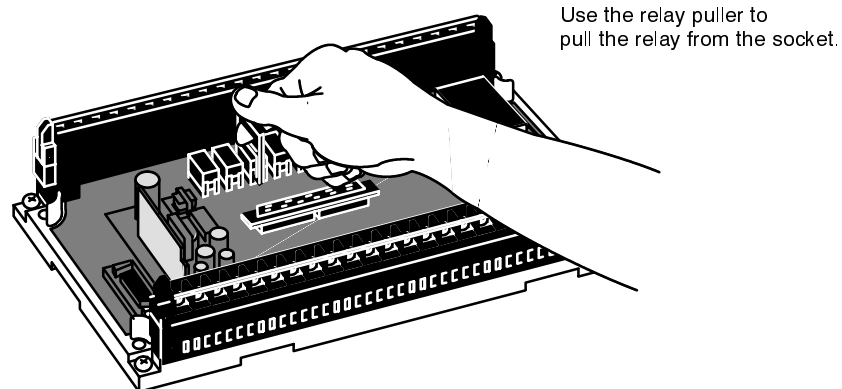
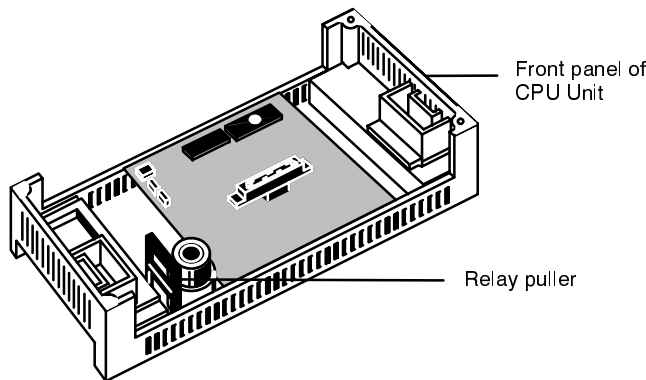

4. Replace the front panel, positioning it over the Unit and firmly pressing on the center of the cover until the internal connectors are mated.



The relays are arranged on the printed circuit board as follows.

**C20H**

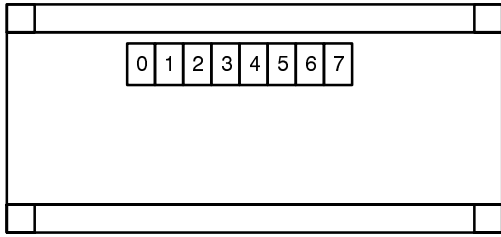

**C28H**

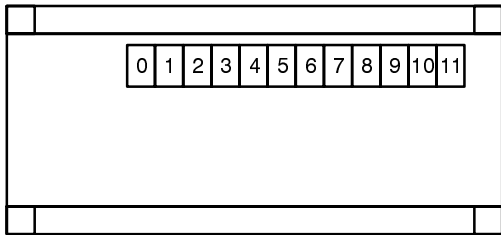

**C40H**

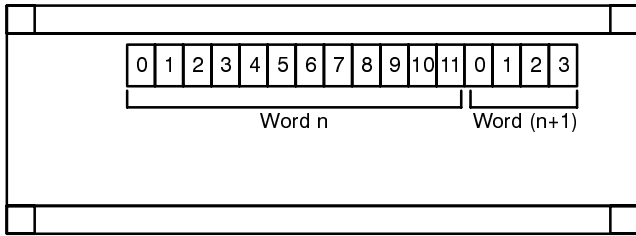

**C60H**

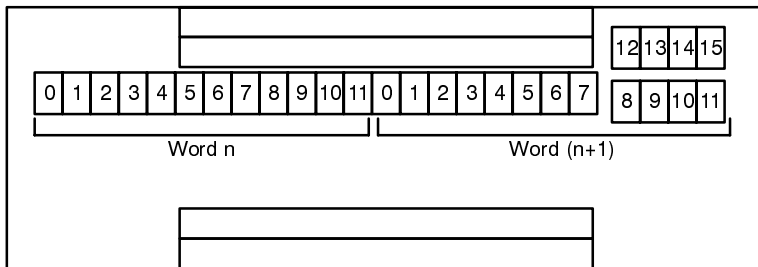

## How to Replace the Battery

The service life of the battery is five years at 25°C. The life of the battery becomes shorter at higher temperatures. When the battery is discharged, the ERR LED blinks telling you that you have one week to replace the battery. The date by which the first battery must be replaced is written on the side panel of the CPU Unit. For example, FIRST REPLACEMENT 93/12 means that you must replace the battery no later than December 1993.

### Note

To prevent the loss of data, the battery must be replaced and completely connected within five minutes.



### Caution

Due to danger of combustion, explosion, or leakage, do not attempt to charge, heat or disassemble the battery, or short-circuit the terminals. When disposing of a used battery, do not throw it into a fire.

- 1, 2, 3... 1. Turn the power to the PC OFF. If the power is already OFF, turn it ON and wait for at least 1 minute and turn it OFF again. Replace the battery within five minutes after turning the power to the PC OFF.
2. Use a Phillips screwdriver to loosen the four screws on the front panel of the CPU Unit. Remove the cover from the Unit, lifting it from the left. The battery is located on the back of the front panel of the CPU Unit.

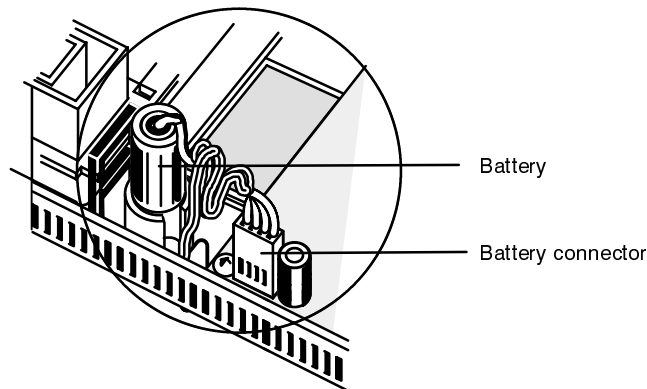

3. Pull the battery from the holder and install the new battery within one minute.

### Note

The entire operation must be completed within five minutes after turning off the power supply.

4. Replace the front panel, positioning it over the Unit and firmly pressing on the center of the cover until the internal connectors are mated.
5. Clear the ERR message on the Programming Console.

## Routine Inspection

In order for your PC to continue operating at optimum condition, periodic inspections are necessary. The main components of the PC are semiconductors and have a long service life, but depending on the operating environment, there may be more or less deterioration of these and other parts. A standard inspection schedule is once every six months to one year. More frequent inspections may be advisable depending on the operating environment. Try to maintain the inspection schedule once it has been set.

Check to be sure that the power supply, ambient temperature, humidity, etc. are within the specifications (refer to *Appendix A Specifications*). Be sure that these are no loose screws in any of the Units and that all battery and cable connections are secure. Clean any dust or dirt that has accumulated. Check all fuses, relays, and other replaceable parts.

# Appendix D

## Test Run Procedures

### Wiring Checklist

After you have finished wiring the PC and before doing a test run, reconfirm the following items.

Item	Confirmation
Power supply and I/O connections	Are the terminals and the power supplies wired properly? Are the terminal screws secure? Is the terminal block securely connected to the Unit? Is the Unit mounted securely?
Connecting Cable	Are the cables connecting each Unit connected properly and locked? Are the connecting cables the proper length?
DIP switches, jumper settings, chips (for ROM chips)	Are the DIP switches and jumper pins set for the kind of memory you are using? Is the memory chip mounted properly?

# Test Run Procedure

After checking all aspects of the PC (i.e. mounting, I/O connections, memory chip, etc.) perform a test run, using the following procedure.

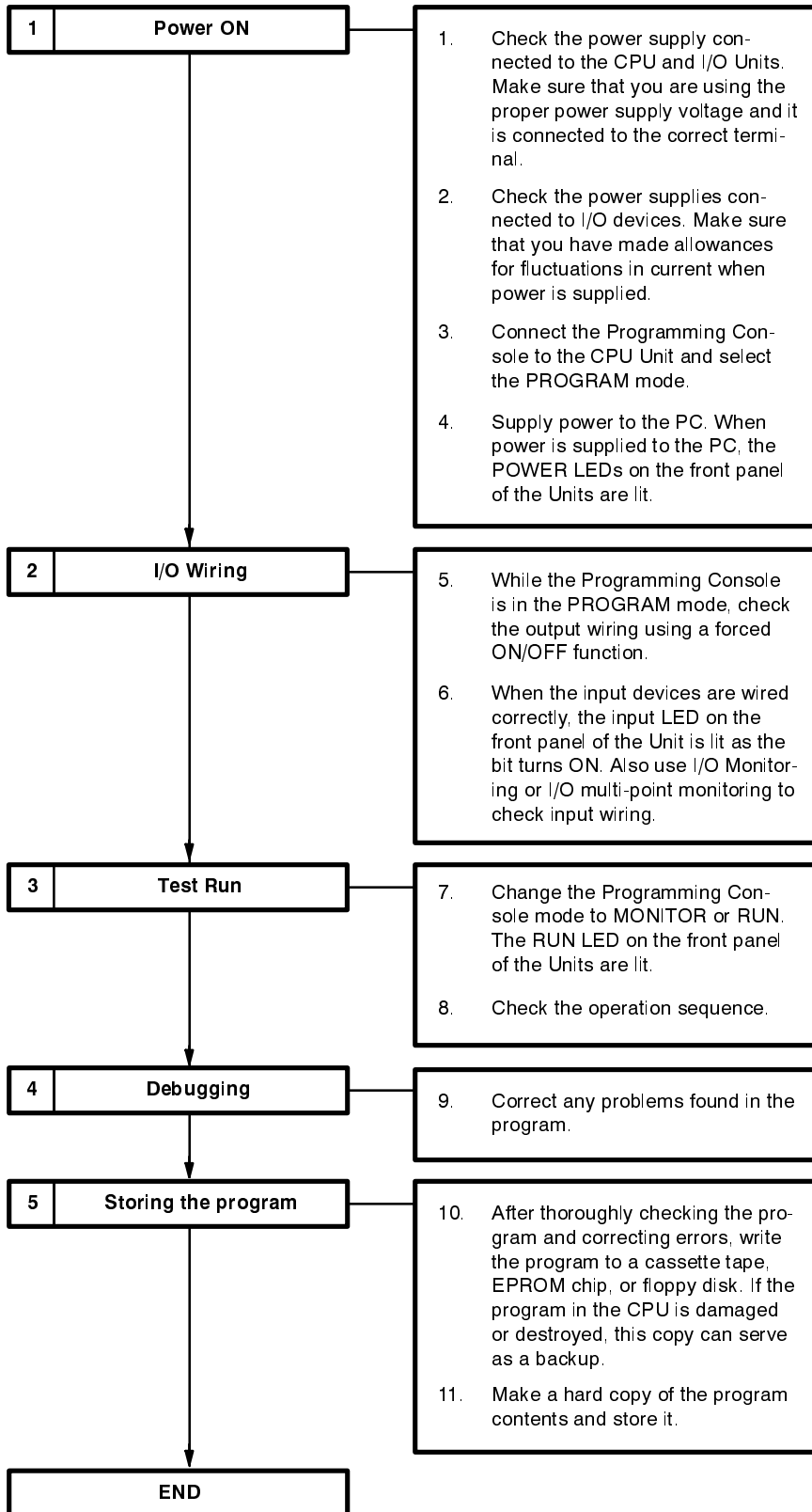

## Self Diagnostic Functions

Situation	Item	POWER	RUN	ALARM ERROR	Error Display	Correction
Fatal error	Power failure (when the power is OFF for at least 1 ms)	●	●	●	---	Check the power supply voltage and power lines, and turn the power ON again.
	CPU error (watchdog timer over 130 ms)	⊗	●	⊗	---	Put the PC in the PROGRAM mode and turn the power ON again. Check the user program.
	Memory error	⊗	●	⊗	MEMORY ERR	<ul style="list-style-type: none"> <li>• Check the program, fix the error, and rerun the program.</li> <li>• Check that the DIP switch settings are correct.</li> <li>• Check that the EPROM chip is properly mounted.</li> <li>• Check that the battery is properly connected.</li> <li>• Clear the error after correcting it.</li> </ul>
	Missing END instruction	⊗	●	⊗	NO END INST	Write END in the final address of the program.
	I/O bus error	⊗	●	⊗	I/O BUS ERR	Check the number of points with I/O Table Read and use I/O Table Register to match the registered table to the actual table. Clear the error after correcting it.
	System error	⊗	●	⊗	SYS FAIL FALS	Check the program for any errors. When executing FALS9F the scan time is between 120 ms. At this time the PC may stop operating. The scan time can be increased by changing the data in the system settings area. See <i>Section 4 System Memory Allocation</i> .

Situation	Item	POWER	RUN	ALARM ERROR	Error Display	Correction
Non-fatal error	System error	☒	☒	●	SYS FAIL FAL	Check the user's program.
	Scan time over	☒	☒	●	SCAN TIME OVER	Check the scan time. The scan time can be increased through the system settings area.
	Battery error	☒	☒	●	BATT LOW	Check that the battery is properly connected and charged. Replace the battery.
	System registration area error	☒	☒	●	---	Check the contents of the system registration area and reset.
	Host Link error	☒	☒	---	---	Reset the Host computer communication status and the CPU Unit settings.
	Load cut-off error	☒	☒	---	---	---

# Glossary

<b>ASCII code</b>	[A(merican) S(tandard) C(ode for) I(nformation) I(nterchange)] A standard computer code used to facilitate the interchange of information among various types of data-processing equipment.
<b>ASCII Unit</b>	An Intelligent I/O Unit. The ASCII Unit has its own CPU and 16 kilobytes of memory. This Unit enables communication between the PC and any other device which uses ASCII code. The ASCII Unit can be programmed in BASIC.
<b>Backplane</b>	A base to which Units are mounted to form a Rack. Backplanes provide a series of connectors for these Units along with wiring to connect them to the CPU and Power Supply. Backplanes also provide connectors used to connect them to other Backplanes. In some Systems, different Backplanes are used for different Racks; in other Systems, Racks differ only by the Units mounted to them.
<b>back-up</b>	A copy of existing data which is valuable if data is accidentally erased.
<b>baud rate</b>	Transfer speed between two devices in a system measured in bits per second. For example, an optical sensor might be configured to send its information to the FIT at 9600 baud. It is important for both of the devices to be set to the same baud rate.
<b>bit</b>	The smallest piece of information that can be represented on a computer. A bit has the value of either zero or one, corresponding to the electrical signals ON and OFF. A bit is one binary digit.
<b>central processing unit</b>	A device that is capable of storing a program and data, and executing the set of instructions contained in the program. In a PC System, the central processing unit executes the program, processes I/O signals, communicates with external devices, etc.
<b>communication cable</b>	Cable used to transfer data between components of a control system and conforming to the RS-232C or RS-422 standards.
<b>Control System</b>	All of the hardware and software components used to control other devices. A Control System includes the PC System, the PC programs, and all I/O devices that are used to control or obtain feedback from the controlled system.
<b>counter</b>	A PC function that counts the number of occurrences of a certain event.
<b>CPU</b>	An acronym for central processing unit.
<b>data area</b>	An area in the PC's memory that is designed to hold a specific type of data, e.g., the LR area is designed to hold common data in a PC Link System.
<b>data disk</b>	Floppy disk used to store information such as programs or I/O tables. The data disk should be used in drive B of the FIT.
<b>data link</b>	Allows for the connection of up to 32 PCs in a Net Link System where each is contributing information to a common memory area. Data links may be established in the LR and/or DM memory areas.

<b>debugging</b>	The process of checking for errors in a program.
<b>default condition</b>	The original condition of a function or system. For example, the FIT's default condition is to start from its hard drive, but this default condition can be changed so that it starts from a floppy disk drive.
<b>distributed control</b>	An automation concept in which control of each portion of an automated system is located near the devices actually being controlled, i.e., control is decentralized and "distributed" over the system. Distributed control is a concept basic to PC Systems.
<b>EEPROM</b>	[E(lectrically) E(rasable) P(rogrammable) R(ead) O(nly) M(emory)] A type of ROM in which stored data can be erased and reprogrammed. This is accomplished using a special control lead connected to the EEPROM chip and can be done without having to remove the EEPROM chip from the device in which it is mounted.
<b>electrical noise</b>	Electric 'static' that can disturb electronic communications. The 'snow' that can appear on a TV screen is an example of the effects of electrical noise.
<b>EPROM</b>	[E(rasable) P(rogrammable) R(ead) O(nly) M(emory)] A type of ROM in which stored data can be erased, by ultraviolet light or other means, and reprogrammed.
<b>Expansion I/O Unit</b>	An I/O Unit for a Package-type PC that provides more I/O points to the PC.
<b>factory computer</b>	A general-purpose computer, usually quite similar to a business computer, that is used in automated factory control.
<b>flag</b>	A bit that is turned ON and OFF automatically by the system in order to provide status information.
<b>High-speed Counter</b>	A Special I/O Unit. A High Speed Counter Unit counts independently of the PC's scan time. This allows counting of very short, fast signals.
<b>host computer</b>	A computer that is used to transfer data to or receive data from a PC in a Host Link system. The host computer is used for data management and overall system control. Host computers are generally small personal or business computers.
<b>IBM PC/XT or AT, or compatibles</b>	A computer that has similar architecture to, and is logically compatible with an IBM PC/XT computer; and that can run software designed for that computer.
<b>instruction line</b>	A succession of instructions which begins with a load instruction at the left bus bar and ends at a right bus bar.
<b>interface</b>	An interface is the conceptual boundary between systems or devices and usually involves changes in the way the communicated data is represented. Interface devices such as NSBs perform operations such as changing the coding, format, or speed of data.
<b>I/O devices</b>	The devices which are connected to the terminals on I/O Units, Special I/O Units, or Intelligent I/O Units. I/O devices may be part of the Control System if they function to help control other devices, or they may be part of the controlled system if they interact directly with it.



<b>I/O point</b>	The place at which an input signal enters the PC System or an output signal leaves the PC System. In physical terms, an I/O point corresponds to terminals or connector pins on a Unit; in terms of programming, an I/O point corresponds to an I/O bit in the IR area.
<b>I/O table</b>	Diagram written to the IR memory area listing the type of I/O units controlled by a PC. It must be cleared before programming or when I/O units are changed. Tables can be read, verified, or transferred to a EPROM.
<b>I/O Unit</b>	The most basic type of Unit mounted to a Backplane. I/O Units include Input Units and Output Units, each of which is available in a range of specifications. I/O Units do not include Special I/O Units, Link Units, etc.
<b>Limit Switch</b>	A switch that detects when an object has reached the limit of its movement by actually making contact with the object. Limit Switches are fitted to electric elevators, traveling cranes, etc. to indicate when a certain part of the equipment has traveled to the specified limit.
<b>Link Unit</b>	Any of the Units used to connect a PC to a Link System. These are Remote I/O Units, I/O Link Units, PC Link Units, Host Link Units, and Net Link Units.
<b>operating mode</b>	The Display Terminal Unit can operate in five different modes: Page Read, Terminal. Dynamic Scan, Read/Write, and Self-Diagnosis.
<b>page</b>	One complete Display Terminal Unit screen. Two hundred screens can be stored on one RAM card.
<b>parallel interface</b>	The parallel interface uses the RS-232 connector, but is not serial communication. When parallel mode is selected as the communication mode, up to 16 Display Terminal Units can be connected to a PC in parallel.
<b>PC</b>	An acronym for Programmable Controller.
<b>PCB</b>	An acronym for printed circuit board.
<b>PC Link Unit</b>	A Unit used to connect two or more PCs together so that they can exchange data through their LR areas.
<b>Photoelectric Switch</b>	A switch that uses light to detect the presence of an object.
<b>Power Supply</b>	A Unit that mounts to a Backplane in a Rack PC. It provides power at the voltage required by the other Units on the Rack.
<b>printed circuit board</b>	A board onto which electrical circuits are printed for mounting into a computer or electrical device.
<b>Programmable Controller</b>	A small, computer-like device that can control peripheral equipment, such as an electric door or quality control devices, based on programming and peripheral input devices. Any process that can be controlled using electrical signals can be controlled by a PC. PCs can be used independently or networked together into a system to control more complex operations.
<b>programming device</b>	A peripheral device used to write programs and to input a program to a PC or to alter or monitor a program already stored in the PC. There are dedicated programming devices, such as Programming Consoles, and there are non-dedicated programming devices, such as a host computer.

<b>PROM</b>	[P(rogrammable) R(ead) O(nly) M(emory)] A type of ROM into which the program or data may be written after manufacture, by a customer, but which is fixed from that time on.
<b>PROM Writer</b>	A PROM Writer is a device used to write data to ROM, PROM, and EPROM storage chips.
<b>Proximity Switch</b>	A switch that uses magnetic induction to measure the distance of a metallic object from the front of the switch.
<b>Rack PC</b>	A PC that is composed of Units mounted to one or more Racks. This configuration is the most flexible, and most large PCs are Rack PCs. A Rack PC is the opposite of a Package-type PC, which has all of the basic I/O, storage, and control functions built into a single package.
<b>RAM</b>	[R(andom) A(ccess) M(emory)] RAM will not retain data when power is disconnected. Therefore data should not be stored in RAM.
<b>register/registered</b>	Storing text and graphics in the RAM/ROM card from a personal computer or the ASCII Unit. Graphics that have been written to the RAM/ROM card are referred to as registered messages.
<b>Remote I/O Unit</b>	A Unit that extends the distance an Expansion I/O Unit can be from the CPU.
<b>ROM</b>	[R(ead) O(nly) M(emory)] A type of digital storage that cannot be written to. A ROM chip is manufactured with its program or data already stored in it, and it can never be changed. However, the program or data can be read as many times as desired.
<b>scan time</b>	The total time it takes the PC to perform internal operations, i.e., reset the watchdog timer, read the program, receive input data, send output data, and execute instructions. Scan time is monitored by the watchdog timer within the PC, and if it takes longer than a certain specified amount of time, an error message may be generated, or the CPU may just stop. Scan times will differ depending on the configuration of the system.
<b>switching capacity</b>	The voltage/current that relay can switch ON and OFF.
<b>stepping motor</b>	An output device that rotates according to signals from the Control System. The rotation is very precise and occurs in pre-defined "steps."
<b>switch</b>	An input device that sends either an ON or OFF signal to the Control System. A switch can be operated either by a person or by the movement of a piece of equipment or material.
<b>system configuration</b>	The arrangement in which Units in a System are connected. This term refers to the conceptual arrangement and wiring together of all the devices needed to comprise the System. In OMRON terminology, system configuration is used to describe the arrangement and connection of the Units comprising a Control System that includes one or more PCs.
<b>Unit</b>	In OMRON PC terminology, the word Unit is capitalized to indicate any product sold for a PC System. Though most of the names of these products end with the word Unit, not all do, e.g., a Remote Terminal is referred to in a collective sense as a Unit. Context generally makes any limitations of this word clear.

<b>watchdog timer</b>	A special timer inside the CPU that monitors the PC's scan time. The watchdog timer sets a flag if the scan time becomes longer than a certain specified value. This is useful if the correct operation of your System depends on a certain maximum scan time.
<b>word</b>	In digital circuits, a group of bits. Usually a word consists of four, eight, or sixteen bits. In C-series PCs, a word consists of sixteen bits. Words can be used to store data, or they can be used for I/O.
<b>work bits</b>	Bits in the IR area that are not being used for input or output. These bits can be used in the program in any way desired.

# Index

## A

Application Program Read/Write Mode, RS-232C Interface, 11  
ASCII I/O, 25  
    display terminal, 26  
ASCII I/O Mode, RS-232C Interface, 11

## B–C

battery, 85  
bit allocation, 34  
codes  
    command, 31  
    response, 31  
connecting cable, 22, 24, 25, 26  
    Hand-held Programming Console, 10  
Console Adapter, 10  
    diagram, 11  
Console Connector, 10  
    connecting cable, 10  
control components, 2  
Control System, definition, 2  
CPU  
    description, 8  
    indicators, 9

## D–E

Data Access Console, connector, 10  
diagnostic functions, 89  
DM word allocation, 28  
EEPROM  
    Memory settings, 17  
    Write Enable Switch, 9  
    Writing data to chip, 14  
EPROM  
    how to mount, 17  
    Memory settings, 17  
error  
    counter, 41  
    history, 40  
    table, 39  
Expansion I/O Unit  
    connectors, 13  
    description, 13  
    Indicators, 13

## F–H

factory computer, 2  
FIT, 22  
    for writing data, 15  
    RS-232C Interface, 11  
flag, 28  
format  
    Intel HEX, 25  
    Motorola S, 25  
ground, 53  
Hand-held Programming Console, connector, 10  
host computer, 23  
    RS-232C Interface, 11  
Host Link Mode, 22  
Host Link Unit  
    connector, 10  
    how to mount, 10

## I–L

Indicators, CPU, 9  
inductive load, 63  
input devices, 3  
interlock, 62  
Jumper pins, memory, 15  
leakage current, 64, 68  
Link Adapter, 23  
    Host Link Mode (RS-232C Interface), 11

## M–P

Memory, 14  
    diagram of memory switches and jumper pins, 15  
    DIP Switch and jumper pin settings, 17  
    EEPROM, 15  
    EPROM, 14  
    installation, 16  
    RAM, 14  
output devices, 3  
Peripheral Interface Connector, storage slot, 8  
Peripheral Interface Unit  
    C500-IP004, 10  
    connector, 10  
    how to mount, 10  
power supply, 53  
precautions, general, xi  
printer, 26  
process control computer, 2

program header, 42

Programmable Controller

  block diagram, 4

  flowchart, 5

  operation, 3

  role, 2

Programming Console, writing data to RAM CPU Unit, 9

PROM Programmer, for writing data, 15

PROM Writer, 25

  Application Program Read/Write Mode (RS-232C Interface),  
  11

  writing data, 14

## R

RAM

  Memory settings, 17

  Write Enable Switch, 9

real-time clock, specifications, 80

registration, system, 28

relays, 66, 83

RS-232C interface, specifications, 80

RS-232C, 22

RS-232C Interface, 10

  Connector pins, 12

  Host Link Mode, 11

  three modes, 11

RS-422, 23

## S

scan time, 4

scanning cycle, 4

surge current, 62, 66, 67

switching capacity, 67

SYSTEM COMMAND, 28

System configuration, 19

SYSTEM ERROR, 28

SYSTEM SETTING, 28

## T

terminal block, 55

test run, 88

Transfer format

  Intel HEX, 11

  Motorola S, 11

TTL, 63, 65

## U

User Program Write Enable Switch, 9  
  diagram, 9

User's Program, Write Enable Switch, 9

## Revision History

A manual revision code appears as a suffix to the catalog number on the front cover of the manual.

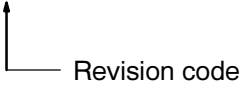
Cat. No. W175-E1-4A  

The following table outlines the changes made to the manual during each revision. Page numbers refer to the previous version.

Revision code	Date	Revised content
1	July 1990	Original production
2	July 1991	Converted to the current format. <b>Page 11:</b> Model number for Peripheral Interface Unit corrected in diagram. <b>Page 20:</b> FIT model number corrected and LSS added to diagram. <b>Page 22:</b> Callouts for and connections to Rack-mounting Host Link Units corrected in diagram. <b>Page 69:</b> LSS added.
3	May 1992	Information on C60H and the new version (V1) of the other CPUs added throughout the manual. Models with transistor outputs with no sockets were added.
4	March 1993	<b>Page 72:</b> EPROM model number ROM-I_-B has been added to the note. <b>Page 74:</b> "-US" has been added to the model number of the 0.2 A Triac Relay. <b>Page 75:</b> "Programming Console Adapter" corrected to "Programming Console Base Unit" and specifications were modified. <b>Pages 78, 79:</b> Model C40H corrected to C60H.
4A	September 1996	Section of precautions added before section 1 and adjustments made to signal words for precautions. LSS replaced with SSS. <b>Page 75:</b> GPC04 removed.