

SIEMENS



SIMATIC

S7-1500 / ET 200MP

Analog output module AQ 8xU/I HS (6ES7532-5HF00-0AB0)

Manual

Edition

09/2016

siemens.com

SIEMENS

SIMATIC

S7-1500/ET 200MP Analog output module AQ 8xU/I HS (6ES7532-5HF00-0AB0)

Manual

Preface

Documentation guide

1

Product overview

2

Wiring

3

Parameters/address space

4

Interrupts/diagnostics alarms

5

Technical specifications

6

Dimensional drawing

A

Parameter data records

B



Representation of analog
values

C

Legal information

Warning notice system

This manual contains notices you have to observe in order to ensure your personal safety, as well as to prevent damage to property. The notices referring to your personal safety are highlighted in the manual by a safety alert symbol, notices referring only to property damage have no safety alert symbol. These notices shown below are graded according to the degree of danger.

 DANGER
indicates that death or severe personal injury will result if proper precautions are not taken.
 WARNING
indicates that death or severe personal injury may result if proper precautions are not taken.
 CAUTION
indicates that minor personal injury can result if proper precautions are not taken.
NOTICE
indicates that property damage can result if proper precautions are not taken.

If more than one degree of danger is present, the warning notice representing the highest degree of danger will be used. A notice warning of injury to persons with a safety alert symbol may also include a warning relating to property damage.

Qualified Personnel

The product/system described in this documentation may be operated only by **personnel qualified** for the specific task in accordance with the relevant documentation, in particular its warning notices and safety instructions. Qualified personnel are those who, based on their training and experience, are capable of identifying risks and avoiding potential hazards when working with these products/systems.

Proper use of Siemens products

Note the following:

 WARNING
Siemens products may only be used for the applications described in the catalog and in the relevant technical documentation. If products and components from other manufacturers are used, these must be recommended or approved by Siemens. Proper transport, storage, installation, assembly, commissioning, operation and maintenance are required to ensure that the products operate safely and without any problems. The permissible ambient conditions must be complied with. The information in the relevant documentation must be observed.

Trademarks

All names identified by ® are registered trademarks of Siemens AG. The remaining trademarks in this publication may be trademarks whose use by third parties for their own purposes could violate the rights of the owner.

Disclaimer of Liability

We have reviewed the contents of this publication to ensure consistency with the hardware and software described. Since variance cannot be precluded entirely, we cannot guarantee full consistency. However, the information in this publication is reviewed regularly and any necessary corrections are included in subsequent editions.

Preface

Purpose of the documentation

This manual supplements the system manual: S7-1500/ET 200MP (<https://support.industry.siemens.com/cs/ww/en/view/59191792>) automation system.

Functions that relate in general to the systems are described in these manuals.

The information provided in this manual and in the system/function manuals supports you in commissioning the systems.

Changes compared to previous version

Compared to the previous version, this manual contains the following changes:

- As of firmware version V2.1.0, the module supports the oversampling function.
- Original texts of the license conditions and copyright notes for open-source software are available on the Internet as of 09/2016.

Conventions

The term "CPU" is used in this manual both for the CPUs of the S7-1500 automation system, as well as for interface modules of the ET 200MP distributed I/O system.

Please also observe notes marked as follows:

Note

A note contains important information regarding the product described in the documentation or its handling, or draws special attention to a section of the documentation.

Security information

Siemens provides products and solutions with industrial security functions that support the secure operation of plants, systems, machines and networks.

In order to protect plants, systems, machines and networks against cyber threats, it is necessary to implement – and continuously maintain – a holistic, state-of-the-art industrial security concept. Siemens' products and solutions only form one element of such a concept.

Customer is responsible to prevent unauthorized access to its plants, systems, machines and networks. Systems, machines and components should only be connected to the enterprise network or the internet if and to the extent necessary and with appropriate security measures (e.g. use of firewalls and network segmentation) in place.

Additionally, Siemens' guidance on appropriate security measures should be taken into account. For more information about industrial security, please visit (<http://www.siemens.com/industrialsecurity>).

Siemens' products and solutions undergo continuous development to make them more secure. Siemens strongly recommends to apply product updates as soon as available and to always use the latest product versions. Use of product versions that are no longer supported, and failure to apply latest updates may increase customer's exposure to cyber threats.

To stay informed about product updates, subscribe to the Siemens Industrial Security RSS Feed under (<http://www.siemens.com/industrialsecurity>).

Open Source Software

Open-source software is used in the firmware of the I/O modules. Open Source Software is provided free of charge. We are liable for the product described, including the open-source software contained in it, pursuant to the conditions applicable to the product. Siemens accepts no liability for the use of the open source software over and above the intended program sequence, or for any faults caused by modifications to the software.

For legal reasons, we are obliged to publish the original text of the license conditions and copyright notices. Please read the information relating to this on the Internet (<https://support.industry.siemens.com/cs/ww/en/view/109739516>).

Table of contents

	Preface	4
1	Documentation guide	7
2	Product overview	11
2.1	Properties	11
2.2	Functions	13
2.2.1	Oversampling for outputs	13
3	Wiring	15
4	Parameters/address space	18
4.1	Output ranges	18
4.2	Parameters	19
4.3	Declaration of parameters	21
4.4	Address space	22
5	Interrupts/diagnostics alarms	30
5.1	Status and error displays	30
5.2	Interrupts	32
5.3	Diagnostics alarms	33
6	Technical specifications	34
A	Dimensional drawing	40
B	Parameter data records	42
B.1	Parameter assignment and structure of the parameter data records	42
C	Representation of analog values	46
C.1	Representation of output ranges	47
C.2	Representation of analog values in the voltage output ranges	48
C.3	Representation of analog values in the current output ranges	49

Documentation guide

The documentation for the SIMATIC S7-1500 automation system, the CPU 1516pro-2 PN based on SIMATIC S7-1500 and the SIMATIC ET 200MP distributed I/O system is arranged into three areas.

This arrangement enables you to access the specific content you require.

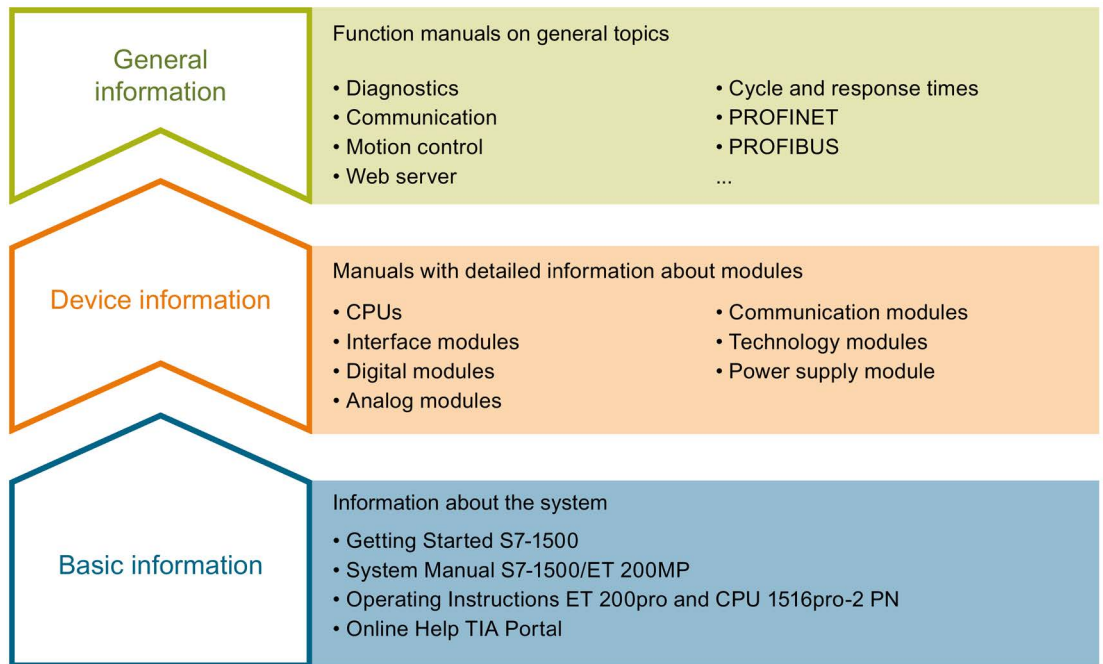

Basic information

The System Manual and Getting Started describe in detail the configuration, installation, wiring and commissioning of the SIMATIC S7-1500 and ET 200MP systems. For CPU 1516pro-2 PN you use the corresponding operating instructions. The STEP 7 online help supports you in the configuration and programming.

Device information

Product manuals contain a compact description of the module-specific information, such as properties, wiring diagrams, characteristics and technical specifications.

General information

The function manuals contain detailed descriptions on general topics regarding the SIMATIC S7-1500 and ET 200MP systems, e.g. diagnostics, communication, motion control, Web server, OPC UA.

You can download the documentation free of charge from the Internet (<http://w3.siemens.com/mcms/industrial-automation-systems-simatic/en/manual-overview/Pages/Default.aspx>).

Changes and supplements to the manuals are documented in a Product Information.

You can download the product information free of charge from the Internet (<https://support.industry.siemens.com/cs/us/en/view/68052815>).

Manual Collection S7-1500/ET 200MP

The Manual Collection contains the complete documentation on the SIMATIC S7-1500 automation system and the ET 200MP distributed I/O system gathered together in one file.

You can find the Manual Collection on the Internet (<https://support.industry.siemens.com/cs/ww/en/view/86140384>).

SIMATIC S7-1500 comparison list for programming languages

The comparison list contains an overview of which instructions and functions you can use for which controller families.

You can find the comparison list on the Internet (<https://support.industry.siemens.com/cs/ww/en/view/86630375>).

"mySupport"

With "mySupport", your personal workspace, you make the best out of your Industry Online Support.

In "mySupport", you can save filters, favorites and tags, request CAx data and compile your personal library in the Documentation area. In addition, your data is already filled out in support requests and you can get an overview of your current requests at any time.

You must register once to use the full functionality of "mySupport".

You can find "mySupport" on the Internet (<https://support.industry.siemens.com/My/ww/en>).

"mySupport" - Documentation

In the Documentation area in "mySupport" you can combine entire manuals or only parts of these to your own manual.

You can export the manual as PDF file or in a format that can be edited later.

You can find "mySupport" - Documentation on the Internet (<http://support.industry.siemens.com/My/ww/en/documentation>).

"mySupport" - CAx data

In the CAx data area in "mySupport", you can access the current product data for your CAx or CAe system.

You configure your own download package with a few clicks.

In doing so you can select:

- Product images, 2D dimension drawings, 3D models, internal circuit diagrams, EPLAN macro files
- Manuals, characteristics, operating manuals, certificates
- Product master data

You can find "mySupport" - CAx data on the Internet (<http://support.industry.siemens.com/my/ww/en/CAxOnline>).

Application examples

The application examples support you with various tools and examples for solving your automation tasks. Solutions are shown in interplay with multiple components in the system - separated from the focus on individual products.

You will find the application examples on the Internet (<https://support.industry.siemens.com/sc/ww/en/sc/2054>).

TIA Selection Tool

With the TIA Selection Tool, you can select, configure and order devices for Totally Integrated Automation (TIA).

This tool is the successor of the SIMATIC Selection Tool and combines the known configurators for automation technology into one tool.

With the TIA Selection Tool, you can generate a complete order list from your product selection or product configuration.

You can find the TIA Selection Tool on the Internet (<http://w3.siemens.com/mcms/topics/en/simatic/tia-selection-tool>).

SIMATIC Automation Tool

You can use the SIMATIC Automation Tool to run commissioning and maintenance activities simultaneously on various SIMATIC S7 stations as a bulk operation independently of the TIA Portal.

The SIMATIC Automation Tool provides a multitude of functions:

- Scanning of a PROFINET/Ethernet network and identification of all connected CPUs
- Address assignment (IP, subnet, gateway) and station name (PROFINET device) to a CPU
- Transfer of the date and the programming device/PC time converted to UTC time to the module
- Program download to CPU
- Operating mode switchover RUN/STOP
- Localization of the CPU by means of LED flashing
- Reading out CPU error information
- Reading the CPU diagnostic buffer
- Reset to factory settings
- Updating the firmware of the CPU and connected modules

You can find the SIMATIC Automation Tool on the Internet (<https://support.industry.siemens.com/cs/ww/en/view/98161300>).

PRONETA

With SIEMENS PRONETA (PROFINET network analysis), you analyze the PROFINET network during commissioning. PRONETA features two core functions:

- The topology overview independently scans PROFINET and all connected components.
- The IO check is a fast test of the wiring and the module configuration of a system.

You can find SIEMENS PRONETA on the Internet (<https://support.industry.siemens.com/cs/ww/en/view/67460624>).

Product overview

2.1 Properties

Article number

6ES7532-5HF00-0AB0

View of the module

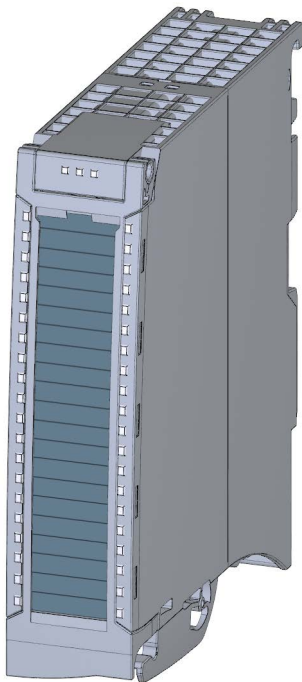

Figure 2-1 View of the AQ 8xU/I HS module

Properties

The module has the following technical properties:

- Channel-based selection of 8 analog outputs
- Selection of channels for current output
- Selection of channels for voltage output
- Resolution: 16 bits including sign
- Configurable diagnostics (per channel)
- Fast updating of the output values

The module supports the following functions:

Table 2- 1 Version dependencies of the module functions

Function	Firmware version of the module	Configuration software	
		STEP 7 (TIA Portal)	GSD file in STEP 7 (TIA Portal) V12 or higher, or STEP 7 V5.5 SP3 or higher
Firmware update	V1.0.0 or higher	V12 or higher	X
Identification data I&M0 to I&M3	V1.0.0 or higher	V12 or higher	X
Parameter assignment in RUN	V1.0.0 or higher	V12 or higher	X
Isochronous mode	V1.0.0 or higher	V12 or higher	---
Calibration in runtime	V1.0.0 or higher	V12 or higher	X
Module-internal Shared Output (MSO)	V2.0.0 or higher	V13 Update 3 or higher (PROFINET IO only)	X (PROFINET IO only)
Configurable submodules / submodules for Shared Device	V2.0.0 or higher	V13 Update 3 or higher (PROFINET IO only)	X (PROFINET IO only)
Oversampling	V2.1.0 or higher	V14 or higher and HSP 0186 (PROFINET IO only)	---

You can configure the module with STEP 7 (TIA Portal) and with a GSD file. The oversampling function requires isochronous mode and can therefore only be configured with STEP 7 (TIA Portal).

Accessories

The following accessories are supplied with the module and can also be ordered separately as spare parts:

- Shield bracket
- Shield terminal
- Power supply element
- Labeling strips
- U connector
- Universal front door

Other components

The following component can be ordered separately:

Front connectors, including potential jumpers and cable ties

You can find additional information on accessories in the S7-1500/ET 200MP (<http://support.automation.siemens.com/WW/view/en/59191792>) system manual.

2.2 Functions

2.2.1 Oversampling for outputs

Function

Oversampling is defined as the transfer of data in constant bus cycle segments (sub-cycles), whereby n sub-cycles correspond to one PROFINET bus cycle. A data packet is transmitted from the controller to the module, which outputs the packet in n constant bus sub-cycles.

Oversampling is useful whenever you require output of data with high time resolution but without using an extremely short PROFINET bus cycle and thus fast CPU cycles.

With oversampling, a PROFINET bus cycle is divided into constant bus sub-cycles:

- Each sub-cycle outputs a 16-bit value per channel.
- The shortest possible sub-cycle is 125 μ s.
- Sub-cycles are possible in increments of 2 to 16. The following applies here: Isochronous data cycle / number of sub-cycles \geq permitted sub-cycle duration (125 μ s).

Typical area of application

Controlling of a feed valve because output data can be controlled exactly at the current position of the machine.

Requirements

- Firmware version V2.1.0 or higher of the module.
- Isochronous mode has to be set.

Configuration

You configure the oversampling function by means of the output rate parameter.

Chronological sequence

The existing output data of a data cycle (send clock) is copied into the interface module in the next data cycle and is available for the module in the data cycle after that.

The figure below shows the chronological sequence for oversampling with 10 sub-cycles.

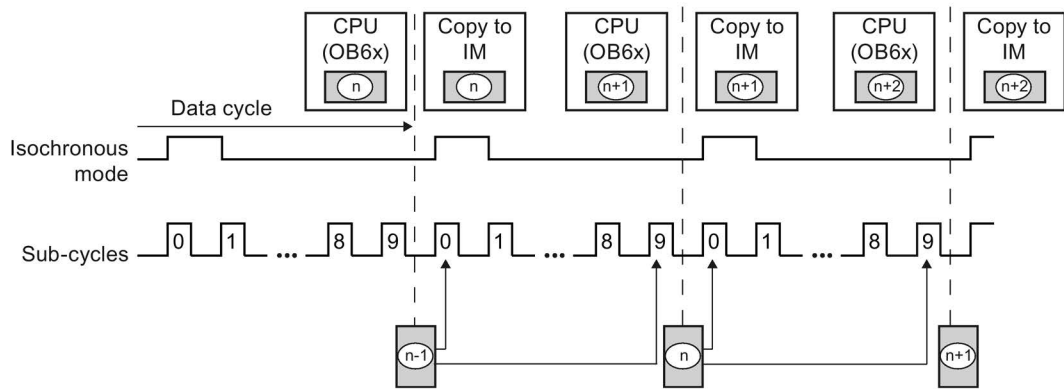

n Output value from cycle n

Figure 2-2 Chronological sequence with oversampling

Output interval

The duration of a sub-cycle corresponds to the output interval. The bus cycle time T_{DP} (send clock for isochronous mode) is specified in the configuration software. The actual output interval of the module results from this time divided by the set sampling rate (2-16).

$$\text{Output interval} = \frac{T_{DP}}{n_{\text{Sample}}} = \frac{2 \text{ ms}}{16} = 125 \mu\text{s}$$

Figure 2-3 Example for the calculation of the output interval

Wiring

This section contains the block diagram of the module and outlines various connection options.

You can find information on wiring the front connector, establishing a cable shield, etc in the Wiring section of the S7-1500/ET 200MP (<http://support.automation.siemens.com/WW/view/en/59191792>) system manual.

Note

- You may use and combine the different wiring options for all channels.
 - Do not insert the potential jumpers included with the front connector!
-

Abbreviations used

Meaning of the abbreviations used in the figures below:

QV _n	Voltage output channel
QI _n	Current output channel
Sn+/Sn-	Sense line channel
L+	Supply voltage connection
M	Ground connection
M _{ANA}	Reference potential of the analog circuit
CHx	Channel or display of the channel status
PWR	Display for the supply voltage

Pin assignment for the power supply element

The power supply element is plugged onto the front connector for powering the analog module. Wire the supply voltage to terminals 41 (L+) and 44 (M). Use terminals 42 (L+) and 43 (M) to loop the potential to the next module.

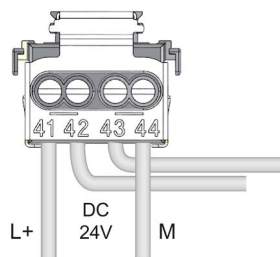
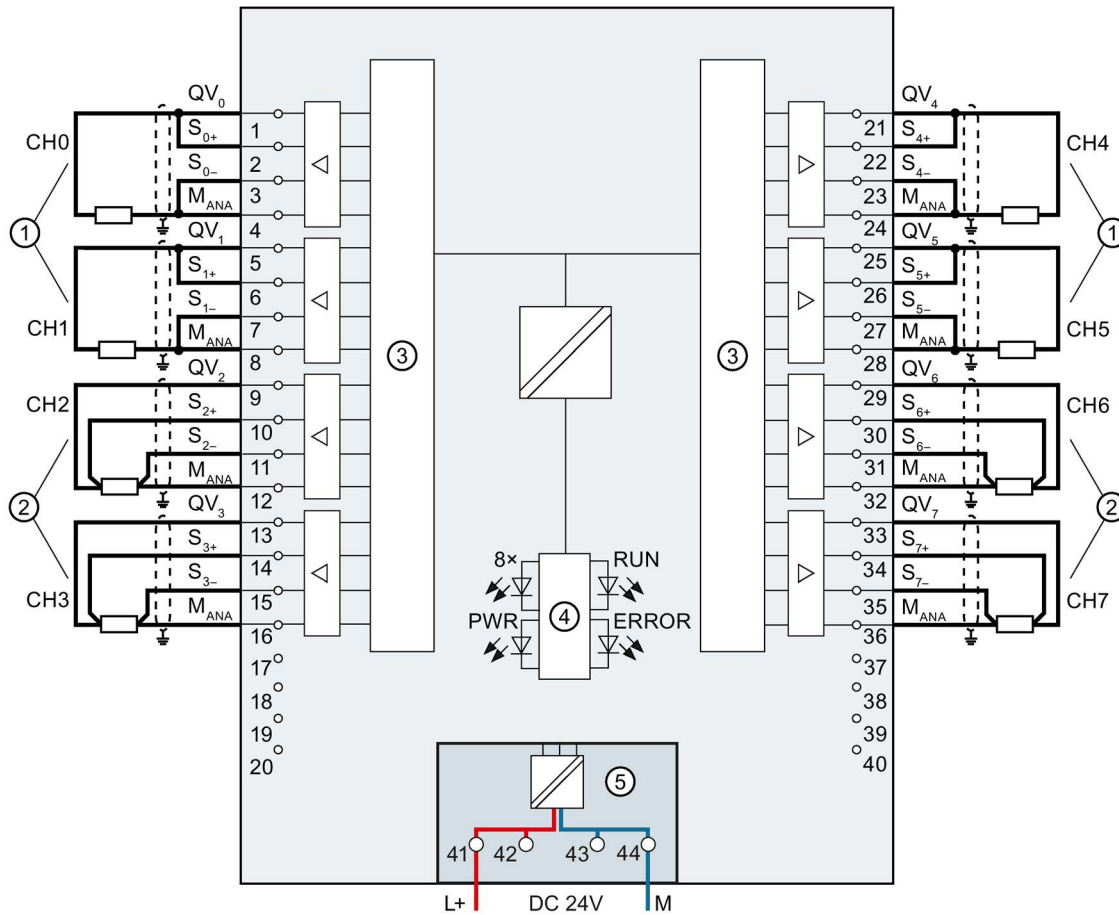

Figure 3-1 Power supply element wiring

Block diagram and terminal assignment for the voltage output

The example in the figure below shows the pin assignment for a voltage measurement.

- 2-wire connection, no compensation for line impedance.
- 4-wire connection with compensation for line impedance is displayed.



- | | | |
|---|-------|---|
| ① 2-wire connection (jumper at the front connector) | CHx | Channel or 8 x channel status (green/red) |
| ② 4-wire connection | RUN | Status display LED (green) |
| ③ Digital Analog Converter (DAC) | ERROR | Error display LED (red) |
| ④ Backplane bus interface | PWR | LED for power supply (green) |
| ⑤ Supply voltage via power supply element | | |

Figure 3-2 Block diagram and terminal assignment for the voltage output

Block diagram and terminal assignment for a current output

The following figure shows an example of the terminal assignment for current output circuitry.

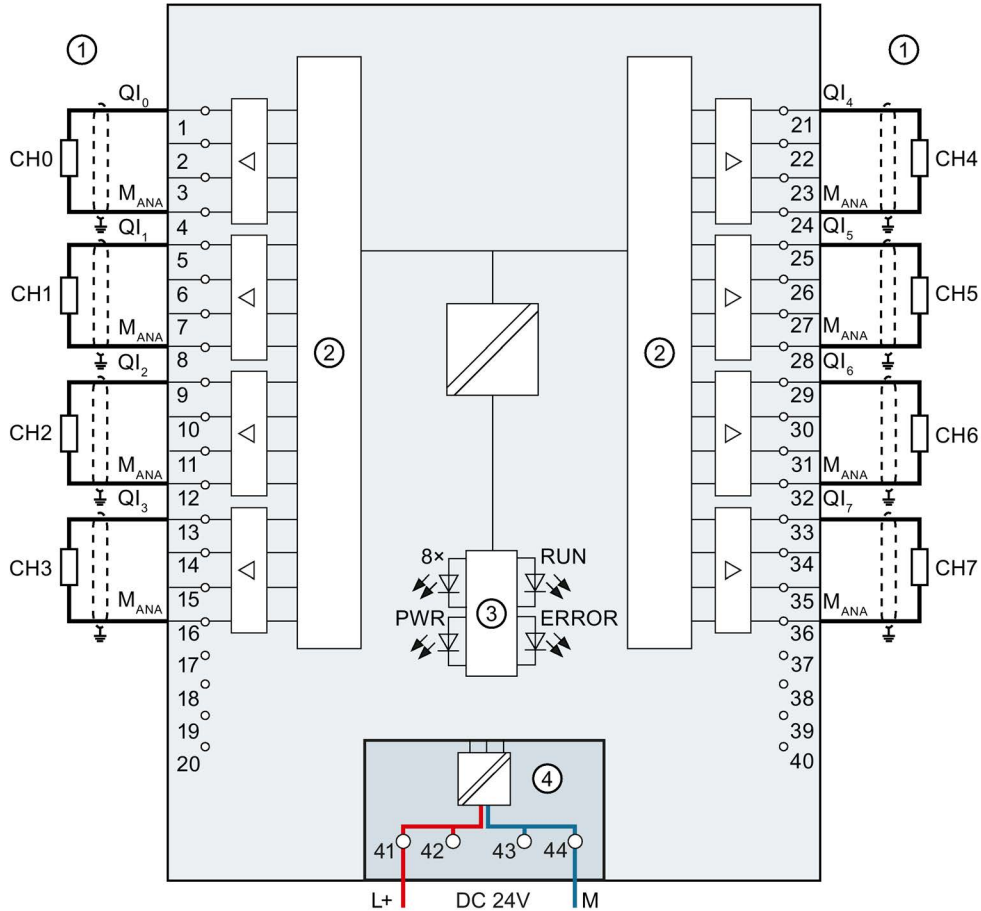

- | | | |
|---|-------|---|
| ① Load on current outputs | CHx | Channel or 8 x channel status (green/red) |
| ② Digital Analog Converter (DAC) | RUN | Status display LED (green) |
| ③ Backplane bus interface | ERROR | Error display LED (red) |
| ④ Supply voltage via power supply element | PWR | LED for power supply (green) |

Figure 3-3 Block diagram and terminal assignment for a current output

Parameters/address space

4.1 Output ranges

The module is set to voltage output type by default with output range ± 10 V. You need to edit the module parameters with STEP 7 if you want to use a different output range or output type.

Output type and output ranges

Output type	Output range	Representation of analog values
Voltage	1 V to 5 V 0 V to 10 V ± 10 V	See Appendix Representation of analog values in the voltage output ranges (Page 48).
Current	0 mA to 20 mA 4 mA to 20 mA ± 20 mA	See Appendix Representation of analog values in the current output ranges (Page 49).
Deactivated	-	

The tables of the output ranges, overflow, overrange, etc. are available in the Appendix Representation of analog values (Page 46).

4.2 Parameters

Parameters of AQ 8xU/I HS

The AQ 8xU/I HS is usually already integrated in the hardware catalog of STEP 7 (TIA Portal). In this case, STEP 7 (TIA Portal) checks the configured properties for plausibility during configuration.

However, you can also assign parameters to the module by means of a GSD file and the configuration software of any provider. The module does not check the validity of the configured properties until after the configuration has been loaded.

When you assign the module parameters in STEP 7, you use various parameters to specify the module properties. The following table lists the configurable parameters. The effective range of the configurable parameters depends on the type of configuration. The following configurations are possible:

- Central operation with a S7-1500 CPU
- Distributed operation on PROFINET IO in an ET 200MP system
- Distributed operation on PROFIBUS DP in an ET 200MP system

When assigning parameters in the user program, use the WRREC instruction to transfer the parameters to the module by means of data records; refer to chapter Parameter assignment and structure of the parameter data records (Page 42).

Table 4- 1 Configurable parameters and their defaults

Parameters	Range of values	Default setting	Parameter assignment in RUN	Scope with configuration software, e.g., STEP 7 (TIA Portal)	
				Integrated in the hardware catalog STEP 7 (TIA Portal) as of V12 or GSD file PROFINET IO	GSD file PROFIBUS DP
AQ configuration					
Output rate (for the oversampling function)	1...16 values/cycle	1	No	Module (not GSD file)	---
Diagnostics					
• Missing supply voltage L+	Yes/No	No	No	Channel ¹⁾	Module ²⁾
• Wire break	Yes/No	No	No	Channel	Module ²⁾
• Short circuit to ground	Yes/No	No	No	Channel	Module ²⁾
• Overflow	Yes/No	No	No	Channel	Module ²⁾
• Underflow	Yes/No	No	No	Channel	Module ²⁾

4.2 Parameters

Parameters	Range of values	Default setting	Parameter assignment in RUN	Scope with configuration software, e.g., STEP 7 (TIA Portal)	
				Integrated in the hardware catalog STEP 7 (TIA Portal) as of V12 or GSD file PROFINET IO	GSD file PROFIBUS DP
Output					
• Output type	Voltage/current	Voltage	Yes	Channel	Channel
• Output range	See chapter output ranges (Page 18)	±10 V	Yes	Channel	Channel
• Reaction to CPU STOP	<ul style="list-style-type: none"> • Turn off • Keep last value • Output substitute value⁴⁾ 	Turn off	Yes	Channel	Channel ³⁾ <ul style="list-style-type: none"> • Turn off • Keep last value
• Substitute value	See Parameter assignment and structure of the parameter data records (Page 42)	0	Yes	Channel	--- ³⁾

1) If you enable diagnostics for multiple channels, you will receive an alarm surge on failure of the supply voltage because each enabled channel will detect this fault.

You can prevent this message burst by assigning the diagnostics function to one channel only.

2) You can set the effective range of the diagnostics for each channel in the user program with data records 64 to 71.

3) You can configure the setting "Output substitute value" and the substitute value in the user program by means of data records 64 to 71.

Short-circuit detection

The diagnostics for short circuit to ground can be configured for the voltage output type. A short-circuit detection is not possible for small output values; the output voltages must therefore be below -0.5 V or above +0.5 V.

Open-circuit detection

The diagnostics for open circuit can be configured for the current output type. An open-circuit detection is not possible for small output values; the output voltages must therefore be below -3 mA or above +3 mA.

4.3 Declaration of parameters

Output rate

Specifies the number of sub-cycles per isochronous data cycle for the for the oversampling function.

Missing supply voltage L+

Enabling of the diagnostics, with missing or too little supply voltage L+.

Wire break

Enabling of the diagnostics if the line to the actuator is broken.

Short circuit to ground

Enabling of the diagnostics if a short-circuit of the output to M_{ANA} occurs.

Overflow

Enabling of the diagnostics when the output value exceeds the overrange.

Underflow

Enabling of the diagnostics when the output value violates the underrange.

Reaction to CPU STOP

Determines the reaction of the output to the CPU going into STOP state.

Substitute value

The substitute value is the value that the module outputs in case of a CPU STOP.

4.4 Address space

The module can be configured differently in STEP 7; see following table. Depending on the configuration, additional/different addresses are assigned in the process image of the outputs/inputs.

Configuration options of AQ 8xU/I HS

You can configure the module with STEP 7 (TIA Portal) or with a GSD file.

When you configure the module by means of the GSD file, the configurations are available under different abbreviations/module names.

The following configurations are possible:

Table 4- 2 Configuration options

Configuration	Abbreviation/module name in the GSD file	Configuration software, e.g., with STEP 7 (TIA Portal)	
		Integrated in hardware catalog STEP 7 (TIA Portal)	GSD file in STEP 7 (TIA Portal) V12 or higher or STEP 7 V5.5 SP3 or higher
1 x 8-channel without value status	AQ 8xU/I HS	V12 or higher	X
1 x 8-channel with value status	AQ 8xU/I HS QI	V12 or higher	X
8 x 1-channel without value status	AQ 8xU/I HS S	V13 Update 3 or higher (PROFINET IO only)	X (PROFINET IO only)
8 x 1-channel with value status	AQ 8xU/I HS S QI	V13 Update 3 or higher (PROFINET IO only)	X (PROFINET IO only)
1 x 8-channel with value status for module-internal Shared Output with up to 4 submodules	AQ 8xU/I HS MSO	V13 Update 3 or higher (PROFINET IO only)	X (PROFINET IO only)
1 x 8-channel without value status for over-sampling	---	V14 or higher with HSP 0186 (PROFINET IO only)	---

Value status (Quality Information, QI)

The value status is always activated for the following module names:

- AQ 8xU/I HS QI
- AQ 8xU/I HS S QI
- AQ 8xU/I HS MSO

An additional bit is assigned to each channel for the value status. The bit for the value status indicates if the output value specified by the user program is actually pending at the module terminal (0 = value is incorrect).

Address space of the AQ 8xU/I HS and AQ 8xU/I HS QI

The following figure shows the address space allocation for the configuration as 8-channel module. You can freely assign the start address for the module. The addresses of the channels are derived from the start address.

"QB x" stands, for example, for the module start address output byte x.

Assignment in the process image output (PIQ)

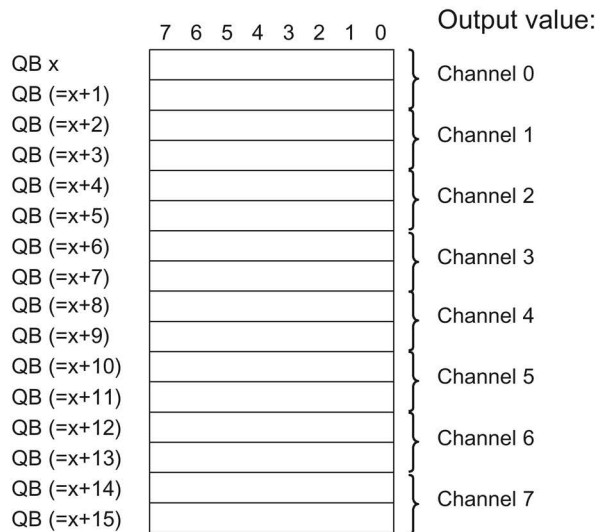

Assignment in process image input (PII)

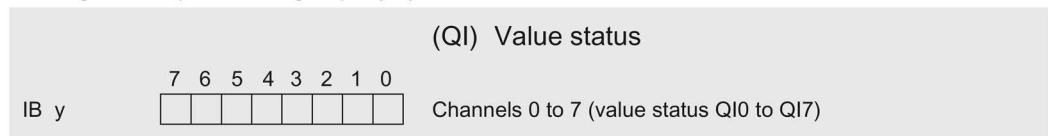

0 = Value output at the channel is faulty
1 = No fault is present on the channel

Figure 4-1 Address space for configuration as 1 x 8-channel AQ 8xU/I HS with value status

Address space for configuration as 8 x 1-channel AQ 8xU/I HS QI and AQ 8xU/I HS S QI

For the configuration as a 8 x 1-channel module, the channels of the module are divided into multiple submodules. The submodules can be assigned to different IO controllers when the module is used in a shared device.

The number of usable submodules is dependent on the interface module used. Observe the information in the manual for the particular interface module.

Contrary to the 1 x 8-channel module configuration, each of the eight submodules has a freely assignable start address.

Assignment in process image output (PIQ) and input (PII)

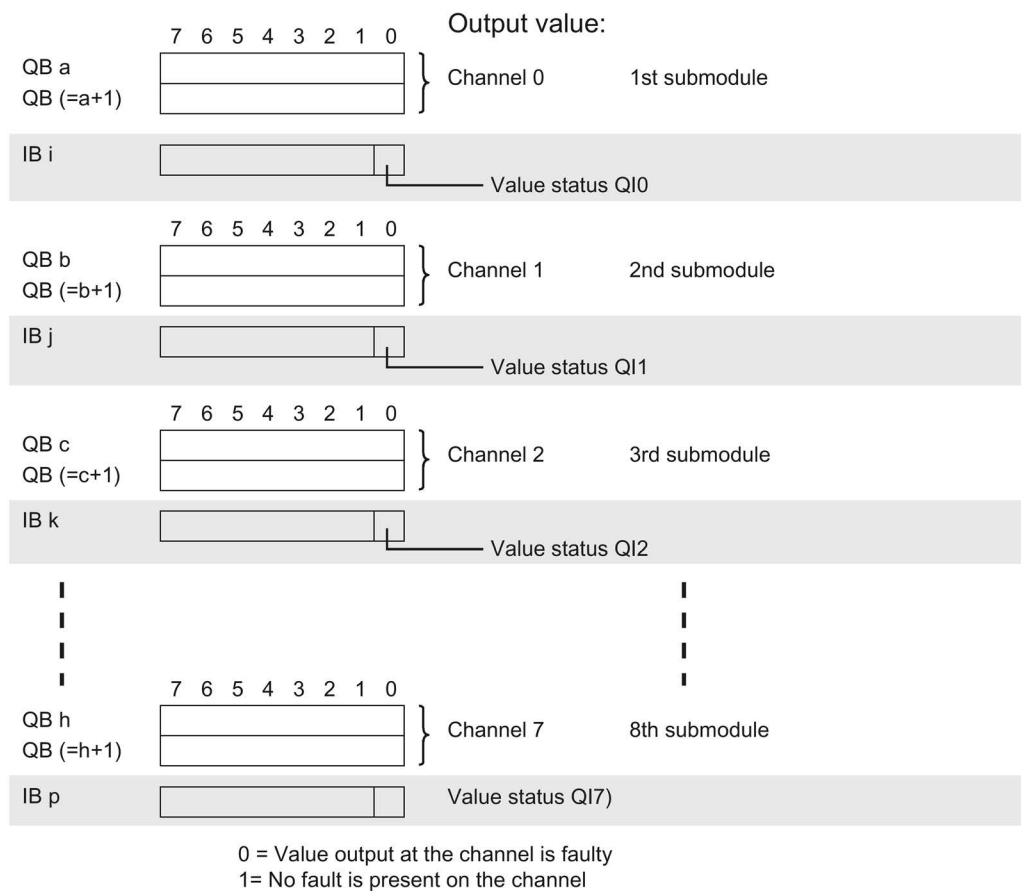

Figure 4-2 Address space for configuration as 8 x 1-channel AQ 8xU/I HS S QI with value status

Address space for configuration as 1 x 8-channel AQ 8xU/I HS MSO

For the configuration as a 1 x 8-channel module (module-internal Shared Output, MSO), channels 0 to 7 of the module are copied to multiple submodules. Channels 0 to 7 are then available with identical values in various submodules. These submodules can be assigned to up to four IO controllers when the module is used in a shared device.

- The IO controller to which submodule 1 is assigned has write access to outputs 0 to 7.
- The IO controllers to which submodule 2, 3, or 4 is assigned have read access to outputs 0 to 7.

The number of usable IO controllers depends on the interface module used. Please observe the information in the manual for the particular interface module.

Value status (Quality Information, QI)

The meaning of the value status depends on the submodule on which it occurs.

For the 1st submodule (=basic submodule), the value status 0 indicates that the value is incorrect or that the IO controller of the basic submodule is in STOP state.

For the 2nd to 4th submodule (=MSO submodule), the value status 0 indicates that the value is incorrect or one of the following errors has occurred:

- The basic submodule is not yet configured (not ready).
- The connection between the IO controller and the basic submodule has been interrupted.
- The IO controller of the basic submodule is in STOP or POWER OFF state.

4.4 Address space

The following figure shows the assignment of the address space with submodules 1 and 2.

Assignment in process image output (PIQ) and input (PII) for 1st submodule:

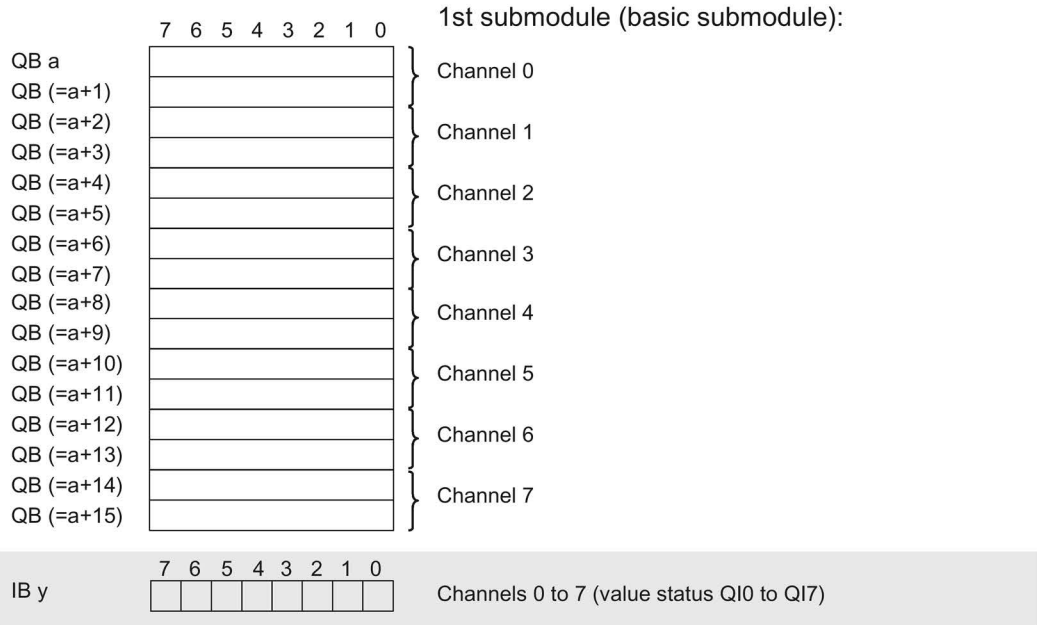

Assignment in the process image input (PII) for 2nd submodule:

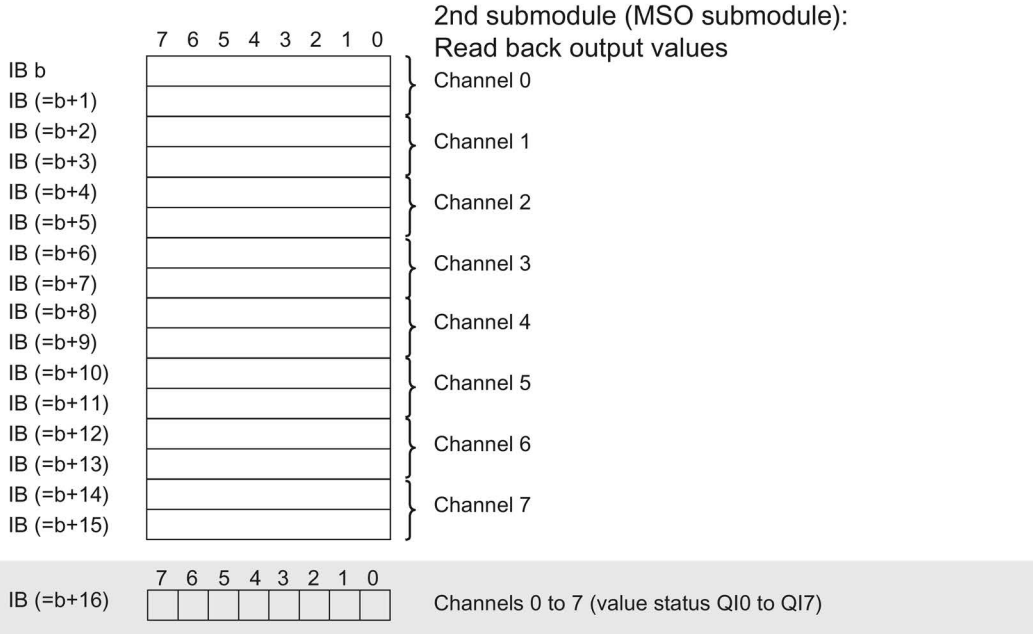

0 = Value output at the channel is faulty
1 = No fault is present on the channel

Figure 4-3 Address space for configuration as 1 x 8-channel AQ 8xU/I HS MSO with value status

The following figure shows the assignment of the address space with submodules 3 and 4.

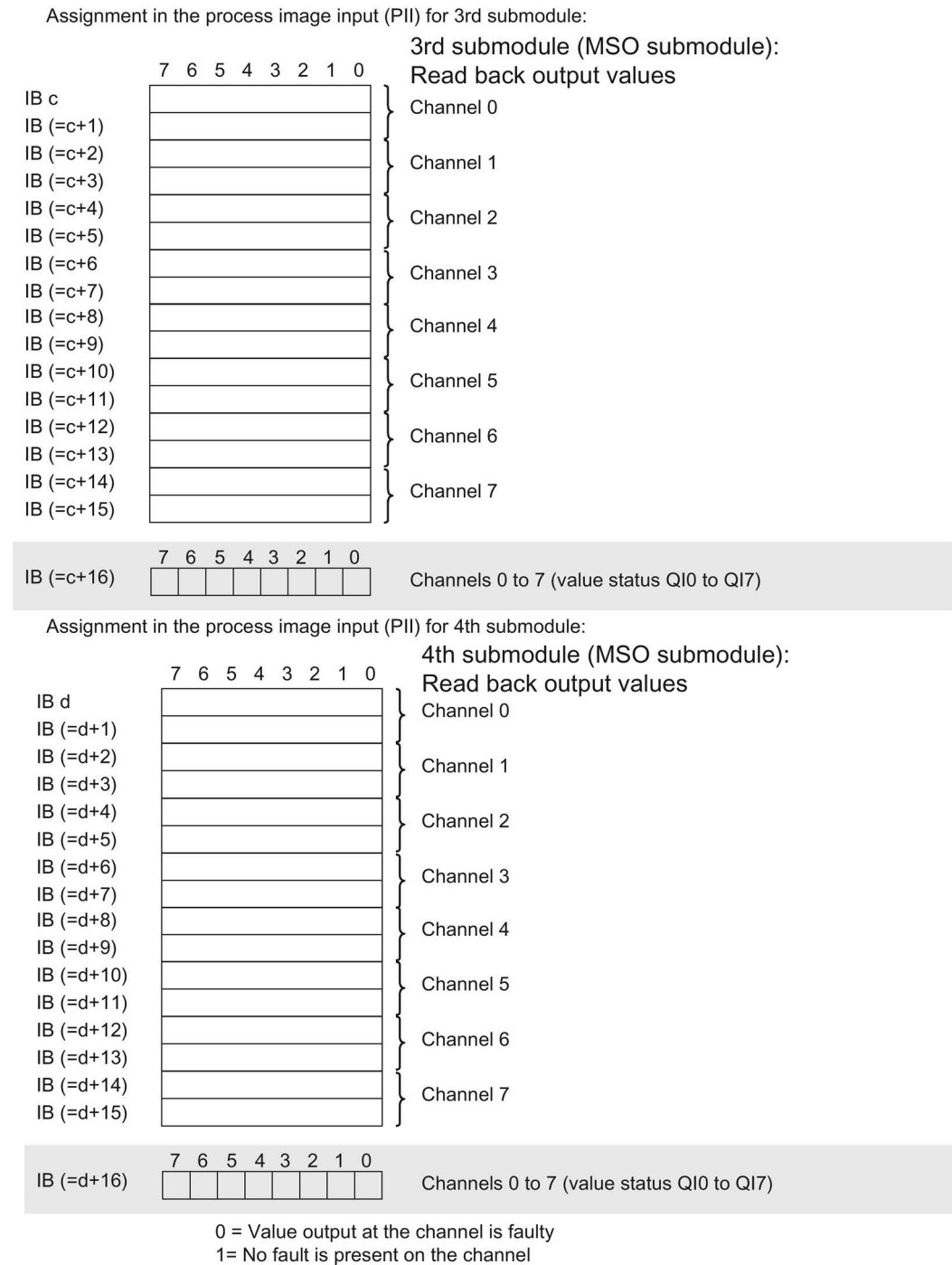

Figure 4-4 Address space for configuration as 1 x 8-channel AQ 8xU/I HS MSO with value status

Reference

You can find information on the Shared Input/Output (MSI/MSO) function in the section Module-Internal Shared Input/Output (MSI/MSO) of the PROFINET with STEP 7 V13 (<https://support.industry.siemens.com/cs/ww/en/view/49948856>) function manual.

Address space for configuration as 1 x 8-channel AQ 8xU/I HS for oversampling

The following figure shows the address space assignment with the configuration as 8-channel module for the oversampling function. You can freely assign the start address for the module. The addresses of the channels are derived from the start address.

Writing always starts from QB x. If fewer than 16 sub-cycles are set, the addresses that are then unused are ignored.

"QB x" stands, for example, for the module start address output byte x.

Assignment in process image input (PIQ)

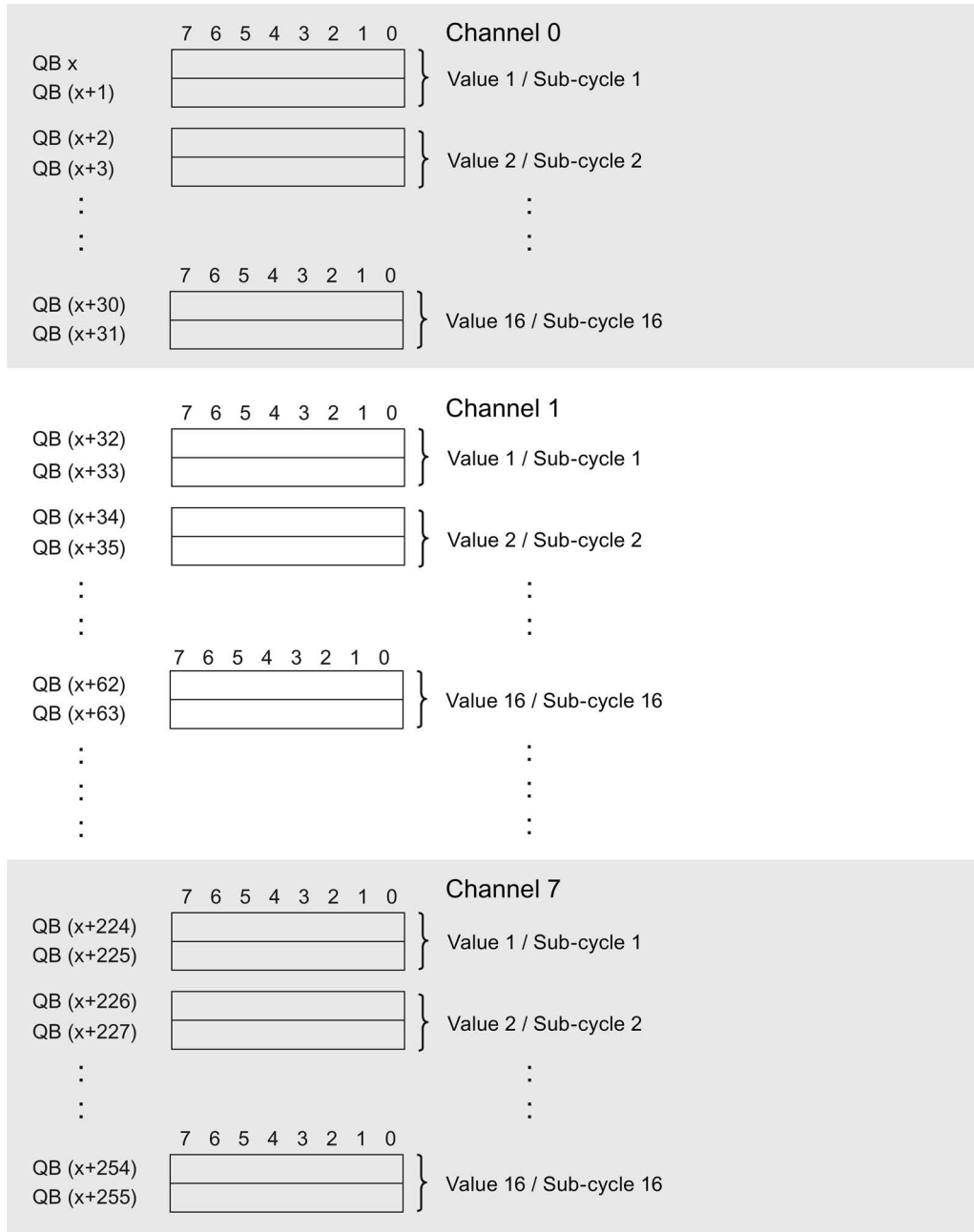

Figure 4-5 Address space for configuration as 1 x 8-channel AI 8xU/I HS for oversampling

Interrupts/diagnostics alarms

5.1 Status and error displays

LED displays

The figure below shows the LED displays (status and error displays) of the AQ 8xU/I HS.

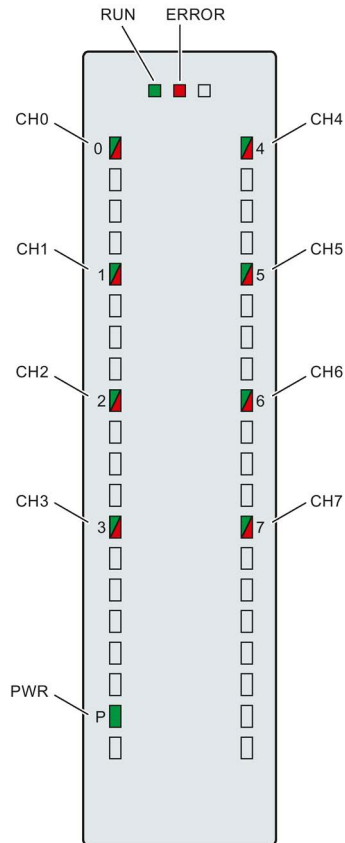

Figure 5-1 LED displays of the AQ 8xU/I HS module

Meaning of the LED displays

The following tables explain the meaning of the status and error displays. Remedial measures for diagnostic alarms can be found in section Diagnostic alarms.

RUN and ERROR LED

Table 5- 1 Status and error displays RUN and ERROR

LED		Meaning	Remedy
RUN	ERROR		
□ Off	□ Off	Voltage missing or too low at backplane bus	<ul style="list-style-type: none"> Switch on the CPU and/or the system power supply modules. Verify that the U connectors are inserted. Check to see if too many modules are inserted.
⚡ Flashes	□ Off	The module starts and flashes until the valid parameter assignment is set.	---
■ On	□ Off	Module is configured	---
■ On	⚡ Flashes	Indicates module errors (at least one error at one channel, e.g., wire break).	Evaluate the diagnostics data and eliminate the error (e.g., wire break).
⚡ Flashes	⚡ Flashes	Hardware defective	Replace the module.

PWR LED

Table 5- 2 PWR status display

LED PWR	Meaning	Remedy
□ Off	Supply voltage L+ too low or missing	Check the L+ supply voltage.
■ On	Supply voltage L+ is present and OK	---

CHx LED

Table 5- 3 CHx status display

LED CHx	Meaning	Remedy
□ Off	Channel deactivated	---
■ On	Channel configured and OK	---
■ On	Diagnostic alarm: e.g., wire break, overflow, underflow	Check the wiring. Disable diagnostics.

See also

Diagnostics alarms (Page 33)

5.2 Interrupts

The analog output module AQ 8xU/I HS supports diagnostic interrupts.

You can find detailed information on the event in the error organization block with the RALRM instruction (read additional interrupt info) and in the STEP 7 online help.

Diagnostic interrupt

The module generates a diagnostic interrupt at the following events:

- Missing supply voltage L+
- Short circuit to ground
- Wire break
- Overflow
- Underflow
- Parameter assignment error

5.3 Diagnostics alarms

A diagnostics alarm is generated and the ERROR LED flashes on the module for each diagnostics event. The diagnostics alarms can be read out in the diagnostics buffer of the CPU, for example. You can evaluate the error codes with the user program.

If the module is operated distributed with PROFIBUS DP in an ET 200MP system, you have the option to read out diagnostics data with the instruction RDREC or RD_REC using data record 0 and 1. The structure of the data records is available on the Internet in the "Manual for interface module IM 155-5 DP ST (6ES7155-5BA00-0AB0)".

Table 5- 4 Diagnostics alarms, their meaning and corrective measures

Diagnostics alarm	Error code	Meaning	Remedy
Short circuit to ground	1H	Overload at output	Eliminate overload
		Short-circuit of output Q _V to M _{ANA}	Eliminate the short-circuit
Wire break	6H	Encoder circuit impedance too high	Use a different actuator type or modify the wiring, for example, use cables with larger cross-section
		Wirebreak between the module and actuator	Connect the cable
		Channel not connected (open)	<ul style="list-style-type: none"> • Disable the channel ("output type" parameter) • Connect the channel
Overflow	7H	The output value set by the user program exceeds the valid rated range/overshoot range.	Correct the output value
Underflow	8H	The output value set by the user program undershoots the valid rated range/undershoot range.	Correct the output value
Parameter assignment error	10H	<ul style="list-style-type: none"> • The module cannot evaluate parameters for the channel • Incorrect parameter assignment. 	Correct the parameter assignment
Load voltage missing	11H	Supply voltage L+ of the module is missing	Connect supply voltage L+ to module

Technical specifications

Technical specifications of the AQ 8xU/I HS

	6ES7532-5HF00-0AB0
General information	
Product type designation	AQ 8xU/I HS
Hardware functional status	FS01
Firmware version	V2.1.0
<ul style="list-style-type: none"> FW update possible 	Yes
Product function	
I&M data	Yes; I&M0 to I&M3
Scalable output range	No
Engineering with	
STEP 7 TIA Portal can be configured/integrated as of version	V14 / -
STEP 7 can be configured/integrated as of version	V5.5 SP3 / -
PROFIBUS as of GSD version/GSD revision	V1.0 / V5.1
PROFINET as of GSD version/GSD revision	V2.3 / -
Operating mode	
Oversampling	Yes
MSO	Yes
CiR Configuration in RUN	
Configuration in RUN possible	Yes
Calibration in RUN possible	Yes
Supply voltage	
Rated value (DC)	24 V
Valid range, low limit (DC)	20.4 V
Valid range, high limit (DC)	28.8 V
Reverse polarity protection	Yes
Input current	
Current consumption, max.	260 mA; with 24 V DC supply
Power	
Power consumption from the backplane bus	1.15 W
Power loss	
Power loss, typ.	7 W

6ES7532-5HF00-0AB0	
Analog outputs	
Number of analog outputs	8
Voltage output, short-circuit protection	Yes
Voltage output, short-circuit current, max.	45 mA
Current output, open-circuit voltage, max.	20 V
Cycle time (all channels), min.	125 µs; regardless of the number of activated channels
Output ranges, voltage	
0 V to 10 V	Yes
1 V to 5 V	Yes
-10 V to +10 V	Yes
Output ranges, current	
0 mA to 20 mA	Yes
-20 mA to +20 mA	Yes
4 mA to 20 mA	Yes
Connection of actuators	
for voltage output two-wire connection	Yes
for voltage output four-wire connection	Yes
for current output two-wire connection	Yes
Load resistance (in the rated output range)	
for voltage outputs, min.	1 kΩ
for voltage outputs, capacitive load, max.	100 nF
for current outputs, max.	500 Ω
for current outputs, inductive load, max.	1 mH
Cable length	
shielded, max.	200 m
Analog value generation for the outputs	
Integration and conversion time/resolution per channel	
Resolution with overrange (bit including sign), max.	16 bit
Conversion time (per channel)	50 µs; regardless of the number of activated channels
Settling time	
for resistive load	30 µs; see additional description in the manual
for capacitive load	100 µs; see additional description in the manual
for inductive load	100 µs; see additional description in the manual

6ES7532-5HF00-0AB0	
Errors/accuracies	
Output ripple (relative to output range, bandwidth 0 to 50 kHz), (+/-)	0.02%
Linearity error (relative to output range), (+/-)	0.15%
Temperature error (in relation to output range), (+/-)	0.002%/K
Crosstalk between outputs, max.	-100 dB
Repeat accuracy in settled state at 25 °C (in relation to output range), (+/-)	0.05%
Operational limit in overall temperature range	
Voltage in relation to output range, (+/-)	0.3%
Current in relation to output range, (+/-)	0.3%
Basic error limit (operational limit at 25 °C)	
Voltage in relation to output range, (+/-)	0.2%
Current in relation to output range, (+/-)	0.2%
Isochronous mode	
Isochronous mode (application synchronized up to terminal)	Yes
Execution and activation time (TCO), min.	100 µs
Bus cycle time (TDP), min.	250 µs
Interrupts/diagnostics/status information	
Diagnostics function	Yes
Substitute values can be applied	Yes
Interrupts	
Diagnostic interrupt	Yes
Diagnostics alarms	
Monitoring of supply voltage	Yes
Wire break	Yes; only for output type current
Short-circuit	Yes; only for output type voltage
Overflow/underflow	Yes
Diagnostics indicator LED	
RUN LED	Yes; green LED
ERROR LED	Yes; red LED
Monitoring of supply voltage (PWR LED)	Yes; green LED
Channel status display	Yes; green LED
For channel diagnostics	Yes; red LED
For module diagnostics	Yes; red LED
Electrical isolation	
Electrical isolation of channels	
Between the channels	No
Between the channels, in groups of	8
Between the channels and backplane bus	Yes
Between the channels and load voltage L+	Yes

6ES7532-5HF00-0AB0	
Permitted potential difference	
between S- and MANA (UCM)	8 V DC
Isolation	
Isolation tested with	707 V DC (type test)
Distributed mode	
Prioritized startup	No
Dimensions	
Width	35 mm
Height	147 mm
Depth	129 mm
Weights	
Weight, approx.	325 g

Derating depending on overall length, ambient temperature and output type (per module)

The following trends show the number of channels (CHx) that can be used simultaneously in horizontal and vertical installation of the S7-1500 automation system/ET 200MP distributed I/O system depending on the ambient temperature.

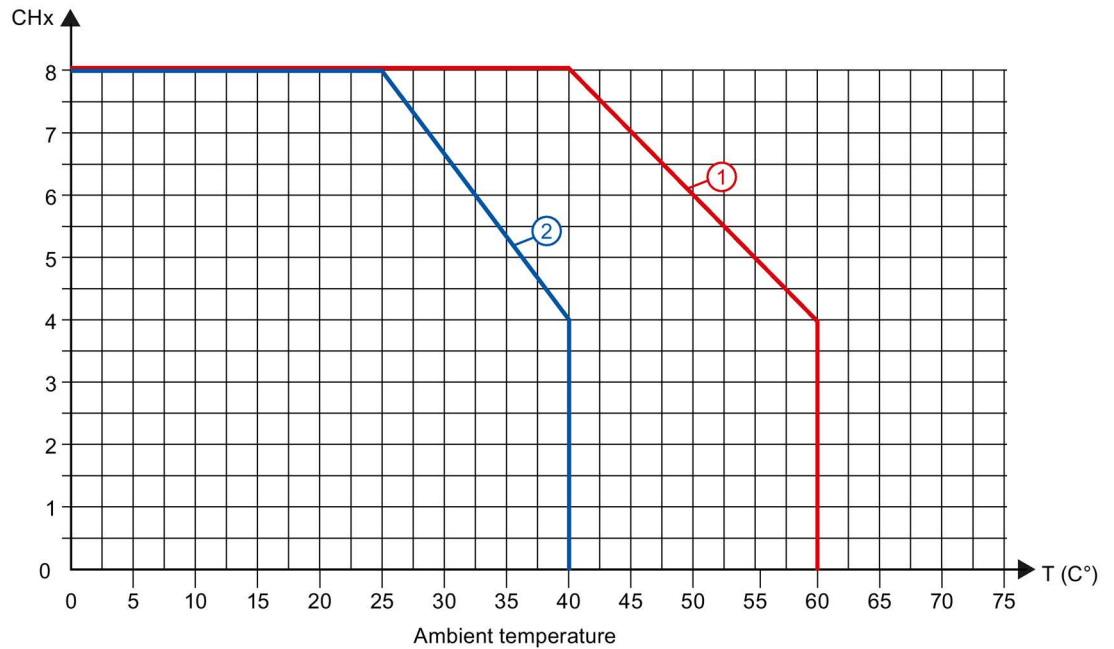

- ① Horizontal mounting of the system
- ② Vertical mounting of the system

Figure 6-1 Information on channels used simultaneously (per module) for output type: Current and voltage

Note

All eight channels can be used in the case of voltage outputs with load resistances $> 5\text{ k}\Omega$ and ambient temperatures up to 40° (vertical installation) or up to 60° (horizontal installation).

Settling times for voltage outputs

The settling time for voltage outputs is influenced mainly by the capacitive load.

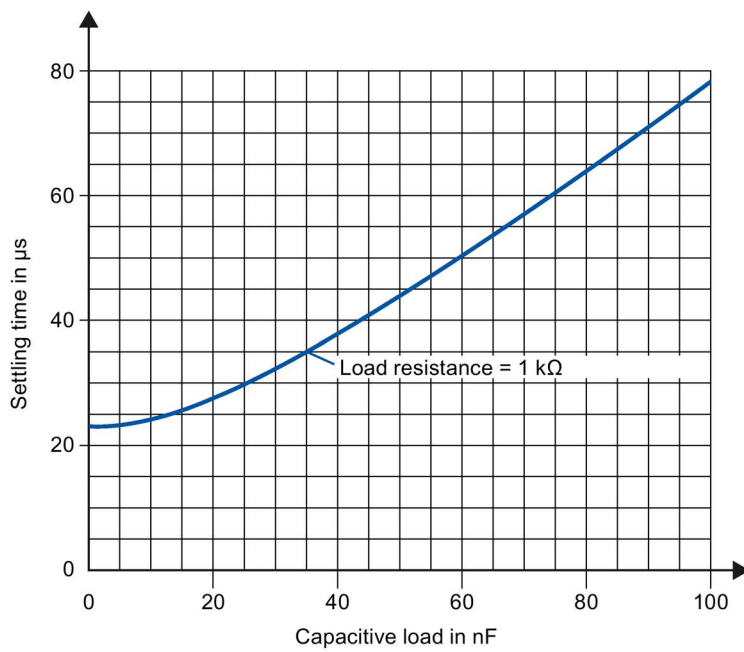

Figure 6-2 Typical settling times for voltage outputs

Settling times for current outputs

The settling time for current outputs increases when the load impedance rises.

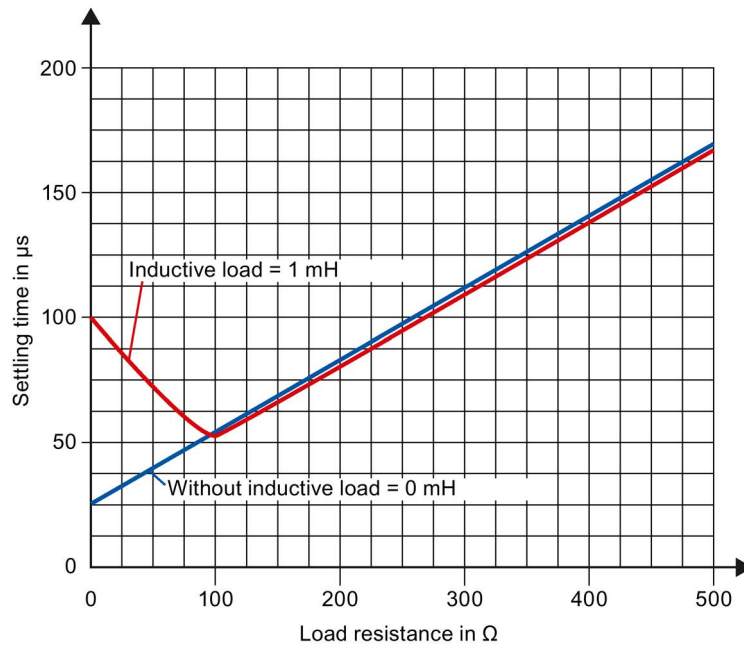

Figure 6-3 Typical settling times for current outputs

See also

Parameters (Page 19)

A

Dimensional drawing

This appendix contains the dimensional drawing of the module installed on a mounting rail and with a shield bracket. Always observe the specified dimensions for installation in cabinets, control rooms, etc.

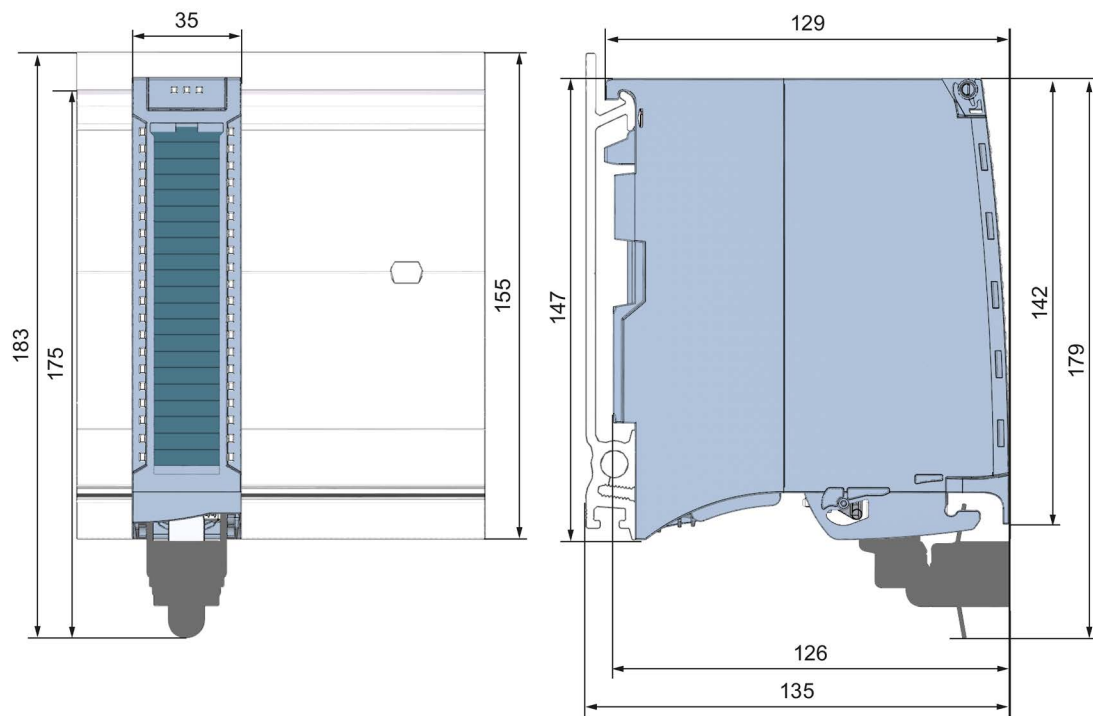

Figure A-1 Dimensional drawing of the AQ 8xU/I HS module



Figure A-2 Dimensional drawing of the AQ 8xU/I HS module, side view with open front panel

Parameter data records

B.1 Parameter assignment and structure of the parameter data records

The data records of the module have an identical structure, regardless of whether you configure the module with PROFIBUS DP or PROFINET IO.

Dependencies for configuration with GSD file

When configuring the module with a GSD file, remember that the settings of some parameters are dependent on each other. The parameters are only checked for plausibility by the module after the transfer to the module.

The following table lists the parameters that depend on one another.

Table B- 1 Dependencies of parameters for configuration with GSD file

Device-specific parameters (GSD file)	Dependent parameters
Short circuit to ground	With output type voltage only
Wire break	With output type current only
Substitute value	Only if Reaction to CPU STOP -> Output substitute value is configured

Parameter assignment in the user program

You have the option to assign module parameters in RUN (e.g., the voltage or current values of selected channels can be edited in RUN without having an effect on the other channels).

Parameter assignment in RUN

The WRREC instruction is used to transfer the parameters to the module using data records 64 to 71. The parameters set in STEP 7 do not change in the CPU, which means the parameters set in STEP 7 are still valid after a restart.

The parameters are only checked for plausibility by the module after the transfer to the module.

Output parameter STATUS

The module ignores errors that occurred during the transfer of parameters with the WRREC instruction and continues operation with the previous parameter assignment. However, a corresponding error code is written to the STATUS output parameter.

The description of the WRREC instruction and the error codes is available in the STEP 7 online help.

Operation of the module behind a PROFIBUS DP interface module

If the module is operated behind a PROFIBUS DP interface module, the parameter data records 0 and 1 are not read back. You obtain the diagnostics data records 0 and 1 with the read back parameter data records 0 and 1. You can find additional information in the Interrupts section of the manual for the PROFIBUS DP interface module on the Internet (<http://support.automation.siemens.com/WW/view/en/78324181>).

Assignment of data record and channel

The channel parameters in data records 64 to 71 are available for 1x 8-channel configuration and are assigned as follows:

- Data record 64 for channel 0
- Data record 65 for channel 1
- ...
- Data record 70 for channel 6
- Data record 71 for channel 7

For configuration 8 x 1-channel, the module has 8 submodules with one channel each. The parameters for the channel are available in data record 64 and are assigned as follows:

- Data record 64 for channel 0 (submodule 1)
- Data record 64 for channel 1 (submodule 2)
- ...
- Data record 64 for channel 5 (submodule 6)
- Data record 64 for channel 6 (submodule 7)
- Data record 64 for channel 7 (submodule 8)

Address the respective submodule for data record transfer.

Data record structure

The figure below shows the structure of data record 64 for channel 0 as an example. The structure is identical for channels 1 to 7. The values in byte 0 and byte 1 are fixed and may not be changed.

Enable a parameter by setting the corresponding bit to "1".

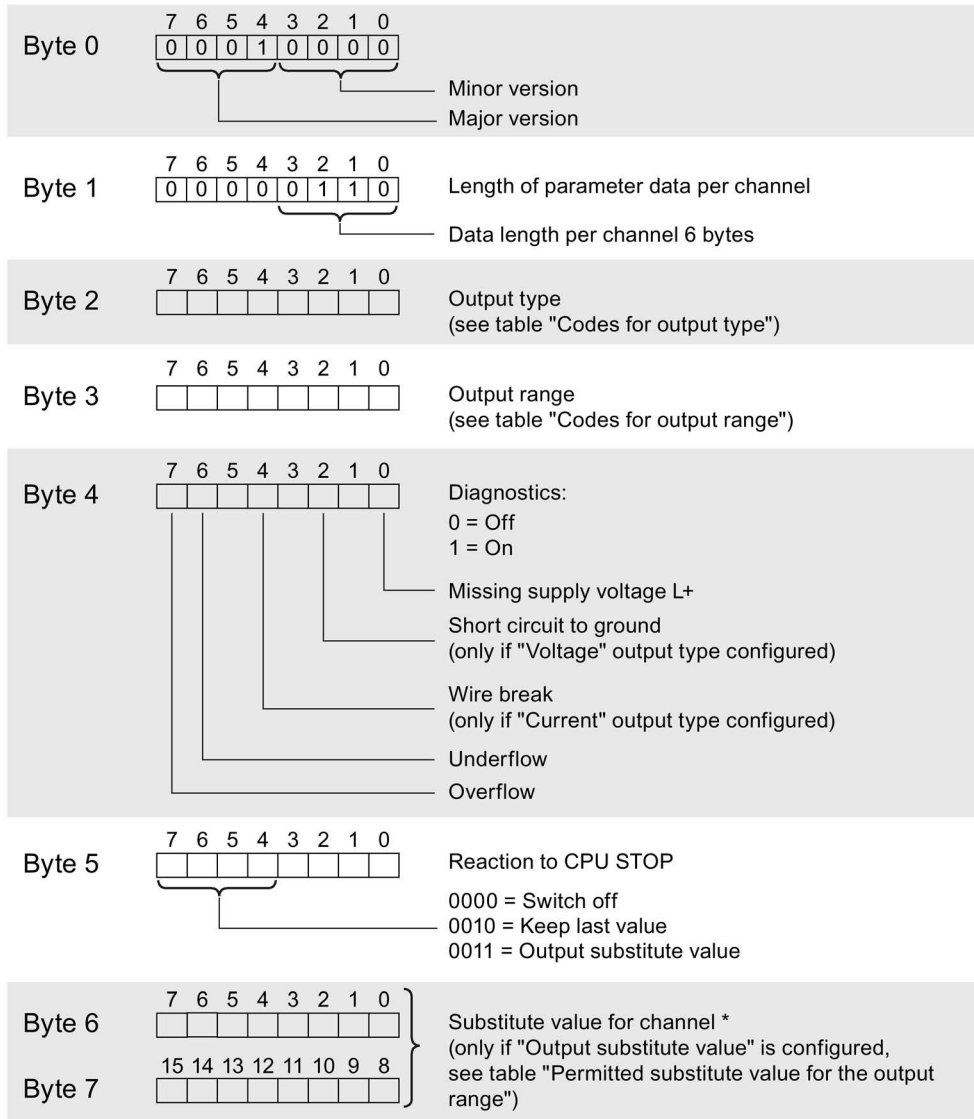

Figure B-1 Data record structure: Bytes 0 to 7

Note

You can only configure the oversampling function with STEP 7 (TIA Portal) via the output rate parameter.

Output type codes

The following table lists all output types of the analog output module along with their codes. Enter these codes at byte 2 of the data record for the corresponding channel (see the previous figure).

Table B- 2 Code for the output type

Output type	Code
Deactivated	0000 0000
Voltage	0000 0001
Current	0000 0010

Codes for the output ranges

The table below contains all output ranges of the analog output module with their codes. Enter these codes at byte 3 of the data record for the corresponding channel (see the previous figure).

Table B- 3 Output range code

Output range for voltage	Code
1 V to 5 V	0000 0011
0 V to 10 V	0000 0010
± 10 V	0000 0000
Output range for current	Code
0 mA to 20 mA	0000 0001
4 mA to 20 mA	0000 0010
± 20 mA	0000 0000

Valid substitute values

The following table lists all output ranges for the valid substitute values. Enter these substitute values at bytes 6 and 7 of the data record for the corresponding channel (see the previous figure). You can find the binary representation of the output ranges in section Representation of analog values (Page 46).

Table B- 4 Valid substitute value for the output range

Output range	Valid substitute value
± 10 V	-32512 ... +32511
1 V to 5 V	-6912 ... +32511
0 V to 10 V	0 ... +32511
± 20 mA	-32512 ... +32511
4 mA to 20 mA	-6912 ... +32511
0 mA to 20 mA	0 ... +32511

Representation of analog values

Introduction

This appendix describes the analog values for all output ranges supported by the AQ 8xU/I HS analog module.

Measured value resolution

Each analog value is written left aligned to the tags. The bits marked with "x" are set to "0".

Table C- 1 Resolution of the analog values

Resolution in bits including sign	Values		Analog value	
	dec	hex	high byte	low byte
16	1	1H	Sign 0 0 0 0 0 0 0	0 0 0 0 0 0 0 1

C.1 Representation of output ranges

The tables below set out the digitalized representation of the output ranges by bipolar and unipolar range. The resolution is 16 bits.

Table C- 2 Bipolar output ranges

Value dec.	Output value in %	Data word																Range
		2 ¹⁵	2 ¹⁴	2 ¹³	2 ¹²	2 ¹¹	2 ¹⁰	2 ⁹	2 ⁸	2 ⁷	2 ⁶	2 ⁵	2 ⁴	2 ³	2 ²	2 ¹	2 ⁰	
32511	117,589	0	1	1	1	1	1	1	0	1	1	1	1	1	1	1	1	Maximum output value*
32511	117,589	0	1	1	1	1	1	1	0	1	1	1	1	1	1	1	1	Overshoot range
27649	100,004	0	1	1	0	1	1	0	0	0	0	0	0	0	0	0	1	
27648	100,000	0	1	1	0	1	1	0	0	0	0	0	0	0	0	0	0	Rated range
1	0,003617	0	0	0	0	0	0	0	0	0	0	0	0	0	0	0	1	
0	0,000	0	0	0	0	0	0	0	0	0	0	0	0	0	0	0	0	
-1	-0,003617	1	1	1	1	1	1	1	1	1	1	1	1	1	1	1	1	
-27648	-100,000	1	0	0	1	0	1	0	0	0	0	0	0	0	0	0	0	
-27649	-100,004	1	0	0	1	0	0	1	1	1	1	1	1	1	1	1	1	Undershoot range
-32512	-117,593	1	0	0	0	0	0	0	1	0	0	0	0	0	0	0	0	
-32512	-117,593	1	0	0	0	0	0	0	1	0	0	0	0	0	0	0	0	Minimum output value**

* When values > 32511 are specified, the output value is limited to 117.589%.

** When values < -32512 are specified, the output value is limited to -117.593%.

Table C- 3 Unipolar output ranges

Value dec.	Output value in %	Data word																Range
		2 ¹⁵	2 ¹⁴	2 ¹³	2 ¹²	2 ¹¹	2 ¹⁰	2 ⁹	2 ⁸	2 ⁷	2 ⁶	2 ⁵	2 ⁴	2 ³	2 ²	2 ¹	2 ⁰	
32511	117,589	0	1	1	1	1	1	1	1	x	x	x	x	x	x	x	x	Maximum output value*
32511	117,589	0	1	1	1	1	1	1	0	1	1	1	1	1	1	1	1	Overshoot range
27649	100,004	0	1	1	0	1	1	0	0	0	0	0	0	0	0	0	1	
27648	100,000	0	1	1	0	1	1	0	0	0	0	0	0	0	0	0	0	Rated range
1	0,003617	0	0	0	0	0	0	0	0	0	0	0	0	0	0	0	1	
0	0,000	0	0	0	0	0	0	0	0	0	0	0	0	0	0	0	0	
0	0	0	0	0	0	0	0	0	0	0	0	0	0	0	0	0	0	Minimum output value**

* When values > 32511 are specified, the output value is limited to 117.589%.

** When values < 0 are specified, the output value is limited to 0%.

C.2 Representation of analog values in the voltage output ranges

The tables below list the decimal and hexadecimal values (codes) of the possible voltage output ranges.

Table C- 4 Voltage output range ± 10 V

Values			Voltage output range	Range
	dec	hex	± 10 V	
>117.589 %	>32511	>7EFF	11.76 V	Maximum output value
117.589 %	32511	7EFF	11.76 V	Overshoot range
	27649	6C01		
100 %	27648	6C00	10 V	Rated range
75 %	20736	5100	7.5 V	
0.003617 %	1	1	361.7 μ V	
0 %	0	0	0 V	
	-1	FFFF	-361.7 μ V	
-75 %	-20736	AF00	-7.5 V	
-100 %	-27648	9400	-10 V	Undershoot range
	-27649	93FF		
-117.593 %	-32512	8100	-11.76 V	Minimum output value
<-117.593 %	<-32512	<8100	-11.76 V	

Table C- 5 Voltage output range 0 V to 10 V

Values			Voltage output range	Range
	dec	hex	0 V to 10 V	
>117.589 %	>32511	>7EFF	11.76 V	Maximum output value
117.589 %	32511	7EFF	11.76 V	Overshoot range
	27649	6C01		
100 %	27648	6C00	10 V	Rated range
75 %	20736	5100	7.5 V	
0.003617 %	1	1	361.7 μ V	
0 %	0	0	0 V	
	<0	<0	0 V	
<0 %	<0	<0	0 V	

C.3 Representation of analog values in the current output ranges

Table C- 6 Voltage output range 1 V to 5 V

Values			Voltage output range	Range
	dec	hex	1 V to 5 V	
>117.589 %	>32511	>7EFF	5.70 V	Maximum output value
117.589 %	32511	7EFF	5.70 V	Overshoot range
	27649	6C01		
100 %	27648	6C00	5 V	Rated range
75 %	20736	5100	4 V	
0.003617 %	1	1	1 V +144.7 μ V	
0 %	0	0	1 V	
	-1	FFFF	1 V -144.7 μ V	
-25 %	-6912	E500	0 V	Undershoot range
<-25 %	<-6912	<E500	0 V	Minimum output value

C.3 Representation of analog values in the current output ranges

The tables below list the decimal and hexadecimal values (codes) of the possible current output ranges.

Table C- 7 Current output range ± 20 mA

Values			Current output range	Range
	dec	hex	± 20 mA	
>117.589 %	>32511	>7EFF	23.52 mA	Maximum output value
117.589 %	32511	7EFF	23.52 mA	Overshoot range
	27649	6C01		
100 %	27648	6C00	20 mA	Rated range
75 %	20736	5100	15 mA	
0.003617 %	1	1	723.4 nA	
0 %	0	0	0 mA	
	-1	FFFF	-723.4 nA	
-75 %	-20736	AF00	-15 mA	Undershoot range
-100 %	-27648	9400	-20 mA	
	-27649	93FF		
-117.593 %	-32512	8100	-23.52 mA	Minimum output value
<-117.593 %	<-32512	<8100	-23.52 mA	

C.3 Representation of analog values in the current output ranges

Table C- 8 Current output range 0 to 20 mA

Values			Current output range	Range
	dec	hex	0 mA to 20 mA	
>117.589 %	>32511	>7EFF	23.52 mA	Maximum output value
117.589 %	32511	7EFF	23.52 mA	Overshoot range
	27649	6C01		
100 %	27648	6C00	20 mA	Rated range
75 %	20736	5100	15 mA	
0.003617 %	1	1	723.4 nA	
0 %	0	0	0 mA	
<0 %	<0	<0	0 mA	

Table C- 9 Current output range 4 to 20 mA

Values			Current output range	Range
	dec	hex	4 mA to 20 mA	
>117.589 %	>32511	>7EFF	22.81 mA	Maximum output value
117.589 %	32511	7EFF	22.81 mA	Overshoot range
	27649	6C01		
100 %	27648	6C00	20 mA	Rated range
75 %	20736	5100	16 mA	
0.003617 %	1	1	4 mA	
0 %	0	0	4 mA	
	-1	FFFF		
-25 %	-6912	E500	0 mA	Minimum output value
<-25 %	<-6912	<E500	0 mA	