

SIEMENS

Operating instructions

SINAMICS

G130

Basic Operator Panel 20 (BOP20)

Edition

11/2017

www.siemens.com/drives

SIEMENS

SINAMICS

SINAMICS G130 Basic Operator Panel 20 (BOP20)

Operating Instructions

<u>Safety information</u>	1
<u>General</u>	2
<u>Installation</u>	3
<u>Setting parameters with the BOP20</u>	4
<u>Technical specifications</u>	5

Firmware version V5.1

Legal information

Warning notice system

This manual contains notices you have to observe in order to ensure your personal safety, as well as to prevent damage to property. The notices referring to your personal safety are highlighted in the manual by a safety alert symbol, notices referring only to property damage have no safety alert symbol. These notices shown below are graded according to the degree of danger.

 DANGER

indicates that death or severe personal injury will result if proper precautions are not taken.
--

 WARNING
--

indicates that death or severe personal injury may result if proper precautions are not taken.

 CAUTION
--

indicates that minor personal injury can result if proper precautions are not taken.
--

NOTICE

indicates that property damage can result if proper precautions are not taken.
--

If more than one degree of danger is present, the warning notice representing the highest degree of danger will be used. A notice warning of injury to persons with a safety alert symbol may also include a warning relating to property damage.

Qualified Personnel

The product/system described in this documentation may be operated only by **personnel qualified** for the specific task in accordance with the relevant documentation, in particular its warning notices and safety instructions. Qualified personnel are those who, based on their training and experience, are capable of identifying risks and avoiding potential hazards when working with these products/systems.

Proper use of Siemens products

Note the following:

 WARNING
--

Siemens products may only be used for the applications described in the catalog and in the relevant technical documentation. If products and components from other manufacturers are used, these must be recommended or approved by Siemens. Proper transport, storage, installation, assembly, commissioning, operation and maintenance are required to ensure that the products operate safely and without any problems. The permissible ambient conditions must be complied with. The information in the relevant documentation must be observed.
--

Trademarks

All names identified by ® are registered trademarks of Siemens AG. The remaining trademarks in this publication may be trademarks whose use by third parties for their own purposes could violate the rights of the owner.

Disclaimer of Liability

We have reviewed the contents of this publication to ensure consistency with the hardware and software described. Since variance cannot be precluded entirely, we cannot guarantee full consistency. However, the information in this publication is reviewed regularly and any necessary corrections are included in subsequent editions.

Table of contents

1	Safety information	5
1.1	General safety instructions	5
1.2	Handling electrostatic sensitive devices (ESD)	10
1.3	Industrial security	11
2	General	13
3	Installation	15
3.1	Removal.....	17
4	Setting parameters with the BOP20	19
4.1	BOP20 overview	19
4.2	Displays/indicators and using the BOP20	23
4.3	Fault and alarm displays	27
4.4	Controlling the drive using the BOP20.....	28
4.5	Important functions via BOP20	28
5	Technical specifications	31

Safety information

1.1 General safety instructions



	<p>! WARNING</p> <p>Electric shock and danger to life due to other energy sources</p> <p>Touching live components can result in death or serious injury.</p> <ul style="list-style-type: none"> • Only work on electrical equipment if you are appropriately qualified. • Always observe the country-specific safety rules for all work. <p>Generally, the following steps apply when establishing safety:</p> <ol style="list-style-type: none"> 1. Prepare for disconnection. Notify all those who will be affected by the procedure. 2. Isolate the drive system from the power supply and take measures to prevent it being switched back on again. 3. Wait until the discharge time specified on the warning labels has elapsed. 4. Check that there is no voltage between any of the power connections, and between any of the power connections and the protective conductor connection. 5. Check that every auxiliary circuit is de-energized. 6. Ensure that the motors cannot move. 7. Identify all other dangerous energy sources, e.g. compressed air, hydraulic systems or water. Switch the energy sources to a safe state. 8. Check that the correct drive system is completely locked. <p>After you have completed the work, restore the operational readiness by following the above steps in the reverse order.</p>
--	---



	<p>! WARNING</p> <p>Electric shock due to connection to an unsuitable power supply</p> <p>When equipment is connected to an unsuitable power supply, exposed components may carry a hazardous voltage that might result in serious injury or death.</p> <ul style="list-style-type: none"> • Only use power supplies that provide SELV (Safety Extra Low Voltage) or PELV (Protective Extra Low Voltage) output voltages for all connections and terminals of the electronics modules.
--	---



 WARNING
Electric shock due to equipment damage
Improper handling may cause damage to equipment. For damaged devices, hazardous voltages can be present at the enclosure or at exposed components; if touched, this can result in death or severe injury.
<ul style="list-style-type: none">• Ensure compliance with the limit values specified in the technical data during transport, storage and operation.• Do not use any damaged devices.



 WARNING
Electric shock due to unconnected cable shield
Hazardous touch voltages can occur through capacitive cross-coupling due to unconnected cable shields.
<ul style="list-style-type: none">• Connect cable shields and unused conductors of power cables (e.g. brake conductors) at least on one side to the grounded housing potential.



 WARNING
Electric shock if there is no ground connection
For missing or incorrectly implemented protective conductor connection for devices with protection class I, high voltages can be present at open, exposed parts, which when touched, can result in death or severe injury.
<ul style="list-style-type: none">• Ground the device in compliance with the applicable regulations.



 WARNING
Arcing when a plug connection is opened during operation
Opening a plug connection when a system is in operation can result in arcing that may cause serious injury or death.
<ul style="list-style-type: none">• Only open plug connections when the equipment is in a voltage-free state, unless it has been explicitly stated that they can be opened in operation.

NOTICE
Property damage due to loose power connections
Insufficient tightening torques or vibration can result in loose power connections. This can result in damage due to fire, device defects or malfunctions.
<ul style="list-style-type: none">• Tighten all power connections to the prescribed torque.• Check all power connections at regular intervals, particularly after equipment has been transported.

 **WARNING****Spread of fire from built-in devices**

In the event of fire outbreak, the enclosures of built-in devices cannot prevent the escape of fire and smoke. This can result in serious personal injury or property damage.

- Install built-in units in a suitable metal cabinet in such a way that personnel are protected against fire and smoke, or take other appropriate measures to protect personnel.
- Ensure that smoke can only escape via controlled and monitored paths.

 **WARNING****Failure of pacemakers or implant malfunctions due to electromagnetic fields**

Electromagnetic fields (EMF) are generated by the operation of electrical power equipment, such as transformers, converters, or motors. People with pacemakers or implants in the immediate vicinity of this equipment are at particular risk.

- If you have a heart pacemaker or implant, maintain a minimum distance of 2 m from electrical power equipment.

 **WARNING****Unexpected movement of machines caused by radio devices or mobile phones**

When radio devices or mobile phones with a transmission power > 1 W are used in the immediate vicinity of components, they may cause the equipment to malfunction. Malfunctions may impair the functional safety of machines and can therefore put people in danger or lead to property damage.

- If you come closer than around 2 m to such components, switch off any radio devices or mobile phones.
- Use the "SIEMENS Industry Online Support App" only on equipment that has already been switched off.

 **WARNING****Motor fire in the event of insulation overload**

There is a greater load on the motor insulation as result of a ground fault in an IT system. If the insulation fails, it is possible that death or severe injury can occur as a result of smoke and fire.

- Use a monitoring device that signals an insulation fault.
- Correct the fault as quickly as possible so the motor insulation is not overloaded.

 **WARNING**

Fire due to inadequate ventilation clearances

Inadequate ventilation clearances can cause overheating of components with subsequent fire and smoke. This can cause severe injury or even death. This can also result in increased downtime and reduced service lives for devices/systems.

- Ensure compliance with the specified minimum clearance as ventilation clearance for the respective component.

 **WARNING**

Unrecognized dangers due to missing or illegible warning labels

Dangers might not be recognized if warning labels are missing or illegible. Unrecognized dangers may cause accidents resulting in serious injury or death.

- Check that the warning labels are complete based on the documentation.
- Attach any missing warning labels to the components, where necessary in the national language.
- Replace illegible warning labels.

NOTICE

Device damage caused by incorrect voltage/insulation tests

Incorrect voltage/insulation tests can damage the device.

- Before carrying out a voltage/insulation check of the system/machine, disconnect the devices as all converters and motors have been subject to a high-voltage test by the manufacturer, and therefore it is not necessary to perform an additional test within the system/machine.

 **WARNING**

Unexpected movement of machines caused by inactive safety functions

Inactive or non-adapted safety functions can trigger unexpected machine movements that may result in serious injury or death.

- Observe the information in the appropriate product documentation before commissioning.
- Carry out a safety inspection for functions relevant to safety on the entire system, including all safety-related components.
- Ensure that the safety functions used in your drives and automation tasks are adjusted and activated through appropriate parameterizing.
- Perform a function test.
- Only put your plant into live operation once you have absolutely guaranteed that the functions relevant to safety are operating correctly.

Note

Important safety instructions for Safety Integrated functions

If you want to use Safety Integrated functions, you must observe the safety instructions in the Safety Integrated manuals.

1.2 Handling electrostatic sensitive devices (ESD)

Electrostatic sensitive devices (ESD) are individual components, integrated circuits, modules or devices that may be damaged by either electric fields or electrostatic discharge.



NOTICE

Damage through electric fields or electrostatic discharge

Electric fields or electrostatic discharge can cause malfunctions through damaged individual components, integrated circuits, modules or devices.

- Only pack, store, transport and send electronic components, modules or devices in their original packaging or in other suitable materials, e.g. conductive foam rubber or aluminum foil.
- Only touch components, modules and devices when you are grounded by one of the following methods:
 - Wearing an ESD wrist strap
 - Wearing ESD shoes or ESD grounding straps in ESD areas with conductive flooring
- Only place electronic components, modules or devices on conductive surfaces (table with ESD surface, conductive ESD foam, ESD packaging, ESD transport container).

The necessary ESD protective measures are clearly illustrated in the following diagram:

- a = conductive floor surface
- b = ESD table
- c = ESD shoes
- d = ESD overall
- e = ESD wristband
- f = cabinet ground connection
- g = contact with conductive flooring

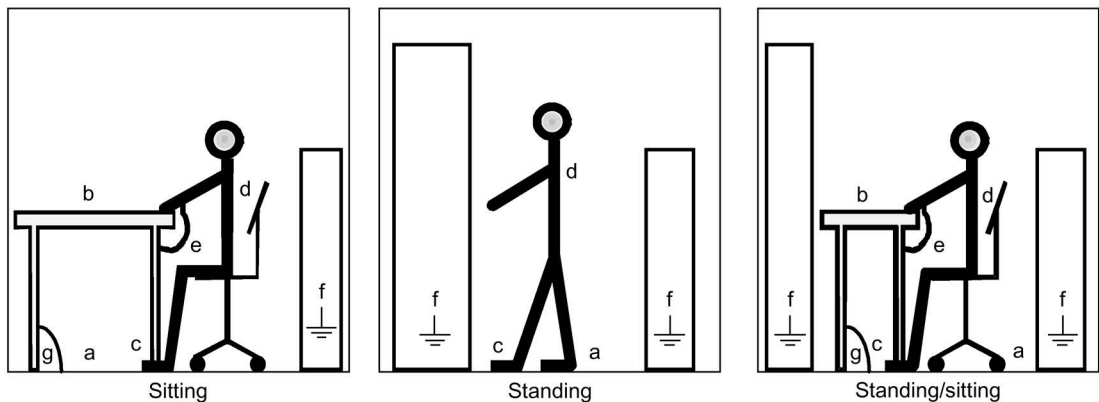

Figure 1-1 ESD protective measures

1.3 Industrial security

Note

Industrial Security

Siemens provides products and solutions with industrial security functions that support the secure operation of plants, systems, machines and networks.

In order to protect plants, systems, machines and networks against cyber threats, it is necessary to implement – and continuously maintain – a holistic, state-of-the-art Industrial Security concept. Siemens products and solutions only represent one component of such a concept.

The customer is solely responsible for preventing unauthorized access to its plants, systems, machines and networks. Systems, machines and components should only be connected to the company's network or the internet if and to the extent necessary and with appropriate security measures (e.g. use of firewalls and network segmentation) in place.

Additionally, Siemens' guidance on appropriate security measures should be taken into account. For more information about Industrial Security, please visit:

Industrial Security (<http://www.siemens.com/industrialsecurity>).

Siemens' products and solutions undergo continuous development to make them more secure. Siemens strongly recommends to apply product updates as soon as available and to always use the latest product versions. Use of product versions that are no longer supported, and failure to apply latest updates may increase customer's exposure to cyber threats.

To stay informed about product updates, subscribe to the Siemens Industrial Security RSS Feed at:

Industrial Security (<http://www.siemens.com/industrialsecurity>).

WARNING

Unsafe operating states resulting from software manipulation

Software manipulation (e.g. viruses, trojans, malware or worms) can cause unsafe operating states in your system that may lead to death, serious injury, and property damage.

- Keep the software up to date.
- Incorporate the automation and drive components into a holistic, state-of-the-art industrial security concept for the installation or machine.
- Make sure that you include all installed products into the holistic industrial security concept.
- Protect files stored on exchangeable storage media from malicious software by applying suitable protection measures, e.g. virus scanners.

Note

Industrial security Configuration Manual

You can find a Configuration Manual on the topic of industrial security at this address (<https://support.industry.siemens.com/cs/ww/en/view/108862708>).

General

Description

The BOP20 Basic Operator Panel is a basic operator panel with six keys and a backlit display unit.

The BOP20 can be plugged onto the SINAMICS Control Unit and operated.

The BOP20 supports the following functions:

- Entering parameters and activating functions
- Displaying operating modes, parameters, alarms, and faults



Figure 2-1 BOP20

The following photos and captions explain how to assemble the Basic Operator Panel 20 (BOP20) on the Control Unit.

NOTICE
Damage to the interface for the BOP20 at the Control Unit through tilting
If the BOP20 is skewed when inserting or withdrawing it, this can damage the interface for the BOP20.
<ul style="list-style-type: none"> • Make sure that you insert and withdraw the BOP20 straight into/out of the Control Unit and that it is not tilted up or down.

Table 3- 1 Mounting a Basic Operator Panel BOP20 using the CU320-2 DP as an example

<p>1. Press the latching cams together and remove the blanking cover.</p>	<p>2. Insert the memory card in the slot provided.</p>

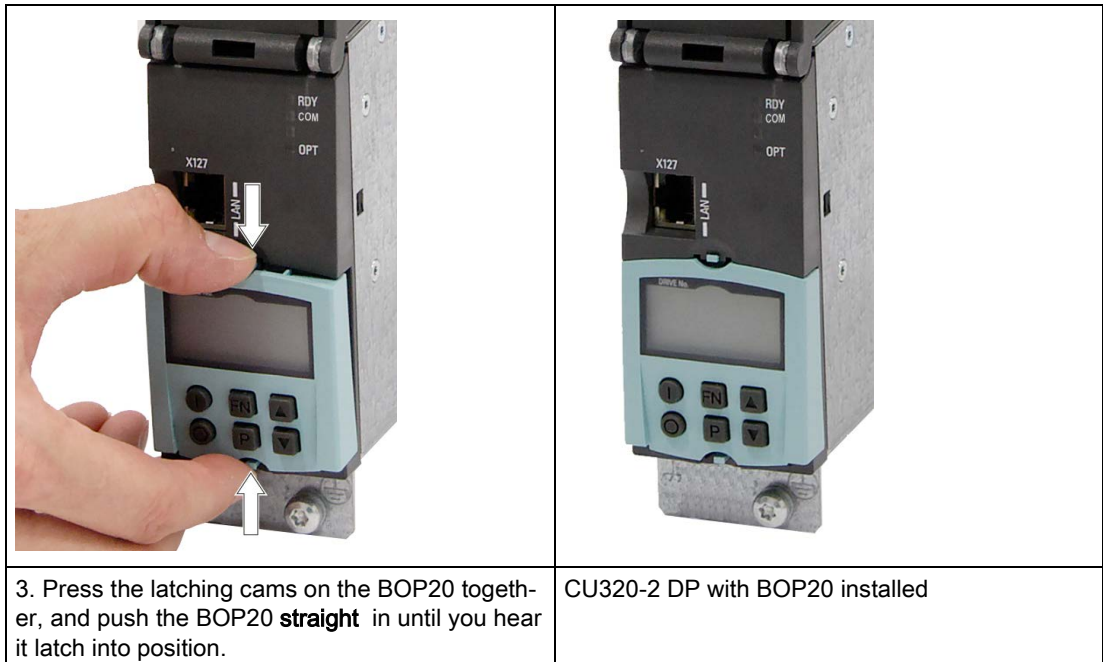

3.1 Removal

Please note the following information when removing the BOP20 from the Control Unit:

1. Simultaneously press the latching cams on the BOP20.
2. Always withdraw the BOP20 straight out (without skewing it). Never withdraw the BOP20 by pulling it at its lower edge, as this could damage the interface at the rear.

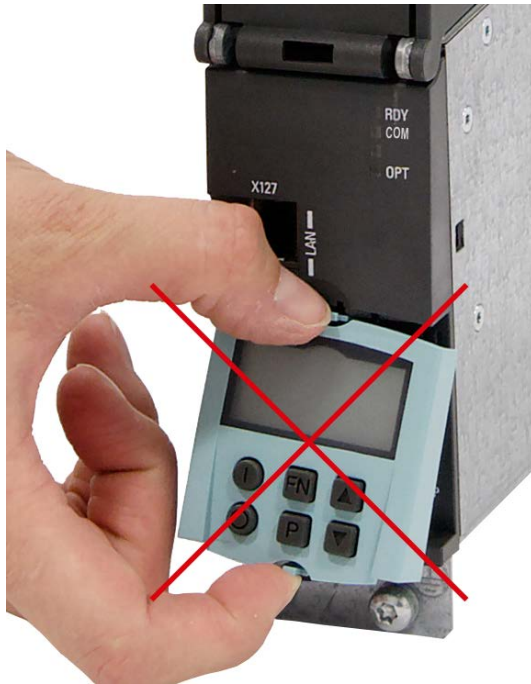

Figure 3-1 Incorrect removal of the BOP20 from a CU320-2 DP (example)

Setting parameters with the BOP20

4.1 BOP20 overview

Overview of displays and keys

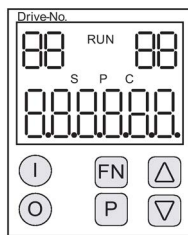

Figure 4-1 Overview of displays and keys







Information on the displays

Table 4- 1 Displays/indicators

Display	Meaning
Top left, 2 chars.	The active drive object of the BOP is displayed here. The displays and key operations always refer to this drive object.
RUN	Lit if at least one drive in the drive line-up is in the RUN state (in operation). RUN is also displayed via bit r0899.2 of the drive.
Top right, 2 chars.	The following is displayed in this field: <ul style="list-style-type: none"> • More than 6 digits: Characters that are present but cannot be seen (e.g. "r2" → 2 characters to the right are invisible, "L1" → 1 character to the left is invisible) • Faults: Selects/displays other drives with faults • Designation of BICO inputs (bi, ci) • Designation of BICO outputs (bo, co) • Source object of a BICO interconnection to a drive object other than the active one.
S	Lit if at least one parameter was changed and the value was not transferred to the non-volatile memory.
P	Lit if the parameter value does not become effective until the P key is pressed.
C	Lit if at least one parameter was changed and the calculation for consistent data management has still not been initiated.
Bottom, 6 chars.	Displays parameters, indices, faults, and alarms.

Information on the keys

Table 4- 2 Keys

Key	Name	Meaning
	ON	Switches on the drives for which the command "ON/OFF1" is to be issued from the BOP. Binector output r0019.0 is set using this key.
	OFF	Switches off the drives for which the commands "ON/OFF1", "OFF2", and "OFF3" are to be issued from the BOP. The binector outputs r0019.0, .1 and .2 are reset simultaneously when this key is pressed. After the key has been released, binector outputs r0019.0, .1 and .2 are again set to a "1" signal.
		Note: The effectiveness of these keys can be defined by parameterizing the BICO (e.g. these keys can be used to control all of the existing drives simultaneously).
	Functions	The significance of this key depends on the current display. Note: The effectiveness of this key for acknowledging faults can be defined by parameterizing the BiCo accordingly.
	Parameters	The significance of this key depends on the current display. If this key is pressed for 3 s, the "Copy RAM to ROM" function is executed. The "S" displayed on the BOP disappears.
	Raise	The keys depend on the current display and are used to either raise or lower values.
	Lower	

BOP20 functions

Name	Meaning
Backlighting	The backlighting can be set using p0007 in such a way that it switches itself off automatically after the set time if no actions are carried out.
Changeover active drive	From the point of view of the BOP, the active drive is defined using p0008 or using the "Fn" keys and "Arrow up".
Units	The units are not displayed on the BOP.
Access level	The access level for the BOP is defined using p0003. The higher the access level, the more parameters can be selected via the BOP.
Parameter filter	The parameter filter in p0004 can be used to filter the available parameters in accordance with their particular function.
Selecting the status display	Actual values and setpoints are displayed on the status display. The status display can be set using p0006.
User parameter list	The user parameter list in p0013 can be used to select access parameters.
Unplug while voltage is present	The BOP can be unplugged and plugged in again while the device is live. <ul style="list-style-type: none"> • The ON and OFF buttons have a function. Unplugging the BOP causes the drives to coast to a standstill. When the BOP is plugged in again, the drives must be switched on again. • The ON and OFF buttons have no function. Unplugging and plugging the BOP in again has no effect on the drives.
Actuating keys	The following applies to the "P" and "Fn" keys: When used in a combination with another key, "P" or "Fn" must be pressed first and then the other key.

Parameters

All drive objects

- p0005 BOP status display selection
- p0006 BOP status display mode
- p0013 BOP user-defined list
- p0971 Save drive object parameters

Drive object, Control Unit

- r0000 BOP status display
- p0003 BOP access level
- p0004 BOP parameter menu
- p0007 Backlighting display delay time
- p0008 BOP drive object selection
- p0009 Device commissioning parameter filter
- p0011 BOP password input (p0013)
- p0012 BOP password confirmation (p0013)
- r0019 CO/BO: Control word, BOP
- p0977 Save all parameters

Other drive objects (e.g. VECTOR, TM31, ...)

- p0010 Commissioning parameter filter

4.2 Displays/indicators and using the BOP20

Status display

The status display for each drive object can be set using p0005 and p0006. Using the status display, you can switch to the parameter display or to a different drive object. The following functions are supported:

- Changing the active drive object
 - Press the "Fn" key and "Arrow up" -> the drive object number at the top left flashes.
 - Select the required drive object using the arrow keys.
 - Confirm with the "P" key.
- Parameter display
 - Press the "P" key.
 - The required parameter can be selected using the arrow keys.
 - Press the "Fn" key -> parameter r0000 is displayed.
 - Press the "P" key -> returns to the status display.

Parameter display

The parameters are selected in the BOP20 using the number. To call up the parameter display from the status display, press the "P" key. You can search for the parameters you require using the arrow keys. To display the parameter value, press the "P" key again. You can toggle between the drive objects by pressing the "Fn" keys and the arrow keys simultaneously. You can toggle between r000 and the parameter that was last displayed by pressing the "Fn" key in the parameter display.

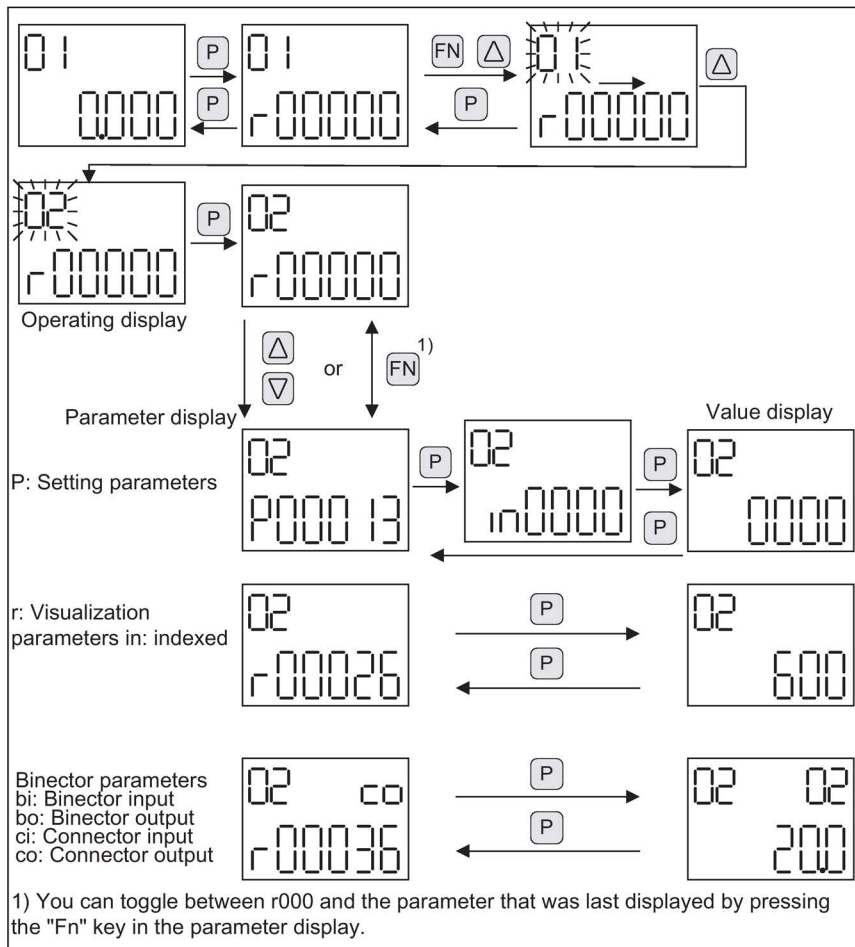

Figure 4-2 Parameter display

Value display

To switch from the parameter display to the value display, press the "P" key. In the value display, the values of the setting parameters can be increased and decreased using the arrow keys. The cursor can be selected using the "Fn" key.

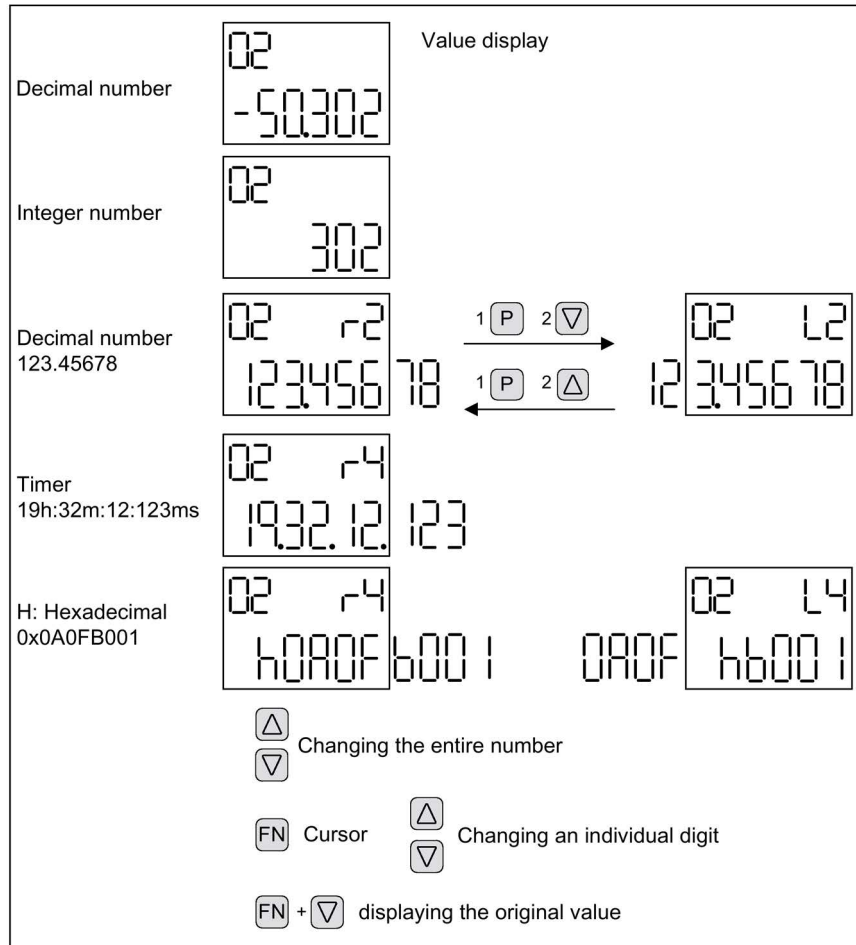

Figure 4-3 Value display

Examples

Example 1: Changing a parameter

Prerequisite: The appropriate access level is set (for this particular example, p0003 = 3).

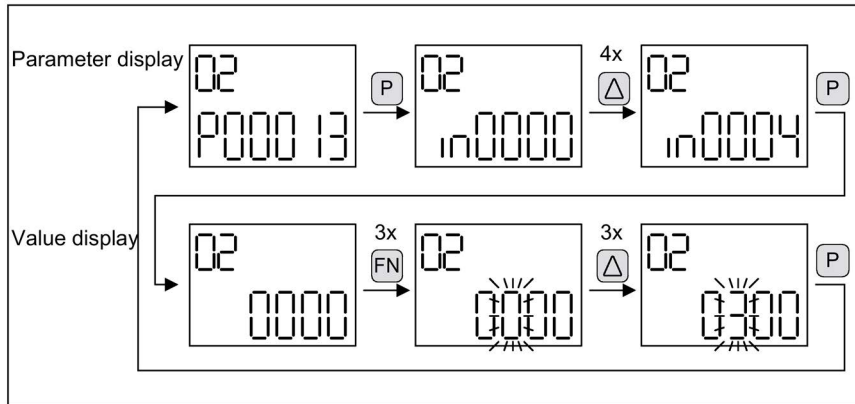

Figure 4-4 Example: Change p0013[4] from "0000" to "0300".

Example 2: Changing binector and connector input parameters

Binector output r0019.0 of the Control Unit (drive object 1) is connected to binector input p0840[0] (OFF1) of drive object 2.

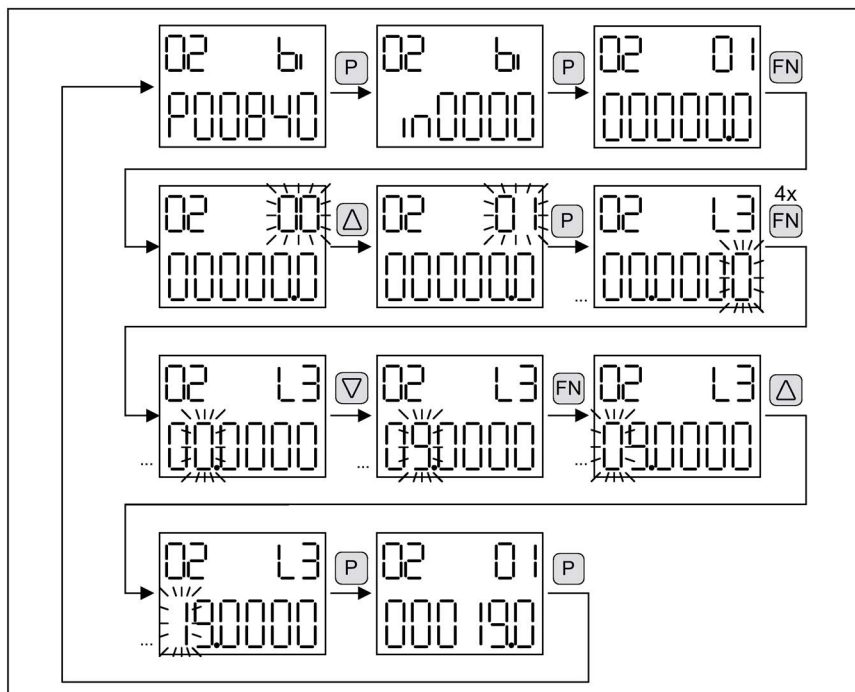

Figure 4-5 Example: Changing the indexed binector parameters

4.3 Fault and alarm displays

Displaying faults

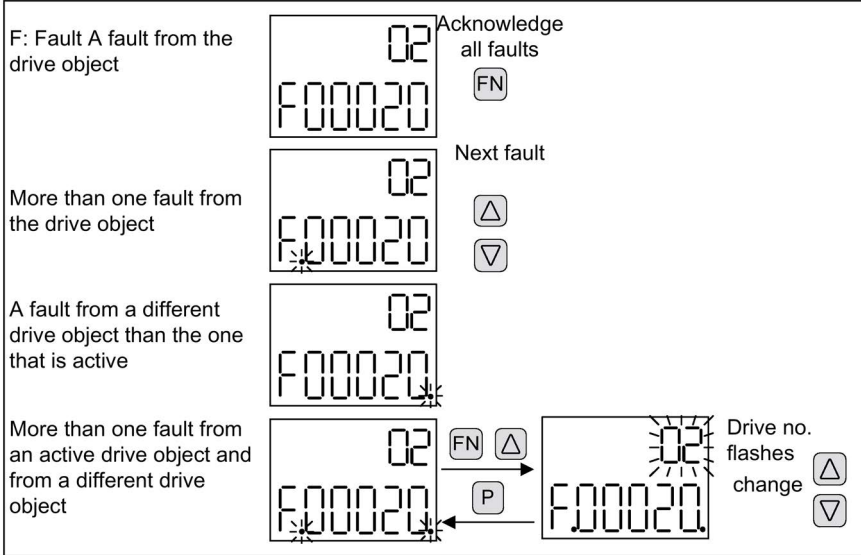

Figure 4-6 Displaying faults

Displaying alarms

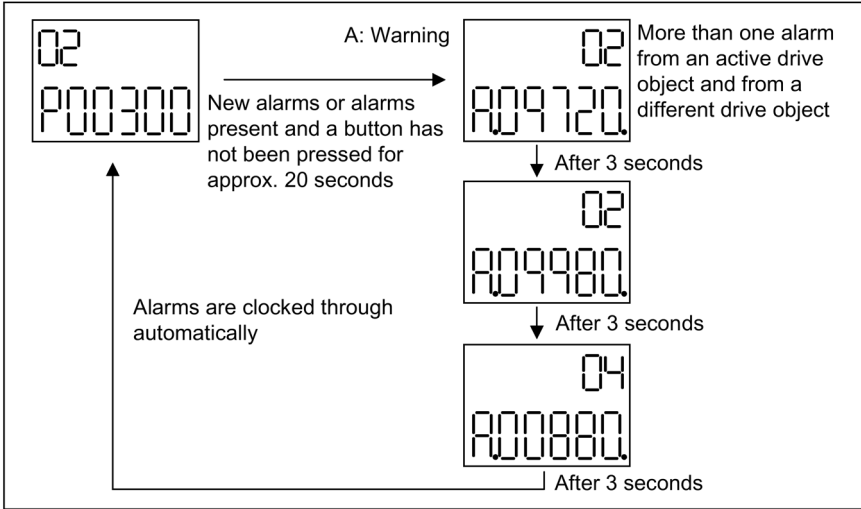

Figure 4-7 Displaying alarms

4.4 Controlling the drive using the BOP20

Description

When the drive is commissioned, it can be controlled via the BOP20. A control word is available on the Control Unit drive object (r0019) for this purpose, which can be interconnected with the appropriate binector inputs of the drive.

The interconnections do not function if a standard PROFIdrive telegram was selected as its interconnection cannot be disconnected.

Table 4- 3 BOP20 control word

Bit (r0019)	Signal name	1 signal	0 signal	Example, interconnection parameters
00	ON / OFF (OFF1)	ON	OFF	p0840
01	No coast down/coast down (OFF2)	No coast down	Coast down (OFF2)	p0844
02	No fast stop/fast stop (OFF3)	No fast stop	Fast stop (OFF3)	p0848
07	Acknowledge fault (0 -> 1)	Yes	No	p2102
13	Motorized potentiometer, raise	Yes	No	p1035
14	Motorized potentiometer, lower	Yes	No	p1036

Note

Simple commissioning

For simple commissioning, only bit 0 should be interconnected. When bits 0 ... 2 are interconnected, the system is switched off according to the following priority: OFF2, OFF3, OFF1.

4.5 Important functions via BOP20

Description

The BOP20 can be used to execute the following functions (via parameters) that help you handle your projects more efficiently:

- Restore the factory settings
- Copy from RAM to ROM
- Identification via LED
- Acknowledge error

Restore the factory settings

The factory setting of the complete device can be restored in the CU drive object.

- p0009 = 30
- p0976 = 1

Copy from RAM to ROM

You can initiate the saving of all parameters to the non-volatile memory (memory card) in the drive object CU:

- Press the "P" key for 3 seconds or
- p0977 = 1

Note

Parameter rejection with active identification

This parameter is not accepted if an identification routine (e.g. motor identification routine) has been selected on a drive.

Identification via LED

The main component of a drive object (e.g. power section) can be identified using the index of p0124. The ready LED on the module starts to flash. The index corresponds to the index in p0107; the drive object type can be identified using this parameter.

The drive objects can be identified using the following parameters:

- p0124 Power unit detection via LED
- p0144 Voltage Sensing Module detection via LED
- p0144 Sensor Module detection via LED
- p0154 DRIVE-CLiQ hub identification using LED
- p0154 Terminal Module detection via LED

Acknowledge error

All errors whose cause has been rectified can be acknowledged by pressing the Fn key.

Technical specifications

Table 5- 1 Technical specifications

Basic Operator Panel 20 (BOP20)	
Electronics power supply	3.3 V DC (provided by CU320)
Weight	0.02 kg

Additional information

Siemens:
www.siemens.com

Industry Online Support (service and support):
www.siemens.com/online-support

IndustryMall:
www.siemens.com/industrymall

Siemens AG
Process Industries and Drives
Large Drives
Postbox 4743
90025 Nuremberg
Germany

Scan the QR-Code
for product
information

