

Hardware

Order No.
GATS 1314 99 R2001

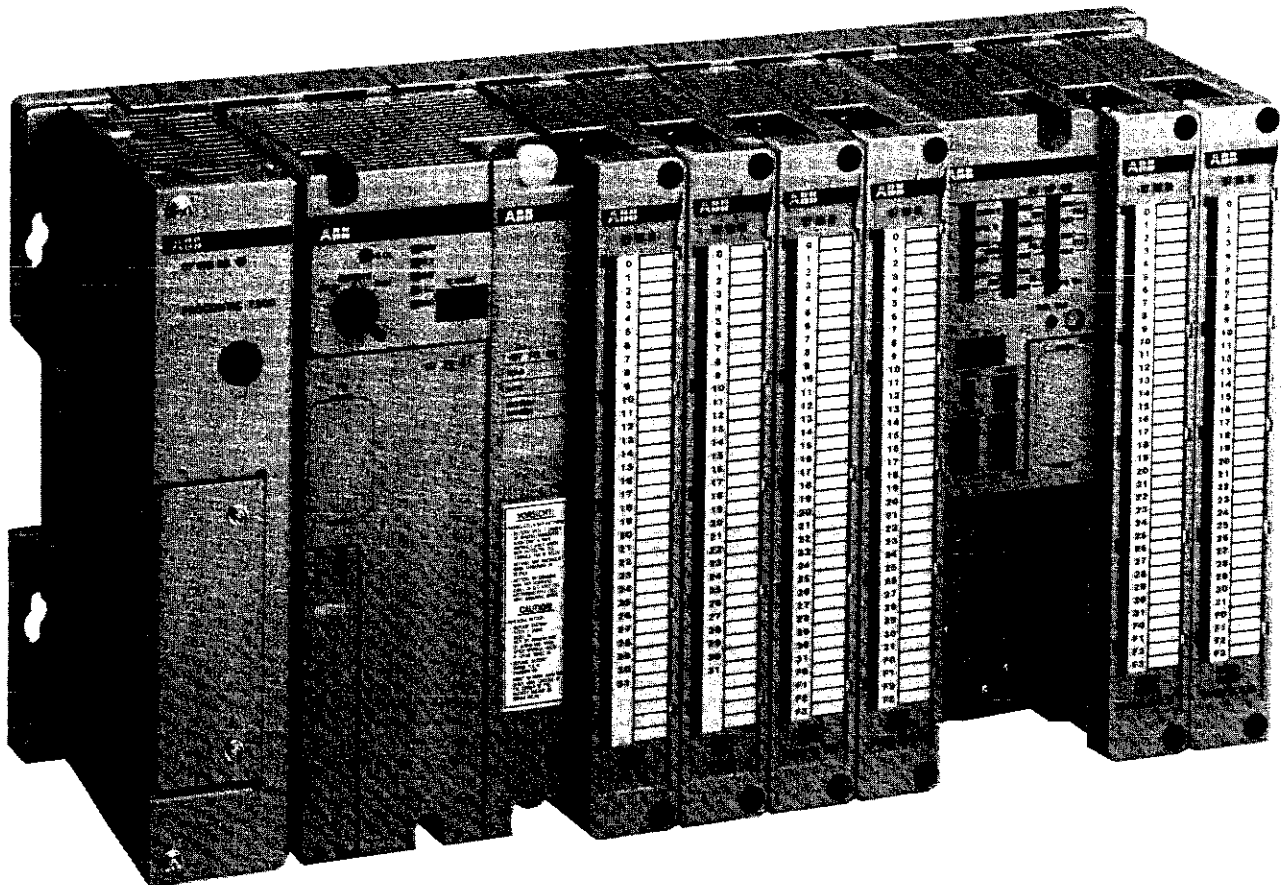

890218

Regulations Concerning the Setting up of Installations

Apart from the basic "Regulations for the Setting up of Power Installations" DIN VDE * 0100 and for "The Rating of Creepage Distances and Clearances" DIN VDE 0110 Part 1 and Part 2 the regulations "The Equipment of Power Installations with Electrical Components" DIN VDE 0160 in conjunction with DIN VDE 0660 Part 500 have to be taken into due consideration.

Further attention has to be paid to DIN VDE 0113 Part 1 and Part 200 in case of the control of working and processing machines. If operating elements are to be mounted near parts with dangerous contact voltage DIN VDE 0106 Part 100 is additionally relevant.

If the protection against direct contact according to DIN VDE 0160 is required, this has to be ensured by the user (e.g. by incorporating the elements in a switch-gear cabinet). The devices are designed for pollution severity 2 in accordance with DIN VDE 0110 Part 1. If higher pollution is expected, the devices must be installed in appropriate housings.

The user has to guarantee that the devices and the components belonging to them are mounted following these regulations. For operating the machines and installations, other national and international relevant regulations, concerning prevention of accidents and using technical working means, also have to be met.

The ABB Procontic devices are designed according to IEC 1131 Part 2. Meeting this regulation, they are classified in overvoltage category II which is in conformance with DIN VDE 0110 Part 2.

For the direct connection of ABB Procontic devices, which are powered with or coupled to AC line voltages of overvoltage category III, appropriate protection measures corresponding to overvoltage category II according to IEC-Report 664/1980 and DIN VDE 0110 Part 1 are to install.

Equivalent standards:

DIN VDE 0110 Part 1 $\hat{=}$ IEC 664
DIN VDE 0113 Part 1 $\hat{=}$ EN 60204 Part 1
DIN VDE 0660 Part 500 $\hat{=}$ EN 60439-1 $\hat{=}$ IEC 439-1

All rights reserved to change design, size, weight, etc.

* VDE stands for "Association of German Electrical Engineers".

ABB Schalt- und Steuerungstechnik GmbH Heidelberg

Table of Contents

1	Technical System Data	1- 1	5	Central Units	5- 1
2	Subracks	2- 1	5.1	Central units 07 ZE 60...63	5- 2
2.1	Basic subrack 07 BT 60 R1	2- 2	5.2	Error code lists	5- 9
2.2	Basic subrack 07 BT 61 R1	2- 4	5.2.1	Central unit error messages	5-10
2.3	Basic subrack 07 BT 62 R1	2- 6	5.2.2	Error recovery	5-13
2.4	Expansion subrack 07 BE 60 R1	2- 8	5.2.3	Internal bit flags	5-21
2.5	Expansion subrack 07 BE 61 R1	2-10	5.2.4	Internal word flags	5-27
2.6	Expansion subrack 07 BE 62 R1	2-12	5.3	Operands	5-36
2.7	Expansion subrack for remote I/O coupler 07 BE 69 R1	2-14	6	Program Memories	6- 1
3	Power Supply Units	3- 1	6.1	Program memory 07 PS 60	6- 2
3.1	Power supply unit 07 NG 61 R2	3- 2	6.2	Program memory 07 PS 61	6- 4
3.2	Power supply unit 07 NG 63 R2	3- 4	6.3	Program memory 07 PS 62	6- 6
3.3	Power supply unit 07 NG 66 R2	3- 6	6.4	Program memory 07 PS 63	6- 8
3.4	Power supply unit 07 NG 68 R2	3- 8	6.5	Program memory 07 PR 62	6-10
	in addition (for information only) 07 NG 60...68 R1		6.6	Program memory 07 PR 63	6-12
4	I/O-Expansions and Coupler	4- 1	7	Binary Input Modules	7- 1
4.1	Bus connector for central I/O expansion 07 BV 60 R1	4- 2	7.1	Binary input module 07 EB 60 R1	7- 2
4.2	Remote I/O coupler with triaxial cable 1) for max. 512 I/O 07 BR 60 R1	4.2- 1	7.2	Binary input module 07 EB 61 R1	7- 5
4.3	Remote I/O coupler with optical fibre for max. 512 I/O 07 BR 60 R2	4.3- 1	7.3	High-speed binary input module 07 EB 62 R1	7- 8
4.4	Remote I/O coupler with triaxial cable 1) for remote substation 07 BR 61 R1	4.4- 1	7.4	Binary input module 07 EB 63 R1	7-11
4.5	Remote I/O coupler with optical fibre for remote substation 07 BR 61 R2	4.5- 1	7.5	Binary input module 07 EB 64 R1	7-14
4.6	Coupler with triaxial cable 1) for connection to field bus ZB 10 07 ZB 60 R1	4.6- 1	7.7	Binary input module 07 EB 66 R1	7-17
4.7	Coupler with TWINAX cable 2) for connection to field bus ZB 10 07 ZB 60 R2	4.7- 1	7.8	Binary input module 07 EB 67 R1	7-20
4.8	Coupler with triaxial cable 1) for con- nection to ZB 20 bus 07 ZB 69 R1 ...	4.8- 1	8	Analog Input Modules	8- 1
4.9	Coupler with optical fibre for con- nection to ZB 20-Bus 07 ZB 69 R2 ..	4.9- 1	8.1	Analog input module 07 EA 60 R1	8- 2
4.10	Remote I/O coupler for connection of ABB Procontic CS 31 to ABB Procontic T200 07 CS 61 R202 ..	4.10- 1	8.2	Analog input module 07 EA 61 R1	8- 6
			8.3	Analog input module 07 EA 62 R1	8-10
			8.4	Analog input module 07 EA 63 R1	8-14
			8.5	Analog input module 07 EA 64 R1	8-18
			8.6	Analog input module 07 EA 65 R1	8-22
			8.7	Analog input module 07 EA 66 R1	8-26
			8.8	Analog input module 07 EA 67 R1	8-32
			9	Special Input Modules	9- 1
			9.1	Interrupt input module 07 EI 60 R1	9- 2
			9.2	High-speed counter 07 ZG 60 R1	9- 7
			10	Binary Output Modules	10- 1
			10.1	Binary output module 07 AB 60 R1	10- 2
			10.2	Binary output module 07 AB 61 R1	10- 5
			10.3	Binary output module 07 AB 62 R1	10- 8
			10.4	Binary output module 07 AB 63 R1	10-12
			10.8	Binary output module 07 AB 67 R1	10-16
			10.9	Binary output module 07 AB 68 R1	10-19

1) TRIAX = triaxial cable (double shielded coaxial cable)

2) TWINAX = twin axial cable (2-core, twisted and shielded high-frequency data transmission line)

11	Analog Output Modules	11- 1	14.8	Serial interface cable for connection of the text processor 07 KT 60 07 SK 64 R1	14- 8
11.1	Analog output module 07 AA 60 R1	11- 2	14.9	Serial interface cable for connection of the positioning unit 07 PO 60 07 SK 65 R1	14- 9
11.2	Analog output module 07 AA 61 R1	11- 6	14.10	Serial interface cable for connection between 2 positioning units 07 PO 60 and the electronic switch and control logic 35 US 50 07 SK 66 R1	14-10
11.3	Analog output module 07 AA 62 R1	11-10	14.11	Serial interface cable for connection of the text processor 07 KT 60 to the printer 07 DR 12 07 SK 67 R1	14-11
11.4	Analog output module 07 AA 63 R1	11-14	14.12	Serial interface cable for connection of the text processor 07 KT 60 to the operator station 35 BS 40 07 SK 68 R1	14-12
11.6	Analog output module 07 AA 65 R1	11-18	14.15	Interface cables for connection of peripheral units to the 9-pole serial interfaces of the compact PLCs 07 KR 91, 07 KT 92 (ABB Procontic CS31) and the communication processors 07 KP 62, 07 KP 63 and 07 KP 64 (ABB Procontic T200)	
12	Communication Units	12.1- 1		Survey table	14-13
12.1	Communication processor 07 KP 60 R101	12.1- 2		07 SK 90	14-14
12.3	Communication processor ASCII 07 KP 62 R202	12.3- 1		07 SK 91	14-15
12.4	Communication processor PROFIBUS 07 KP 63 R101 ³⁾	12.4- 1		07 SK 92	14-16
12.5	Communication processor RCOM 07 KP 64 R101	12.5- 1		Cable for the 07 DR 12 printer	14-17
12.8	Text processor 07 KT 60 R101	12.8- 1	14.20	Fibre-optic cable for direct connection between couplers 07 LK 60 R1	14-13
13	Preprocessors	13- 1	14.21	Fibre-optic cable for connection of couplers to an external optical fibre 07 LK 61 R1	14-14
13.1	Industrial computer Basic 07 IR 60 R101	13.1- 1	14.25	Coupling device for cable-to-cable connection and test and measurement purposes 07 LV 60 R1	14-15
13.2	One-axis positioning unit 07 PO 60 R201	13.2- 1	15	Accessories	15- 1
13.3	Programmable real-time clock 07 UD 60 R1	13.3- 1	15.1	EPROM Set 07 PR 67	15- 2
14	System Cables	14- 1	15.2	EPROM Set 07 PR 68	15- 2
14.1	System-expansion cable for central I/O expansion (cable length 0.5 m) 07 SV 60 R1	14- 2	15.3	Replacement lithium battery 07 LB 60 R1	15- 3
	(cable length 1.0 m) 07 SV 60 R2	14- 2	15.4	Lithium battery module 07 LE 90 R1	15- 5
14.2	System-expansion cable for central I/O expansion (cable length 0.5 m) 07 SV 61 R1	14- 2	15.5	Dummy module for empty I/O slots 07 BA 60 R1	15- 6
	(cable length 1.0 m) 07 SV 61 R2	14- 2		Power supply units for mounting into switchgear cabinets:	
14.3	System cable set connecting an input/output module and its remote mounted front panel 07 SZ 60 R1	14- 3	15.11	Power supply unit 07 NG 32 R1	15- 7
14.4	Interface cable connecting the serial interface of a central unit and the hand-held monitoring tool 07 BG 60 (cable length 2 m) 07 SK 60 R2	14- 4	15.12	Power supply unit 07 NG 34 R1	15- 9
	(cable length 5 m) 07 SK 60 R5	14- 4	15.13	Power supply unit 07 NG 35 R1	15-12
14.5	Serial interface cable; SUB-D plugs: Side A: 25 pole female; side B: 15 pole male 07 SK 61 R1	14- 5	15.14	Power supply unit 07 NG 36 R1	15-15
14.6	Serial interface cable; SUB-D plugs: Side A: 9 pole female; side B: 15 pole male 07 SK 62 R1	14- 6			
14.7	Serial interface cable for connection of the industrial computer Basic 07 IR 60 07 SK 63 R1	14- 7			

1) TRIAX = triaxial cable (double shielded coaxial cable)

2) TWINAX = twin axial cable (2-core, twisted and shielded high-frequency data transmission line)

3) in preparation

1 Technical System Data

The relevant product standard for the ABB Procontic T200 control system is EN 61131-2 \cong IEC 1131-2.

Operating and environmental conditions

Voltages

Process voltages UP

UP1 (incl. ripple)	or	24 V DC (+ 25 %, - 20 %)
UP3		48 V DC (+ 25 %, - 20 %)
UP5		12 V DC (\pm 10 %)
UP7	or	120 V AC (+ 10 %, - 15 %)
UP8		230 V AC (+ 10 %, - 15 %)
		24 V AC
		48 V AC

Ripple	U_{pp}	UP1 = 24 V DC	< 4 V
		UP1 = 48 V DC	< 8 V

Reference potential ZP

ZP	0 V for process voltage UP
----	----------------------------

Line voltages UN

UN1	230 V AC (+ 10 %, - 15 %)
UN2	120 V AC (+ 10 %, - 15 %)

Internal voltages UB

UB1	5 V DC
UB4	24 V DC

Reference potential ZB

ZB	0 V for internal voltages UB
----	------------------------------

Temperature

operation	0 °C ... + 55 °C
storage	- 25 °C ... + 75 °C
transport	- 25 °C ... + 75 °C

Humidity

5...95 %, without condensation

Air pressure

operation	\geq 800 hPa/ \leq 2000 m
storage	\geq 660 hPa/ \leq 3500 m

Creepage distances and clearances

The creepage distances and clearances meet

Overvoltage category II, pollution degree 2

Insulation test voltages

230 V circuits (mains, 230 V inputs/outputs) against other circuitry	2500 V
120 V circuits (mains) against other circuitry	1500 V
24 V circuits (supply, 24 V inputs/outputs), if electrically isolated against other circuitry	500 V
bus against other circuitry	500 V

Electromagnetic compatibility

- Immunity
against electrostatic discharge (ESD)

– electrostatic voltage in case of air discharge	8 kV	according to EN 61000–4–2
– electrostatic voltage in case of contact discharge	6 kV	

- Immunity against
the influence of radiated interference (CW radiated)

– test field strength	10 V/m	according to ENV 50140
-----------------------	--------	------------------------

- Immunity
against transient interference voltages (burst)

– supply voltage units (AC/DC)	2 kV	according to EN 61000–4–4
– binary inputs/outputs (24 V DC)	1 kV	
– binary inputs/outputs (120/230 V AC)	2 kV	
– analog inputs/outputs	1 kV	
– CS31 system bus	2 kV	

- Immunity against the influence
line–conducted interferences (CW conducted)

– test voltage	10 V	according to ENV 50141
----------------	------	------------------------

- Radio disturbance

		according to EN 55011 radio interference level A *) and according to EN 55022 radio interference level A *) (only for communication modules)
--	--	--

*) If the power supply unit 07 NG 66 R1 is to be used, an EMC filter (FN 680–2,5/06 made by Schaffner or equivalent) must be used in order to meet the radio interference level A.

Mechanical data

Conductor cross section of process terminals

power supplies	L1, N	max. 1.5 mm ²
	PE	max. 2.5 mm ²
I/O modules		max. 1.5 mm ²
subracks, ground terminals		max. 6.0 mm ²

Degree of protection IP 20

Vibration resistance

all three axes	10 Hz...57 Hz	continuous	0.0375 mm
		peak	0.075 mm
	57 Hz...150 Hz	continuous	0.5 g
		peak	1.0 g

Shock test

all three axes	15 g, 11 ms, half–sinusoidal
----------------	------------------------------

Mechanical data, mounting dimensions

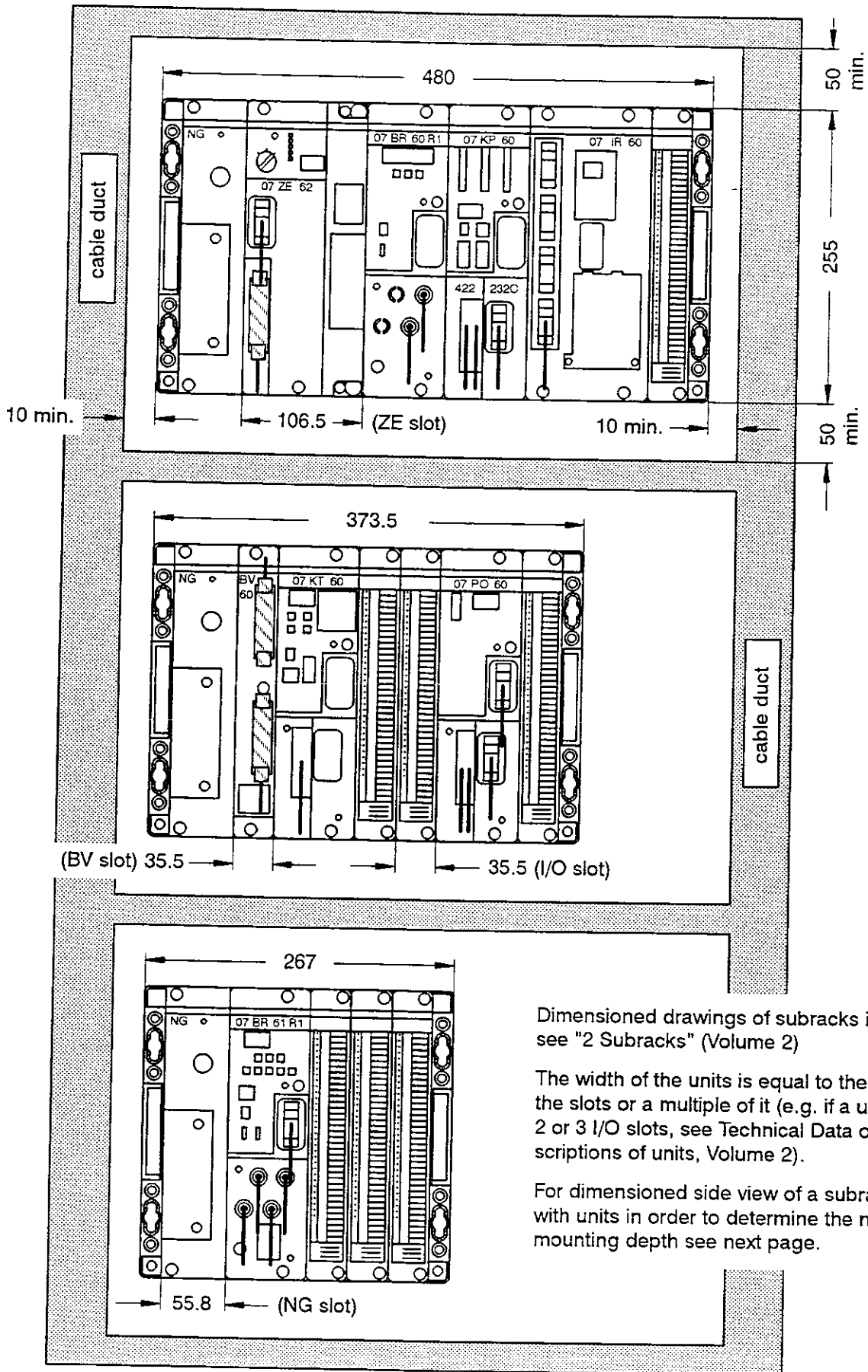

Dimensioned drawings of subracks in detail see "2 Subracks" (Volume 2)

The width of the units is equal to the width of the slots or a multiple of it (e.g. if a unit needs 2 or 3 I/O slots, see Technical Data of the descriptions of units, Volume 2).

For dimensioned side view of a subrack fitted with units in order to determine the necessary mounting depth see next page.

Fig. 1.1: Mounting dimensions of ABB Procontic T200

All dimensions in mm

Mechanical data, determination of mounting depth

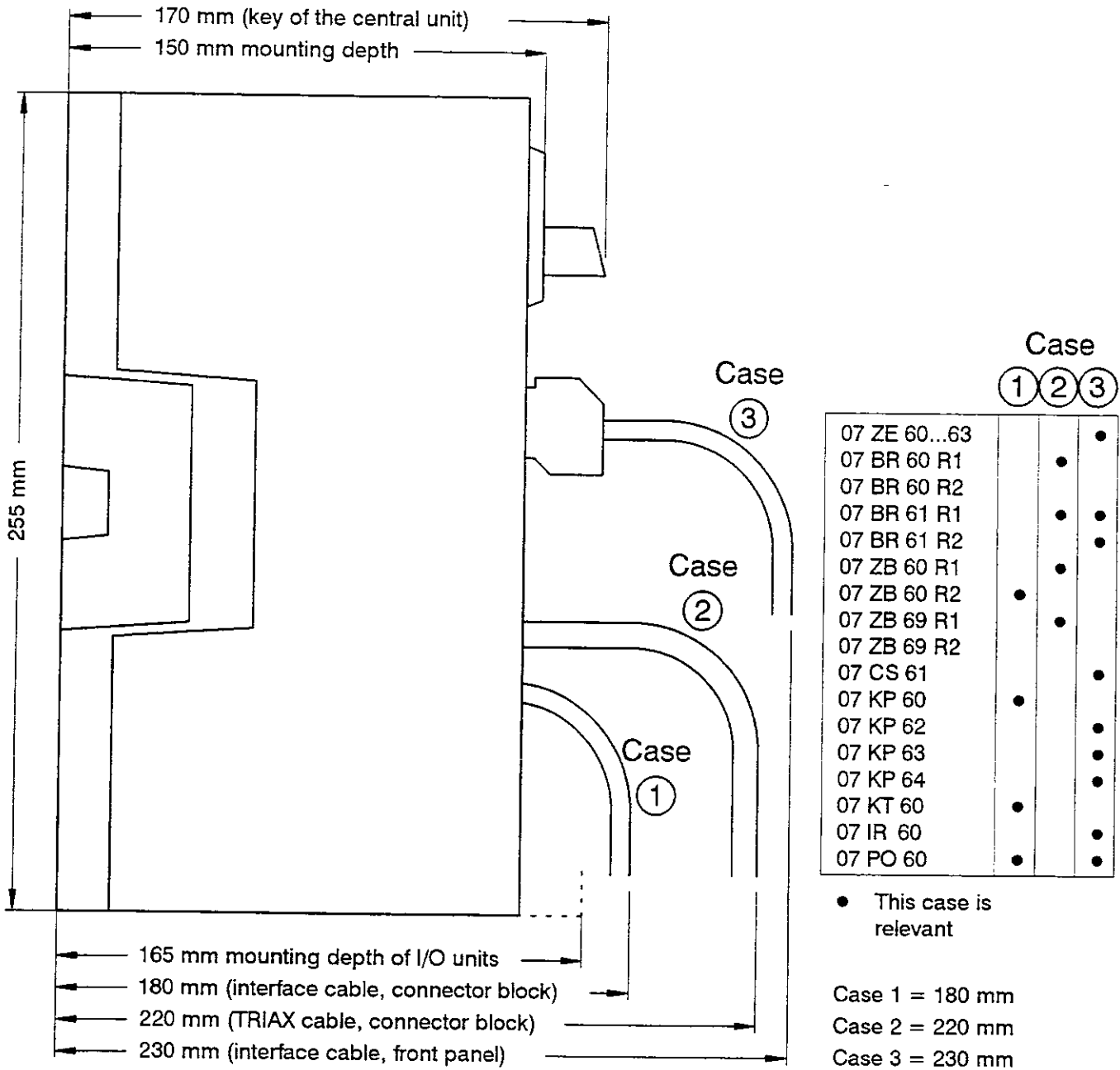

The connection of optical fibres as well as the use of system cables 07 SV 60 and 07 SV 61 for central expansion do not influence the mounting depth.

Width of slots or units respectively:

Power supply slot	NG	55.8 mm
Central unit slot	ZE	106.5 mm
Bus connector slot	BV	35.5 mm
I/O module slot	I/O	35.5 mm

Fig. 1.2: Side view of a subrack fitted with units, determination of mounting depth

2 Subracks

- 07 BT 60 R1: Basic subrack with slots for the central unit and 2 I/O modules
 07 BT 61 R1: Basic subrack with slots for the central unit and 5 I/O modules
 07 BT 62 R1: Basic subrack with slots for the central unit and 8 I/O modules
 07 BE 60 R1: Expansion subrack with slots for 4 I/O modules
 07 BE 61 R1: Expansion subrack with slots for 7 I/O modules
 07 BE 62 R1: Expansion subrack with slots for 10 I/O modules
 07 BE 69 R1: Expansion subrack for remote I/O couplers

Table of Module-Mounting Possibilities

Module	Basic subracks	Central I/O expansion		Remote I/O expansion	
	07 BT 60/61/62	07 BE 60/61/62	07 BE 69	07 BE 60/61/62	07 BE 69
07 ZE 60...63	•	-	-	-	-
07 EB 60...64	•	•	•	•	-
07 EB 66...67	•	•	•	•	-
07 AB 60...63	•	•	•	•	-
07 AB 67...68	•	•	•	•	-
07 EA 60...67	•	•	•	•	-
07 AA 60...63	•	•	•	•	-
07 AA 65	•	•	•	•	-
07 ZG 60	•	•	•	• ¹⁾	-
07 EI 60	•	•	•	-	-
07 BV 60	-	•	•	-	-
07 BR 60	•	-	•	-	-
07 BR 61	-	-	-	-	-
07 ZB 60	•	-	-	•	-
07 ZB 69	•	-	-	-	-
07 CS 61	•	•	•	-	-
07 KP 60	•	-	-	-	-
07 KP 62	•	-	-	-	-
07 KP 63	•	-	-	-	-
07 KP 64	•	-	-	-	-
07 KT 60	•	•	•	-	-
07 IR 60	•	-	-	-	-
07 PO 60	•	•	•	-	-
07 UD 60	•	•	•	•	-

¹⁾ only possible when application is not time-critical

- Module can be mounted
- Module cannot be mounted

2.1 Basic Subrack 07 BT 60 R1 with 2 I/O slots, 1 NG slot and 1 ZE slot

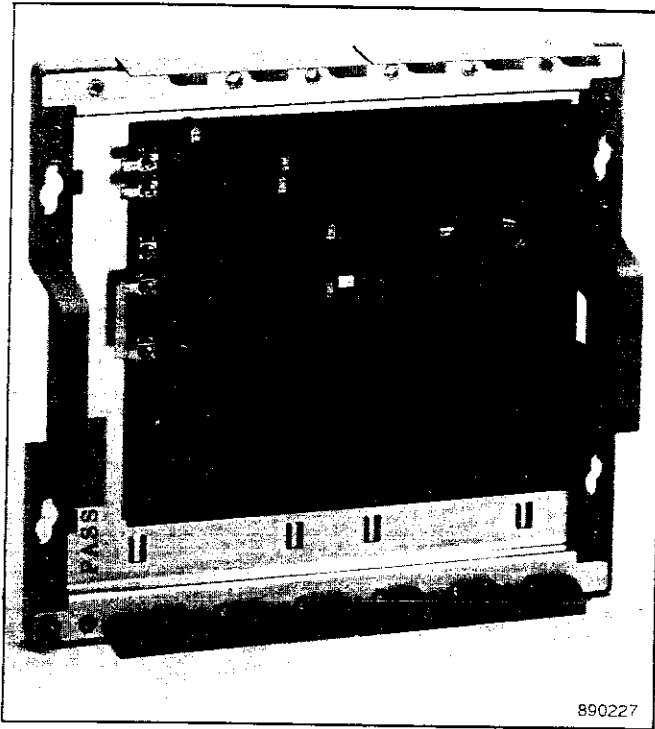

Fig. 2.1.1: Basic subrack 07 BT 60 R1

The basic subrack 07 BT 60 R1 is required to set up a central-station subrack of ABB Procontic T200. The subrack has to be equipped with a power supply unit and a central unit including a program memory. 2 further slots are available for mounting of I/O modules.

A back-plane, which connects the modules electrically, is an integral part of the subrack. The back-plane is equipped with printed board connectors for a power supply unit, a central unit (system bus) and I/O modules.

All I/O modules except 07 BR 61 R1/R2 and 07 BV 60 R1 can be mounted in the basic subrack 07 BT 60 R1.

The slot numbers increase from left to right. The first slot at the right side of the central unit is addressed to number 0.

Technical Data

Slots	power supply unit	1
	central unit	1
	I/O modules	2
Conductor cross section of ground terminals		max. 6.0 mm ²
Weight		1.4 kg
Dimensions		255 mm x 267 mm
Order number		GJV3074301R1

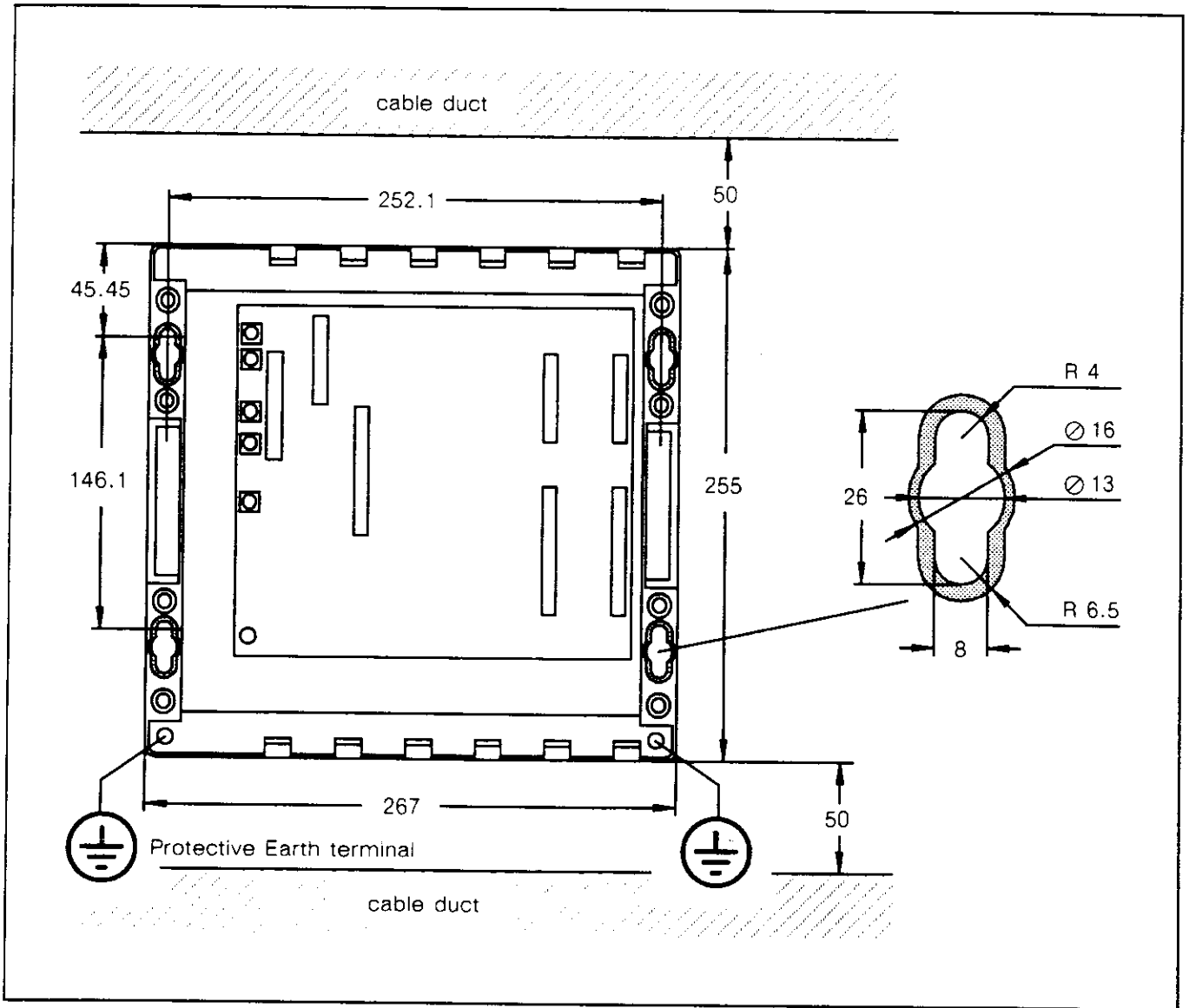

Fig. 2.1.2: Dimensioned drawing of the basic subrack 07 BT 60 R1

2.2 Basic Subrack 07 BT 61 R1 with 5 I/O slots, 1 NG slot and 1 ZE slot

The basic subrack 07 BT 61 R1 is required to set up a central-station subrack of ABB Procontic T200. The subrack has to be equipped with a power supply unit and a central unit including a program memory. 5 further slots are available for mounting of I/O modules.

A back-plane, which connects the modules electrically, is an integral part of the subrack. The back-plane is equipped with printed board connectors for a power

supply unit, a central unit (system bus) and I/O modules.

All I/O modules except 07 BR 61 R1/R2 and 07 BV 60 R1 can be mounted in the basic subrack 07 BT 61 R1.

The slot numbers increase from left to right. The first slot at the right side of the central unit is addressed to number 0.

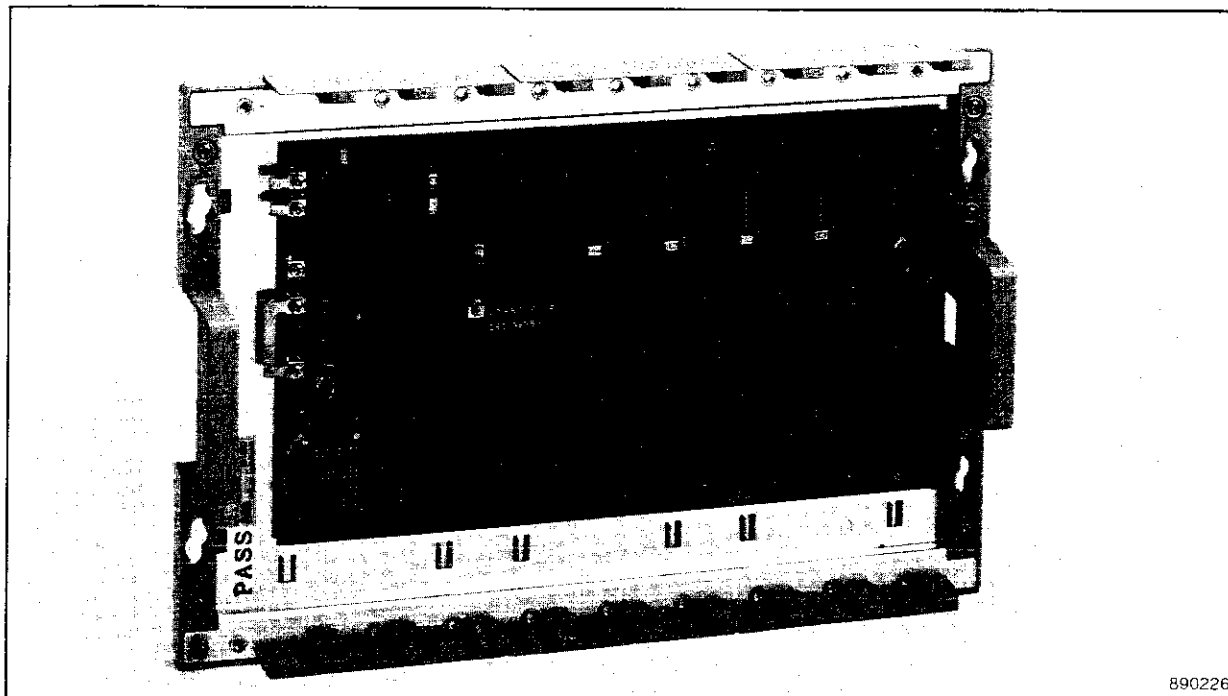

Fig. 2.2.1: Basic subrack 07 BT 61 R1

Technical Data

Slots	power supply unit	1
	central unit	1
	I/O modules	5
Conductor cross section of ground terminals		max. 6.0 mm ²
Weight		1.9 kg
Dimensions		255 mm x 373.5 mm
Order number		GJV3074302R1

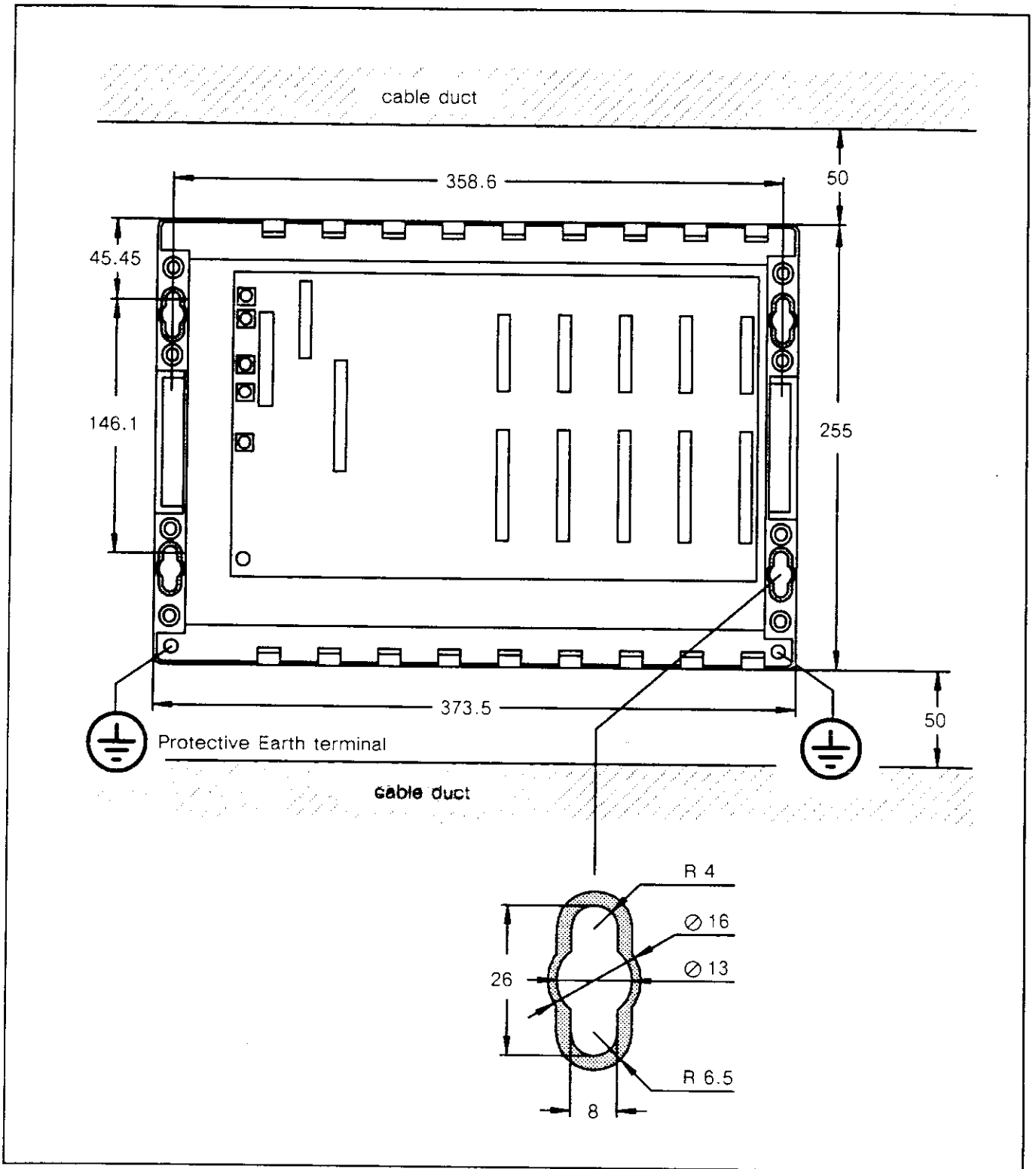

Fig. 2.2.2: Dimensioned drawing of the basic subrack 07 BT 61 R1

2.3 Basic Subrack 07 BT 62 R1 with 8 I/O slots, 1 NG slot and 1 ZE slot

The basic subrack 07 BT 62 R1 is required to set up a central-station subrack of ABB Procontic T200. The subrack has to be equipped with a power supply unit and a central unit including a program memory. 8 further slots are available for mounting of I/O modules.

A back-plane, which connects the modules electrically, is an integral part of the subrack. The back-plane is equipped with printed board connectors for a power

supply unit, a central unit (system bus) and I/O modules.

All I/O modules except 07 BR 61 R1/R2 and 07 BV 60 R1 can be mounted in the basic subrack 07 BT 61 R1.

The slot numbers increase from left to right. The first slot at the right side of the central unit is addressed to number 0.

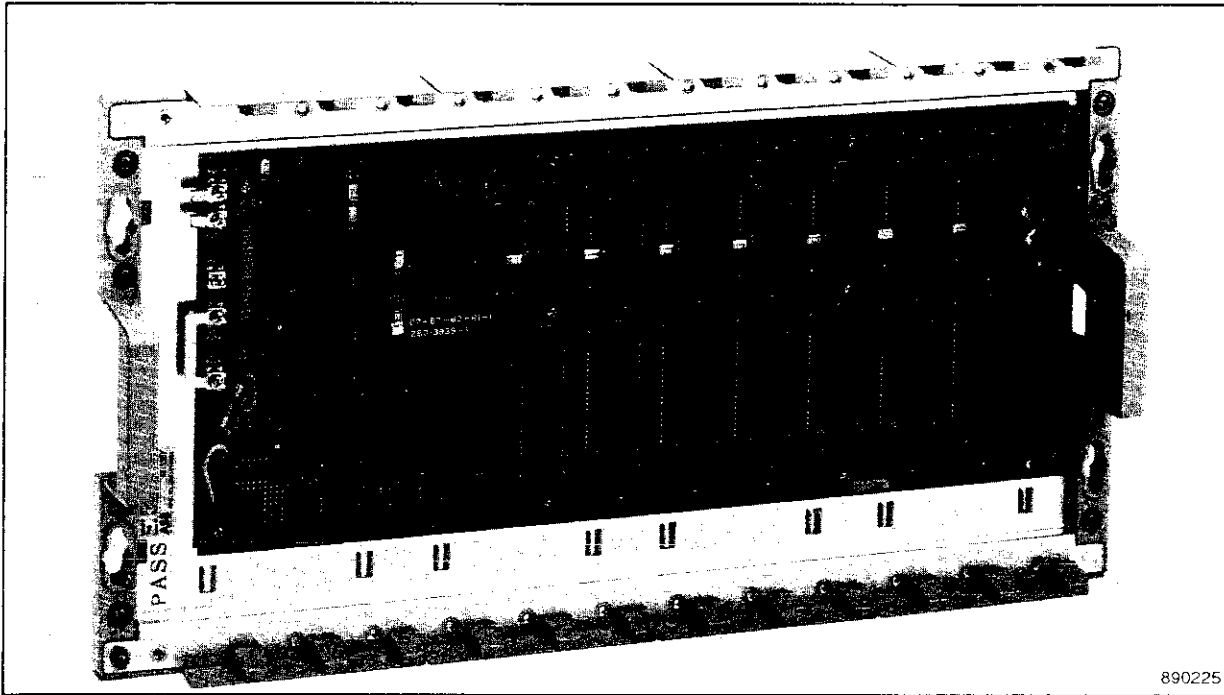

Fig. 2.3.1: Basic subrack 07 BT 62 R1

Technical Data

Slots	power supply unit	1
	central unit	1
	I/O modules	8
Conductor cross section of ground terminals		max. 6.0 mm ²
Weight		2.5 kg
Dimensions		255 mm x 480 mm
Order number		GJV3074303R1

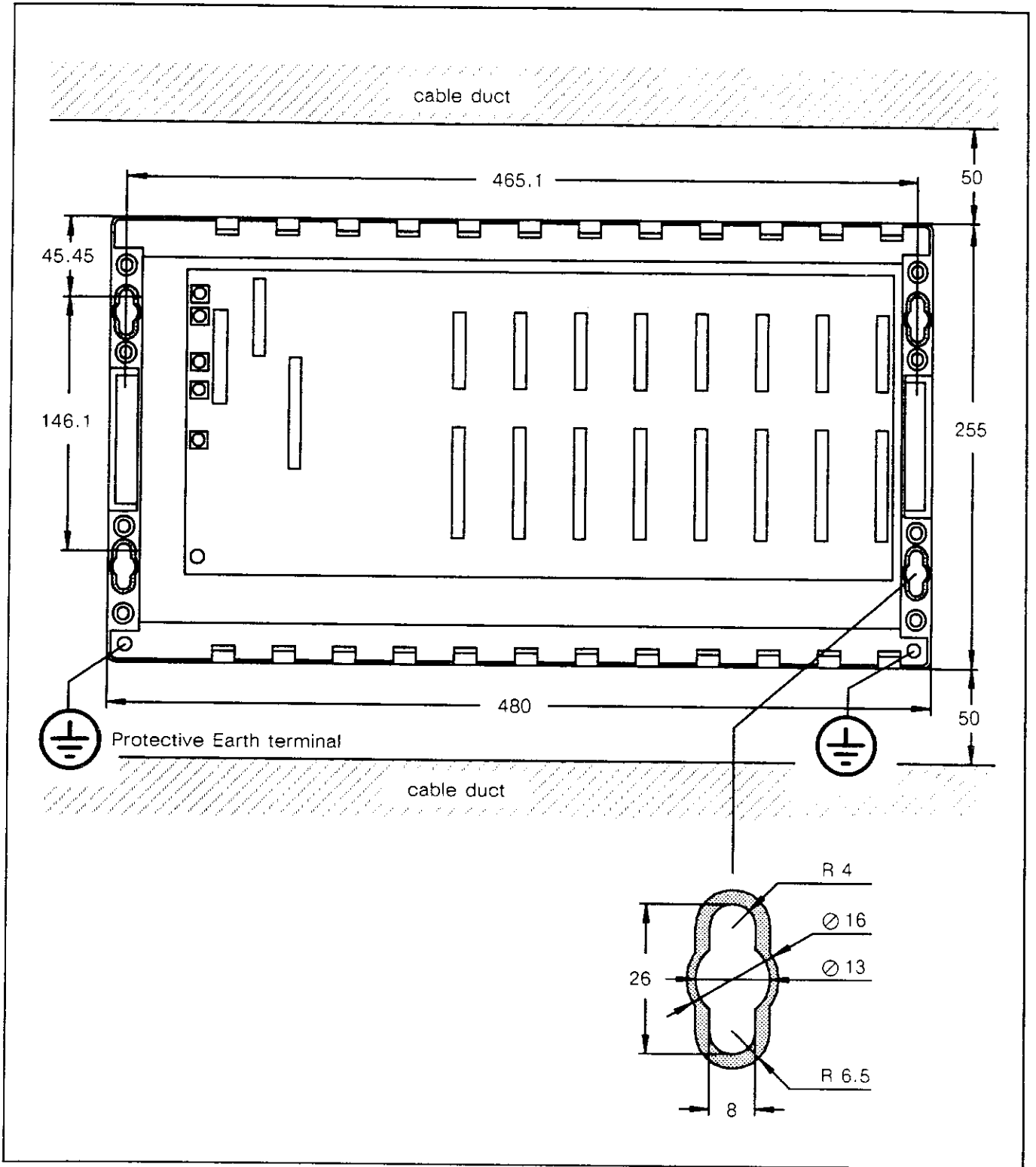

Fig. 2.3.2: Dimensioned drawing of the basic subrack 07 BT 62 R1

2.4 Expansion Subrack 07 BE 60 R1

with 4 I/O slots in case of central expansion,

with 3 I/O slots in case of remote I/O expansion

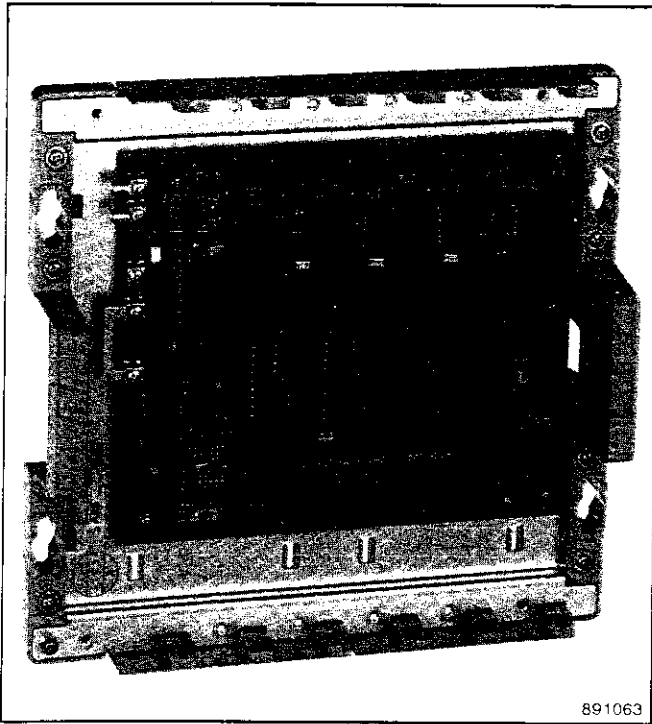

Fig. 2.4.1: Expansion subrack 07 BE 60 R1

The expansion subrack 07 BE 60 R1 is required to set up a central or remote I/O expansion of ABB Procontic T200. The subrack is intended for mounting of I/O modules. A back-plane, which connects the modules electrically, is an integral part of the subrack. The back-plane is equipped with printed board connectors for a power supply unit, a bus connector and I/O modules.

In case of a central expansion the subrack has to be equipped with a power supply unit and a bus connector 07 BV 60 R1, in case of a remote I/O expansion with a power supply unit and a coupler 07 BR 61.

The slot numbers increase from left to right. The first slot at the right side of the bus connector 07 BV 60 R1 respectively at the right side of the coupler 07 BR 61 is addressed to number 0.

In case of a central I/O expansion with the bus connector 07 BV 60 R1 all of the 4 I/O slots of the subrack can be used for I/O expansion; the slot numbers are 0, 1, 2, 3. In case of a remote I/O expansion with coupler 07 BR 61 the number of I/O slots is reduced by one as the coupler 07 BR 61 occupies two slots. The three I/O slots are addressed to the numbers 0, 1, 2.

Technical Data

Slots	power supply unit	1
	I/O modules	4 in case of a central I/O expansion 3 in case of a remote I/O expansion
Conductor cross section of ground terminals		max. 6.0 mm ²
Weight		1.4 kg
Dimensions		255 mm x 267 mm
Order number		GJV3074304R1

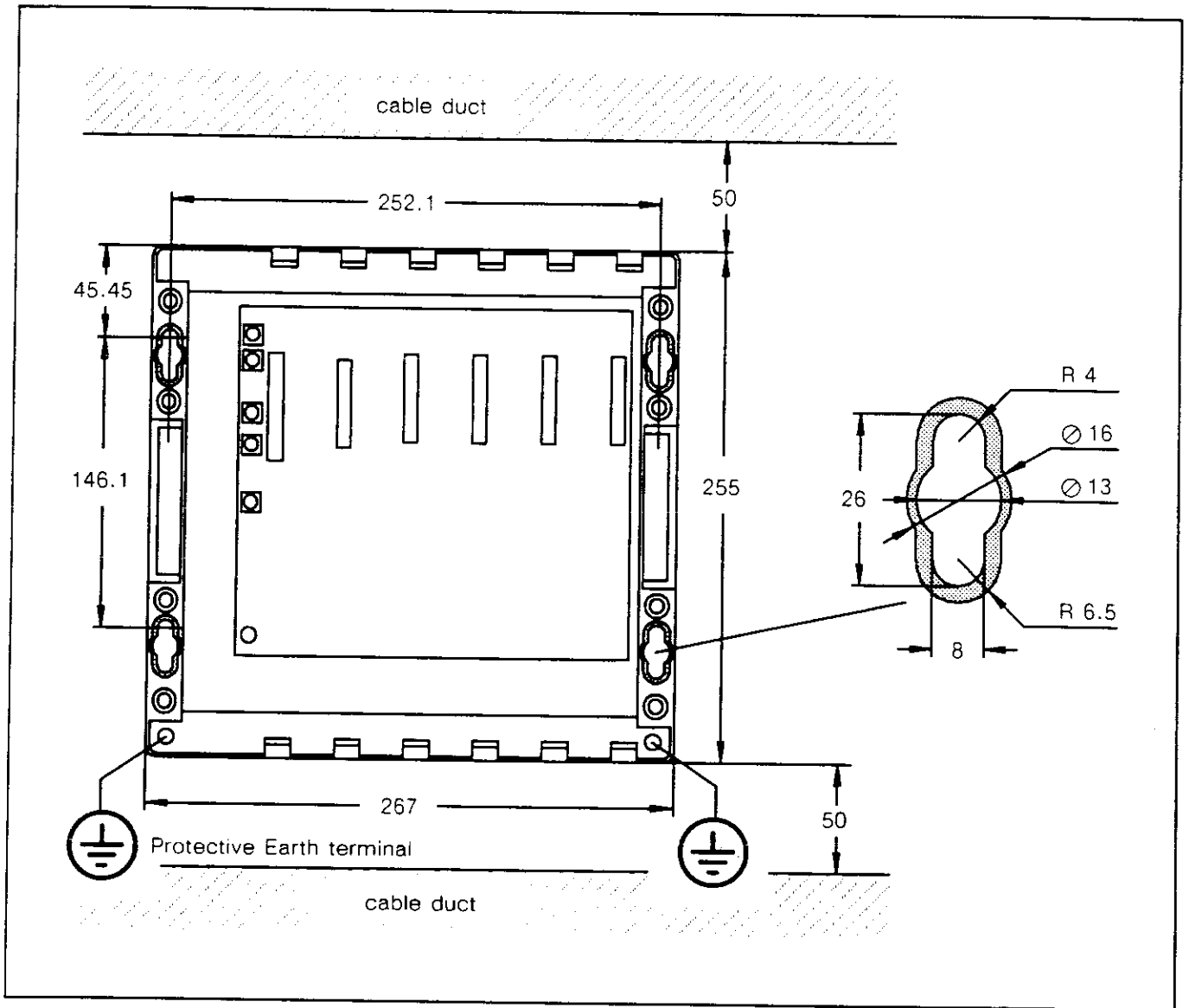

Fig. 2.4.2: Dimensioned drawing of the expansion subrack 07 BE 60 R1

2.5 Expansion Subrack 07 BE 61 R1

with 7 I/O slots in case of central expansion,
with 6 I/O slots in case of remote I/O expansion

The expansion subrack 07 BE 61 R1 is required to set up a central or remote I/O expansion of ABB Procontic T200. The subrack is intended for mounting of I/O modules. A back-plane, which connects the modules electrically, is an integral part of the subrack. The back-plane is equipped with printed board connectors for a power supply unit, a bus connector and I/O modules.

In case of a central expansion the subrack has to be equipped with a power supply unit and a bus connector 07 BV 60 R1, in case of a remote I/O expansion with a power supply unit and a coupler 07 BR 61.

The slot numbers increase from left to right. The first slot at the right side of the bus connector 07 BV 60 R1 respectively at the right side of the coupler 07 BR 61 is addressed to number 0.

In case of a central I/O expansion with the bus connector 07 BV 60 R1 all of the 7 I/O slots of the subrack can be used for I/O expansion; the slot numbers are 0...6. In case of a remote I/O expansion with coupler 07 BR 61 the number of I/O slots is reduced by one as the coupler 07 BR 61 occupies two slots. The six I/O slots are addressed to the numbers 0...5.

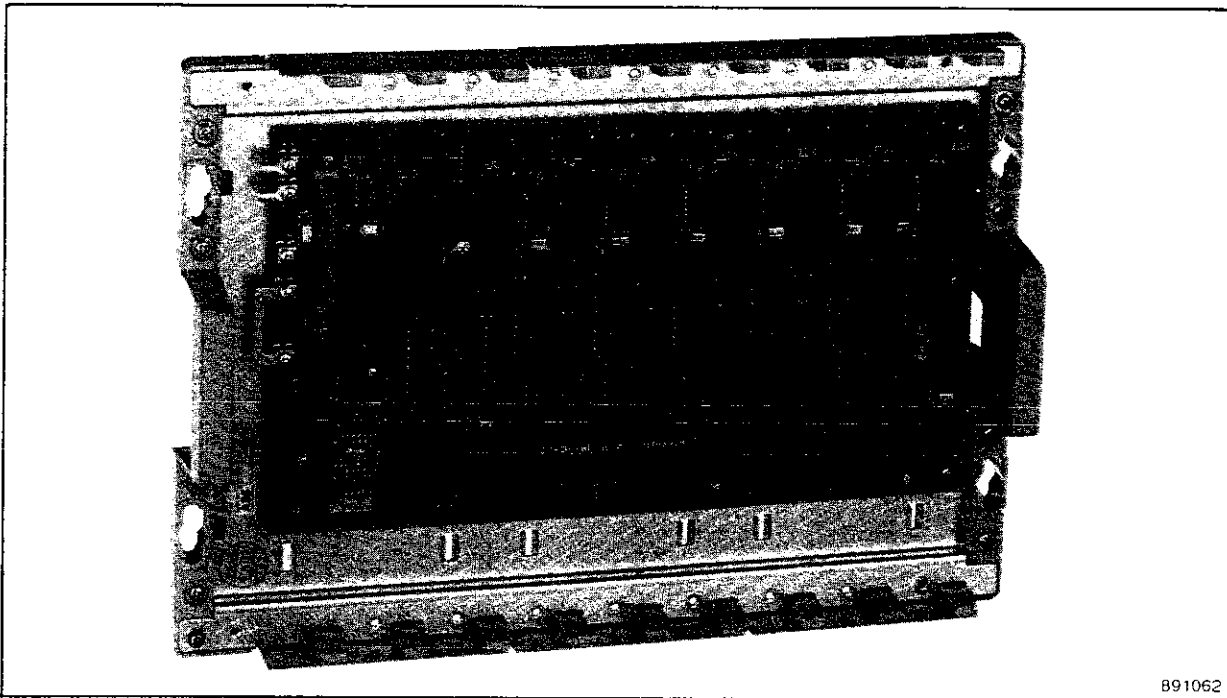

891062

Fig. 2.5.1: Expansion subrack 07 BE 61 R1

Technical Data

Slots	power supply unit	1
	I/O modules	7 in case of a central I/O expansion 6 in case of a remote I/O expansion
Conductor cross section of ground terminals		max. 6.0 mm ²
Weight		1.8 kg
Dimensions		255 mm x 373.5 mm
Order number		GJV3074305R1

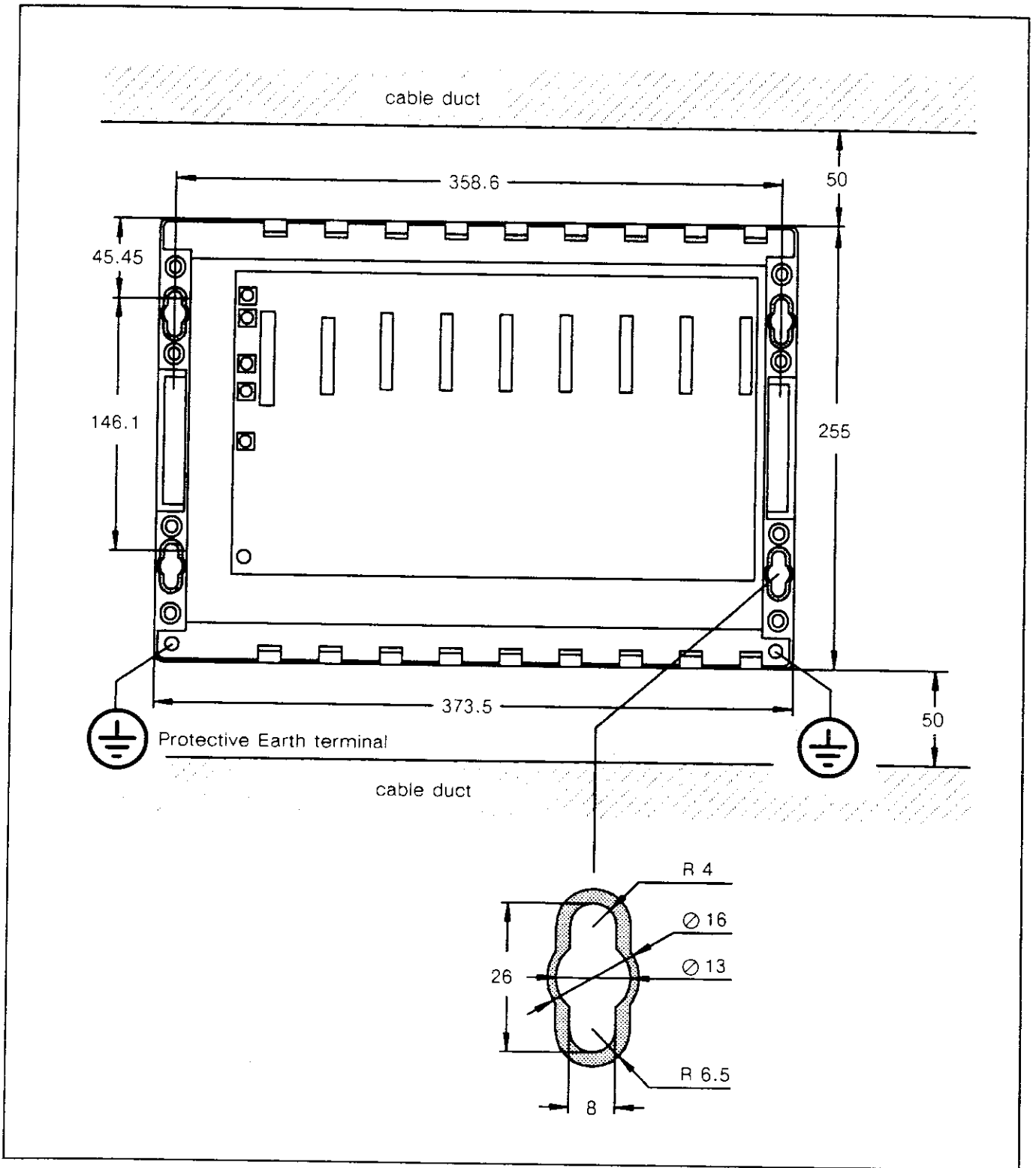

Fig. 2.5.2: Dimensioned drawing of the expansion subrack 07 BE 61 R1

2.6 Expansion Subrack 07 BE 62 R1

with 10 I/O slots in case of central expansion,
with 9 I/O slots in case of remote I/O expansion

The expansion subrack 07 BE 62 R1 is required to set up a central or remote I/O expansion of ABB Procontic T200. The subrack is intended for mounting of I/O modules. A back-plane, which connects the modules electrically, is an integral part of the subrack. The back-plane is equipped with printed board connectors for a power supply unit, a bus connector and I/O modules.

In case of a central expansion the subrack has to be equipped with a power supply unit and a bus connector 07 BV 60 R1, in case of a remote I/O expansion with a power supply unit and a coupler 07 BR 61.

The slot numbers increase from left to right. The first slot at the right side of the bus connector 07 BV 60 R1 respectively at the right side of the coupler 07 BR 61 is addressed to number 0.

In case of a central I/O expansion with the bus connector 07 BV 60 R1 all of the 10 I/O slots of the subrack can be used for I/O expansion; the slot numbers are 0...9. In case of a remote I/O expansion with coupler 07 BR 61 the number of I/O slots is reduced by one as the coupler 07 BR 61 occupies two slots. The nine I/O slots are addressed to the numbers 0...8.

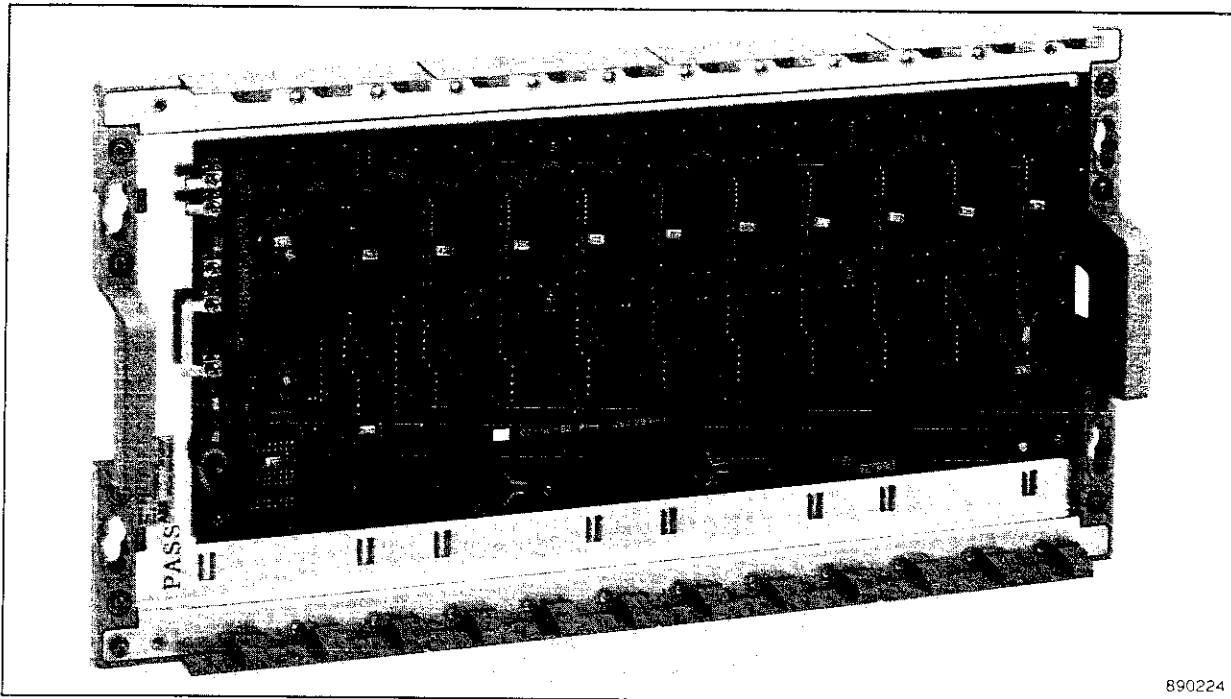

Fig. 2.6.1: Expansion subrack 07 BE 62 R1

Technical Data

Slots	power supply unit	1
	I/O modules	10 in case of a central I/O expansion 9 in case of a remote I/O expansion
Conductor cross section of ground terminals		max. 6.0 mm ²
Weight		2.4 kg
Dimensions		255 mm x 480 mm
Order number		GJV3074306R1

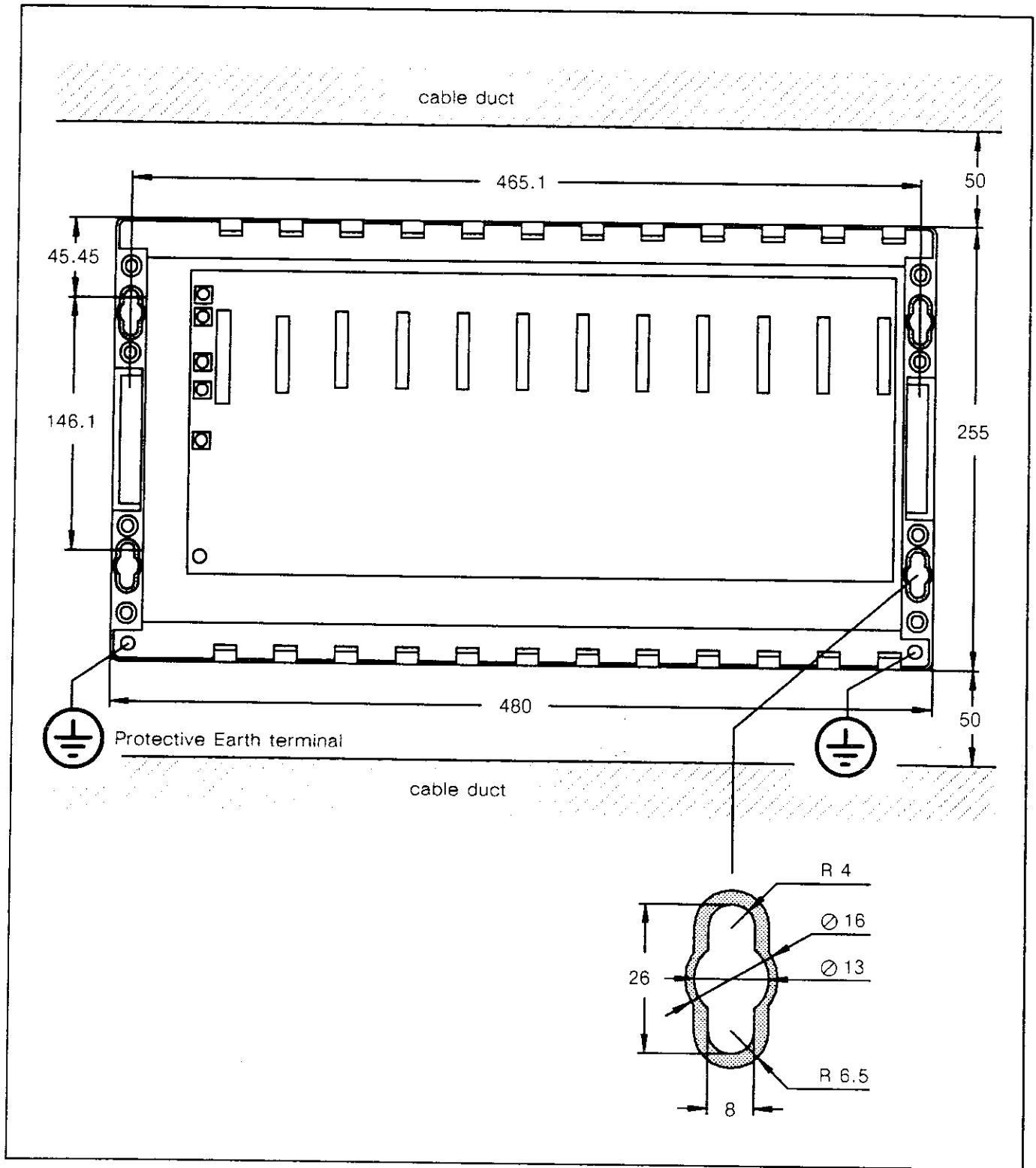

Fig. 2.6.2: Dimensioned drawing of the expansion subrack 07 BE 62 R1

2.7 Expansion Subrack 07 BE 69 R1 for remote I/O couplers with 4 I/O slots in case of central I/O expansion, I/O slots additionally usable with 07 BR 60 couplers

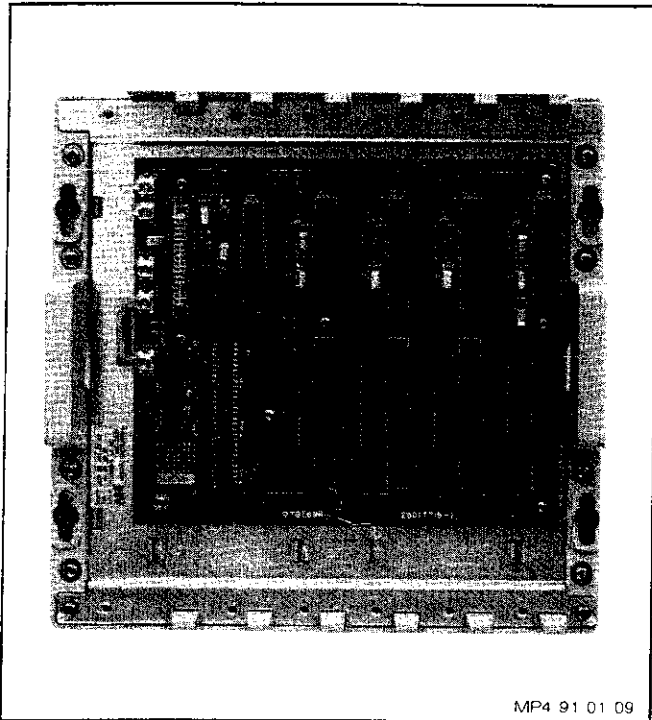

Fig. 2.7.1: Expansion subrack 07 BE 69 R1

Characteristics

Contrary to 07 BE 60, the 07 BE 69 R1 subrack can be equipped with up to two 07 BR 60 R1/R2 remote I/O couplers in central expansion. Thus in the basic subrack more system slots are available for modules with high complexity (see Fig. 2.7.3).

The sum of 07 BR 60 R1/R2 couplers in one system (basic subrack plus expansion subrack) is still 4 (for a maximum of 4 lines).

Notice has to be taken, that the programming interface on the 07 BR 61 coupler in the connected substation cannot be used, if the 07 BR 60 coupler belonging to it is located in a 07 BE 69 subrack.

I/O slots of the 07 BE 69, which are not used by couplers, can be equipped with I/O modules in the same way as with other expansion subracks.

The 07 BE 69 subrack is not suitable to build up substations (remote I/O expansion with 07 BR 61 coupler).

Module Description

A back-plane, which connects the modules electrically, is the main integral part of the subrack. The back-plane is equipped with printed board connectors for a power supply unit, a 07 BV 60 bus connector and I/O modules.

The slot numbers increase from left to right. The first slot at the right side of the 07 BV 60 R1 bus connector is addressed to number 0. Thus the four I/O slots get the numbers 0...3 (see Fig. 2.7.3).

The positioning sequence in the basic subrack (BT) and expansion subrack (07 BE 69) determines the number of the remote line, i.e. the couplers are given the numbers 1...4 (lines 1...4) in ascending order, starting with the 1st slot to the right of the central unit.

Technical Data

Project planning		Central expansion with 07 BV 60 for I/O modules or 07 BR 60 R1/R2 couplers
Slots	Power supply units	1
	07 BV 60 bus connectors	1
	I/O modules	4 (only central expansion is possible)
		The 4 I/O slots may also be equipped with up to two 07 BR 60 R1/R2 couplers
Conductor cross section of ground terminals		max. 6.0 mm ²
Weight		1.4 kg
Dimensions		255 mm x 267 mm
Order number		GJV3074309R1

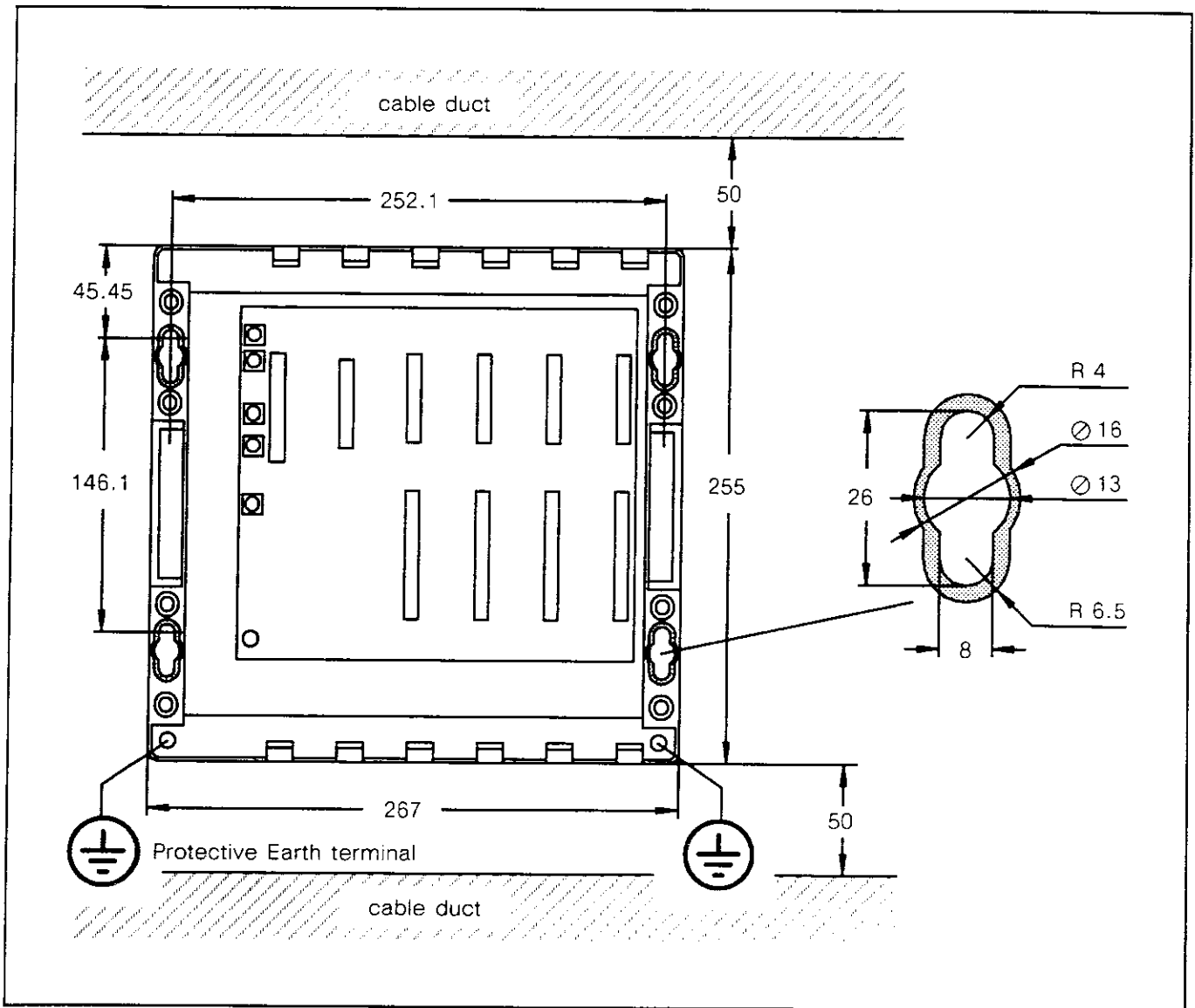
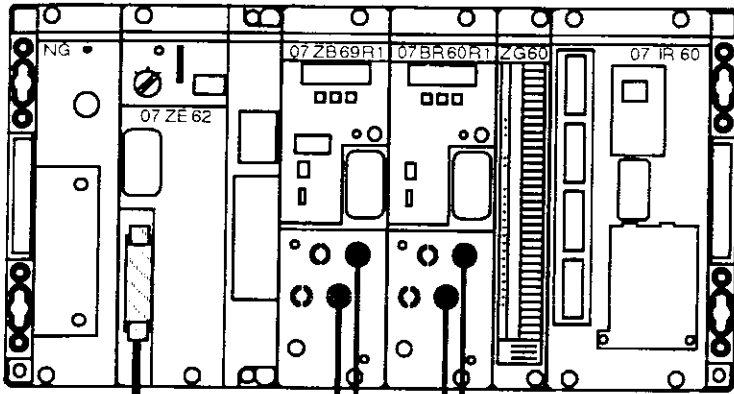

Fig. 2.7.2: Dimensioned drawing of the 07 BE 69 R1 expansion subrack

Central station

I/O slot No. 0 1 2 3 4 5 6 7



max. expansion possible:

- 4 lines for each system
- 10 substations for each line
- 512 I/O points for each line

ZB 20

I/O slot No. 0 1 2 3

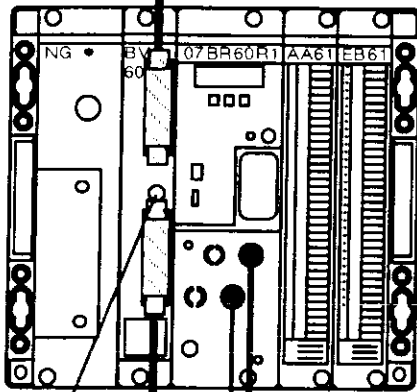

1st line

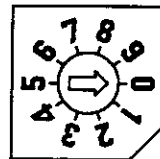

07 BE 69 R1
expansion
subrack

Substation No. 0, line 1

I/O slot No. 0 1 2 3

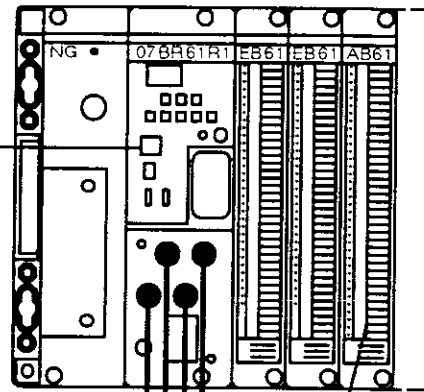

A 1.02,31

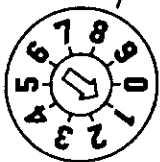

2nd line

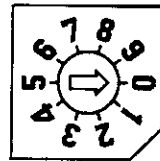

Substation No. 0, line 2

I/O slot No. 0 1 2 3

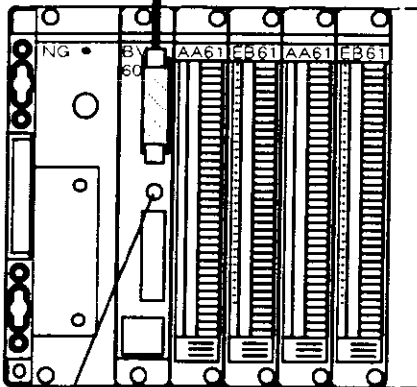

I/O slot No. 0 1 2 3 4 5

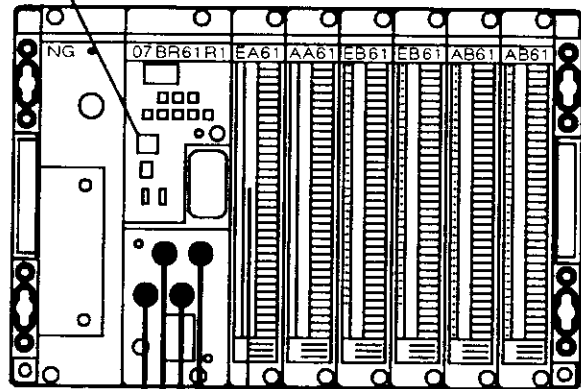

EW 2.00,03

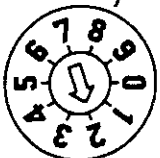

Fig. 2.7.3: Configuration example with the 07 BE 69 R1 expansion subrack for remote I/O couplers

3 Power Supply Units

Dependent on the power consumption of the configuration you can use one of the following power supply units:

07 NG 61 R2:	Input voltage: 120/230 V AC,	output voltages: 5 V DC/4.0 A, 24 V DC/1.5 A
07 NG 63 R2:	Input voltage: 120/230 V AC,	output voltages: 5 V DC/9.0 A, 24 V DC/0.5 A
07 NG 66 R2:	Input voltage: 24 V DC,	output voltages: 5 V DC/4.0 A, 24 V DC/1.5 A
07 NG 68 R2:	Input voltage: 24 V DC,	output voltages: 5 V DC/9.0 A, 24 V DC/0.5 A

3.1 Power Supply Unit 07 NG 61 R2

Input voltage: 120/230 V AC, output voltages: 5 V DC/4 A, 24 V DC/1.5 A

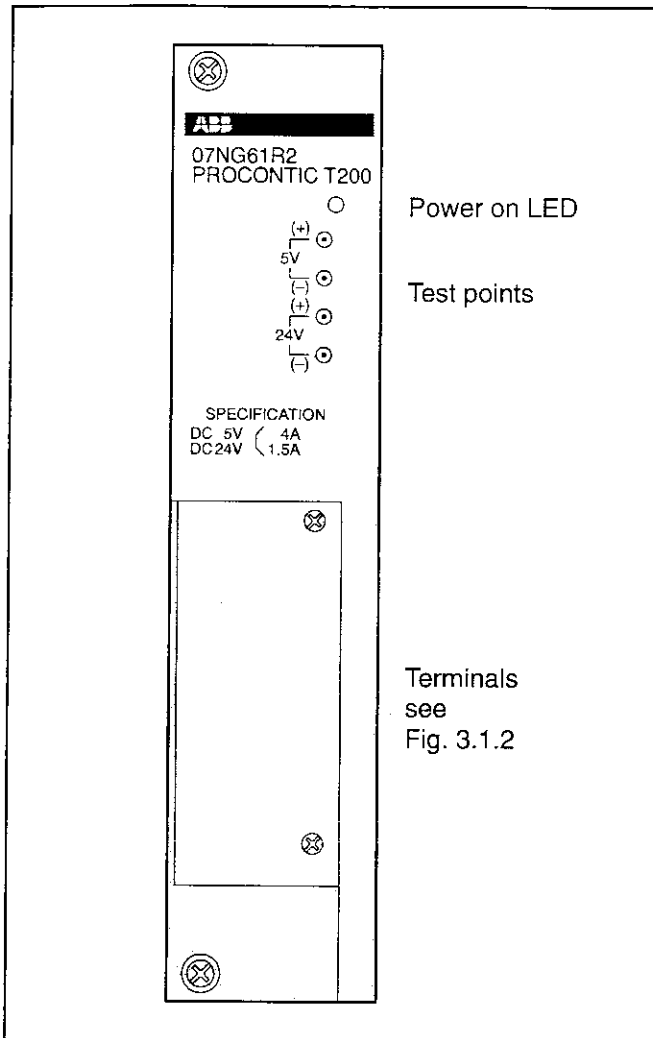

The power supply unit 07 NG 61 generates the internal voltages 5 V/4 A and 24 V/1.5 A required for the PLC. It is supplied by an input voltage of 230 V AC or 120 V AC alternatively. In order to select the input voltage plug the jumper into the respective position (see Fig. 3.1.2).

07 NG 61 is short-circuit-proof and includes an over-voltage protection. A green LED indicates that the power supply unit is in operation.

In addition, the operation state of the central unit is allocated to a relay (RUN contact), i.e. as long as the central unit is in the RUN state, the contact of the relay is closed. The RUN contact only indicates the state of the central unit, when the power supply unit is mounted in the basic subrack, i.e. RUN contacts of power supply units in expansion subracks are permanently open.

Fig. 3.1.1: Power supply unit 07 NG 61

Technical Data

Input voltage	selectable
UN1	230 V AC (+ 20 %, - 22 %)
UN2	120 V AC (+ 20 %, - 22 %)
frequency	47 Hz ... 63 Hz
Output voltages (system internal voltages)	
UB1	5 V DC (- 1 % ... + 5 %)
UB4	24 V DC (0 % ... + 30 %)
short-circuit-proof	yes
Output load capability	
UB1 = 5 V DC	max. 4.0 A
UB4 = 24 V DC	max. 1.5 A
Electrical isolation	between input voltage and output voltages, between output voltages
Nominal insulation voltage, process terminals versus subrack and output voltages:	
according to VDE 0160	250 V AC
tested with	1500 V AC
Power consumption	max. 150 VA

Power dissipation		max. 22.4 W
Conductor cross section of process terminals		
L1, N		max. 1.5 mm ²
PE (protective earth)		max. 2.5 mm ²
Buffered voltage interruption time		≥ 20 ms
Specification RUN contact		
switching voltage		4.5 V ... 264 V, AC or DC
switching current		max. 2 A
		min. 1 mA at 5 V DC
switching power,	if AC is switched	max. 0.5 kVA
	if DC is switched	max. 50 W
contact lifetime		≥ 20,000 cycles at max. load
mechanical contact lifetime		≥ 10 ⁶ cycles
contact protection against arcing		no (only resistive load is permitted)
bounce time		≤ 4 ms
Indication of operating		one green LED
Number of required slots		1 NG slot
Ability of fitting in subracks		
slots, ● = plug-in is possible		
	BT	BE-central
	NG ZE I/O	NG BV I/O
	●	●
		BE-remote
		NG BV I/O
		●
Weight		1 kg
Order number of module 07 NG 61 R2		GJV3074311R2

Block Diagram

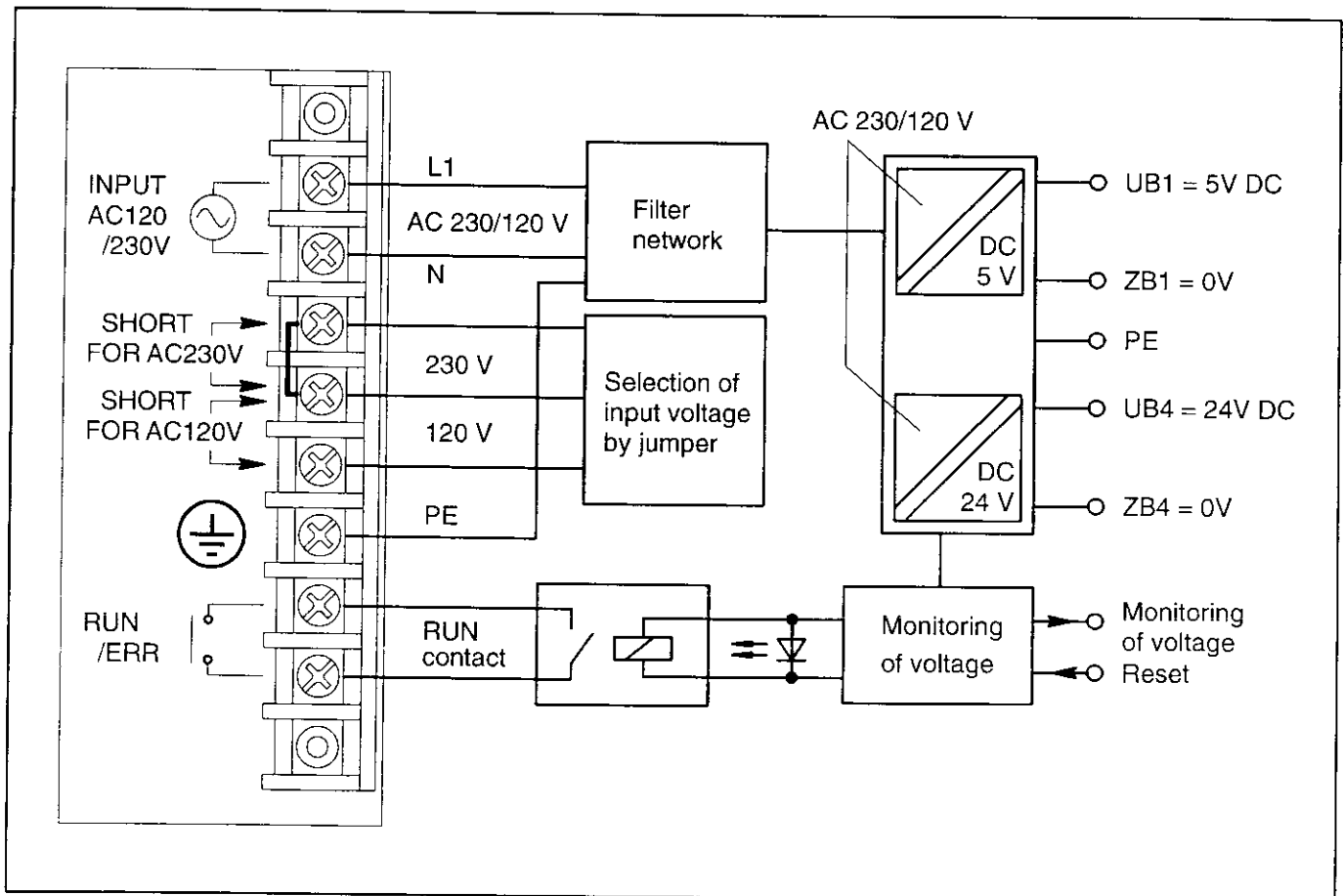

Fig. 3.1.2: Block diagram 07 NG 61 R2

3.2 Power Supply Unit 07 NG 63 R2

Input voltage: 120/230 V AC, output voltages: 5 V DC/9 A, 24 V DC/0.5 A

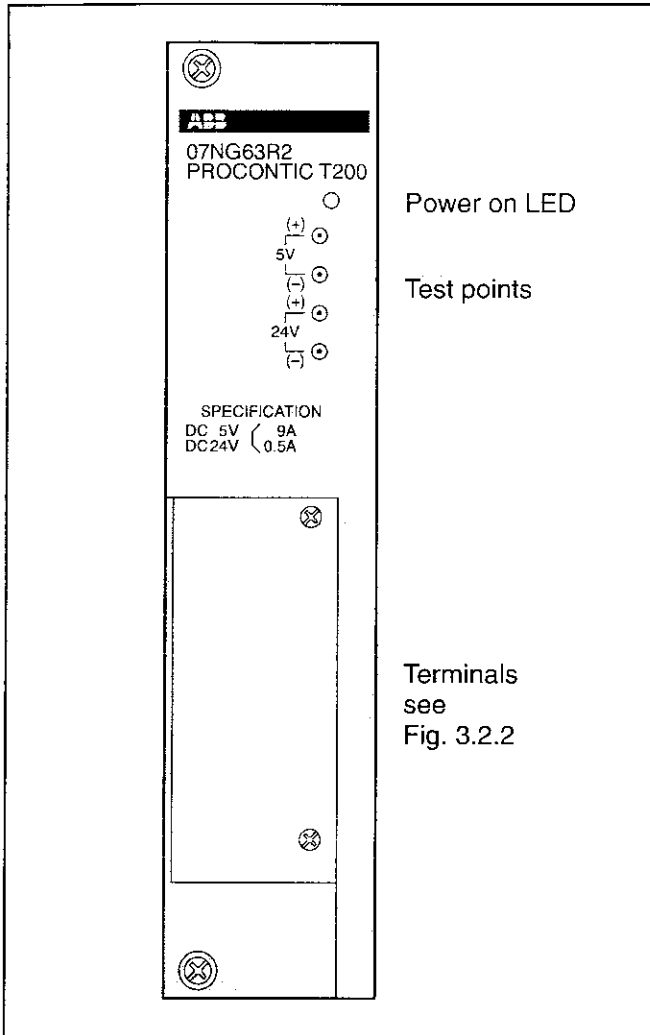

Fig. 3.2.1: Power supply unit 07 NG 63

The power supply unit 07 NG 63 generates the internal voltages 5 V/9 A and 24 V/0.5 A required for the PLC. It is supplied by an input voltage of 230 V AC or 120 V AC alternatively. In order to select the input voltage plug the jumper into the respective position (see Fig. 3.2.2).

07 NG 63 is short-circuit-proof and includes an over-voltage protection. A green LED indicates that the power supply unit is in operation.

In addition, the operation state of the central unit is allocated to a relay (RUN contact), i.e. as long as the central unit is in the RUN state, the contact of the relay is closed. The RUN contact only indicates the state of the central unit, when the power supply unit is mounted in the basic subrack, i.e. RUN contacts of power supply units in expansion subracks are permanently open.

Technical Data

Input voltage	selectable
UN1	230 V AC (+ 20 %, - 22 %)
UN2	120 V AC (+ 20 %, - 22 %)
frequency	47 Hz ... 63 Hz
Output voltages (system internal voltages)	
UB1	5 V DC (- 1 % ... + 5 %)
UB4	24 V DC (0 % ... + 30 %)
short-circuit-proof	yes
Output load capability	
UB1 = 5 V DC	max. 9.0 A
UB4 = 24 V DC	max. 0.5 A
Electrical isolation	between input voltage and output voltages, between output voltages
Nominal insulation voltage, process terminals versus subrack and output voltages:	
according to VDE 0160	250 V AC
tested with	1500 V AC
Power consumption	max. 150 VA

Power dissipation		max. 22.8 W	
Conductor cross section of process terminals			
L1, N		max. 1.5 mm ²	
PE (protective earth)		max. 2.5 mm ²	
Buffered voltage interruption time		≥ 20 ms	
Specification RUN contact			
switching voltage		4.5 V ... 264 V, AC or DC	
switching current		max. 2 A	
switching power,	if AC is switched	min. 1 mA at 5 V DC	
	if DC is switched	max. 0.5 kVA	
contact lifetime		max. 50 W	
mechanical contact lifetime		≥ 20,000 cycles at max. load	
contact protection against arcing		≥ 10 ⁶ cycles	
bounce time		no (only resistive load is permitted)	
Indication of operating		≤ 4 ms	
Number of required slots		one green LED	
Ability of fitting in subracks		1 NG slot	
slots, ● = plug-in is possible			
	BT	BE-central	BE-remote
	NG ZE I/O	NG BV I/O	NG BV I/O
	●	●	●
Weight		1 kg	
Order number of module 07 NG 63 R2		GJV3074313R2	

Block Diagram

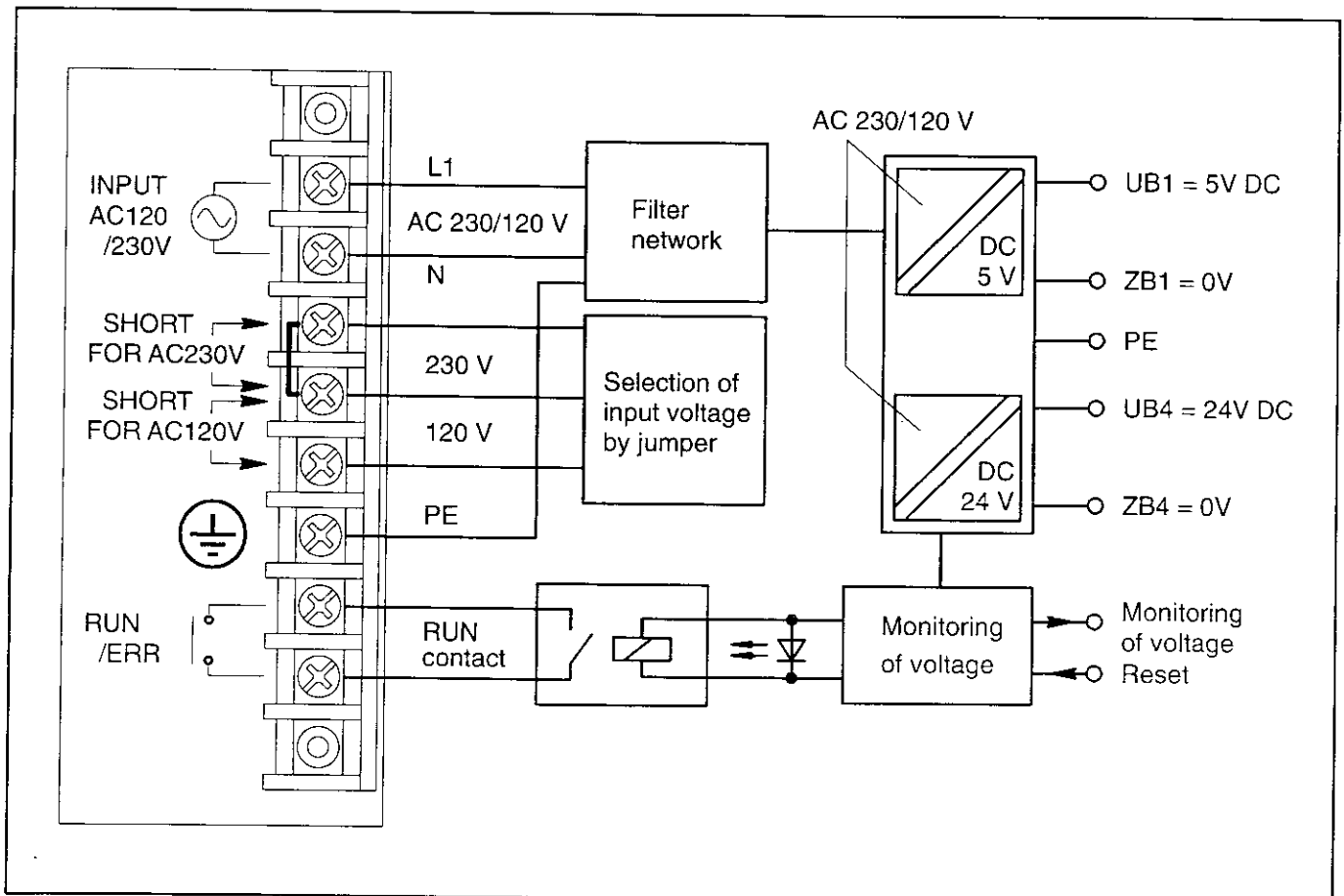
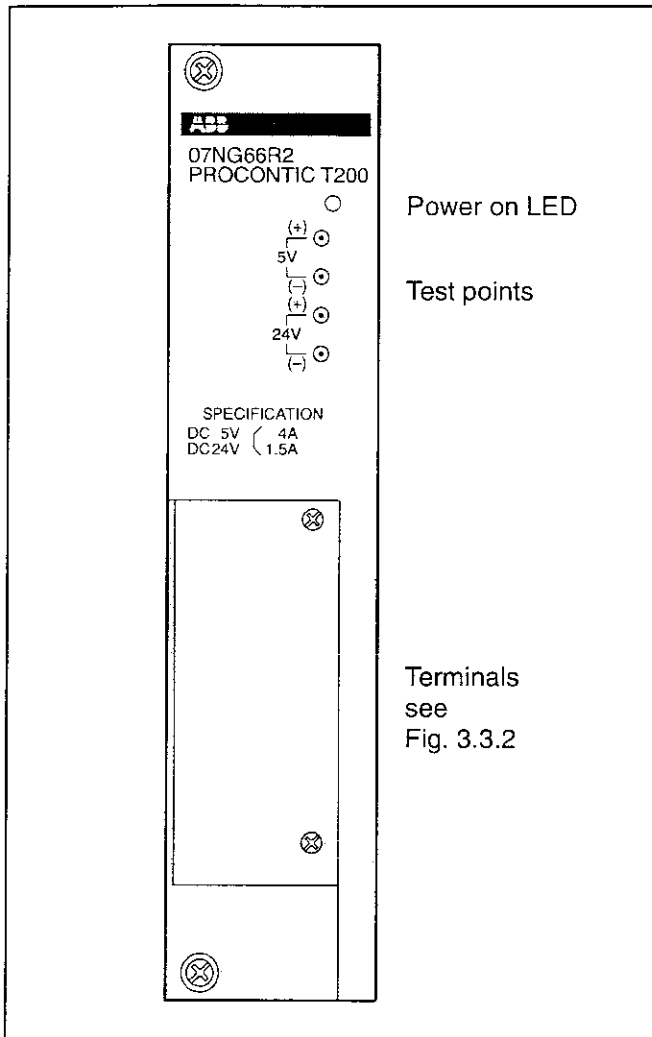

Fig. 3.2.2: Block diagram 07 NG 63 R2

3.3 Power Supply Unit 07 NG 66 R2

Input voltage: 24 V DC, output voltages: 5 V DC/4 A, 24 V DC/1.5 A



The power supply unit 07 NG 66 generates the internal voltages 5 V/4 A and 24 V/1.5 A required for the PLC. It is supplied by an input voltage of 24 V DC.

07 NG 66 is short-circuit-proof and includes an over-voltage protection. A green LED indicates that the power supply unit is in operation.

In addition, the operation state of the central unit is allocated to a relay (RUN contact), i.e. as long as the central unit is in the RUN state, the contact of the relay is closed. The RUN contact only indicates the state of the central unit, when the power supply unit is mounted in the basic subrack, i.e. RUN contacts of power supply units in expansion subracks are permanently open.

Fig. 3.3.1: Power supply unit 07 NG 66

Technical Data

Input voltage (incl. ripple)	24 V DC (+ 25 %, – 20 %)
Ripple of input voltage	max. 4 Vpp
Output voltages (system internal voltages)	
UB1	5 V DC (– 1 % ... + 5 %)
UB4	24 V DC (0 % ... + 30 %)
short-circuit-proof	yes
Output load capability	
UB1 = 5 V DC	max. 4.0 A
UB4 = 24 V DC	max. 1.5 A
Electrical isolation	between input voltage and output voltages, between output voltages
Nominal insulation voltage, process terminals versus subrack and output voltages:	
according to VDE 0160	60 V AC
tested with	500 V AC
Power consumption	max. 100 W
Power dissipation	max. 22.4 W

Conductor cross section of process terminals	max. 2.5 mm ²																											
Buffered voltage interruption time	≥ 1 ms																											
Specification RUN contact																												
switching voltage	4.5 V ... 264 V, AC or DC																											
switching current	max. 2 A																											
	min. 1 mA at 5 V DC																											
switching power, if AC is switched	max. 0.5 kVA																											
if DC is switched	max. 50 W																											
contact lifetime	≥ 20,000 cycles at max. load																											
mechanical contact lifetime	≥ 10 ⁶ cycles																											
contact protection against arcing	no (only resistive load is permitted)																											
bounce time	≤ 4 ms																											
Indication of operating	one green LED																											
Number of required slots	1 NG slot																											
Ability of fitting in subracks																												
slots, ● = plug-in is possible																												
	<table border="1" style="display: inline-table; border-collapse: collapse;"> <thead> <tr> <th colspan="3">BT</th> <th colspan="3">BE-central</th> <th colspan="3">BE-remote</th> </tr> <tr> <th>NG</th><th>ZE</th><th>I/O</th> <th>NG</th><th>BV</th><th>I/O</th> <th>NG</th><th>BV</th><th>I/O</th> </tr> </thead> <tbody> <tr> <td>●</td><td></td><td></td> <td>●</td><td></td><td></td> <td>●</td><td></td><td></td> </tr> </tbody> </table>	BT			BE-central			BE-remote			NG	ZE	I/O	NG	BV	I/O	NG	BV	I/O	●			●			●		
BT			BE-central			BE-remote																						
NG	ZE	I/O	NG	BV	I/O	NG	BV	I/O																				
●			●			●																						
Weight	1 kg																											
Order number of module 07 NG 66 R2	GJV3074315R2																											

Block Diagram

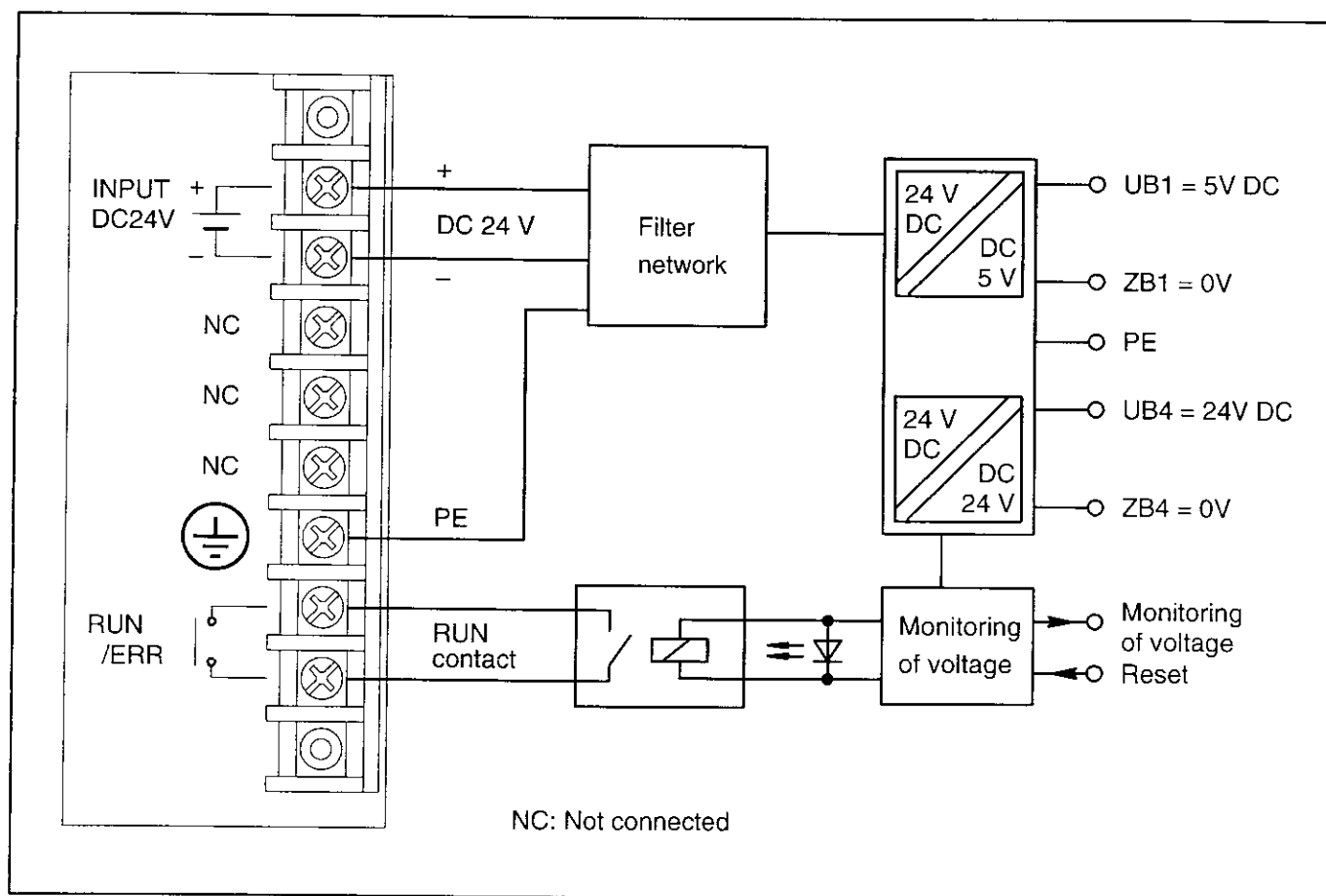

Fig. 3.3.2: Block diagram 07 NG 66 R2

3.4 Power Supply Unit 07 NG 68 R2

Input voltage: 24 V DC, output voltages: 5 V DC/9 A, 24 V DC/0.5 A

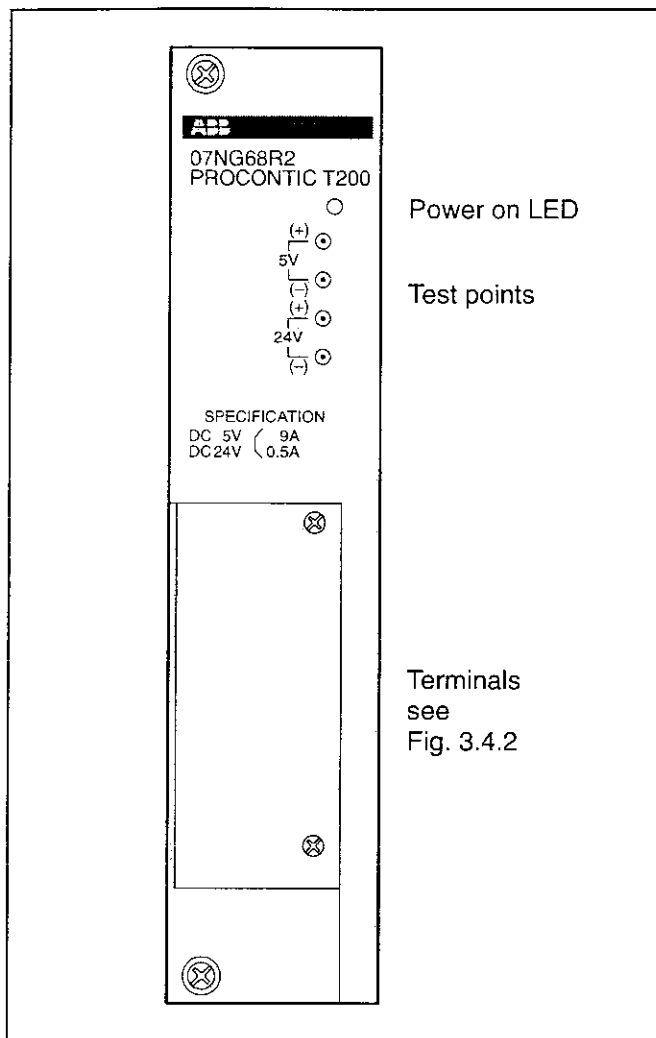

Fig. 3.4.1: Power supply unit 07 NG 68

The power supply unit 07 NG 68 generates the internal voltages 5 V/9 A and 24 V/0.5 A required for the PLC. It is supplied by an input voltage of 24 V DC.

07 NG 68 is short-circuit-proof and includes an over-voltage protection. A green LED indicates that the power supply unit is in operation.

In addition, the operation state of the central unit is allocated to a relay (RUN contact), i.e. as long as the central unit is in the RUN state, the contact of the relay is closed. The RUN contact only indicates the state of the central unit, when the power supply unit is mounted in the basic subrack, i.e. RUN contacts of power supply units in expansion subracks are permanently open.

Technical Data

Input voltage (incl. ripple)	24 V DC (+ 25 %, - 20 %)
Ripple of input voltage	max. 4 Vpp
Output voltages (system internal voltages)	
UB1	5 V DC (- 1 % ... + 5 %)
UB4	24 V DC (0 % ... + 30 %)
short-circuit-proof	yes
Output load capability	
UB1 = 5 V DC	max. 9.0 A
UB4 = 24 V DC	max. 0.5 A
Electrical isolation	between input voltage and output voltages, between output voltages
Nominal insulation voltage, process terminals versus subrack and output voltages:	
according to VDE 0160	60 V AC
tested with	500 V AC
Power consumption	max. 100 W
Power dissipation	max. 22.8 W

Conductor cross section of process terminals	max. 2.5 mm ²																											
Buffered voltage interruption time	≥ 1 ms																											
Specification RUN contact																												
switching voltage	4.5 V ... 264 V, AC or DC																											
switching current	max. 2 A																											
	min. 1 mA at 5 V DC																											
switching power, if AC is switched	max. 0.5 kVA																											
if DC is switched	max. 50 W																											
contact lifetime	≥ 20,000 cycles at max. load																											
mechanical contact lifetime	≥ 10 ⁶ cycles																											
contact protection against arcing	no (only resistive load is permitted)																											
bounce time	≤ 4 ms																											
Indication of operating	one green LED																											
Number of required slots	1 NG slot																											
Ability of fitting in subracks																												
slots, ● = plug-in is possible																												
	<table border="1" style="border-collapse: collapse; text-align: center;"> <thead> <tr> <th colspan="3">BT</th> <th colspan="3">BE-central</th> <th colspan="3">BE-remote</th> </tr> <tr> <th>NG</th><th>ZE</th><th>I/O</th> <th>NG</th><th>BV</th><th>I/O</th> <th>NG</th><th>BV</th><th>I/O</th> </tr> </thead> <tbody> <tr> <td>●</td><td></td><td></td> <td>●</td><td></td><td></td> <td>●</td><td></td><td></td> </tr> </tbody> </table>	BT			BE-central			BE-remote			NG	ZE	I/O	NG	BV	I/O	NG	BV	I/O	●			●			●		
BT			BE-central			BE-remote																						
NG	ZE	I/O	NG	BV	I/O	NG	BV	I/O																				
●			●			●																						
Weight	1 kg																											
Order number of module 07 NG 68 R2	GJV3074317R2																											

Block Diagram

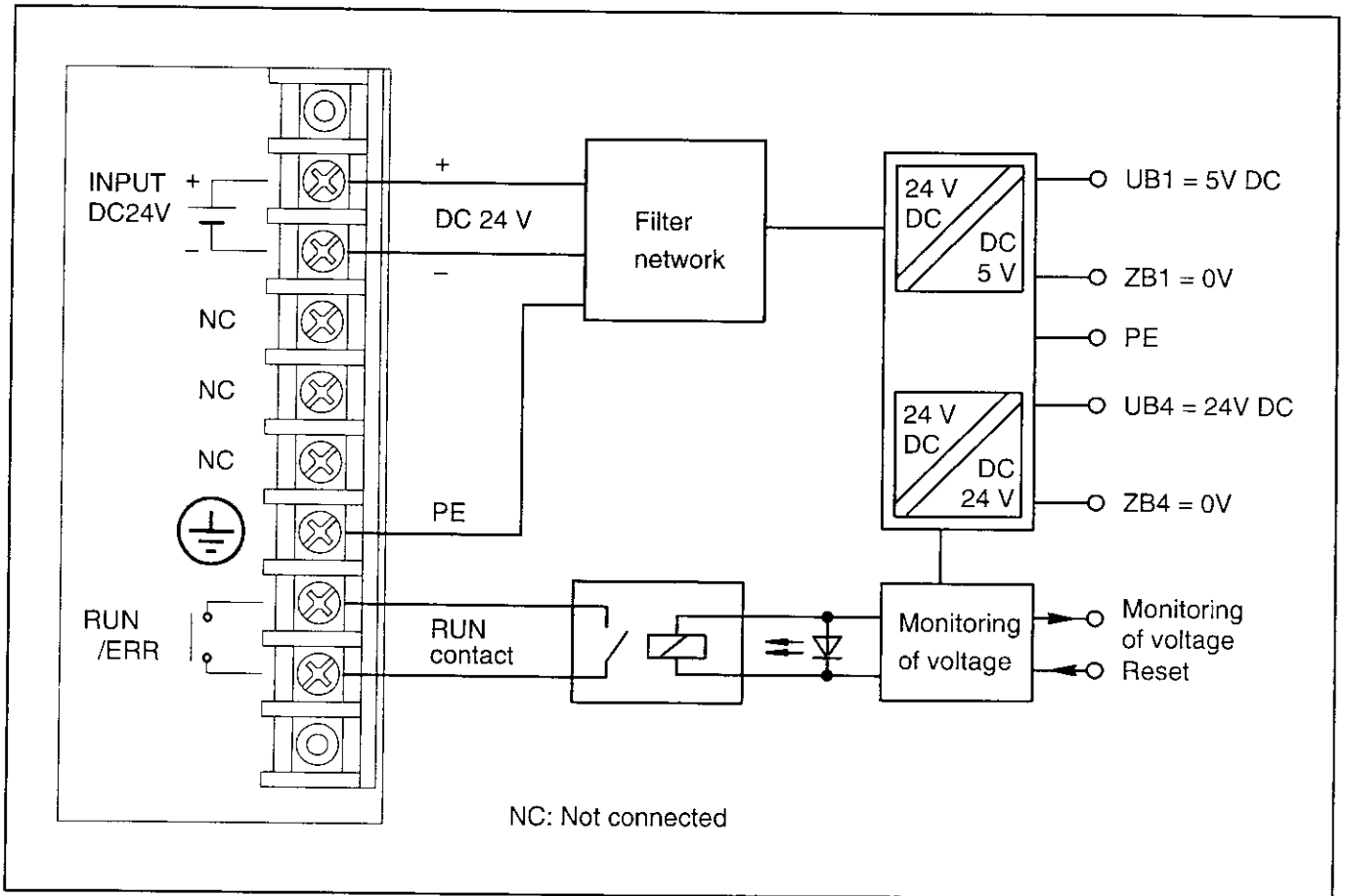

Fig. 3.4.2: Block diagram 07 NG 68 R2

3 Power Supply Units

Dependent on the power consumption of the configuration you can use one of the following power supply units:

07 NG 60 R1: Input voltage: 110/220 V AC, output voltages: 5 V DC/2.0 A, 24 V DC/2.0 A
07 NG 61 R1: Input voltage: 110/220 V AC, output voltages: 5 V DC/4.0 A, 24 V DC/1.5 A
07 NG 63 R1: Input voltage: 110/220 V AC, output voltages: 5 V DC/9.0 A, 24 V DC/0.5 A
07 NG 66 R1: Input voltage: 24 V DC, output voltages: 5 V DC/4.0 A, 24 V DC/1.5 A
07 NG 68 R1: Input voltage: 24 V DC, output voltages: 5 V DC/9.0 A, 24 V DC/0.5 A

3.1 Power supply Unit 07 NG 60 R1

Input voltage: 110/220 V AC, output voltages: 5 V DC/2 A, 24 V DC/2 A

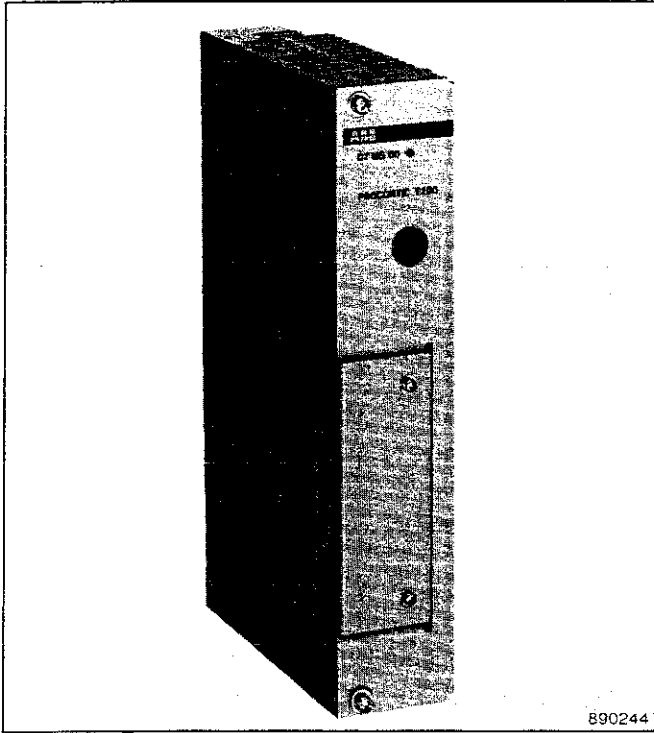

Fig. 3.1.1: Power supply unit 07 NG 60

The power supply unit 07 NG 60 generates the internal voltages 5 V/2 A and 24 V/2 A required for the PLC. It is supplied by an input voltage of 220 V AC or 110 V AC alternatively. In order to select the input voltage plug the jumper into the respective position (see Fig. 3.1.2).

07 NG 60 is used for operation in an expansion subrack by preference. It is short-circuit-proof and includes an over-voltage protection. A green LED indicates that the power supply unit is in operation.

In addition, the operation state of the central unit is allocated to a relay (RUN-contact), i.e. as long as the central unit is in the RUN state, the contact of the relay is closed. The RUN-contact only indicates the state of the central unit, when the power supply unit is mounted in the basic subrack, i.e. RUN-contacts of power supply units in expansion subracks are permanently open.

Technical Data

Input voltage	selectable
UN2	110 V AC (+ 20 %, - 22 %)
UN1	220 V AC (+ 20 %, - 22 %)
frequency	47 Hz ... 63 Hz
Output voltages (system internal voltages)	
UB1	5 V DC (- 1 % ... + 5 %)
UB4	24 V DC (0 % ... + 30 %)
short-circuit-proof	yes
Output load capability	
UB1 = 5 V DC	max. 2.0 A
UB4 = 24 V DC	max. 2.0 A
Electrical isolation	between input voltage and output voltages, between output voltages
Nominal insulation voltage, process terminals versus subrack and output voltages:	
acc. VDE 0160	250 V AC
tested with	1500 V AC
Power consumption	max. 150 VA
Power dissipation	max. 23.2 W
Conductor cross section of process terminals	
L1, N	max. 1.5 mm ²
PE (protective earth)	max. 2.5 mm ²
Buffered voltage interruption time	≥ 20 ms
Supply-side fuse	slow 5 A

Specification RUN-contact

switching voltage
switching current

switching power, if AC is switched
if DC is switched

contact lifetime
mechanical contact lifetime
contact protection against arcing
bounce time

Indication of operating

Number of required slots

Ability of fitting in subracks

slots, ● = plug-in is possible

Weight

Order number of module 07 NG 60 R1

4.5 V ... 264 V, AC or DC

max. 2 A

min. 1 mA at 5 V DC

max. 0.5 kVA

max. 50 W

≥ 20,000 cycles at max. load

≥ 10⁶ cycles

no (only resistive load is permitted)

≤ 4 ms

one green LED

1 NG slot

BT			BE-central			BE-remote		
NG	ZE	I/O	NG	BV	I/O	NG	BV	I/O
●			●			●		

1 kg

GJV3074310R1

Block Diagram

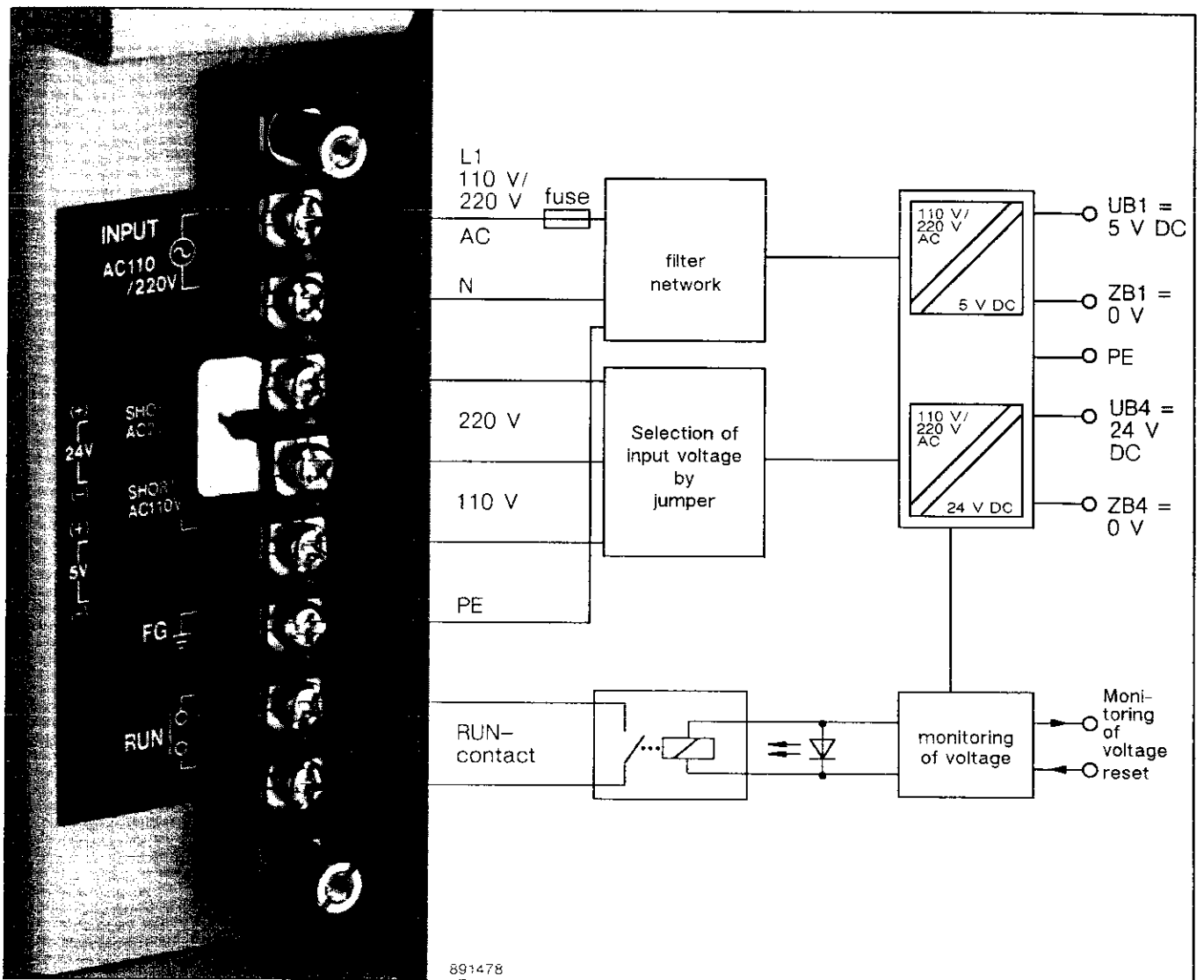

Fig. 3.1.2: Block diagram 07 NG 60 R1

3.2 Power supply Unit 07 NG 61 R1

Input voltage: 110/220 V AC, output voltages: 5 V DC/4 A, 24 V DC/1.5 A

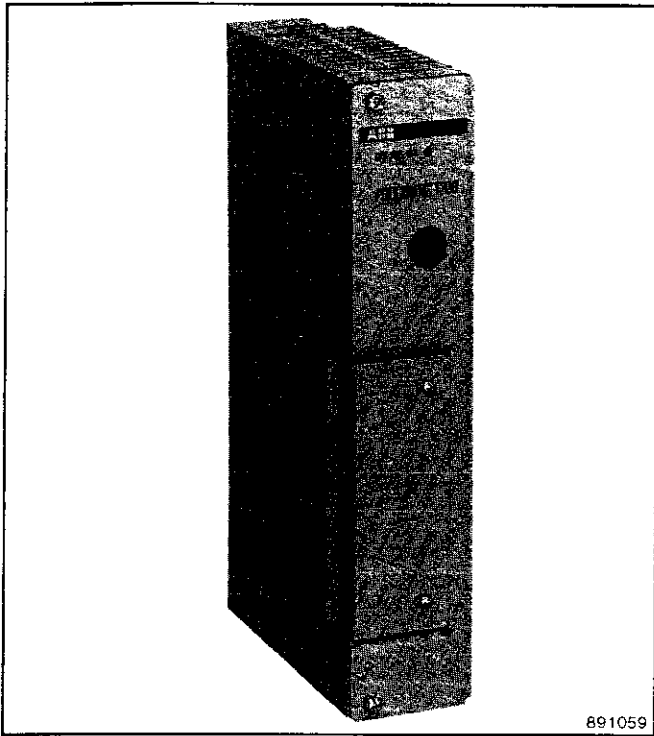

Fig. 3.2.1: Power supply unit 07 NG 61

The power supply unit 07 NG 61 generates the internal voltages 5 V/4 A and 24 V/1.5 A required for the PLC. It is supplied by an input voltage of 220 V AC or 110 V AC alternatively. In order to select the input voltage plug the jumper into the respective position (see Fig. 3.2.2).

07 NG 61 is short-circuit-proof and includes an over-voltage protection. A green LED indicates that the power supply unit is in operation.

In addition, the operation state of the central unit is allocated to a relay (RUN-contact), i.e. as long as the central unit is in the RUN state, the contact of the relay is closed. The RUN-contact only indicates the state of the central unit, when the power supply unit is mounted in the basic subrack, i.e. RUN-contacts of power supply units in expansion subracks are permanently open.

Technical Data

Input voltage	selectable
UN2	110 V AC (+ 20 %, - 22 %)
UN1	220 V AC (+ 20 %, - 22 %)
frequency	47 Hz ... 63 Hz
Output voltages (system internal voltages)	
UB1	5 V DC (- 1 % ... + 5 %)
UB4	24 V DC (0 % ... + 30 %)
short-circuit-proof	yes
Output load capability	
UB1 = 5 V DC	max. 4.0 A
UB4 = 24 V DC	max. 1.5 A
Electrical isolation	between input voltage and output voltages, between output voltages
Nominal insulation voltage, process terminals versus subrack and output voltages:	
acc. VDE 0160	250 V AC
tested with	1500 V AC
Power consumption	max. 150 VA
Power dissipation	max. 22.4 W
Conductor cross section of process terminals	
L1, N	max. 1.5 mm ²
PE (protective earth)	max. 2.5 mm ²
Buffered voltage interruption time	≥ 20 ms
Supply-side fuse	slow 5 A

Specification RUN-contact

switching voltage
switching current

switching power, if AC is switched
if DC is switched

contact lifetime
mechanical contact lifetime
contact protection against arcing
bounce time

Indication of operating

Number of required slots

Ability of fitting in subracks

slots, ● = plug-in is possible

Weight

Order number of module 07 NG 61 R1

4.5 V ... 264 V, AC or DC

max. 2 A

min. 1 mA at 5 V DC

max. 0.5 kVA

max. 50 W

≥ 20,000 cycles at max. load

≥ 10⁶ cycles

no (only resistive load is permitted)

≤ 4 ms

one green LED

1 NG slot

BT			BE-central			BE-remote		
NG	ZE	I/O	NG	BV	I/O	NG	BV	I/O
●			●			●		

1 kg

GJV3074311R1

Block Diagram

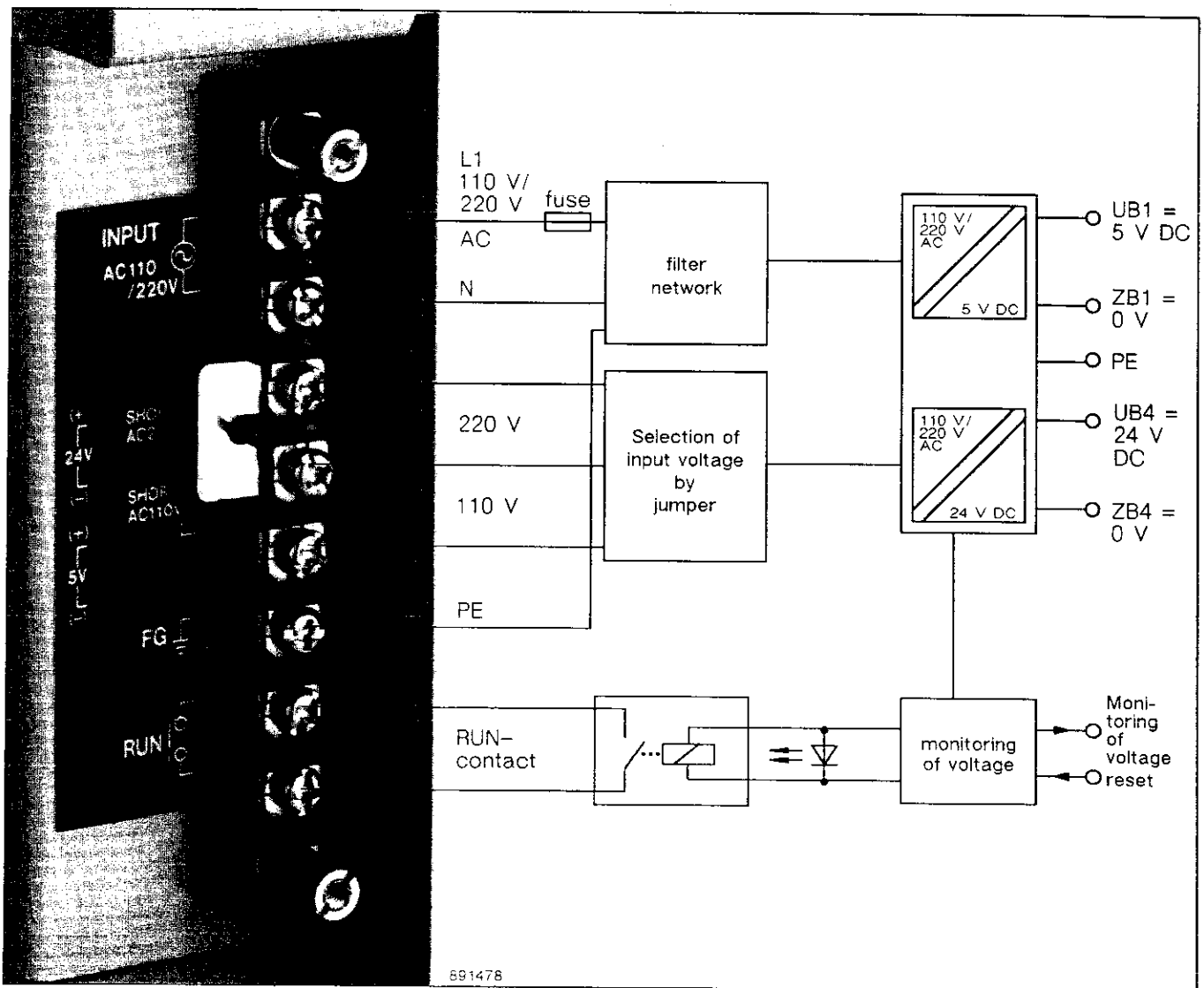

Fig. 3.2.2: Block diagram 07 NG 61 R1

3.3 Power supply Unit 07 NG 63 R1

Input voltage: 110/220 V AC, output voltages: 5 V DC/9 A, 24 V DC/0.5 A

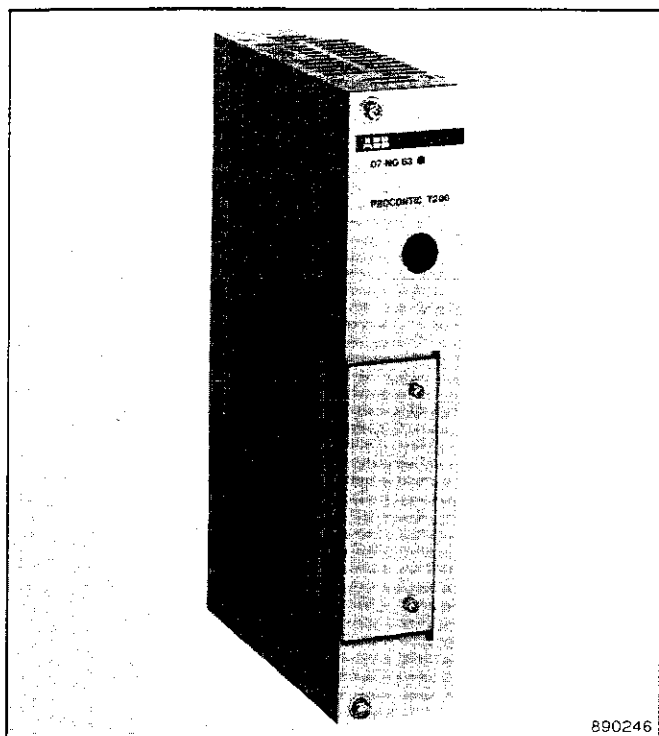

Fig. 3.3.1: Power supply unit 07 NG 63

The power supply unit 07 NG 63 generates the internal voltages 5 V/9 A and 24 V/0.5 A required for the PLC. It is supplied by an input voltage of 220 V AC or 110 V AC alternatively. In order to select the input voltage plug the jumper into the respective position (see Fig. 3.3.2).

07 NG 63 is short-circuit-proof and includes an over-voltage protection. A green LED indicates that the power supply unit is in operation.

In addition, the operation state of the central unit is allocated to a relay (RUN-contact), i.e. as long as the central unit is in the RUN state, the contact of the relay is closed. The RUN-contact only indicates the state of the central unit, when the power supply unit is mounted in the basic subrack, i.e. RUN-contacts of power supply units in expansion subracks are permanently open.

Technical Data

Input voltage	selectable
UN2	110 V AC (+ 20 %, - 22 %)
UN1	220 V AC (+ 20 %, - 22 %)
frequency	47 Hz ... 63 Hz
Output voltages (system internal voltages)	
UB1	5 V DC (- 1 % ... + 5 %)
UB4	24 V DC (0 % ... + 30 %)
short-circuit-proof	yes
Output load capability	
UB1 = 5 V DC	max. 9.0 A
UB4 = 24 V DC	max. 0.5 A
Electrical isolation	between input voltage and output voltages, between output voltages
Nominal insulation voltage, process terminals versus subrack and output voltages:	
acc. VDE 0160	250 V AC
tested with	1500 V AC
Power consumption	max. 150 VA
Power dissipation	max. 22.8 W
Conductor cross section of process terminals	
L1, N	max. 1.5 mm ²
PE (protective earth)	max. 2.5 mm ²
Buffered voltage interruption time	≥ 20 ms
Supply-side fuse	slow 5 A

Specification RUN-contact		
switching voltage		4.5 V ... 264 V, AC or DC
switching current		max. 2 A
		min. 1 mA at 5 V DC
switching power,	if AC is switched	max. 0.5 kVA
	if DC is switched	max. 50 W
contact lifetime		≥ 20,000 cycles at max. load
mechanical contact lifetime		≥ 10 ⁶ cycles
contact protection against arcing		no (only resistive load is permitted)
bounce time		≤ 4 ms
Indication of operating		one green LED
Number of required slots		1 NG slot
Ability of fitting in subracks		
slots, ● = plug-in is possible		
Weight		1 kg
Order number of module 07 NG 63 R1		GJV3074313R1

BT			BE-central			BE-remote		
NG	ZE	I/O	NG	BV	I/O	NG	BV	I/O
●			●			●		

Block Diagram

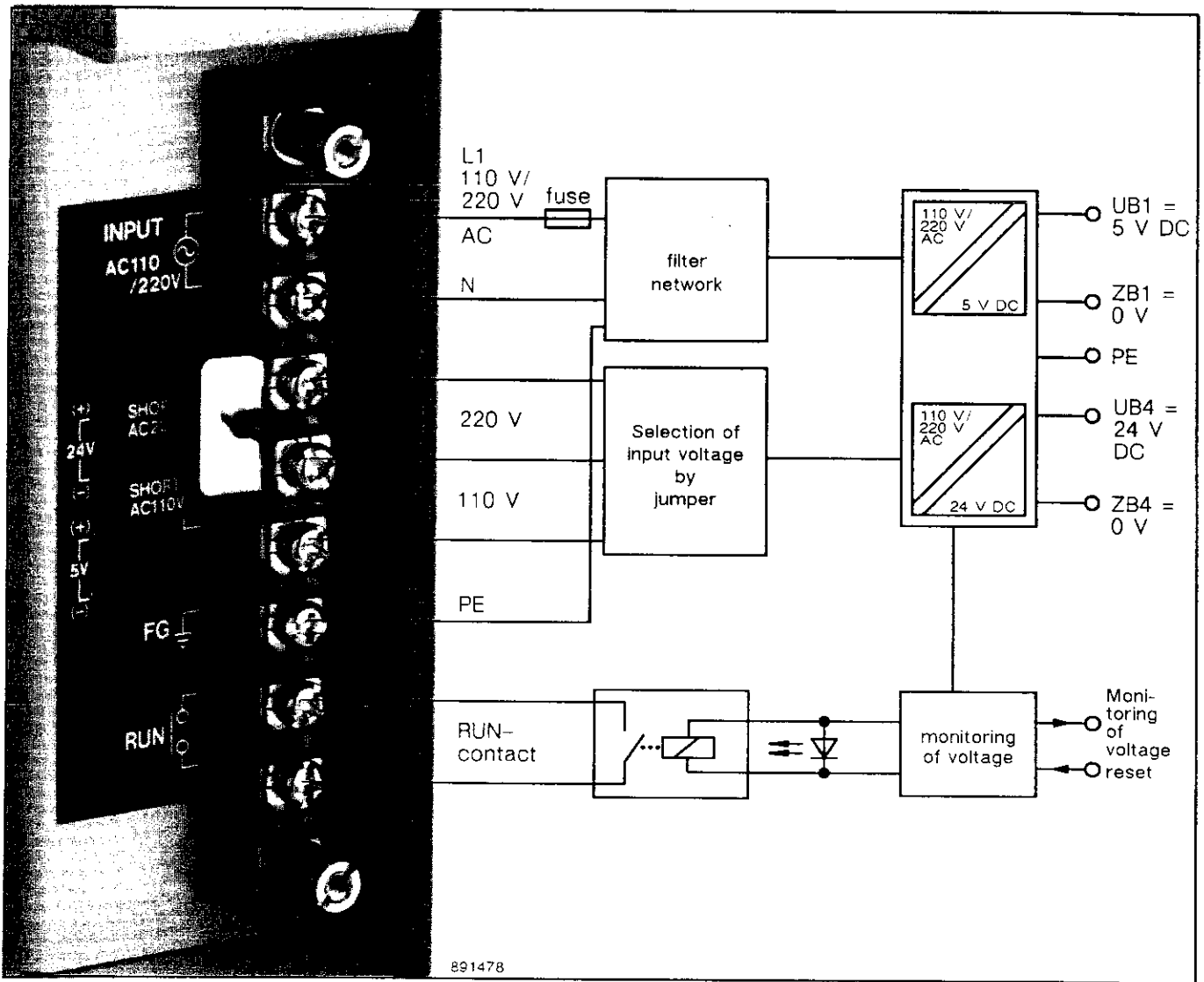

Fig. 3.3.2: Block diagram 07 NG 63 R1

3.4 Power Supply Unit 07 NG 66 R1

Input voltage: 24 V DC, output voltages: 5 V DC/4 A, 24 V DC/1.5 A

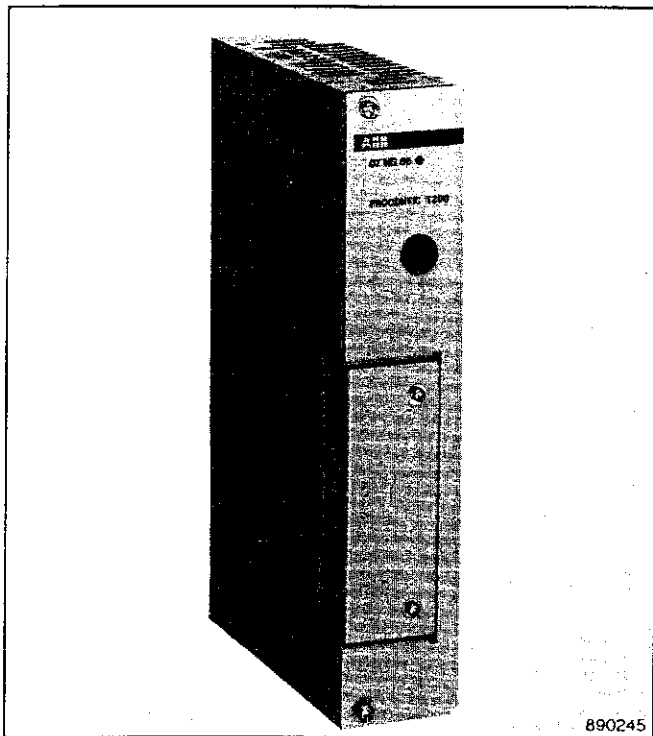

Fig. 3.4.1: Power supply unit 07 NG 66

The power supply unit 07 NG 66 generates the internal voltages 5 V/4 A and 24 V/1.5 A required for the PLC. It is supplied by an input voltage of 24 V DC.

07 NG 66 is short-circuit-proof and includes an over-voltage protection. A green LED indicates that the power supply unit is in operation.

In addition, the operation state of the central unit is allocated to a relay (RUN-contact), i.e. as long as the central unit is in the RUN state, the contact of the relay is closed. The RUN-contact only indicates the state of the central unit, when the power supply unit is mounted in the basic subrack, i.e. RUN-contacts of power supply units in expansion subracks are permanently open.

Technical Data

Input voltage (incl. ripple)	24 V DC (+ 25 %, - 20 %)
Ripple of input voltage	max. 4 Vpp
Output voltages (system internal voltages)	
UB1	5 V DC (- 1 % ... + 5 %)
UB4	24 V DC (0 % ... + 30 %)
short-circuit-proof	yes
Output load capability	
UB1 = 5 V DC	max. 4.0 A
UB4 = 24 V DC	max. 1.5 A
Electrical isolation	between input voltage and output voltages, between output voltages
Nominal insulation voltage, process terminals versus subrack and output voltages:	
acc. VDE 0160	60 V AC
tested with	500 V AC
Power consumption	max. 100 W
Power dissipation	max. 22.4 W
Conductor cross section of process terminals	max. 2.5 mm ²
Buffered voltage interruption time	≥ 1 ms
Supply-side fuse	slow 6.3 A

Specification RUN-contact

switching voltage
switching current

switching power, if AC is switched
if DC is switched

contact lifetime
mechanical contact lifetime
contact protection against arcing
bounce time

Indication of operating

Number of required slots

Ability of fitting in subracks

slots, ● = plug-in is possible

Weight

Order number of module 07 NG 66 R1

4.5 V ... 264 V, AC or DC

max. 2 A

min. 1 mA at 5 V DC

max. 0.5 kVA

max. 50 W

≥ 20,000 cycles at max. load

≥ 10⁶ cycles

no (only resistive load is permitted)

≤ 4 ms

one green LED

1 NG slot

BT			BE-central			BE-remote		
NG	ZE	I/O	NG	BV	I/O	NG	BV	I/O
●			●			●		

1 kg

GJV3074315R1

Block Diagram

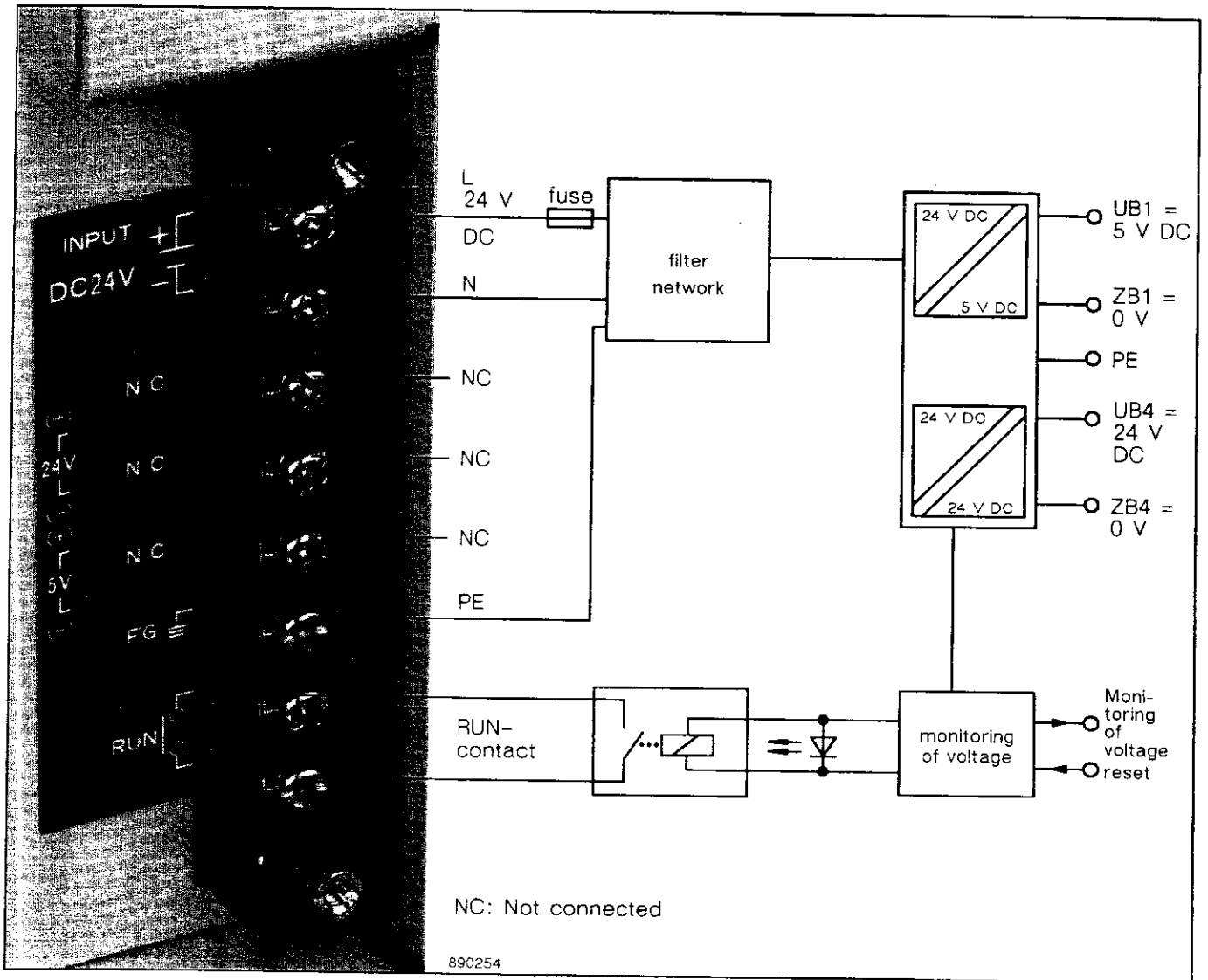

Fig. 3.4.2: Block diagram 07 NG 66 R1

3.5 Power Supply Unit 07 NG 68 R1

Input voltage: 24 V DC, output voltages: 5 V DC/9 A, 24 V DC/0.5 A

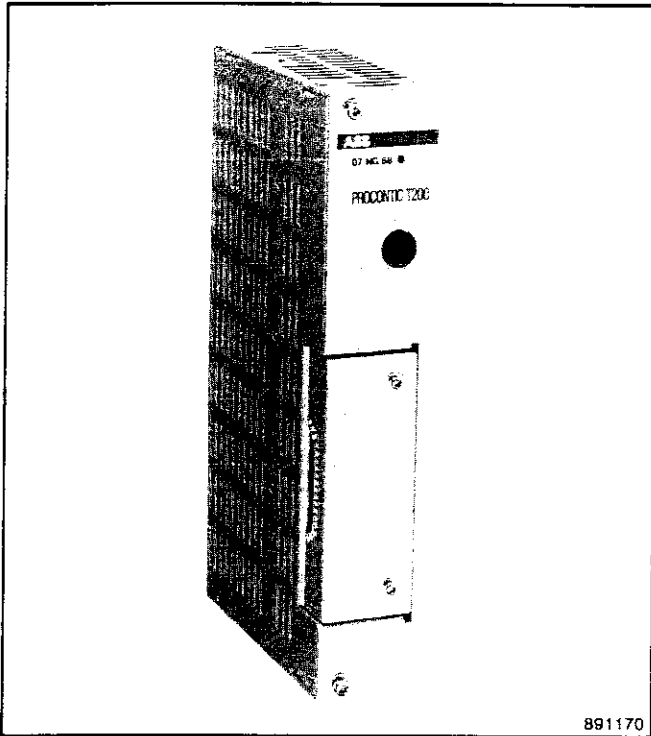

Fig. 3.5.1: Power supply unit 07 NG 68

The power supply unit 07 NG 68 generates the internal voltages 5 V/9 A and 24 V/0.5 A required for the PLC. It is supplied by an input voltage of 24 V DC.

07 NG 68 is short-circuit-proof and includes an over-voltage protection. A green LED indicates that the power supply unit is in operation.

In addition, the operation state of the central unit is allocated to a relay (RUN-contact), i.e. as long as the central unit is in the RUN state, the contact of the relay is closed. The RUN-contact only indicates the state of the central unit, when the power supply unit is mounted in the basic subrack, i.e. RUN-contacts of power supply units in expansion subracks are permanently open.

Technical Data

Input voltage (incl. ripple)	24 V DC (+ 25 %, - 20 %)
Ripple of input voltage	max. 4 Vpp
Output voltages (system internal voltages)	
UB1	5 V DC (- 1 % ... + 5 %)
UB4	24 V DC (0 % ... + 30 %)
short-circuit-proof	yes
Output load capability	
UB1 = 5 V DC	max. 9.0 A
UB4 = 24 V DC	max. 0.5 A
Electrical isolation	between input voltage and output voltages, between output voltages
Nominal insulation voltage, process terminals versus subrack and output voltages:	
acc. VDE 0160	60 V AC
tested with	500 V AC
Power consumption	max. 100 W
Power dissipation	max. 22.8 W
Conductor cross section of process terminals	max. 2.5 mm ²
Buffered voltage interruption time	≥ 1 ms
Supply-side fuse	slow 6.3 A

Specification RUN-contact		
switching voltage		4.5 V ... 264 V, AC or DC
switching current		max. 2 A
		min. 1 mA at 5 V DC
switching power,	if AC is switched	max. 0.5 kVA
	if DC is switched	max. 50 W
contact lifetime		≥ 20,000 cycles at max. load
mechanical contact lifetime		≥ 10 ⁶ cycles
contact protection against arcing		no (only resistive load is permitted)
bounce time		≤ 4 ms
Indication of operating		one green LED
Number of required slots		1 NG slot
Ability of fitting in subracks		
slots, ● = plug-in is possible		
Weight		1 kg
Order number of module 07 NG 68 R1		GJV3074317R1

BT			BE-central			BE-remote		
NG	ZE	I/O	NG	BV	I/O	NG	BV	I/O
●			●			●		

Block Diagram

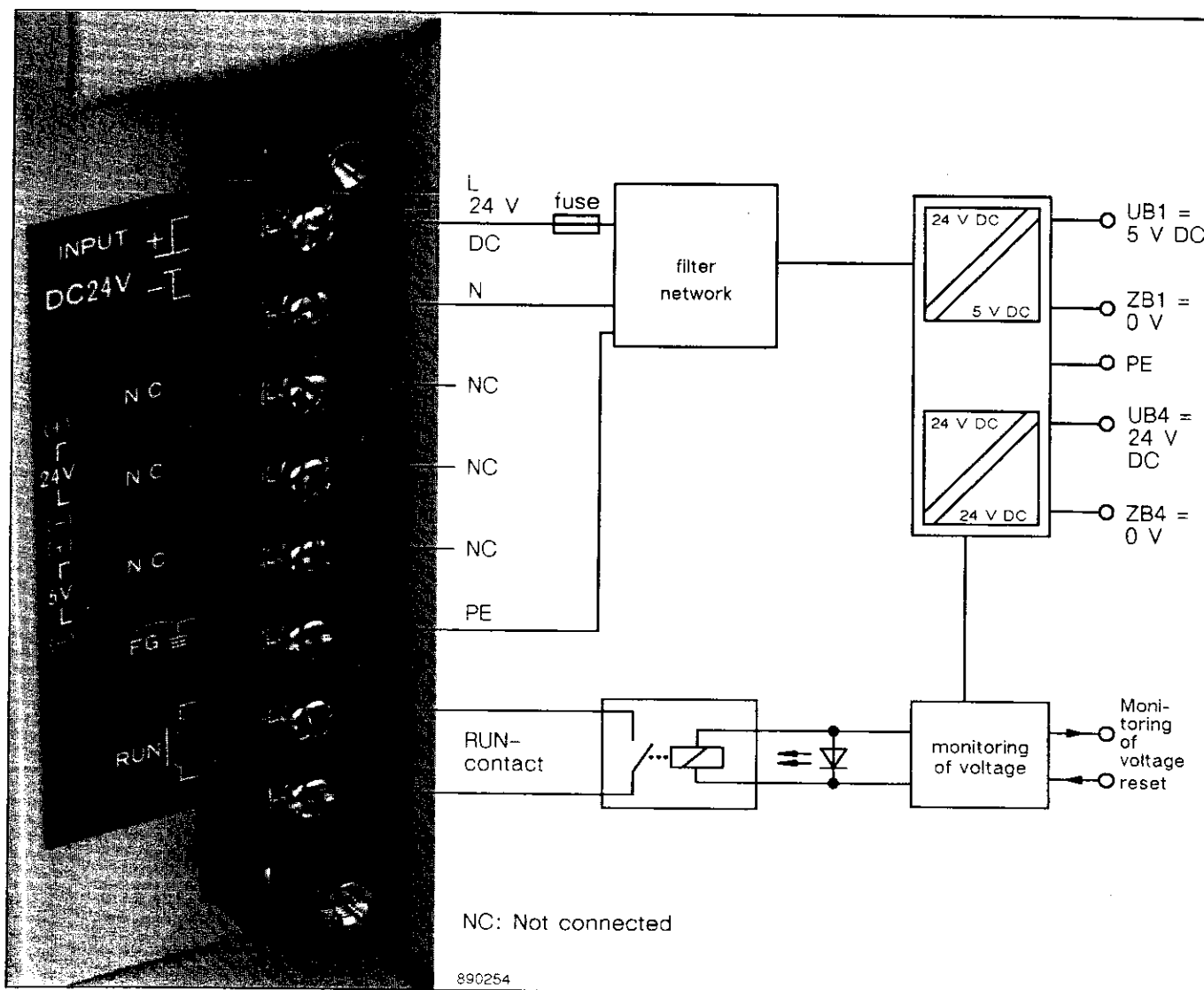

Fig. 3.5.2: Block diagram 07 NG 68 R1

4 I/O Expansions and Couplers

- 07 BV 60 R1: Bus connector for central I/O expansions
- 07 BR 60 R1: Remote I/O coupler with triaxial cable ¹⁾ for 512 I/O points maximum
- 07 BR 60 R2: Remote I/O coupler with optical fibre for 512 I/O points maximum
- 07 BR 61 R1: Remote I/O coupler with triaxial cable ¹⁾ for remote substation
- 07 BR 61 R2: Remote I/O coupler with optical fibre for remote substation
- 07 ZB 60 R1: Coupler with triaxial cable ¹⁾ for connection to ABB Procontic field bus ZB 10
- 07 ZB 60 R2: Coupler with twin axial cable ²⁾ for connection to ABB Procontic field bus ZB 10
- 07 ZB 69 R1: Coupler with triaxial cable ¹⁾ for connection to ZB 20 bus
- 07 ZB 69 R2: Coupler with optical fibre for connection to ZB 20 bus
- 07 CS 61 R202: Remote I/O coupler for connection of ABB Procontic CS31 to ABB Procontic T200

¹⁾ TRIAX = double shielded coaxial cable

²⁾ TWINAX = twin axial cable (2-core, twisted and shielded high-frequency data transmission line)

4.1 Bus Connector 07 BV 60 R1 for central I/O expansions

The bus connector is used for a central I/O expansion of a ABB Procontic T200. It has to be mounted in each expansion subrack (5 expansions maximum) at the first slot at the right side of the power supply unit (BV slot).

If the 07 BV 60 bus connector is located on a 07 BE 69 expansion subrack, up to two remote lines can be installed from here (see example in the description of the 07 BR 60 R1/R2 couplers).

On the front panel, the bus connector is equipped with 2 plug-in connectors for the connection to/from the next bus connector or to the central unit on the basic subrack. The connections are established by one of the system cables 07 SV 60 or 07 SV 61.

The number of the central I/O expansion subrack is set by a rotary switch on the front panel of the unit. The expansion subracks are numbered from 1 to 5, begin-

ning with 1 for the first expansion subrack. The basic subrack has number 0.

When setting up the central I/O expansion, the subracks are to be connected by equipotential bonding conductors (4 mm²/6 mm²). For the establishment of these connections, the subracks (BT/BE) are equipped with 2 screw-type terminals at the NG slots (at the top). We recommend you to lay the conductors through the opening under the left handles of the subracks (see Fig. 4.1.3).

The system cables 07 SV 60/61 must be laid separately, i.e. they must not be laid together with other cables into the same cable duct. The overall length of all system cables used in a central I/O expansion must not exceed 4 m. System cables with a length of 1 m (R 2) may only be used, if this is necessary for configuration (adjacent control cabinets).

Technical Data

Number of expansion subracks:

central unit	07 ZE 60	none
	07 ZE 61	1
	07 ZE 62/63	5

System cables to be used for connection:

07 ZE 61...63	- 07 BV 60 R1	07 SV 60 R1 (length 0.5 m) or R2 (length 1 m)
07 BV 60 R1	- 07 BV 60 R1	07 SV 61 R1 (length 0.5 m) or R2 (length 1 m)

Overall length of all system cables in a central I/O expansion

max. 4 m

Electrical isolation

no

Supply current from internal voltages

UB1 = 5 V DC

UB4 = 24 V DC

max. 0.22 A

no current consumption

Total power dissipation

max. 1.1 W

Signalling

none

Number of required slots

1 BV slot

Ability of fitting in subracks

slots, ● = plug-in is possible

BT	BE-central	BE-remote
NG ZE I/O	NG BV I/O ●	NG BV I/O

Weight

320 g

Order number of bus connector 07 BV 60 R1

GJV3074370R1

Accessories:

System cable 07 SV 60 R1 (0.5 m), order number

GJV3074371R1

System cable 07 SV 60 R2 (1.0 m), order number

GJV3074371R2

System cable 07 SV 61 R1 (0.5 m), order number

GJV3074372R1

System cable 07 SV 61 R2 (1.0 m), order number

GJV3074372R2

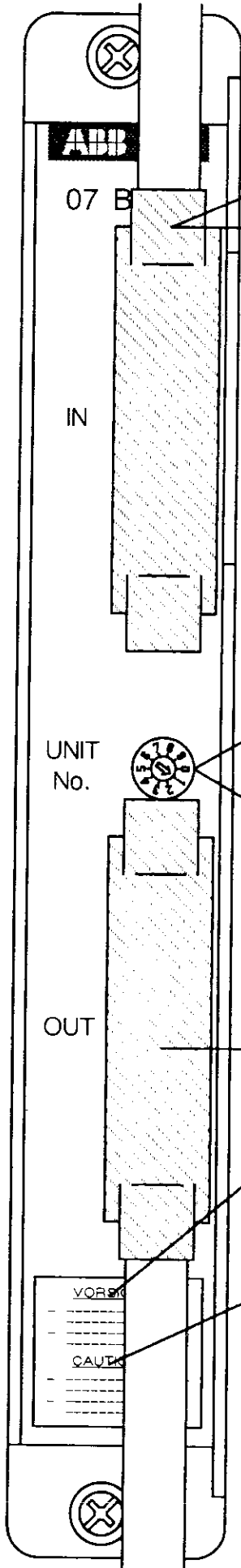
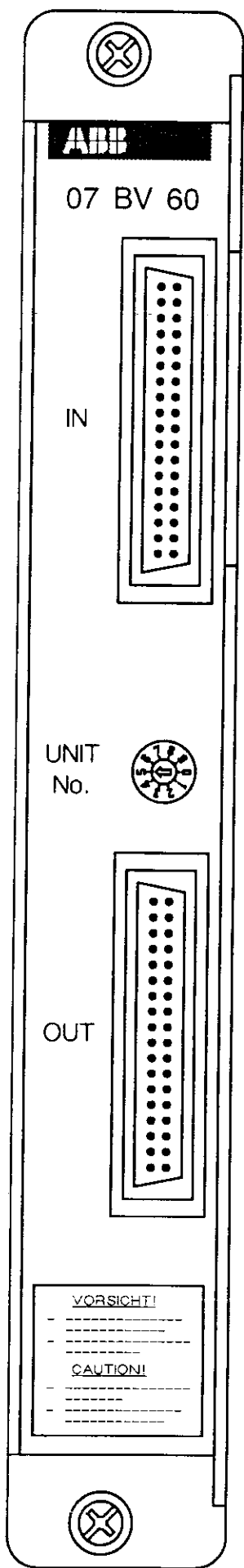

System cable 07 SV 60,
if the connection is made to a central unit

System cable 07 SV 61,
if the connection is made to a bus connector

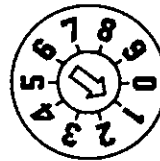

Here the number of the
expansion subrack
is set,
from 1

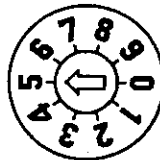

to 5

System cable 07 SV 61

VORSICHT!

- BAUGRUPPENTRÄGER-NR. NICHT
DOPPELT BELEGEN
- IM BETRIEB BAUGRUPPENTRÄGER-NR.
NICHT ÄNDERN

CAUTION!

- BE CAREFUL NOT TO SET DUPLICATE
UNIT No.
- DO NOT CHANGE UNIT No. WHILE
CPU IS IN RUN MODE

Fig. 4.1.1 (left): 07 BV 60 R1
without system cables

Fig. 4.1.1 (right): 07 BV 60 R1
with system cables

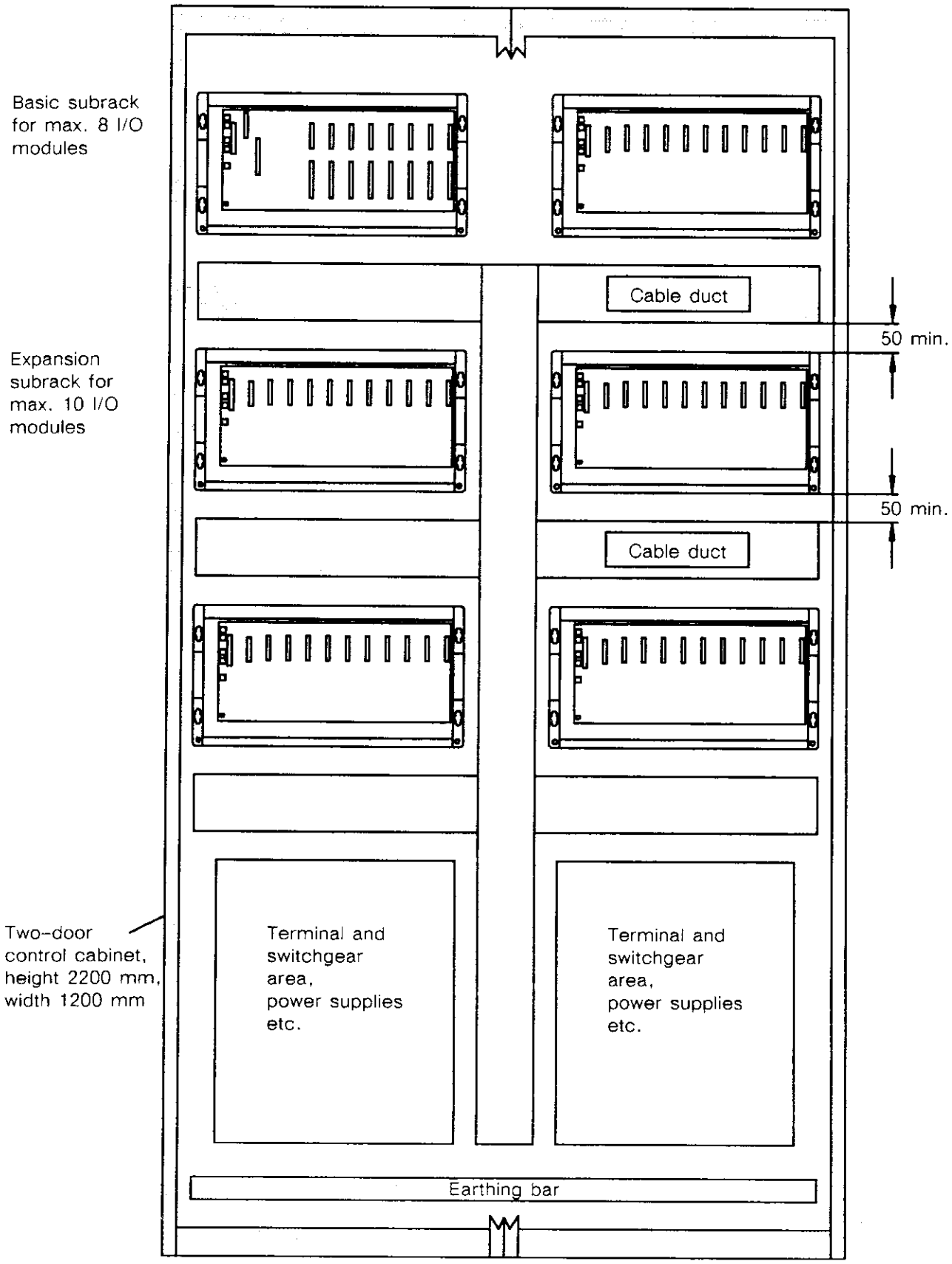

The minimum clearance between subracks and cable ducts is required in order to ensure a sufficient air circulation through the units for cooling

Installation of a central I/O expansion see Fig. 4.1.3 and Fig. 4.1.4 on the following pages

Fig. 4.1.2: Installation of the subracks in a control cabinet

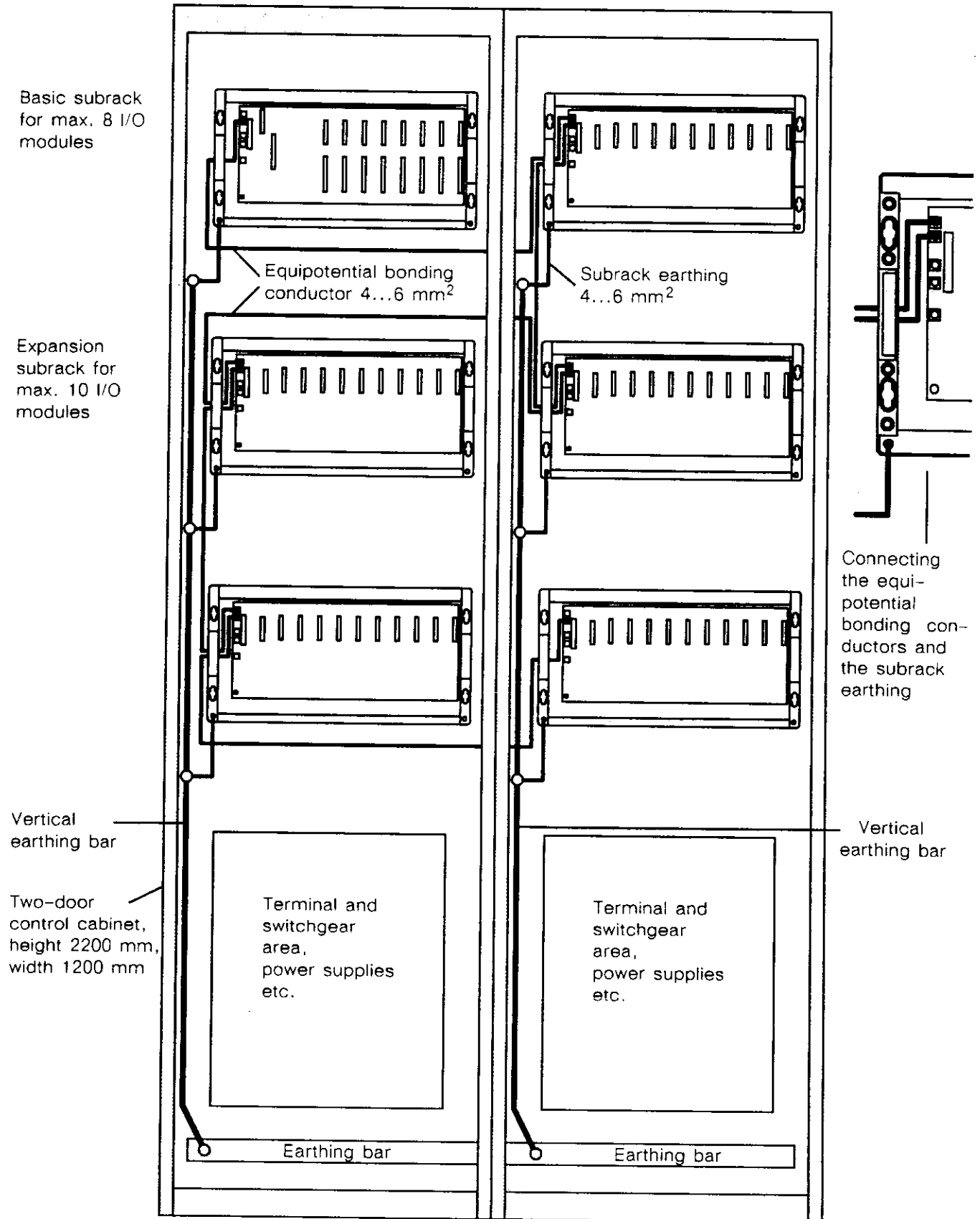

The equipotential bonding conductor starts at the basic subrack and runs via the first expansion subrack to the subsequent ones in the same sequence as the bus connectors 07 BV 60 are connected by the system cables 07 SV 60/61 (see also Fig. 4.1.4 on the next page). See also grounding concept volume 5 "Grounding".

Fig. 4.1.3: Equipotential bonding between the subracks of a central expansion (maximum configuration) and earthing of the subracks

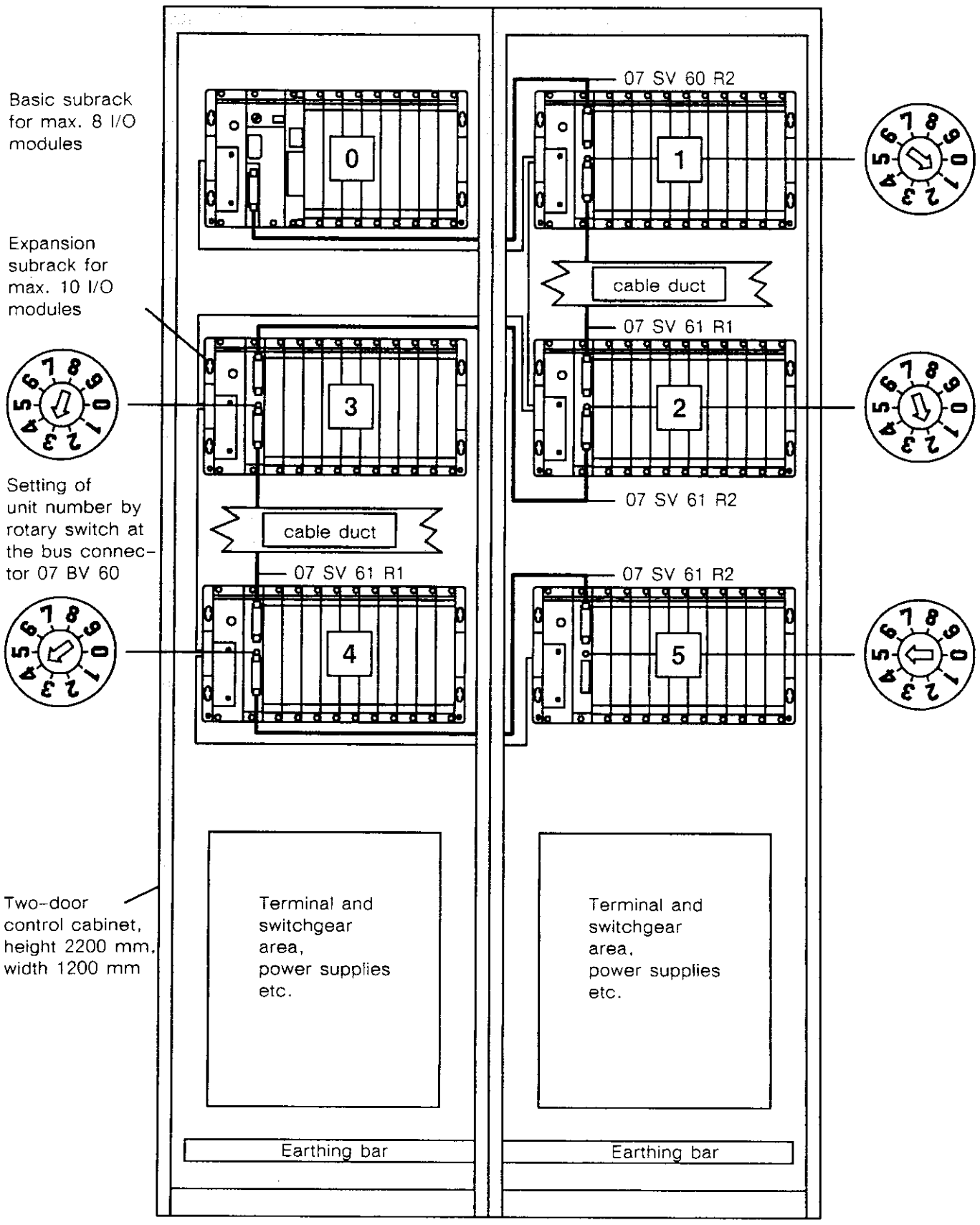

The central expansion starts at the basic subrack and is coupled via interfaces to the central unit and to the bus connectors. As connecting cables between the interfaces system cables 07 SV 60 (between central unit and the first bus connector 07 BV 60) and 07 SV 61 (between two bus connectors) are used, in lengths of 0.5 m (R 1) and 1.0 m (R 2) respectively.

Fig. 4.1.4: Selection and laying of the system cables in a maximum configuration of a central expansion

4.2 Remote I/O Coupler with Triaxial Cable 1) 07 BR 60 R1 for 512 I/O points maximum

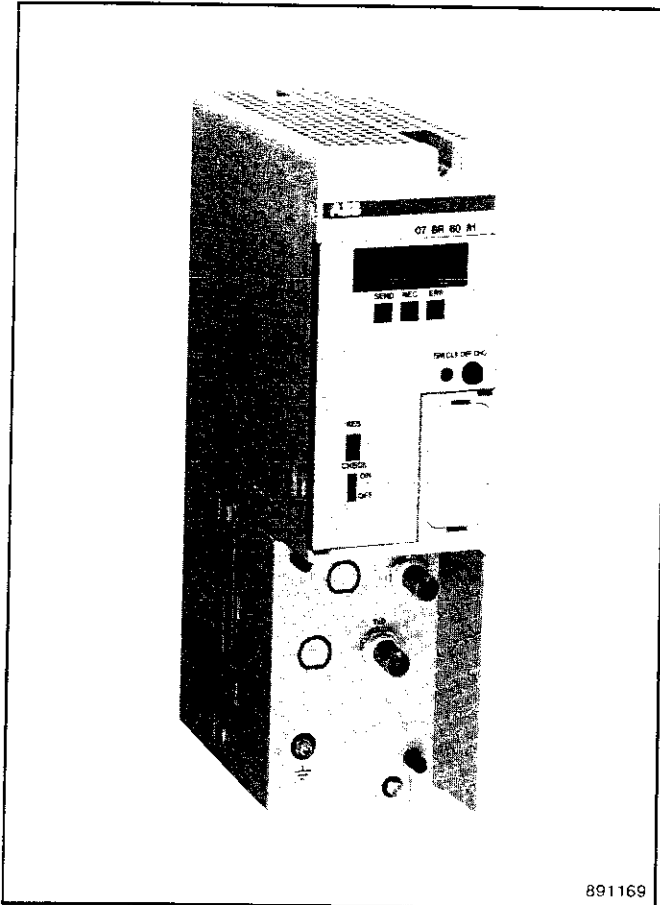

Fig. 4.2.1 Remote I/O coupler 07 BR 60 R1

Characteristics

Using remote I/O coupler 07 BR 60 together with substation coupler 07 BR 61, a remote I/O expansion for the ABB Procontic T200 controller system can be constructed (see Fig. 4.2.2).

This makes it possible to have substations with process-oriented signal cabling. The distance between stations can be up to 500 m (triaxial cable) or up to 2 km (optical fibre ²⁾. The maximum possible overall length per line is 500 m (triaxial cable) or 10 km (optical fibre).

For the construction of a remote I/O expansion configuration at least one 07 BR 60 coupler is required in the basic subrack, together with one 07 BR 61 substation coupler per expansion subrack.

Apart from the basic subracks, the 07 BE 69 R1 expansion subrack can also include up to two 07 BR 60

couplers. In doing so, in the basic subrack more slots are available for modules with high complexity (see Fig. 4.2.3).

The sum of 07 BR 60 R1/R2 couplers in one system (basic subrack plus expansion subrack) is still 4 (for a maximum of 4 lines).

Notice has to be taken, that the programming interface on the 07 BR 61 coupler in the connected substation cannot be used, if the 07 BR 60 coupler belonging to it is located in a 07 BE 69 subrack.

A maximum of 4 remote I/O expansion lines with up to 10 substations each is possible. In this case, in addition to the central expansion, a maximum of 2048 remote binary I/Os is possible with the maximum expansion configuration. The sum of all binary I/Os, including central expansion, is then 3648.

Module Description

The coupler consists of the housing with removable transparent front covering for the display and operating elements, a screw-on connector block with BNC sockets for connecting to the substation coupler and a grounding screw.

A 7-segment display and light-emitting diodes are provided for signalling ready status for operation and errors. Further pushbuttons and switches are provided for testing and operating the module (see Fig. 4.2.4).

Project Planning

The 07 BR 60 couplers required for the construction of a remote I/O expansion configuration are placed in basic subracks (BT) and/or in 07 BE 69 in central expansion. The positioning sequence in the basic subrack and in the 07 BE 69 expansion subrack determines the number of the remote line, i.e. the couplers are given the numbers 1...4 in ascending order, starting with the 1st slot to the right of the central unit (see Fig. 4.2.2 and Fig 4.2.3).

The connections between the couplers are made either with commercially available triaxial cable or with optical fibres ²⁾. Comprehensive diagnostic facilities allow for simple monitoring and fault detection both during commissioning and in operation.

1) double shielded coaxial cable

2) see description of coupler 07 BR 60 R2, starting on page 4.3-1

Central station

I/O slot No. 0 1 2 3 4 5 6 7

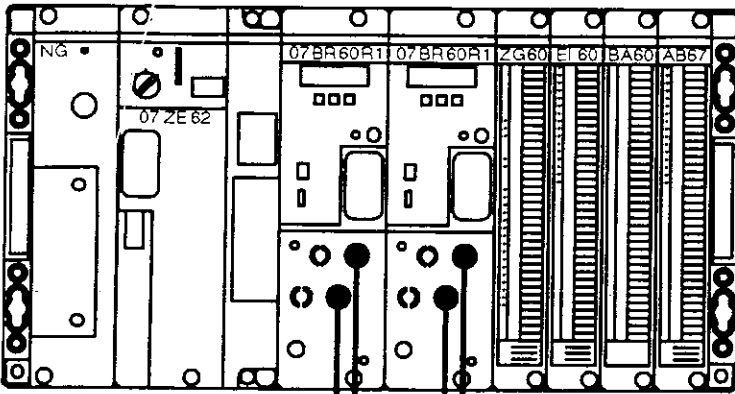

max. expansion possible:

- 4 lines for every central station
- 10 substations for every line
- 512 I/O points for every line
- 500 m max. for the distance between two stations
- 500 m total length of the line (between first and last station)

Connecting cables:
Triax cable

1st line

2nd line

Substation No. 0

I/O slot No. 0 1 2 3

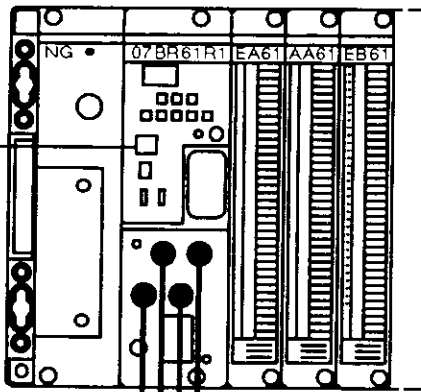

Substation No. 0

I/O slot No. 0 1 2 3

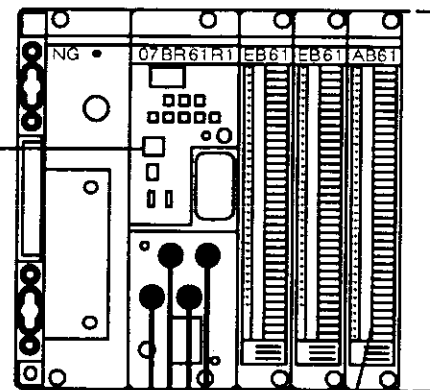

Substation No. 1

I/O slot No. 0 1 2 3 4 5

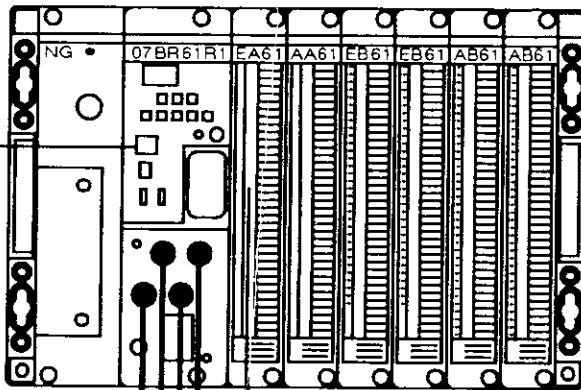

A 2.02,31

Line
Substation
Slot
Channel

VORSICHT!

DIE ANSCHLÜSSE RxD-T UND TxD-T MÜSSEN BEI LETZTER UNTERSTATION VERBUNDEN WERDEN

CAUTION!

CONNECT RxD-T AND TxD-T, WHEN THIS MODULE IS THE END OF REMOTE SYSTEM.

EW 1.10,03

Fig. 4.2.2: 1st configuration example with remote I/O expansion

Central station

I/O slot No. 0 1 2 3 4 5 6 7

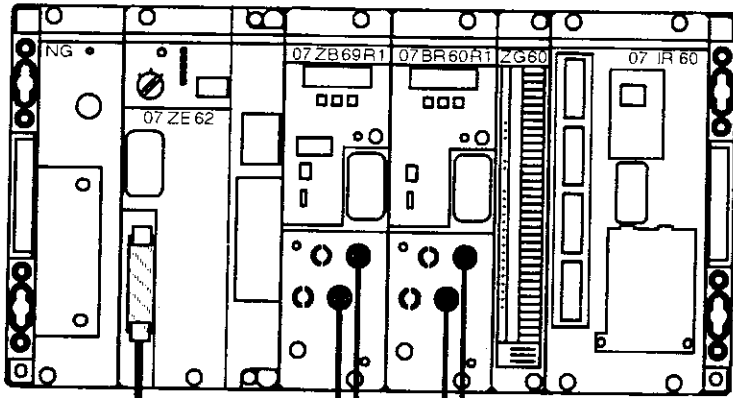

max. expansion possible:

- 4 lines for each system
- 10 substations for each line
- 512 I/O points for each line

ZB 20

I/O slot No. 0 1 2 3

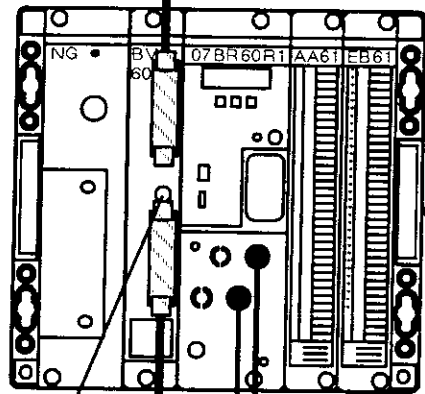

1st line

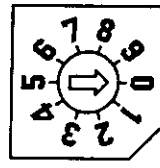

07 BE 69 R1
expansion
subrack

Substation No. 0, line 1

I/O slot No. 0 1 2 3

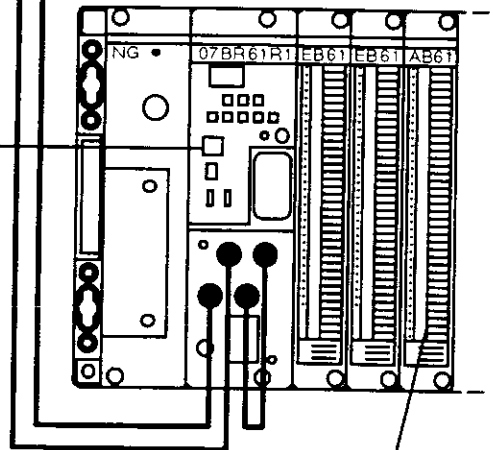

A 1.02,31

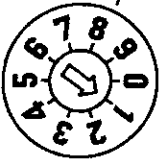

2nd line

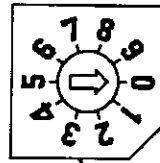

Substation No. 0, line 2

I/O slot No. 0 1 2 3 4 5

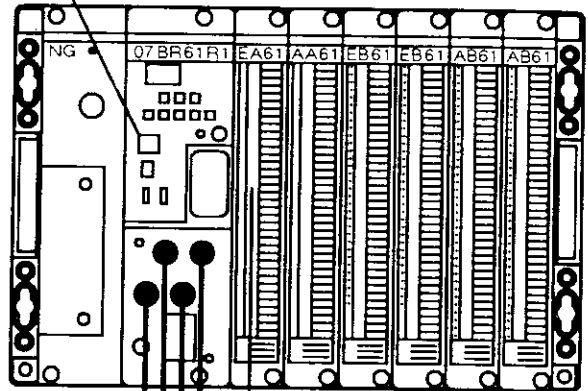
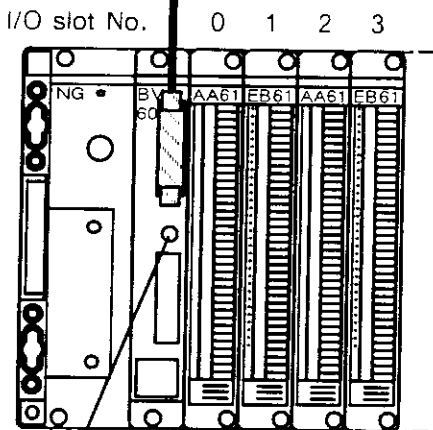

EW 2.00,03

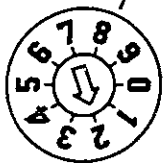

Fig. 4.2.3: Configuration example with the 07 BE 69 R1 expansion subrack for remote I/O couplers

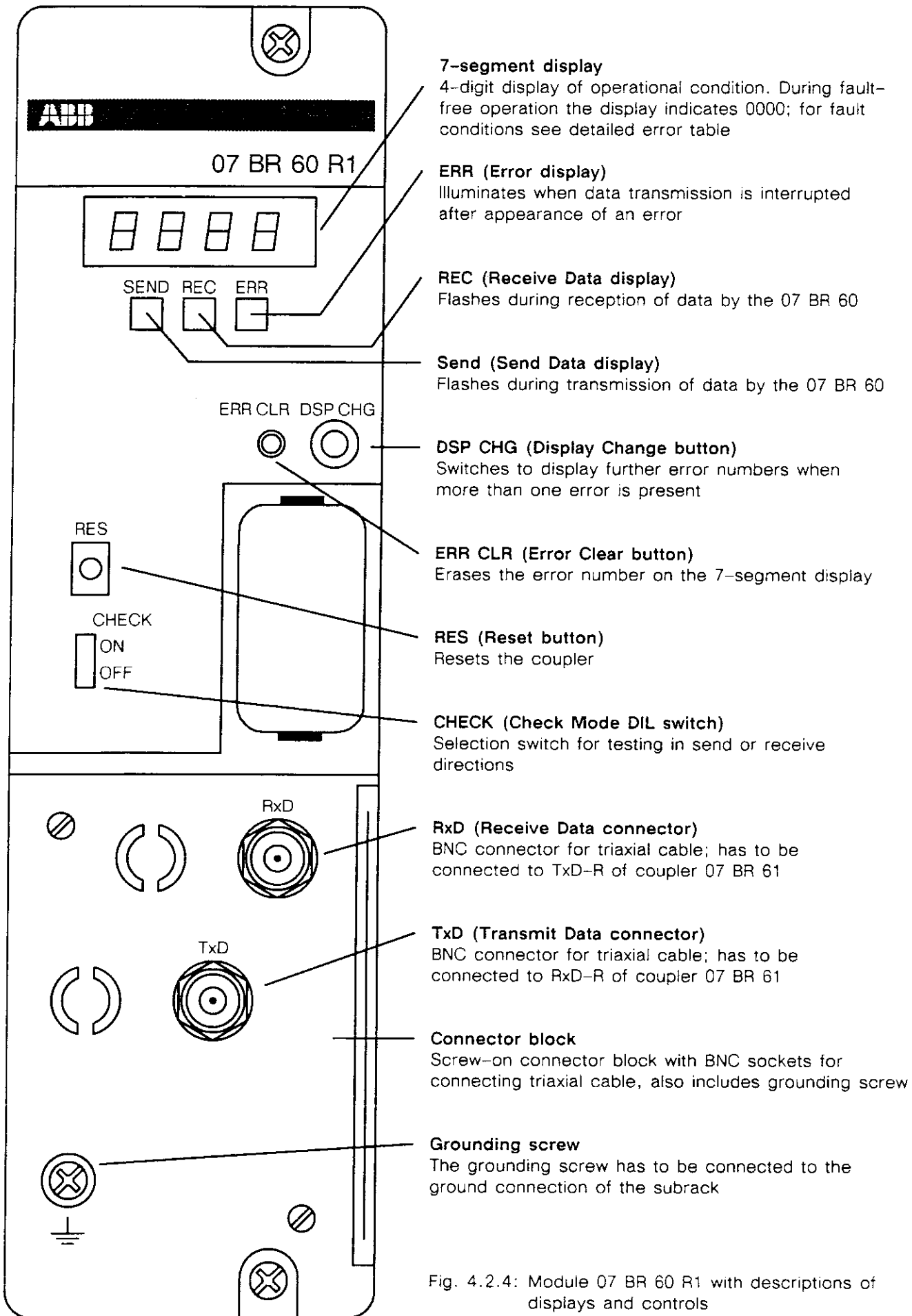

Fig. 4.2.4: Module 07 BR 60 R1 with descriptions of displays and controls

Addressing

For binary I/Os the following applies:

E, A a b c, xx	
	Channel No. 00...31
	Slot No. 0... 8
	Substation No. 0... 9
	Remote I/O line No. 1... 4

Example: A 2.02,31 means;

- Remote I/O line No. 2
- Substation No. 0
- Slot No. 2
- Channel No. 31

See also Fig. 4.2.2

Table 4.2.1: Addressing of binary I/Os

For word-oriented I/Os the following applies:

EW, AW a b c, xx	
	Channel No. 00...07
	Slot No. 0... 8
	Substation No. 0... 9
	Remote I/O line No. 1... 4

Example: EW 1.10,03 means:

- Remote I/O line No. 1
- Substation No. 1
- Slot No. 0
- Channel No. 03

See also Fig. 4.2.2

Table 4.2.2: Addressing of word-oriented I/Os

Connection scheme

Connections to the coupler of the substation are made with triaxial cable. The RxD respectively TxD connectors of the 07 BR 60 coupler have to be connected to the TxD respectively RxD connectors of the 07 BR 61 coupler (see Table 4.2.3 and Fig. 4.2.2).

If the connection between the couplers is broken or if there is a false connection, this is detected by the coupler and the corresponding error number is issued.

The removable connector block of the couplers for substations (07 BR 61) has "bypass structure", i.e. if the supply voltage to a substation is switched off, the remote I/O expansion bus is not interrupted. In such an operational condition the bus connection is bridged

over by integrated relays. The bus need therefore not be disconnected when replacing a defective substation coupling module.

from	to
Central station RxD	substation No. 0 TxD-R
Central station TxD	substation No. 0 RxD-R
Subst. No. 0 RxD-T	substation No. 1 TxD-R
Subst. No. 0 TxD-T	substation No. 1 RxD-R
Subst. No. 1 RxD-T	substation No. 2 TxD-R
Subst. No. 1 TxD-T	substation No. 2 RxD-R
.....
.....
Last subst. RxD-T	last substation TxD-T

Table 4.2.3: Triaxial cable connections

General instructions

In general the voltage supply to the subrack must be switched off before inserting or removing couplers.

Screw-on connector blocks of couplers labeled with R2 (optical fibre connection) must neither be replaced with connector blocks of couplers labeled with R1 (triaxial connection) nor in the reverse case.

When powering up, either all power supplies should be switched on simultaneously or the remote expansions switched on first. Otherwise error message E8 (invalid substation number) will appear on the coupler or error message "43" on the central unit, depending on how the operating mode parameters are set in the menu point "Configuration of system reactions".

When the supply voltage is switched on, i.e. during operation, neither the connector block nor the connecting leads may be removed.

Software Instructions

The operational condition of the modules is monitored by the central unit and can be requested by means of internal flags (see error lists).

Flag:		
M 125,00	Coupler error (0 = normal, 1 = error)	
MW 4096,06	Position of faulty 07 BR 60 module (Table 4.2.5)	
MW 4104,00 - 4109,15	Error information of couplers (Table 4.2.6)	

Table 4.2.4: Flags

For reactions to specific error information it is advisable to use the Online Listings (907 PC 32).

The following table shows the structure of the MW 4096,06 in hex (representation in 907 PC 32 in decimal)

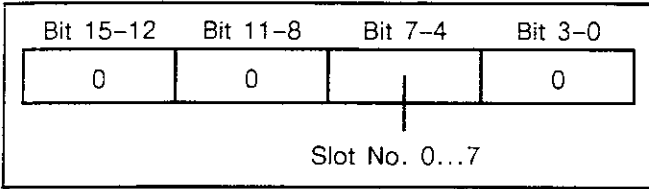

Table 4.2.5: Structure of MW 4096,06 in hex

The slot number (righthand number of the two occupied slots) of the 07 BR 60 coupler of the line in which a fault occurred appears in the MW 4096,06.

The flags MW 4096,06 and M 125,00 signal and store (with battery backup) an error and must be reset by the user in this order.

This can be done by means of a program or with the help of the short lists RESERR*.SIM supplied as files with 907 PC 32.

Configuration of the 07 BR 60 couplers is carried out in the "System configuration" menu by entering the following for the righthand slot of the coupler.

BR60 (if the coupler is located in a basic subrack)

CS61 (if the coupler is located in the 07 BE 69 expansion subrack)

Error information for the 1st line		Bit 15 14 13 12 11 10 9 8 7 6 5 4 3 2 1 0																
Flag	Contents																	
MW 4104,00	Assignment																	1)
01	Position of faulty substation																	2)
02	Coupler 07 BR 60																	3)
03	Coupler substation No. 0																	3)
04	" substation No. 1																	3)
05	" substation No. 2																	3)
06	" substation No. 3																	3)
07	" substation No. 4																	3)
08	" substation No. 5																	3)
09	" substation No. 6																	3)
10	" substation No. 7																	3)
11	" substation No. 8																	3)
12	" substation No. 9																	3)
MW 4105,03	I/O module configuration	0				Subst. No.				slot No.								
04	I/O module	0				Subst. No.				slot No.								
05	max. updating time in ms																	
06	min. updating time in ms																	
07	updating time in ms																	
MW 4104,13 – MW 4105,02 not relevant																		
Error information for 2nd line has the same structure as MW 4105,08...MW 4106,15																		
Error information for 3rd line has the same structure as MW 4107,00...MW 4108,07																		
Error information for 4th line has the same structure as MW 4108,08...MW 4109,15																		
1) A set bit indicates an occupied substation; e.g. MW 4104,00 Bit 7 = 1 means that substation No. 7 in the first line is occupied.																		
2) A set bit indicates which substation is in a faulty state; e.g. MW 4104,01 Bit 2 = 1 means that substation No. 2 is in a faulty state.																		
3) Set bit means an error																		
Bit 0 ... 7	counters for transmission error					Bit 12				I/O error on substation								
Bit 8						Bit 13				system bus error								
Bit 9	faulty configuration					Bit 14				framing error								
Bit 10	faulty connection to substation					Bit 15				time exceeded								
Bit 11	double substation number																	

Table 4.2.6: Error information on couplers

Configuration of the system reactions

The behaviour of the controller when faults of certain classes appear can be set with programmer software 907 PC 32 for the ABB Procontic T200.

For influencing the system reactions within the menu "Configuration of system reactions" parameters 3, 4, and 5 are relevant, if a remote I/O configuration has been projected (see Fig. 4.2.5).

Parameter

```
External start input_____ : E
Cycle monitoring time (msec)_____ : 250

1 -> Error at centr. I/O configuration ; CPU__ : Signalling Stop
2 -> Error at centr. I/O expansion unit; CPU__ : Signalling Stop
3 -> Error on remote I/O coupler ; CPU__ : Signalling Stop
4 -> Error on remote I/O config. ;Transmission: Signalling Stop
5 -> Error at remote substation; Transmission: Signalling Stop
Access permission Debug_____ : Yes No
RUN without output permitted_____ : Yes No
External RUN/STOP-operation permitted_____ : Yes No
```

Fig. 4.2.5: Menu in 907 PC 32 "Configuration of system reactions"

Effects of the individual parameters:

Parameter 3:

Determines whether the central unit stops or not after the appearance of a fault from a remote I/O expansion (coupler fault).

Parameter 4:

Determines whether a faulty configuration of the remote I/O expansion (E7)¹⁾ is to be regarded as a coupler fault. This can be required for step-by-step commissioning of a system without complete hardware extension of a remote I/O expansion configuration.

Parameter 5:

Determines whether a transmission error (E1)¹⁾, transmission timeout error (E2)¹⁾, communication error with the central unit (E5)¹⁾, allocation of a duplicated substation number (E6)¹⁾ or a faulty connection to a substation (E8)¹⁾ is to be regarded as a coupler fault.

If this parameter is set to "Stop", the central unit stops on appearance of one of the above-mentioned faults only if Parameter 3 is also set to "Stop".

¹⁾ Error number, issued by coupler 07 BR 60

System reaction on appearance of an error in a remote I/O line

- the entry of "0" in the parameter column corresponds to a selected "Stop"
- the entry of "1" in the parameter column corresponds to a selected "Signalling".

The error number indicated (E..) is issued on the coupler 07 BR 60 of the faulty line.

The error/status information of the couplers stored in MW 4104,00...MW 4109,15 (see Table 4.2.6 on page 4.2-6) is generally entered.

In the menu "Configuration of system reactions":

Parameter			Operation condition of line with error display E.. on 07 BR 60	Operational condition of the central unit	Error display on the central unit	M125,00	MW 4096,06
3	4	5					
1	0	0	always STOP	RUN	yes	active	active
1	1	0	only after E7 RUN	RUN	no	active	active
			otherwise STOP		yes		
1	0	1	after E1, E2, E5, E6 and E8 RUN	RUN	no	inactive	inactive
			otherwise RUN		yes	active	active
1	1	1	after E1, E2, E5, E6, E7 and E8 RUN	RUN	no	inactive	inactive
			otherwise STOP		yes	active	active
0	0	0	always STOP	STOP	yes	active	active
0	1	0	only after E7 RUN	RUN	no	active	active
			otherwise STOP	STOP	yes	active	active
0	0	1	after E1, E2, E5, E6 and E8 RUN	RUN	no	inactive	inactive
			otherwise STOP	STOP	yes	active	active
0	1	1	after E1, E2, E5, E6, E7 and E8 RUN	RUN	no	inactive	inactive
			otherwise STOP	STOP	yes	active	active

Table 4.2.7: System reaction after occurrence of an error in a remote I/O line

Calculation of updating time

The updating time of a remote I/O expansion line can be calculated approximately from the sum of the following times.

$t_1 =$ basic processing time = 13.3 ms

$t_2 =$ processing time (dependent on number of I/O points occupied)

$t_2 = 0.05 \text{ ms} \times n$ ($n \leq 32$, $n \cong 1$ word with 16 bits)

$t_3 =$ processing time (dependent on number of substations used)

$t_3 = 0.02 \text{ ms} \times m$ ($1 \leq m \leq 10$)

Updating time

$$T = t_1 + t_2 + t_3$$

Example for calculating the updating time:

- Number of words 4
- Number of substations 2

$$T = t_1 + t_2 + t_3$$

$$T = 13.3 \text{ ms} + 0.05 \text{ ms} \times 4 + 0.02 \text{ ms} \times 2$$

$$T = 13.54 \text{ ms}$$

Grounding Scheme

(see Fig. 4.2.6 to 4.2.9)

The outer shield of the triaxial cable is directly electrically grounded on the side of the 07 BR 60 once per line (Fig. 4.2.6). The outer shields must be capacitively grounded (via $0.1 \mu\text{F}$) on the side of the substations (Fig. 4.2.7 and 4.2.8).

If an equal ground potential is guaranteed in a system through the use of special measures, e.g. by the provision of additional equipotential bonding of large cross-sectional area, the substations can also be directly grounded.

The return lead ("inner shield" of the triaxial cable) is directly grounded at the coupler 07 BR 60; at the coupler 07 BR 61 it is capacitively grounded. The grounding screw of the connector blocks must be connected to the grounding screw of the subrack with a short cable ($\geq 4 \text{ mm}^2$).

For effective protection against electromagnetic interference the outer shields must be connected to the cabinet ground with the shortest possible leads.

The protective caps supplied should be placed over the BNC sockets to protect them against electrostatic discharges.

In the switching cabinet the connecting cables for the couplers should not be laid in the same cable ducts as the low-voltage leads.

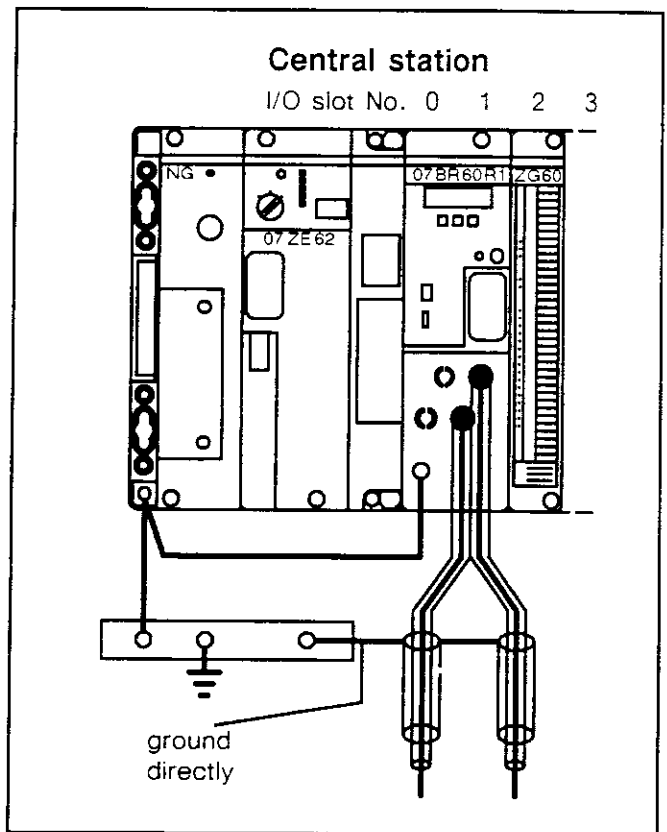

Fig. 4.2.6: Grounding scheme of the 07 BR 60 at basic subrack

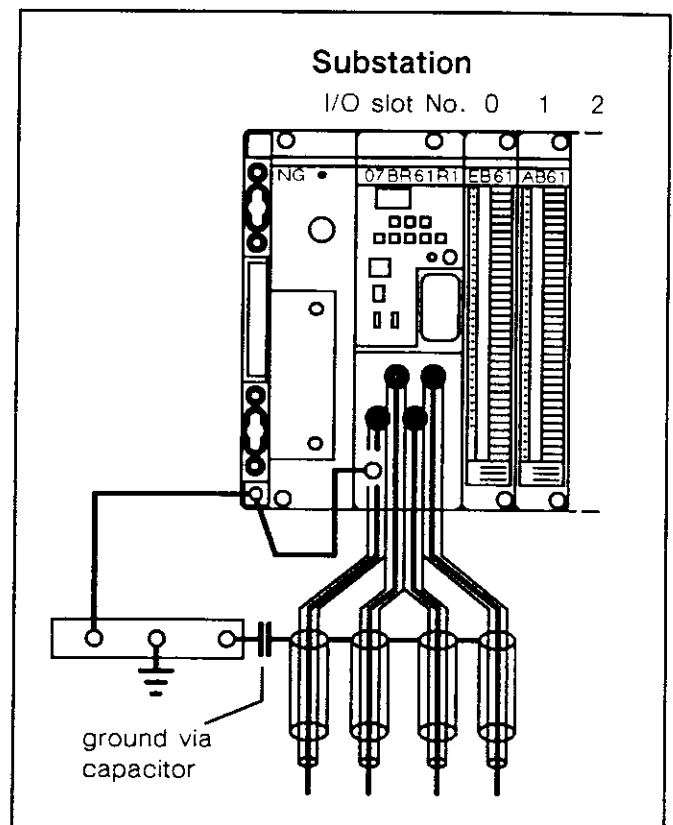

Fig. 4.2.7: Grounding scheme of the 07 BR 61 at substation

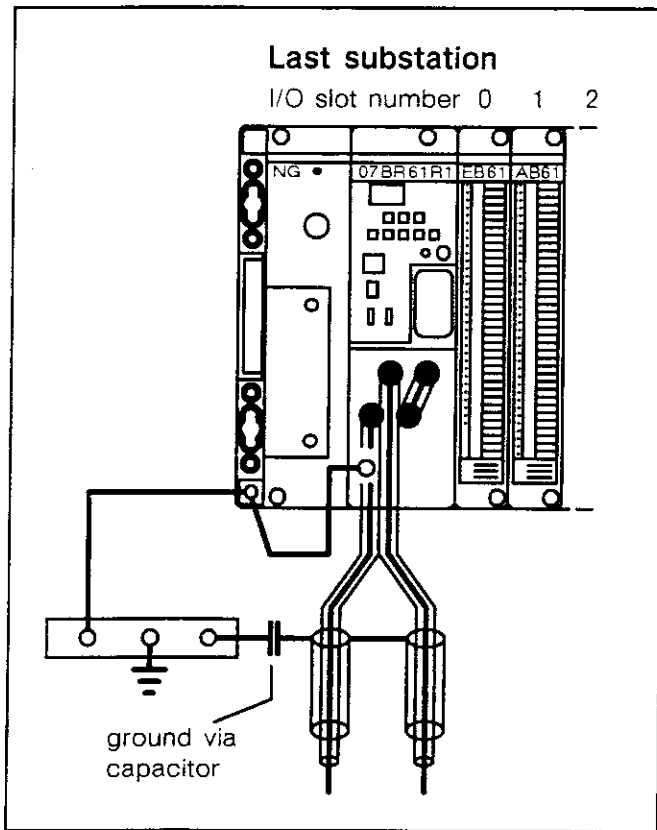

Fig 4.2.8: Grounding scheme of 07 BR 61 in the last substation

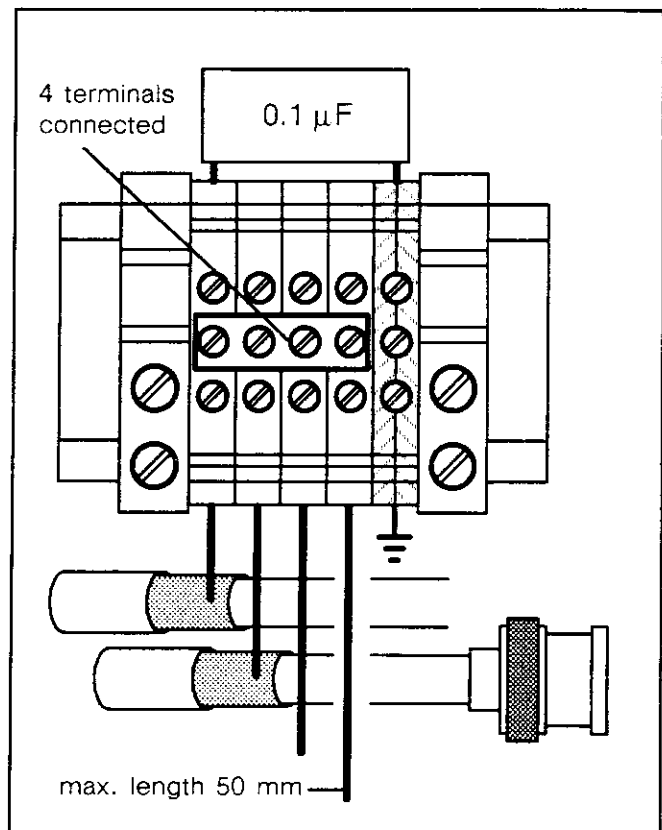

Fig. 4.2.9: Constructional suggestion for grounding the triax outer shields (see also Fig. 4.2.6/4.2.7)

Manual Loop Test

The manual loop test is carried out only when a transmission error has occurred between two couplers. Only one coupler can be tested at a time.

The voltage supply to the subrack must be switched off and the send and receive connectors TxD and RxD connected with the cable supplied.

The DIP switch CHECK must be set to ON. After power-up or after pressing the RES key the loop test is started. The data pattern sent is compared with the data pattern received and displayed on the 7-segment display. An error will be indicated by the ERR LED and by an error number.

Technical Data

Max. number of configurable lines	4 (one 07 BR 60 per line is required)
Max. address range per line	512 I/O points ¹⁾
Max. address range for 4 lines	2048 I/O points
Max. number of substations ²⁾ per line	10
Max. number of I/O slots per substation	9
Transmission speed/Baud rate	1.5 Mbit/s
Transmission mode	halfduplex with serial transmission
Updating time	15 ms for 512 I/O points with 10 substations

¹⁾ 1 bit channel occupies 1 I/O point
1 word channel occupies 16 I/O points

²⁾ 1 substation occupies 1 BE subrack

Self-diagnosis
 Error test
 Distance between two stations
 Overall length of line
 Connecting cable
 Interfaces for programming unit
 Signalling
 Current consumption from internal voltages
 UB1 = 5 V DC
 UB4 = 24 V DC
 Total power dissipation
 Number of required slots
 Configuration identifier in 907 PC 32 when located
 in a basic subrack
 in the 07 BE 69 expansion subrack
 Ability of fitting in subracks
 slot,
 ●-● = plug-in is possible (2 slots)
 Weight
 Order number
 Accessories (supplied):

ROM/RAM system test, watchdog, loop test
 CRC16
 max. 500 m
 max. 500 m
 triaxial cable, impedance 50 Ω
 none
 LED, 7-segment display
 max. 0.6 A
 no current consumption
 max. 3 W
 2 I/O slots
 BR60 (entered for right slot number)
 CS61 (entered for right slot number)

BT	BE-central 07 BE 60..62	BE-central 07 BE 69	BE-remote
NG ZE I/O ●-●	NG BV I/O	NG BV I/O ●-●	NG BV I/O

880 g
 GJV3074375R0001
 2 BNC connecting cables for loop test
 2 protective caps for insulating BNC sockets
 1 15-pin interface plug for loop test of serial
 interface on 07 BR 61 module

Accessories (not supplied):

Component	Designations (remarks)
TRIAX cable	50 Ω Triax cable higher EMC, Type 9222 or Type 9888 Manufacturer: Belden Electronics, Fuggerstr. 2 W-4040 Neuss 1
TRIAX cable	50 Ω Triax cable higher EMC, Type 43V 616/310 Manufacturer: Letronic - Dieter Ley Radeberger Str. 4 W-6800 Mannheim 31
BNC plug	Crimp plug for 9222 or 43V 616/310 Suhner 11BNC-50-3-4c Rosenberger 51 S 101-106 A1
BNC plug	Crimp plug for 9888 Suhner 11BNC-50-7-7c
X-type capacitor 0.1 μF	Manufacturer: RIFA, Sweden Part No. PME 271 M 610 Suppliers: Industrial Electronics GmbH Hauptstr. 71-79, W-6236 Eschborn or EVOX-Rifa GmbH Industriestr. 5, Postfach 1166 W-7707 Engen
Universal terminal, Universal Protective Earth terminal	Suppliers: C. A. Weidmüller GmbH & Co. Postfach 950, W-4930 Detmold or Phönix, Postfach 149 W-4933 Blomberg/Lippe

Error Handling

When an error occurs, information about it is stored in the internal flags M 125,00, MW 4096,06 and MW 4104,00 to MW 4109,15. At the same time an error

code appears on the 7-segment display. The following error table shows the meanings of the error codes:

Table 4.2.8: Error table (07 BR 60)

No	Error name	Error code	ERR LED display	is displayed in case of	is reset when	Remarks
1	Watchdog error	8 8 8 8	● ON	Fault in micro-computer	the reset button (RES) is pressed	
2	ROM/RAM-error	8 8 8 8	● ON	a RAM/ROM error has been detected on switching on the voltage supply	the reset button (RES) is pressed	The RAM/ROM error will lead to a watchdog error
3	Transmission error	E 1 x x	★	a "framing" fault occurs	the reset button (RES) and the error clear button (ERR CLR) are pressed	invalid text length or CRC-error xx: substation number (00....09)
4	Transmission time exceeded	E 2 x x	★	a transmission has not been finished within the preset time	the reset button (RES) and the error clear button (ERR CLR) are pressed	xx: substation number (00....09)
5	Central unit communication error	E 5	★	a fault occurs during communication between the central unit and the 07 BR 60 coupler	the reset button (RES) is pressed; the error clear button (ERR CLR) is pressed, after the fault has been eliminated	
6	Double substation number	E 6 x x	★	the same substation number has been set more than once	the reset button (RES) is pressed; the error clear button (ERR CLR) is pressed, after the fault has been eliminated	xx: substation number (00....09)
7	System configuration error	E 7	★	the I/O allocation information defined by the system configuration does not match the I/O modules set	the reset button (RES) is pressed; the error clear button (ERR CLR) is pressed, after the fault has been eliminated	

No	Error name	Error code	ERR LED display	is displayed in case of	is reset when	Remarks
8	False number of substations	E 8	★	the number of substations connected does not match the number set in the system configuration (because one or more substations are switched off)	the reset button (RES) is pressed; the error clear button (ERR CLR) is pressed, after the fault has been eliminated	
9	Too many I/O points	E 9	● ON	the number of I/O points specified by the user is greater than 512	the reset button (RES) is pressed; the error clear button (ERR CLR) is pressed, after the fault has been eliminated	
10	Inter-ruption	E 3 x x	● ON	the transmission path is interrupted	the reset button (RES) is pressed	xx: substation number (00....09)

Notes:

- The error display can also be reset by switching the voltage supply to the unit off and on again. Hardware faults cannot be eliminated by pressing the reset button.
- "★" in the "ERR LED display" column has the following meaning:
 - Error E7:
The ERR LED lights up if, in the configuration of the system reactions in 907 PC 32, "Error in remote I/O configuration; transmission" was set to STOP.
 - Errors E1 to E6 or E8:
The ERR LED lights up if, in the configuration of the system reactions in 907 PC 32, "Error in remote substation; transmission" was set to STOP and the substation has already been configured.

In all other cases the error indicator does not light up.
- Even if an error occurs which will be eliminated automatically, the error code is displayed and stored until the ERR CLR or the RES button is pressed.
- When several errors are detected at the same time, they are stored in the order in which they occurred. The 7-segment display shows the error code of the latest error to occur. By pressing the DSP CHG button the next respective error number can be displayed (cyclical switching).
- If the supply voltage of a substation is decreasing, error E8 occurs.

The central unit stops, if, in the configuration of the system reactions in 907 PC 32, "Error in remote substation; transmission" was set to STOP and (!) if "Error at remote I/O coupler" was set to STOP. Eliminate the fault, switch off the voltage supply to the central station, then switch on the supply voltage to the substations and the central station again.

Table 4.2.9: Loop test result (07 BR 60)

No	Error name	Error code	ERR LED display	is displayed in case of	is reset when	Remarks
1	Normal loop test	X X	⊗ OFF	---	the reset button (RES) is pressed	xx: loop test data
2	Loop test aborted	X X	● ON	an error appeared during the loop test	the reset button (RES) is pressed	xx: test data at time of abort

4.3 Remote I/O Coupler with Optical Fibre 07 BR 60 R2 for 512 I/O points maximum

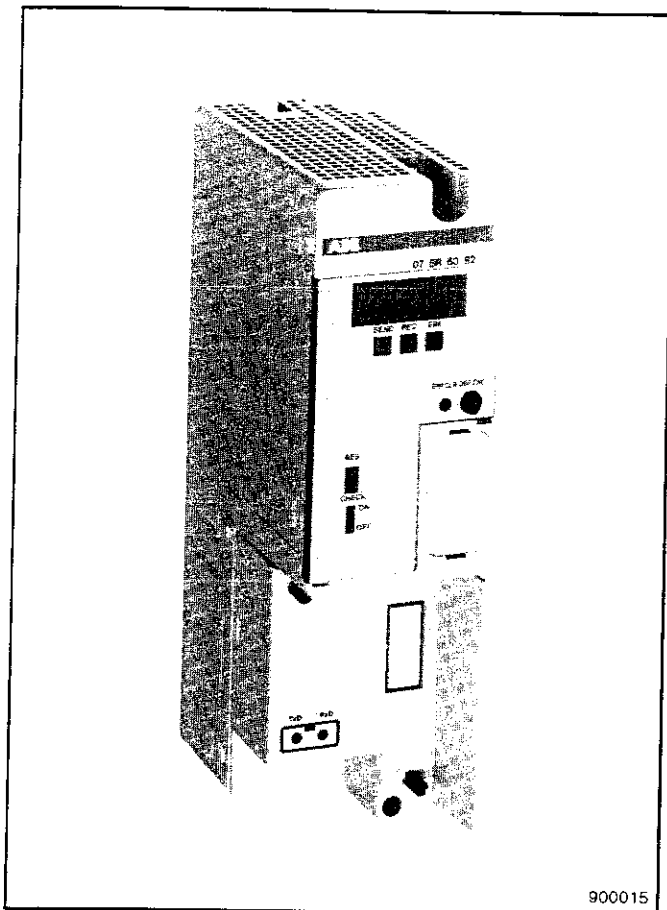

Fig. 4.3.1: Remote I/O coupler 07 BR 60 R2

Characteristics

Using remote I/O coupler 07 BR 60 together with substation coupler 07 BR 61, a remote I/O expansion for the ABB Procontic T200 controller system can be constructed (see Fig. 4.3.2).

This makes it possible to have substations with process-oriented signal cabling. The distance between stations can be up to 2 km (optical fibre). The maximum possible overall length per line is 10 km (optical fibre).

For the construction of a remote I/O expansion configuration at least one 07 BR 60 coupler is required in the basic subrack, together with one 07 BR 61 substation coupler per expansion subrack.

Apart from the basic subracks, the 07 BE 69 R1 expansion subrack can also include up to two 07 BR 60

couplers. In doing so, in the basic subrack more slots are available for modules with high complexity (see Fig. 4.3.3).

The sum of 07 BR 60 R1/R2 couplers in one system (basic subrack plus expansion subrack) is still 4 (for a maximum of 4 lines).

Notice has to be taken, that the programming interface on the 07 BR 61 coupler in the connected substation cannot be used, if the 07 BR 60 coupler belonging to it is located in a 07 BE 69 subrack.

A maximum of 4 remote I/O expansion lines with up to 10 substations each is possible. In this case, in addition to the central expansion, a maximum of 2048 remote binary I/Os is possible with the maximum expansion configuration. The sum of all binary I/Os, including central expansion, is then 3648.

Module Description

The coupler consists of the housing with removable transparent front covering for the display and operating elements, a screw-on connector block with fibre-optical sockets for connection to the substation coupler.

A 7-segment display and light-emitting diodes are provided for signalling ready status for operation and errors. Further pushbuttons and switches are provided for testing and operating the module (see Fig. 4.3.4).

Project Planning

The 07 BR 60 couplers required for the construction of a remote I/O expansion configuration are placed in basic subracks (BT) and/or in 07 BE 69 in central expansion. The positioning sequence in the basic subrack and in the 07 BE 69 expansion subrack determines the number of the remote line, i.e. the couplers are given the numbers 1...4 in ascending order, starting with the 1st slot to the right of the central unit (see Fig. 4.3.2 and Fig 4.3.3).

The connections between the couplers are made with optical fibres ¹⁾.

Comprehensive diagnostic facilities allow for simple monitoring and fault detection both during commissioning and in operation.

¹⁾ see specifications for optical fibres

Central Station

I/O slot No. 0 1 2 3 4 5 6 7

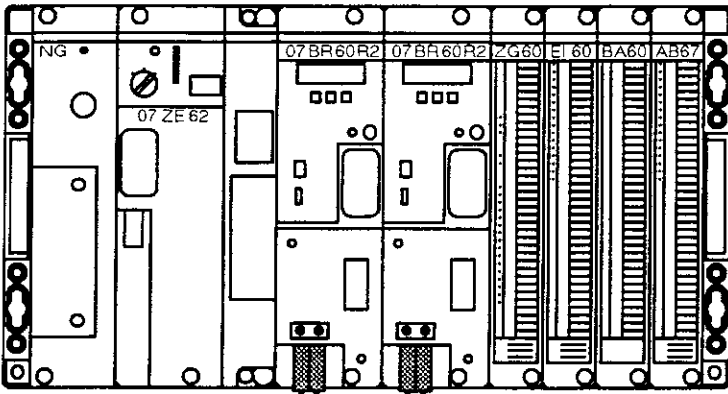

max. expansion possible:

- 4 lines for every central station
- 10 substations for every line
- 512 I/O points for every line
- 2 km max. for the distance between two stations
- 10 km total length of the line (between first and last station)

Connecting cables:
fibre-optic cable

1st line

2nd line

Substation No. 0

I/O slot No. 0 1 2 3

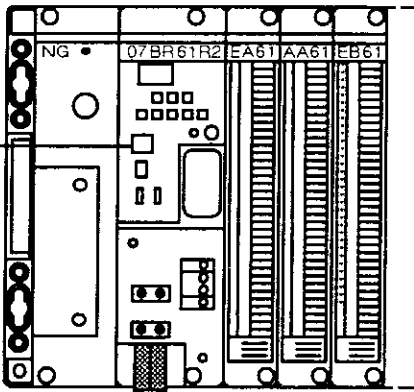

Substation No. 0

I/O slot No. 0 1 2 3

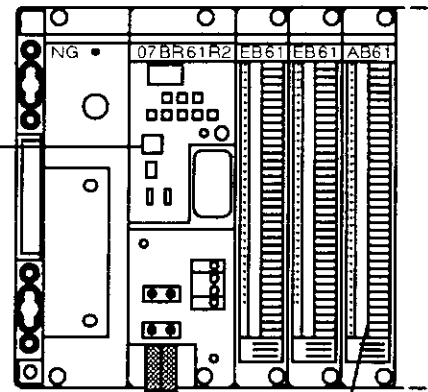

lines
at the rear

Substation No. 1

I/O slot No. 0 1 2 3 4 5

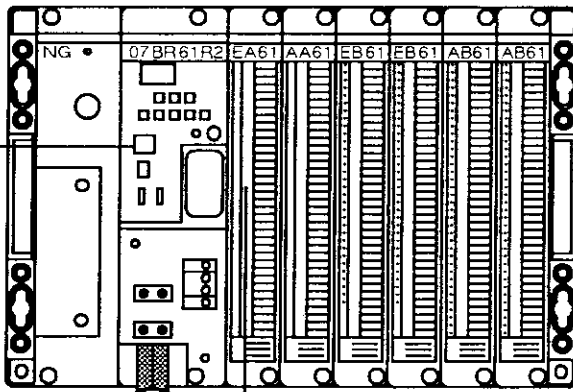

A 2.02,31

Line
Substation
Slot
Channel

VORSICHT!

DIE ANSCHLÜSSE RxD-T UND TxD-T MÜSSEN BEI LETZTER UNTERSTATION VERBUNDEN WERDEN

CAUTION!

CONNECT RxD-T AND TxD-T, WHEN THIS MODULE IS THE END OF REMOTE SYSTEM.

EW 1.10,03

Fig. 4.3.2: 1st configuration example with remote I/O expansion

Central station

I/O slot No. 0 1 2 3 4 5 6 7

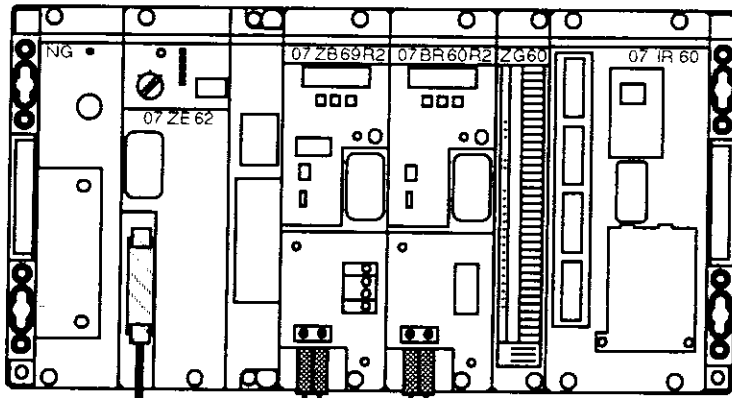

max. expansion possible:

- 4 lines for each system
- 10 substations for each line
- 512 I/O points for each line

ZB 20

Substation No. 0, line 1

I/O slot No. 0 1 2 3

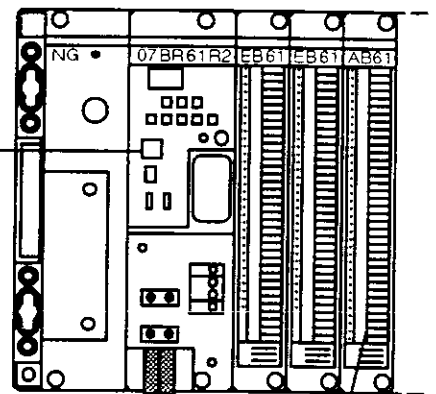

1st line

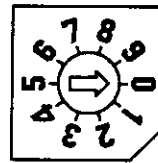

07 BE 69 R1
expansion
subrack

A 1.02,31

Substation No. 0, line 2

I/O slot No. 0 1 2 3 4 5

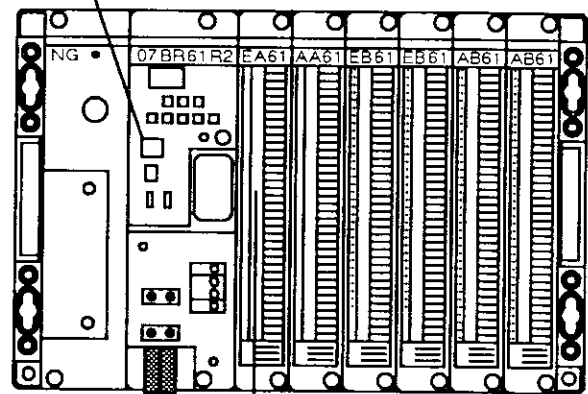

2nd line

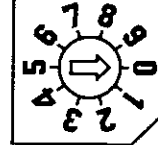

EW 2.00,03

I/O slot No. 0 1 2 3

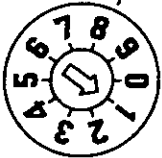
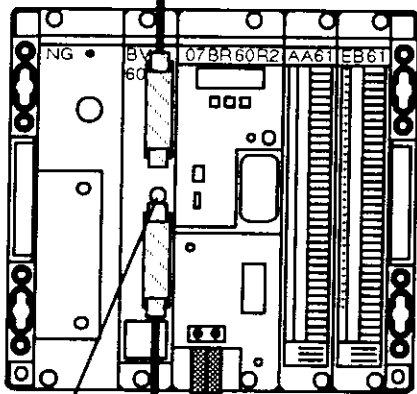

I/O slot No. 0 1 2 3

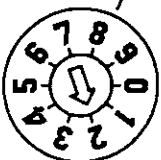
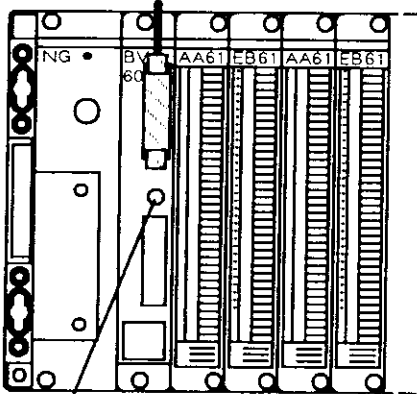
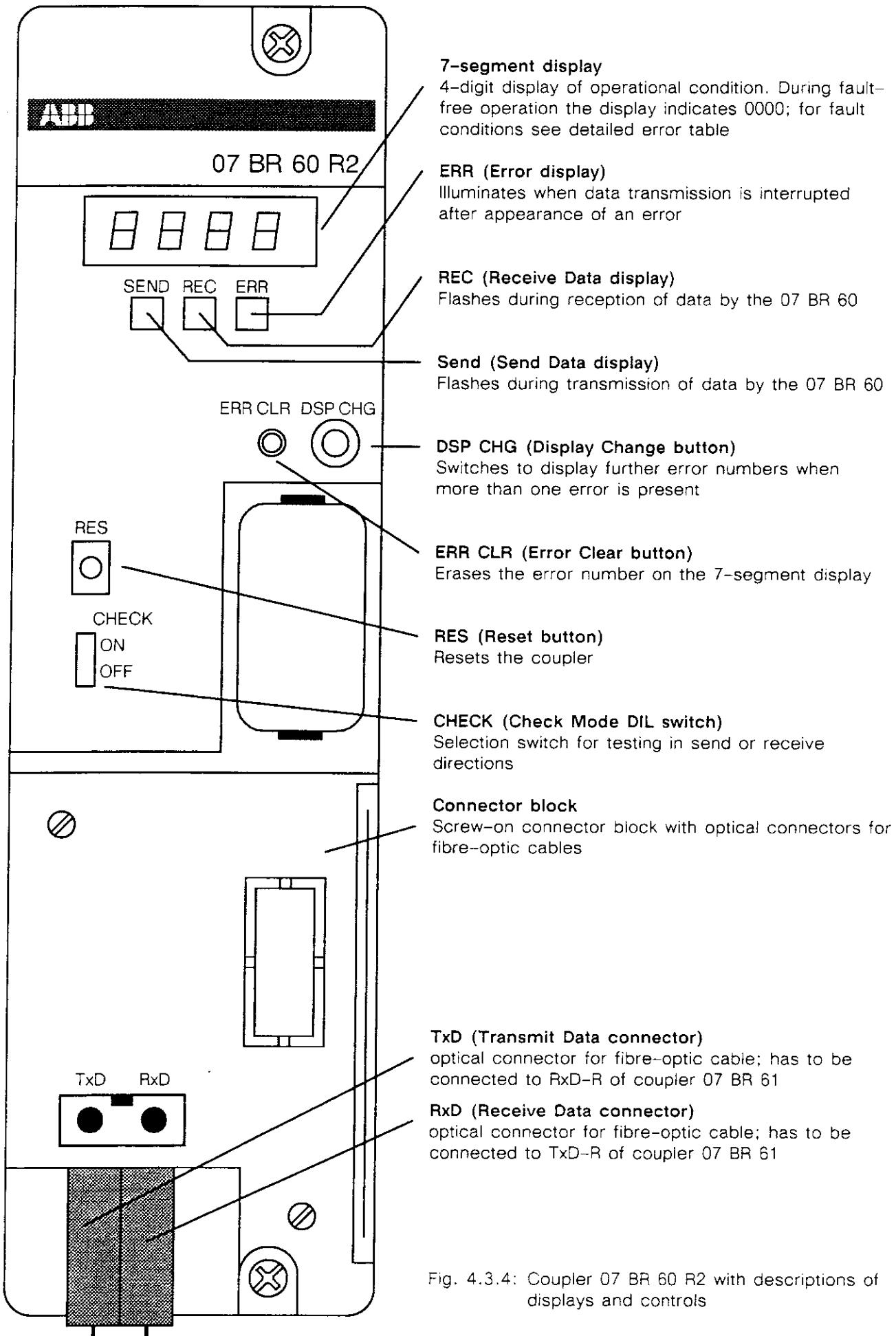

Fig. 4.3.3: Configuration example with the 07 BE 69 R1 expansion subrack for remote I/O couplers



7-segment display
4-digit display of operational condition. During fault-free operation the display indicates 0000; for fault conditions see detailed error table

ERR (Error display)
Illuminates when data transmission is interrupted after appearance of an error

REC (Receive Data display)
Flashes during reception of data by the 07 BR 60

Send (Send Data display)
Flashes during transmission of data by the 07 BR 60

DSP CHG (Display Change button)
Switches to display further error numbers when more than one error is present

ERR CLR (Error Clear button)
Erases the error number on the 7-segment display

RES (Reset button)
Resets the coupler

CHECK (Check Mode DIL switch)
Selection switch for testing in send or receive directions

Connector block
Screw-on connector block with optical connectors for fibre-optic cables

TxD (Transmit Data connector)
optical connector for fibre-optic cable; has to be connected to RxD-R of coupler 07 BR 61

RxD (Receive Data connector)
optical connector for fibre-optic cable; has to be connected to TxD-R of coupler 07 BR 61

Fig. 4.3.4: Coupler 07 BR 60 R2 with descriptions of displays and controls

Addressing

For binary I/Os the following applies:

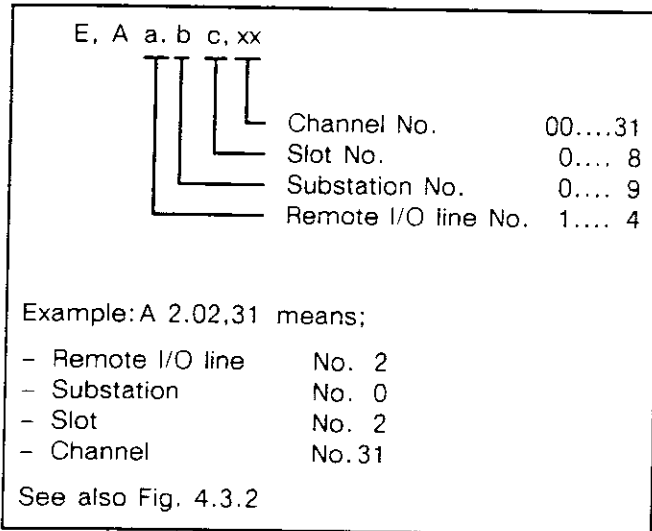

Table 4.3.1: Addressing of binary I/Os

For word-oriented I/Os the following applies:

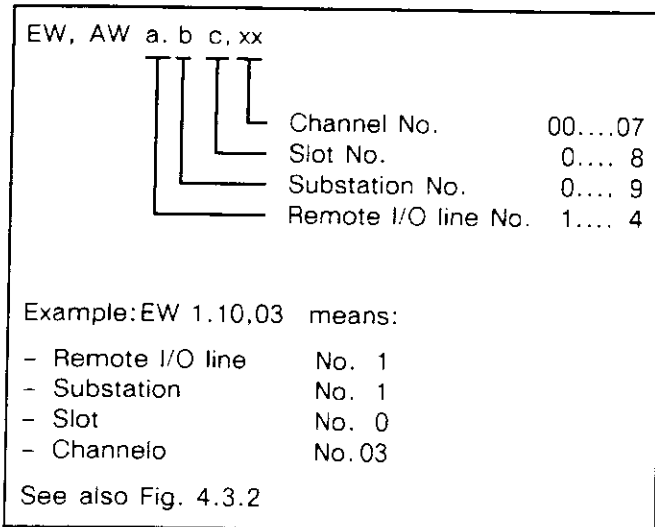

Table 4.3.2: Addressing of word-oriented I/Os

Connection scheme

Connections to the coupler of the substation are made with optical fibres. The RxD respectively TxD connectors of the 07 BR 60 coupler have to be connected to the TxD respectively RxD connectors of the 07 BR 61 coupler (see Table 4.3.3 and Fig. 4.3.2).

If the connection between the couplers is broken or if there is a false connection, this is detected by the coupler and the corresponding error number is issued.

The removable connector block of the couplers for substations (07 BR 61) has "bypass structure", if the external 5 V DC supply voltage is connected. If the supply voltage to a substation is switched off, the remote I/O expansion bus is not interrupted. In such an opera-

tional condition the bus connection is bridged over. The bus need therefore not be disconnected when replacing a defective substation coupling module.

from		to	
Central station RxD		substation No. 0	TxD-R
Central station TxD		substation No. 0	RxD-R
Subst. No. 0 RxD-T		substation No. 1	TxD-R
Subst. No. 0 TxD-T		substation No. 1	RxD-R
Subst. No. 1 RxD-T		substation No. 2	TxD-R
Subst. No. 1 TxD-T		substation No. 2	RxD-R
.....		
.....		
Last subst. RxD-T		last substation	TxD-T

Table 4.3.3: Optical fibre connections

General instructions

In general the voltage supply to the subrack must be switched off before inserting or removing couplers.

Screw-on connector blocks of couplers labeled with R2 (optical fibre connection) must neither be replaced with connector blocks of couplers labeled with R1 (triaxial connection) nor in the reverse case.

When powering up, either all power supplies should be switched on simultaneously or the remote expansions switched on first. Otherwise error message E8 (invalid substation number) will appear on the coupler or error message "43" on the central unit, depending on how the operating mode parameters are set in the menu point "Configuration of system reactions".

When the supply voltage is switched on, i.e. during operation, neither the connector block nor the connecting leads may be removed.

Software Instructions

The operational condition of the modules is monitored by the central unit and can be requested by means of internal flags (see error lists).

Flag:		
M 125,00		Coupler error (0 = normal, 1 = error)
MW 4096,06		Position of faulty 07 BR 60 module (Table 4.3.5)
MW 4104,00 - 4109,15		Error information of couplers (Table 4.3.6)

Table 4.3.4: Flags

For reactions to specific error information it is advisable to use the Online Listings (907 PC 32).

The following table shows the structure of the MW 4096,06 in hex (representation in 907 PC 32 in decimal)

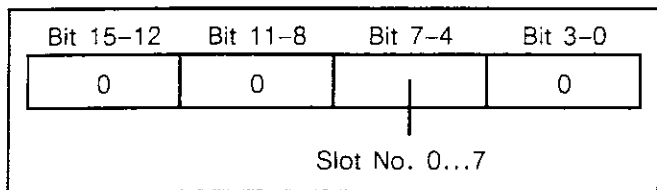

Table 4.3.5: Structure of MW 4096,06 in hex

The slot number (righthand number of the two occupied slots) of the 07 BR 60 coupler of the line in which a fault occurred appears in the MW 4096,06.

The flags MW 4096,06 and M 125,00 signal and store (with battery backup) an error and must be reset by the user in this order.

This can be done by means of a program or with the help of the short lists RESERR*.SIM supplied as files with 907 PC 32.

Configuration of the 07 BR 60 couplers is carried out in the "System configuration" menu by entering the following for the righthand slot of the coupler.

BR60 (if the coupler is located in a basic subrack)

CS61 (if the coupler is located in the 07 BE 69 expansion subrack)

Error information for the 1st line		Bit 15 14 13 12 11 10 9 8 7 6 5 4 3 2 1 0																
Flag	Contents																	
MW 4104,00	Assignment																	1)
01	Position of faulty substation																	2)
02	Coupler 07 BR 60																	3)
03	Coupler substation No. 0																	3)
04	" substation No. 1																	3)
05	" substation No. 2																	3)
06	" substation No. 3																	3)
07	" substation No. 4																	3)
08	" substation No. 5																	3)
09	" substation No. 6																	3)
10	" substation No. 7																	3)
11	" substation No. 8																	3)
12	" substation No. 9																	3)
MW 4105,03	I/O module configuration	0				Subst. No.				slot No.								
04	I/O module	0				Subst. No.				slot No.								
05	max. updating time in ms																	
06	min. updating time in ms																	
07	updating time in ms																	

MW 4104,13 - MW 4105,02 not relevant

Error information for 2nd line has the same structure as MW 4105,08...MW 4106,15

Error information for 3rd line has the same structure as MW 4107,00...MW 4108,07

Error information for 4th line has the same structure as MW 4108,08...MW 4109,15

- 1) A set bit indicates an occupied substation; e.g. MW 4104,00
Bit 7 = 1 means that substation No. 7 in the first line is occupied.
- 2) A set bit indicates which substation is in a faulty state; e.g. MW 4104,01
Bit 2 = 1 means that substation No. 2 is in a faulty state.
- 3) Set bit means an error

Bit 0 ... 7 counters for transmission error	Bit 12 I/O error on substation
Bit 8	Bit 13 system bus error
Bit 9 faulty configuration	Bit 14 framing error
Bit 10 faulty connection to substation	Bit 15 time exceeded
Bit 11 double substation number	

Table 4.3.6: Error information on couplers

Configuration of the system reactions

The behaviour of the controller when faults of certain classes appear can be set with programmer software 907 PC 32 for the ABB Procontic T200.

For influencing the system reactions within the menu "Configuration of system reactions" parameters 3, 4, and 5 are relevant, if a remote I/O configuration has been projected (see Fig. 4.3.5).

Parameter

External start input_____:	E
Cycle monitoring time (msec)_____:	250
1 → Error at centr. I/O configuration ; CPU__:	Signalling Stop
2 → Error at centr. I/O expansion unit; CPU__:	Signalling Stop
3 → Error on remote I/O coupler ; CPU__:	Signalling Stop
4 → Error on remote I/O config. ;Transmission:	Signalling Stop
5 → Error at remote substation; Transmission:	Signalling Stop
Access permission Debug_____:	Yes No
RUN without output permitted_____:	Yes No
External RUN/STOP-operation permitted_____:	Yes No

Fig. 4.3.5: Menu in 907 PC 32 'Configuration of System Reactions'

Effects of the individual parameters:

Parameter 3:

Determines whether the central unit stops or not after the appearance of a fault from a remote I/O expansion (coupler fault).

Parameter 4:

Determines whether a faulty configuration of the remote I/O expansion (E7)¹⁾ is to be regarded as a coupler fault. This can be required for step-by-step commissioning of a system without complete hardware extension of a remote I/O expansion configuration.

Parameter 5:

Determines whether a transmission error (E1)¹⁾, transmission timeout error (E2)¹⁾, communication error with the central unit (E5)¹⁾, allocation of a duplicated substation number (E6)¹⁾ or a faulty connection to a substation (E8)¹⁾ is to be regarded as a coupler fault. If this parameter is set to "Stop", the central unit stops on appearance of one of the above-mentioned faults only if Parameter 3 is also set to "Stop".

¹⁾ Error number, issued by coupler 07 BR 60

System reaction on appearance of an error in a remote I/O line

The error number indicated (E..) is issued on the coupler 07 BR 60 of the faulty line.

In the menu "Configuration of system reactions":

- the entry of "0" in the parameter column corresponds to a selected "Stop"
- the entry of "1" in the parameter column corresponds to a selected "Signalling".

The error/status information of the couplers stored in MW 4104,00...MW 4109,15 (see Table 4.3.6 on page 4.3-6) is generally entered.

Parameter			Operation condition of line with error display E.. on 07 BR 60	Operational condition of the central unit	Error display on the central unit	M125,00	MW 4096,06
3	4	5					
1	0	0	always STOP	RUN	yes	active	active
1	1	0	only after E7 RUN	RUN	no	active	active
			otherwise STOP		yes		
1	0	1	after E1, E2, E5, E6 and E8 RUN	RUN	no	inactive	inactive
			otherwise RUN		yes	active	active
1	1	1	after E1, E2, E5, E6, E7 and E8 RUN	RUN	no	inactive	inactive
			otherwise STOP		yes	active	active
0	0	0	always STOP	STOP	yes	active	active
0	1	0	only after E7 RUN	RUN	no	active	active
			otherwise STOP	STOP	yes	active	active
0	0	1	after E1, E2, E5, E6 and E8 RUN	RUN	no	inactive	inactive
			otherwise STOP	STOP	yes	active	active
0	1	1	after E1, E2, E5, E6, E7 and E8 RUN	RUN	no	inactive	inactive
			otherwise STOP	STOP	yes	active	active

Table 4.3.7: System reaction after occurrence of an error in a remote I/O line

Calculation of updating time

The updating time of a remote I/O expansion line can be calculated approximately from the sum of the following times.

$$t_1 = \text{basic processing time} = 13.3 \text{ ms}$$

$$t_2 = \text{processing time (dependent on number of I/O points occupied)}$$

$$t_2 = 0.05 \text{ ms} \times n \quad (n \leq 32, n \hat{=} 1 \text{ word with 16 bits})$$

$$t_3 = \text{processing time (dependent on number of substations used)}$$

$$t_3 = 0.02 \text{ ms} \times m \quad (1 \leq m \leq 10)$$

Updating time

$$T = t_1 + t_2 + t_3$$

Example for calculating the updating time:

- Number of words 4
- Number of substations 2

$$T = t_1 + t_2 + t_3$$

$$T = 13.3 \text{ ms} + 0.05 \text{ ms} \times 4 + 0.02 \text{ ms} \times 2$$

$$T = 13.54 \text{ ms}$$

Manual Loop Test

The manual loop test is carried out only when a transmission error has occurred between two couplers. Only one coupler can be tested at a time.

The voltage supply to the subrack must be switched off and the send and receive connectors TxD and RxD connected with the connecting cable supplied.

The DIP switch CHECK must be set to ON. After power-up or after pressing the RES key the loop test is started. The data pattern sent is compared with the data pattern received and displayed on the 7-segment display. An error will be indicated by the ERR LED and by an error number.

Technical Data

Max. number of configurable lines	4 (one 07 BR 60 per line is required)
Max. address range per line	512 I/O points ¹⁾
Max. address range for 4 lines	2048 I/O points
Max. number of substations ²⁾ per line	10
Max. number of I/O slots per substation	9
Transmission speed/Baud rate	1.5 Mbit/s
Transmission mode	halfduplex with serial transmission
Updating time	15 ms for 512 I/O points with 10 substations
Self-diagnosis	ROM/RAM system test, watchdog, loop test
Error test	CRC16
Distance between two stations	max. 2 km
Overall length of line	max. 10 km
Connecting cable	fibre-optic cable
Wave length	840 nm
Launched power (peak dBm)	- 21 dBm
Type of fibre (core/cladding diameter)	50/125 μ m
Attenuation of fibre	3.0 dB/km @ 840 nm
Max. permissible system loss of assembled cable	16 dB
Typical insertion loss of connector	\leq 1 dB

¹⁾ 1 bit channel occupies 1 I/O point
1 word channel occupies 16 I/O points

²⁾ 1 substation occupies 1 BE subrack

Typical insertion loss of connection ≤ 2 dB
 Typical insertion loss of splice ≤ 0.2 dB
 Interfaces for programming unit none
 Signalling LED, 7-segment display

Current consumption from internal voltages
 UB1 = 5 V DC max. 0.9 A
 UB4 = 24 V DC no current consumption

Total power dissipation max. 3 W

Number of required slots 2 I/O slots

Configuration identifier in 907 PC 32 when located
 in a basic subrack BR60 (entered for right slot number)
 in the 07 BE 69 expansion subrack CS61 (entered for right slot number)

Ability of fitting in subracks

slot,
 ●--● = plug-in is possible (2 slots)

BT	BE-central 07 BE 60..62	BE-central 07 BE 69	BE- remote
NG ZE I/O ●--●	NG BV I/O	NG BV I/O ●--●	NG BV I/O

Weight 880 g
 Order number GJV3074375R0002

Technical data for external 5 V DC power supply:

Voltage 5 V DC $\pm 5\%$

Output load capability 700 mA

Residual ripple max. 50 mV_{ss}

For each optical coupler (07 BR 61 R2) a separate 5 V DC power supply module should be used.

Accessories (supplied):
 2 connection cables for loop test
 1 15-pin interface plug for loop test of serial
 interface on 07 BR 61 module

Accessories (not supplied):

Component	Designations (remarks)	
ABB SIGMA [®] tronic b Converter R508.1 (24 V DC/5 V DC)	ABB order No.	GH R508 0001 R1
Premounted Simplex optical-fibre indoor cable with connectors at both ends, length = 10 m	Type:	07 LK 60
	ABB order No.	GJV3 0755 01 R1
Premounted Simplex optical-fibre indoor cable with connectors at one end, for splice connections, length = 10 m	Type:	07 LK 61
	ABB order No.	GJV3 0755 02 R1
Coupling device for cable-to-cable connection and test and measurement purposes	Type:	07 LV 60
	ABB order No.	GJV3 0755 03 R1

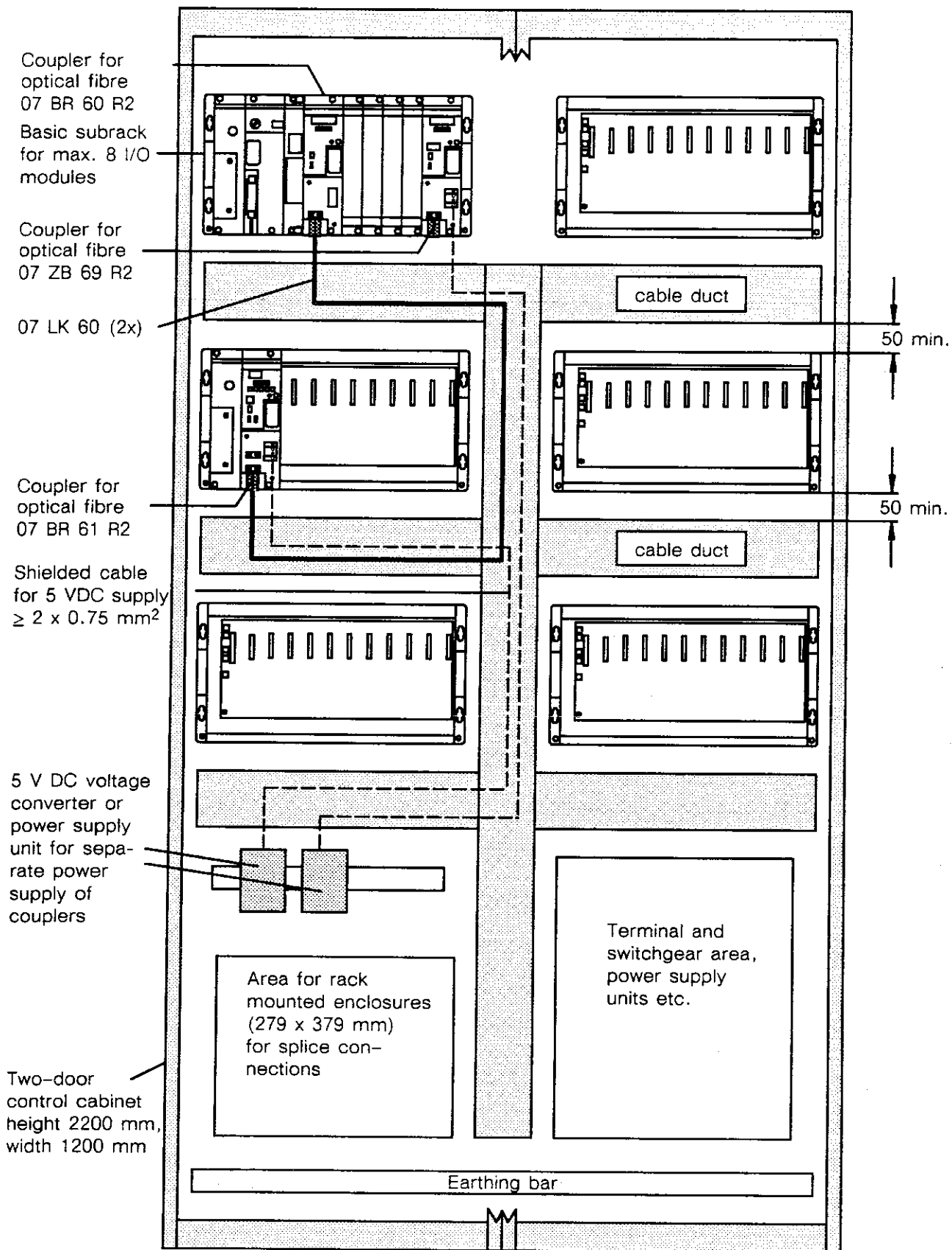

When laying fibre-optic cables care has to be taken that the bending radius will not fall below the minimum permissible.

Fig. 4.3.6: Typical rack mounting and wiring management of optical-fibre modules

Fibre-Optic Cable Installation

Laying fibre-optic cables is more ambitious than laying copper cables. It has to be carried out by highly skilled workers, who are familiar with the mechanical properties of the cable and the practical aspects of a correct installation. The following points should be observed.

1. There is a great variety of fibre-optic cables, which can be buried, strung aerially or placed in trays and conduits. Depending on the way of installation there are many tools and special equipments to be used.
2. Minimum bend radius and maximum tensile rating are the critical specifications for any fibre-optic cable installation, both during the installing process and during the installed life of the cable. Careful planning of the installation layout will ensure that the specifications are not exceeded. In addition, the installation process itself must be carefully planned.

An increasing tensile load as well as a decreasing bend radius cause a reversible attenuation increase, an irreversible attenuation increase, and, finally, cracking of the fibre.

2. Cables must be protected against damage during and after installation. Splice connections and cable ends (with their connectors) must be protected against humidity. Buried cables must be protected against frost, water seepage, attack by burrowing and gnawing animals, and mechanical stresses that could result from earth movements. Armored cables specially designed for burial are available. Aerial cables must be able to withstand the forces

of high winds, storms, ice loading, and so forth. Self-supporting aerial cables are available.

3. Since standard fibre-optic cables are electrically nonconductive, they may be placed near high-voltage cables without shielding.
4. The primary consideration in selecting a route for fibre-optic cable through trays and ducts is to avoid potential cutting edges and sharp bends. Areas where particular caution must be taken are corners and exit slots in sides of trays. If a fibre-optic cable is in the same tray or duct with very large, heavy electrical cables, care must be taken to avoid placing excessive crushing forces on the fibre-optic cable, particularly where the heavy cables cross over the fibre-optic cable.
5. Long vertical runs within trays and ducts as well as runs outside them should be clamped at intermediate points. Clamping forces should be no more than necessary to prevent damage and crushing forces on the jacket of the optical cable.
6. During pulling of the cable, pulling force should be constantly monitored by a mechanical gauge. If any increase in pulling force is noticed, pulling should immediately cease, and the cause of the increase should be determined. Pull tension can be monitored by a running line tensiometer or a dynamometer and pulley arrangement. If a power winch is used to assist the pulling, a power capstan with adjustable slip clutch is recommended. The clutch, set for the maximum loading, will disengage if the set load is reached. If necessary for difficult pulls, the cable should be continuously lubricated during pulling-in.

Error Handling

When an error occurs, information about it is stored in the internal flags M 125,00, MW 4096,06 and MW 4104,00 to MW 4109,15. At the same time an error

code appears on the 7-segment display. The following error table shows the meanings of the error codes:

Table 4.3.8: Error table (07 BR 60)

No	Error name	Error code	ERR LED display	is displayed in case of	is reset when	Remarks
1	Watchdog error	8 8 8 8	● ON	Fault in micro-computer	the reset button (RES) is pressed	
2	ROM/RAM-error	8 8 8 8	● ON	a RAM/ROM error has been detected on switching on the voltage supply	the reset button (RES) is pressed	The RAM/ROM error will lead to a watchdog error
3	Transmission error	E 1 x x	★	a "framing" fault occurs	the reset button (RES) and the error clear button (ERR CLR) are pressed	invalid text length or CRC-error xx: substation number (00....09)
4	Transmission time exceeded	E 2 x x	★	a transmission has not been finished within the preset time	the reset button (RES) and the error clear button (ERR CLR) are pressed	xx: substation number (00....09)
5	Central unit communication error	E 5	★	a fault occurs during communication between the central unit and the 07 BR 60 coupler	the reset button (RES) is pressed; the error clear button (ERR CLR) is pressed, after the fault has been eliminated	
6	Double substation number	E 6 x x	★	the same substation number has been set more than once	the reset button (RES) is pressed; the error clear button (ERR CLR) is pressed, after the fault has been eliminated	xx: substation number (00....09)
7	System configuration error	E 7	★	the I/O allocation information defined by the system configuration does not match the I/O modules set	the reset button (RES) is pressed; the error clear button (ERR CLR) is pressed, after the fault has been eliminated	

No	Error name	Error code	ERR LED display	is displayed in case of	is reset when	Remarks
8	False number of substations	E 8	★	the number of substations connected does not match the number set in the system configuration (because one or more substations are switched off)	the reset button (RES) is pressed; the error clear button (ERR CLR) is pressed, after the fault has been eliminated	
9	Too many I/O points	E 9	● ON	the number of I/O points specified by the user is greater than 512	the reset button (RES) is pressed; the error clear button (ERR CLR) is pressed, after the fault has been eliminated	
10	Inter-ruption	E 3 x x	● ON	the transmission path is interrupted	the reset button (RES) is pressed	xx: substation number (00....09)

Notes:

- The error display can also be reset by switching the voltage supply to the unit off and on again. Hardware faults cannot be eliminated by pressing the reset button.
- "★" in the "ERR LED display" column has the following meaning:
 - Error E7:
The ERR LED lights up if, in the configuration of the system reactions in 907 PC 32, "Error in remote I/O configuration; transmission" was set to STOP.
 - Errors E1 to E6 or E8:
The ERR LED lights up if, in the configuration of the system reactions in 907 PC 32, "Error in remote substation; transmission" was set to STOP and the substation has already been configured.

In all other cases the error indicator does not light up.
- Even if an error occurs which will be eliminated automatically, the error code is displayed and stored until the ERR CLR or the RES button is pressed.
- When several errors are detected at the same time, they are stored in the order in which they occurred. The 7-segment display shows the error code of the latest error to occur. By pressing the DSP CHG button the next respective error number can be displayed (cyclical switching).
- If the supply voltage of a substation is decreasing, error E8 occurs.

The central unit stops, if, in the configuration of the system reactions in 907 PC 32, "Error in remote substation; transmission" was set to STOP and (!) if "Error at remote I/O coupler" was set to STOP. Eliminate the fault, switch off the voltage supply to the central station, then switch on the supply voltage to the substations and the central station again.

Table 4.3.9: Loop test result (07 BR 60)

No	Error name	Error code	ERR LED display	is displayed in case of	is reset when	Remarks
1	Normal loop test	x x	⊗ OFF	---	the reset button (RES) is pressed	xx: loop test data
2	Loop test aborted	x x	● ON	an error appeared during the loop test	the reset button (RES) is pressed	xx: test data at time of abort

4.4 Remote I/O Coupler with Triaxial Cable 1) 07 BR 61 R1 for substation

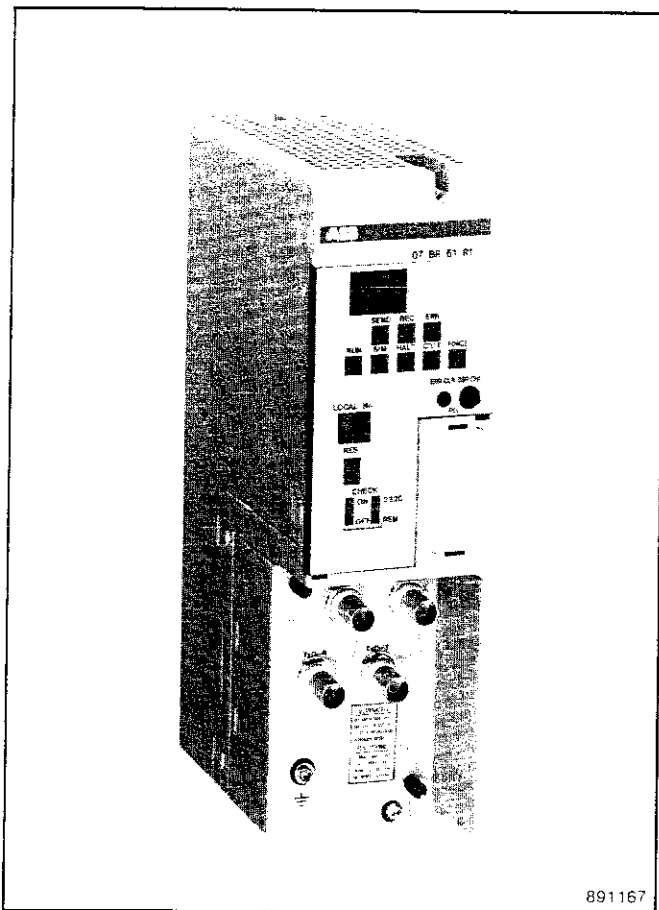

Fig. 4.4.1: Remote I/O coupler 07 BR 61 R1

Characteristics

Using remote I/O coupler 07 BR 61 for substations together with coupler 07 BR 60, a remote I/O expansion for the ABB Procontic T200 controller system can be constructed (see Fig. 4.4.2).

This makes it possible to have substations with process-oriented signal cabling. The distance between stations can be up to 500 m (triaxial cable) or up to 2 km (optical fibre ²⁾). The maximum possible overall length per line is 500 m (triaxial cable) or 10 km (optical fibre).

For the construction of a remote I/O expansion configuration at least one 07 BR 60 coupler is required in the

basic subrack, together with one 07 BR 61 substation coupler per expansion subrack.

A maximum of 4 remote I/O expansion lines with up to 10 substations each is possible. In this case, in addition to the central expansion, a maximum of 2048 remote binary I/Os is possible with the maximum configuration. The sum of all binary I/Os, including central expansion, is then 3648.

Module Description

The coupler consists of the housing with removable transparent front covering for the display and operating elements, a screw-on connector block with BNC sockets for connecting to the couplers 07 BR 60 or 07 BR 61 respectively and a grounding screw.

A 7-segment display and light-emitting diodes are provided for signalling ready status for operation and errors. Further pushbuttons and switches are provided for testing and operating the module (see Fig. 4.4.3).

In order to connect the 907 PC 32 programming and test system the coupler is provided with an RS-232-C interface, which has the standard values of the central units' interfaces (pin assignment, function, parameters).

Project Planning

The 07 BR 61 couplers for the construction of a remote I/O expansion configuration are placed only in the expansion subracks (BE). They occupy the BV slot and additionally one I/O slot per subrack. Therefore the maximum number of slots for I/O modules is reduced by one slot. The first slot to the right of the coupler 07 BR 61 is given slot number 0.

The connections between the couplers are made either with commercially available triaxial cable or with optical fibres ²⁾.

Comprehensive diagnostic facilities allow for simple monitoring and fault detection both during commissioning and in operation.

1) double shielded coaxial cable

2) see description of coupler 07 BR 61 R2, starting on page 4.5-1

Central station

I/O slot No. 0 1 2 3 4 5 6 7

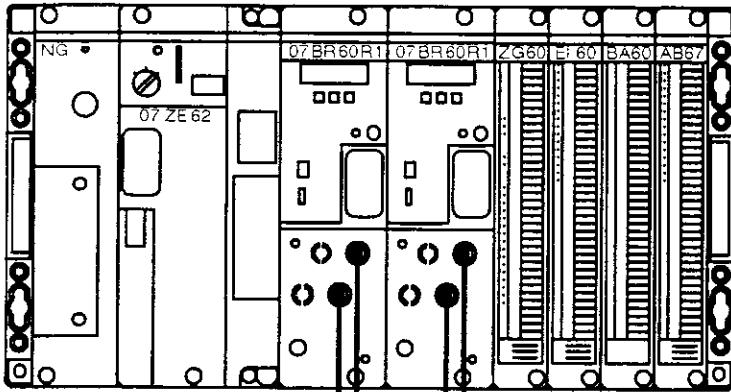

max. expansion possible:

- 4 lines for every central station
- 10 substations for every line
- 512 I/O points for every line
- 500 m max. for the distance between two stations
- 500 m total length of the line (between first and last station)

Connecting cables:
Triax cable

1st line

2nd line

Substation No. 0

I/O slot No. 0 1 2 3

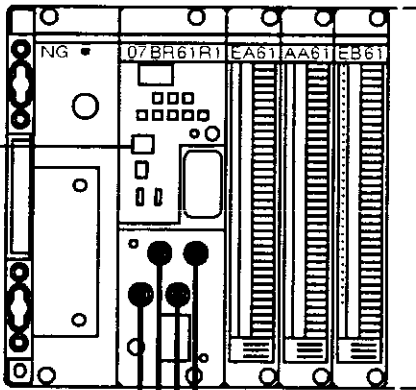

Substation No. 0

I/O slot No. 0 1 2 3

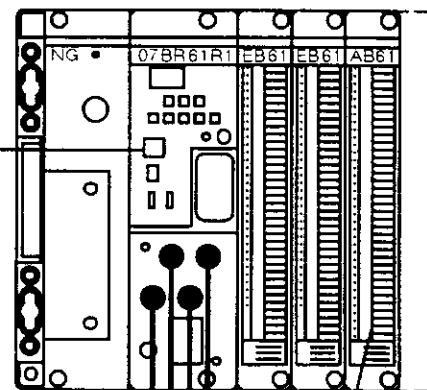

Substation No. 1

I/O slot No. 0 1 2 3 4 5

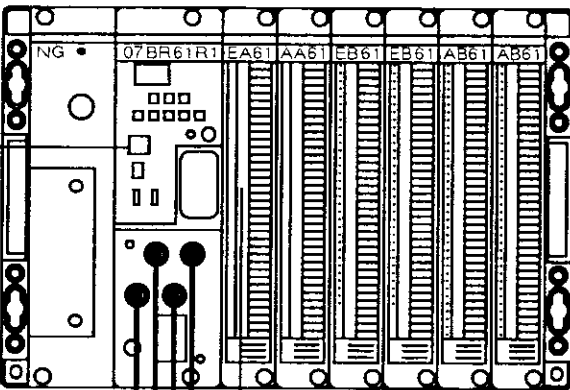

A 2.02,31

Line
Substation
Slot
Channel

VORSICHT!

DIE ANSCHLÜSSE RxD-T UND TxD-T MÜSSEN BEI LETZTER UNTERSTATION VERBUNDEN WERDEN

CAUTION!

CONNECT RxD-T AND TxD-T, WHEN THIS MODULE IS THE END OF REMOTE SYSTEM.

EW 1.10,03

Fig. 4.4.2: Configuration with remote expansion

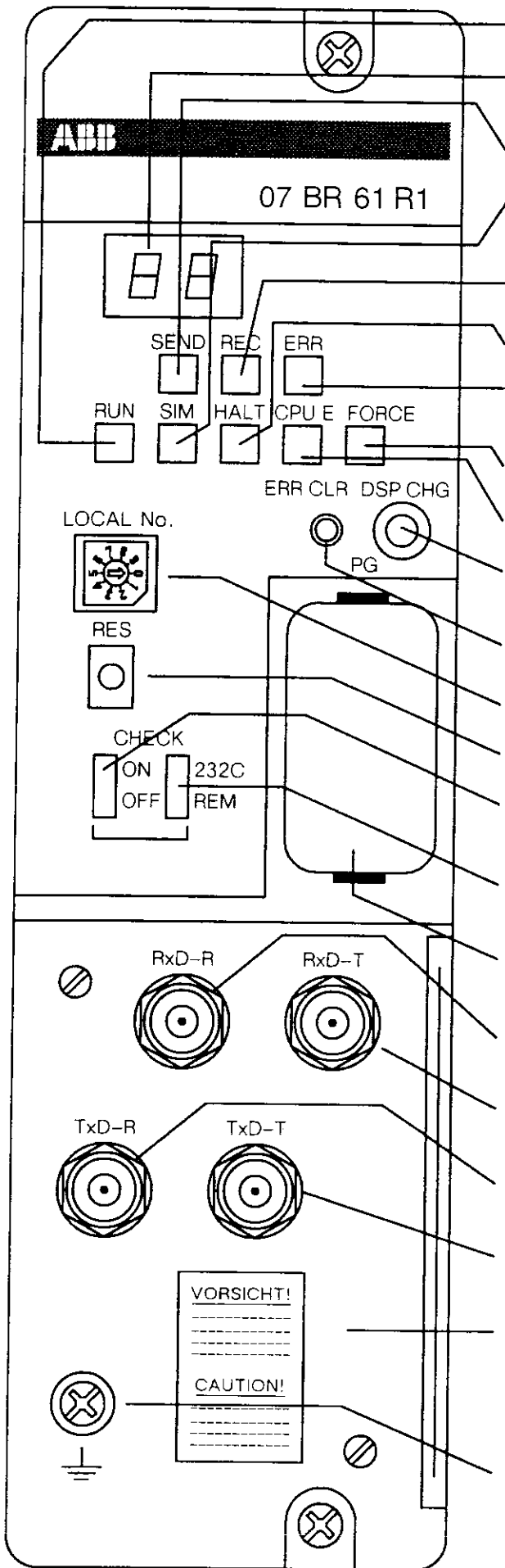

- RUN display**
Illuminates during PLC operation
- 7-segment display**
2-digit display of operational condition. During fault-free operation 00; for fault conditions see detailed error table
- SEND (Send Data display)**
Flashes during data transmission of 07 BR 61
- SIM display**
Illuminates during passive operation, i.e. during operation without active output
- REC (Receive Data display)**
Flashes during reception of data of the 07 BR 61
- HALT display**
Illuminates when the program processing is stopped
- ERR (Error display)**
Illuminates when the data transmission is interrupted after occurrence of an error
- FORCE display**
Illuminates when "Forcing" is carried out via 907 PC 321
- CPU E (CPU Error display)**
Illuminates when errors are present at the central unit
- DSP CHG (Display Change button)**
Switches to display further error numbers when more than one error is present
- ERR CLR (Error Clear button)**
Erases the error number on the 7-segment display
- LOCAL No.**
Selection switch for setting the substation No. (0...9)
- RES (Reset button)**
Resets the coupler
- CHECK (Check Mode DIL switch)**
Selection switch for testing in send or receive directions the serial interface as well as the triaxial connection
- 232C/REM**
Selection switch for setting the test mode (serial interface or triaxial connection)
- PG**
15 poles plug (female) for the connection of a programming unit or an external computer
- RxD-R (Receive Data connector, receive path)**
BNC connector for triaxial cable; has to be connected to TxD-R of coupler 07 BR 61 or TxD of coupler 07 BR 60
- RxD-T (Receive Data connector, send path)**
BNC connector for triaxial cable; has to be connected to TxD-R of coupler 07 BR 61 of a further substation
- TxD-R (Transmit Data connector, receive path)**
BNC connector for triaxial cable; has to be connected to RxD-R of coupler 07 BR 61 or RxD of coupler 07 BR 60
- TxD-T (Transmit Data connector, send path)**
BNC connector for triaxial cable; has to be connected to RxD-R of coupler 07 BR 61 of a further substation
- Connector block**
Screw-on connector block with BNC sockets for connecting triaxial cable, also includes grounding screw. The connectors TxD-T and RxD-T of the last substation have to be connected by the connecting cable supplied.
- Grounding screw**
The grounding screw has to be connected to the ground connection of the subrack by the shortest possible way

Fig. 4.4.3 Coupler 07 BR 61 R1 with descriptions of displays and operating elements

Addressing

For binary I/Os the following applies:

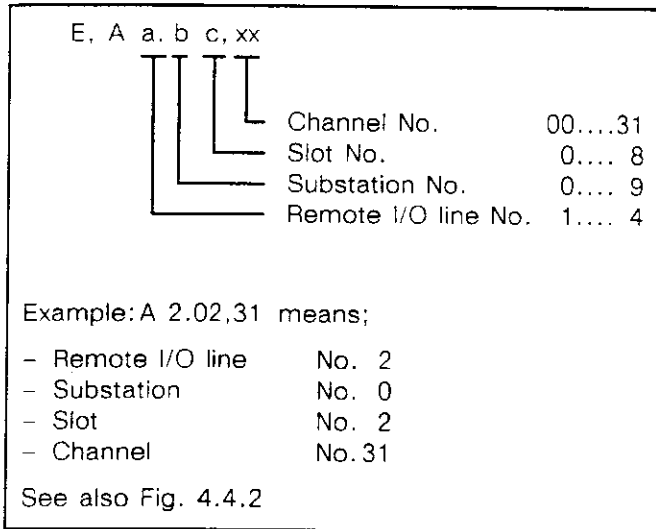

Table 4.4.1: Addressing of binary I/Os

For word-oriented I/Os the following applies:

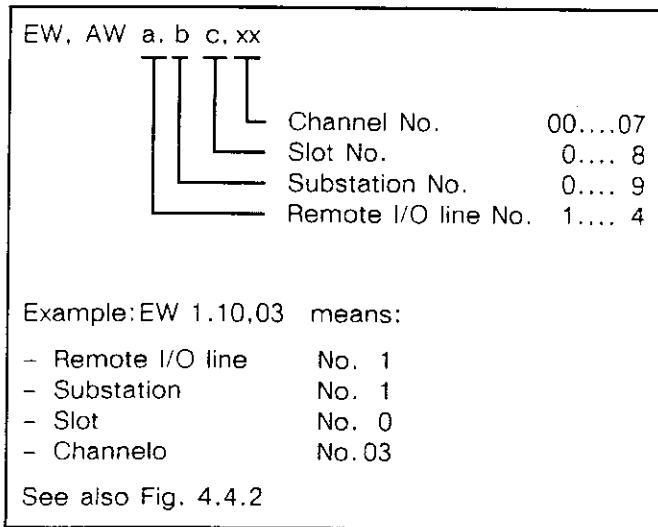

Table 4.4.2: Addressing of word-oriented I/Os

Connection scheme

Connections to further couplers are made with triaxial cable. The RxD-T or TxD-T connectors of the 07 BR 61 coupler have to be connected to the TxD-R or RxD-R connectors of the next 07 BR 61 coupler respectively (see Table 4.4.3 and Fig. 4.4.2).

If the connection between the couplers is broken or if there is a false connection, this is detected by the coupler and the corresponding error number is issued.

The removable connector block has "bypass structure", i.e. if the supply voltage to a substation is switched off, the remote I/O expansion bus is not interrupted. In such an operational condition the bus con-

nection is bridged over by integrated relays. The bus need therefore not be disconnected when replacing a defective substation coupler.

from	to
Central station RxD	substation No. 0 TxD-R
Central station TxD	substation No. 0 RxD-R
Subst. No. 0 RxD-T	substation No. 1 TxD-R
Subst. No. 0 TxD-T	substation No. 1 RxD-R
Subst. No. 1 RxD-T	substation No. 2 TxD-R
Subst. No. 1 TxD-T	substation No. 2 RxD-R
.....
.....
Last subst. RxD-T	last substation TxD-T

Table 4.4.3: Triaxial cable connections

General instructions

In general the voltage supply to the subrack must be switched off before inserting or removing couplers.

Screw-on connector blocks of couplers labeled with R2 (optical fibre connection) must neither be replaced with connector blocks of couplers labeled with R1 (triaxial connection) nor in the reverse case.

When powering up, either all power supplies should be switched on simultaneously or the remote expansions switched on first. Otherwise error message E8 (invalid substation number) will appear on coupler 07 BR 60 or error message "43" on the central unit, depending on how the operating mode parameters are set in the menu point "Configuration of system reactions".

When the supply voltage is switched on, i.e. during operation, neither the connector block nor the connecting leads may be removed.

Software Instructions

The operational condition of the units is monitored by the central unit and can be requested by means of internal flags (see error lists).

Flag:		
M 125,00	Coupler error (0 = normal, 1 = error)	
MW 4096,06	Position of faulty 07 BR 60 module (Table 4.4.5)	
MW 4104,00 - 4109,15	Error information of couplers (Table 4.4.6)	

Table 4.4.4: Flags

For reactions to specific error information it is advisable to use the Online Listings (907 PC 32).

The following table shows the structure of the MW 4096,06 in hex (representation in 907 PC 32 in decimal)

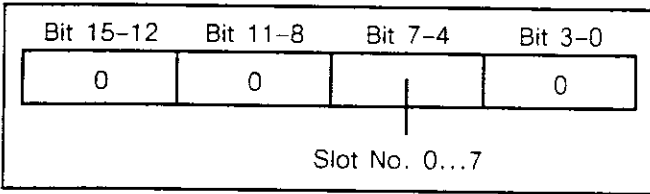

Table 4.4.5: Structure of MW 4096,06 in hex

The slot number (righthand number of the two occupied slots) of the coupler of the line in which a fault occurred appears in the MW 4096,06.

The flags MW 4096,06 and M 125,00 signal and store (with battery backup) an error and must be reset by the user in this order.

This can be done by means of a program or with the help of the short lists RESERR*.SIM supplied as files with 907 PC 32.

With the 07 BR 61 coupler no entry is necessary in the menu "System configuration".

The behaviour of the central unit in case of an error can be set in the 907 PC 32 menu "Configuration of system reactions" (see "Configuration of system reactions" in the description of the unit 07 BR 60).

Error information for the 1st line		Bit	15	14	13	12	11	10	9	8	7	6	5	4	3	2	1	0
MW 4104,00	Assignment																	
01	Position of faulty substation																	
02	Coupler 07 BR 60																	
03	Coupler substation No. 0																	
04	" substation No. 1																	
05	" substation No. 2																	
06	" substation No. 3																	
07	" substation No. 4																	
08	" substation No. 5																	
09	" substation No. 6																	
10	" substation No. 7																	
11	" substation No. 8																	
12	" substation No. 9																	
MW 4105,03	I/O module configuration																	
04	I/O module																	
05	max. updating time in ms																	
06	min. updating time in ms																	
07	updating time in ms																	
MW 4104,13 – MW 4105,02 not relevant																		
Error information for 2nd line has the same structure as MW 4105,08...MW 4106,15																		
Error information for 3rd line has the same structure as MW 4107,00...MW 4108,07																		
Error information for 4th line has the same structure as MW 4108,08...MW 4109,15																		
1) A set bit indicates an occupied substation; e.g. MW 4104,00																		
Bit 7 = 1 means that substation No. 7 in the first line is occupied.																		
2) A set bit indicates which substation is in a faulty state; e.g. MW 4104,01																		
Bit 2 = 1 means that substation No. 2 is in a faulty state.																		
3) Set bit means an error																		
Bit 0 ... 7	counters for transmission error																	
Bit 8	faulty configuration																	
Bit 9	faulty connection to substation																	
Bit 10	double substation number																	
Bit 11																		
Bit 12	I/O error on substation																	
Bit 13	system bus error																	
Bit 14	framing error																	
Bit 15	time exceeded																	

Table 4.4.6: Error information on couplers

Grounding Scheme

(see Fig. 4.4.4 to 4.4.7)

The outer shield of the triaxial cable is directly electrically grounded on the side of the 07 BR 60 once per line (Fig. 4.4.4). The outer shields must be capacitively grounded (via $0.1 \mu\text{F}$) on the side of the substations (Fig. 4.4.5 and 4.4.6).

If an equal ground potential is guaranteed in a system through the use of special measures, e.g. by the provision of additional equipotential bonding of large cross-sectional area, the substations can also be directly grounded.

The return lead ("inner shield" of the triaxial cable) is directly grounded at the coupler 07 BR 60; at the coupler 07 BR 61 it is capacitively grounded. The grounding screw of the connector blocks must be connected to the grounding screw of the subrack with a short cable ($\geq 4 \text{ mm}^2$).

For effective protection against electromagnetic interference the outer shields must be connected to the cabinet ground with the shortest possible leads.

The protective caps supplied should be placed over the BNC sockets to protect them against electrostatic discharges.

In the control cabinet the connecting cables for the couplers should not be laid in the same cable ducts as the low-voltage leads.

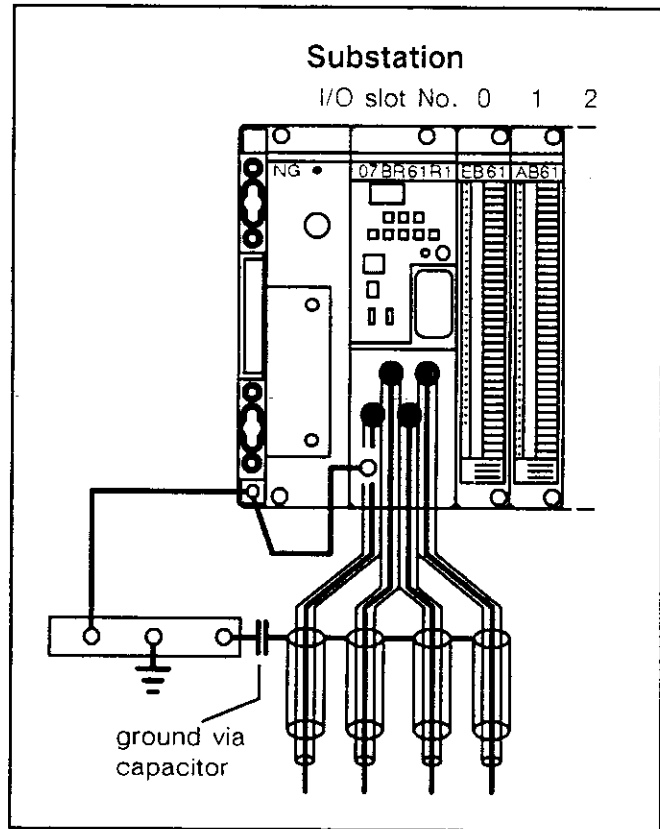

Fig. 4.4.5: Grounding scheme of the 07 BR 61 at substation

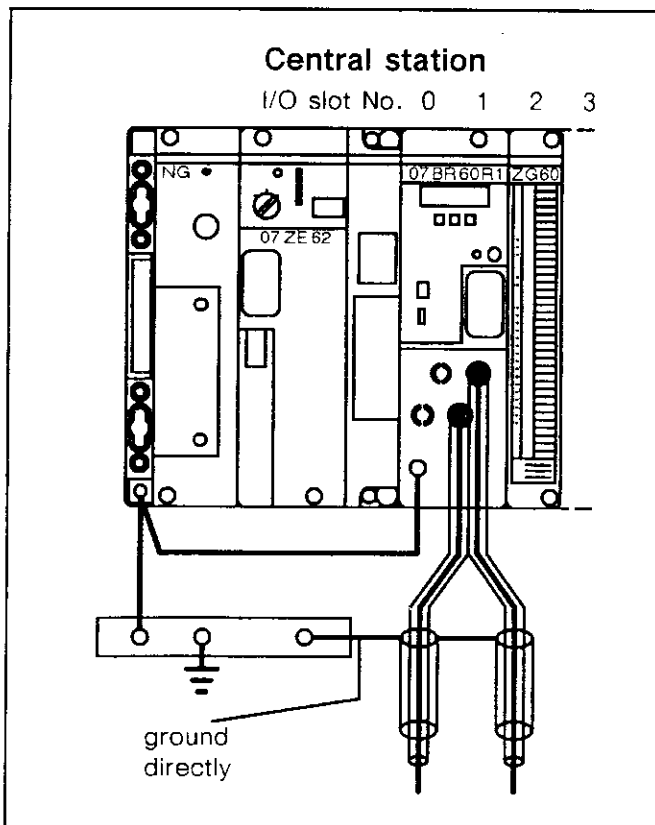

Fig. 4.4.4: Grounding scheme of 07 BR 60 at basic subrack

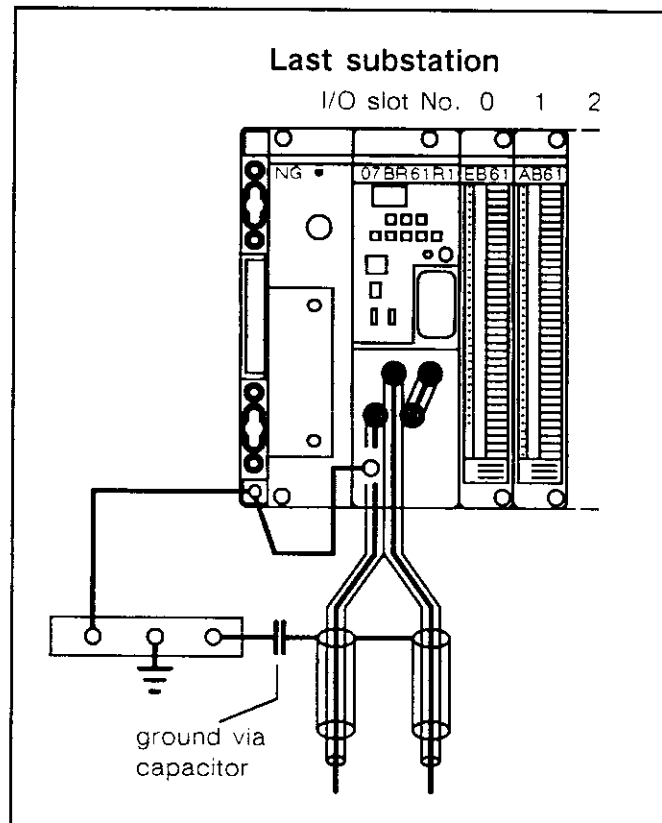

Fig. 4.4.6: Grounding scheme of 07 BR 61 in the last substation

Manual Loop Test

The manual loop test is carried out only when a transmission error is present between two couplers or between a coupler of a substation and a programming unit (e.g. PC). Only one coupler can be tested at a time.

Testing a remote I/O connection:

The voltage supply to the subrack must be switched off and the send and receive connectors TxD-T and RxD-T or TxD-R and RxD-R respectively are to be connected with the cable supplied.

The DIP switch CHECK must be set to ON and the RS-232C - REM selection switch to REM. After powering up or pressing the RES key the loop test is started. The data pattern sent is compared with the data pattern received and displayed on the 7-segment display. An error will be indicated by the ERR LED and the latest received test telegram.

Testing the serial interface:

The voltage supply to the subrack is to be switched off and the test connector supplied is to be plugged on the interface plug. The DIP switch CHECK is to be set to ON and the RS-232C - REM selection switch to 232C. After powering up or when the supply voltage is turned on after pressing the RES key, the loop test is started. The data pattern sent is compared with the data pattern received and displayed on the 7-segment display. An error will be indicated by the ERR LED and by an error number.

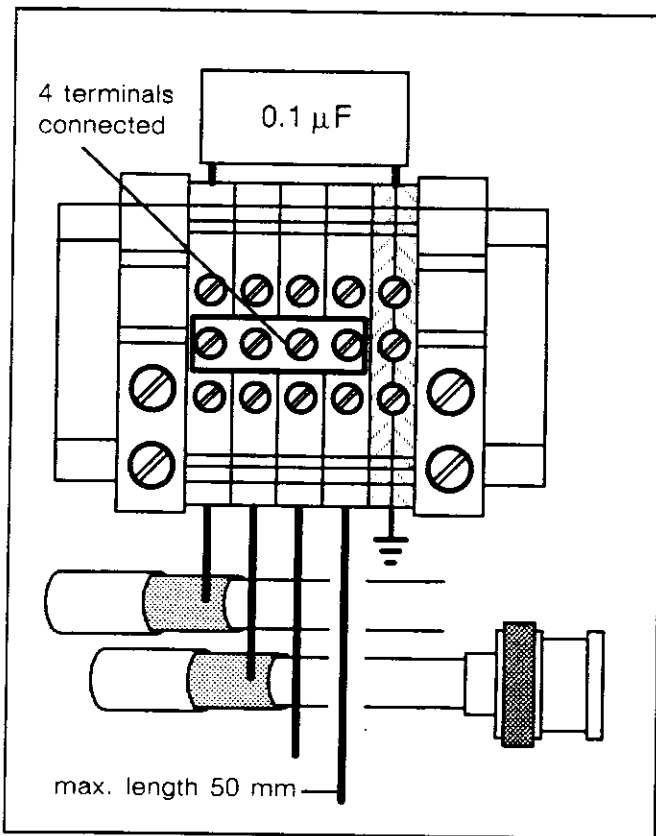

Fig. 4.4.7: Constructional suggestion for grounding the triax outer shields (see also Fig. 4.4.5/4.4.6)

Technical Data

Max. number of configurable lines

Max. address range per line

Max. address range for 4 lines

Max. number of substations²⁾ per line

Max. number of I/O slots per substation

Transmission speed/Baud rate

Transmission mode

Updating time

Self-diagnosis

Error test

Special mode of networking

Distance between two stations

Overall length of line

Connecting cable

07 BR 61 R1

4 (one 07 BR 60 per line is required)

512 I/O points¹⁾

2048 I/O points

10 (one 07 BR 61 per substation is required)

9

1.5 Mbit/s

halfduplex with serial transmission

15 ms for 512 I/O points with 10 substations

ROM/RAM system test, watchdog, loop test

CRC16, checksum test

Connector block with bypass structure

max. 500 m

max. 500 m

triaxial cable, impedance 50 Ω

¹⁾ 1 bit channel occupies 1 I/O point
1 word channel occupies 16 I/O points

²⁾ 1 substation occupies 1 BE subrack

Interfaces for programming unit	1
Signalling	LED, 7-segment display
Current consumption from internal voltages	
UB1 = 5 V DC	max. 1.6 A
UB4 = 24 V DC	no current consumption
Total power dissipation	max. 8 W
Number of required slots	1 BV slot + 1 I/O slot
Configuration identifier in 907 PC 32	no entry in menu "System configuration"
Ability of fitting in subracks	
slot,	
●--● = plug-in is possible (2 slots)	
Weight	920 g
Order number	GJV3074376R0001
Serial interface:	
Interface type	RS-232-C
Transmission speed/Baud rate	19 200 baud
Transmission mode	semiduplex, bit-serial, 7 data bits, 1 stop bit, even parity
Self-diagnosis	checking of parity, overflow and frame
Accessories (supplied):	4 protective caps for insulating BNC sockets

BT			BE-central			BE-remote		
NG	ZE	I/O	NG	BV	I/O	NG	BV	I/O
							●---●	

Accessories (not supplied):

Component	Designations (remarks)
TRIAx cable	50 Ω Triax cable higher EMC, Type 9222 or Type 9888 Manufacturer: Belden Electronics, Fuggerstr. 2 W-4040 Neuss 1
TRIAx cable	50 Ω Triax cable higher EMC, Type 43V 616/310 Manufacturer: Letronic – Dieter Ley Radeberger Str. 4 W-6800 Mannheim 31
BNC plug	Crimp plug for 9222 or 43V 616/310 Suhner 11BNC-50-3-4c Rosenberger 51 S 101-106 A1
BNC plug	Crimp plug for 9888 Suhner 11BNC-50-7-7c
X-type capacitor 0.1 μF	Manufacturer: RIFA, Sweden Part No. PME 271 M 610 Suppliers: Industrial Electronics GmbH Hauptstr. 71-79, W-6236 Eschborn or EVOX-Rifa GmbH Industriestr. 5, Postfach 1166 W-7707 Engen
Universal terminal, Universal Protective Earth terminal	Suppliers: C. A. Weidmüller GmbH & Co. Postfach 950, W-4930 Detmold or Phönix, Postfach 149 W-4933 Blomberg/Lippe

Error handling

When an error occurs, information about it is stored in the internal flags M 125,00, MW 4096,06 and MW 4104,00 to MW 4109,15. At the same time an error code appears on the 7-segment display. The following error table shows the meanings of the error codes:

Table 4.4.7: Error table (07 BR 61)

No	Error name	Error code	ERR LED display	is displayed in case of	is reset when	Remarks
1	Watchdog error	8 8	● ON	Fault in micro-computer	the reset button (RES) is pressed	
2	ROM/RAM-error	8 8	● ON	a RAM/ROM error has been detected on switching on the voltage supply	the reset button (RES) is pressed	The RAM/ROM error will lead to a watchdog error
3	Transmission error	E 1	⊗ OFF	a transmission error has occurred between the central station and the substation	the reset button (RES) and the error clear button (ERR CLR) are pressed	
4	Transmission time exceeded	E 2	⊗ OFF	neither the central station nor the substation have reacted within the preset time	the reset button (RES) and the error clear button (ERR CLR) are pressed	
5	RS-232-C parity error	6 1	⊗ OFF	the received data at the peripheral connector show a parity error	the reset button (RES) and the error clear button (ERR CLR) are pressed	
6	RS-232-C frame/overflow error	6 2	⊗ OFF	the received data show a "framing error" or an overflow error	the reset button (RES) and the error clear button (ERR CLR) are pressed	
7	RS-232-C time exceeded	6 3	⊗ OFF	a receive-data time-out error has appeared	the reset button (RES) and the error clear button (ERR CLR) are pressed	
8	Protocol error	6 4	⊗ OFF	the protocol of the received data is incorrect	the reset button (RES) and the error clear button (ERR CLR) are pressed	

No	Error name	Error code	ERR LED display	is displayed in case of	is reset when	Remarks
9	RS-232-C checksum error	6 5	⊗ OFF	the received data show a checksum error	the reset button (RES) and the error clear button (ERR CLR) are pressed	
10	PI/O bus error	2 8	⊗ OFF	a bus error interrupt has appeared	the reset button (RES) is pressed	

Notes:

1. The error display can also be reset by switching the voltage supply to the unit off and on again. Hardware faults cannot be eliminated by pressing the reset button.
2. Even if an error occurs which will be eliminated automatically, the error code is displayed and stored until the ERR CLR or the RES button is pressed.
3. When several errors are detected at the same time, they are stored in the order in which they occurred. The 7-segment display shows the error code of the latest error to appear. By pressing the DSP CHG button the next respective error number can be displayed (cyclical switching).
4. If the ERR display of a substation (07 BR 61) is illuminated, the 7-segment display of the central station (07 BR 60) shows "E2" or "E8".

Table 4.4.8: Loop test result (07 BR 61)

No	Error name	Error code	ERR LED display	is displayed in case of	is reset when	Remarks
1	Normal remote I/O operation	0 0	⊗ OFF	communication between 07 BR 60 and 07 BR 61 is running correctly		
2	Normal loop test	x x	⊗ OFF		the reset button (RES) is pressed	xx: loop test data (dependent on time interval preset)
3	Loop test aborted	x x	● ON	the error has occurred during loop test	the reset button (RES) is pressed	xx: loop test data

4.5 Remote I/O Coupler with Optical Fibre 07 BR 61 R2 for substation

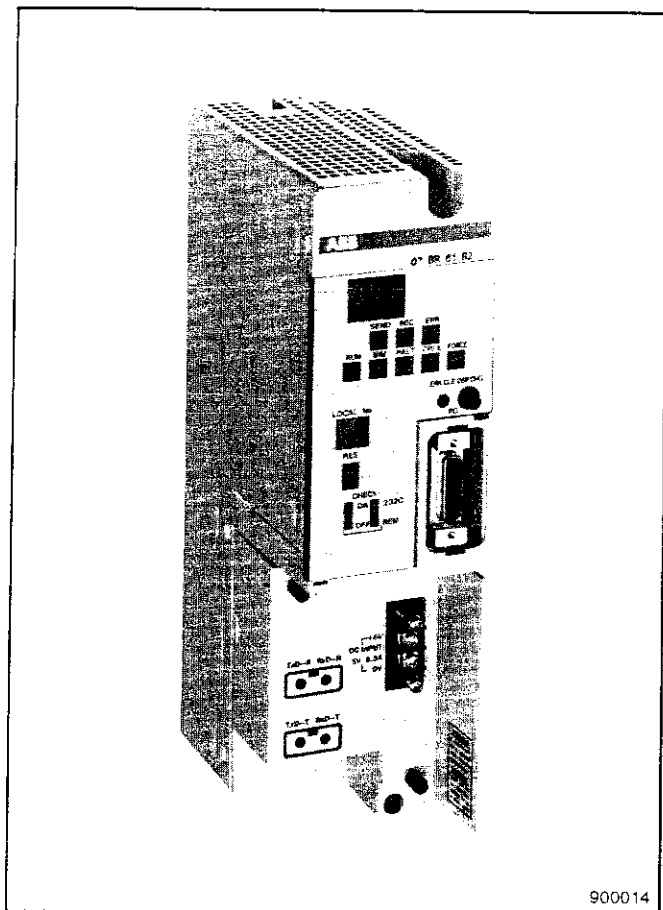

Fig. 4.5.1: Remote I/O coupler 07 BR 61 R2

Characteristics

Using remote I/O coupler 07 BR 61 for substations together with coupler 07 BR 60, a remote I/O expansion for the ABB Procontic T200 controller system can be constructed (see Fig. 4.5.2).

This makes it possible to have substations with process-oriented signal cabling. The distance between stations can be up to 2 km (optical fibre). The maximum possible overall length per line is 10 km (optical fibre).

For the construction of a remote I/O expansion configuration at least one 07 BR 60 coupler is required in the

basic subrack, together with one 07 BR 61 substation coupler per expansion subrack.

A maximum of 4 remote I/O expansion lines with up to 10 substations each is possible. In this case, in addition to the central expansion, a maximum of 2048 remote binary I/Os is possible with the maximum configuration. The sum of all binary I/Os, including central expansion, is then 3648.

Module Description

The coupler consists of the housing with removable transparent front covering for the display and operating elements, a screw-on connector block with fibre-optical sockets for connection to the couplers 07 BR 60 or 07 BR 61 respectively.

A 7-segment display and light-emitting diodes are provided for signalling ready status for operation and errors. Further pushbuttons and switches are provided for testing and operating the module (see Fig. 4.5.3).

In order to connect the 907 PC 32 programming and test system the coupler is provided with an RS-232-C interface, which has the standard values of the central units' interfaces (pin assignment, function, parameters).

Project Planning

The 07 BR 61 couplers for the construction of a remote I/O expansion configuration are placed only in the expansion subracks (BE). They occupy the BV slot and additionally one I/O slot per subrack. Therefore the maximum number of slots for I/O modules is reduced by one slot. The first slot to the right of the coupler 07 BR 61 is given slot number 0.

The connections between the couplers are made with optical fibres¹⁾.

Comprehensive diagnostic facilities allow for simple monitoring and fault detection both during commissioning and in operation.

¹⁾ see specifications for optical fibres

Central Station

I/O slot No. 0 1 2 3 4 5 6 7

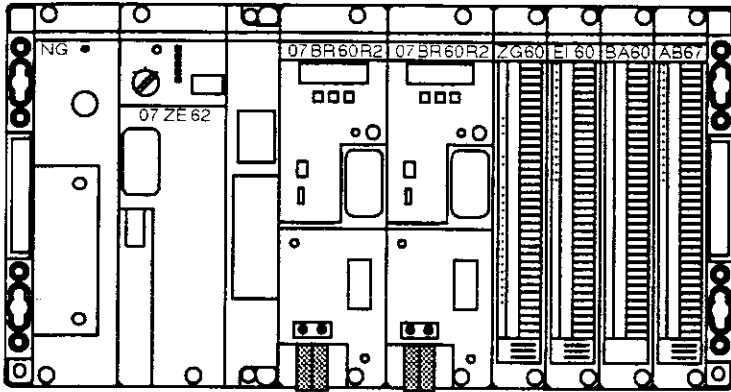

max. expansion possible:

- 4 lines for every central station
- 10 substations for every line
- 512 I/O points for every line
- 2 km max. for the distance between two stations
- 10 km total length of the line (between first and last station)

Connecting cables:
fibre-optic cable

1st line

2nd line

Substation No. 0

I/O slot No. 0 1 2 3

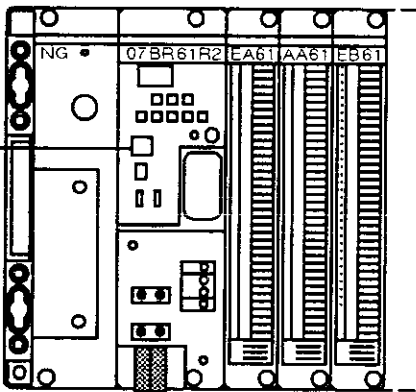

Substation No. 0

I/O slot No. 0 1 2 3

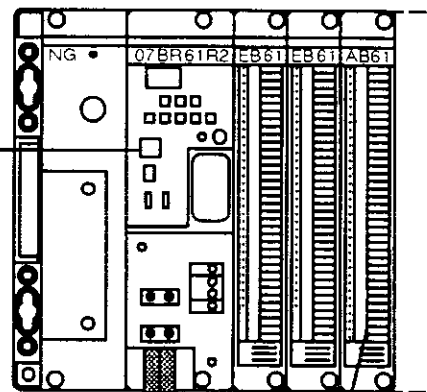

lines
at the rear

Substation No. 1

I/O slot No. 0 1 2 3 4 5

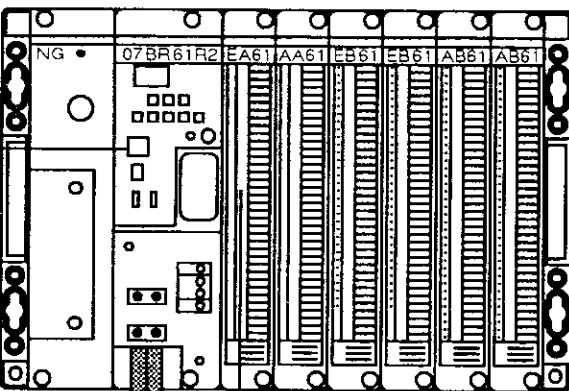

A 2.02,31

Line
Substation
Slot
Channel

VORSICHT!

DIE ANSCHLÜSSE RxD-T UND TxD-T MÜSSEN BEI LETZTER UNTERSTATION VERBUNDEN WERDEN

CAUTION!

CONNECT RxD-T AND TxD-T, WHEN THIS MODULE IS THE END OF REMOTE SYSTEM.

EW 1.10,03

Fig. 4.5.2: Configuration with remote expansion

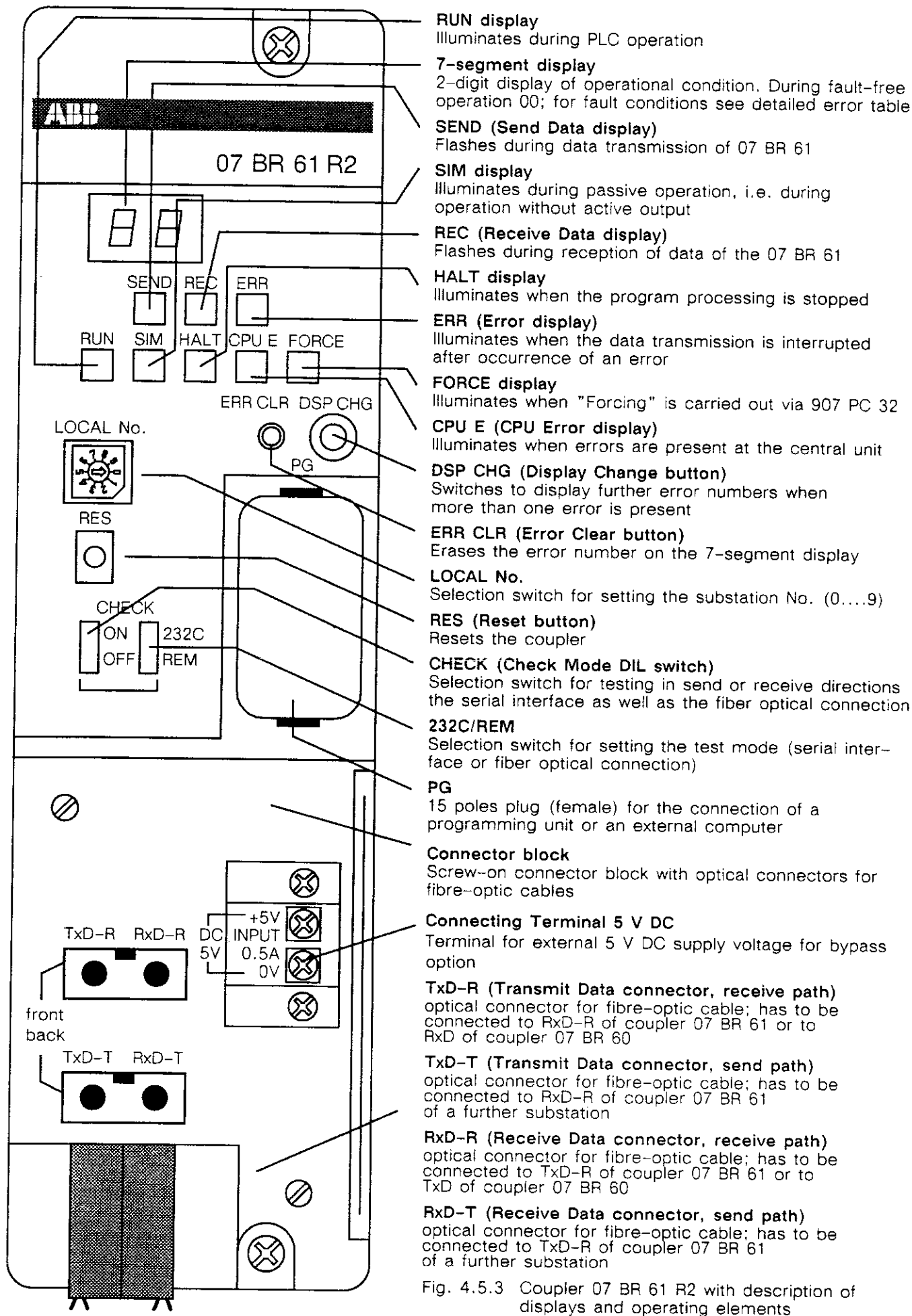

- RUN display**
Illuminates during PLC operation
- 7-segment display**
2-digit display of operational condition. During fault-free operation 00; for fault conditions see detailed error table
- SEND (Send Data display)**
Flashes during data transmission of 07 BR 61
- SIM display**
Illuminates during passive operation, i.e. during operation without active output
- REC (Receive Data display)**
Flashes during reception of data of the 07 BR 61
- HALT display**
Illuminates when the program processing is stopped
- ERR (Error display)**
Illuminates when the data transmission is interrupted after occurrence of an error
- FORCE display**
Illuminates when "Forcing" is carried out via 907 PC 32
- CPU E (CPU Error display)**
Illuminates when errors are present at the central unit
- DSP CHG (Display Change button)**
Switches to display further error numbers when more than one error is present
- ERR CLR (Error Clear button)**
Erases the error number on the 7-segment display
- LOCAL No.**
Selection switch for setting the substation No. (0...9)
- RES (Reset button)**
Resets the coupler
- CHECK (Check Mode DIL switch)**
Selection switch for testing in send or receive directions the serial interface as well as the fiber optical connection
- 232C/REM**
Selection switch for setting the test mode (serial interface or fiber optical connection)
- PG**
15 poles plug (female) for the connection of a programming unit or an external computer
- Connector block**
Screw-on connector block with optical connectors for fibre-optic cables
- Connecting Terminal 5 V DC**
Terminal for external 5 V DC supply voltage for bypass option
- TxD-R (Transmit Data connector, receive path)**
optical connector for fibre-optic cable; has to be connected to RxD-R of coupler 07 BR 61 or to RxD of coupler 07 BR 60
- TxD-T (Transmit Data connector, send path)**
optical connector for fibre-optic cable; has to be connected to RxD-R of coupler 07 BR 61 of a further substation
- RxD-R (Receive Data connector, receive path)**
optical connector for fibre-optic cable; has to be connected to TxD-R of coupler 07 BR 61 or to TxD of coupler 07 BR 60
- RxD-T (Receive Data connector, send path)**
optical connector for fibre-optic cable; has to be connected to TxD-R of coupler 07 BR 61 of a further substation

Fig. 4.5.3 Coupler 07 BR 61 R2 with description of displays and operating elements

Addressing

For binary I/Os the following applies:

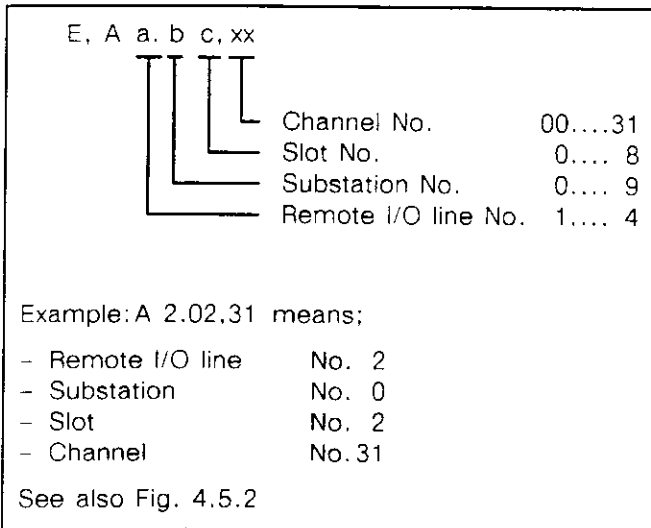

Table 4.5.1: Addressing of binary I/Os

For word-oriented I/Os the following applies:

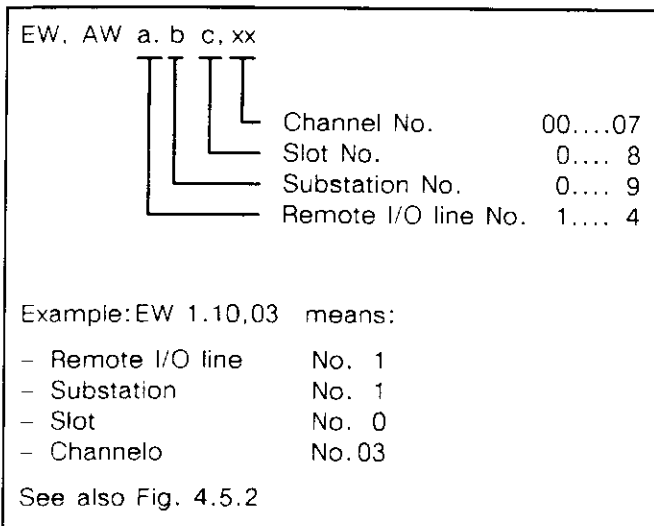

Table 4.5.2: Addressing of word-oriented I/Os

Connection scheme

Connections to further couplers are made with fibre-optic cables. The RxD-T or TxD-T connectors of the 07 BR 61 coupler have to be connected to the TxD-R or RxD-R connectors of the next 07 BR 61 coupler respectively (see Table 4.5.3 and Fig. 4.5.2).

If the connection between the couplers is broken or if there is a false connection, this is detected by the coupler and the corresponding error number is issued.

The removable connector block has "bypass structure", if the external 5 V DC supply voltage is connected. If the supply voltage to a substation is switched off, the remote I/O expansion bus is not interrupted. In

such an operational condition the bus connection is bridged over. The bus need therefore not be disconnected when replacing a defective substation coupler.

from	to
Central station RxD	substation No. 0 TxD-R
Central station TxD	substation No. 0 RxD-R
Subst. No. 0 RxD-T	substation No. 1 TxD-R
Subst. No. 0 TxD-T	substation No. 1 RxD-R
Subst. No. 1 RxD-T	substation No. 2 TxD-R
Subst. No. 1 TxD-T	substation No. 2 RxD-R
.....
.....
Last subst. RxD-T	last substation TxD-T

Table 4.5.3: Optical fibre connections

General instructions

In general the voltage supply to the subrack must be switched off before inserting or removing couplers.

Screw-on connector blocks of couplers labeled with R2 (optical fibre connection) must neither be replaced with connector blocks of couplers labeled with R1 (triaxial connection) nor in the reverse case.

When powering up, either all power supplies should be switched on simultaneously or the remote expansions switched on first. Otherwise error message E8 (invalid substation number) will appear on coupler 07 BR 60 or error message "43" on the central unit, depending on how the operating mode parameters are set in the menu point "Configuration of system reactions".

When the supply voltage is switched on, i.e. during operation, neither the connector block nor the connecting leads may be removed.

Software Instructions

The operational condition of the units is monitored by the central unit and can be requested by means of internal flags (see error lists).

Flag:		
M 125,00	Coupler error (0 = normal, 1 = error)	
MW 4096,06	Position of faulty 07 BR 60 module (Table 4.5.5)	
MW 4104,00 - 4109,15	Error information of couplers (Table 4.5.6)	

Table 4.5.4: Flags

For reactions to specific error information it is advisable to use the Online Listings (907 PC 32).

The following table shows the structure of the MW 4096,06 in hex (representation in 907 PC 32 in decimal)

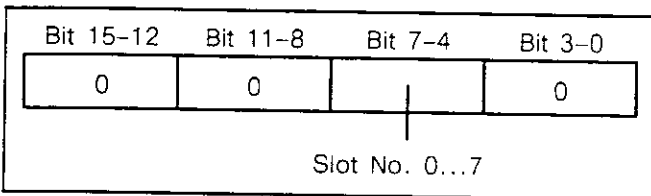

Table 4.5.5: Structure of MW 4096,06 in hex

The slot number (righthand number of the two occupied slots) of the coupler of the line in which a fault occurred appears in the MW 4096,06.

The flags MW 4096,06 and M 125,00 signal and store (with battery backup) an error and must be reset by the user in this order.

This can be done by means of a program or with the help of the short lists RESERR*.SIM supplied as files with 907 PC 32.

With the 07 BR 61 coupler no entry is necessary in the menu "System configuration".

The behaviour of the central unit in case of an error can be set in the 907 PC 32 menu "Configuration of system reactions" (see "Configuration of system reactions" in the description of the unit 07 BR 60).

Error information for the 1st line		Bit	15	14	13	12	11	10	9	8	7	6	5	4	3	2	1	0
MW 4104,00	Assignment																	
	01 Position of faulty substation																	
	02 Coupler 07 BR 60																	
	03 Coupler substation No. 0																	
	04 " substation No. 1																	
	05 " substation No. 2																	
	06 " substation No. 3																	
	07 " substation No. 4																	
	08 " substation No. 5																	
	09 " substation No. 6																	
	10 " substation No. 7																	
	11 " substation No. 8																	
	12 " substation No. 9																	
MW 4105,03	I/O module configuration																	
	04 I/O module																	
	05 max. updating time in ms																	
	06 min. updating time in ms																	
	07 updating time in ms																	
MW 4104,13 - MW 4105,02 not relevant																		
Error information for 2nd line has the same structure as MW 4105,08...MW 4106,15																		
Error information for 3rd line has the same structure as MW 4107,00...MW 4108,07																		
Error information for 4th line has the same structure as MW 4108,08...MW 4109,15																		

<p>1) A set bit indicates an occupied substation; e.g. MW 4104,00 Bit 7 = 1 means that substation No. 7 in the first line is occupied.</p> <p>2) A set bit indicates which substation is in a faulty state; e.g. MW 4104,01 Bit 2 = 1 means that substation No. 2 is in a faulty state.</p> <p>3) Set bit means an error</p> <table style="width: 100%; border: none;"> <tr> <td style="width: 50%;">Bit 0 ... 7 counters for transmission error</td> <td style="width: 50%;">Bit 12 I/O error on substation</td> </tr> <tr> <td>Bit 8</td> <td>Bit 13 system bus error</td> </tr> <tr> <td>Bit 9 faulty configuration</td> <td>Bit 14 framing error</td> </tr> <tr> <td>Bit 10 faulty connection to substation</td> <td>Bit 15 time exceeded</td> </tr> <tr> <td>Bit 11 double substation number</td> <td></td> </tr> </table>	Bit 0 ... 7 counters for transmission error	Bit 12 I/O error on substation	Bit 8	Bit 13 system bus error	Bit 9 faulty configuration	Bit 14 framing error	Bit 10 faulty connection to substation	Bit 15 time exceeded	Bit 11 double substation number		<table border="1" style="width: 100%; border-collapse: collapse; text-align: center;"> <tr> <td style="width: 50%;"></td> <td style="width: 25%;">Subst. No.</td> <td style="width: 25%;">slot No.</td> </tr> <tr> <td style="text-align: center;">0</td> <td></td> <td></td> </tr> <tr> <td style="text-align: center;">0</td> <td></td> <td></td> </tr> <tr> <td style="text-align: center;"> </td> <td></td> <td></td> </tr> <tr> <td style="text-align: center;"> </td> <td></td> <td></td> </tr> <tr> <td style="text-align: center;"> </td> <td></td> <td></td> </tr> </table>		Subst. No.	slot No.	0			0											
Bit 0 ... 7 counters for transmission error	Bit 12 I/O error on substation																												
Bit 8	Bit 13 system bus error																												
Bit 9 faulty configuration	Bit 14 framing error																												
Bit 10 faulty connection to substation	Bit 15 time exceeded																												
Bit 11 double substation number																													
	Subst. No.	slot No.																											
0																													
0																													

Table 4.5.6: Error information on couplers

Manual Loop Test

The manual loop test is carried out only when a transmission error is present between two couplers or between a coupler of a substation and a programming unit (e.g. PC). Only one coupler can be tested at a time.

Testing a remote I/O connection:

The voltage supply to the subrack must be switched off and the send and receive connectors TxD-T and RxD-T or TxD-R and RxD-R respectively are to be connected with the cable supplied.

The DIP switch CHECK must be set to ON and the RS-232C - REM selection switch to REM. After powering up or pressing the RES key the loop test is started.

The data pattern sent is compared with the data pattern received and displayed on the 7-segment display. An error will be indicated by the ERR LED and the latest received test telegram.

Testing the serial interface:

The voltage supply to the subrack is to be switched off and the test connector supplied is to be plugged on the interface plug. The DIP switch CHECK is to be set to ON and the RS-232C - REM selection switch to 232C. After powering up or when the supply voltage is turned on after pressing the RES key, the loop test is started. The data pattern sent is compared with the data pattern received and displayed on the 7-segment display. An error will be indicated by the ERR LED and by an error number.

Technical Data

Max. number of configurable lines	4 (one 07 BR 60 per line is required)
Max. address range per line	512 I/O points ¹⁾
Max. address range for 4 lines	2048 I/O points
Max. number of substations ²⁾ per line	10 (one 07 BR 61 per substation is required)
Max. number of I/O slots per substation	9
Transmission speed/Baud rate	1.5 Mbit/s
Transmission mode	halfduplex with serial transmission
Updating time	15 ms for 512 I/O points with 10 substations
Self-diagnosis	ROM/RAM system test, watchdog, loop test
Error test	CRC16, checksum test
Special mode of networking	Connector block with bypass structure (the external 5 V DC supply voltage must be switched on)
Distance between two stations	max. 2 km
Overall length of line	max. 10 km
Connecting cable	fibre-optic cable
Wave length	840 nm
Launched power (peak dBm)	- 21 dBm
Type of fibre (core/cladding diameter)	50/125 µm
Attenuation of fibre	3.0 dB/km @ 840 nm
Max. permissible system loss of assembled cable	16 dB
Typical insertion loss of connector	≤ 1 dB
Typical insertion loss of connection	≤ 2 dB
Typical insertion loss of splice	≤ 0.2 dB
Interfaces for programming unit	1
Signalling	LED, 7-segment display
Current consumption from internal voltages	
UB1 = 5 V DC	max. 1.9 A
UB4 = 24 V DC	no current consumption

- ¹⁾ 1 bit channel occupies 1 I/O point
1 word channel occupies 16 I/O points
²⁾ 1 substation occupies 1 BE subrack

Total power dissipation		max. 8 W
Number of required slots		1 BV slot + 1 I/O slot
Configuration identifier in 907 PC 32		no entry in menu "System configuration"
Ability of fitting in subracks		
slot,		
●---● = plug-in is possible (2 slots)		
Weight		920 g
Order number	07 BR 61 R2	GJV3074376R0002
Serial interface:		
Interface type		RS-232-C
Transmission speed/Baud rate		19 200 baud
Transmission mode		semiduplex, bit-serial, 7 data bits, 1 stop bit, even parity
Self-diagnosis		checking of parity, overflow and frame
Technical data for external 5 V DC power supply:		
Voltage		5 V DC ± 5 %
Output load capability		700 mA
Residual ripple		max. 50 mVss

For each optical coupler (07 BR 61 R2) a separate 5 V DC power supply module should be used.

Accessories (not supplied):

Component	Designations (remarks)	
ABB SIGMA [®] tronic b Converter R508.1 (24 V DC/5 V DC)	ABB order No.	GH R508 0001 R1
Premounted Simplex optical-fibre indoor cable with connectors at both ends, length = 10 m	Type:	07 LK 60
	ABB order No.	GJV3 0755 01 R1
Premounted Simplex optical-fibre indoor cable with connectors at one end, for splice connections, length = 10 m	Type:	07 LK 61
	ABB order No.	GJV3 0755 02 R1
Coupling device for cable-to-cable connection and test and measurement purposes	Type:	07 LV 60
	ABB order No.	GJV3 0755 03 R1

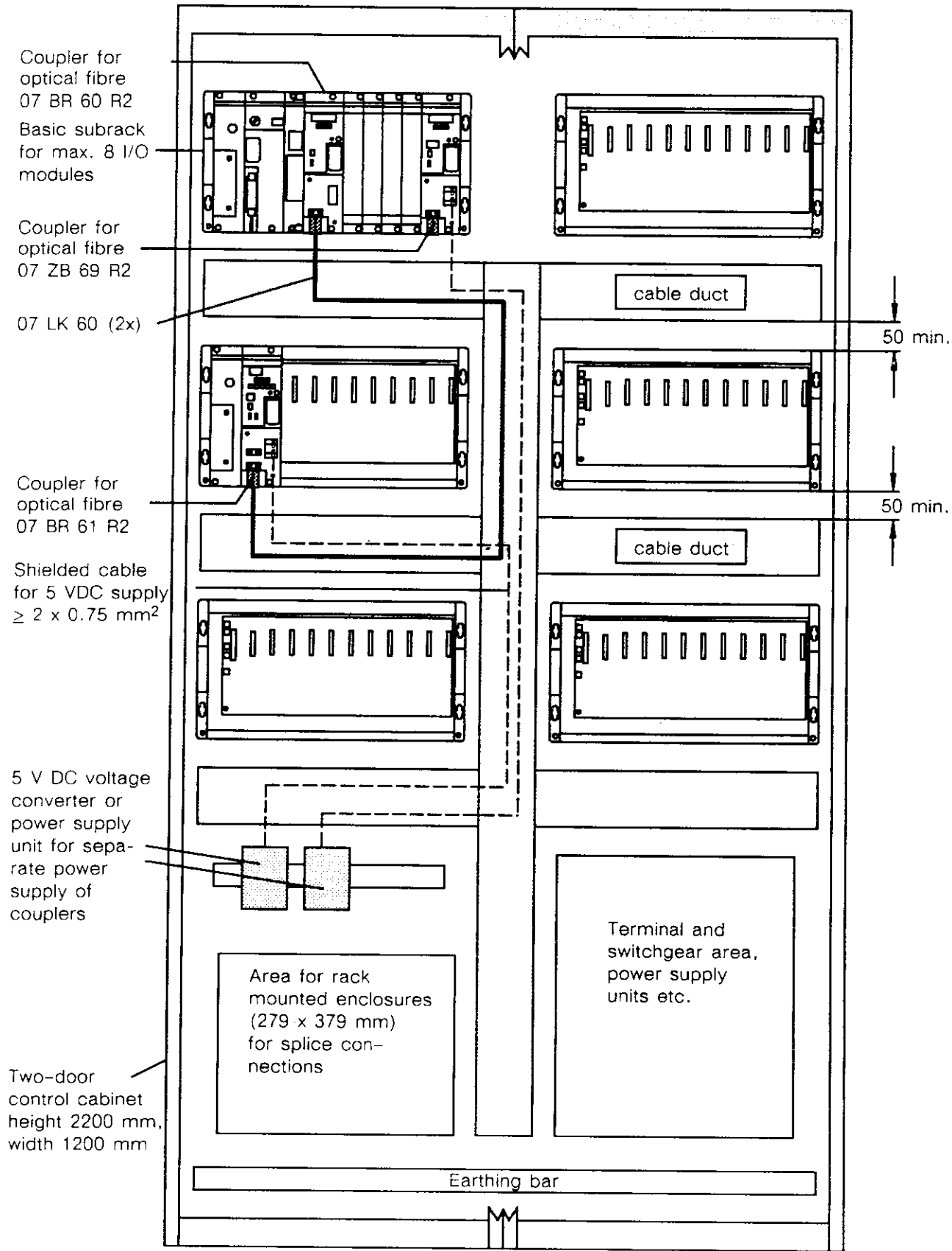

When laying fibre-optic cables care has to be taken that the bending radius will not fall below the minimum permissible.

Fig. 4.5.4: Typical rack mounting and wiring management of optical-fibre modules

Fibre-Optic Cable Installation

Laying fibre-optic cables is more ambitious than laying copper cables. It has to be carried out by highly skilled workers, who are familiar with the mechanical properties of the cable and the practical aspects of a correct installation. The following points should be observed.

1. There is a great variety of fibre-optic cables, which can be buried, strung aerially or placed in trays and conduits. Depending on the way of installation there are many tools and special equipments to be used.
2. Minimum bend radius and maximum tensile rating are the critical specifications for any fibre-optic cable installation, both during the installing process and during the installed life of the cable. Careful planning of the installation layout will ensure that the specifications are not exceeded. In addition, the installation process itself must be carefully planned.

An increasing tensile load as well as a decreasing bend radius cause a reversible attenuation increase, an irreversible attenuation increase, and, finally, cracking of the fibre.

2. Cables must be protected against damage during and after installation. Splice connections and cable ends (with their connectors) must be protected against humidity.
Buried cables must be protected against frost, water seepage, attack by burrowing and gnawing animals, and mechanical stresses that could result from earth movements. Armored cables specially designed for burial are available.
Aerial cables must be able to withstand the forces

of high winds, storms, ice loading, and so forth. Self-supporting aerial cables are available.

3. Since standard fibre-optic cables are electrically nonconductive, they may be placed near high-voltage cables without shielding.
4. The primary consideration in selecting a route for fibre-optic cable through trays and ducts is to avoid potential cutting edges and sharp bends. Areas where particular caution must be taken are corners and exit slots in sides of trays.
If a fibre-optic cable is in the same tray or duct with very large, heavy electrical cables, care must be taken to avoid placing excessive crushing forces on the fibre-optic cable, particularly where the heavy cables cross over the fibre-optic cable.
5. Long vertical runs within trays and ducts as well as runs outside them should be clamped at intermediate points. Clamping forces should be no more than necessary to prevent damage and crushing forces on the jacket of the optical cable.
6. During pulling of the cable, pulling force should be constantly monitored by a mechanical gauge. If any increase in pulling force is noticed, pulling should immediately cease, and the cause of the increase should be determined.
Pull tension can be monitored by a running line tensiometer or a dynamometer and pulley arrangement. If a power winch is used to assist the pulling, a power capstan with adjustable slip clutch is recommended. The clutch, set for the maximum loading, will disengage if the set load is reached.
If necessary for difficult pulls, the cable should be continuously lubricated during pulling-in.

Error handling

When an error occurs, information about it is stored in the internal flags M 125,00, MW 4096,06 and MW 4104,00 to MW 4109,15. At the same time an er-

ror code appears on the 7-segment display. The following error table shows the meanings of the error codes:

Table 4.5.7: Error table (07 BR 61)

No	Error name	Error code	ERR LED display	is displayed in case of	is reset when	Remarks
1	Watchdog error	8 8	● ON	Fault in micro-computer	the reset button (RES) is pressed	
2	ROM/RAM-error	8 8	● ON	a RAM/ROM error has been detected on switching on the voltage supply	the reset button (RES) is pressed	The RAM/ROM error will lead to a watchdog error
3	Transmission error	E 1	⊗ OFF	a transmission error has occurred between the central station and the substation	the reset button (RES) and the error clear button (ERR CLR) are pressed	
4	Transmission time exceeded	E 2	⊗ OFF	neither the central station nor the substation have reacted within the preset time	the reset button (RES) and the error clear button (ERR CLR) are pressed	
5	RS-232-C parity error	6 1	⊗ OFF	the received data at the peripheral connector show a parity error	the reset button (RES) and the error clear button (ERR CLR) are pressed	
6	RS-232-C frame/overflow error	6 2	⊗ OFF	the received data show a "framing error" or an overflow error	the reset button (RES) and the error clear button (ERR CLR) are pressed	
7	RS-232-C time exceeded	6 3	⊗ OFF	a receive-data time-out error has appeared	the reset button (RES) and the error clear button (ERR CLR) are pressed	
8	Protocol error	6 4	⊗ OFF	the protocol of the received data is incorrect	the reset button (RES) and the error clear button (ERR CLR) are pressed	

No	Error name	Error code	ERR LED display	is displayed in case of	is reset when	Remarks
9	RS-232-C checksum error	6 5	⊗ OFF	the received data show a checksum error	the reset button (RES) and the error clear button (ERR CLR) are pressed	
10	PI/O bus error	2 8	⊗ OFF	a bus error interrupt has appeared	the reset button (RES) is pressed	

Notes:

1. The error display can also be reset by switching the voltage supply to the unit off and on again. Hardware faults cannot be eliminated by pressing the reset button.
2. Even if an error occurs which will be eliminated automatically, the error code is displayed and stored until the ERR CLR or the RES button is pressed.
3. When several errors are detected at the same time, they are stored in the order in which they occurred. The 7-segment display shows the error code of the latest error to appear. By pressing the DSP CHG button the next respective error number can be displayed (cyclical switching).
4. If the ERR display of a substation (07 BR 61) is illuminated, the 7-segment display of the central station (07 BR 60) shows "E2" or "E8".

Table 4.5.8: Loop test result (07 BR 61)

No	Error name	Error code	ERR LED display	is displayed in case of	is reset when	Remarks
1	Normal remote I/O operation	0 0	⊗ OFF	communication between 07 BR 60 and 07 BR 61 is running correctly		
2	Normal loop test	x x	⊗ OFF		the reset button (RES) is pressed	xx: loop test data (dependent on time interval preset)
3	Loop test aborted	x x	● ON	the error has occurred during loop test	the reset button (RES) is pressed	xx: loop test data

4.6 Coupler with TRIAX Cable ¹⁾ 07 ZB 60 R1 for connection to ABB Procontic field bus ZB 10

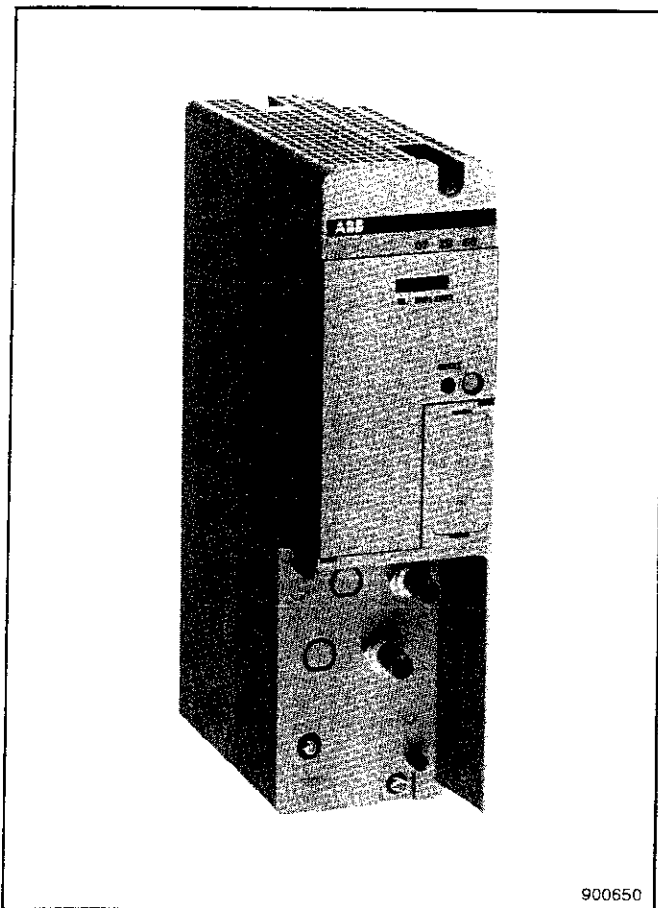

Fig. 4.6.1: Coupler 07 ZB 60 R1

Characteristics

Networking the ABB Procontic T200 control system with other ABB Procontic systems via the ABB Procontic field bus ZB 10 is possible, when using the 07 ZB 60 coupler (see Fig. 4.6.2).

In addition to this, each networked station can be expanded centrally and/or remotely (see descriptions of the 07 BV 60 bus connector and 07 BR 60/61 couplers).

A maximum of two 07 ZB 60 couplers can be employed on a basic subrack; in doing so, two ZB 10 lines with up to 250 stations can be achieved. It is also possible to use one ZB 10 coupler and one ZB 20 coupler in the same station and thus to create a data transmission path between ZB 10 and ZB 20 (see Fig. 4.6.7).

The transmission of the process data is carried out via operands for the coupler ranges. These can be addressed in bits or in words. The consistency of 16-bit data is guaranteed.

¹⁾ TRIAX = double shielded coaxial cable

²⁾ TWINAX = twin axial cable (2-core, twisted and shielded high-frequency data transmission line)

³⁾ see description of coupler 07 ZB 60 R2, starting on page 4.7-1

Module Description

The module consists of a housing with a removable transparent front cover for the display and operating elements and a connector block, which can be unscrewed, with BNC sockets for coupling further ZB 10 couplers and a grounding screw.

LEDs are provided for signalling the ready status for operation and errors.

Project Planning

The 07 ZB 60 couplers can only be employed in basic subracks (BT). The positioning sequence of the couplers determines the number of the ZB 10 line (1 or 2). With two couplers the left 07 ZB 60 is given the number 1, corresponding to ZB 10 line 1.

Commercially available TRIAX cable ¹⁾ is used as data transmission line for the networking.

If it is desired to configure the ZB 10 networking by means of TWINAX cable ²⁾, the coupler 07 ZB 60 R2 ³⁾ is to be used.

Comprehensive diagnostic facilities of the bus controller allow for simple monitoring and error detection both during commissioning and in operation. Marshalling of source addresses is carried out in words by the programming software 907 PC 32. EPROMs for marshalling are not necessary.

Hardware and planning with the ABB Procontic field bus ZB 10 are described in detail in the following publications:

English:

ABB Procontic Field Bus ZB 10, Hardware,
Order No. GATS 1350 01 R2001

ABB Procontic Field Bus ZB 10, Planning,
Order No. GATS 1350 02 R2001

German:

ABB Procontic Feldbus ZB 10, Hardware,
Bestell-Nr. GATS 1350 01 R1001

ABB Procontic Feldbus ZB 10, Projektierung,
Bestell-Nr. GATS 1350 02 R1001

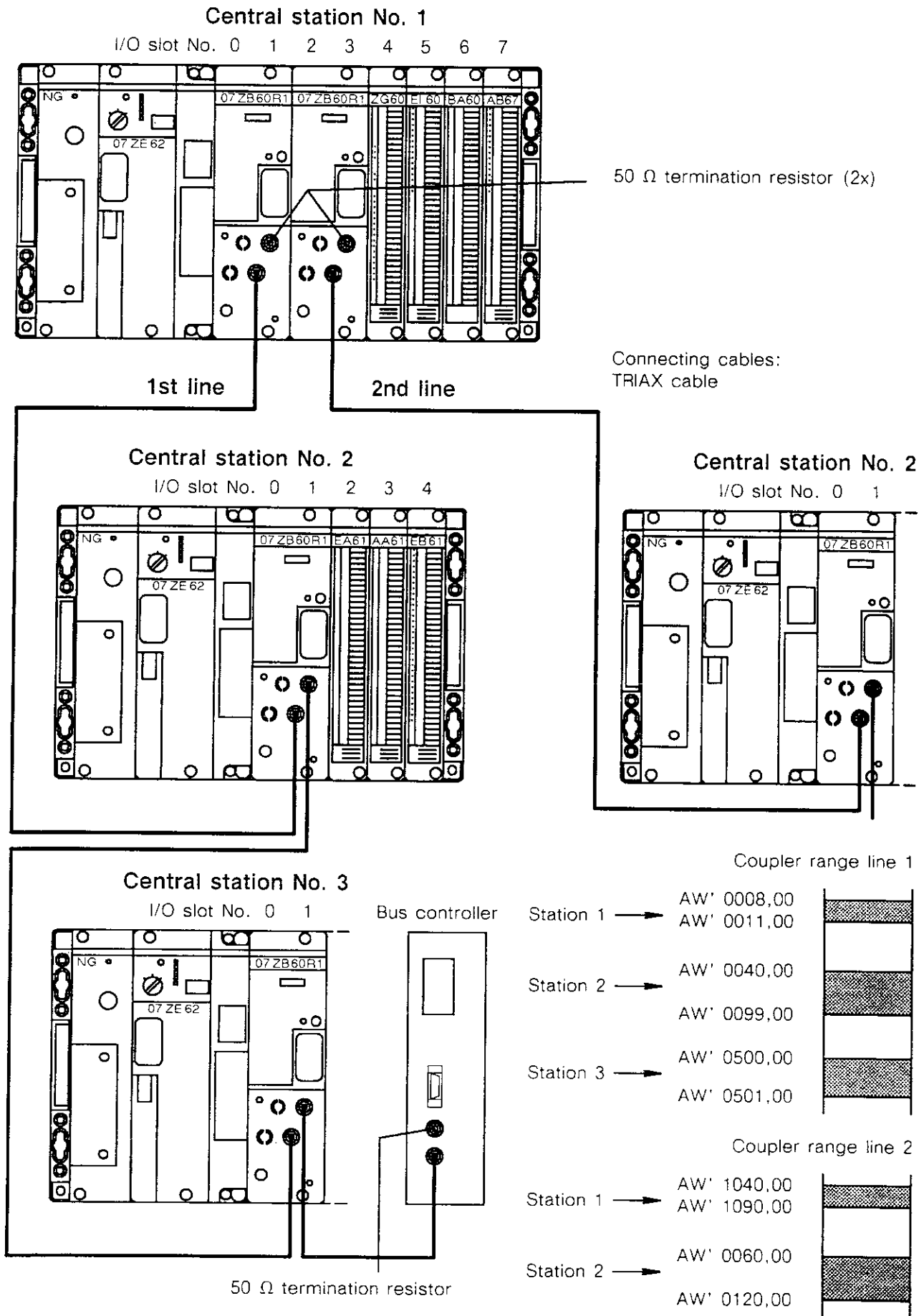

Fig. 4.6.2: Example for a networking with 2 lines (line 1 shown with 3 central stations and the bus controller)

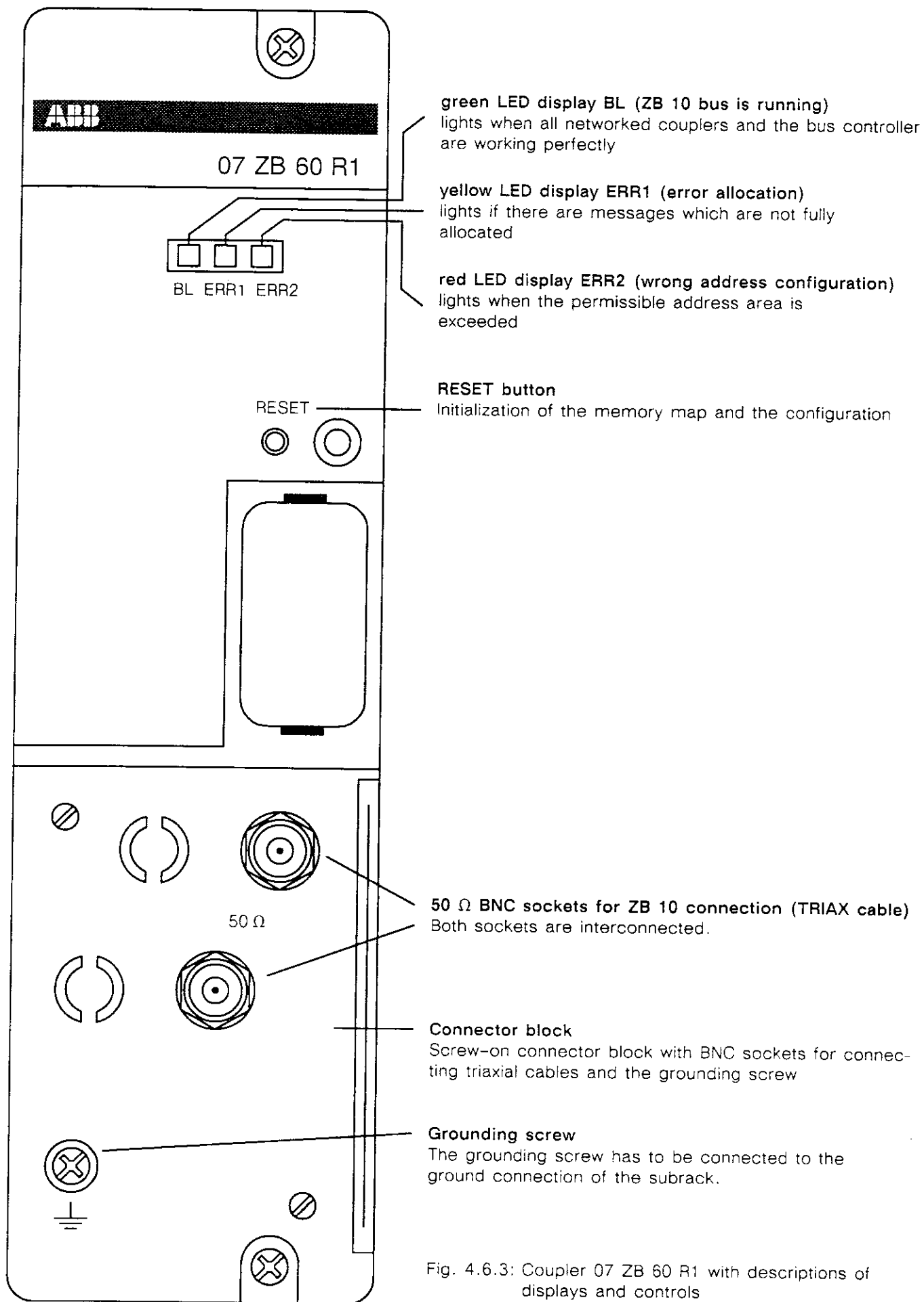

Fig. 4.6.3: Coupler 07 ZB 60 R1 with descriptions of displays and controls

Connection scheme

Commercially available TRIAX cable is used as data transmission line for the networking.

The removable connector block allows a replacement of a defective coupler without breaking the bus line. If a coupler is to be replaced, the power supply unit of the station involved has to be switched off. The connector block is unscrewed and, without loosening the TRIAX cables, the defective unit replaced by a new one, whose connector block has been removed before. The previous connector block can be reinstalled then.

At both ends, the bus line is terminated with a $50\ \Omega$ BNC-type termination resistor (see Fig. 4.6.2).

IMPORTANT:

When the supply voltage is switched on, i.e. during operation, neither the connector block nor the connecting leads may be removed.

General instructions

In general the voltage supply to the subrack is to be switched off before inserting or removing couplers.

There are no restrictions on the power-up sequence of ABB Procontic T200 systems with ZB 10 couplers. Data transmission via the ZB 10 bus, however, does not start until the ZB 10 bus controller has been powered up.

The message BL (bus is running) will not appear, before all stations at the ZB 10 bus are working correctly.

For further information with regard to planning the ZB 10 field bus refer to both the publication

ABB Procontic Field Bus ZB 10, Planning,
Order No. GATS 1350 02 R2001

and to the following grounding scheme.

Grounding scheme

(see Fig. 4.6.4 and Fig. 4.6.5)

At the bus controller, the inner and the outer shields of the TRIAX cables are grounded directly, i.e. once per line.

At the couplers, the outer shields of the TRIAX cables must be grounded capacitively (via $0.1\ \mu\text{F}$), see Figure 4.6.4.

All couplers can be grounded directly, if an equal ground potential is guaranteed in a system by use of special measures, e.g. the provision of additional equipotential bonding of large cross-sectional area.

The return lead ("inner shield" of the triaxial cable) is grounded capacitively inside the connector block of the 07 ZB 60 coupler.

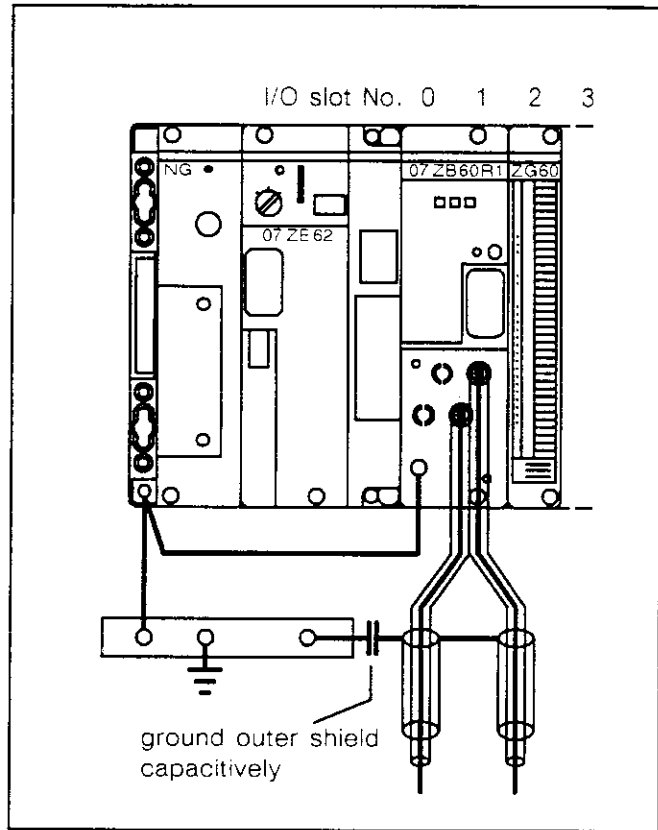

Fig. 4.6.4: Grounding scheme of the 07 ZB 60 R1

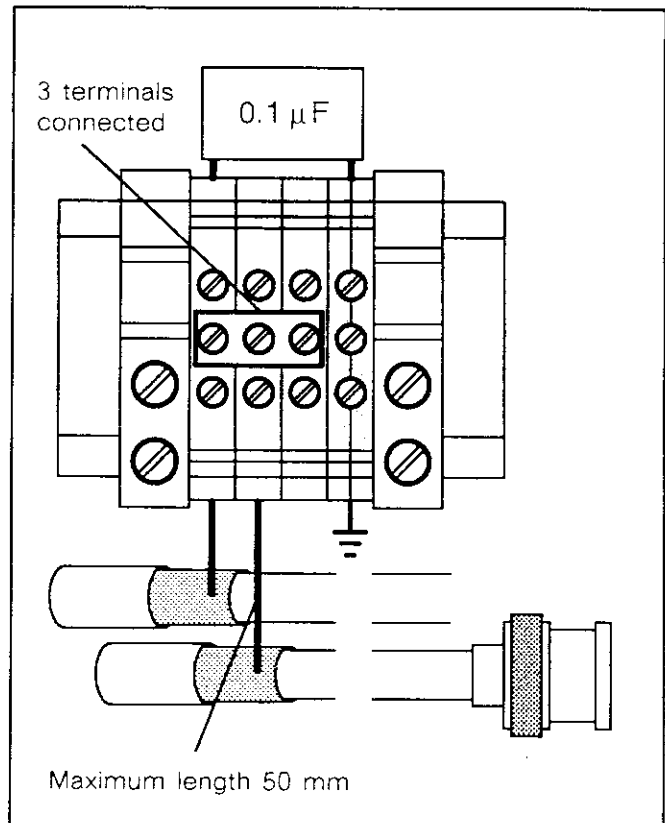

Fig. 4.6.5: Constructional suggestion for grounding Triax outer shields (see also Fig. 4.6.4)

The grounding screw of the connector blocks must be connected to the grounding screw of the subrack by a short wire with a conductor cross section greater than or equal to 4 mm².

For most effective Electro-Magnetic Compatibility the outer shields must be connected to the cabinet ground by leads as short as possible.

In the control cabinet the connecting cables for the couplers should not be laid in the same cable ducts as low-voltage leads.

Software Instructions

Coupler ranges

Process data are transmitted via the ZB 10 by means of operands for the coupler range 1 (left-hand module) and the coupler range 2 (right-hand module), see Table 4.6.1. The user software can address these ranges by bits or by words (see Fig. 4.6.6).

When using two 07 ZB 60 couplers or one 07 ZB 60 coupler and one 07 ZB 69 couplers respectively, the coupler range 1 of the line (or ring) is assigned to the left-hand module and the coupler range 2 of the line (or ring) is assigned to the right-hand module.

Operand	Meaning
E' 0000,00 ... 0501,15	Inputs in coupler range 1 of the line (or ring)
A' 0008,00 ... 0501,15	Outputs in coupler range 1 of the line (or ring)
EW' 0000,00 ... 0501,00	Word inputs in coupler range 1 of the line (or ring)
AW' 0008,00 ... 0501,00	Word outputs in coupler range 1 of the line (or ring)
E' 1024,00 ... 1525,15	Inputs in coupler range 2 of the line (or ring)
A' 1032,00 ... 1525,15	Outputs in coupler range 2 of the line (or ring)
EW' 1024,00 ... 1525,00	Word inputs in coupler range 2 of the line (or ring)
AW' 1032,00 ... 1525,00	Word outputs in coupler range 2 of the line (or ring)

Table 4.6.1: Operands for coupler ranges

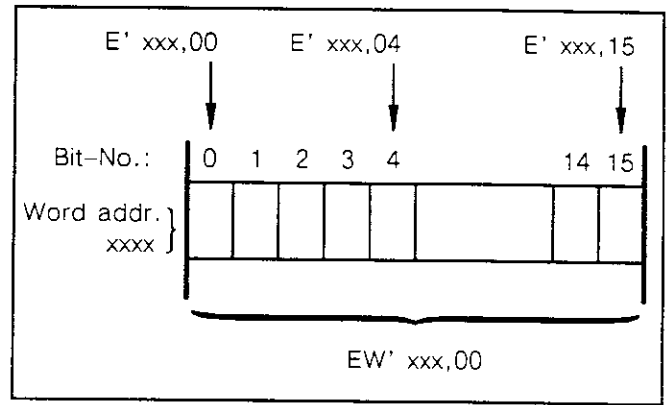

Fig. 4.6.6: Coupler ranges, that can be addressed both by bits and by words

The coupler ranges cannot be buffered. When the execution of a central station program is stopped (e.g. by setting the key switch to STOP) or at failure of a station, the last data written by this station are retained. When changing from STOP to RUN, all data of the coupler are initialized to 0.

The allocation between bit and word positions is found from the operand address. In this range both the inputs (E', EW') and the outputs (A', AW') refer to the same address. The distinction between E' and A' is necessary, in order to be able to distinguish between source and destination address during programming.

For process data transmission a coupler range must be set for each station, which may only be written to by this station (source); see also the description of the 907 PC 32 Test and Programming System, configuration of flag ranges. The entire coupler range can be read by all stations (sink).

When reading back programs with 907 PC 32 it must be noticed, that E'xx,xx is converted into A'xx,xx and EW'xx,xx is converted into AW'xx,xx in the back-read program.

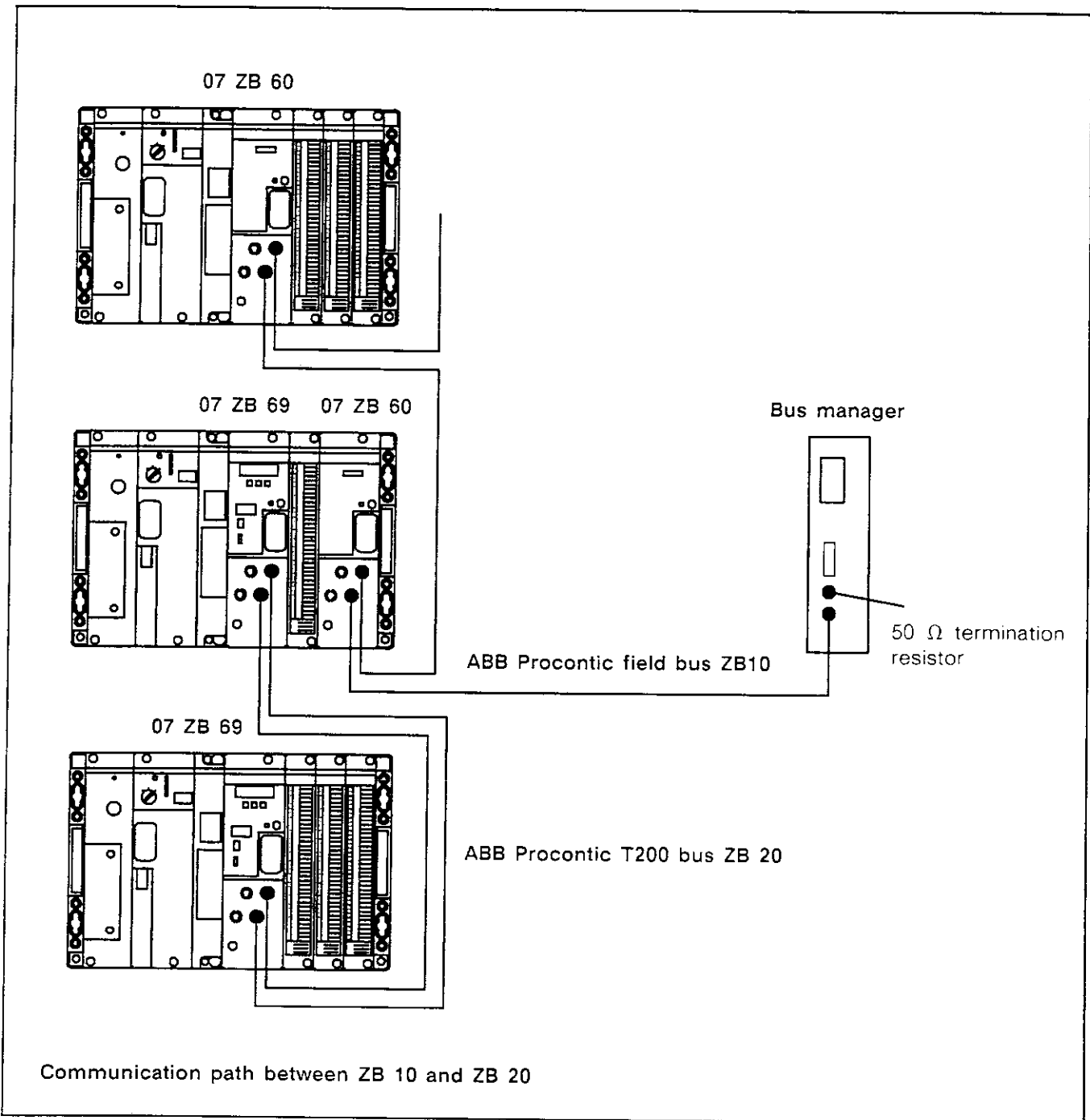

Fig. 4.6.7: Example for a networking with ZB10/ZB20

Structure of the image memory

Only complete telegrams can be marshalled, i.e., a minimum of two words per coupler has to be marshalled. The user must not write to the first 8 words of the coupler range.

Telegram No.		Procontic T200 address
0 low		EW'000,00
0 high		EW'001,00
1 low		EW'002,00
1 high		EW'003,00
2 low		EW'004,00
2 high		EW'005,00
3 low		EW'006,00
3 high		EW'007,00
4 low		EW//AW'008,00
4 high		EW//AW'009,00
5 low		EW//AW'010,00
5 high		EW//AW'011,00
6 low		EW//AW'012,00
6 high		EW//AW'013,00
7 low		EW//AW'014,00
7 high		EW//AW'015,00
250 low		EW//AW'500,00
250 high		EW//AW'501,00

Fig. 4.6.8: Structure of the image memory

Technical Data

max. number of 07 ZB 60 in one basic subrack
or sum of modules of 07 ZB 60 and 07 ZB 69

Size of the coupler range

max. number of I/O slots in the
basic subrack of the central station

Transmission speed

Data volume

Data security

Cycle time

Connecting cable

Connectors

Distance

Signalling

Current consumption from internal voltages
UB1 = 5 V DC
UB4 = 24 V DC

Total power dissipation

Number of required slots

Configuration identifier in 907 PC 32

Ability of fitting in subracks

slot,
●-● = plug-in is possible (occupies 2 slots)

Weight

Order number 07 ZB 60 R1 (TRIAX)

07 ZB 60 R1

2

2

500 words per ZB 10 line ¹⁾

6

150 kbits/s

250 data source telegrams to the ZB 10,
Monitoring of 250 data source telegrams from ZB 10,
i.e. the coupler can transfer the complete data image
of the ZB 10,
one ZB 10 telegram occupies 32 bits
Hamming distance $d = 4$ due to CRC Code
see Chapter 4 in:
ABB Procontic Field Bus ZB 10, Planning,
Order No. GATS 1350 02 R2001

TRIAX cable, characteristic impedance 50 Ω
BNC sockets

max. 1500 m, when TRIAX and 10 couplers/stations
3 LEDs (see Fig. 4.6.3)

max. 0.6 A
no current consumption

max. 4 W

2 I/O slots

ZB60 (entered for right slot number)

BT			BE central			BE remote		
NG	ZE	I/O	NG	BV	I/O	NG	BV	I/O
		●-●						

approx. 850 g

GJR5240200R1

Accessories (not supplied):

Component	Designations (remarks)
TRIAX cable	50 Ω Triax cable higher EMC, Type 9222 or Type 9888 Manufacturer: Belden Electronics, Fuggerstr. 2 W-4040 Neuss 1
TRIAX cable	50 Ω Triax cable higher EMC, Type 43V 616/310 Manufacturer: Letronic - Dieter Ley Radeberger Str. 4 W-6800 Mannheim 31
BNC plug	Crimp plug for 9222 or 43V 616/310 Suhner 11BNC-50-3-4c Rosenberger 51 S 101-106 A1

¹⁾ 1 word occupies 16 bits

BNC plug

X-type capacitor 0.1 μ F

Universal terminal,
Universal Protective Earth terminal

Crimp plug for 9888

Suhner 11BNC-50-7-7c

Manufacturer: RIFA, Sweden

Part No. PME 271 M 610

Suppliers: Industrial Electronics GmbH

Hauptstr. 71-79, W-6236 Eschborn

or EVOX-Rifa GmbH

Industriestr. 5, Postfach 1166

W-7707 Engen

Suppliers: C. A. Weidmüller GmbH & Co.

Postfach 950, W-4930 Detmold

or Phönix, Postfach 149

W-4933 Blomberg/Lippe

Error handling

The range (AW') which the coupler is meant to operate, must always begin with even numbers and terminate with odd numbers (see example in Fig. 4.6.2). If this regulation is not observed, the yellow LED "ERR1" will light up. However, the transmission still operates. The source data range is rounded up to complete ZB 10 telegrams.

If the source data ranges are beyond their limits, the red LED "ERR2" lights up:

AW' 0008,00 to AW' 0501,00
or AW' 1032,00 to AW' 1525,00

Diagnosis and monitoring

The 07 ZB 60 coupler supports (with certain restrictions) all diagnosis, display and monitoring functions of the bus controllers 07 ZV 80, 07 ZV 86 as well as of the 930 PC 30 programming and diagnosis software for the ZB 10 field bus.

With regard to the diagnosis software there are the following restrictions:

- Only in a particular configuration the "Search of Sink" function on the coupler is supported.
- The same is valid for the "Cross Link Check" carried out by the bus controller.

The above mentioned functions are only supported, when the coupler range (source address range) for the

ABB Procontic T200 begins at the lowest AW' values permitted (AW' 0008,00 or AW' 1032,00 respectively).

However, both function and security of the ZB 10 are still guaranteed in all configurations. The safety-oriented monitoring of the networked stations is always carried out. An error message is always sent, if a station does not respond.

So it is possible to construct "Cross Link" monitored ZB 10 lines, when one 07 ZB 10 coupler is used together with couplers of other types.

If a ZB 10 line includes more than one 07 ZB 60 coupler, the monitoring of the "Cross Link" is not applicable.

The mentioned restrictions occur due to the fact, that from the point of view of the bus controller and the diagnosis software each coupler must have a defined address which is stored in the coupler.

In case of the 07 ZB 60 coupler this is the address 4. If a deviating address for the source address range is entered in the 907 PC 32 programming software (which is possible), the previously mentioned functions cannot operate.

A "LOW CRC" error might be displayed, while reading the marshalling list from the coupler by the 930 PC 30 software. This display does not affect the function and has to be acknowledged. A "TYPE ED 1685" message can be ignored.

This software can only be used as diagnosis software for the 07 ZB 60 coupler.

Marshalling of the 07 ZB 60 is carried out via the 907 PC 32 programming software..

4.7 Coupler with TWINAX cable ²⁾ 07 ZB 60 R2 for connection to ABB Procontic field bus ZB 10

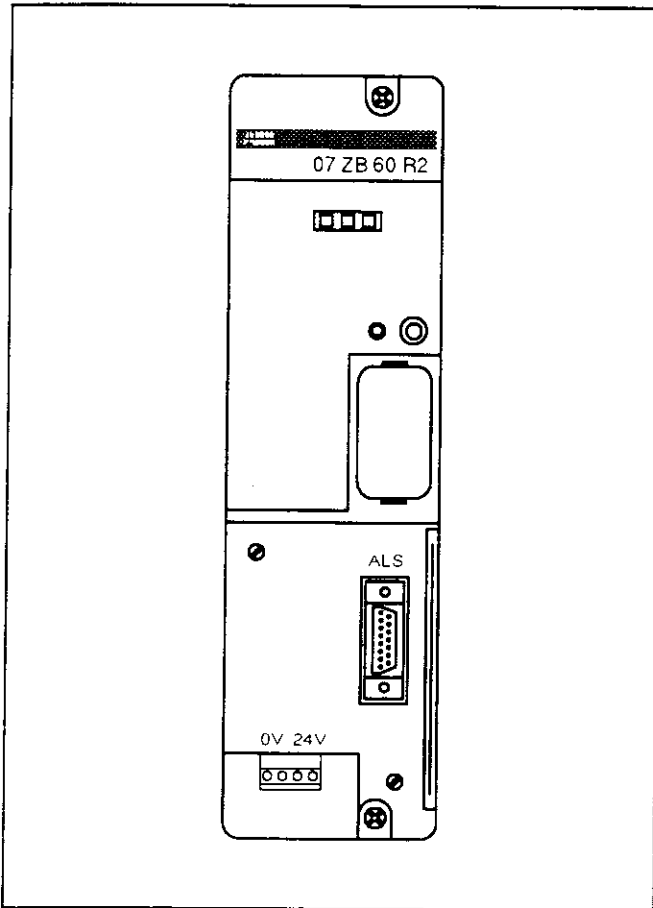

Fig. 4.7.1: Coupler 07 ZB 60 R2

Characteristics

Networking the ABB Procontic T200 control system with other ABB Procontic systems via the ABB Procontic field bus ZB 10 is possible, when using the 07 ZB 60 coupler (see Fig. 4.7.2).

In addition to this, each networked station can be expanded centrally and/or remotely (see descriptions of the 07 BV 60 bus connector and 07 BR 60/61 couplers).

A maximum of two 07 ZB 60 couplers can be employed on a basic subrack; in doing so, two ZB 10 lines with up to 250 stations can be achieved. It is also possible to use one ZB 10 coupler and one ZB 20 coupler in the same station and thus to create a data transmission path between ZB 10 and ZB 20 (see Fig. 4.7.7).

The transmission of the process data is carried out via operands for the coupler ranges. These can be addressed in bits or in words. The consistency of 16-bit data is guaranteed.

1) TRIAX = double shielded coaxial cable

2) TWINAX = twin axial cable (2-core, twisted and shielded high-frequency data transmission line)

3) see description of coupler 07 ZB 60 R1, starting on page 4.6-1

Module Description

The module consists of a housing with a removable transparent front cover for the display and operating elements and a connector block, which can be unscrewed, with a 15-pole female SUB-D connector for coupling further ZB 10 couplers (via ranging unit) and terminals for external 24 V supply.

LEDs are provided for signalling the ready status for operation and errors.

Project Planning

The 07 ZB 60 couplers can only be employed in basic subracks (BT). The positioning sequence of the couplers determines the number of the ZB 10 line (1 or 2). With two couplers the left 07 ZB 60 is given the number 1, corresponding to ZB 10 line 1.

Commercially available TWINAX cable ²⁾ is used as data transmission line for the networking.

If it is desired to configure the ZB 10 networking by means of TRIAX cable ¹⁾, the coupler 07 ZB 60 R1 ³⁾ is to be used.

Comprehensive diagnostic facilities of the bus controller allow for simple monitoring and error detection both during commissioning and in operation. Marshalling of source addresses is carried out in words by the programming software 907 PC 32. EPROMs for marshalling are not necessary.

Hardware and planning with the ABB Procontic field bus ZB 10 are described in detail in the following publications:

English:

ABB Procontic Field Bus ZB 10, Hardware,
Order No. GATS 1350 01 R2001

ABB Procontic Field Bus ZB 10, Planning,
Order No. GATS 1350 02 R2001

German:

ABB Procontic Feldbus ZB 10, Hardware,
Bestell-Nr. GATS 1350 01 R1001

ABB Procontic Feldbus ZB 10, Projektierung,
Bestell-Nr. GATS 1350 02 R1001

Central station No. 1

I/O slot No. 0 1 2 3 4 5 6 7

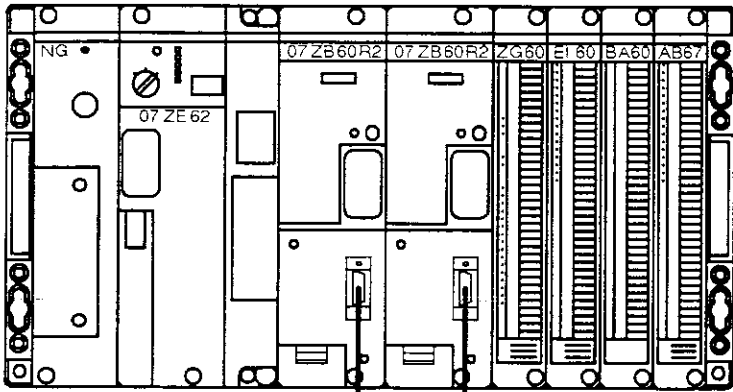

89 IZ 20 system cables

The TWINAX cables are terminated by a 124 Ω resistor at both ends (see description 88 ZA 20, connecting configuration).

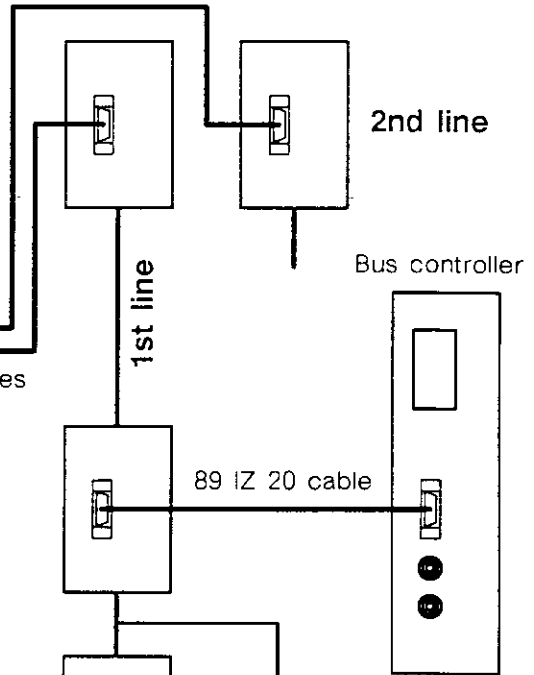

Central station No. 2

I/O slot No. 0 1 2 3 4

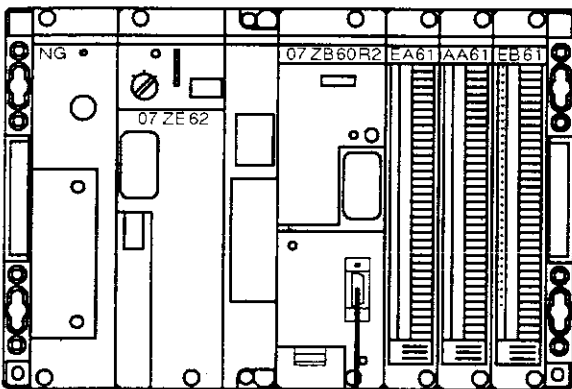

89 IZ 20 cable

89 IZ 20 cable

Connecting cables: TWINAX cable

Ranging unit 88 ZA 20

89 IZ 20 system cable

Central station No. 3

I/O slot No. 0 1

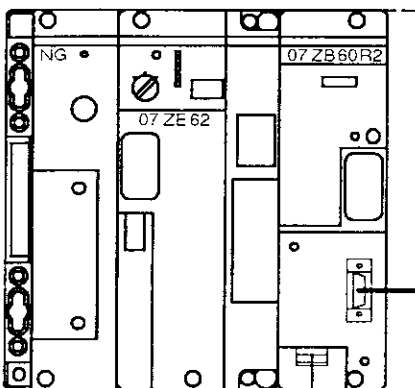

Coupler range line 1

Station 1	→	AW' 0008,00	[Coupler symbol]
		AW' 0011,00	
Station 2	→	AW' 0040,00	[Coupler symbol]
		AW' 0099,00	
Station 3	→	AW' 0500,00	[Coupler symbol]
		AW' 0501,00	

Coupler range line 2

Station 1	→	AW' 1040,00	[Coupler symbol]
		AW' 1090,00	

Via these terminals, all couplers 07 ZB 60 must be supplied from an external 24 V power supply unit.

Fig. 4.7.2: Example for a networking with 2 lines (line 1 shown with 3 central stations, 4 ranging units and the bus controller)

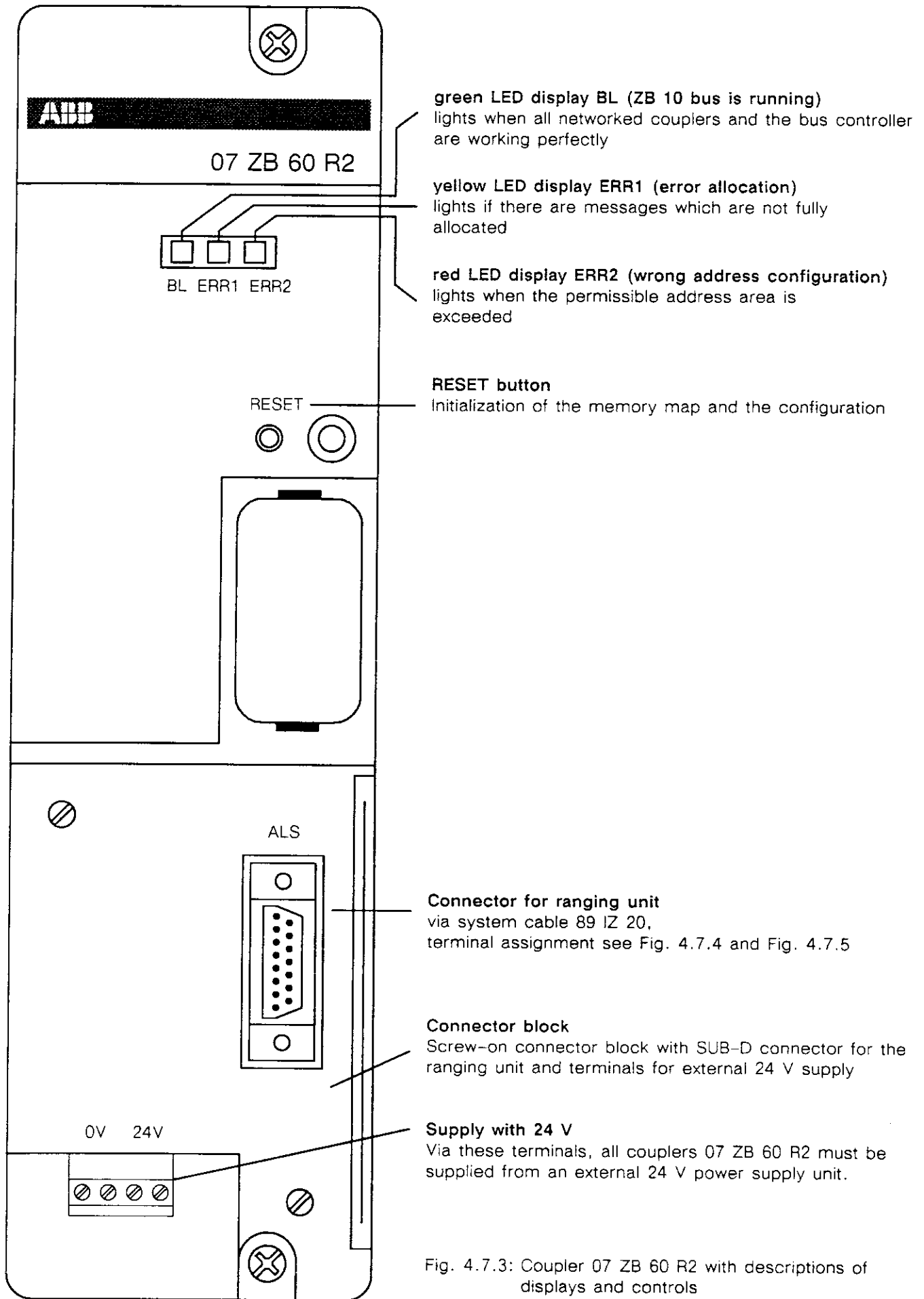

Fig. 4.7.3: Coupler 07 ZB 60 R2 with descriptions of displays and controls

Connection scheme

The connection between the couplers (or the bus controller) and the ranging units is established by 89 IZ 20 system cables. The ZB 10 bus is installed by means of TWINAX cable and runs between the ranging units (see Fig. 4.7.2).

The removable connector block allows a replacement of a defective coupler without breaking the bus line. If a coupler is to be replaced, the power supply unit of the station involved has to be switched off. The connector block is unscrewed and, without loosening the plug and the wires, the defective unit replaced by a new one, whose connector block has been removed before. The previous connector block can be reinstalled then.

The TWINAX cables are terminated by a 124 Ω resistor at both ends (see description 88 ZA 20, connecting configuration).

IMPORTANT:

When the supply voltage is switched on, i.e. during operation, neither the connector block nor the connecting leads may be removed.

General instructions

In general, the voltage supply to the subrack is to be switched off before inserting or removing couplers.

There are no restrictions on the power-up sequence of ABB Procontic T200 systems with ZB 10 couplers. Data transmission via the ZB 10 bus, however, does not start until the ZB 10 bus controller has been powered up.

The message BL (bus is running) will not appear, before all stations at the ZB 10 bus are working correctly.

For further information with regard to planning the ZB 10 field bus refer to the publication

ABB Procontic Field Bus ZB 10, Planning,
Order No. GATS 1350 02 R2001

Terminal assignment of the connector for the ranging unit

The data transmission between station (coupler, bus controller) and ranging unit is performed via the 89 IZ 20 system cable. Furthermore, each station supplies its connected ranging unit with 24 V and 5 V voltages through this cable.

As a protection against interference the data are transmitted with drivers and receivers according to RS-422 specification. Signal (A) and signal (B) represent inverted states to each other. The 89 IZ 20 interface contains two pairs of wires (S1 and S2) in sending direction with the following meaning:

S1	S2	Meaning
0	0	Transmitter inactive (does not force the bus)
0	1	0 signal at the bus
1	0	1 signal at the bus
1	1	non-allowable condition

The terminal assignment of the 15-pole female plugs is shown in the following Figures 4.7.4 und 4.7.5.

Signal name	Pin No.	Meaning
S1 (A), S1 (B)	2, 9	Sending signal 1, at logic 0 during transmission interval
S2 (A), S2 (B)	3, 10	Sending signal 2, during transmission as inverse of S1. During transmission intervals at logic 0.
E1 (A), E1 (B)	4, 11	Received signal. During transmission the sending signal S1 appears on E1. During pauses normally permanent logic 0 or logic 1.
VP	6	Supply voltage 24 V (19,2...31,2 V)
Frei	13	for test purposes only
VS	7, 14	Supply voltage 5 V ± 5 %
BP	8, 15	Reference earth, 0 V

Fig. 4.7.4: Meaning of the signals

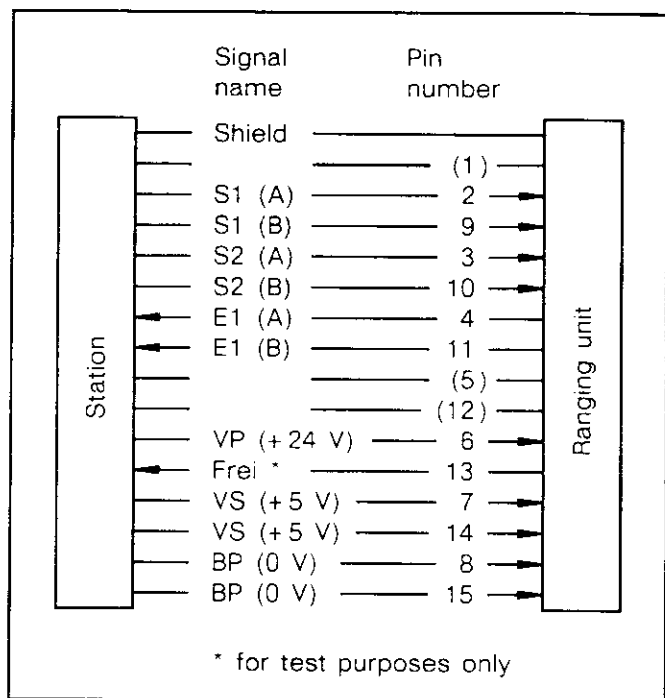

Fig. 4.7.5: Interfaces of station and ranging unit

Software Instructions

Coupler ranges

Process data are transmitted via the ZB 10 by means of operands for the coupler range 1 (left-hand module) and the coupler range 2 (right-hand module), see Table 4.7.1. The user software can address these ranges by bits or by words (see Fig. 4.7.6).

When using two 07 ZB 60 couplers or one 07 ZB 60 coupler and one 07 ZB 69 coupler respectively, the coupler range 1 of the line (or ring) is assigned to the left-hand module and the coupler range 2 of the line (or ring) is assigned to the right-hand module.

Operand	Meaning
E' 0000,00 ... 0501,15	Inputs in coupler range 1 of the line (or ring)
A' 0008,00 ... 0501,15	Outputs in coupler range 1 of the line (or ring)
EW' 0000,00 ... 0501,00	Word inputs in coupler range 1 of the line (or ring)
AW' 0008,00 ... 0501,00	Word outputs in coupler range 1 of the line (or ring)
E' 1024,00 ... 1525,15	Inputs in coupler range 2 of the line (or ring)
A' 1032,00 ... 1525,15	Outputs in coupler range 2 of the line (or ring)
EW' 1024,00 ... 1525,00	Word inputs in coupler range 2 of the line (or ring)
AW' 1032,00 ... 1525,00	Word outputs in coupler range 2 of the line (or ring)

Table 4.7.1: Operands for coupler ranges

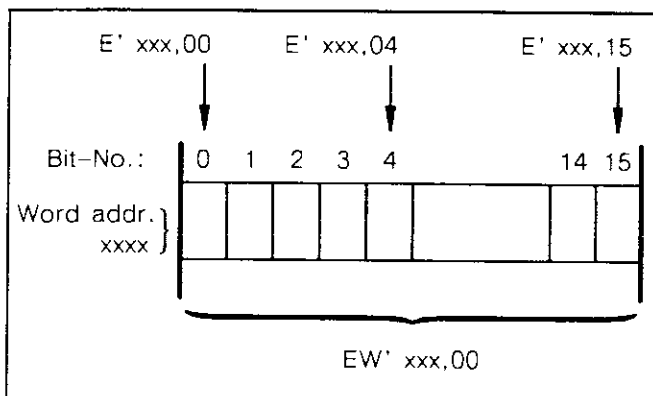

Fig. 4.7.6: Coupler ranges, that can be addressed both by bits and by words

The coupler ranges cannot be buffered. When the execution of a central station program is stopped (e.g. by setting the key switch to STOP) or at failure of a station, the last data written by this station are retained. When changing from STOP to RUN, all data of the coupler are initialized to 0.

The allocation between bit and word positions is found from the operand address. In this range both the inputs (E', EW') and the outputs (A', AW') refer to the same address. The distinction between E' and A' is necessary, in order to be able to distinguish between source and destination address during programming.

For process data transmission a coupler range must be set for each station, which may only be written to by this station (source); see also the description of the 907 PC 32 Test and Programming System, configuration of flag ranges. The entire coupler range can be read by all stations (sink).

When reading back programs with 907 PC 32 it must be noticed, that E'xx,xx is converted into A'xx,xx and EW'xx,xx is converted into AW'xx,xx in the back-read program.

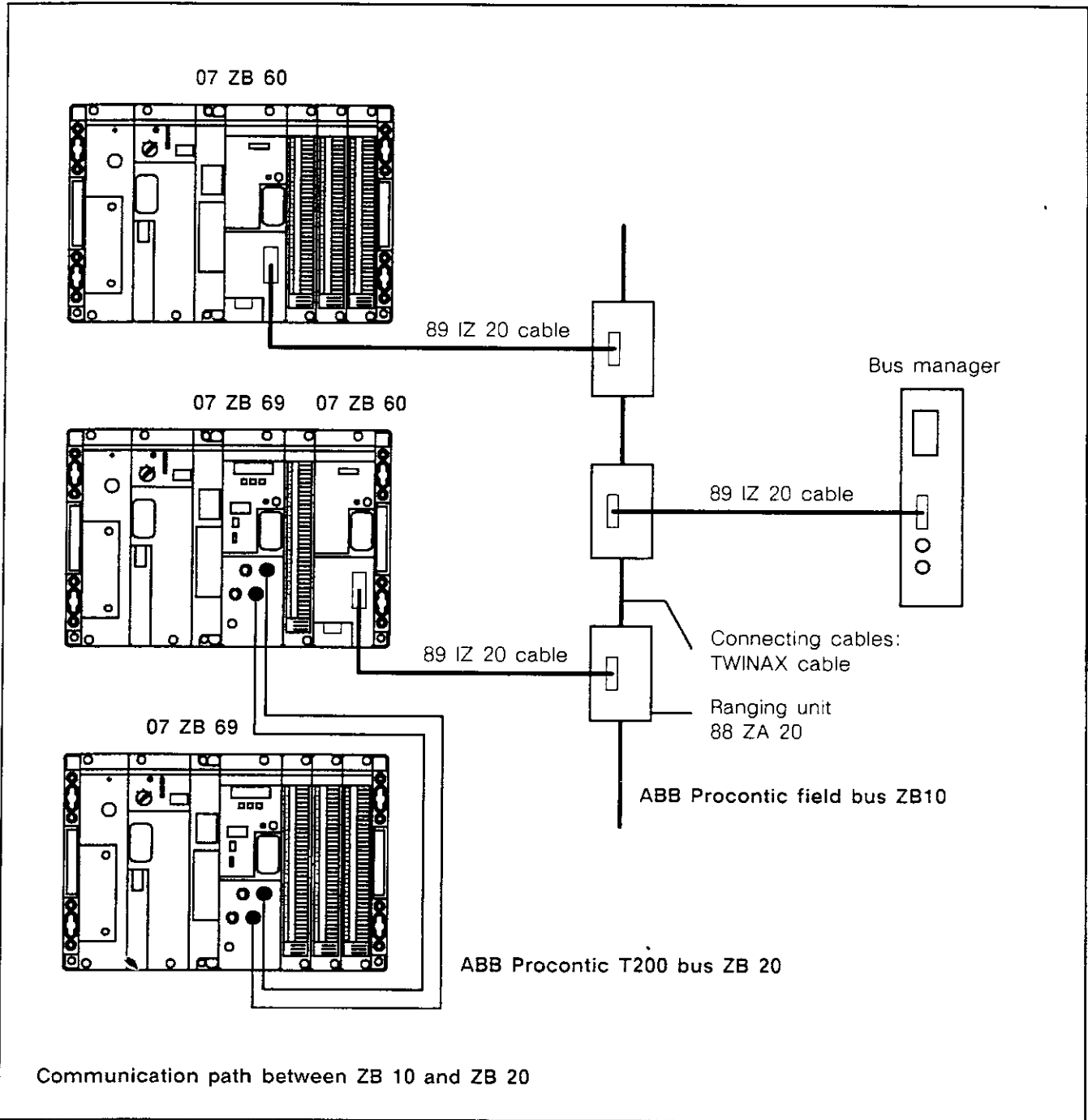

Fig. 4.7.7: Example for a networking with ZB10/ZB20

Structure of the image memory

Only complete telegrams can be marshalled, i.e., a minimum of two words per coupler has to be marshalled. The user must not write to the first 8 words of the coupler range.

Telegram No.		Procontic T200 address
0 low		EW'000,00
0 high		EW'001,00
1 low		EW'002,00
1 high		EW'003,00
2 low		EW'004,00
2 high		EW'005,00
3 low		EW'006,00
3 high		EW'007,00
4 low		EW'/AW'008,00
4 high		EW'/AW'009,00
5 low		EW'/AW'010,00
5 high		EW'/AW'011,00
6 low		EW'/AW'012,00
6 high		EW'/AW'013,00
7 low		EW'/AW'014,00
7 high		EW'/AW'015,00
250 low		EW'/AW'500,00
250 high		EW'/AW'501,00

Fig. 4.7.8: Structure of the image memory

Technical Data

max. number of 07 ZB 60 in one basic subrack
or sum of modules of 07 ZB 60 and 07 ZB 69

Size of the coupler range

max. number of I/O slots in the
basic subrack of the central station

Transmission speed

Data volume

Data security

Cycle time

Connecting cable

Connector

Distance

Signalling

Current consumption from internal voltages

UB1 = 5 V DC

UB4 = 24 V DC

Current consumption from external voltage

UB_{ext} = 24 V DC (19.2...31.3 V DC)

Total power dissipation

Number of required slots

Configuration identifier in 907 PC 32

Ability of fitting in subracks

slot,

●--● = plug-in is possible (occupies 2 slots)

Weight

Order number 07 ZB 60 R2 (TWINAX)

07 ZB 60 R2

2

2

500 words per ZB 10 line 1)

6

150 kbits/s

250 data source telegrams to the ZB 10,

Monitoring of 250 data source telegrams from ZB 10,
i.e. the coupler can transfer the complete data image
of the ZB 10,

one ZB 10 telegram occupies 32 bits

Hamming distance $d = 4$ due to CRC Code

see Chapter 4 in:

ABB Procontic Field Bus ZB 10, Planning,

Order No. GATS 1350 02 R2001

TWINAX cable, characteristic impedance 124 Ω

15-pole interface for ranging unit 88 ZA 20

max. 1000 m, when TWINAX and 50 couplers/stations

3 LEDs (see Fig. 4.7.3)

max. 0.6 A

no current consumption

max. 0.15 A

max. 4 W

2 I/O slots

ZB60 (entered for right slot number)

BT			BE central			BE remote		
NG	ZE	I/O	NG	BV	I/O	NG	BV	I/O
		●--●						

approx. 850 g

GJR5240200R2

Accessories (not supplied):

Component		Designations (remarks)
TWINAX cable	(GKWN 000065P0001)	TWINAX cable, characteristic impedance 124 Ω Manufacturer: AEG Type 44BB628
88 ZA 20 R1	(GJR2 347100 R1)	ranging unit for TWINAX cable
89 IZ 20 R1000	(GJR2 362600 R1000)	system cable for connection between 07 ZB 60 R2 and the 88 ZA 20 ranging unit, length = 1 m
89 IZ 20 R3000	(GJR2 362600 R3000)	system cable for connection between 07 ZB 60 R2 and the 88 ZA 20 ranging unit, length = 3 m

1) 1 word occupies 16 bits

Error handling

The range (AW') which the coupler is meant to operate, must always begin with even numbers and terminate with odd numbers (see example in Fig. 4.7.2). If this regulation is not observed, the yellow LED "ERR1" will light up. However, the transmission still operates. The source data range is rounded up to complete ZB 10 telegrams.

If the source data ranges are beyond their limits, the red LED "ERR2" lights up:

AW' 0008,00 to AW' 0501,00
or AW' 1032,00 to AW' 1525,00

Diagnosis and monitoring

The 07 ZB 60 coupler supports (with certain restrictions) all diagnosis, display and monitoring functions of the bus controllers 07 ZV 80, 07 ZV 86 as well as of the 930 PC 30 programming and diagnosis software for the ZB 10 field bus.

With regard to the diagnosis software there are the following restrictions:

- Only in a particular configuration the "Search of Sink" function on the coupler is supported.
- The same is valid for the "Cross Link Check" carried out by the bus controller.

The above mentioned functions are only supported, when the coupler range (source address range) for the

ABB Procontic T200 begins at the lowest AW' values permitted (AW' 0008,00 or AW' 1032,00 respectively).

However, both function and security of the ZB 10 are still guaranteed in all configurations. The safety-oriented monitoring of the networked stations is always carried out. An error message is always sent, if a station does not respond.

So it is possible to construct "Cross Link" monitored ZB 10 lines, when one 07 ZB 10 coupler is used together with couplers of other types.

If a ZB 10 line includes more than one 07 ZB 60 coupler, the monitoring of the "Cross Link" is not applicable.

The mentioned restrictions occur due to the fact, that from the point of view of the bus controller and the diagnosis software each coupler must have a defined address which is stored in the coupler.

In case of the 07 ZB 60 coupler this is the address 4. If a deviating address for the source address range is entered in the 907 PC 32 programming software (which is possible), the previously mentioned functions cannot operate.

A "LOW CRC" error might be displayed, while reading the marshalling list from the coupler by the 930 PC 30 software. This display does not affect the function and has to be acknowledged. A "TYPE ED 1685" message can be ignored.

This software can only be used as diagnosis software for the 07 ZB 60 coupler.

Marshalling of the 07 ZB 60 is carried out via the 907 PC 32 programming software..

4.8 Coupler with Triaxial Cable 1) 07 ZB 69 R1 for connection to ZB 20 bus

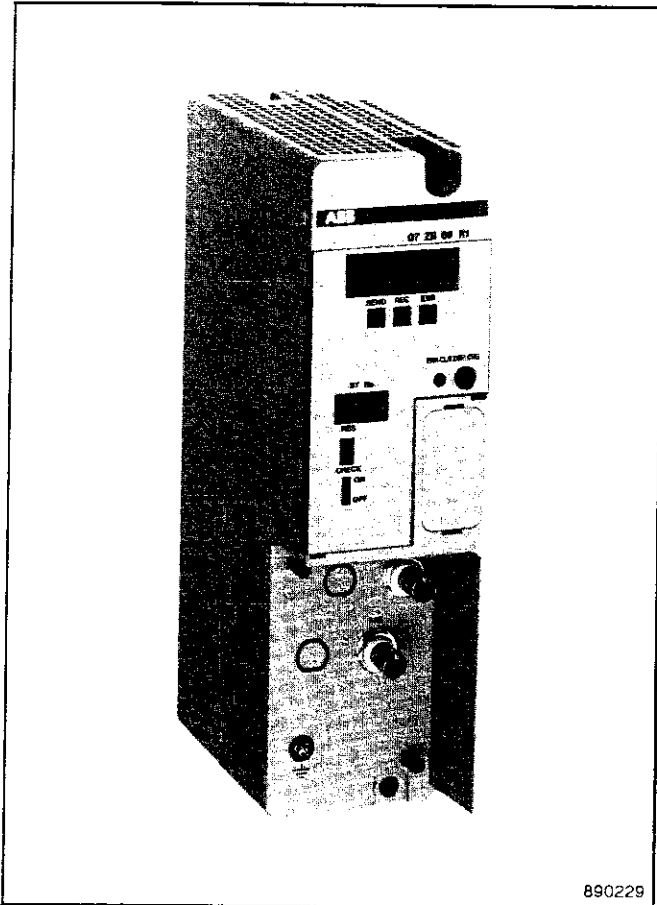

Fig. 4.8.1: Coupler 07 ZB 69 for connection to ZB20

Characteristics

Using coupler 07 ZB 69, networking is possible via the ABB Procontic T200 bus, the ZB 20 (see Fig. 4.8.2). This makes it possible to network ABB Procontic T200 controller systems with process-oriented signal cabling. The distance between stations can be up to 500 m (triaxial cable) or up to 2 km (optical fibre ²⁾. The maximum possible overall length of the ring is 1 km (triaxial cable) or 15 km (optical fibre ²⁾. Each station can in turn be centrally or remotely expanded.

Process data are transmitted via the ZB 20 by means of operands for the coupler ranges. These can be addressed by bit or by word.

With a programming unit connected to the central unit of a central station, every other central unit on the network can be programmed or remotely controlled (e.g. START, STOP) via the ZB 20. Status inquiries can also be carried out, except 'General Reset'. A maximum of 4 programming units can be connected to a ZB 20 networked system simultaneously.

A maximum of two 07 ZB 69 couplers per basic subrack can be installed. Using this concept two ZB 20 rings with up to 64 stations each can be constructed (see Fig. 4.8.2).

It is also possible to use one 07 ZB 69 coupler and one 07 ZB 60 coupler in the same basic subrack and thus to create a data transmission path between the ABB Procontic T200 bus (ZB20) and the ABB Procontic field bus ZB10 (see Fig. 4.8.6).

Module Description

The module consists of the housing with removable transparent front covering for the display and operating elements and a screw-on connector block with BNC sockets for connection to further ZB 20 couplers and a grounding screw.

A 7-segment display and light-emitting diodes are provided for signalling ready status for operation and errors. Further pushbuttons and switches are provided for testing and operating the module (see Fig. 4.8.3).

Project Planning

The 07 ZB 69 couplers for the ZB 20 can be used only in the basic subrack (BT). The positioning sequence of the modules in the basic subrack determines the numbers in the ZB 20 ring (1 or 2). With two couplers the left 07 ZB 69 module is given the number 1, corresponding to ZB 20 ring 1.

The connections between the couplers are made either with commercially available triaxial cable or with optical fibres ²⁾.

Comprehensive diagnostic facilities allow for simple monitoring and fault detection both during commissioning and in operation.

1) double shielded coaxial cable

2) see description of coupler 07 ZB 69 R2, starting on page 4.9-1

Central station No. 00 (master station) for both rings

I/O slot No. 0 1 2 3 4 5 6 7

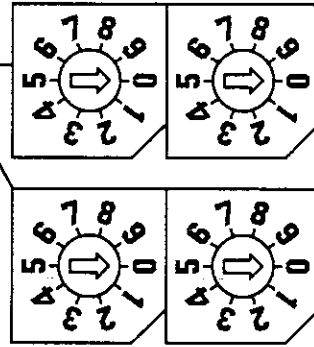
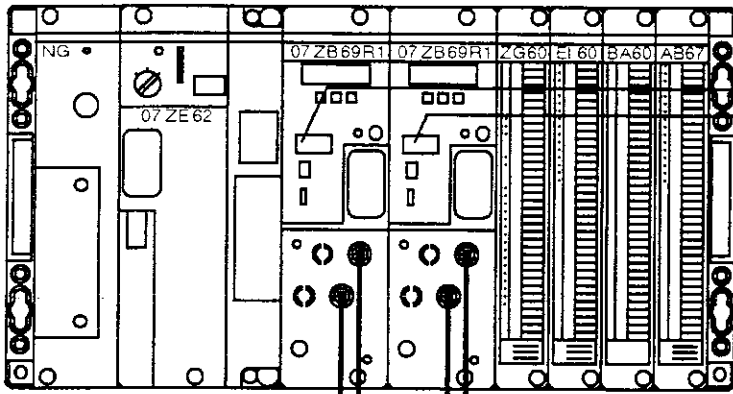

ZB 20 ring 1

ZB 20 ring 2

Connecting cables:
TRIAx cable

Central station No. 01, ring 1

I/O slot No. 0 1 2 3 4

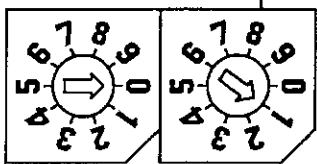
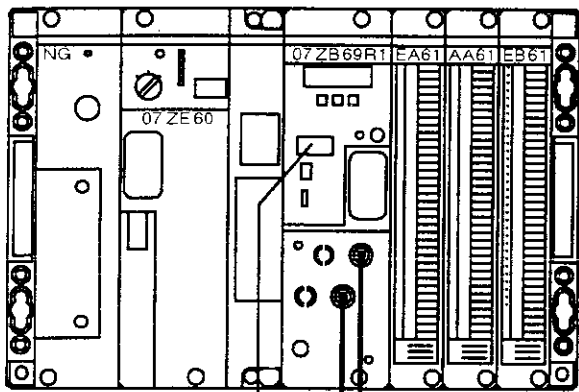

Central station No. 01, ring 2

I/O slot No. 0 1 2 3 4

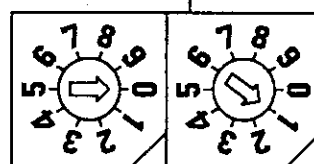
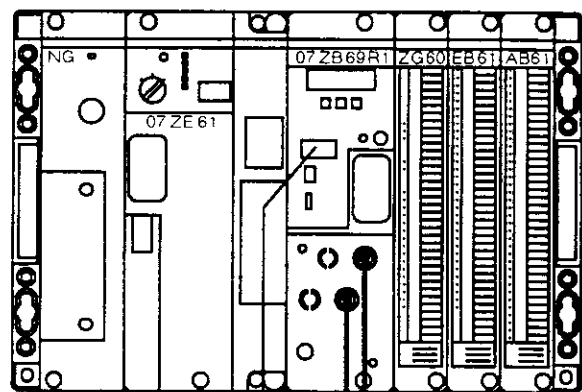

Central station No. 02, ring 1

I/O slot No. 0 1 2 3 4

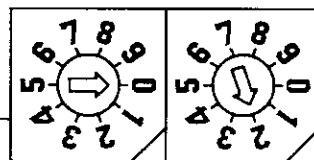
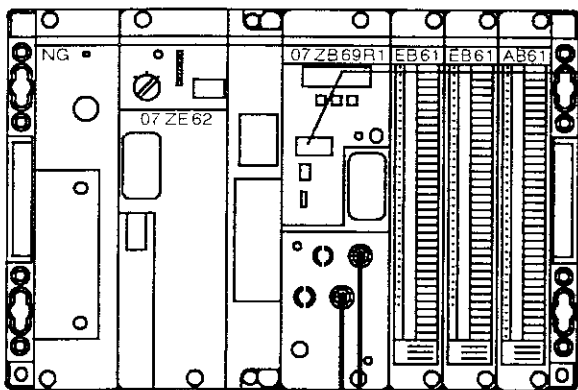

The setting of station numbers for the couplers are examples. Couplers with the setting 00 define the central station in which they are located to the master central station of the ring concerned.

- Maximal expansion possible with ZB 20 networking:
- 2 rings per central station
 - 64 central stations per ring (setting 00...63)
 - 500 m distance between two stations
 - 1000 m overall length of ring

Fig. 4.8.2: Configuration of a ZB20 networking

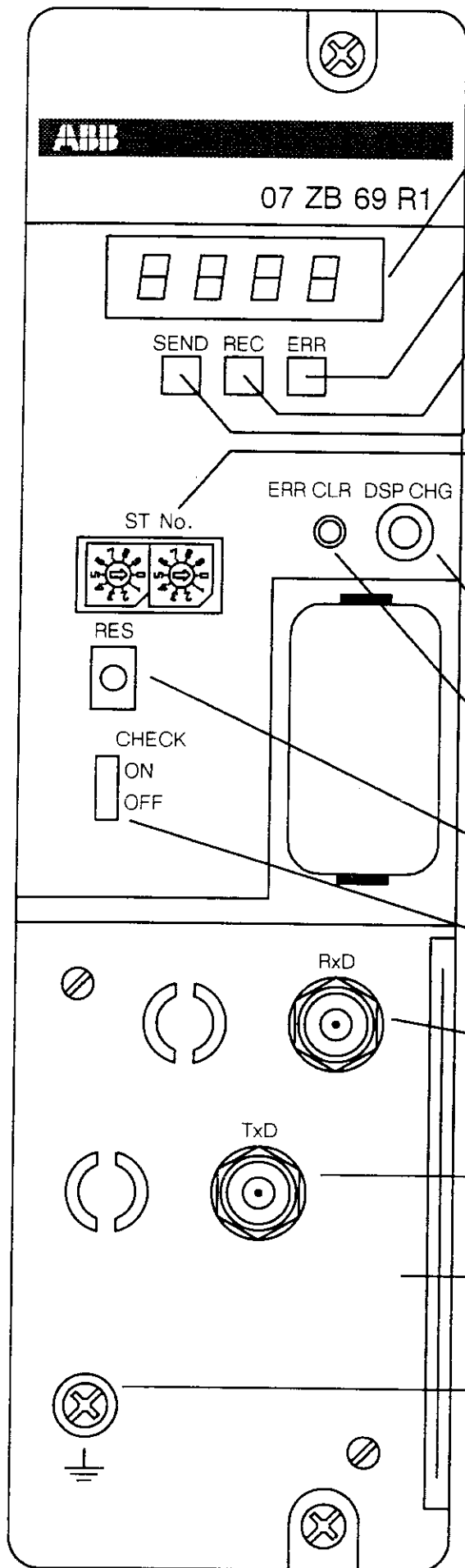

7-segment display

4-digit display of operational condition. During error-free operation the display indicates 0000; for error conditions see detailed error table.

ERR (Error display)

illuminates when data transmission is interrupted after occurrence of an error

REC (Receive Data display)

Flashes during reception of data by the 07 ZB 69

Send (Send Data display)

Flashes during transmission of data by the 07 ZB 69

ST No. (Station Number rotary switch)

Selection switch for setting the station number (00...63). The righthand rotary switch sets the units digits, the left-hand switch sets the tens digits (decimal setting). Settings that are too large are indicated as error E8. The setting does not become effective until after powering-up.

DSP CHG (Display Change button)

Switches to display further error numbers when more than one error is present

ERR CLR (Error Clear button)

Erases the error number on the 7-segment display

RES (Reset button)

Resets the coupler; must not be used while in RUN mode

CHECK (Check Mode DIL switch)

Selection switch for testing in send or receive directions

RxD (Receive Data connector)

BNC connector for triaxial cable; has to be connected to the TxD connector of ZB 20 coupler of previous station

TxD (Transmit Data connector)

BNC connector for triaxial cable; has to be connected to the RxD connector of ZB 20 coupler of next station

Connector block

Screw-on connector block with BNC sockets for connecting triaxial cable, also includes grounding screw

Grounding screw

The grounding screw has to be connected to the ground connection of the subrack

Fig. 4.8.3: Module 07 ZB 69 R1 with descriptions of displays and controls

Connection scheme

Connections to further ZB 20 couplers are made with triaxial cable. The TxD connectors of the 07 ZB 69 coupler are connected to the RxD connectors of the coupler of the next station and the RxD connectors of the 07 ZB 69 to the TxD connectors of the coupler of the previous station (see Table 4.8.2). If the connection between the couplers is broken or if there is a false connection, this is detected by the coupler and the corresponding error number issued.

The removable connector block of the couplers has "bypass structure", i.e. if the supply voltage to another station is switched off, the ZB 20 ring is not interrupted. In such an operational condition the bus connection is bridged over by integrated relays. The bus need therefore not be disconnected when replacing a defective ZB 20 coupler. The voltage supply to the defective station needs only be switched off, the connector block unscrewed, the defective module replaced and the connector block reinstalled.

IMPORTANT:

When the supply voltage is switched on, i.e. during operation, neither the connector block nor the connecting leads may be removed.

General Instructions

In general the voltage supply to the subrack should be switched off before inserting or removing couplers.

Screw-on connector blocks of couplers labeled with R2 (optical fibre connection) must neither be replaced with connector blocks of couplers labeled with R1 (triaxial connection) nor in the reverse case.

There are no restrictions on the power-up sequence of ABB Procontic T200 systems with ZB 20 couplers. Data transmission via the ZB 20 does not however begin until powering-up of the "master station", i.e. the central station whose station number is 00, set on the 07 ZB 69 coupler.

On commissioning, the supply voltage to the other stations should be switched on before that to the master station. If a duplicated station number has been set, error E6 will be signalled at the central unit.

With a programming unit connected to the central unit of a central station, every other central unit on the ZB 20 network can be remotely programmed or controlled (e.g. START, STOP) via the ZB 20. Status inquiries can also be carried out. A maximum of 4 programming units can be connected to a ZB 20 networked system simultaneously.

The function 'General Reset' may not be performed via a ZB 20 network.

Software Instructions

Coupler ranges

Process data are transmitted via the ZB 20 by means of operands for the coupler ranges (Table 4.8.1). These can be addressed by bits or by words (see Fig. 4.8.4).

When using two 07 ZB 69 couplers or one 07 ZB 69 coupler and one 07 ZB 60 coupler respectively, the coupler range 1 of the ring (or line) is assigned to the left-hand module and the coupler range 2 of the ring (or line) is assigned to the right-hand module.

The coupler ranges cannot be buffered. When the execution of a central station program is stopped (e.g. by setting the key switch to STOP) or at failure of a station, the last data written by this station are retained.

Operand	Meaning
E' 0000,00 ... 1023,15	Inputs in coupler range 1 of the ring (or line)
A' 0000,00 ... 1023,15	Outputs in coupler range 1 of the ring (or line)
EW' 0000,00 ... 1023,00	Word inputs in coupler range 1 of the ring (or line)
AW' 0000,00 ... 1023,00	Word outputs in coupler range 1 of the ring (or line)
E' 1024,00 ... 2047,15	Inputs in coupler range 2 of the ring (or line)
A' 1024,00 ... 2047,15	Outputs in coupler range 2 of the ring (or line)
EW' 1024,00 ... 2047,00	Word inputs in coupler range 2 of the ring (or line)
AW' 1024,00 ... 2047,00	Word outputs in coupler range 2 of the ring (or line)

Table 4.8.1: Operands for coupler ranges

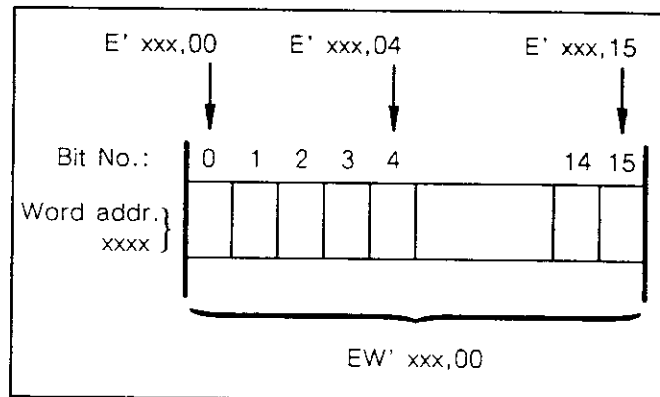

Fig. 4.8.4: Coupler ranges, that can be addressed both by bits and by words

The allocation between bit and word positions is found from the operand address. In this range both the inputs (E', EW') and the outputs (A', AW') refer to the same address. The distinction between E' and A' is neces-

sary, in order to be able to distinguish between source and destination address during programming.

For process data transmission a coupler range must be set for each station, which may only be written to by this station (source); see also the description of the 907 PC 32 Test and Programming System, configura-

tion of flag ranges. The entire coupler range can be read by all stations (sink).

When reading back programs with 907 PC 32 it must be noticed, that E'xx,xx is converted into A'xx,xx and EW'xx,xx is converted into AW'xx,xx in the back-read program.

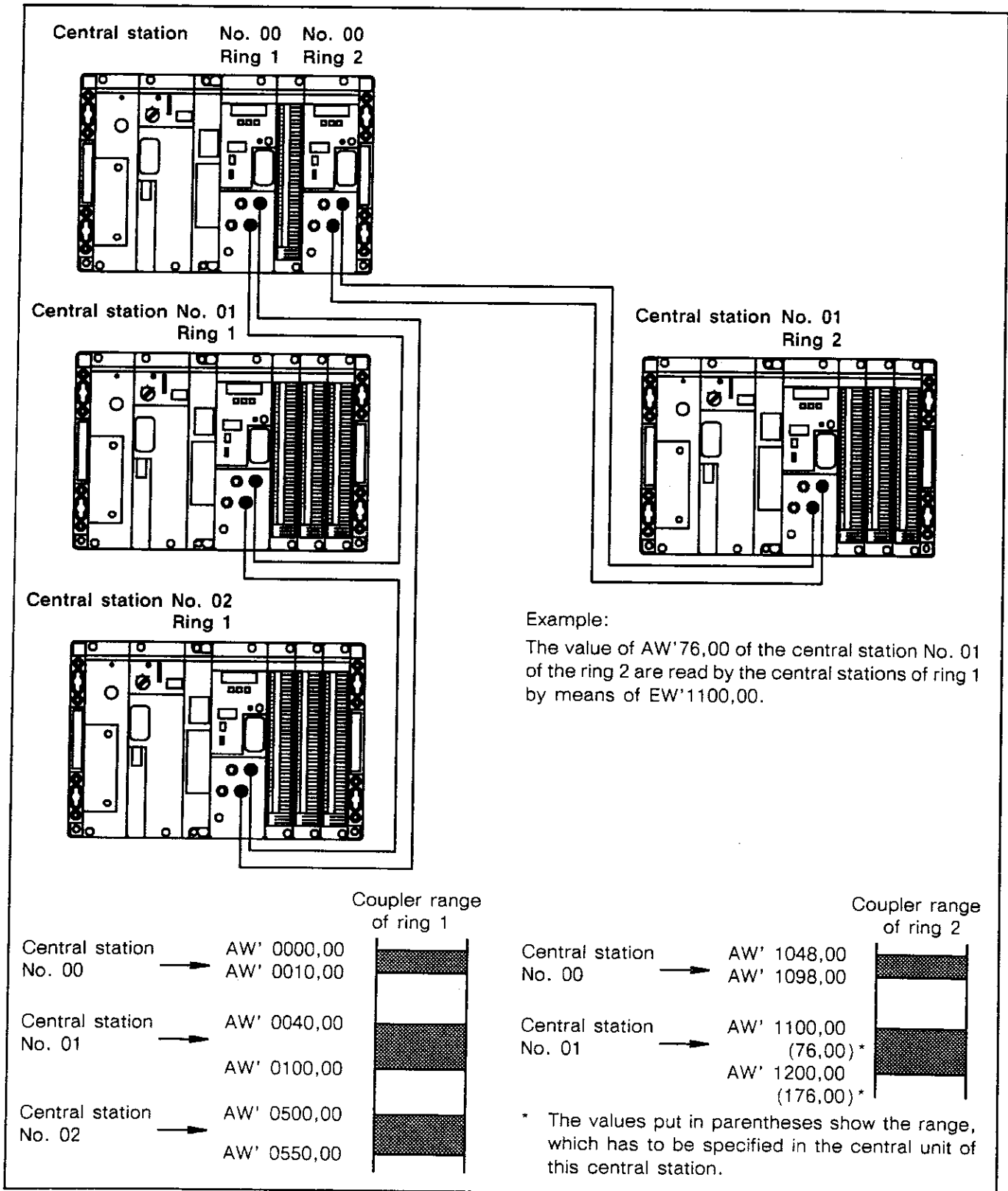

Fig. 4.8.5: Example for a ZB 20 networking with two rings

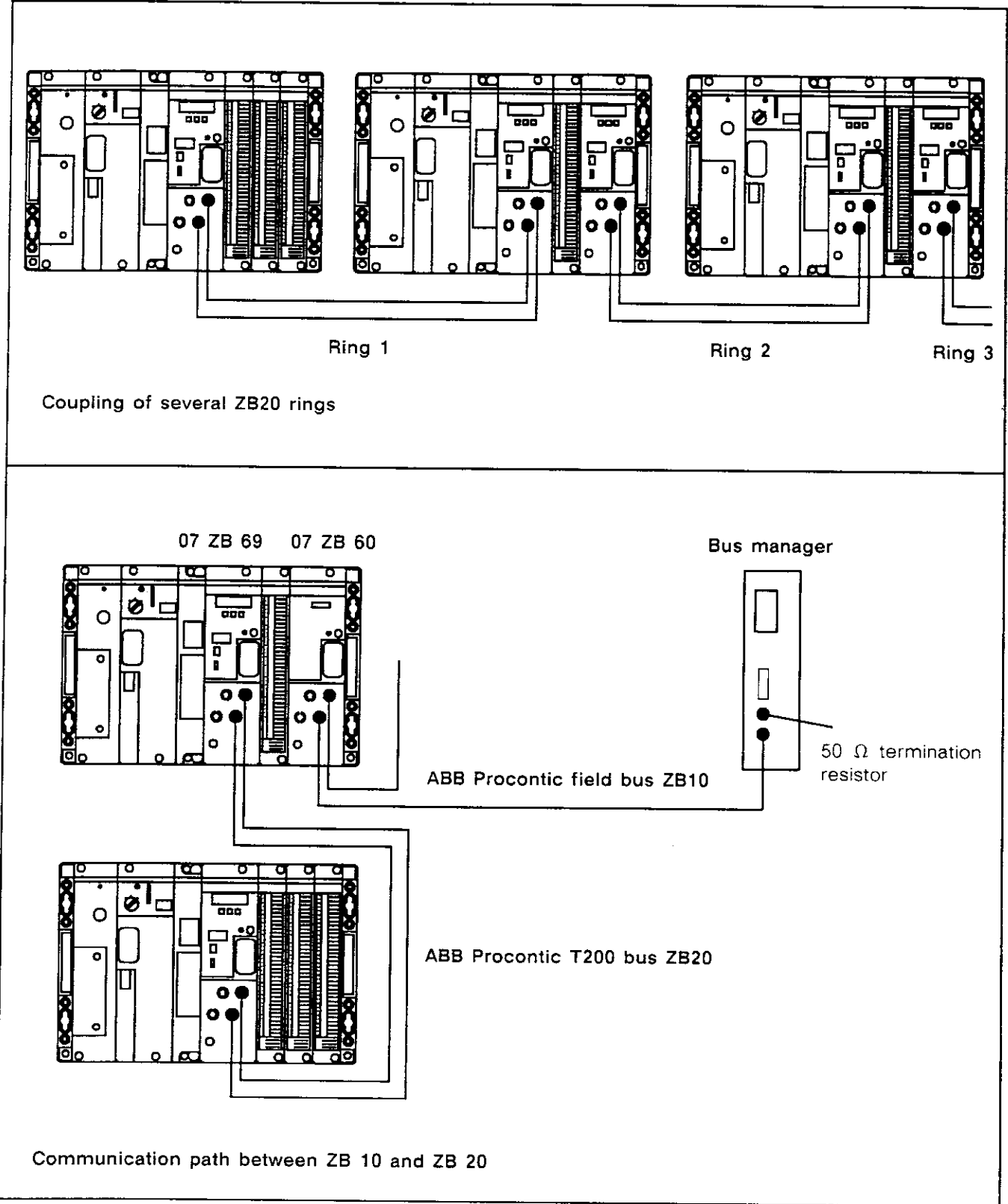

Fig. 4.8.6: Networking examples

Error handling

The operational condition of the modules is monitored by the central unit and can be interrogated by means of internal flags (see error lists).

Flags:		
M 124,14	Coupler error (0 = normal; 1 = error)	
MW 4096,07	Position of faulty 07 ZB 69 coupler (Table 4.8.3)	
MW 4110,00 – 4121,15	Error information on couplers (Table 4.8.4)	

Table 4.8.2: Flags

The following table shows the structure of the MW 4096,07 in hex (depiction in 907 PC 32 in decimal)

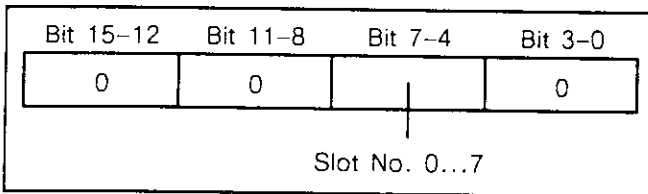

Table 4.8.3: Structure of MW 4096,07 in hex

MW 4096,07 contains the slot number (righthand number of both occupied slots) of the 07 ZB 69 coupler of the station of the ZB 20 ring, in which an error has appeared.

Flags MW 4096,07 and M 124,14 signal and store an error. They must be reset in this order at the beginning of the program. In the RESERR.SIM short list supplied with 907 PC 32, which can be read in within the Online list in "ONLINE", all relevant flags can be reset (see also the short list in the Online list).

The configuration of the 07 ZB 69 couplers is carried out in the "System configuration" menu by entering ZB69 for the righthand slot of the coupler.

For reactions to specific error information it is advisable to use the Online Listing (907 PC 32).

The behaviour of the central unit in the event of a fault in a coupler can be set in the 907 PC 32 menu "Configuration of system reactions".

Error information for ZB 20 ring 1

		Bit 15 14 13 12 11 10 9 8 7 6 5 4 3 2 1 0																
MW 4110,00	Local unit error information	not defin.	a	b	c	d	e	f	not defined	ST-No. of not connected station						0		
MW 4110,01	Information on which 07 ZB 69 units are present	15							—							0		
02		31							—							16		
03		47							—							32		
04		63							—							48		
MW 4110,05	Information on which of the present 07 ZB 69 units are connected	15							—							0		
06		31							—							16		
07		47							—							32		
08		63							—							48		
MW 4110,09	Central units' status flag	3				2				1				0				.
.		"																.
.		"																.
MW 4111,08	Error status flag	63				62				61				60				18
MW 4111,09		15							—							0		
10		31							—							16		
11		47							—							32		
12	63							—							48			
MW 4111,13	Details of unit faults at stations 00...63	k	l	m	not defined				count transmission errors						1D			
.		"																.
.		"	"	"	"				"						5C			
MW 4115,12		maximum updating time								in ms								5D
MW 4115,13		minimum updating time								in ms								5E
MW 4115,14		current updating time								in ms								5F

HEX

MW 4116,00 – MW 4121,15 Error information for ZB 20 ring 2 (structure as above)

- a: System bus fault
- b: not defined
- c: configuration out of range
- d: double configuration of range
- e: slot number out of range
- f: transmission cable not connected
- g: number in table corresponds to unit number (1 = unit present)
- h: number in table corresponds to unit number (1 = unit connected via ZB 20)
- i: number in table corresponds to unit number given as 4-bit information as follows:

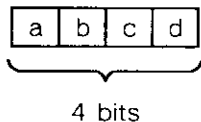

- a: 1 = central unit fault, 0 = no fault
- b: 1 = simulation in progress, 0 = simulation not in progress
- c: 1 = unchanged, 0 = changed
- d: 1 = in operation, 0 = stopped
- j: number in table corresponds to unit number (1 = error, 0 = no error)
- k: time-out error (1 = error, 0 = no error)
- l: framing error (1 = error, 0 = no error)
- m: error between a central unit and 07 ZB 69 (1 = error, 0 = no error)

Table 4.8.4: Error information on coupler 07 ZB 69

Calculation of updating time

The updating time can be calculated approximately from the sum of the following times.

Basic processing time of 07 ZB 69 with station number $n = 0$

$$t_1 = 45 \text{ ms}$$

Processing time of 07 ZB 69 with station number $n > 0$ (k_n = number of flags assigned for coupler range of station n)

$$t_{2n} = 3.7 \text{ ms} + 0.09 \text{ ms} \times k_n$$

Time for determining the number of stations occupied

$$t_3 = 20 \text{ ms}$$

Processing time for programming units which simultaneously access the ZB 20 (l = number of programming units)

$$t_4 = 4 \text{ ms} \times l$$

Updating time

$$T = t_1 + \sum t_{2n} + t_3 + t_4 \quad \text{for } 0 \leq n \leq 63$$

Example of calculation of updating time:

Configuration:

- Number of stations 3
- Number of flags assigned for coupler range of station 0 40
- Number of flags assigned for coupler range of station 1 20
- Number of flags assigned for coupler range of station 2 10

$$T = t_1 + \sum t_{2n} + t_3 + t_4$$

$$T = t_1 + t_{20} + t_{21} + t_{22} + t_3 + t_4$$

$$T = 45 \text{ ms} + 3.7 \text{ ms} + 0.09 \text{ ms} \times 40 + 3.7 \text{ ms} + 0.09 \text{ ms} \times 20 + 3.7 \text{ ms} + 0.09 \text{ ms} \times 10 + 20 \text{ ms} + 4 \text{ ms} \times 2$$

$$T = 90.4 \text{ ms}$$

Grounding scheme

(see Fig.4.8.7 to 4.8.9)

The outer shield of the triaxial cable is directly grounded on the couplers with station number 00 (Fig. 4.8.7). The outer shields of the other couplers must be capacitively grounded (via $0.1 \mu\text{F}$) (Fig. 4.8.8).

If an equal ground potential is guaranteed in a system through the use of special measures, e.g. the provision of additional equipotential bonding of large cross-sectional area, all couplers can be directly grounded.

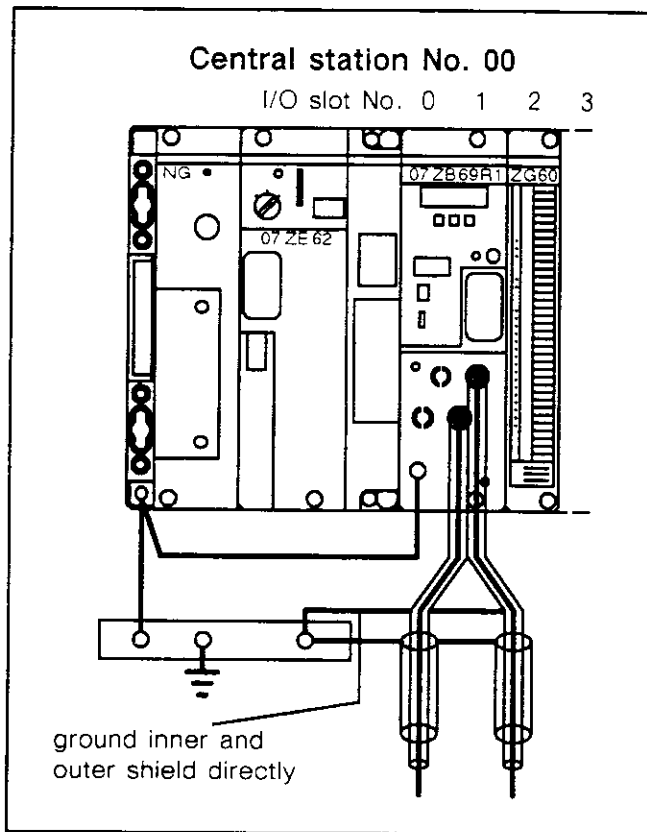

Fig. 4.8.7: Grounding scheme of the 07 ZB 69 at central station No. 00

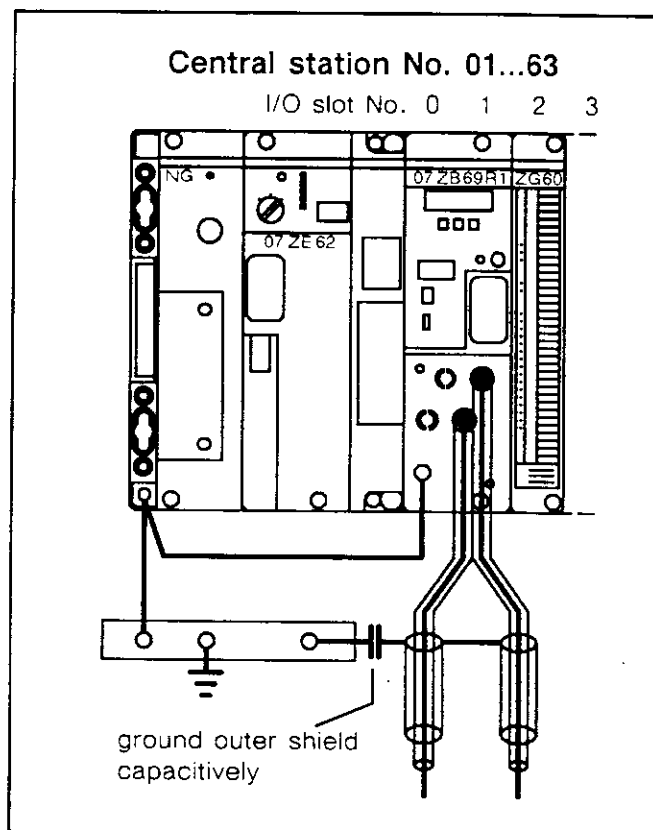

Fig. 4.8.8: Grounding scheme of the 07 ZB 69 at central stations No. 01..63

The return lead ("inner shield" of the triaxial cable) is capacitively grounded in the connector block with coupler 07 ZB 69 .

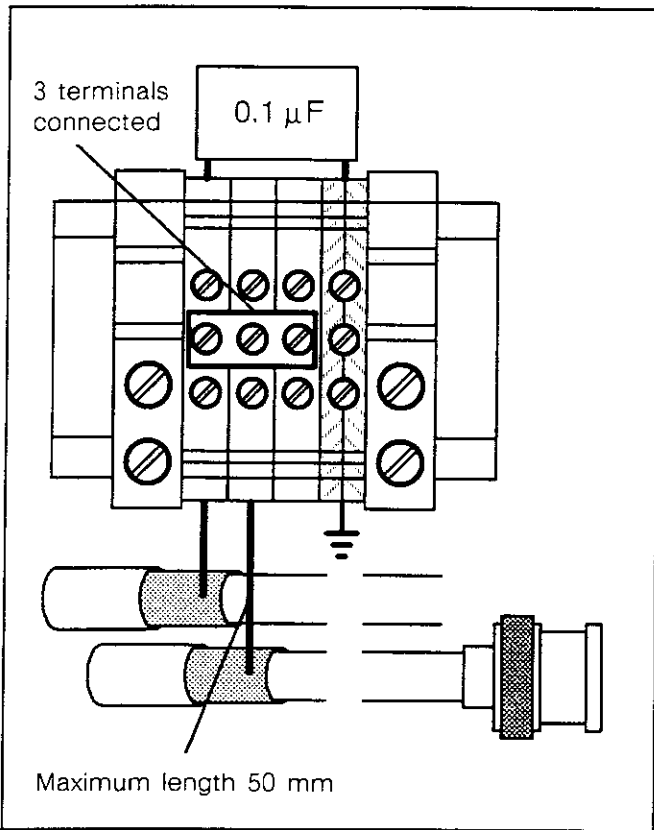

Fig. 4.8.9: Constructional suggestion for grounding triax outer shields (see also Fig. 4.8.8)

The grounding screw of the connector blocks must be connected to the grounding screw of the subrack with a short cable ($\geq 4 \text{ mm}^2$).

In order to prevent electrostatic charges building up on the inner shields, they must, in addition, be directly grounded to the coupler with station No. 00 (Fig. 4.8.7).

For effective protection against electromagnetic interference the outer shields must be connected to the switching cabinet ground with the shortest possible leads.

The protective caps supplied should be placed over the BNC sockets to protect them against electrostatic discharges.

In the control cabinet the connecting cables for the couplers should not be laid in the same cable duct as low-voltage leads.

Manual Loop Test

The manual loop test is carried out only when a transmission error has occurred between two couplers. Only one coupler can be tested at a time.

The voltage supply to the subrack must be switched off and the send and receive connectors TxD and RxD connected with the cable supplied.

The DIP switch CHECK must be set to ON. After powering up or after pressing the RES key the loop test is started. The data pattern sent is compared with the data pattern received and displayed on the 7-segment display. An error will be indicated by the ERR LED and by an error number.

Detailed description of the transmission method using TRIAX cable:

The ABB Procontic ZB20 network employs a special transmission method, which allows a fast interchange of process data between the ABB Procontic T200 control systems. Up to 64 stations can be connected to this network, which works with a gross baud rate of 1 Megabaud. The accessing method, also known as "Token passing" method, guarantees the real-time processing of the bus system. For the exact equation for the calculation of the updating time of the process data see section "Updating time".

The ZB20 bus provides a common data area of 1024 words of 16 bits each, which can be read by every coupler of the same ring (E' and/or EW'), see Table 4.8.1. Only the data area allocated to a coupler can be written by this coupler (A' and/or AW'). Overlapping of allocated coupler areas of the ZB20 bus is not permitted (see section "Software Instructions" and Fig. 4.8.5).

The construction of the communication follows the layer management of ISO 7.

Physical structure:

Serial transmission takes place through coaxial cable in baseband. Each station is coupled to the bus system by a transformer (Manchester coding).

All stations are operated in a physical ring. The length of the ring as well as the distance between the stations are included in the system specifications.

The Z 8530 "Serial Communication Controller" is used as data interchange module.

Transmission speed: 1 MBit/sec

Way of coupling: transformer

Signal representation:

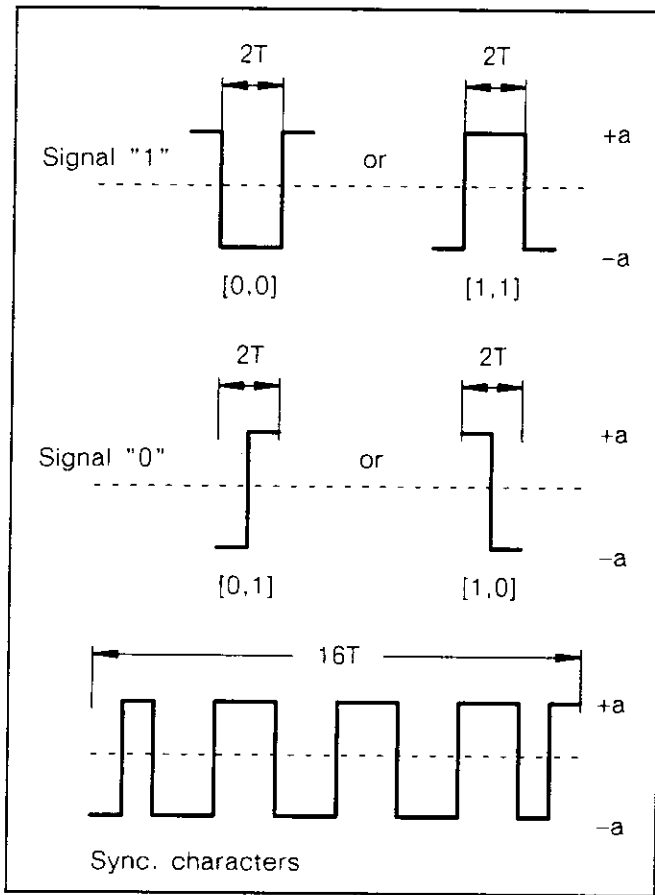

Initialization:

- The master station checks by means of a sequential call of the station numbers 1 to 63 which of the stations are present at the bus.
- It is checked, if there is a station number which is used twice.
- It is checked, whether or not the source data areas do overlap.

Cyclic data interchange:

- After initialization source data are transmitted from the slave stations to the master station. T200 communication protocols (data of the programming units), if in existence, are also transmitted.
- The token holding is passed to the station with the next number.
- The next station starts data interchange.

Source of error:

If the master station (station number = 0) breaks down, a "master transfer" is carried out to the station which has the lowest station number. Then the communication starts again.

If the "new master station" also breaks down, the communication is aborted.

Data interchange with the PLC:

The coupler is connected to the PLC via a dual-port RAM. With each allocation or interrogation of a variable out of the E'-A'-EW'-AW'-area the PLC accesses the dual-port RAM. If the ZB20 controller is the token-holding station, it reads the source data from this memory and sends them to the ZB20 bus stations. In the same way the received data are handled.

Accessing method:

Token passing method (multi-master).

After the master station (station number = 0) has been activated, the communication between the stations starts according to the following procedure:

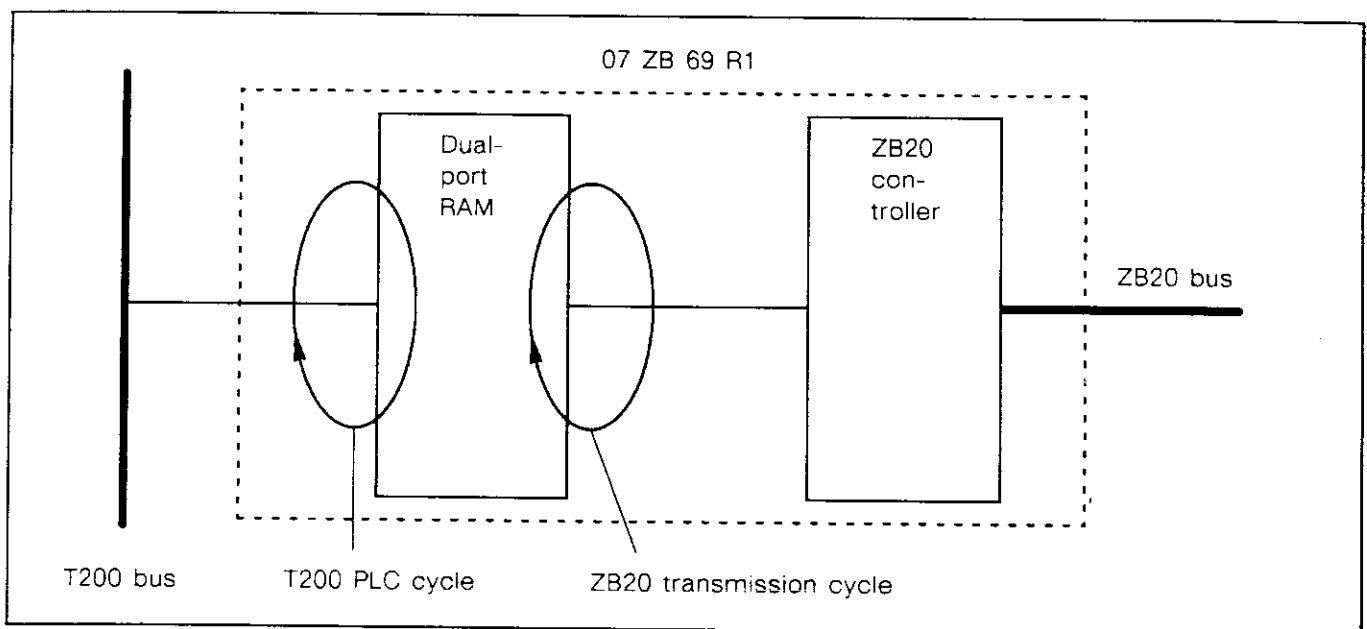

Telegram structure:

HDLC protocol with 16 bits CRC ($x^{16}+x^{12}+x^5+1$) according to CCITT

Telegram format:

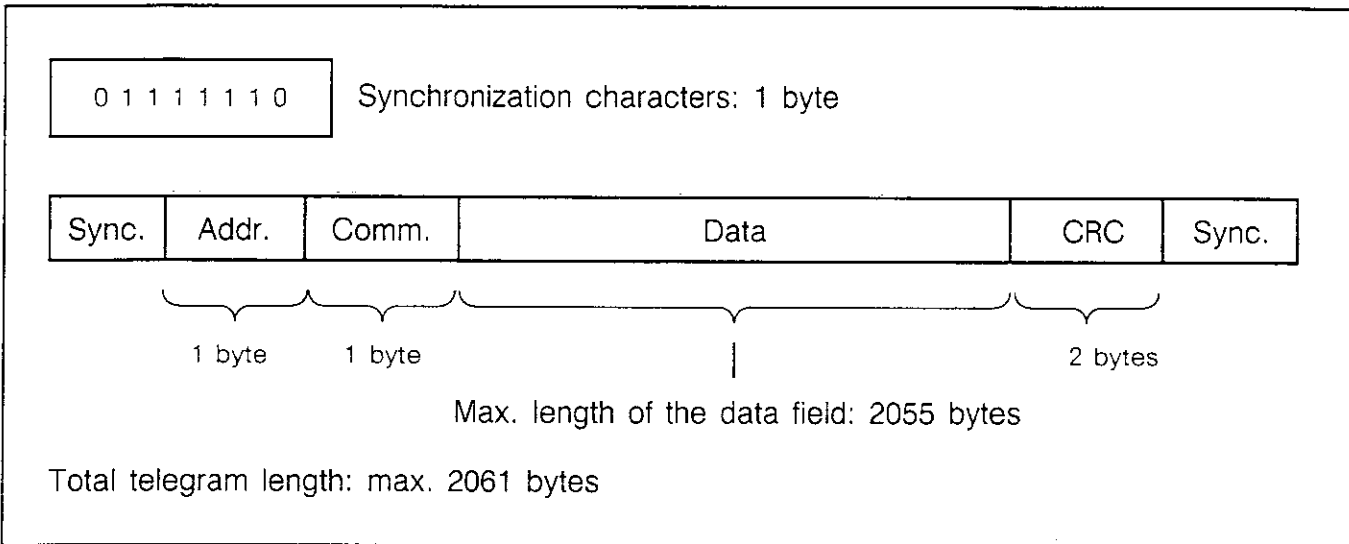

Addr. = address = 00_H to 3F_H = slave stations
= C0_H = master station

Comm. = commands:

01	1st request for a substation	: Master --> Slave
02	2nd request for a substation	: Master --> Slave
03	Request for the source data area	: Master --> Slave
04	Not used	
05	Request for source data transmission	: Master --> Slave
11	Response to command 01	: Slave --> Master
12	Response to command 02	: Slave --> Master
13	Source data transfer	: Slave --> Master
21	Transfer of data from the programming units	
22	OK for data from the programming units or request for transmission retry	
23	Request for programming units or I/O data	
FF	Confirmation of connection	
80-8F	Indication: open circuit within the ring	
00	Open circuit recovered	

Technical Data

07 ZB 69 R1

max. number of 07 ZB 69 units in one subrack or sum of modules of 07 ZB 69 and 07 ZB 60	2 2																											
max. number of central stations on T200 bus (ZB 20)	64 (Nos 00...63) per ZB 20 ring																											
Size of coupler range	1024 words per ZB 20 ring ¹⁾																											
max. number of I/O slots in basic subrack of central station	6																											
Transmission speed	1 Mbit/s																											
Transmission mode	halfduplex with serial transmission, framing synchronization																											
Transmission structure	token																											
Updating time	390 ms for 1024 words, 64 stations without additional access of a peripheral unit via T200 bus																											
Self-diagnosis	ROM/RAM system test, time monitoring, loop test																											
Error test	CRC16, overflow, parameter and cable test and time monitoring																											
Connection type	ring structure																											
Connecting cable	triaxial cable, impedance 50 Ω																											
Connector	BNC connector, connector block with bypass structure																											
Distance between two stations	max. 500 m																											
Overall length of ring	max. 1000 m																											
Interfaces for programming unit	none																											
Signalling	LED, 7-segment display																											
Current consumption from internal voltages UB1 = 5 V DC UB4 = 24 V DC	max. 0.8 A no current consumption																											
Total power dissipation	max. 4 W																											
Number of required slots	2 I/O slots																											
Configuration identifier in 907 PC 32	ZB69 (entered for right slot number)																											
Ability of fitting in subracks																												
slot, ●-● = plug-in is possible (occupies 2 slots)	<table border="1" style="border-collapse: collapse; text-align: center;"> <thead> <tr> <th colspan="3">BT</th> <th colspan="3">BE-central</th> <th colspan="3">BE-remote</th> </tr> <tr> <th>NG</th> <th>ZE</th> <th>I/O</th> <th>NG</th> <th>BV</th> <th>I/O</th> <th>NG</th> <th>BV</th> <th>I/O</th> </tr> </thead> <tbody> <tr> <td></td> <td></td> <td>●-●</td> <td></td> <td></td> <td></td> <td></td> <td></td> <td></td> </tr> </tbody> </table>	BT			BE-central			BE-remote			NG	ZE	I/O	NG	BV	I/O	NG	BV	I/O			●-●						
BT			BE-central			BE-remote																						
NG	ZE	I/O	NG	BV	I/O	NG	BV	I/O																				
		●-●																										
Weight	850 g																											
Order number	GJV3074379R0001																											
Accessories (supplied):	1 BNC connecting cable for loop test 2 protective caps for insulating BNC sockets																											
Accessories (not supplied):	see next page																											

1) 1 word occupies 16 bits

Accessories (not supplied):

Component	Designations (remarks)
TRIAX cable	50 Ω Triax cable higher EMC, Type 9222 or Type 9888 Manufacturer: Belden Electronics, Fuggerstr. 2 W-4040 Neuss 1
TRIAX cable	50 Ω Triax cable higher EMC, Type 43V 616/310 Manufacturer: Letronic – Dieter Ley Radeberger Str. 4 W-6800 Mannheim 31
BNC plug	Crimp plug for 9222 or 43V 616/310 Suhner 11BNC-50-3-4c Rosenberger 51 S 101-106 A1
BNC plug	Crimp plug for 9888 Suhner 11BNC-50-7-7c
X-type capacitor 0.1 μF	Manufacturer: RIFA, Sweden Part No. PME 271 M 610 Suppliers: Industrial Electronics GmbH Hauptstr. 71-79, W-6236 Eschborn or EVOX-Rifa GmbH Industriestr. 5, Postfach 1166 W-7707 Engen
Universal terminal, Universal Protective Earth terminal	Suppliers: C. A. Weidmüller GmbH & Co. Postfach 950, W-4930 Detmold or Phönix, Postfach 149 W-4933 Blomberg/Lippe

Error Handling

When an error occurs, information about it is stored in the internal flags M 124,14, MW 4096,07 and MW 4110,00 to MW 4121,15. At the same time an er-

ror code appears on the 7-segment display. The following error table shows the meanings of the error codes:

Table 4.8.5: Error table (07 ZB 69)

No	Error name	Error code	ERR LED display	is displayed in case of	is reset when	Remarks
1	Watchdog error	8 8 8 8	● ON	Fault in micro-computer	the reset button (RES) is pressed	
2	ROM/RAM-error	8 8 8 8	● ON	a RAM/ROM error has been detected on switching on the voltage supply	the reset button (RES) is pressed	The RAM/ROM error will lead to a watchdog error
3	Transmission error	E 1 x x	⊗ OFF	a "framing" fault occurs	the reset button (RES) and the error clear button (ERR CLR) are pressed	invalid text length or CRC-error xx: central station number (00....63)
4	Transmission time exceeded	E 2 x x	⊗ OFF	a transmission of external data has not been finished within the preset time	the reset button (RES) and the error clear button (ERR CLR) are pressed	xx: central station number (00....63)
5	Channel interrupted	E 3 x x	● ON	a channel is interrupted	the reset button (RES) is pressed after the error has been eliminated	xx: central station number (00....63)
6	Central unit communication error	E 5	⊗ OFF	an error occurs during communication with the central unit (watchdog or checksum error on system bus)	the reset button (RES) and the error clear button (ERR CLR) are pressed	
7	Double central station number	E 6	● ON	the same station number has been set more than once	the reset button (RES) and the error clear button (ERR CLR) are pressed after the error has been eliminated	

No	Error name	Error code	ERR LED display	is displayed in case of	is reset when	Remarks
8	Overlapping of coupler ranges	E 7	● ON	overlapping of assigned coupler ranges is detected	the reset button (RES) and the error clear button (ERR CLR) are pressed after the error has been eliminated	
9	Station number out of range	E 8	● ON	the setting of the station number is not within the range 00...63	the reset button (RES) is pressed after the error has been eliminated	
10	Error-free operation	0 0 0 0	⊗ OFF	correct operation of the unit		
11	Loop test error	x x	● ON		the reset button (RES) is pressed	xx: Loop test data at time of error
12	Operands out of coupler range	E 9	● ON	assigned operands lie outside the permissible coupler range	the reset button (RES) and the error clear button (ERR CLR) are pressed	

Notes:

1. The error display can also be reset by switching the voltage supply to the unit off and on again. Hardware faults cannot be eliminated by pressing the reset button.
2. If the ERR LED lights up, this always indicates a fault that must be taken seriously.
3. Even if an error occurs which will be eliminated automatically, the error code is displayed and stored until the ERR CLR or the RES button is pressed.
4. When several errors are detected at the same time, they are stored in the order in which they occurred. The 7-segment display shows the error code of the latest error to occur. By pressing the DSP CHG button the next respective error number can be displayed (cyclical switching).

4.9 Coupler with Optical Fibre 07 ZB 69 R2 for connection to ZB 20 bus

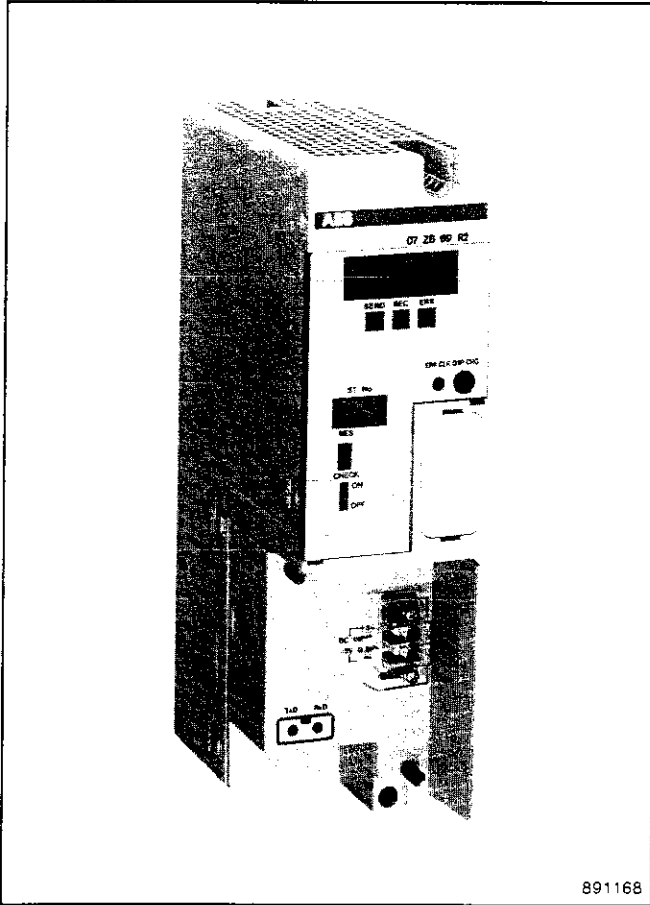

Fig. 4.9.1: Coupler 07 ZB 69 for connection to ZB20

Characteristics

Using coupler 07 ZB 69, networking is possible via the ABB Procontic T200 bus, the ZB 20 (see Fig. 4.9.2). This makes it possible to network ABB Procontic T200 controller systems with process-oriented signal cabling. The distance between stations can be up to 2 km (optical fibre). The maximum possible overall length of the ring is 15 km (optical fibre). Each station can in turn be centrally or remotely expanded.

Process data are transmitted via the ZB 20 by means of operands for the coupler ranges. These can be addressed by bit or by word.

With a programming unit connected to the central unit of a central station, every other central unit on the network can be programmed or remotely controlled (e.g. START, STOP) via the ZB 20. Status inquiries can also be carried out, except 'General Reset'. A maximum of 4 programming units can be connected to a ZB 20 networked system simultaneously.

A maximum of two 07 ZB 69 couplers per basic subrack can be installed. Using this concept two ZB 20 rings with up to 64 stations each can be constructed (see Fig. 4.9.2).

It is also possible to use one 07 ZB 69 coupler and one 07 ZB 60 coupler in the same basic subrack and thus to create a data transmission path between the ABB Procontic T200 bus (ZB20) and the ABB Procontic field bus ZB10 (see Fig. 4.9.6).

Module Description

The module consists of the housing with removable transparent front covering for the display and operating elements and a screw-on connector block with fibre-optical sockets for connection to further ZB 20 couplers.

A 7-segment display and light-emitting diodes are provided for signalling ready status for operation and errors. Further pushbuttons and switches are provided for testing and operating the module (see Fig. 4.9.3).

Project Planning

The 07 ZB 69 couplers for the ZB 20 can be used only in the basic subrack (BT). The positioning sequence of the modules in the basic subrack determines the numbers in the ZB 20 ring (1 or 2). With two couplers the left 07 ZB 69 module is given the number 1, corresponding to ZB 20 ring 1.

The connections between the couplers are made with optical fibres ¹⁾.

Comprehensive diagnostic facilities allow for simple monitoring and fault detection both during commissioning and in operation.

¹⁾ see specifications for optical fibres

Central station No. 00 (master station) for both rings

I/O slot No. 0 1 2 3 4 5 6 7

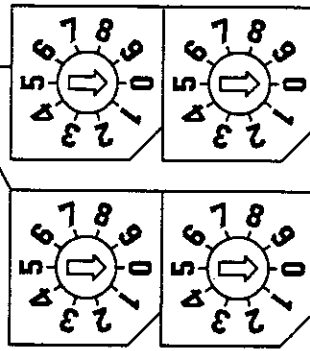
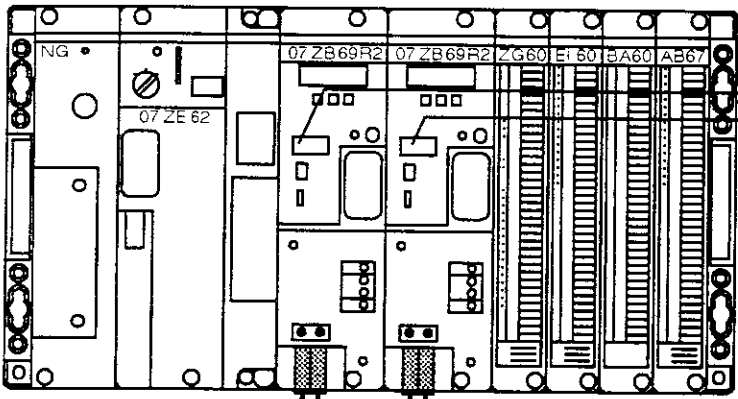

ZB 20 ring 1

ZB 20 ring 2

Connecting cables:
fiber-optic cable

Central station No. 01, ring 1

I/O slot No. 0 1 2 3 4

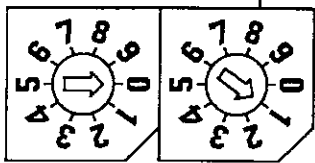
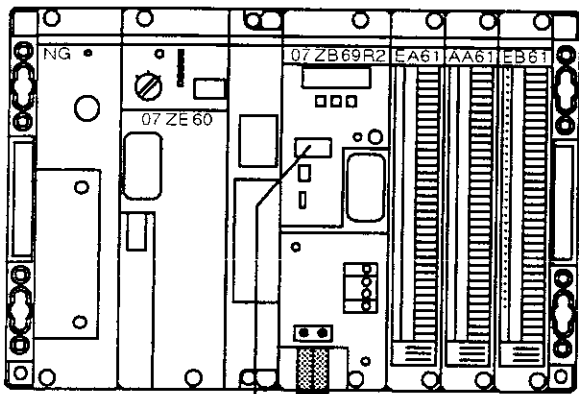

Central station No. 01, ring 2

I/O slot No. 0 1 2 3 4

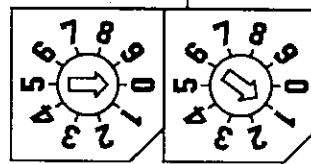
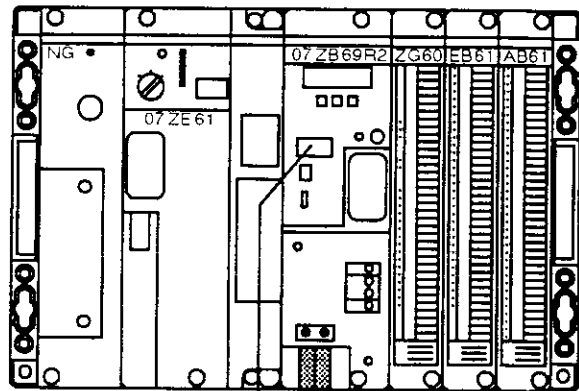

Central station No. 02, ring 1

I/O slot No. 0 1 2 3 4

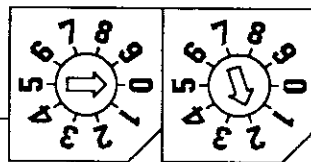
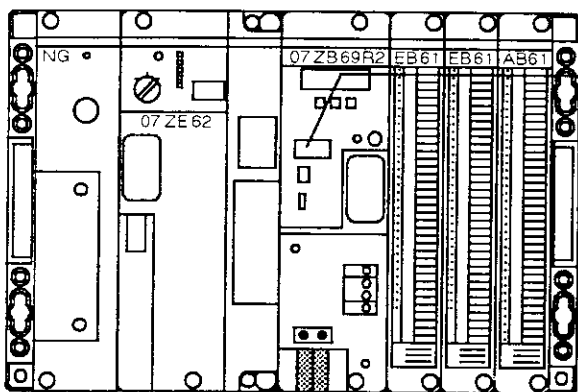

The setting of station numbers for the couplers are examples. Couplers with the setting 00 define the central station in which they are located to the master central station of the ring concerned.

Maximal expansion possible with ZB 20 networking:

- 2 rings per central station
- 64 central stations per ring (settings 00...63)
- 2000 m distance between two stations
- 15000 m overall length of ring

Fig. 4.9.2: Configuration of a ZB 20 networking

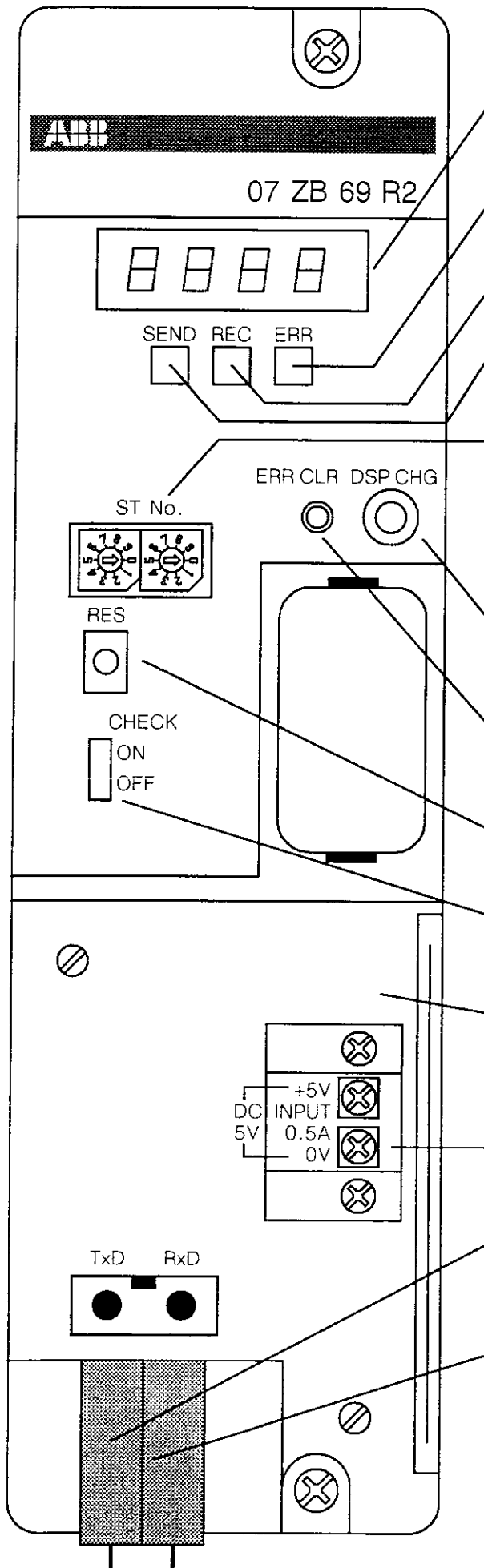

7-segment display

4-digit display of operational condition. During error-free operation the display indicates 0000; for error conditions see detailed error table.

ERR (Error display)

illuminates when data transmission is interrupted after occurrence of an error

REC (Receive Data display)

Flashes during reception of data by the 07 ZB 69

Send (Send Data display)

Flashes during transmission of data by the 07 ZB 69

ST No. (Station Number rotary switch)

Selection switch for setting the station number (00...63). The righthand rotary switch sets the units digits, the left-hand switch sets the tens digits (decimal setting). Settings that are too large are indicated as error E8. The setting does not become effective until after powering-up.

DSP CHG (Display Change button)

Switches to display further error numbers when more than one error is present

ERR CLR (Error Clear button)

Erases the error number on the 7-segment display

RES (Reset button)

Resets the coupler; must not be used while in RUN mode

CHECK (Check Mode DIL switch)

Selection switch for testing in send or receive directions

Connector block

Screw-on connector block with optical connectors for fibre-optic cables.

Connecting Terminal 5 V DC

Terminal for external 5 V DC supply voltage for bypass option.

TxD (Transmit Data connector)

optical connector for fibre-optic cable; has to be connected to the RxD connector of ZB 20 coupler of next station.

RxD (Receive Data connector)

optical connector for fibre-optic cable; has to be connected to the TxD connector of ZB 20 coupler of previous station.

Fig. 4.9.3: Coupler 07 ZB 69 R2 with description of displays and controls

Connection scheme

Connections to further ZB 20 couplers are made with fibre-optic cables. The TxD connectors of the 07 ZB 69 coupler are connected to the RxD connectors of the coupler of the next station and the RxD connectors of the 07 ZB 69 to the TxD connectors of the coupler of the previous station (see Table 4.9.2). If the connection between the couplers is broken or if there is a false connection, this is detected by the coupler and the corresponding error number issued.

The removable connector block of the couplers has "bypass structure", if the external 5 V DC supply voltage is connected. If the supply voltage to another station is switched off, the ZB 20 ring is not interrupted. In such an operational condition the bus connection is bridged over. The bus need therefore not be disconnected when replacing a defective ZB 20 coupler. The voltage supply to the defective station needs only be switched off, the connector block unscrewed, the defective module replaced and the connector block reinstalled.

IMPORTANT:

When the supply voltage is switched on, i.e. during operation, neither the connector block nor the connecting leads may be removed.

General Instructions

In general the voltage supply to the subrack should be switched off before inserting or removing couplers.

Screw-on connector blocks of couplers labeled with R2 (optical fibre connection) must neither be replaced with connector blocks of couplers labeled with R1 (triaxial connection) nor in the reverse case.

There are no restrictions on the power-up sequence of ABB Procontic T200 systems with ZB 20 couplers. Data transmission via the ZB 20 does not however begin until powering-up of the "master station", i.e. the central station whose station number is 00, set on the 07 ZB 69 coupler.

On commissioning, the supply voltage to the other stations should be switched on before that to the master station. If a duplicated station number has been set, error E6 will be signalled at the central unit.

With a programming unit connected to the central unit of a central station, every other central unit on the ZB 20 network can be remotely programmed or controlled (e.g. START, STOP) via the ZB 20. Status inquiries can also be carried out. A maximum of 4 programming units can be connected to a ZB 20 networked system simultaneously.

The function 'General Reset' may not be performed via a ZB 20 network.

Software Instructions

Coupler ranges

Process data are transmitted via the ZB 20 by means of operands for the coupler ranges (Table 4.9.1). These can be addressed by bits or by words (see Fig. 4.9.4).

When using two 07 ZB 69 couplers or one 07 ZB 69 coupler and one 07 ZB 60 coupler respectively, the coupler range 1 of the ring (or line) is assigned to the left-hand module and the coupler range 2 of the ring (or line) is assigned to the right-hand module.

The coupler ranges cannot be buffered. When the execution of a central station program is stopped (e.g. by setting the key switch to STOP) or at failure of a station, the last data written by this station are retained.

Operand	Meaning
E' 0000,00 ... 1023,15	Inputs in coupler range 1 of the ring (or line)
A' 0000,00 ... 1023,15	Outputs in coupler range 1 of the ring (or line)
EW' 0000,00 ... 1023,00	Word inputs in coupler range 1 of the ring (or line)
AW' 0000,00 ... 1023,00	Word outputs in coupler range 1 of the ring (or line)
E' 1024,00 ... 2047,15	Inputs in coupler range 2 of the ring (or line)
A' 1024,00 ... 2047,15	Outputs in coupler range 2 of the ring (or line)
EW' 1024,00 ... 2047,00	Word inputs in coupler range 2 of the ring (or line)
AW' 1024,00 ... 2047,00	Word outputs in coupler range 2 of the ring (or line)

Table 4.9.1: Operands for coupler ranges

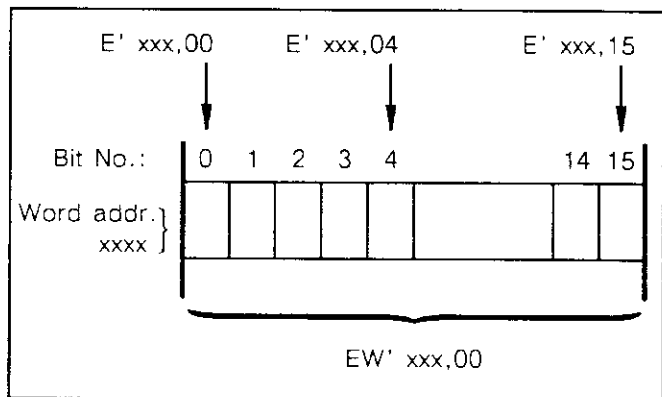

Fig. 4.9.4: Coupler ranges, that can be addressed both by bits and by words

The allocation between bit and word positions is found from the operand address. In this range both the inputs (E', EW') and the outputs (A', AW') refer to the same address. The distinction between E' and A' is neces-

sary, in order to be able to distinguish between source and destination address during programming.

For process data transmission a coupler range must be set for each station, which may only be written to by this station (source); see also the description of the 907 PC 32 Test and Programming System, configura-

tion of flag ranges. The entire coupler range can be read by all stations (sink).

When reading back programs with 907 PC 32 it must be noticed, that E'xx,xx is converted into A'xx,xx and EW'xx,xx is converted into AW'xx,xx in the back-read program.

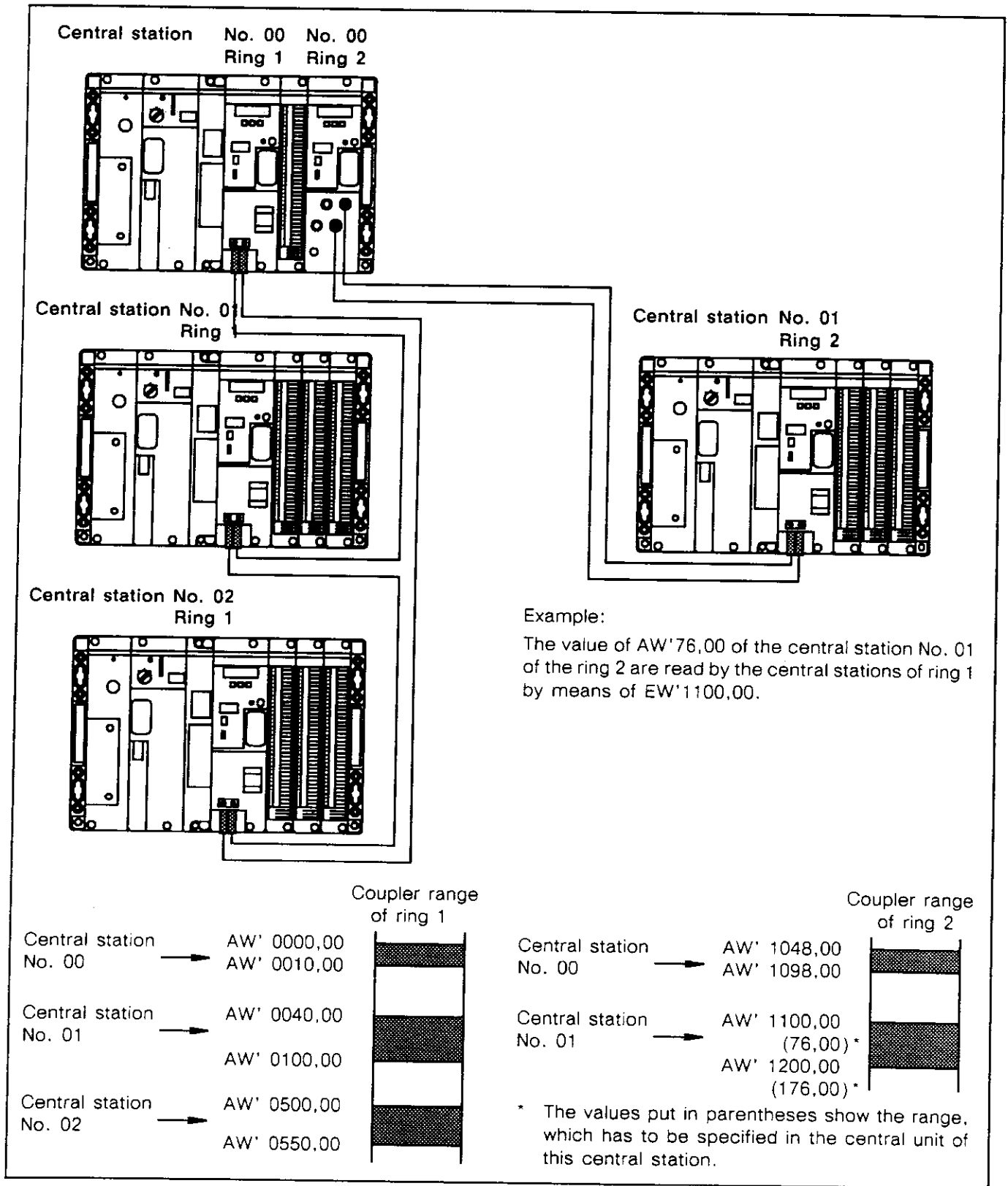

Fig. 4.9.5: Example for a ZB 20 networking with two rings

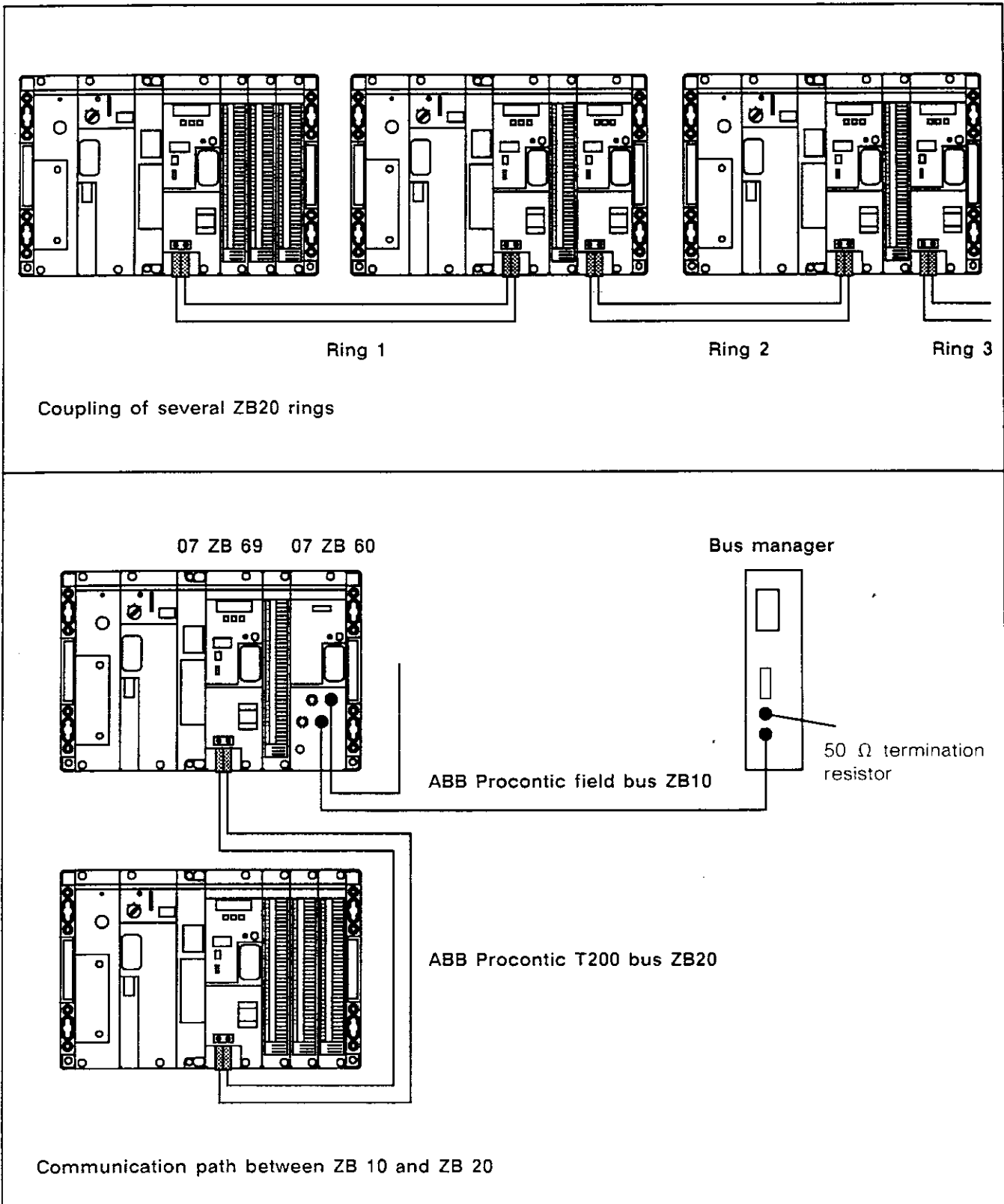

Fig. 4.9.6: Networking examples

Error handling

The operational condition of the modules is monitored by the central unit and can be interrogated by means of internal flags (see error lists).

Flags:		
M 124,14	Coupler error (0 = normal; 1 = error)	
MW 4096,07	Position of faulty 07 ZB 69 coupler (Table 4.9.3)	
MW 4110,00 – 4121,15	Error information on couplers (Table 4.9.4)	

Table 4.9.2: Flags

The following table shows the structure of the MW 4096,07 in hex (depiction in 907 PC 32 in decimal)

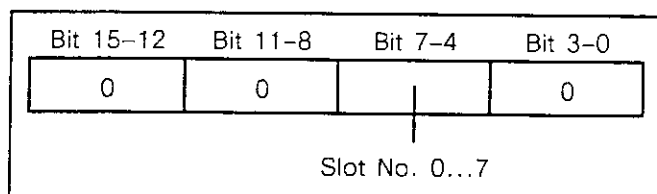

Table 4.9.3: Structure of MW 4096,07 in hex

MW 4096,07 contains the slot number (righthand number of both occupied slots) of the 07 ZB 69 coupler of the station of the ZB 20 ring, in which an error has appeared.

Flags MW 4096,07 and M 124,14 signal and store an error. They must be reset in this order at the beginning of the program. In the RESERR.SIM short list supplied with 907 PC 32, which can be read in within the Online list in "ONLINE", all relevant flags can be reset (see also the short list in the Online list).

The configuration of the 07 ZB 69 couplers is carried out in the "System configuration" menu by entering ZB69 for the righthand slot of the coupler.

For reactions to specific error information it is advisable to use the Online Listing (907 PC 32).

The behaviour of the central unit in the event of a fault in a coupler can be set in the 907 PC 32 menu "Configuration of system reactions".

Error information for ZB 20 ring 1

Bit 15 14 13 12 11 10 9 8 7 6 5 4 3 2 1 0

MW	Description	15	14	13	12	11	10	9	8	7	6	5	4	3	2	1	0	HEX
MW 4110,00	Local unit error information	not defin.	a	b	c	d	e	f	not defined	ST-No. of not connected station								0
MW 4110,01	Information on which 07 ZB 69 units are present	15	-						-								0	1
02		31	-						-								16	2
03		47	-						-								32	3
04		63	-						-								48	4
MW 4110,05	Information on which of the present 07 ZB 69 units are connected	15	-						-								0	5
06		31	-						-								16	6
07		47	-						-								32	7
08		63	-						-								48	8
MW 4110,09	Central units' status flag	3				2				1				0				.
.		"																.
.		"																.
MW 4111,08	Error status flag	63				62				61				60				18
MW 4111,09		15	-						-								0	19
10		31	-						-								16	1A
11		47	-						-								32	1B
12	63	-						-								48	1C	
MW 4111,13	Details of unit faults at stations 00...63	k	l	m	not defined				count transmission errors								1D	
.		"																.
.		"	"	"	"	"				"								5C
MW 4115,12	maximum updating time in ms																5D	
MW 4115,13	minimum updating time in ms																5E	
MW 4115,14	current updating time in ms																5F	

MW 4116,00 – MW 4121,15 Error information for ZB 20 ring 2 (structure as above)

- a: System bus fault
- b: not defined
- c: configuration out of range
- d: double configuration of range
- e: slot number out of range
- f: transmission cable not connected
- g: number in table corresponds to unit number (1 = unit present)
- h: number in table corresponds to unit number (1 = unit connected via ZB 20)
- i: number in table corresponds to unit number given as 4-bit information as follows:

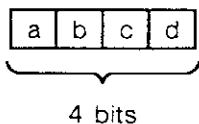

- a: 1 = central unit fault, 0 = no fault
- b: 1 = simulation in progress, 0 = simulation not in progress
- c: 1 = unchanged, 0 = changed
- d: 1 = in operation, 0 = stopped

- j: number in table corresponds to unit number (1 = error, 0 = no error)
- k: time-out error (1 = error, 0 = no error)
- l: framing error (1 = error, 0 = no error)
- m: error between a central unit and 07 ZB 69 (1 = error, 0 = no error)

Table 4.9.4: Error information on coupler 07 ZB 69

Calculation of updating time

The updating time can be calculated approximately from the sum of the following times.

Basic processing time of 07 ZB 69 with station number $n = 0$

$$t_1 = 45 \text{ ms}$$

Processing time of 07 ZB 69 with station number $n > 0$ (k_n = number of flags assigned for coupler range of station n)

$$t_{2n} = 3.7 \text{ ms} + 0.09 \text{ ms} \times k_n$$

Time for determining the number of stations occupied

$$t_3 = 20 \text{ ms}$$

Processing time for programming units which simultaneously access the ZB 20 (l = number of programming units)

$$t_4 = 4 \text{ ms} \times l$$

Updating time

$$T = t_1 + \sum t_{2n} + t_3 + t_4 \quad \text{for } 0 \leq n \leq 63$$

Example of calculation of updating time:
Configuration:

- Number of stations	3
- Number of flags assigned for coupler range of station 0	40
- Number of flags assigned for coupler range of station 1	20
- Number of flags assigned for coupler range of station 2	10

$$T = t_1 + \sum t_{2n} + t_3 + t_4$$

$$T = t_1 + t_{20} + t_{21} + t_{22} + t_3 + t_4$$

$$T = 45 \text{ ms} + 3.7 \text{ ms} + 0.09 \text{ ms} \times 40 \\ + 3.7 \text{ ms} + 0.09 \text{ ms} \times 20 + 3.7 \text{ ms} + 0.09 \text{ ms} \times 10 \\ + 20 \text{ ms} + 4 \text{ ms} \times 2$$

$$T = 90.4 \text{ ms}$$

Manual Loop Test

The manual loop test is carried out only when a transmission error has occurred between two couplers. Only one coupler can be tested at a time.

The voltage supply to the subrack must be switched off and the send and receive connectors TxD and RxD connected with the cable supplied.

The DIP switch CHECK must be set to ON. After powering up or after pressing the RES key the loop test is started. The data pattern sent is compared with the data pattern received and displayed on the 7-segment display. An error will be indicated by the ERR LED and by an error number.

Detailed description of the transmission method using optical fibre:

The ABB Procontic ZB20 network employs a special transmission method, which allows a fast interchange of process data between the ABB Procontic T200 control systems. Up to 64 stations can be connected to this network, which works with a gross baud rate of 1 Megabaud. The accessing method, also known as "Token passing" method, guarantees the real-time processing of the bus system. For the exact equation for the calculation of the updating time of the process data see section "Updating time".

The ZB20 bus provides a common data area of 1024 words of 16 bits each, which can be read by every coupler of the same ring (E' and/or EW'), see Table 4.9.1. Only the data area allocated to a coupler can be written by this coupler (A' and/or AW'). Overlapping of allocated coupler areas of the ZB20 bus is not permitted (see section "Software Instructions" and Fig. 4.9.5).

The construction of the communication follows the layer management of ISO 7.

Physical structure:

Serial transmission takes place through fibre-optic cable in baseband.

All stations are operated in a physical ring. The length of the ring as well as the distance between the stations are included in the system specifications.

The Z 8530 "Serial Communication Controller" is used as data interchange module.

Transmission speed: 1 MBit/sec

Way of coupling: optical fibre

Accessing method:

Token passing method (multi-master).

After the master station (station number = 0) has been activated, the communication between the stations starts according to the following procedure:

Initialization:

- The master station checks by means of a sequential call of the station numbers 1 to 63 which of the stations are present at the bus.
- It is checked, if there is a station number which is used twice.
- It is checked, whether or not the source data areas do overlap.

Cyclic data interchange:

- After initialization source data are transmitted from the slave stations to the master station. T200 communication protocols (data of the programming units), if in existence, are also transmitted.

- The token holding is passed to the station with the next number.

- The next station starts data interchange.

Source of error:

If the master station (station number = 0) breaks down, a "master transfer" is carried out to the station which has the lowest station number. Then the communication starts again.

If the "new master station" also breaks down, the communication is aborted.

Data interchange with the PLC:

The coupler is connected to the PLC via a dual-port RAM. With each allocation or interrogation of a variable out of the E'-A'-EW'-AW'-area the PLC accesses the dual-port RAM. If the ZB20 controller is the token-holding station, it reads the source data from this memory and sends them to the ZB20 bus stations. In the same way the received data are handled.

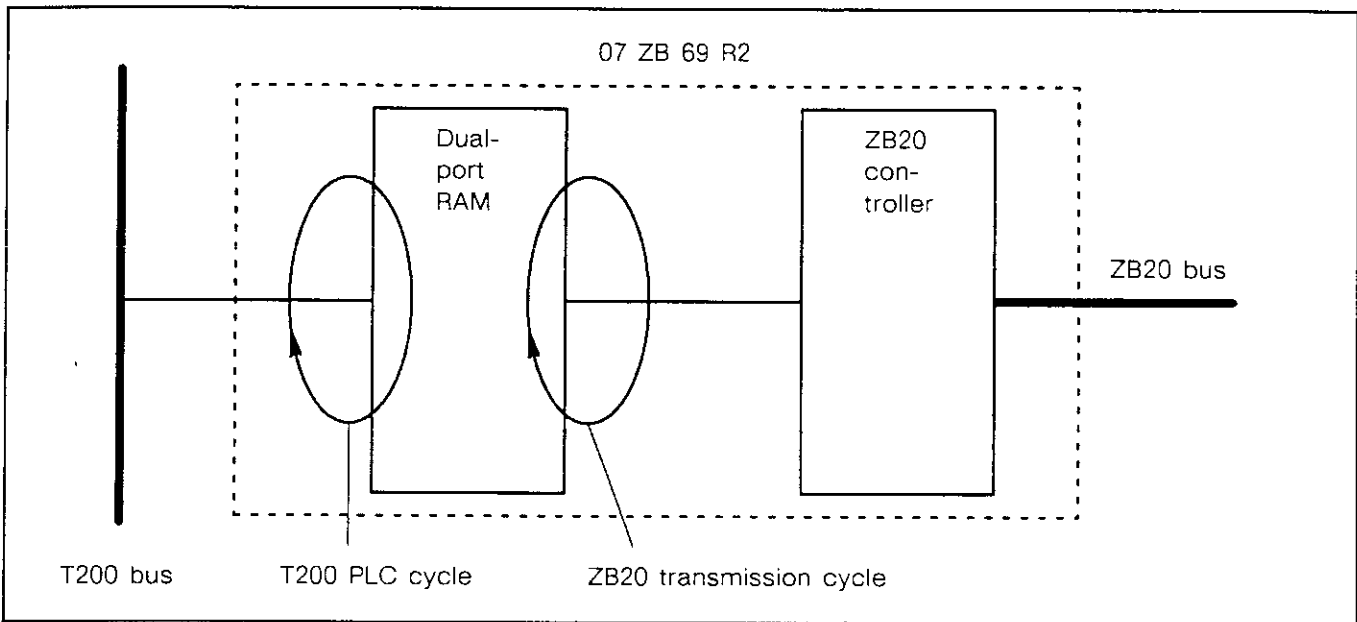

Telegram structure:

HDLC protocol with 16 bits CRC (x16+x12+x5+1) according to CCITT

Telegram format:

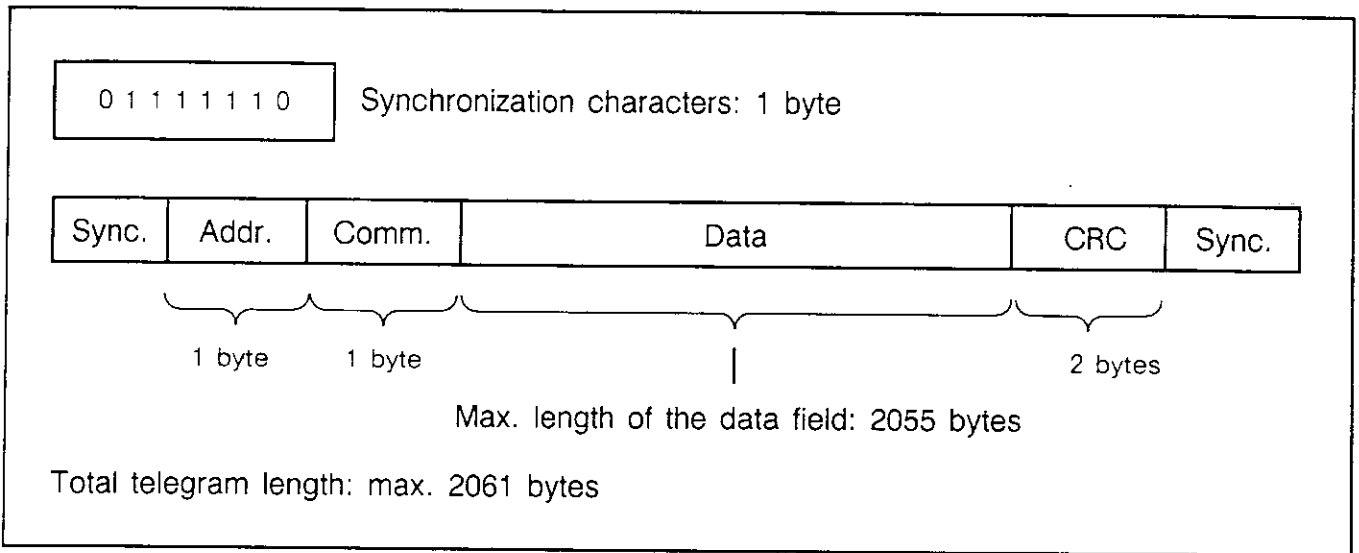

Addr. = address = 00_H to 3F_H = slave stations
 = C0_H = master station

Comm. = commands:

- | | | |
|-------|--|--------------------|
| 01 | 1st request for a substation | : Master --> Slave |
| 02 | 2nd request for a substation | : Master --> Slave |
| 03 | Request for the source data area | : Master --> Slave |
| 04 | Not used | |
| 05 | Request for source data transmission | : Master --> Slave |
| 11 | Response to command 01 | : Slave --> Master |
| 12 | Response to command 02 | : Slave --> Master |
| 13 | Source data transfer | : Slave --> Master |
| 21 | Transfer of data from the programming units | |
| 22 | OK for data from the programming units or request for transmission retry | |
| 23 | Request for programming units or I/O data | |
| FF | Confirmation of connection | |
| 80-8F | Indication: open circuit within the ring | |
| 00 | Open circuit recovered | |

Technical Data

Max. number of 07 ZB 69 units in one subrack
or sum of modules of 07 ZB 69 and 07 ZB 60

Max. number of central stations on
T200 bus (ZB 20)

Size of coupler range

Max. number of I/O slots in basic subrack
of central station

Transmission speed

Transmission mode

Transmission structure

Updating time

Self-diagnosis

Error test

Connection type

Connecting cable

Connectors

Distance between two stations

Overall length of ring

Wave length

Launched power (peak dBm)

Type of fibre (core/cladding diameter)

Attenuation of fibre

Max. permissible system loss of assembled cable

Typical insertion loss of connector

Typical insertion loss of connection

Typical insertion loss of splice

Interfaces for programming unit

Signalling

Current consumption from internal voltages

UB1 = 5 V DC

UB4 = 24 V DC

Total power dissipation

Number of required slots

Configuration identifier in 907 PC 32

Ability of fitting in subracks

slot,

●-● = plug-in is possible (occupies 2 slots)

Weight

Order number

07 ZB 69 R2

07 ZB 69 R2

2

2

64 (No. 00...63) per ZB 20 ring

1024 words per ZB 20 ring ¹⁾

6

1 Mbit/s

halfduplex with serial transmission,
framing synchronization

token

390 ms for 1024 words, 64 stations without
additional access of a peripheral unit via
T200 bus

ROM/RAM system test, time monitoring,
loop test

CRC16, overflow, parameter and cable test and
time monitoring

ring structure

fibre-optic cable

optical connectors, connector block with bypass
structure (if connected to 5 V DC)

max. 2 km

max. 15 km

840 nm

- 21 dBm

50/125 µm

3.0 dB/km @ 840 nm

16 dB

≤ 1 dB

≤ 2 dB

≤ 0.2 dB

none

LED, 7-segment display

max. 1.1 A

no current consumption

max. 4 W

2 I/O slots

ZB69 (entered for right slot number)

BT			BE-central			BE-remote		
NG	ZE	I/O	NG	BV	I/O	NG	BV	I/O
		●-●						

850 g

GJV3074379R0002

¹⁾ 1 word occupies 16 bits

Technical data for external 5 V DC power supply:

Voltage	5 V DC \pm 5 %
Output load capability	700 mA
Residual ripple	max. 50 mVss

For each optical coupler a separate 5 V DC power supply module should be used.

Accessories (supplied): 1 fibre-optic connecting cable for loop test

Accessories (not supplied):

Component	Designations (remarks)
ABB SIGMA [®] tronic b Converter R508.1 (24 V DC/5 V DC)	ABB order No. GH R508 0001 R1
Premounted Simplex optical-fibre indoor cable with connectors at both ends, length = 10 m	Type: 07 LK 60 ABB order No. GJV3 0755 01 R1
Premounted Simplex optical-fibre indoor cable with connectors at one end, for splice connections, length = 10 m	Type: 07 LK 61 ABB order No. GJV3 0755 02 R1
Coupling device for cable-to-cable connection and test and measurement purposes	Type: 07 LV 60 ABB order No. GJV3 0755 03 R1

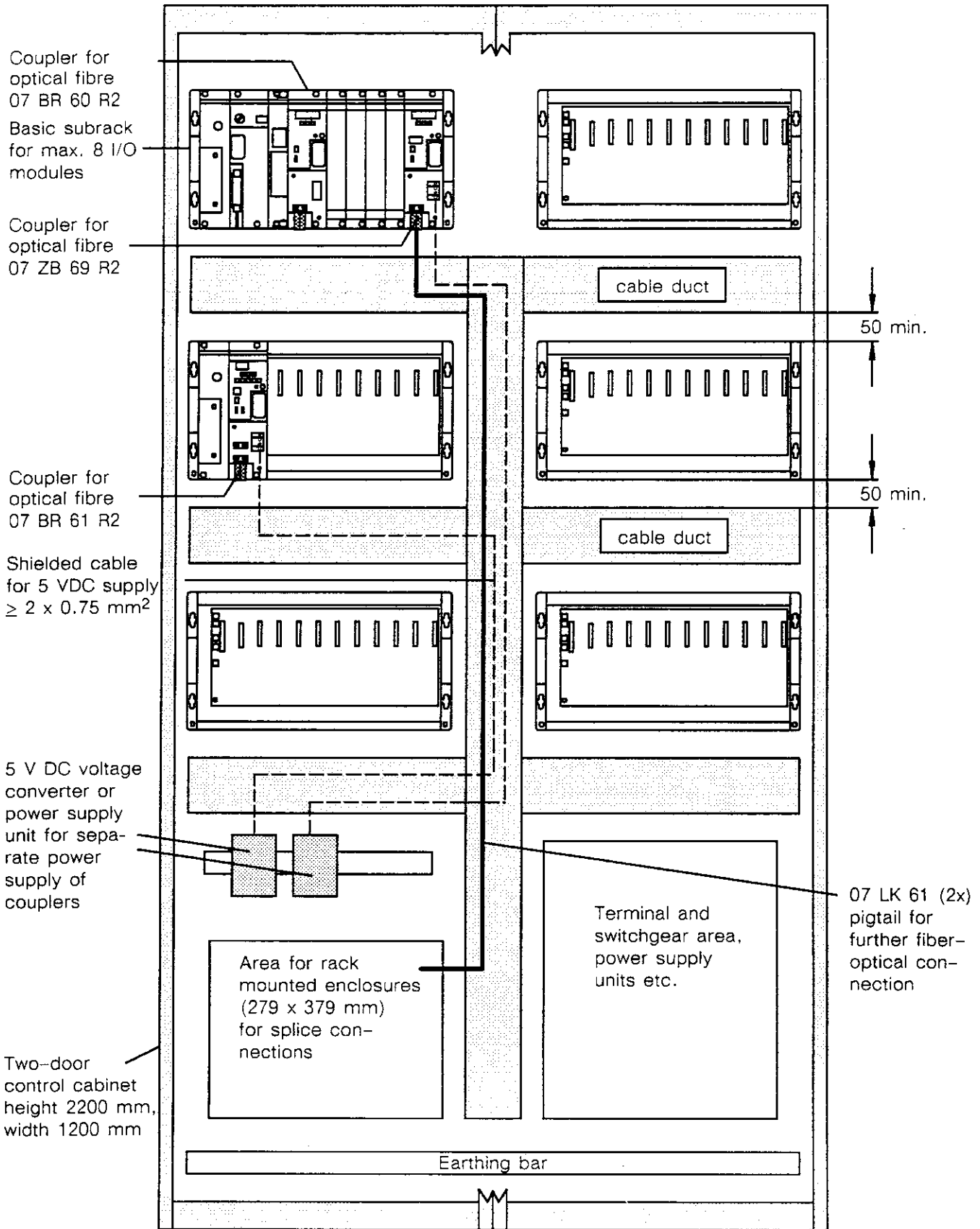

When laying fibre-optic cables care has to be taken that the bending radius will not fall below the minimum permissible.

Fig. 4.9.7: Typical rack mounting and wiring management of optical-fiber modules

Fibre-Optic Cable Installation

Laying fibre-optic cables is more ambitious than laying copper cables. It has to be carried out by highly skilled workers, who are familiar with the mechanical properties of the cable and the practical aspects of a correct installation. The following points should be observed.

1. There is a great variety of fibre-optic cables, which can be buried, strung aerially or placed in trays and conduits. Depending on the way of installation there are many tools and special equipments to be used.
2. Minimum bend radius and maximum tensile rating are the critical specifications for any fibre-optic cable installation, both during the installing process and during the installed life of the cable. Careful planning of the installation layout will ensure that the specifications are not exceeded. In addition, the installation process itself must be carefully planned.

An increasing tensile load as well as a decreasing bend radius cause a reversible attenuation increase, an irreversible attenuation increase, and, finally, cracking of the fibre.

2. Cables must be protected against damage during and after installation. Splice connections and cable ends (with their connectors) must be protected against humidity.
Buried cables must be protected against frost, water seepage, attack by burrowing and gnawing animals, and mechanical stresses that could result from earth movements. Armored cables specially designed for burial are available.
Aerial cables must be able to withstand the forces

of high winds, storms, ice loading, and so forth. Self-supporting aerial cables are available.

3. Since standard fibre-optic cables are electrically nonconductive, they may be placed near high-voltage cables without shielding.
4. The primary consideration in selecting a route for fibre-optic cable through trays and ducts is to avoid potential cutting edges and sharp bends. Areas where particular caution must be taken are corners and exit slots in sides of trays.
If a fibre-optic cable is in the same tray or duct with very large, heavy electrical cables, care must be taken to avoid placing excessive crushing forces on the fibre-optic cable, particularly where the heavy cables cross over the fibre-optic cable.
5. Long vertical runs within trays and ducts as well as runs outside them should be clamped at intermediate points. Clamping forces should be no more than necessary to prevent damage and crushing forces on the jacket of the optical cable.
6. During pulling of the cable, pulling force should be constantly monitored by a mechanical gauge. If any increase in pulling force is noticed, pulling should immediately cease, and the cause of the increase should be determined.
Pull tension can be monitored by a running line tensiometer or a dynamometer and pulley arrangement. If a power winch is used to assist the pulling, a power capstan with adjustable slip clutch is recommended. The clutch, set for the maximum loading, will disengage if the set load is reached.
If necessary for difficult pulls, the cable should be continuously lubricated during pulling-in.

Error Handling

When an error occurs, information about it is stored in the internal flags M 124,14, MW 4096,07 and MW 4110,00 to MW 4121,15. At the same time an er-

ror code appears on the 7-segment display. The following error table shows the meanings of the error codes:

Table 4.9.5: Error table (07 ZB 69)

No	Error name	Error code	ERR LED display	is displayed in case of	is reset when	Remarks
1	Watchdog error	8 8 8 8	● ON	Fault in micro-computer	the reset button (RES) is pressed	
2	ROM/RAM-error	8 8 8 8	● ON	a RAM/ROM error has been detected on switching on the voltage supply	the reset button (RES) is pressed	The RAM/ROM error will lead to a watchdog error
3	Transmission error	E 1 x x	⊗ OFF	a "framing" fault occurs	the reset button (RES) and the error clear button (ERR CLR) are pressed	invalid text length or CRC-error xx: central station number (00....63)
4	Transmission time exceeded	E 2 x x	⊗ OFF	a transmission of external data has not been finished within the preset time	the reset button (RES) and the error clear button (ERR CLR) are pressed	xx: central station number (00....63)
5	Channel interrupted	E 3 x x	● ON	a channel is interrupted	the reset button (RES) is pressed after the error has been eliminated	xx: central station number (00....63)
6	Central unit communication error	E 5	⊗ OFF	an error occurs during communication with the central unit (watchdog or checksum error on system bus)	the reset button (RES) and the error clear button (ERR CLR) are pressed	
7	Double central station number	E 6	● ON	the same station number has been set more than once	the reset button (RES) and the error clear button (ERR CLR) are pressed after the error has been eliminated	

No	Error name	Error code	ERR LED display	is displayed in case of	is reset when	Remarks
8	Overlapping of coupler ranges	E 7	● ON	overlapping of assigned coupler ranges is detected	the reset button (RES) and the error clear button (ERR CLR) are pressed after the error has been eliminated	
9	Station number out of range	E 8	● ON	the setting of the station number is not within the range 00...63	the reset button (RES) is pressed after the error has been eliminated	
10	Error-free operation	0 0 0 0	⊗ OFF	correct operation of the unit		
11	Loop test error	x x	● ON		the reset button (RES) is pressed	xx: Loop test data at time of error
12	Operands out of coupler range	E 9	● ON	assigned operands lie outside the permissible coupler range	the reset button (RES) and the error clear button (ERR CLR) are pressed	

Notes:

1. The error display can also be reset by switching the voltage supply to the unit off and on again. Hardware faults cannot be eliminated by pressing the reset button.
2. If the ERR LED lights up, this always indicates a fault that must be taken seriously.
3. Even if an error occurs which will be eliminated automatically, the error code is displayed and stored until the ERR CLR or the RES button is pressed.
4. When several errors are detected at the same time, they are stored in the order in which they occurred. The 7-segment display shows the error code of the latest error to occur. By pressing the DSP CHG button the next respective error number can be displayed (cyclical switching).

4.10 Remote I/O coupler 07 CS 61 R202

for connection of ABB Procontic CS31 to ABB Procontic T200

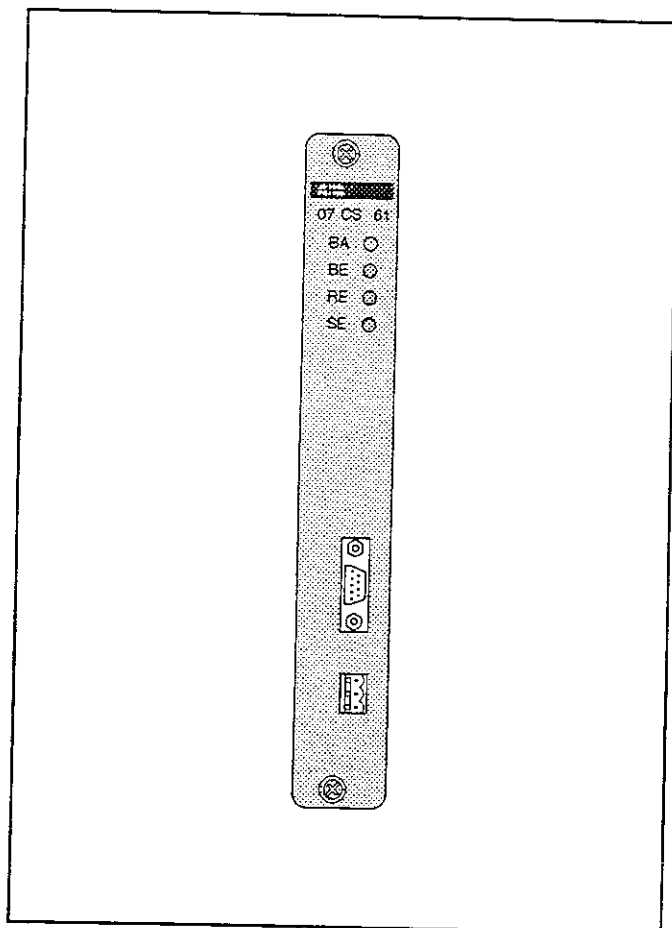

Fig. 4.10.1: Remote I/O coupler 07 CS 61 R202

Contents

Characteristics	4.10- 1
Module description	4.10- 1
Project planning	4.10- 1
Address allocation CS31 <-> T200	4.10- 6
Examples for address allocations	4.10-10
Transmission time	4.10-14
Diagnosis	4.10-14
Procedure in case of an error	4.10-18
Behaviour of the coupler if the central unit stops working	4.10-18
Behaviour of the coupler in case of an error	4.10-18
Self-tests of the internal coupling processor	4.10-18
Monitoring of the user configuration	4.10-18
Transmission of the analog formats	4.10-19
Technical data	4.10-19

Characteristics

Using the 07 CS 61 remote I/O coupler, networking with remote I/O modules of the ABB Procontic CS31 system and the ABB Procontic T200 control system is feasible with the ABB Procontic CS31 system bus (see Fig. 4.10.4).

The 07 CS 61 coupler has a CS31 bus interface to connect up to a maximum of 31 remote I/O modules.

Data interchange on the CS31 bus is carried out cyclically. Data to be transferred between T200 and CS31 is kept ready in a Dual-Port RAM, which is integrated in the coupler.

The CS 61 coupler always controls the CS31 bus performing the master function. In doing so, all telegrams necessary including diagnosis telegrams are processed. A short-form diagnosis is displayed with LEDs on the front panel. Data required for a detailed diagnosis can be read by the TCZ pocket terminal or by a PC or is provided in special flags of the ABB Procontic T200.

In the ABB Procontic T200 system, the 07 CS 31 coupler works in the same way as a 07 BR 60 remote I/O coupler.

The module addresses of CS31 remote I/O modules are set on the modules' mounting bases. Transfer of CS31 addresses into T200 addresses is carried out by means of the configuration table of the T200 software.

The CS31 bus is electrically isolated from the T200 bus.

For detailed diagnosis of the ABB Procontic CS31 bus the TCZ pocket terminal or a PC can be connected to the diagnostic interface of the 07 CS 61.

Module Description

The I/O coupler 07 CS 61 R202 is a successor module of the coupler 07 CS 61 R101. 07 CS 61 R202 completely replaces 07 CS 61 R101 which is no longer available in the future.

The coupler has a metal housing with a front panel including display elements, the diagnostic interface (as a 9-pole D-plug) and the 3-pole terminal block for connecting the ABB Procontic CS31 bus.

Light-emitting diodes are provided in order to display ready status for operation and errors (see Fig. 4.10.5).

Project Planning

The 07 CS 61 coupler can be placed in basic subracks and expansion subracks of the ABB Procontic T200 (see Fig. 4.10.4). Dependent on the configuration up to 4 couplers can be used (the sum of 07 CS 61 and 07 BR 60 couplers located in basic and expansion subracks of one system).

The positioning sequence of couplers in the basic subrack and in expansion subracks determines the number of the remote line. The couplers are given the numbers 1...4 in ascending order, starting with the 1st slot to the right of the central unit.

Comprehensive diagnostic facilities of the ABB Procontic CS31 system bus allows for simple monitoring and error detection both during commissioning and in operation.

Dependent on the used central unit, 512 or 1024 I/O points can be addressed per line to max. 31 ABB Procontic CS31 remote I/O modules. The number of I/O points can be set on a switch on the module's rear side. The setting has to be carried out before mounting the module into the subrack. The factory setting is 512 I/O points (switch is open). Fig. 4.10.2 to the right shows the settings.

The configuration of the remote I/O modules must be entered into the configuration menu of the programming software, in "Config.-PLC:2 System". If 512 I/O points are selected, the configuration identifier CS61 has to be entered. If 1024 I/O points are selected, the configuration identifier CS6B has to be entered (see the Fig. below). The current configuration of the remote I/O modules cannot be read back.

A commercially available shielded and twisted wire pair is used as transmission line (see Technical data).

The CS31 system bus must be terminated with a 120Ω termination resistor at both ends. The 07 CS 61 coupler already contains one termination resistor. The remote I/O modules must not be connected in a star-type network. Tap lines which are shorter than 1 m are allowed.

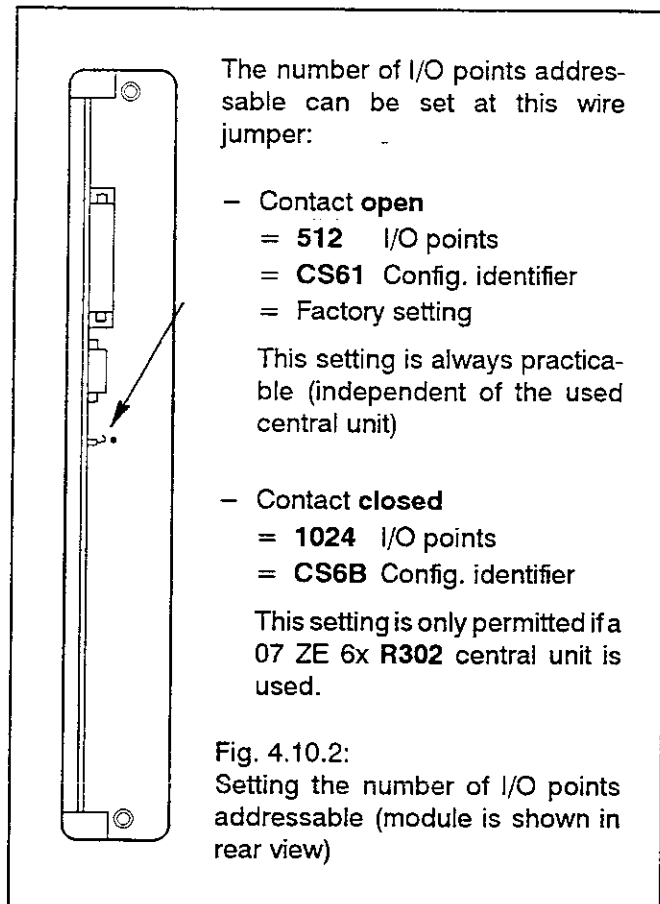

Configuration of the basic subrack

	00	01	02	03	04	05	06	07	08	09	Modules
GET			IR60	CS6B		BR60		ZB69			E16 E32 E64 A16 A32 A64
EW	BE60			BE61			BE62				EA16 EA32 EW4 EW8 AW4 AW8 EAW4 EAW8
1. EW											BR60
2. EW											ZB60 ZB69
3. EW											EI60
4. EW											KP60 KP6X
5. EW											IR60 CS61 CS6B BA16 BA32 BA64 LEER
	GET = Basic subrack EW = Expansion subrack										

Fig. 4.10.3: Entering the configuration identifier

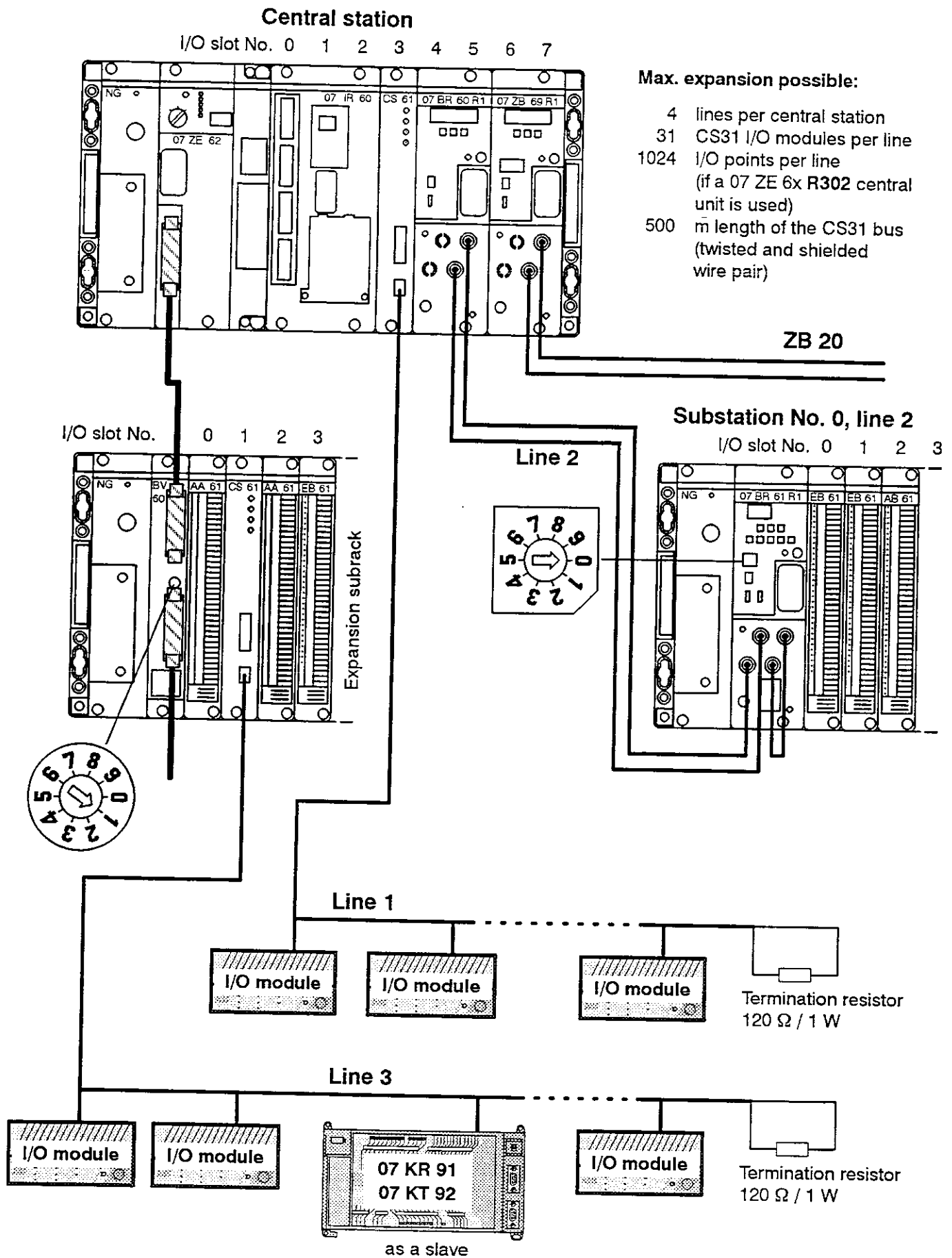
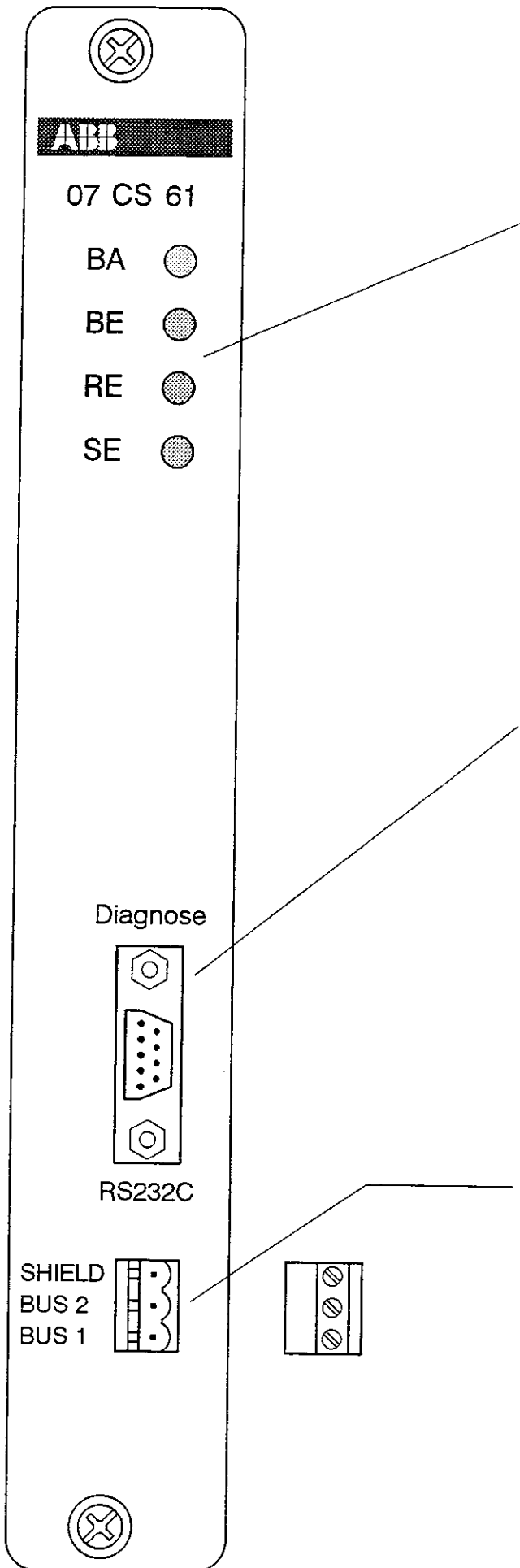

Fig. 4.10.4: Configuration example for the definition of 2 CS31 lines with ABB Procontic CS31 remote I/O modules, connected to 07 CS 61 R202 remote I/O couplers



Meaning of the LEDs

- BA Operation display,
07 CS 61 is addressed by the PLC
- BE Bus Error,
Communication error on
the CS31 bus
- RE Remote Unit Error,
Error in the remote I/O module
- SE Serial Unit Error,
Error in the CS31 bus master

Connectors

RS-232-C diagnostic interface

PIN	Signal name	Meaning
X3.1	PGND	Shield (Protective Ground)
X3.2	$\overline{\text{TxD}}$	Transmit Data
X3.3	$\overline{\text{RxD}}$	Receive Data
X3.4	–	unused
X3.5	–	unused
X3.6	–	unused
X3.7	0V	Signal Ground
X3.8	0V	Signal Ground
X3.9	+5V	Power supply for the TCZ pocket terminal

System cable FPTN 404948 R2 (refer to chapter diagnosis and configuration through the serial interface on page 4.10–14)

CS31 bus interface

PIN	Signal name	Meaning
X4.1	SHIELD	Shield (Protective Ground)
X4.2	$\overline{\text{T/R}} \text{ BUS 2}$	CS31 bus $\overline{\text{Transmit/Receive}}$
X4.3	T/R BUS 1	CS31 bus Transmit/Receive

The SHIELD terminal is internally connected to the coupler's housing.

Fig. 4.10.5:
Remote I/O coupler 07 CS 61 R202

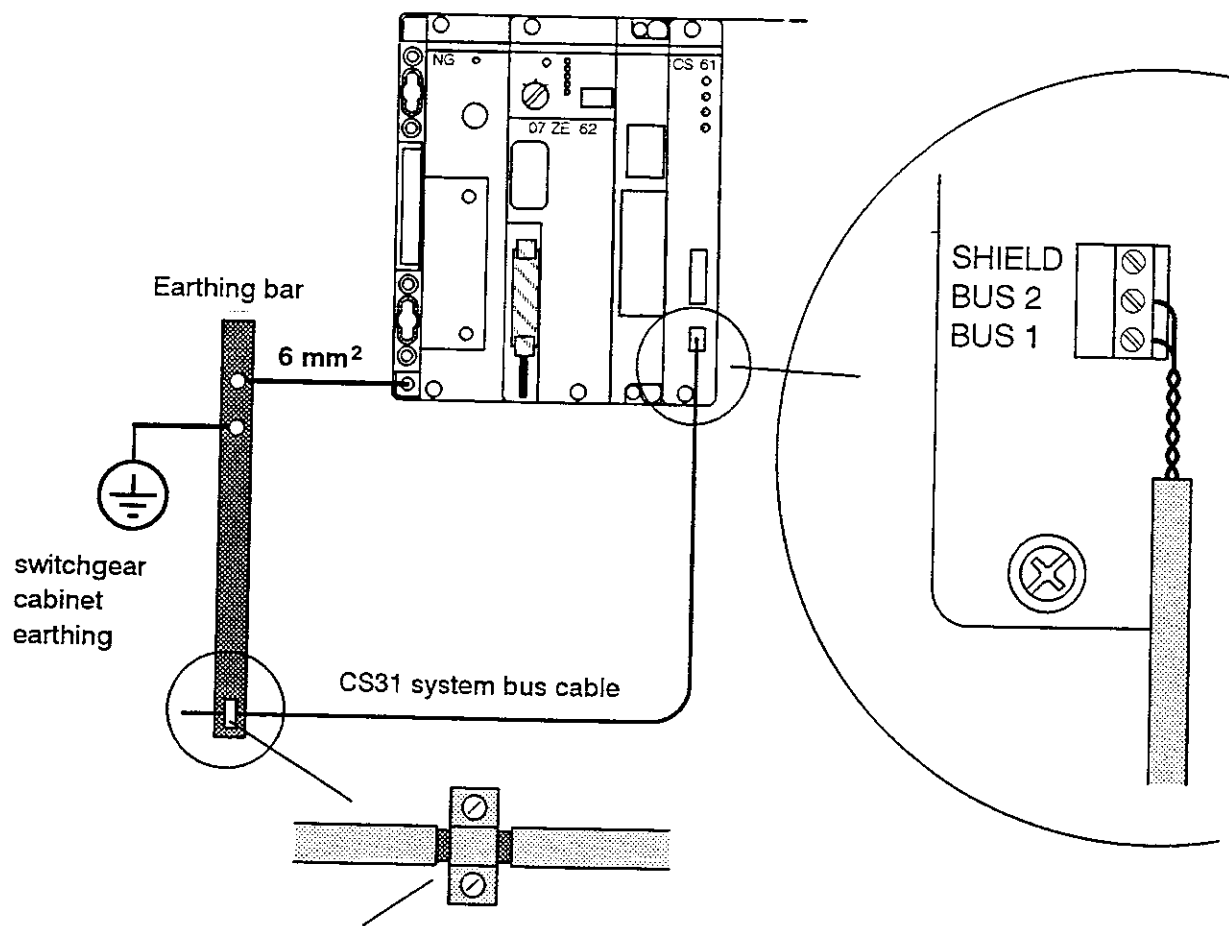

Earthing with a metal clamp at the earthing bar or earthing point of the switchgear cabinet.

For more information on the entire CS31 system bus earthing conception see the CS31 system description.

Fig. 4.10.6: Earthing the CS31 system bus cable at the 07 CS 61 coupler (bus master)

Address allocation CS31 <-> T200

For the transfer of data from the Dual-Port RAM into the transfer memory an allocation between the CS31 module addresses and the T200 addresses (identifier) must be carried out. This allocation is performed in the configuration table of the ABB Procontic T200. The following table shows the allocation.

The line number (top left corner of the figure) refers to the slot in the system. Line 1 is the nearest slot to the central unit. ABB Procontic CS31 module addresses ending with a 9 cannot be entered into this table and must not be set on the DIL switches of the CS31 module sockets.

Configuration of the remote I/O expansion

L 01	00	01	02	03	04	05	06	07	08	09	Modules
0. UST			EW4								E16 E32 E64 A16 A32 A64
1. UST					E16		E16				EA16 EA32 EW4 EW8
2. UST				A16							AW4 AW8 EAW4 EAW8
3. UST		EA16									BR60 ZB60 ZB69
4. UST											EI60 KP60 KP6X
5. UST				A16							IR60 CS61 CS6B BA16 BA32 BA64
6. UST											LEER
7. UST											
8. UST											
9. UST											

Meaning of the entries as an example: EW 1. 0 2,..

Identifier (E, A, EW, AW)
Line number (1...4)
Module address (00...63)

The number of channels of the selected module must be greater than or equal to the number of channels in the CS31 remote module.

UST = Remote substation

Fig. 4.10.7: Allocation of the CS31 module addresses

Permissible CS31 module addresses

(Permissible settings of the DIL switch on the plug-in base)

for bit modules: 0 1 2 3 4 5 6 7 8
 10 11 12 13 14 15 16 17 18
 20 21 22 23 24 25 26 27 28
 30 31 32 33 34 35 36 37 38
 40 41 42 43 44 45 46 47 48
 50 51 52 53 54 55 56 57 58
 60 61 62 63

for word modules: 0 1 2 3 4 5 6

Meaning of the DIL switches on the CS31 plug-in base ECZ:

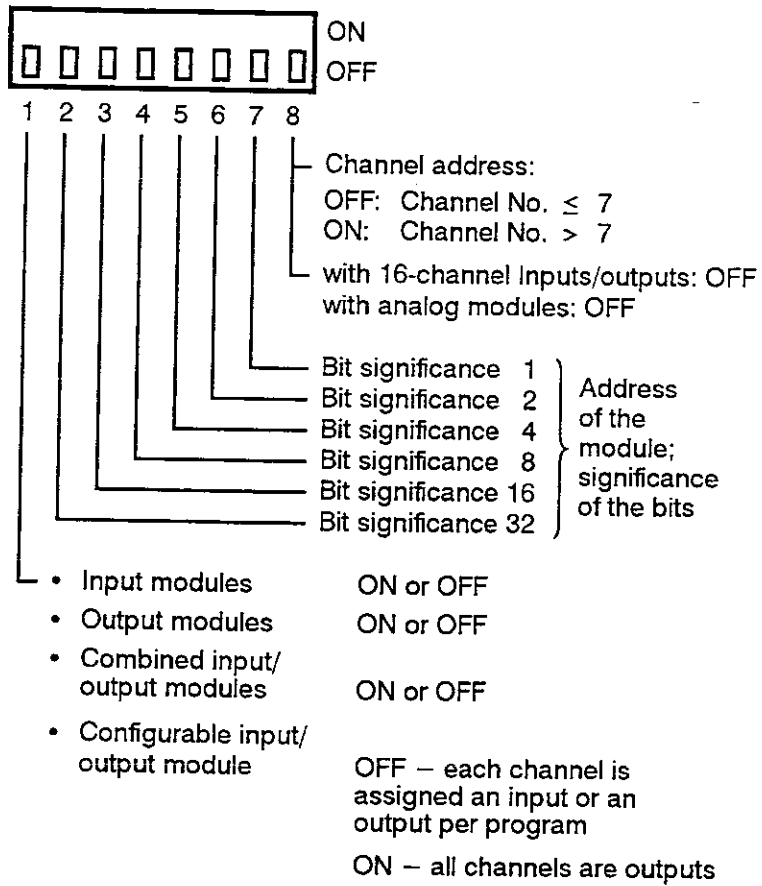

Example for a module address setting on the plug-in base ECZ:

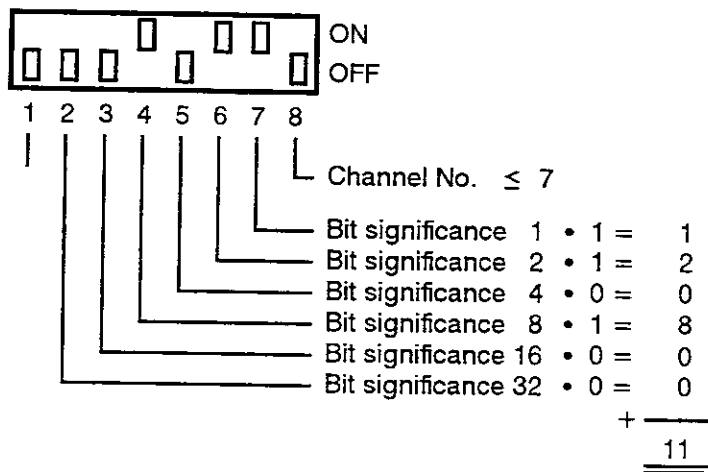

Fig. 4.10.8: Meaning of the DIL switches on the CS31 plug-in base ECZ and example for a module address setting

Setting examples (overview)

Module type, referred to the I/O terminals	Address switch on the ECZ plug-in base	07 CS 61	Configuration identifier T200	Allowed addresses
8 analog outputs	Address 0, ≤7		AWm.00,00...AWm.00,07	AW8 0...6
8 analog inputs	Address 1, ≤7		EWm.01,00...EWm.01,07	EW8 (2=OFF, 3=OFF: Analog representation (a))
4 analog inputs and 4 analog outputs	Address 2, ≤7		EWm.02,00...EWm.02,03 AWm.02,04...AWm.02,07	EAW4
8 binary inputs	Address 3, ≤7		Em.03,00...Em.03,07	EA16 1... 8 10...18 20...28 30...38 40...48 50...58 60...63
8 binary inputs	Address 3, >7		Em.03,08...Em.03,15 Combined here under one address	
8 binary outputs	Address 3, ≤7		Am.03,16...Am.03,23	
8 binary outputs	Address 3, >7		Am.03,24...Am.03,31	
8 binary inputs	Address 4, ≤7		Em.04,00...Em.04,07 (single input module)	E16
16 binary inputs	Address 5, ≤7		Em.05,00...Em.05,15 Combined here under one address	EA16
16 binary outputs	Address 5, ≤7		Am.05,16...Am.05,31	
32 binary outputs	Address 6, ≤7		Am.06,00...Am.06,15 Am.07,00...Am.07,15	A32
8 binary inputs and 8 binary outputs	Address 8, ≤7		Em.08,00...Em.08,07 Am.08,16...Am.08,23 Combined here under one address	EA16
8 binary inputs and 8 binary outputs	Address 8, >7		Em.08,08...Em.08,15 Am.08,24...Am.08,31	
16 binary inputs and 16 binary outputs	Address 9, ≤7		Em.09,00...Em.09,15 Am.09,16...Am.09,31	EA16
32 binary inputs and 32 binary outputs	Address 10, ≤7		Em.10,00...Em.10,31 Am.10,32...Am.10,63	EA32

Max. 31 slave modules on the CS31 bus

Max. number of bits per 07 CS 61: 1024 (1 binary signal = 1 bit, 1 analog signal = 16 bits)

Kinds of entries in the T200 configuration table, dependent on the different CS31 module types

Each I/O module, connected to the 07 CS 61 coupler via the CS31 system bus, has to be entered into the T200 configuration list of the coupler. The following table shows the module types.

CS31 I/O module type	Entry in die T200-configuration list (corresponding module for T200)	Number of transmitted bits between T200 central unit and 07 CS 61	Remarks
8 channels input binary	E16	16	1)
16 channels input binary	E16	16	
8 channels output binary	A16	16	1)
16 channels output binary	A16	16	
32 channels output binary	A32	32	Festo Island PCZB Slave 07KR/KT Slave
16 channels in-/output binary	EA16	32	
32 channels in-/output binary	EA32	64	
8 channels input analog	EW8	128	
4 channels output analog	AW4	64	
combined modules 4 channels input analog +2 channels output analog	EAW4	128	
high-speed counter (ICSF 08 D1)	EAW8	256	

1) Two CS31 modules can be allocated to one module.

Notes:

In the T200, CS31 modules with both input and output channels are addressed under the same address, but with different channel numbers.

e.g. • CS31 module ICSC 08 L1 (8 channels configurable as input or output):

Set CS31 module address: 5
 CS61 coupler: Line 1, entered module: EA16
 Identifier in the T200 program: E 1.05,00...07
 A 1.05,16...23

Note that the channel numbers 8...15 and 24...31 are not covered.

Identifier when configuring via the serial interface with TCZ or PC:

I 0500...0507
 A 0500...0507

• CS31 module ICSM 06 A6 (4 analog input channels + 2 analog output channels):

Set CS31 module address: 4
 CS61 coupler: Line 1, entered module: EAW4
 Identifier in the T200 program: EW 1.04,00...03
 AW 1.04,04...05

Identifier when configuring via the serial interface with TCZ or PC:

AI 0400...0403
 AO 0400...0401

If a binary module is entered

- of types E32, A32 or EA32, the following slot (address) must not be used for a another binary module,
- of types E64 or A64, the following three slots (addresses) must not be used for further binary modules.

Using such slots (addresses) for modules of types EW, AW, EAW, however, is possible – but only for the addresses 0...6.

Expansion possibilities when using 07 CS 61 couplers

The project planning meets the following limits:

- max. **4 couplers** (sum of 07 CS 61 couplers plus 07 BR 60 in basic and expansion subracks in one system)
- max. **31 CS31 modules** per line
- max. **1024 I/O points** per coupler, if 07 ZE 6x R302 central units are used
max. 512 I/O points per coupler, if 07 ZE 6x R101 or R201 central units are used
- permissible addresses for analog modules: 0...6, i.e. maximum **7 analog modules** per line
- The binary input and output modules can be in any allocation.

Examples for address allocations

Example 1: 07 CS 61 R202 in basic subrack for line 1

CS31 module type	quantity	setting on the CS31 module (CS31 module address)	corresponding module	transmitted data bits	identifier in the T200 program
analog input, 4 channels	1	02, ≤ 7	EW4	64	EW 1.02,00...03
binary input, 8 channels	2	14, ≤ 7 and 14, > 7	E16	16	E 1.14,00...15
binary input, 16 channels	1	16, ≤ 7	E16	16	E 1.16,00...15
binary output, 8 channels	1	23, ≤ 7	A16	16	A 1.23,00...07
binary output, 16 channels	1	31, ≤ 7	EA16	32	E 1.31,00...15 and A 1.31,16...31
binary output, 8 channels	2	53, ≤ 7 and 53, > 7	A16	16	A 1.53,00...15
07 KR 91 / 07 KT 92 as a slave	1	51 (system constant)	EA32	64	E 1.51,00...31 and A 1.51,32...63
				Σ	224

Configuration of the remote I/O expansion

L 01	00	01	02	03	04	05	06	07	08	09	Modules
0. UST			EW4								E16 E32 E64
1. UST					E16		E16				A16 A32 A64
2. UST				A16							EA16 EA32
3. UST		EA16									EW4 EW8
4. UST											EAW4 EAW8
5. UST		EA32	*	A16							BR60
6. UST											ZB60 ZB69
7. UST											EI60
8. UST											KP60 KP6X
9. UST											IR60
											CS61 CS6B
											BA16 BA32 BA64
											LEER

* This slot (address) is additionally shared by the EA32 module on the left.

UST = Remote substation

Meaning of the entries in the example: EW 1. 0 2,..

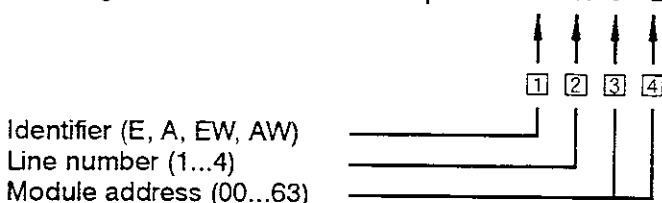

The number of channels of the selected module has to be greater than or equal to the number of channels in the CS31 remote module.

Fig. 4.10.9: Allocation of the CS31 module addresses (07 CS 61 in basic subrack for line 1)

Example 2: 2 couplers 07 CS 61 R202 in one basic subrack

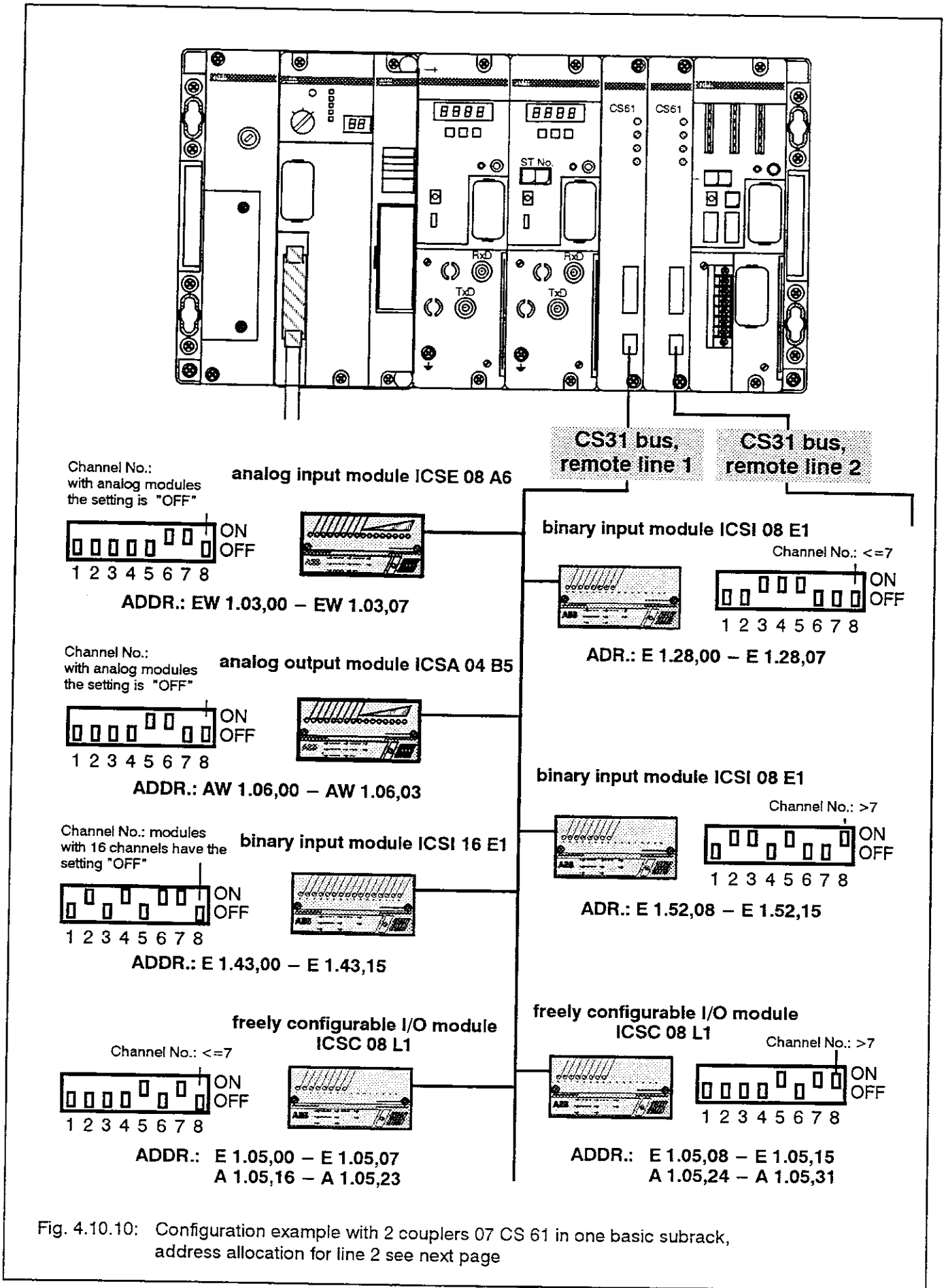

Fig. 4.10.10: Configuration example with 2 couplers 07 CS 61 in one basic subrack, address allocation for line 2 see next page

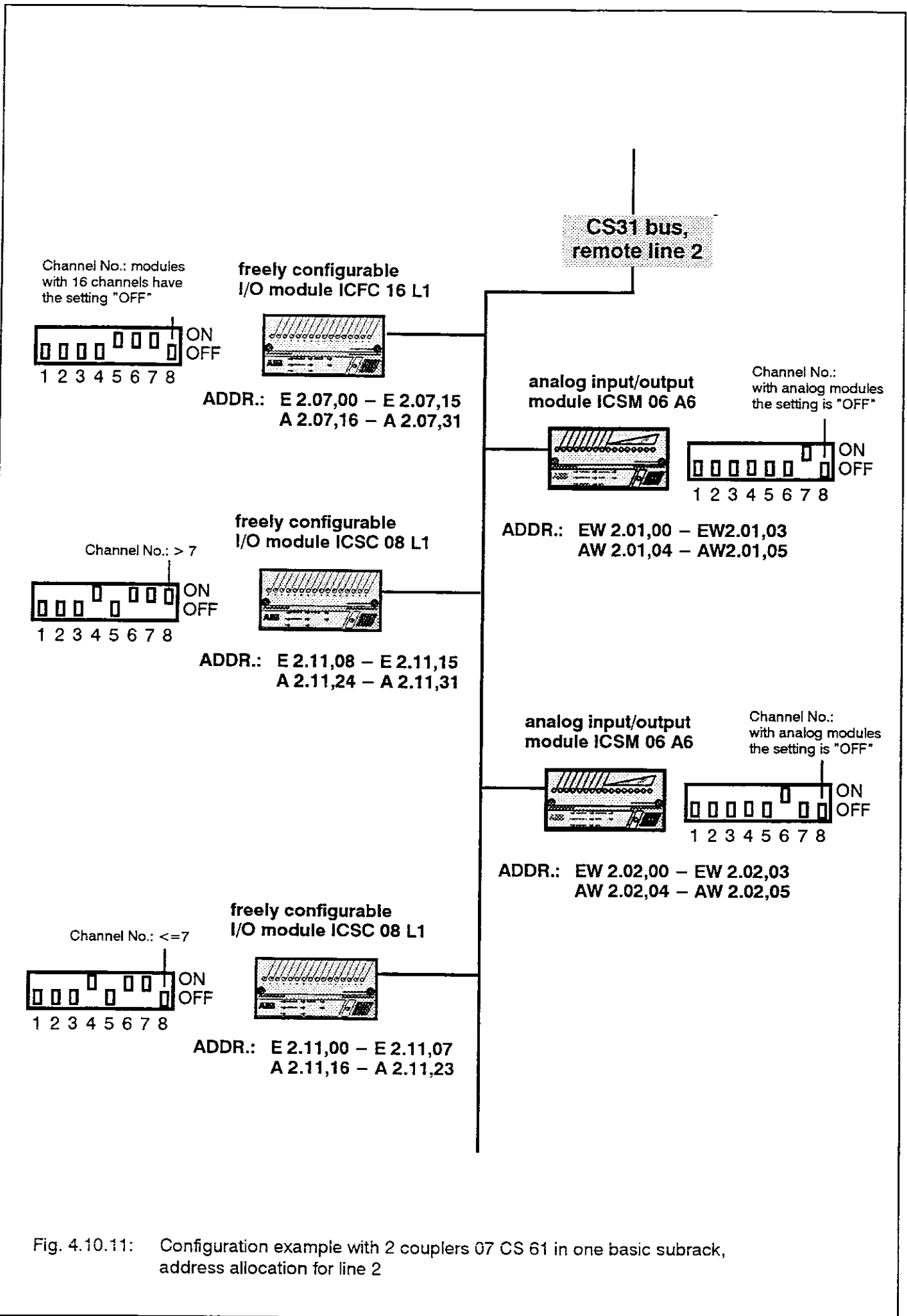

Fig. 4.10.11: Configuration example with 2 couplers 07 CS 61 in one basic subrack, address allocation for line 2

Configuration table for example 2 Line 1:

Configuration of the remote I/O expansion

L 01	00	01	02	03	04	05	06	07	08	09	Modules
0. UST				EW8		EA16	AW4				E16 E32 E64
1. UST											A16 A32 A64
2. UST									E16		EA16 EA32
3. UST											EW4 EW8
4. UST				E16							AW4 AW8
5. UST											EAW4 EAW8
6. UST											BR60
7. UST											ZB60 ZB69
8. UST	Addresses >63 do not exist										EI60
9. UST*											KP60 KP6X
	Addresses >63 do not exist										IR60
											CS61 CS6B
	Addresses >63 do not exist										BA16 BA32 BA64
											LEER

Possible entries:

* UST means remote substation

- E16 uses 16 I/O points on the remote I/O line
- A16 uses 16 I/O points on the remote I/O line
- EA16 uses 32 I/O points on the remote I/O line
- EW8 uses 128 I/O points on the remote I/O line
- AW4 uses 64 I/O points on the remote I/O line
- EAW4 uses 128 I/O points on the remote I/O line
- EAW8 uses 256 I/O points on the remote I/O line (Caution: not useful, better EAW4 !!!)

Configuration table for example 2 Line 2:

Configuration of the remote I/O expansion

L 02	00	01	02	03	04	05	06	07	08	09	Modules
0. UST		EAW4	EAW4					EA16			E16 E32 E64
1. UST		EA16									A16 A32 A64
2. UST											EA16 EA32
3. UST											EW4 EW8
4. UST											AW4 AW8
5. UST											EAW4 EAW8
6. UST											BR60
7. UST											ZB60 ZB69
8. UST	Addresses >63 do not exist										EI60
9. UST*											KP60 KP6X
	Addresses >63 do not exist										IR60
											CS61 CS6B
	Addresses >63 do not exist										BA16 BA32 BA64
											LEER

Possible entries:

* UST means remote substation

- E16 uses 16 I/O points on the remote I/O line
- A16 uses 16 I/O points on the remote I/O line
- EA16 uses 32 I/O points on the remote I/O line
- EW8 uses 128 I/O points on the remote I/O line
- AW4 uses 64 I/O points on the remote I/O line
- EAW4 uses 128 I/O points on the remote I/O line
- EAW8 uses 256 I/O points on the remote I/O line (Caution: not useful, better EAW4 !!!)

Fig. 4.10.12: Configuration example with 2 couplers 07 CS 61 in one basic subrack, configuration tables

Transmission time

The I/O data of the remote modules are addressed via a memory image in the 07 CS 61 coupler. This memory image is written to or read from the remote modules asynchronously to the PLC cycle. The total transmission time consists of the time to copy data from the T200 bus to the memory image and the CS31 bus cycle time.

Time for the copy procedure:

1...6 ms depending on the number and type of the remote modules (number of I/O points)

CS31 bus cycle time:

typ. 5...15 ms depending on the number and type of the remote modules (see CS31 documentation)

Diagnosis

The 07 CS 61 coupler provides

- a short-form diagnosis with LEDs on its front panel
- an extensive and detailed diagnosis when using the TCZ handheld terminal or a PC/terminal
- diagnosis data in T200 special flags for evaluation in the PLC program.

Meaning of the LEDs on the front panel

The operating condition of both the coupler and the CS31 system bus is displayed on the front panel of the 07 CS 61 coupler in the following way:

- BA** Operation display,
07 CS 61 is addressed by the PLC
- BE** Bus Error,
communication error on
the CS31 bus
- RE** Remote Unit Error,
error in the remote I/O module
- SE** Serial Unit Error,
error in the CS31 bus master

LED	BA	BE	RE	SE	Meaning	Remedy
	gn	rd	rd	rd		
☆	□	□	□		everything ok., bus is running. Coupler is addressed by the PLC.	--
☆	□	□	☆		Error in the CS31 bus processor, e.g. Dual-Port RAM defective or EPROM error.	<ul style="list-style-type: none"> ● Voltage OFF/ON. If unsuccessful, device is defective.
□	☆	☆	☆		Initialization phase after power ON	--
□	X	X	X		Only a short time during the transition of the T200 central unit from STOP → RUN or RUN → STOP (no error)	--
☆	☆	□	□		The 07 CS 61 coupler cannot find any remote modules at the CS31 bus <u>after</u> power ON or at least 3 remote modules are present on the CS31 bus and 2 modules do not respond any more.	<ul style="list-style-type: none"> ● Insert remote modules. ● Check CS31 bus line. ● Check power supply of the remote modules. ● Interpret error flags. ● Interpret error flags. ● Check power supply of the remote modules. ● Check CS31 bus line. ● Check remote modules.
☆	☆	☆	□		Only 1 remote module is present on the CS31 bus and does not respond any more.	<ul style="list-style-type: none"> ● Interpret error flags. ● Check power supply of the remote modules. ● Check CS31 bus line. ● Check remote modules.
☆	☆	☆	☆		At least 2 remote modules are present on the CS31 bus and do not respond any more.	<ul style="list-style-type: none"> ● Interpret error flags. ● Check power supply of the remote modules. ● Check CS31 bus line. ● Check remote modules.
☆	□	☆	□		Error message of a remote module, e.g. broken wire	<ul style="list-style-type: none"> ● Interpret error flags. ● Check remote modules.
□ = LED off, ☆ = LED on, X = LED on or off, gn = green, rd = red						

Diagnosis and configuration through the serial interface (RS-232)

System cable FPTN404948R0002

The system cable (order No. FPTN404948R0002) is intended for the connection between the central units UCZA, PCZB, CS20 or the coupler 07 CS 61 with a personal computer. The cable length is 2 m.

9 pole
SUB-D plug
female

PC

9 pole
SUB-D plug
male

UCZA
PCZB
CS20
07 CS 61

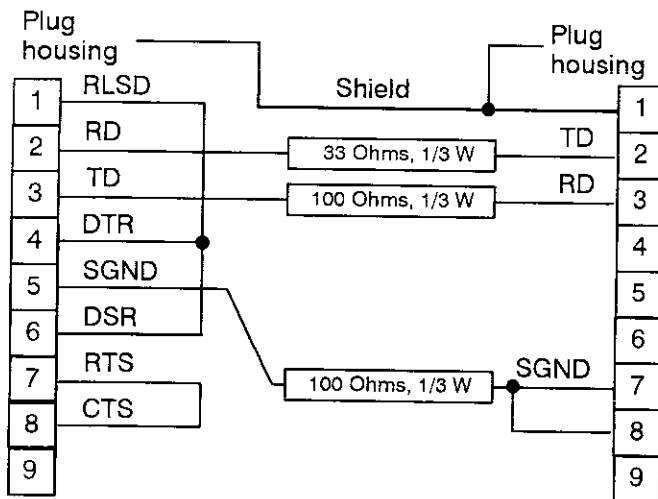

TD	Transmitted data
RLSD	Receive line signal detector
RD	Received data
RTS	Request to send
CTS	Clear to send
SGND	Signal ground
DTR	Data terminal ready
DSR	Data set ready

Fig. 4.10.13: System cable FPTN404948R0002

Using the cable FPTN404948R1/R2, diagnosis and configuration at the CS31 bus can be performed with the TCZ programming and diagnosis unit or with a PC via the serial interface.

Serial interface

If a PC is used, the interface of the PC has to be set to 9600 Baud, 8 data bits without parity, 1 start bit, 1 stop bit, no hardware handshake.

Setting of the serial interface, when the 907 PC 32/33 software is used in terminal mode:

In order to set the interface parameters please select the point "CONFIGURATION" in the Main Menu and then select "V24 CONFIGURATION" there.

Settings:

Channel : COM 1 or COM 2
 Baud rate : 9600
 Data bits : 8
 Stop bits : 1
 Parity : no
 Protocol : XON/XOFF
 Echo : no
 Line feed : CR/LF, CR (alternatively)
 Control characters : no

The menu point is left on pressing the <ESC> key.

Please establish the connection between the selected interface of your computer and the interface of the 07 CS 61 now.

Possible configuration and diagnosis functions

- Configuration of the modules operating on the bus
- Setting the module parameters
- Location of the faulty module
- Kind of Remote Unit Error (RE):
 - Short circuit
 - Overload
 - Broken wire
- Error acknowledgement

Further handling is described in the ABB Procontic CS31 system description, part TCZ with UCZA, volume 7.3, as of chapter 2.2, as of page 2-3.

Diagnosis data for evaluation in the PLC program

The CS31 bus processor stores max. 8 diagnosis messages into the Dual-Port RAM. This diagnostic data coming from the CS31 system bus is transferred to the error messages of the T200. The diagnostic data is transferred to the special flag range.

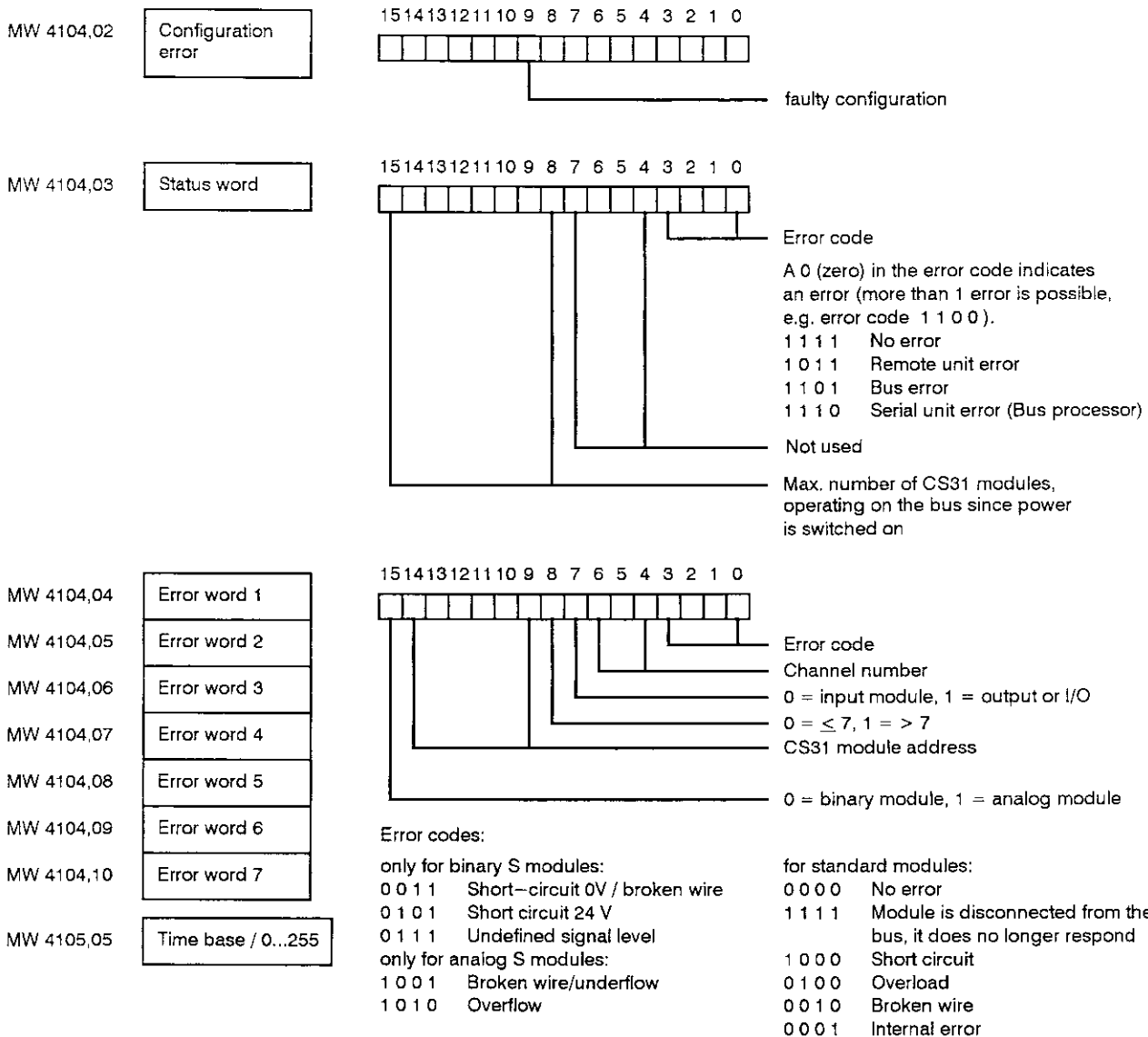

The word flag MW 4104,03 (status word of the 07 CS 61 coupler) is suitable for a constant control of the CS31 system bus by the PLC program. In this way, the start of the program can be made conditional on the number of the modules operating on the bus. This can be useful, if a system is working with more than one supply voltage.

The error words 1...7 are not stored, i.e. if an error (e.g. a broken wire) is repaired and acknowledged by the pushbutton on the module or via the serial interface, then the corresponding word flag is reset to 0 automatically.

The order of the word flags is dependent on the chronological order the errors occur. Max. 4 errors can be reported per remote module. Each of them need one word flag.

Note: For the evaluation of the error flags the flag content has to be considered hexadecimally.

- System flag for line 1: MW 4104,02...10 (see example above)
- System flag for line 2: MW 4105,10...15 and MW 4106,00...02
- System flag for line 3: MW 4107,02...10
- System flag for line 4: MW 4108,10...15 and MW 4109,00...02

Fig. 4.10.14: T200 error flags for CS31 remote modules

ERR- No. T200 CPU	Coupler LEDs BA BE RE SE	System flags		Causes
		M125,0	MW.....	
41	0 x x x	0	MW4096,02 (contains the slot number)	<ul style="list-style-type: none"> – System configuration is faulty (CS61 is located in a wrong slot, does not exist or wrong setting of the addressable data points see Fig. 4.10.2) or – Error occurred during self-test of the coupler (checksum error, RAM error, initialization error) or – only a short time during the transition of the T200 central unit from STOP → RUN or RUN → STOP (no error)
43	1 0 0 0	1	MW4104,02 * (bit 9) MW4096,06 (contains the slot number of the coupler)	<ul style="list-style-type: none"> – Configuration error (wrong entry in the T200 configuration table): for the CS61 coupler applies: <ul style="list-style-type: none"> – CS31 module address < 64 – CS31 module address for word modules < 7 – Number of entered modules < 32
43	1 0 0 1	1	MW4104,03 *	– Internal error on the CS31 bus processor
43	1 1 0 0	1	MW4104,03 *	<ul style="list-style-type: none"> – CS31 bus processor does not find any remote modules on the CS31 bus after power on or – at least 3 remote modules are present on the CS31 bus and 2 modules do not respond any more.
43	1 1 1 0	1	MW4104,03 *	– Only 1 remote module is present on the CS31 bus and does not respond any more.
43	1 1 1 1	1	MW4104,03 *	– At least 2 remote modules are present on the CS31 bus and do not respond any more.
00	1 0 1 0	0	MW4104,03 * MW4104,04 * ⋮ MW4104,10 *	<ul style="list-style-type: none"> – Remote Unit Error (external device error) e.g. broken wire, short circuit see also contents of the T200 error flags
00	1 0 0 0	0	MW4104,02 * = 0 MW4104,03 * = ---> MW4104,04 * = 0 ⋮ MW4104,10 * = 0	<ul style="list-style-type: none"> – Normal operation without error Status word Bits 8...15 contain the number of modules on the bus Bits 0...3 = 1; Code: no error
<p>x = 0 or 1 * = System flags for line 1, the lines 2, 3 and 4 have corresponding system flags (see Fig. 4.10.14)</p>				

Fig. 4.10.15: Error table for the 07 CS 61 coupler

Procedure in case of an error

- **Read the error number** on the T200 central unit or the LEDs on the coupler, without evaluation in the PLC program

Error No. on the T200–CPU (see also error table on the previous page):

41 and coupler LED BA = 0

appears only after power ON; system configuration is faulty (07 CS 61 in a wrong slot or does not exist) or error during the self–test of the coupler

43 and coupler LEDs BE = 0, RE = 0, SE = 0

configuration error in the configuration table for the CS31 system bus. The error 43 appears if, for example, the output A1.00,00 is addressed in the program and the module is not entered in the configuration table

43 and at least coupler LED BE = 1

error on the CS31 system bus (see also error table), further diagnosis via the serial interface

00 and coupler LED RE = 1

error on a CS31 remote module (e.g. broken wire, further diagnosis via the serial interface, see also TCZ description)

- **Evaluation in the PLC program**

Error flag M 125.0 = 1

indicates configuration error or bus error, further distinction with MW 4104,02:
bit 9 = 1 means configuration error,

MW 4104,03 contains error words concerning bus errors and bus processor errors (see also T200 error flags in Fig. 4.10.14)

MW 4104,04...10 contain more precise information on the bus error

Error flag M125.0 = 0 and MW 4104,03 presents error code for Remote Unit Error, see also T200 error flags

in MW 4104,04...10 are statements concerning the error and the remote module

Behaviour of the coupler if the central unit stops working

If the central unit of the ABB Procontic T200 is switched to STOP, the CS31 bus processor deletes the output data of the Dual–Port RAM and thus the output data for the bus.

About 200 ms later after the T200 is powered off the output modules turn all channel signals to 0.

Behaviour of the coupler in case of an error

For error table see previous page.

In order to monitor the internal coupling processor respectively the CS31 bus processor the 07 CS 61 coupler is equipped with a hardware watchdog. When the watchdog reacts, a reset signal is generated for the coupling processor or the CS31 bus processor respectively. There is no difference between a reset triggered after power–on and by the watchdog, i.e. also the watchdog reaction causes a short interruption on the CS31 bus and thus at the output channels.

Self–tests of the internal coupling processor

After power–on, the coupling processor performs the following self–tests:

- Checksum test of the EPROM
- RAM test of the T200 transfer RAM
- Time monitoring of the initialization on the T200 bus to 30 seconds.

Reaction to one of those errors:

- The green LED (BA) remains off.
- The test in which the error has been detected is repeated cyclically.
- No data transmission to the CS31 bus.

Monitoring of the user configuration

The coupling processor checks the user configuration after power–on and after switching from STOP to RUN. The following is checked:

- Word address < 7
- Bit address < 64 and not 9, 19, 29, 39, 49, 59
- Number of entered modules < 32

Notice: The number of modules connected to the CS31 bus is not checked. To do this, the diagnostic data in the PLC program has to be evaluated. It is possible to configure two CS31 modules to one T200 module by setting the channel addresses ≤ 7 and > 7 on the CS31 modules.

In case of an error the system flag M125,00 is set and in the same way the bit 9 in the system word flag MW4104,02 for the 1st line or, in case of another line, the bit 9 of the corresponding word flag. The central unit now reports the error 43 and turns to STOP if configured correspondingly. The slot position of the involved CS 61 coupler is specified in the system word flag MW4096,06.

No data is transferred to the CS31 bus in case of an error. The green LED is turned on.

The coupling processor does not change the analog formats. The 16 bit word is transferred without processing. The user can

- select from 3 format settings on the CS31 modules (MICAS format; left-justified or right-justified storage of the 8 or 12 data bits), refer to the CS31 documentation
- adapt the format by using conversion CEs (ANAI, ANAO).

Transmission of the analog formats

Technical Data

Configuration

Number of configurable lines (couplers 07 CS 61 in basic and/or expansion subracks)

Number of configurable lines per system (the sum of CS 61 and BR 60 couplers)

Max. address range per line

Max. address range for 4 lines

Max. number of CS31 remote I/O modules per line

Signalling

Current consumption from internal voltages

UB1 = 5 V DC

UB4 = 24 V DC

Total power dissipation

Number of required slots

Configuration identifier in programming software (inserted in basic or expansion subrack)

set to 512 I/O points

set to 1024 I/O points

Ability of fitting in subracks

slot,

- = plug-in is possible (1 slot)

Interfaces

Diagnostic interface:

Interface standard

Interface connector

Transmission speed

Length of characters

Parity

Number of start bits

Number of stop bits

07 CS 61 R202

max. 4 (one 07 CS 61 per line is required)

max. 4

1024 I/O points ¹⁾ ²⁾

4096 I/O points

31

4 LEDs, see Fig. 4.10.5

max. 0.45 A

no current consumption

max. 2.3 W

1 I/O slot

CS61

CS6B

BT			BE-central			BE-remote		
NG	ZE	I/O	NG	BV	I/O	NG	BV	I/O
		●			●			

1) 1 bit channel occupies 1 I/O point
1 word channel occupies 16 I/O points

2) 1024 I/O points when using 07 ZE 6x R302 central units
512 I/O points when using 07 ZE 6x R101 and R201 central units

CS31 bus interface:

Interface standard	RS-485
Interface connector	3-pole plug with screw-type terminals
Transmission speed	187.5 kbaud
Length of characters	8 bits + 1 selection bit for address/data
Number of start bits	1
Number of stop bits	1
Data transmission security	CRC8 (Hamming distance 4)
Transmission mode	halfduplex, asynchronous
Bus termination resistor, integrated in coupler	120 Ω

Transmission cable for the CS31 bus

Type of cable	twisted wire pair (shield is recommended)
Cable length for the CS31 bus	max. 500 m (shielded)
Conductor cross section	min. 0.2 mm ² \cong AWG 24 (twisting rate 10/m)
Cable capacitance	< 37 pF/m
Attenuation	\leq 1,5 dB per 100 m @ 1 MHz
Characteristic impedance	135...165 Ω

Mechanical data

Dimensions	1 slot
Weight	900 g

Ordering information

Order number	07 CS 61 R202	GJR5240300R202
Accessories (supplied):		1 3-pole interface plug for connecting the CS31 bus

5 Central Units

- 07 ZE 60: Central unit for max. 1 subrack with max. 8 I/O slots, only remote I/O expansion possible
- 07 ZE 61: Central unit for max. 2 subracks with max. 18 I/O slots in central expansion with 1 subrack, additional remote I/O expansion possible
- 07 ZE 62: High-speed central unit for max. 6 subracks with max. 58 I/O slots in central expansion with 5 subracks, additional remote I/O expansion possible
- 07 ZE 63: Central unit for max. 6 subracks with max. 58 I/O slots in central expansion with 5 subracks, additional remote I/O expansion possible

One common feature of all central units is a 7-segment display that displays detected errors in the form of an error number. Following the hardware description of the central units listed above, the following topics are dealt with in additional chapters:

Central-unit error messages
Remedy at error occurrence
Internal bit flags
Internal word flags
Operands

The central units version R201 replace the central units version R101 entirely.

The central units version R302 replace the central units version R101 and R201 entirely.

New capabilities added by versions R201 and R302:

From R101 to R201:

- PID control feature; additionally using the corresponding software blocks of the block library expansion 907 PB 361 (function blocks and description, order No. GJP5 2018 00 R102).

From R201 to R302 and using program memories 07 PS 6x R2/R3 or 07 PR 6x R2:

- **16 % faster command processing** for all commands
- **Improved ONLINE programming.** When using the program memories 07 PS 6x R3, ONLINE program changes result in only very short switch-over times of the central unit. This signifies additionally faster ONLINE changes using 07 PS 6x R3.
- **Integrated real-time clock on the central unit.**
Date: day, day of the week, month, year
Time: seconds, minutes, hours
The data is stored and backed in the central unit's special flag area.
- **Remote address area expanded** to 1024 bits per ABB Procontic CS31 system bus line.
- **Additional square root function block.** Available in conjunction with 907 PC 33 for ABB Procontic T200.
- **Additional signalling of a battery fault** by a red LED on the front.

5.1 Central Units 07 ZE 60, 07 ZE 61, 07 ZE 62 and 07 ZE 63

07 ZE 60: for max. 1 subrack with max. 8 I/O slots,
max. user program 7.6 k instructions

07 ZE 61: for max. 2 subracks with max. 18 I/O slots,
max. user program 15.7 k instructions

07 ZE 62: high-speed central unit for max. 6 subracks with max. 58 I/O slots,
max. user program 48.5 k instructions

07 ZE 63: for max. 6 subracks with max. 58 I/O slots,
max. user program 15.7 k instructions

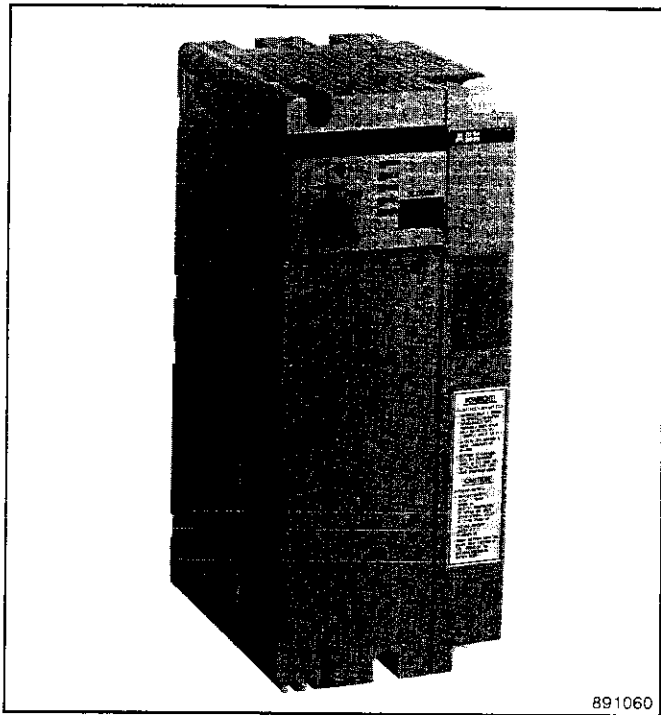

Fig. 5.1: Central unit 07 ZE 62 equipped with a program memory 07 PS 60

Features

The central unit is the central arithmetic and logic unit, which processes the process-oriented logic operations given by the user program. It receives and processes binary and analog input data and transfers them to output modules and communication units.

The operation state (RUN, REMOTE, STOP) has to be set by means of a keylock switch. Operating modes, diagnostic states and battery faults are indicated by LEDs.

The central unit has self-diagnostic capabilities such as memory test, watchdog, bus and battery monitoring

and syntax error monitoring of the user program. Detected errors are displayed along with their numbers (7-segment LED display). Possible errors, their causes and remedies on occurrence of these errors are summarized in tables at the end of this chapter. Test possibilities such as single step, single cycle, forcing and overwriting are available.

The R.CL. (Register Clear) pushbutton serves to reset the battery-backed flag areas. Pressing R.CL. also clears the flags M 124.00 to M 125.15 and MW4096.00 to MW4096.15.

A serial EIA-232 interface (15-pin SUB-D connector, female) allows connection of the programming unit or of the ABB Procontic process display and control system.

Expansion subracks for central expansion are connected directly from the central unit by way of system cables (refer to the description of the 07 BV 60 bus connector).

One central unit always operates together with one program memory fitted in the slot within the central unit (see 'Technical Data' for details of suitable program memories).

Central units are only ever inserted in the specially provided slots (ZE slots) in basic subracks. The ZE slot is on the right of the power supply unit slot (see Technical system data, Mechanical data, mounting dimensions).

The central units differ by virtue of both their type designations and their version identifications. A higher version number signifies greater power. They are upwardly compatible, i.e. a high version number supersedes the previous one.

R101 has already been superseded by R201. R302 supersedes R201 (and, as a replacement unit, naturally also R101).

Addition of capabilities by new versions

From R101 to R201:

- PID control feature; additionally using the corresponding software blocks of the block library expansion 907 PB 361 (function blocks and description, order No. GJP5 2018 00 R102).

From R201 to R302 and using program memories 07 PS 6x R2/R3 or 07 PR 6x R2:

- **16 % faster command processing** for all commands
- **Improved ONLINE programming.** When using the program memories 07 PS 6x R3, ONLINE program changes result in only very short switch-over times of the central unit. This signifies additionally faster ONLINE changes using 07 PS 6x R3.
- **Integrated real-time clock on the central unit.**
Date: day, day of the week, month, year
Time: seconds, minutes, hours
The data is stored and backed in the central unit's special flag area.
- **Remote address area expanded** to 1024 bits per ABB Procontic CS31 system bus line.
- **Additional square root function block.** Available in conjunction with 907 PC 33 for ABB Procontic T200.
- **Additional signalling of a battery fault** by a red LED on the front.

Project planning

The version R302 central units are fully software-compatible with the previous ones. The user program only needs to be adapted to the faster command processing speed in applications that make use of the cycle time as the time base.

Program memories for extended capabilities must be used to be able to exploit the additional capabilities of the R302 central units. These program memories have the version designations R2 and R3 (R3 is needed if it is intended to exploit the improved ONLINE programming function additionally with fast ONLINE changes). Program memories R2 and R3 are downwardly compatible, i.e. can also be used for version R201 and R101 central units. Program memories R1 will not be manufactured any longer in the future.

Under 'Technical data' a table illustrates the possibilities of combining various versions of central units and program memories.

Programming unit interface EIA-232

The EIA-232 interface (programming and ABB Procontic process display and control) is not electrically isolated from internal operating voltages. It is connected to the programming and test system 907 PC 32/33 with the system cables 07 SK 61 or 07 SK 62.

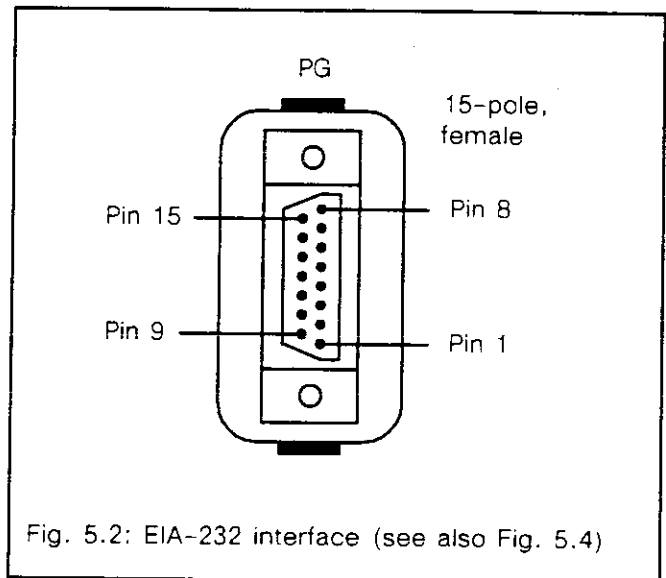

Fig. 5.2: EIA-232 interface (see also Fig. 5.4)

Pin	Signal name	Meaning
1	PGND	Protective Ground (Shield)
2	TxD	Transmit Data
3	RxD	Receive Data
4	RTS	Request to Send
5	CTS	Clear to Send
6	DTR	Data Terminal Ready
7	DSR	Data Set Ready
8	PHL	RLSD Receive Line Signal Detector
9, 10	SGND	Signal Ground
11, 12	PV5	+ 5 V
13	NV12	- 12 V
14	PV12	+ 12 V
15	NC	Not Connected

Table 5.1: Signal assignment of the EIA-232 interface

Real-time clock

All central units as from version R302 (equipped with program memories 07 PS 6x R2/R3 or 07 PR 6x R2) contain a real-time clock. It provides the time (hours, minutes, seconds) and the date (year, month, day of week, day) in BCD code.

The clock runs (updates itself) as long as the program memory has a supply voltage (by way of the central unit and/or the backup battery). This means that it also continues to run whenever the program memory is not even fitted in the central unit, but the backup battery is intact. As the clock belongs to the hardware of the program memory, it must be reinitialized for the system whenever the program memory has been replaced by a new one.

The current date and time information is permanently available and can be interrogated by the affiliated word flags MW4096,11...15.

The current clock data register cannot be written directly. In order to change date and time information, the clock setting register MW4097,11...15 has therefore to be written first. Then the contents have to be copied to the current clock register by setting the flag M 127,09. In doing so, the clock setting register has to be filled entirely with admissible values. It is useful, to copy the contents of the current clock data register to the setting register first, then change them and copy the changed values back to the current clock data register.

The current time/date parameters are copied to the clock setting register by setting the flag M 127,08 to "1" (load clock setting register) for at least one cycle (or continuously).

When the flag M 127,09 (load clock register) is set, the word flag contents of the setting register are copied to the flags for the clock data. The setting register can be written with the overwrite list. If an invalid value is entered, this error is indicated by the flag M 127,11 when setting the clock register.

The copy operations are explained in the following figure.

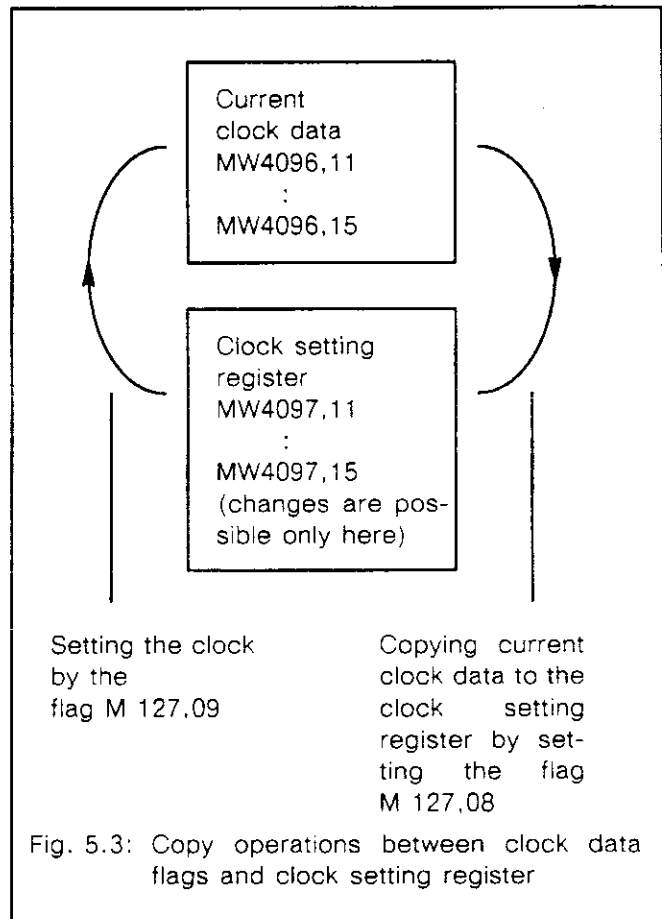

Fig. 5.3: Copy operations between clock data flags and clock setting register

The seconds parameter can be set to full minutes as follows with a positive edge of the flag M 127,10:

- current seconds parameter <30
--> rounded down to 0,
- current seconds parameter ≥30
--> rounded up to the next full minute

The following table shows the allocation of the flags to the clock data and the clock setting register.

Clock data	Clock setting register	Content
MW4096,11	MW4097,11	Year
MW4096,12	MW4097,12	Month and day
MW4096,13	MW4097,13	Day of week (Sunday = 0)
MW4096,14	MW4097,14	Hour + minute
MW4096,15	MW4097,15	Second

Table 5.2: Allocation of flags to the clock data and the clock setting register

The real-time clock can also be set by means of the CE "UHR" (available as of 907 PC 332).

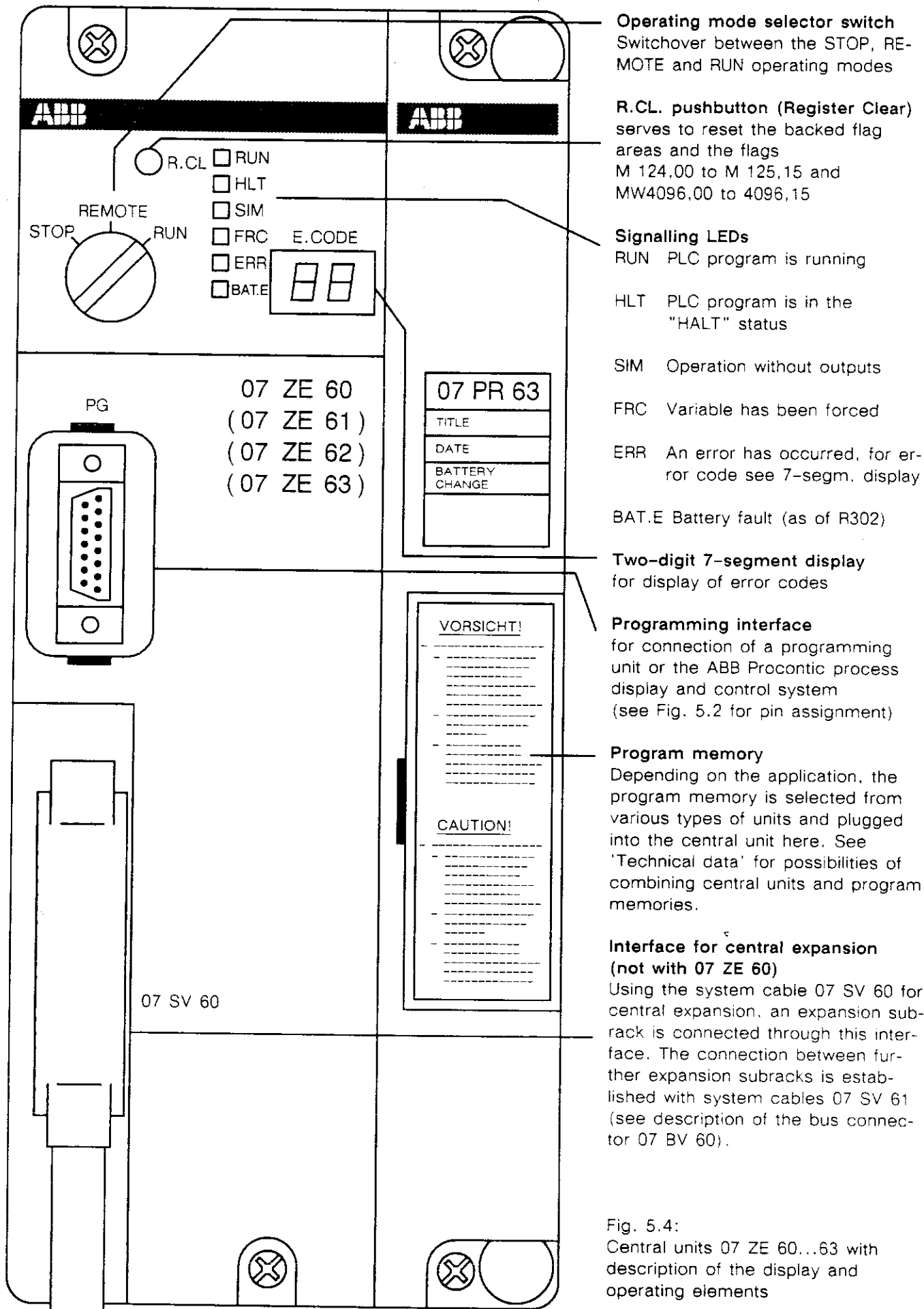

Operating mode selector switch
 Switchover between the STOP, REMOTE and RUN operating modes

R.CL. pushbutton (Register Clear)
 serves to reset the backed flag areas and the flags
 M 124,00 to M 125,15 and
 MW4096,00 to 4096,15

- Signalling LEDs**
- RUN PLC program is running
 - HLT PLC program is in the "HALT" status
 - SIM Operation without outputs
 - FRC Variable has been forced
 - ERR An error has occurred, for error code see 7-segm. display
 - BAT.E Battery fault (as of R302)

Two-digit 7-segment display
 for display of error codes

Programming interface
 for connection of a programming unit or the ABB Procontic process display and control system (see Fig. 5.2 for pin assignment)

Program memory
 Depending on the application, the program memory is selected from various types of units and plugged into the central unit here. See 'Technical data' for possibilities of combining central units and program memories.

Interface for central expansion (not with 07 ZE 60)
 Using the system cable 07 SV 60 for central expansion, an expansion subrack is connected through this interface. The connection between further expansion subracks is established with system cables 07 SV 61 (see description of the bus connector 07 BV 60).

Fig. 5.4:
 Central units 07 ZE 60...63 with description of the display and operating elements

Technical Data

RAM data memory of the central unit

power fail protection

by the lithium battery of the program memory

RAM data areas:

bit flags (M)	can be backed	max. 1984
bit flags/word flags (M' MW' MD')		max. 12 288 bits or 768 words
word flags (MW MD)	can be backed	dependent on the program memory selected
step chains (S)	can be backed	max. 256 with 16 steps each
counters (Z)	can be backed	max. 256 (counting range 0...65535)
timers (T)	can be backed	max. 256 (adjustable by software)
time base (selectable for each timer)		10 ms or 100 ms or 1 s
time range, if time base = 10 ms		10 ms...5 min 27.67 s (only T00,00...T03,15)
if time base = 100 ms		100 ms...54 min 36.7 s
if time base = 1 s		1 s...9 h 6 min 7 s

Program memories

are not delivered with the central units

Suitable program memories (with respect to the type of the central units),

suitable for use in the central unit **07 ZE 60:**

07 PS 60	RAM user program memory	max. 3.5 k	instructions	1)
	RAM word flag memory	max. 2.0 k	word flags	2)
07 PS 61	RAM user program memory	max. 7.6 k	instructions	
	RAM word flag memory	max. 2.0 k	word flags	
07 PR 62	EPROM user program memory	max. 7.6 k	instructions accessible	
	RAM word flag memory	max. 2.0 k	word flags accessible	

suitable for use in the central units **07 ZE 61/63:**

07 PS 60	RAM user program memory	max. 3.5 k	instructions
	RAM word flag memory	max. 2.0 k	word flags
07 PS 61	RAM user program memory	max. 7.6 k	instructions
	RAM word flag memory	max. 2.0 k	word flags
07 PS 62	RAM user program memory	max. 15.7 k	instructions
	RAM word flag memory	max. 16.0 k	word flags
07 PR 62	EPROM user program memory	max. 15.7 k	instructions
	RAM word flag memory	max. 16.0 k	word flags

suitable for use in the central unit **07 ZE 62:**

07 PS 60	RAM user program memory	max. 3.5 k	instructions
	RAM word flag memory	max. 2.0 k	word flags
07 PS 61	RAM user program memory	max. 7.6 k	instructions
	RAM word flag memory	max. 2.0 k	word flags
07 PS 62	RAM user program memory	max. 15.7 k	instructions
	RAM word flag memory	max. 16.0 k	word flags
07 PS 63	RAM user program memory	max. 48.5 k	instructions
	RAM word flag memory	max. 50.0 k	word flags
07 PR 62	EPROM user program memory	max. 15.7 k	instructions
	RAM word flag memory	max. 16.0 k	word flags
07 PR 63	EPROM user program memory	max. 48.5 k	instructions
	RAM word flag memory	max. 50.0 k	word flags

Suitable program memories (with respect to the versions of the central units and program memories),

	07 PS 6x R1 ³⁾	07 PS 6x R2	07 PS 6x R3
	07 PR 6x R1 ³⁾	07 PR 6x R2	4)
07 ZE 6x, R101 and R201	yes	yes	yes
07 ZE 6x, R302	no	yes ⁵⁾	yes ⁵⁾

1) referred to 32 bits per instruction (see operator list)

2) 1 word = 16 bits

3) Version R1 will no longer be available in the future

4) **07 PS 60 R3** and **07 PR 6x R3** not available

5) The improved ONLINE programming is only possible with version R302 central units, which are fitted with version R2 or R3 program memories. High-speed ONLINE changes with **07 PS 6x R3** only.

Alarm processing	1 module with 16 channels
Arithmetics	signed integer, - 32767...+ 32767
Number of different instructions	68 + function blocks
Speed of processing with 1 k binary instructions	
07 ZE 60/61/63 R 101/R201	3 ms
07 ZE 62 R 101/R201	2 ms
07 ZE 60/61/63 R 302	2.6 ms
07 ZE 62 R 302	1.7 ms
Scan time for a program with 65 % bits and 35 % words	
07 ZE 60/61/63 R 101/R201	14 ms/k instructions
07 ZE 62 R 101/R201	8 ms/k instructions
07 ZE 60/61/63 R 302	12 ms/k instructions
07 ZE 62 R 302	6.8 ms/k instructions
Serial interface	one, EIA-232, for programming and ABB Procontic process display and control
parameters of the interface	Baud rate 19200 bit/s, 7 data bits, 1 stop bit, even parity
PID controller capability as from version R201	function blocks and description see 907 PB 361, GJP5 2018 00 R102
Integrated real-time clock as from version R302	Date: day, day of week, month, year Time: seconds, minutes, hours The data are stored and backed in the special flag area of the central unit.
Accuracy of the real-time clock @ 0...55 °C	-175 s...+70 s per month
Central inputs and outputs	
number of slots	07 ZE 60 max. 8 07 ZE 61 max. 18 07 ZE 62/63 max. 58
number of subracks	07 ZE 60 max. 1 07 ZE 61 max. 2 07 ZE 62/63 max. 6
max. address capacity	
central	4096 I/O points 1)
additionally remote (lines)	
via I/O Coupler 07 BR 60	2048 I/O points
via CS31 coupler 07 CS 61,	
07 ZE 60...63 R101/R201	2048 I/O points
07 ZE 60...63 R302	4096 I/O points
max. address capacity per line	
via I/O Coupler 07 BR 60	512 I/O points
via CS31 coupler 07 CS 61,	
07 ZE 60...63 R101/R201	512 I/O points
07 ZE 60...63 R302	1024 I/O points
max. number of configurable lines	4 (Sum of lines via 07 BR 60 and 07 CS 61)
max. number of remote substations 2) per line	10 (see also description 07 BR 60 R1/R2)
max. number of I/O slots per remote substation	9 (see also description 07 BR 60 R1/R2)
Programming	
ONLINE/OFFLINE	both possible
improved ONLINE programming	as from version R302
programming languages:	in accordance with IEC 65A, DIN 19239
IL (instruction list)	yes
LD (ladder diagram)	yes
FBD (function block diagram)	yes
SFC (sequential function chart)	in preparation

1) 1 bit-channel requires 1 I/O point, 1 word-channel requires 16 I/O points

2) 1 remote substation requires 1 expansion subrack

Programming unit		Personal Computer (IBM-compatible)																											
Test and programming software		907 PC 32 or 907 PC 33																											
Self-test capabilities		memory test, watchdog, self test, battery and bus monitoring, programmable scan time monitor, extensive error display																											
Program documentation		yes																											
IL		yes																											
LD		yes																											
FBD		yes																											
SFC		in preparation																											
Test capabilities		breakpoint, single step, single cycle, forcing, overwriting																											
Supply current from internal voltages, current consumption of program memory is included:																													
UB1 = 5 V DC	07 ZE 60/61/63	max. 2.05 A																											
	07 ZE 62	max. 2.75 A																											
UB4 = 24 V DC		no current consumption																											
Total power dissipation	07 ZE 60/61/63	max. 10.25 W																											
	07 ZE 62	max. 13.75 W																											
Signalling		status and error indication by LEDs and 7-segment display																											
Number of required slots		1 ZE slot in the basic subrack																											
Ability of fitting in subracks																													
slots, ● = plug-in is possible																													
		<table border="1" style="border-collapse: collapse; width: 100%;"> <thead> <tr> <th colspan="3">BT</th> <th colspan="3">BE-central</th> <th colspan="3">BE-remote</th> </tr> <tr> <th>NG</th> <th>ZE</th> <th>I/O</th> <th>NG</th> <th>BV</th> <th>I/O</th> <th>NG</th> <th>BV</th> <th>I/O</th> </tr> </thead> <tbody> <tr> <td></td> <td>●</td> <td></td> <td></td> <td></td> <td></td> <td></td> <td></td> <td></td> </tr> </tbody> </table>	BT			BE-central			BE-remote			NG	ZE	I/O	NG	BV	I/O	NG	BV	I/O		●							
BT			BE-central			BE-remote																							
NG	ZE	I/O	NG	BV	I/O	NG	BV	I/O																					
	●																												
Weight	07 ZE 60	800 g																											
	07 ZE 61/63	820 g																											
	07 ZE 62	1000 g																											
Order numbers of the central units																													
	07 ZE 60 R201	GJV3074320R0201 (will not be available in the future)																											
	07 ZE 61 R201	GJV3074321R0201 (will not be available in the future)																											
	07 ZE 62 R201	GJV3074322R0201 (will not be available in the future)																											
	07 ZE 63 R201	GJV3074323R0201 (will not be available in the future)																											
	07 ZE 60 R302	GJV3074320R0302																											
	07 ZE 61 R302	GJV3074321R0302																											
	07 ZE 62 R302	GJV3074322R0302																											
	07 ZE 63 R302	GJV3074323R0302																											
Accessories:																													
Order number of spare key		GJV3074396P1																											
Order numbers of the program memories																													
RAM program memories for extended ONLINE programming without high-speed ONLINE program changing																													
	07 PS 60 R2	GJV3074330R0002																											
	07 PS 61 R2	GJV3074331R0002																											
	07 PS 62 R2	GJV3074332R0002																											
	07 PS 63 R2	GJV3074333R0002																											
RAM program memories for extended ONLINE programming with high-speed ONLINE program changing																													
	07 PS 61 R3	GJV3074331R0003																											
	07 PS 62 R3	GJV3074332R0003																											
	07 PS 63 R3	GJV3074333R0003																											
EPROM program memories																													
	07 PR 62 R2	GJV3074336R0002																											
	07 PR 63 R2	GJV3074337R0002																											

5.2 Error code and flag lists

An error occurring during program execution is displayed by means of the self-diagnosis functions. Therefore the two-digit 7 segment LED display is available. In case of normal mode "00" is displayed on the 7 segment display.

Additionally to the error code display of the central unit detailed error information is available, stored in battery maintained flag and word flag area.

With the 'ONLINE LIST' within 907 PC 32 the corresponding flags of the central unit can be checked, set or reset (see RESERR*.*).

The flag areas entered as buffered as well as the actual values of the counters and time values entered as buffered (including the respective output bits) are deleted when the R.Cl. button (Register Clear) is pressed.

Moreover the following flag areas are cleared:

M 124,00 to M 125,15

MW 4096,00 to MW 4096,15

There are four error levels, which depend on the mode of the central unit.

a) Warning (level 1):

The error is only displayed, but the program execution is not interrupted.

7 segment LED display:

5X, 6X, 7X

b) Fault (level 2):

According to parameters set at configuration of system reaction, the program execution can be continued

at error occurrence, only displaying the error code (see below 'Screen display of 907 PC 32').

7 segment LED display:

4X

c) Error (level 3):

The program execution is stopped. The central unit is able to communicate with a programming unit or with an external computer.

7 segment LED display:

2X, 3X

d) Serious error (level 4):

The program execution is stopped. The central unit is not able to communicate with the programming unit or with an external computer.

7 segment LED display:

1X, 88

Description:

X

Indicates, that any number (hex) can be displayed at this digit of the 7 segment display.

ABB T200/ 07 ZE 60

Configuration of system reaction

```

External start input_____ : E
Cycle monitoring time (msec)_____ : 250

Error at centr. I/O configuration ; CPU___ : Signalling Stop
Error at centr. I/O expansion unit; CPU___ : Signalling Stop
Error on remote I/O coupler ; CPU___ : Signalling Stop
Error at remote I/O config. ;Transmission_ : Signalling Stop
Error at remote substation; Transmission_ : Signalling Stop
Access permission Debug_____ : 1) Yes No
RUN without output permitted_____ : 2) Yes No
External RUN/STOP-operation permitted_____ : 3) Yes No
    
```

Screen display of 907 PC 32

1) M 124,05 3) M 124,03
2) M 124,06 M 124,04

5.2.1 Central unit error messages

Error	Error level	State of the LED RUN	State of the LED ERR	7 segment LED display (HEX)	Internal flag
Central unit errors					
System ROM 1 error	4	Off	On	11	-
System ROM 2 error	3	Off	On	21	-
System RAM 1 error	4	Off	On	12	-
System RAM 2 error	3	Off	On	2A	-
High-speed memory error (only in case of 07 ZE 62)	3	Off	On	26	M 124,09
Microcomputer error	4	Off	On	13	M 124,08
Microcomputer-watch dog error	4	Off	On	88	-
Gate-array error	3	Off	On	22	M 124,09
Not defined instruction	3	Off	On	23	M 124,09
I/O bus error	3	Off	On	24	M 124,09
Power-supply errors					
Short disturbance of supply voltage (voltage drop < low voltage interruption time)	1	Halted	Off	72	M 125,10
Program-memory errors					
Program-memory error e. g. not mounted correctly	3	Off	On	25	-
1. The user-program memory contains invalid data; 2. Data cannot be read or written (sum error)	3	Off	On	31	M 124,10
Data cannot be written into or read out of the memory.	3	Off	On	27	-
1. Battery is not mounted correctly; 2. Battery voltage is too low.	1	Halted	Off	71	M 125,09

Error	Error level	State of the LED RUN	State of the LED ERR	7 segment LED display (HEX)	Internal flag
Parameter errors					
Error in the size of the user-program memory	3	Off	On	33	M124,12
Error in the configuration of the central I/O units	2	Halted/ Off ³⁾	Off/On ³⁾	41	M 124,13 MW 4096,02
Number of assigned I/O points exceeded	2	Halted/ Off ³⁾	Off/On ³⁾	47	M 125,06
Error in the configuration of communication units	1	Halted	Off	58	M 124,14 MW 4096,03
Number of assigned communication units exceeded	1	Halted	Off	57	M 125,13
Program errors					
Syntax error or program-architecture error	3	Off	On	34	M 125,04 MW 4096,01
Cycle time-out error (main program)	2	On/Off ³⁾	Off/On ³⁾	44	M 125,01
Cycle time-out error (time-controlled module)	2	On/Off ³⁾	Off/On ³⁾	45	M 125,02
Cycle time-out error (interrupt module)	2	On/Off ³⁾	Off/On ³⁾	46	M 125,03
I/O errors					
I/O bus error	3	Off	On	28	M 124,11
I/O bus cycle time-out error	3	Off	On	29	M 124,11
I/O module error e. g. blown fuse or short-circuit indication of a short-circuit-proven output module	1	Halted	Off	51	M 125,05 MW 4096,05
I/O transmission error in case of complex units	1	Halted	Off	52	-
Not allowed I/O interrupt	1	Halted	Off	53	-
Remote I/O bus error	2	Halted/ Off ³⁾	Off/On ³⁾	43	M125,00 MW 4096,05
07 ZB 69 unit error	1	Halted	Off	59	M125,14 MW 4096,07

³⁾ According to parameters set at configuration of system reaction

Error	Error level	State of the LED RUN	State of the LED ERR	7 segment LED display (HEX)	Internal flag
Communication-unit errors					
System-bus cycle time-out error	4	Off	On	15	M 125,08
System-bus unit error	1	Halted	Off	56	M 125,08
Communication-unit error	1	Halted	Off	54	M 125,07 MW 4096,04
Communication-unit transmission error	1	Halted	Off	55	M 125,07 MW 4096,04
Errors, when communicating with peripherals					
Interface-transmission error (parity)	1	Halted	Off	61	-
Interface-transmission error (framing error, overrun)	1	Halted	Off	62	-
Interface-transmission error (cycle time-out error)	1	Halted	Off	63	-
Interface-transmission error (protocol error)	1	Halted	Off	64	-
Interface-transmission error (block check character error = BCC error)	1	Halted	Off	65	-

5.2.2 Error recovery

E. Code ⁴⁾ (HEX)	Mode of error	ZE Status	Description. Possible cause	Remedy at error occurrence	Level of the error	RUN LED-	ERR LED-	Flag
--	Error with power supply on one or more subrack(s)	Stop	One or more sub-rack(s) of the remote expansion has/have no power supply	Check power supply units	-	Off	Off	-
11	ZE error System ROM 1 error (checked during power up)	Stop	System ROM data required by the management micro-computer cannot be read (sum check error)	Check the hardware. Correct mounting of the central unit or in the basic subrack. Power up. If the error occurs anew, replace the faulty hardware.	4	Off	On	-
12	ZE error System RAM 1 error (checked during power up)	Stop	System RAM data required by the management micro-computer cannot be read (sum check error)	refer to 11	4	Off	On	-
13	Microcomputer error (is always checked)	Stop	Not defined operation code was detected during execution of the microcomputer-system program.	refer to 11	4	Off	On	M 124.08
15	Communication-unit error System-bus cycle time-out error (checked during access on the bus)	Stop	No response from 07 BR 60, 07 ZB 69, or 07 KP 60	Check mounting of the units, then power up. If the error occurs anew, replace the faulty unit or the central unit.	4	Off	On	M 125.08
21	ZE error System ROM 2 error (checked during power up)	Stop	The gate-array system ROM data cannot be read.	Switch voltage on again. If the error occurs anew, replace the central unit or the program memory.	3	Off	On	-
22	ZE error Gate-array error (is always checked)	Stop	Check-sum error of the Gate-Array processor (SP) system ROM	refer to 21	3	Off	On	M 124.09
23	ZE error Not defined instruction (is always checked)	Stop	The program contains an instruction code, which cannot be executed by the control unit.	refer to 21	3	Off	On	M 124.09
24	ZE error Gate-array processor bus error (checked during external I/O access).	Stop	A request by the gate-array processor was not answered by an external I/O unit.	Check mounting of the central unit and power up. If the error occurs anew, check the connection between the units.	3	Off	On	M 124.09

⁴⁾ Error Code
ZE: Central unit

E. Code 4) (HEX)	Mode of error	ZE Status	Description. Possible cause	Remedy at error occurrence	Level of the error	RUN LED-	ERR LED-	Flag
25	Program memory error (is always checked)	Stop	The program memory is not mounted correctly.	Mount program memory correctly. power up again.	3	Off	On	-
26	ZE error High-speed memory error (checked during voltage is powered up. if it is switched to RUN mode or during RUN mode).	Stop	Correct data cannot be read out of the central unit 07 ZE 62 or no correct data can be written into it.	Power up again. If the error occurs anew. re-place central unit or program memory.	3	Off	On	M 124.09
27	Data memory error (checked during voltage is powered up or general reset is output via the programming unit).	Stop	Valid data cannot be read out o the high-speed memory of the central unit 07 ZE 62. or no correct data can be written into it.	Check ZE and memory. Power up again. If the error occurs anew. replace central unit or program memory.	3	Off	On	-
28	I/O bus error (checked during external I/O access)	Stop	No response from the I/O unit (error between microprocessor and I/O unit).	Check Hardware. Eliminate mounting error of central unit or in the basic subrack. Power up. If the error occurs anew. replace faulty I/O unit or central unit.	3	Off	On	M 124.11
29	Gate-array bus cycle time-out error (is always checked)	Stop	No response from I/O unit	refer to 28	3	Off	On	M 124.11
2A	System RAM 2 error (checked during voltage is switched on).	Stop	Read/write check error of the gate-array processor RAM data.	refer to 28	3	Off	On	-
2C	Gate-array error	Stop	Gate-array processor cycle time-out error.	Switch voltage off and on. If the error occurs anew. replace central unit.				

4) Error Code
ZE: Central unit

E. Code 4) (HEX)	Mode of error	ZE Status	Description, Possible cause	Remedy at error occurrence	Level of the error	RUN LED-	ERR LED-	Flag
31	User-program memory error (checked during powering up, during switching from STOP to RUN, during RUN (only RAM). If parameters are changed or if general reset is executed).	Stop	For EPROM memory: The program is not stored correctly in the user program memory or the EPROM is not mounted correctly (sum check error). For RAM memory: The user-program memory contains invalid data or valid data cannot be written or read (sum check error).	For EPROM memory: Load the correct program into the memory or mount the EPROM correctly. For RAM memory: Load the correct program into the memory, then restart the program.	3	Off	On	M 124.10
33	User-program memory size error (checked during switching from STOP to RUN)	Stop	The user program exceeds the specified size of the user-program memory or mismatching system configuration.	Check the size of the user-program memory and the size of the user program defined via the programming unit and correct it. Then restart the program. General reset.	3	Off	On	M 124.12
	Error with EPROM program memory		Indicates after power-on, that EPROMs are not mounted properly or not mounted at all.	Insert EPROMs correctly.	3	Off	On	
34	Program Syntax- or architecture error (checked during switching from STOP to RUN).	Stop	Syntax error in the user program. A detailed description of the error is given in the internal flag MW 4096.01.	Check the user program and correct it, then restart the program.	3	Off	On	M 125.04 MW4096.01
41	System-configuration error in case of inquiry of I/O informations (is always checked).	Stop (operation)	The I/O assignment defined by the system configuration does not match the current I/O units (except remote I/O units). The mismatching unit and the slot number are given in the internal flag MW4096.02.	Correct the system configuration or position the I/O unit according to the configuration correctly, then restart the program. Checking the station numbers at the coding switch of bus connectors 07 BV 60 and system cable 07 SV 60 and 07 SV 61.	2	Hal- ted/ Off 3)	Off/ On	M 124.13 MW4096.02
42	Not defined.							

3) According to the central-unit parameters

4) Error Code

ZE: Central unit

E. Code *) (HEX)	Mode of error	ZE Status	Description. Possible cause	Remedy at error occurrence	Level of the error	RUN LED-	ERR LED-	Flag
43	Remote I/O bus error (is always checked)	Stop (operation)	1. Current configuration of the remote I/O expansion does not match the system configuration. 2. A Communication error has occurred between 07 BR 60 and central unit. 3. Data transfer to a remote I/O substation was stopped because of a hardware or communication error in the 07 BR 60. The error description is given in the internal flags MW4104.00 to MW4109.15.	1. Check the configuration of the remote I/O expansion and correct it. Restart the program. 2. Detect faulty unit(s): is (are) displayed via ERR LED, or by means of the content of the internal flag or via error information code of 07 BR 60. Reset unit by pressing the RES key. 3. Same as first sentence in 2. Remove error cause according to the displayed error information code. Reset unit by pressing the RES key. Restart the program.	2	Hal- ted/ Off	Off/ On 3)	M125.00 MW4096.05
44	Program Cycle time-out error. Main program (is checked during processing is finished)	Stop (operation)	Cycle-supervision time exceeded.	Calculate user program run time anew. Correct program or modify the cycle-supervision time. then restart the program.	2	On/ Off 3)	Off/ On 3)	M125.01
45	Program Cycle time-out error. time-controlled module (is checked during cycle processing).	Stop (operation)	The time-controlled modules have exceeded the maximum time.	Calculate execution time of the time-controlled modules anew. check and correct the program. then restart the program.	2	On/ Off 3)	Off/ On 3)	M125.02
46	Program Cycle time-out error. Interrupt modules (is checked during interruption).	Stop (operation)	An interruption of the same channel has occurred anew during interruption processing.	Increase the time duration between Interrupt inputs. then restart the program anew.	2	On/ Off 3)	Off/ On 3)	M 125.03

3) According to the central-unit parameters

4) Error Code

ZE: Central unit

E. Code 4) (HEX)	Mode of error	ZE Status	Description. Possible cause	Remedy at error occurrence	Level of the error	RUN LED-	ERR LED-	Flag
47	Exceeding number of assigned I/O points (checked during powering up, during switching from STOP to RUN, during RUN or if a new program is transferred).	Stop (operation)	The number of I/O points set by the program has exceeded the number of I/O points (4096).	Correct I/O assignment to reduce the configuration to the maximum I/O points of the central unit, then restart the program.	2	Hal- ted/ Off	Off/ On 3)	M125.06
51	I/O unit error (is always checked)	Operation	1. A fuse of an output unit is blown or a short-circuit-proven output module indicates a short-circuit. The corresponding unit or the slot number is given in the internal flag MW4096.05. 2. An error has occurred in a complex unit or in a communication unit.	1. Exchange the fuse, as soon as the unit with blown fuse is identified by inquiring the internal flag. Acknowledge the short-circuit-proven output module after eliminating the short-circuit. 2. Exchange the faulty unit.	1	Hal- ted	Off	M125.05 MW4096.05
52	I/O transmission error	Operation	An error has occurred during data transmission from or to a complex unit.	Switch the complex unit on again to remove the error.	1	Hal- ted	Off	-
53	Non-permissible I/O interruption (is checked during RUN mode)	Operation	An interruption was received from a not assigned module slot for a unit, having the interrupt function.	Compare the current configuration with the specified system configuration and correct it.	1	Hal- ted	Off	-
54	Communication-unit error (is always checked)	Operation	A Hardware error has occurred in a communication unit. (the module slot number of the according unit is given in the internal flag MW4096.04).	Eliminate the error by checking the error code of the communication unit.	1	Hal- ted	Off	M125.07 MW4096.04

3) According to the central-unit parameters

4) Error Code

ZE: Central unit

E. Code 4) (HEX)	Mode of error	ZE Status	Description. Possible cause	Remedy at error occurrence	Level of the error	RUN LED-	ERR LED-	Flag
55	Transmission error of the communication unit (is checked during an instruction from the programming unit is received via the communication unit).	Operation	An error has occurred during data transfer to or from the communication unit. The module slot number of the corresponding unit is given in the internal flag MW4096.04.	Eliminate error by proceeding according to the instruction in the error code of the communication unit.	1	Hal- ted	Off	M125.07 MW4096.04
56	Communication-unit error. System-bus error	Operation	Error in a complex unit.	Check the program for the complex unit and correct it.	1	Hal- ted	Off	M125.08
57	Configuration error Exceeded number of assigned communication units	Operation	The number of configuration units set by the configuration has exceeded the maximum possible number.	Correct the assignment of communication units.	1	Hal- ted	Off	M125.13
58	Configuration error when inquiring the communication unit (is always checked)	Operation	The communication assignment defined by the system configuration does not match the current unit. The mismatching slot number is given in the internal flag MW4096.03.	Correct the configuration or position the communication unit according to the configuration correctly.	1	Hal- ted	Off	M124.14 MW4096.03
59	07 ZB 69 unit error (is always checked)	Operation	Error in the Hardware of the 07 ZB 69 unit.	Eliminate error by proceeding according to the error description in the error code of the faulty 07 ZB 69 unit.	1	Hal- ted	Off	M125.14 MW4096.07
61	Interface-transmission error. parity error (is checked during transmission)	Operation	A parity error was detected during communication with a programming unit or with an external computer. 1. The cables are connected incorrectly. 2. The external computer and the central unit mismatch in their data format or baud rate.	1. Check the connection cables. 2. Modify the data format of the external computer to reach the specification of the central unit.	1	Hal- ted	Off	-

4) Error Code
ZE: Central unit

E. Code 4) (HEX)	Mode of error	ZE Status	Description. Possible cause	Remedy at error occurrence	Level of the error	RUN LED-	ERR LED-	Flag
62	Interface-transmission error, framing error, overrun error (is checked during transmission)	Operation	A framing error or an overrun error was detected during communication with a programming unit (or with an external computer). 1. The cables are connected incorrectly. 2. The external computer and the central unit mismatch in their data format or in the baud rate.	1. Check the connection cables. 2. Modify the data format or the baud rate of the external computer to reach the specification of the central unit.	1	Hal- ted	Off	-
63	Interface transmission error, cycle time-out error (is checked during transmission)	Operation	A cycle time-out error was detected during communication with a programming unit (or with an external computer). 1. The cable are connected incorrectly. 2. The external computer and the central unit mismatch in their protocols.	1. Check the connection cables. 2. Check the protocol specifications and correct the protocols of the external computer.	1	Hal- ted	Off	-
64	Interface transmission error, protocol error (is checked during transmission)	Operation	A protocol error was detected during communication with a programming unit (or with an external computer). 1. The cable are connected incorrectly. 2. The external computer and the central unit mismatch in their protocols.	1. Check the connection cables. 2. Check the protocol specifications and correct the protocols of the external computer.	1	Hal- ted	Off	-

4) Error Code
ZE: Central unit

E. Code 4) (HEX)	Mode of error	ZE Status	Description, Possible cause	Remedy at error occurrence	Level of the error	RUN LED-	ERR LED-	Flag
65	Interface transmission error. Block check character error (BCC error). (is checked during transmission)	Operation	Valid data cannot be received during communication with a programming unit (or with an external computer). 1. The cables are connected incorrectly. 2. The BCC calculation of the external computer mismatches with the specifications of the central unit.	1. Check the connection cables. 2. Correct the BCC calculation of the external computer to fulfill the specifications of the central unit.	1	Hal- ted	Off	-
71	Program memory. Battery error (is always checked)	Operation	1. Battery voltage is too low. 2. Battery is mounted incorrectly.	1. Replace the battery. To avoid data loss, replace the battery within one week after the error occurred. Replace the battery only with the PLC connected to power supply voltage. 2. Mount the battery according to the mounting instructions on the program memory.	3	Off	On	M125.09
72	Short disturbance of supply voltage. voltage drop < low voltage interruption time (is always checked)	Operation	The central unit remains in RUN mode, it does not stop and it indicates, that a voltage dip has occurred.	Check the power supply voltage.	1	Hal- ted	Off	M125.10
88	Microcomputer-Watchdog error	Stop	Watchdog error	Switch power supply on anew.	4	Off	On	-

Remark:

If two or more errors occur simultaneously, the error code having the least number (except "00") is displayed first.

4) Error Code
ZE: Central unit

5.2.3 Internal bit flags

No.	Reaction/type of error	Explanation	Detailed description
M 124,00	Reaction in case of cycle time-out (main program)	0: Processing is stopped at occurrence of error message. 1: Processing is continued at occurrence of error message.	The status of the flag defines, whether the central unit shall be stopped or if the cycle shall be continued in case of the cycle time-out error during main-program processing.
M 124,01	Reaction in case of cycle time-out (time-controlled module)	0: Processing is stopped at occurrence of error message. 1: Processing is continued at occurrence of error message.	The status of the flag defines, whether the central unit shall be stopped or if the cycle shall be continued in case of the cycle time-out error during processing of the time-controlled module.
M 124,02	Reaction in case of cycle time-out (Interrupt module)	0: Processing is stopped at occurrence of error message. 1: Processing is continued at occurrence of error message.	The status of the flag defines, whether the central unit shall be stopped or if the cycle shall be continued in case of the cycle time-out error during processing of the interrupt module.
M 124,03	Remote RUN release	0: Disables remote RUN. 1: Release for remote RUN.	Disables or releases the input of the RUN instruction via the programming unit or via an external computer.
M 124,04	Remote STOP release	0: Disables remote-STOP. 1: Release for remote STOP.	Disables or releases the input of the STOP instruction via the programming unit or via an external computer.
M 124,05	Release for test mode (debugging)	0: Disables test mode. 1: Release for test mode.	Disables or releases the test mode (debugging) with break point setting, single cycle, single step.
M 124,06	Release for passive mode (SIM.)	0: Disables passive mode. 1: Release for passive mode.	Disables or releases the passive mode (mode without active release)
M 124,07	Release for program modification during RUN mode	0: Disables program modification during RUN mode. 1: Releases program modification during RUN mode.	Disables or releases the modification of user programs during program execution.
M 124,08	Serious error	0: A serious error did not occur. 1: A serious error did occur.	Indicates, whether or not an error occurs in the management micro-processor.

No.	Reaction/type of error	Explanation	Detailed description
M 124,09	Gate-array error	0: No error 1: Error	Indicates occurrence of gate-array error.
M 124,10	Memory error	0: No error 1: Error	Indicates occurrence of an user-program memory error.
M 124,11	I/O bus error	0: No error 1: Error	Indicates occurrence of an error.
M 124,12	Exceeding of the user-program memory size	0: No error 1: Error	Indicates, if the user-program memory size defined by the parameter is exceeded or not.
M 124,13	Checks, if the I/O assignment information matches with the used units.	0: No error 1: Error	Indicates, if the I/O assignment information defined by the system configuration matches with the used units or not. The information on the mismatching module slots is given in the internal flag MW 4096.02.
M 124,14	Error in the configuration of communication unit (07 KP 60, 07 ZB 69, 07 BR 69)	0: No error 1: Error	Indicates, if the communication assignment information defined by the system configuration matches with the used units or not. The information on the mismatching module-slot number is given in the internal flag MW 4096.03.
M 124,15	Not defined		
M 125.00	Remote I/O bus error	0: No error 1: Error	Indicates, if the current configuration of the remote I/O expansion matches or mismatches with the system configuration. The mismatching module-slot number is given in the internal flag MW 4096.06.
M 125.01	Cycle time-out error (main program)	0: No error 1: Error	Indicates, if the user-program runtime exceeds the configured cycle-supervision time.
M 125.02	Cycle time-out error (time controlled module)	0: No error 1: Error	Indicates, if the execution time of the time-controlled modules is too long.
M 125.03	cycle time-out error (Interrupt module)	0: No error 1: Error	Indicates occurrence of a new interrupt of the same channel during interrupt execution.
M 125.04	Syntax error or program-architecture error	0: No error 1: Error	Indicates occurrence of a syntax error in the user program. A detailed error description is given in the internal flag MW4096.01 .

No.	Reaction/type of error	Explanation	Detailed description
M 125.05	I/O module error	0: No error 1: Error	Indicates, if a fuse of an I/O module is faulty or if a short-circuit-proven module indicates a short-circuit. The slot number of the corresponding unit is given in the internal flag MW4096.05.
M 125.06	Exceeding number of assigned I/O points	0: No error 1: Error	Indicates, if the number of I/O points set by the program has exceeded the number of points (4096), which is the maximum allowed by the central unit.
M 125.07	Communication-unit error 1)	0: No error 1: Error	Indicates, if a communication-unit error has occurred. The slot number of the corresponding unit is given in the internal flag MW4096.04.
M 125.08	System-bus error	0: No error 1: Error	Indicates, if an error has occurred during access to the system bus.
M 125.09	Battery error	0: No error 1: Error	Indicates, if the voltage of the battery in the program memory is too low.
M 125.10	Short disturbance of supply voltage (voltage drop < low voltage interruption time)	0: Voltage failure did not occur. 1: Voltage failure did occur.	Indicates occurrence of voltage drop of power supply.
M 125.11	Self-diagnostic error	0: No error 1: Error	Indicates, if an error has occurred during self diagnosis. The error number is given in the internal flag MW4096.00 (refer to section 5.5.4).
M 125.12	Not defined		
M 125.13	Exceeding number of assigned communication units 1)	0: No error 1: Error	Indicates, if the number of communication units set by the configuration has exceeded the maximum possible number.
M 125.14	Hardware error of the 07 ZB 69	0: No error 1: Error	Indicates hardware error of the 07 ZB 69. The corresponding slot number is given in the internal flag MW4096.07.
M 125.15	Internal use only		Must not be occupied by the user
M 126.00	Key switch in STOP position	0: Switch is not in STOP position 1: Switch is in STOP position	Indicates, if the key-operated switch for selection of the operating mode is in STOP position.

1) 07 KP 6x, 07 ZB 69, 07 BR 60 are communication units.

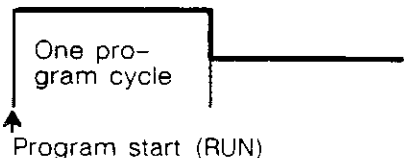
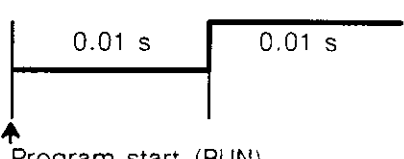
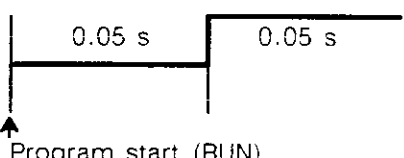
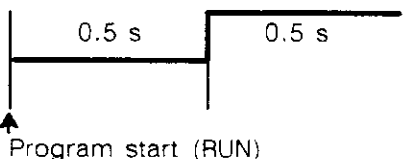
No.	Reaction/type of error	Explanation	Detailed description
M 126.01	Key-operated switch in REMOTE position	0: Switch is not in REMOTE position 1: Switch is in REMOTE position	Indicates, if the key-operated switch for selection of the operating mode is in REMOTE position.
M 126.02	Key-operated switch in RUN position	0: Switch is not in RUN position 1: Switch is in RUN position	Indicates, if the key-operated switch for selection of the operating mode is in RUN position.
M 126.03	Display of the first program cycle after program run (RUN).	0: Two program cycles or more after program run. 1: During the first program cycle.	ON (1) OFF (0)  Program start (RUN)
M 126.04	Always 1 signal	0: Never occurs 1: Always	
M 126.05	Cycle of 0.02 seconds	Duration of: 0: 0.01 s 1: 0.01 s	ON (1) OFF (0)  Program start (RUN)
M 126.06	Cycle of 0.1 seconds	Duration of: 0: 0.05 s 1: 0.05 s	ON (1) OFF (0)  Program start (RUN)
M 126.07	Cycle of 1 second	Duration of: 0: 0.5 s 1: 0.5 s	ON (1) OFF (0)  Program start (RUN)
M 126.08	Central unit is busy.	0: not busy 1: busy	Indicates, that the central unit communicates with an external computer.
M 126.09	Permission for system run	0: Execution permitted. 1: Execution not permitted.	Indicates, if the central unit may be started or not.
M 126.10	Program modification during RUN mode	0: Program is not modified during RUN mode. 1: Program is modified during RUN mode.	Indicates, if the program is modified during execution or, if the execution is halted for a short time (output HALT).
M 126.11	Deletion of the error display on the central unit		The error display on the central unit is reset to 00, when this flag has been set.

No.	Reaction/type of error	Explanation	Detailed description
M 126,12	Resetting the error flags		The following error flag areas are deleted, when this flag has been set: M 124,08 to M 125,15 MW 4096,00 to MW 4096,15 MW 4104,01 to MW 4105,04 MW 4105,09 to MW 4106,12 MW 4107,01 to MW 4108,04 MW 4108,09 to MW 4109,12 MW 4110,00 MW 4111,09 to MW 4115,12 MW 4116,00 MW 4117,09 to MW 4117,12 MW 4122,00 to MW4127,15
M 126,12 must not be used in safety-related applications (safety-related shut-down)			
M 126,13	Internal use only		Must not be occupied by the user
M 126,14 to M 126,15	not defined		
M 127,00	Carry	0: Carry on bit 15 is not set. 1: Carry on bit 15 is set.	It is used as carry flag in case of arithmetic operations (+, -, .. :).
M 127,01	Overflow	0: Carry on bit 14 is not set. 1: Carry on bit 14 is set.	It is used as overflow flag in case of arithmetic operations (+, -, .. :).
M 127,02	Data move	0: The instruction "Data move" has the logical state 0. 1: The instruction "Data move" has the logical state 1.	Moving of input data is used with the move instructions.
M 127,03	Wrong arithmetic instruction	0: No error 1: Error	Indicates, if a wrong instruction has occurred during execution of an arithmetic instruction. Detailed information is given in the internal flag MW4097,05.
M 127,04	Exceeding of data area (Ari-Bit)	0: No error 1: Error	Indicates, if a data-area exceeding error has occurred during execution of arithmetic instructions.
M 127,05 to M 127,07	not defined		

No.	Reaction/type of error	Explanation	Detailed description
M 127,08	Copying clock data into the setting register	0: No copying 1: Contents of MW4096,11 to MW4096,15 are copied to MW4097,11 to MW4097,15.	As long as M 127,08 is "1", the contents of the current clock register is copied to the setting register.
M 127,09	Loading the current clock data register	0: No loading 1: Contents of MW4097,11 to MW4097,15 are copied to MW4096,11 to MW4096,15.	The contents of the clock setting register are loaded into the current clock register by the positive edge of M 127,09.
M 127,10	Setting the second digits	0: No operation 1: Setting to full minutes	Current second digits < 30 --> rounded down to 0. Current second digits ≥ 30 --> rounded up to the next minute
M 127,11	Error during setting the clock register	0: No error 1: Error	Shows whether an inadmissible setting value has been entered.
M 127,12 to M 127,14	not defined		
M 127,15	Mode bit	0: Limitation 1: Without Limitation	Refer to the ABB Procontic T200 arithmetic description in SW description 907 PC 332 for T200 volume 4, chapter 3.2.9.

5.2.4 Internal word flags

No.	Mode of error	Stored data	Detailed description
MW 4096,00	Self-diagnosis error code	Self-diagnosis error number	Contains the error number, which was detected as binary code via the central unit.
MW 4096,01	Details concerning syntax/program error	Number of syntax/program error	Contains the syntax error of the user program as binary code.
		Decimal representation 907 PC 32	
		0	Normal mode
		1	Multi-jump label definition
		2	not used
		3	not used
		4	Multi-user program block defined (AB)
		5	Multi-interruption program (IB) defined
		6	
		:	not used
		15	
		16	Program end (PE) not defined
		17	Subroutine end (BE) not defined
		18	Interruption-program end (IBE) not defined
		19	Subroutine (!PB AB nn) not defined
		20	Interruption-program (!PB IB nn) not defined
		21	
		:	not used
		31	
		32	Subroutine end (BE) is placed incorrect
		33	Interruption-program end (IBE) is placed wrongly
		34	Program end (PE) is placed incorrect
		35	
		:	not used
		47	
		48	Subroutine call error
		49	Interruption-program calling error
		50	not used
		51	not used
		52	PE (program end) multiple defined
		53	
		:	not used
		63	

No.	Mode of error	Stored data	Detailed description																																				
MW 4096,02	Details on the error, when assigning the central I/O modules	Slot number of the mismatching I/O modules ²⁾	<p>Contains the slot number of the I/O modules, which does not match the I/O assignment information defined by the system configuration. Architecture of the flag in HEX (representation in 907 PC 32 in decimal)</p> <div style="text-align: center;"> <table border="1" style="margin: auto;"> <tr> <td style="width: 20px;">15</td> <td style="width: 20px;">12</td> <td style="width: 20px;">11</td> <td style="width: 20px;">8</td> <td style="width: 20px;">7</td> <td style="width: 20px;">4</td> <td style="width: 20px;">3</td> <td style="width: 20px;">0</td> </tr> <tr> <td style="text-align: center;">0</td> <td colspan="2" style="text-align: center;">a</td> <td colspan="2" style="text-align: center;">b</td> <td colspan="2" style="text-align: center;">0</td> <td style="text-align: center;">0</td> </tr> </table> <p>a: BT/BE number (0 to 5) b: Slot number (0 to 9)</p> </div> <p>Example for MW 4096,02: In case of error the word flag MW 4096,02 contains for instance: 368 (decimal representation in Online 907 PC 32), HEX equivalent: 0170H</p> <div style="text-align: center;"> <table border="1" style="margin: auto;"> <tr> <td style="width: 20px;">15...12</td> <td style="width: 20px;">11</td> <td style="width: 20px;">10</td> <td style="width: 20px;">9</td> <td style="width: 20px;">8</td> <td style="width: 20px;">7</td> <td style="width: 20px;">6</td> <td style="width: 20px;">5</td> <td style="width: 20px;">4</td> <td style="width: 20px;">3...0</td> </tr> <tr> <td style="text-align: center;">0</td> <td style="text-align: center;">0</td> <td style="text-align: center;">0</td> <td style="text-align: center;">0</td> <td style="text-align: center;">1</td> <td style="text-align: center;">0</td> <td style="text-align: center;">1</td> <td style="text-align: center;">1</td> <td style="text-align: center;">1</td> <td style="text-align: center;">0</td> </tr> </table> <p style="text-align: center;"> ↑ ↑ ↑ ↑ </p> <p style="text-align: center;"> BE No. 1 Slot No. 7 </p> </div> <p>i. e.: The module in slot 7 in the 1. expansion subrack does not match the I/O assignment information defined by the system configuration.</p>	15	12	11	8	7	4	3	0	0	a		b		0		0	15...12	11	10	9	8	7	6	5	4	3...0	0	0	0	0	1	0	1	1	1	0
15	12	11	8	7	4	3	0																																
0	a		b		0		0																																
15...12	11	10	9	8	7	6	5	4	3...0																														
0	0	0	0	1	0	1	1	1	0																														
MW 4096,03	Details on the error when assigning communication units ¹⁾	Slot number of the mismatching communication units ²⁾	Contains the slot number (0 to 7) of the communication unit, which does not match the communication-unit assignment information defined by the system configuration.																																				
MW 4096,04	Slot number of a defective communication unit ¹⁾	Slot number	Contains the slot number (0 to 7) of a communication unit, which has a hardware error.																																				
MW 4096,05	Slot number of a faulty I/O module	Slot number	Contains the slot number of a faulty I/O module (format: refer to word flag MW 4096,02).																																				
MW 4096,06	Slot number of a coupler for remote I/O expansion, which does not match the configuration.	Slot number	Contains the slot number of a coupler for remote I/O expansion, which does not match the configuration (format: refer to word flag 4096,02 with a = 0).																																				
MW 4096,07	Slot number of a faulty unit 07 ZB 69	Slot number	Contains the slot number (0 to 7) of a unit 07 ZB 69, which has a hardware error (format: refer to word flag MW 4096,02 with a = 0).																																				

¹⁾ Communication units are 07 KP 6x, 07 ZB 69, 07 BR 60.

²⁾ Contains the lowest slot number

Remark to:

MW 4096,03
MW 4096,04
MW 4096,07
Architecture of the flag in HEX (representation in 907 PC 32 in decimal)

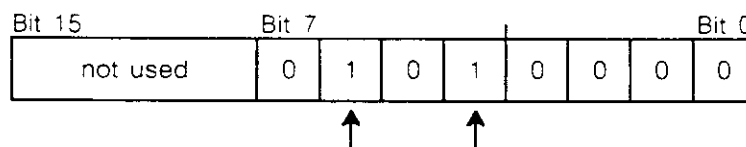

Example: The communication unit in slot 5 is defective. In case of error the word flag MW 4096,... contains for instance: 80 (decimal representation Online 907 PC 32), HEX equivalent: 0050H

No.	Mode of error	Stored data	Detailed description																								
MW 4096.08 to MW 4096.10	not defined																										
MW 4096.11	Clock data	Contains the year in BCD code																									
MW 4096.12	Clock data	Contains the month and the day in BCD code																									
MW 4096.13	Clock data	Contains the day of week in BCD code (0 = Sunday, 1 = Monday etc.)																									
MW 4096.14	Clock data	Contains the hours and the minutes in BCD code																									
MW 4096.15	Clock data	Contains the seconds in BCD code																									
MW 4097.00	Maximum cycle time	Maximum main-program execution time	In steps of 10 milliseconds																								
MW 4097.01	Current cycle time	Main program execution time	In steps of 10 milliseconds																								
MW 4097.02	Minimum cycle time	Minimum main-program execution time	In steps of 10 milliseconds																								
MW 4097.03	Display of central-unit status	Operating mode of central unit																									
		<table border="1" style="width: 100%; text-align: center;"> <tr> <td>15</td><td>10</td><td>9</td><td>8</td><td>7</td><td>6</td><td>5</td><td>4</td><td>3</td><td>2</td><td>1</td><td>0</td> </tr> <tr> <td>Not used</td><td></td><td>a</td><td>b</td><td>c</td><td>d</td><td>e</td><td>f</td><td>g</td><td>h</td><td>i</td><td></td> </tr> </table>	15	10	9	8	7	6	5	4	3	2	1	0	Not used		a	b	c	d	e	f	g	h	i		
15	10	9	8	7	6	5	4	3	2	1	0																
Not used		a	b	c	d	e	f	g	h	i																	
		a: Type of central unit:	01 = 07 ZE 62, 10 = 07 ZE 61/63, 11 = 07 ZE 60																								
		b: Battery error:	1 = error, 0 = no error																								
		c:	Not used																								
		d: Debugging:	1 = during debugging, 0 = debugging is not executed																								
		e: Forcing (Overwriting of a variable without taking notice of the result of the controller):	1 = forcing, 0 = no forcing																								
		f: Error:	1 = error, 0 = no error																								
		g: Simulation:	1 = during simulation, 0 = no simulation																								
		h: Changing the operating mode:	1 = unchanged, 0 = changed																								
		i: Operating mode:	1 = operating, 0 = not operating																								
MW 4097.04	Number of available word flags	Display of the number of available word flags	Display: 0400HEX = 1024, 4400HEX = 17408 or C400HEX = 50176																								

No.	Mode of error	Stored data	Detailed description
MW 4097,05	Error codes in case of arithmetic operations	Decimal representation 907 PC 32/33	
		0	Normal mode
		1	Multi-branch mark definition
		2	not used
		3	not used
		4	Multi-user program block (AB)
		5	Multi-interruption program (IB)
		6	
		:	not used
		15	
		16	Program end (PE) not defined
		17	Subroutine end (BE) not defined
		18	Interruption program end (IBE) not defined
		19	Subroutine (!PB AB nn) not defined
		20	Interruption program (!PB IB nn) not defined
		21	Branch marks not defined
		22	
		:	not used
		31	
		32	Subroutine end error
		33	interruption program end error
		34	Program end error
		35	
		:	not used
		47	
		48	Error at the sub-program end
		49	Error at the interruption-program end
		50	Error at the program end
		51	
		:	not used
		63	
		64	Branch mark area error
		65	Subroutine nesting depth is exceeded
		66	Subroutine calling is not defined
		67	
		:	not defined
		:	
MW 4097,06	Arithmetic register Low	Carry in case of	In case of 16 bit arithmetic
MW 4097,07	Arithmetic register High	execution of division or multiplication resp.	MW 4097,06 is used only.

No.	Mode of error	Stored data	Detailed description
-----	---------------	-------------	----------------------

MW 4097.08 Setting the flag of the communication unit ¹⁾

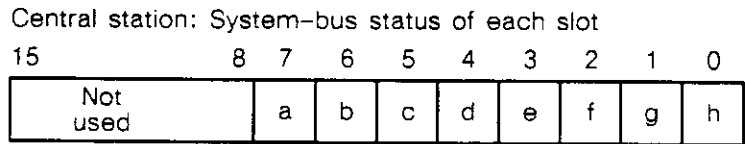

1 = System-bus configuration is complete
 0 = System-bus configuration is not complete
 A set bit corresponds to the right slot number of a communication unit, which is plugged-in.
 a = Slot number 7
 b = Slot number 6
 c = Slot number 5
 d = Slot number 4
 e = Slot number 3
 f = Slot number 2
 g = Slot number 1
 h = Slot number 0

Example for MW 4097.08:

If 2 communication units are configured in slot 4 and 5 and also in 6 and 7, the word flag 4097.08 will contain the decimal value of 160. HEX equivalent: 00A0H

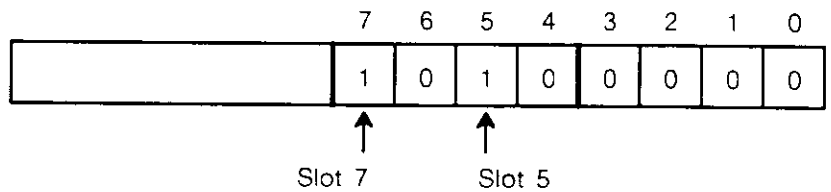

MW 4097.09 IR 60 Status Register

Operating condition of the 07 IR 60

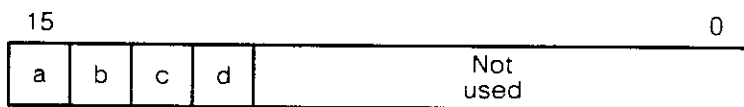

a = Error 1 = yes
 0 = no

b = RUN 1 = RUN
 0 = STOP

c = Initialization 1 = Initialization of the IR 60 is complete
 0 = Initialization of the IR 60 is not complete (see description of IR 60)

d = Battery error 1 = yes
 0 = no

MW 4097.10 not defined

MW 4097.11 Clock setting register Contains the year in BCD code

MW 4097.12 Clock setting register Contains the month and the day in BCD code

MW 4097.13 Clock setting register Contains the day of week in BCD code
 (0 = Sunday, 1 = Monday etc.)

MW 4097.14 Clock setting register Contains the hours and the minutes in BCD code

MW 4097.15 Clock setting register Contains the seconds in BCD code

¹⁾ Communication units are 07 KP 6x, 07 ZB 69, 07 BR 60

No.	Mode of error	Stored data	Detailed description
-----	---------------	-------------	----------------------

MW 4098.00 } Status of the
 MW 4098.01 } communication unit,
 which is plugged
 into the slots 0/1.
 " " " "

MW 4098,n with n = 00, 02, 04, 06,
 08, 10, 12, 14

Bit	Meaning
0	RS-232-C parity/sum error
1	RS-232-C framing error
2	RS-232-C protocol error
3	RS-232-C cycle time-out error
4	RS-422 parity/sum error
5	RS-422 framing error
6	RS-422 protocol error
7	RS-422 cycle time-out error
8	RS-232-C READY
9	RS-422 READY
10	DSR 1 = ON, 0 = OFF
11	} not used
to	
15	

MW 4098.14 } Status of the
 MW 4098.15 } communication unit,
 which is plugged
 into the slots 6/7.
 " " " "

MW 4098,m with m = 01, 03, 05, 07,
 09, 11, 13, 15

Bit	Meaning
0	} used by the system
to	
5	
6	
to	
7	
8	} used by the system
to	
13	
14	
to	
15	

The information on the slot is not defined, if no communication unit is plugged-in.

MW 4099.00 } not used
 MW 4099.01 }

MW 4099.02
 to not defined
 MW 4099.15

No.	Mode of error	Stored data	Detailed description																
MW 4100,00 MW 4100,01 MW 4100,02	List of area 1	Interface number, which is used with the central unit.	<table border="1"> <tr> <td style="text-align: right;">15</td> <td style="text-align: center;">8</td> <td style="text-align: center;">7</td> <td style="text-align: right;">0</td> </tr> <tr> <td style="text-align: center;">a</td> <td colspan="3" style="text-align: center;">"0"</td> </tr> <tr> <td style="text-align: center;">b</td> <td colspan="3" style="text-align: center;">c</td> </tr> <tr> <td style="text-align: center;">d</td> <td colspan="3" style="text-align: center;">e</td> </tr> </table>	15	8	7	0	a	"0"			b	c			d	e		
15	8	7	0																
a	"0"																		
b	c																		
d	e																		
MW 4100,09 MW 4100,10 MW 4100,11	List of area 4	Interface number, which is used with the central unit.	<p>a: 0 = not used 1 = is used for reading 2 = is used for writing</p> <p>b: Number of passes c: Slot number d: Unit number e: Interface number</p>																
MW 4100,12 MW 4100,13 MW 4100,14	Area for debugging list	interface number, which is used for debugging.	<table border="1"> <tr> <td style="text-align: right;">15</td> <td style="text-align: center;">8</td> <td style="text-align: center;">7</td> <td style="text-align: right;">0</td> </tr> <tr> <td style="text-align: center;">During debugging</td> <td colspan="3" style="text-align: center;">"0"</td> </tr> <tr> <td style="text-align: center;">Number of passes</td> <td colspan="3" style="text-align: center;">Slot number</td> </tr> <tr> <td style="text-align: center;">Unit number</td> <td colspan="3" style="text-align: center;">Interface number</td> </tr> </table>	15	8	7	0	During debugging	"0"			Number of passes	Slot number			Unit number	Interface number		
15	8	7	0																
During debugging	"0"																		
Number of passes	Slot number																		
Unit number	Interface number																		
MW 4100,15 to MW 4103,15	not defined																		

Error information for the 1st line of 07 BR 60/61:

Flag	Contents	Bit 15	14	13	12	11	10	9	8	7	6	5	4	3	2	1	0	
MW 4104,00	Assignment																	1)
01	Position of faulty sub-station																	2)
02	Coupler 07 BR 60																	3)
03	Coupler Substation No. 0																	3)
04	" Substation No. 1																	3)
05	" Substation No. 2																	3)
06	" Substation No. 3																	3)
07	" Substation No. 4																	3)
08	" Substation No. 5																	3)
09	" Substation NO. 6																	3)
10	" Substation No. 7																	3)
11	" Substation No. 8																	3)
12	" Substation No. 9																	3)
MW 4105,03	I/O module configuration	0						Sub-station no.			Slot no.							
04	I/O module	0						Sub-station no.			Slot no.							
05	max. updating time in ms																	
06	min. updating time in ms																	
07	updating time in ms																	

MW 4104,13 – MW 4105,02 not relevant

The error information for the 2nd line has the same architecture with MW 4105,08...MW 4106,15
 The error information for the 3rd line has the same architecture with MW 4107,00...MW 4108,07
 The error information for the 4th line has the same architecture with MW 4108,08...MW 4109,15

1) A set bit indicates a used sub-station; e. g. MW 4104,00 = 6 ≙ 0006H means, that the sub-stations no. 1 and 2 of the 1st line are used.

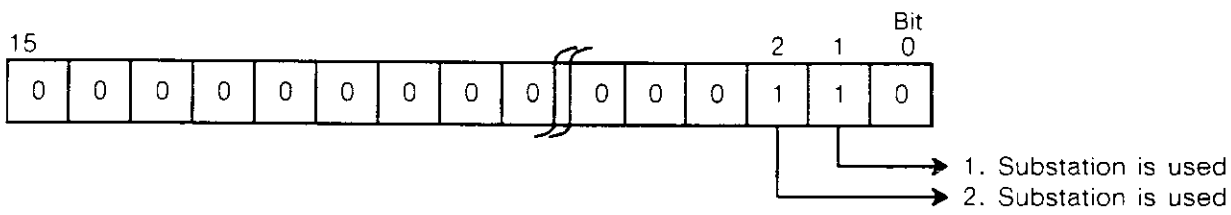

2) A set bit indicates, which sub-station is in a faulty state; e. g. MW 4104,01 = 10 ≙ 000AH means, that the sub-stations 1 and 3 are in a faulty state.

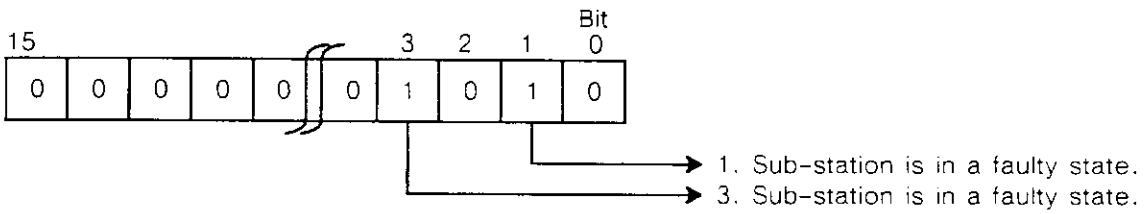

3) A set bit means the case of error

- | | | | |
|-------------|----------------------------------|--------|------------------------------|
| Bit 0 ... 7 | Counter for transmission error | Bit 12 | I/O error on the sub-station |
| Bit 8 | | Bit 13 | System-bus error |
| Bit 9 | Faulty configuration | Bit 14 | Framing error |
| Bit 10 | Faulty connection of sub-station | Bit 15 | Time exceeding |
| Bit 11 | Double sub-station number | | |

Error information for the 1st line of 07 CS 61

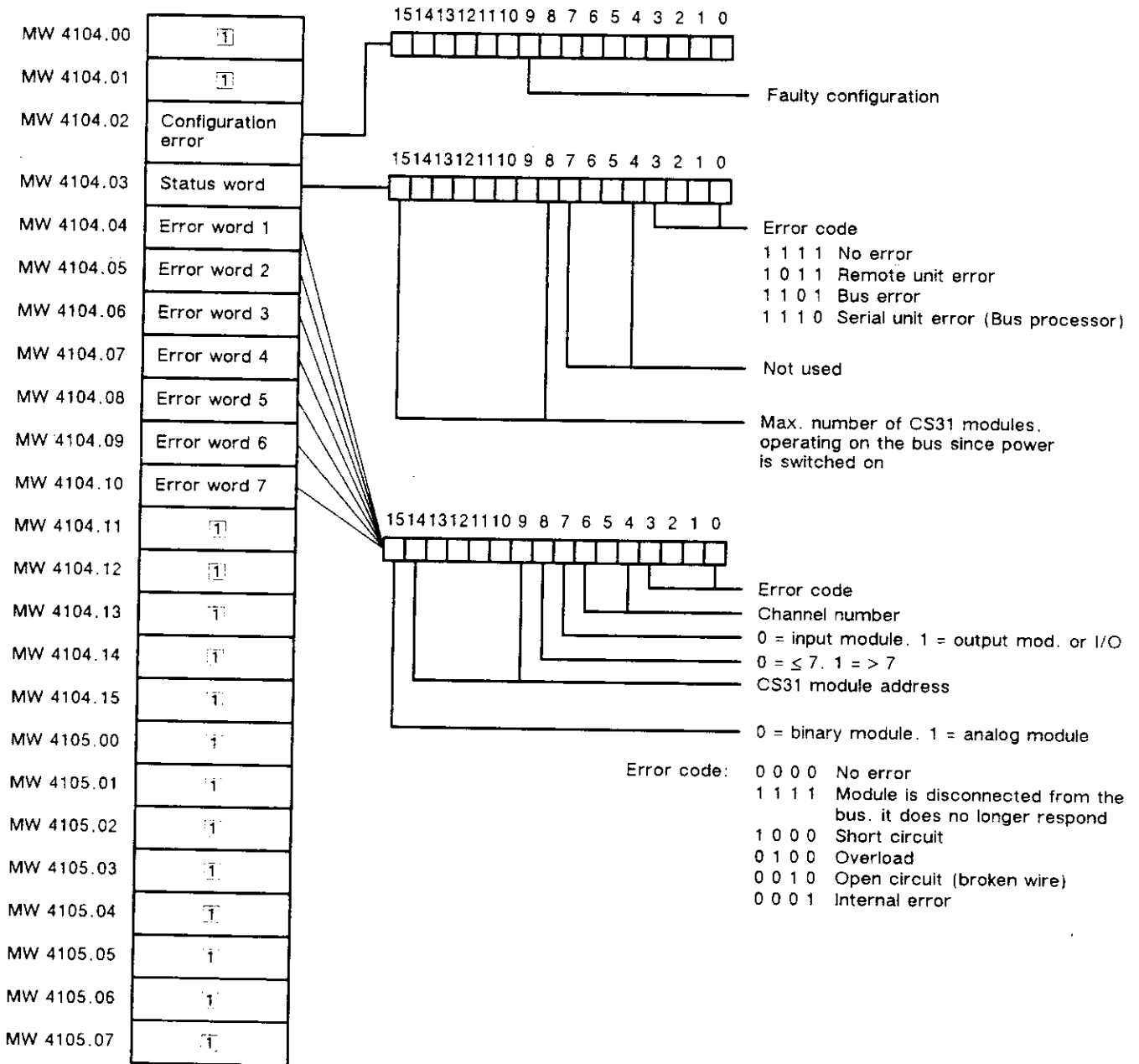

[1] is defined with 07 BR 60, not supported by 07 CS 61

Note: For evaluation of the error flags, the contents are to be considered in hexadecimal.

Word flags for error information of the 1st line: MW 4104.00...MW 4105.07 (see above)

Word flags for error information of the 2nd line: MW 4105.08...MW 4106.15

Word flags for error information of the 3rd line: MW 4107.00...MW 4108.07

Word flags for error information of the 4th line: MW 4108.08...MW 4109.15

Error information for ZB 20 ring 1

		Bit 15	14	13	12	11	10	9	8	7	6	5	4	3	2	1	0	
MW 4110,00	Local unit error information	not defin.	a	b	c	d	e	f	not defined	ST-No. of not connected station								0
MW 4110,01	Information, which 07 ZB 69 units are present.	15	—											0	1			
02		31	—											16	2			
03		47	—											32	3			
04		63	—											48	4			
MW 4110,05	Information, which of the present 07 ZB 69 units are connected.	15	—											0	5			
06		31	—											16	6			
07		47	—											32	7			
08		63	—											48	8			
MW 4110,09	Central unit status flag	3			2		1		0									.
.		"																.
.		"																.
MW 4111,08	Error-status flag	63			62		61		60									18
MW 4111,09		15	—											0	19			
10		31	—											16	1A			
11		47	—											32	1B			
12	63	—											48	1C				
MW 4111,13	Details on the unit error of the stations 00...63	k	l	m	not defined				Transmission error counting								1D	
.		"																.
.		"	"	"	"				"								5C	
MW 4115,12	maximal updating time in ms																5D	
MW 4115,13	minimal updating time in ms																5E	
MW 4115,14	current updating time in ms																5F	

HEX

MW 4116,00 – MW 4121,15 error information in ZB 20 ring 2 (architecture see above)

- a: System-bus error
- b: not defined
- c: Off the configuration area
- d: Doupling of the configuration area
- e: Off the slot number
- f: Not connected transmission cable
- g: Number in the table is unit number (1 = unit number)
- h: Number in the table is unit number (1 = unit connected via ZB 20)
- i: Number in the table is unit number as 4 bit information as follows:

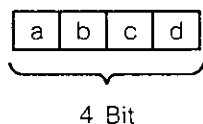

- a: 1 = Central-unit error, 0 = no error
- b: 1 = Simulation, 0 = no simulation
- c: 1 = unchanged, 0 = not unchanged
- d: 1 = operation, 0 = halted

- j: Number in the table is unit number (1 = error, 0 = no error)
- k: Time-out error (1 = error, 0 = no error)
- l: Framing error (1 = error, 0 = no error)
- m: Error between central unit and 07 ZB 69 (1 = error, 0 = no error)

MW 4122,00 to MW 4125,15 not defined

MW 4126,00 to MW 4126,03 reserved as special flags for the communication with the communication processor ASCII 07 KP 62

MW 4126,04 to MW 4127,15 not defined

5.3 Operands

5.3.1 Operands for flags

Operand	07 ZE 60	07 ZE 61/63	07 ZE 62	Remarks	
M	000,00	M 123,15	M 123,15	M 123,15	Bit flag area
M	124,00	M 127,15	M 127,15	M 127,15	Special flag area
M'	000,00	M' 383,31	M' 383,31	M' 383,31	Bit/word flag area
MW	000,00	MW 063,15	MW 063,15	MW 063,15	Word flags with 07 PS 60/61
MW	000,00	MW 1087,15	MW 1087,15	MW 1087,15	Word flags with 07 PS/PR 62
MW	000,00	---	---	MW 3135,15	Word flags with 07 PS/PR 63
MW	4096,00	MW 4127,15	MW 4127,15	MW 4127,15	Special word flag area
MD	000,00	MD 063,14	MD 063,14	MD 063,14	Double word flags with 07 PS 60
MD	000,00	MD 1087,14	MD 1087,14	MD 1087,14	Double word flags with 07 PS 62
MD	000,00	---	---	MD 3135,14	Double word flags with 07 PS 63
MW'	000,00	MW' 383,01	MW' 383,01	MW' 383,01	Word/bit flag area
MD'	000,00	MD' 383,00	MD' 383,00	MD' 383,00	Double word/bit flag area
S	000,00	S 255,15	S 255,15	S 255,15	Step chains with 16 steps

5.3.2 Operands for timers and counters

Operand	07 ZE 60	07 ZE 61/63	07 ZE 62	Remarks	
T	00,00	T 15,15	T 15,15	T 15,15	Times, time bases 0.01 s; 0.1 s; 1 s
Z	00,00	Z 15,15	Z 15,15	Z 15,15	16 bit counters, 00000 ... 65535
TI	00,00	TI 15,15	TI 15,15	TI 15,15	Word variable: Actual value of the time
ZI	00,00	ZI 15,15	ZI 15,15	ZI 15,15	Word variable: Actual val. of the counter

5.3.3 Operands for the coupler areas

Operand	07 ZE 60	07 ZE 61/63	07 ZE 62	Remarks	
E'	0000,00	E' 2047,15	E' 2047,15	E' 2047,15	Inputs in the coupler area
A'	0000,00	A' 2047,15	A' 2047,15	A' 2047,15	Outputs in the coupler area
EW'	0000,00	EW' 2047,00	EW' 2047,00	EW' 2047,00	Word inputs, coupler area
AW'	0000,00	AW' 2047,00	AW' 2047,00	AW' 2047,00	Word outputs, coupler area

Operands and operators are described entirely in 907 PC 32, Programming and Testing Software, System Specific Part ABB Procontic T200.

6 Program Memories

07 PS 60:	CMOS RAM with 3.5 k instructions, RAM data memory with 2 k word flags
07 PS 61:	CMOS RAM with 7.6 k instructions, RAM data memory with 2 k word flags
07 PS 62:	CMOS RAM with 15.7 k instructions, RAM data memory with 16 k word flags
07 PS 63:	CMOS RAM with 48.5 k instructions, RAM data memory with 50 k word flags
07 PR 62:	EPROM with 15.7 k instructions, RAM data memory with 16 k word flags
07 PR 63:	EPROM with 48.5 k instructions, RAM data memory with 50 k word flags

Program memories are not provided automatically with the central units. Dependent on the application, the most suitable type must be ordered separately. The following table shows which program memories can be combined with the various central units (refer also to the description of the central units).

Suitable program memories (with respect to the type of the central units),

suitable for use in the central unit **07 ZE 60:**

07 PS 60	RAM user program memory	max. 3.5 k instructions	1)
	RAM word flag memory	max. 2.0 k word flags	2)
07 PS 61	RAM user program memory	max. 7.6 k instructions	
	RAM word flag memory	max. 2.0 k word flags	
07 PR 62	EPROM user program memory	max. 7.6 k instructions accessible	
	RAM word flag memory	max. 2.0 k word flags accessible	

suitable for use in the central units **07 ZE 61/63:**

07 PS 60	RAM user program memory	max. 3.5 k instructions	
	RAM word flag memory	max. 2.0 k word flags	
07 PS 61	RAM user program memory	max. 7.6 k instructions	
	RAM word flag memory	max. 2.0 k word flags	
07 PS 62	RAM user program memory	max. 15.7 k instructions	
	RAM word flag memory	max. 16.0 k word flags	
07 PR 62	EPROM user program memory	max. 15.7 k instructions	
	RAM word flag memory	max. 16.0 k word flags	

suitable for use in the central unit **07 ZE 62:**

07 PS 60	RAM user program memory	max. 3.5 k instructions	
	RAM word flag memory	max. 2.0 k word flags	
07 PS 61	RAM user program memory	max. 7.6 k instructions	
	RAM word flag memory	max. 2.0 k word flags	
07 PS 62	RAM user program memory	max. 15.7 k instructions	
	RAM word flag memory	max. 16.0 k word flags	
07 PS 63	RAM user program memory	max. 48.5 k instructions	
	RAM word flag memory	max. 50.0 k word flags	
07 PR 62	EPROM user program memory	max. 15.7 k instructions	
	RAM word flag memory	max. 16.0 k word flags	
07 PR 63	EPROM user program memory	max. 48.5 k instructions	
	RAM word flag memory	max. 50.0 k word flags	

Suitable program memories (with respect to the versions of the central units and program memories),

	07 PS 6x R1 ³⁾ 07 PR 6x R1 ³⁾	07 PS 6x R2 07 PR 6x R2	07 PS 6x R3 4)
07 ZE 6x, R101 and R201	yes	yes	yes
07 ZE 6x, R302	no	yes ⁵⁾	yes ⁵⁾

1) referred to 32 bits per instruction (see operator list)

2) 1 word = 16 bits

3) Version R1 will no longer be available in the future

4) **07 PS 60 R3** and **07 PR 6x R3** not available

5) The improved ONLINE programming is only possible with version R302 central units, which are fitted with version R2 or R3 program memories. High-speed ONLINE changes with **07 PS 6x R3** only.

6.1 Program Memory 07 PS 60

CMOS RAM, 3.5 k instructions, 2 k word flags

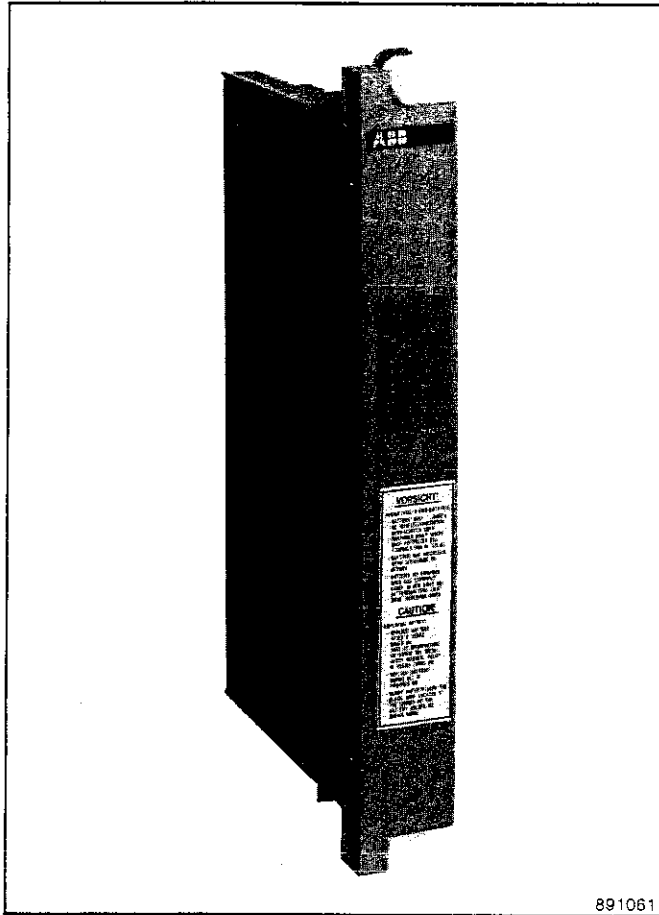

Fig. 6.1.1: Program memory 07 PS 60

The program memory 07 PS 60 (CMOS RAM) with a capacity of 3.5 k instructions and a data memory of 2 k word flags has to be plugged into a central unit.

The data is backed by a lithium battery. A 7-segment display at the central unit indicates when a battery re-

placement is required or errors have occurred. This information can also be got by reading of internal flags. Chapter 5 (description of the central units) includes tables with detailed information about error codes and flags as well as error correction.

After installation of a program memory, the function 'general reset' has to be performed by means of the software 907 PC 32/33.

Program memory versions

Program memories of version **R1** are only suitable for central units of versions R101 and R201.

Program memories of version **R2** can be used with all central units. They enable an improved **ONLINE** programming when central units of version **R302** or later are employed.

Tables on page 6-1 show which program memories can be combined with the various central units (with respect to types and version numbers of central units and program memories).

Battery replacement

In order to avoid data losses the battery has to be replaced within one week after occurrence of error message (error number 71, flag M 125.09). The replacement of the battery is only permitted when the PLC is powered by mains.

The battery is accessible on the front panel of the program memory. Plus and minus poles of the connection are colored (+ red, - black). Reverse polarity is avoided mechanically. For replacement battery only a genuine spare battery may be used (order No. see Technical data).

Technical Data

Memory capacity		max. 3.5 k instructions ¹⁾ max. 2 k word flags ²⁾
Utilization capability		
if mounted in 07 ZE 60		full capability
if mounted in 07 ZE 61		full capability
if mounted in 07 ZE 62		full capability
if mounted in 07 ZE 63		full capability
Battery back-up		by means of a lithium battery
Battery lifetime	07 PS 60 R1 07 PS 60 R2	min. 12500 h, when it is on duty min. 6300 h, when it is on duty
Error indications		by means of internal flags or error number on 7-seg- ment display at the central unit
Location of mounting		in the central unit
Weight		420 g
Order numbers ³⁾	07 PS 60 R1 07 PS 60 R2	GJV3074330R1 (R1 will not be available in the future) GJV3074330R2
Accessories (supplied)		1 lithium battery
Order number of spare battery		GJV3074399R1

Error indications

Internal flags

M 124,10
M 125,09

RAM – ERR (RAM error)
BAT – ERR (Battery error)

Error number on the 7-segment display of the central unit

14
25
31
27
71

Wrong type of program memory is inserted
Program memory is not plugged-in properly
1. The user program memory contains invalid data;
2. Data cannot be read or written (check sum error)
Data cannot be written into the memory or be read
from the memory
1. Battery is not mounted correctly
2. Battery voltage is too low

Error remedy, when flag M 125,09 is set or
error No. 71 is displayed

Battery replacement
In order to avoid data losses the battery has to be re-
placed within one week after occurrence of error mes-
sage (error number 71, flag M 125,09). The replace-
ment of the battery is only permitted when the PLC is
powered by mains.

¹⁾ according to 32 bits per instruction (see operator list)

²⁾ 1 word = 16 bits

³⁾ If in order to enable fast ONLINE changes a program memory of version R3 is required, a program memory 07 PS 61...63 R3 can be used.

6.2 Program Memory 07 PS 61

CMOS RAM, 7.6 k instructions, 2 k word flags

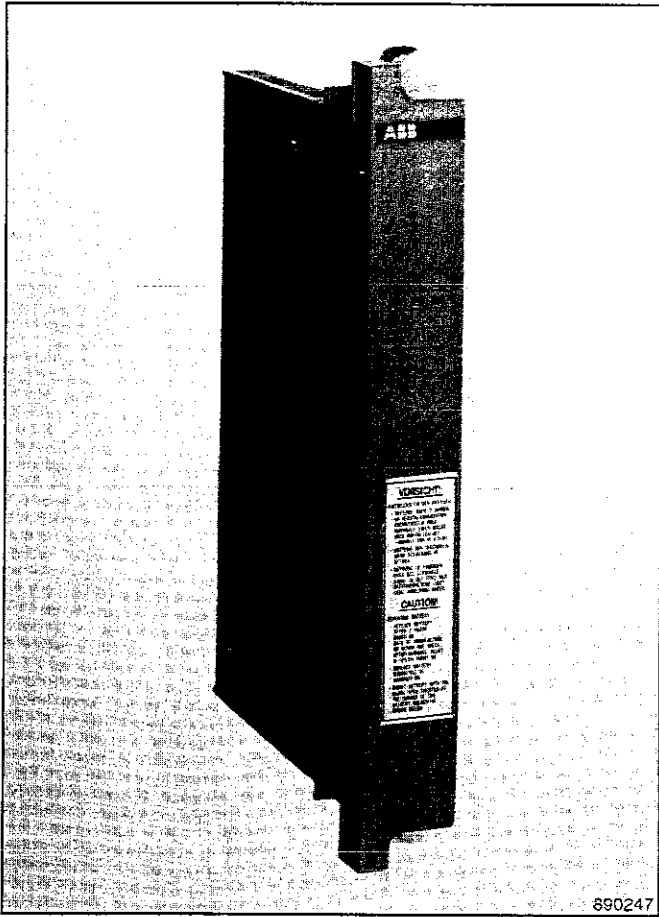

Fig. 6.2.1: Program memory 07 PS 61

The program memory 07 PS 61 (CMOS RAM) with a capacity of 7.6 k instructions and a data memory of 2 k word flags has to be plugged into a central unit.

The data is backed by a lithium battery. A 7-segment display at the central unit indicates when a battery re-

placement is required or errors have occurred. This information can also be got by reading of internal flags. Chapter 5 (description of the central units) includes tables with detailed information about error codes and flags as well as error correction.

After installation of a program memory, the function 'general reset' has to be performed by means of the software 907 PC 32/33.

Program memory versions

Program memories of version **R1** are only suitable for central units of versions R101 and R201.

Program memories of version **R2** can be used with all central units. They enable an improved **ONLINE** programming when central units of version **R302** or later are employed.

Program memories of version **R3** additionally enable fast **ONLINE** changes (central units as of R302).

Tables on page 6-1 show which program memories can be combined with the various central units (with respect to types and version numbers of central units and program memories).

Battery replacement

In order to avoid data losses the battery has to be replaced within one week after occurrence of error message (error number 71, flag M 125,09). The replacement of the battery is only permitted when the PLC is powered by mains.

The battery is accessible on the front panel of the program memory. Plus and minus poles of the connection are colored (+ red, - black). Reverse polarity is avoided mechanically. For replacement battery only a genuine spare battery may be used (order No. see Technical data).

Technical Data

Memory capacity		max. 7.6 k instructions ¹⁾ max. 2 k word flags ²⁾
Utilization capability		full capability
if mounted in 07 ZE 60		full capability
if mounted in 07 ZE 61		full capability
if mounted in 07 ZE 62		full capability
if mounted in 07 ZE 63		full capability
Battery back-up		by means of a lithium battery
Battery lifetime	07 PS 61 R1	min. 12500 h, when it is on duty
	07 PS 61 R2	min. 6300 h, when it is on duty
	07 PS 61 R3	min. 4200 h, when it is on duty
Error indications		by means of internal flags or error number on 7-seg- ment display at the central unit
Location of mounting		in the central unit
Weight		425 g
Order numbers	07 PS 61 R1	GJV3074331R1 (R1 will not be available in the future)
	07 PS 61 R2	GJV3074331R2
	07 PS 61 R3	GJV3074331R3
Accessories (supplied)		1 lithium battery
Order number of spare battery		GJV3074399R1

Error indications

Internal flags

M 124,10
M 125,09

RAM - ERR (RAM error)
BAT - ERR (Battery error)

Error number on the 7-segment display of the central unit

14
25
31
27
71

Wrong type of program memory is inserted
Program memory is not plugged-in properly
1. The user program memory contains invalid data;
2. Data cannot be read or written (check sum error)
Data cannot be written into the memory or be read
from the memory
1. Battery is not mounted correctly
2. Battery voltage is too low

Error remedy, when flag M 125,09 is set or
error No. 71 is displayed

Battery replacement
In order to avoid data losses the battery has to be re-
placed within one week after occurrence of error mes-
sage (error number 71, flag M 125,09). The replace-
ment of the battery is only permitted when the PLC is
powered by mains.

1) according to 32 bits per instruction (see operator list)
2) 1 word = 16 bits

6.3 Program Memory 07 PS 62

CMOS RAM, 15.7 k instructions, 16 k word flags

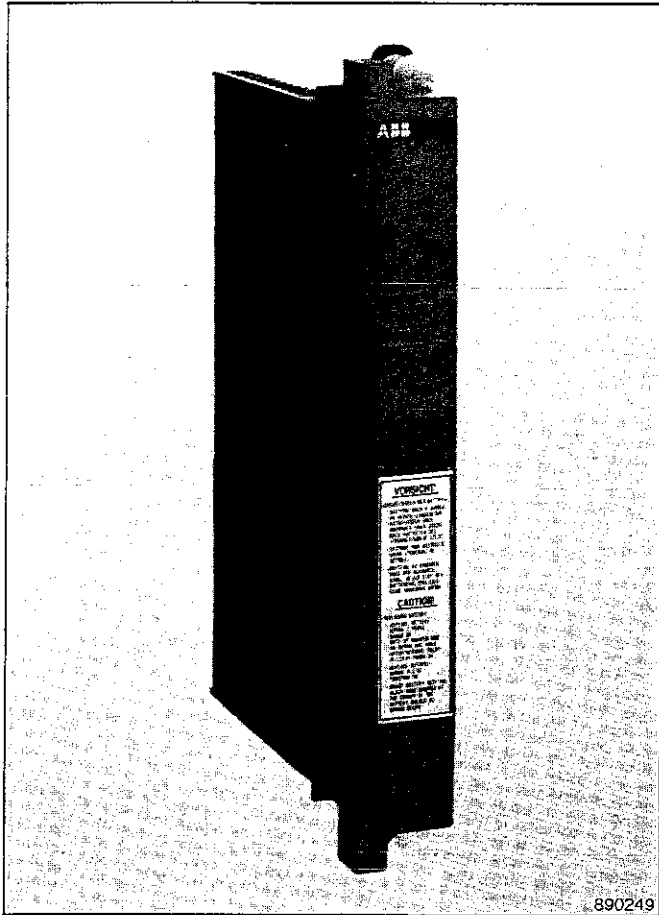

Fig. 6.3.1: Program memory 07 PS 62

The program memory 07 PS 62 (CMOS RAM) with a capacity of 15.7 k instructions and a data memory of 16 k word flags has to be plugged into a central unit.

The data is backed by a lithium battery. A 7-segment display at the central unit indicates when a battery replacement is required or errors have occurred. This information can also be got by reading of internal flags.

Chapter 5 (description of the central units) includes tables with detailed information about error codes and flags as well as error correction.

For the central unit 07 ZE 60 the whole memory area is only partly usable.

After installation of a program memory, the function 'general reset' has to be performed by means of the software 907 PC 32/33.

Program memory versions

Program memories of version **R1** are only suitable for central units of versions R101 and R201.

Program memories of version **R2** can be used with all central units. They enable an improved **ONLINE** programming when central units of version **R302** or later are employed.

Program memories of version **R3** additionally enable fast **ONLINE** changes (central units as of R302).

Tables on page 6-1 show which program memories can be combined with the various central units (with respect to types and version numbers of central units and program memories).

Battery replacement

In order to avoid data losses the battery has to be replaced within one week after occurrence of error message (error number 71, flag M 125,09). The replacement of the battery is only permitted when the PLC is powered by mains.

The battery is accessible on the front panel of the program memory. Plus and minus poles of the connection are colored (+ red, - black). Reverse polarity is avoided mechanically. For replacement battery only a genuine spare battery may be used (order No. see Technical data).

Technical Data

Memory capacity		max. 15.7 k instructions ¹⁾ max. 16 k word flags ²⁾
Utilization capability		partial capability full capability full capability full capability
	if mounted in 07 ZE 60	
	if mounted in 07 ZE 61	
	if mounted in 07 ZE 62	
	if mounted in 07 ZE 63	
Battery back-up		by means of a lithium battery
Battery lifetime	07 PS 62 R1	min. 6300 h, when it is on duty
	07 PS 62 R2	min. 4200 h, when it is on duty
	07 PS 62 R3	min. 3200 h, when it is on duty
Error indications		by means of internal flags or error number on 7-seg- ment display at the central unit
Location of mounting		in the central unit
Weight		430 g
Order numbers	07 PS 62 R1	GJV3074332R1 (R1 will not be available in the future)
	07 PS 62 R2	GJV3074332R2
	07 PS 62 R3	GJV3074332R3
Accessories (supplied)		1 lithium battery
Order number of spare battery		GJV3074399R1

Error indications

Internal flags

M 124,10
M 125,09

RAM - ERR (RAM error)
BAT - ERR (Battery error)

Error number on the 7-segment display of the central unit

14
25
31
27
71

Wrong type of program memory is inserted
Program memory is not plugged-in properly
1. The user program memory contains invalid data;
2. Data cannot be read or written (check sum error)
Data cannot be written into the memory or be read
from the memory
1. Battery is not mounted correctly
2. Battery voltage is too low

Error remedy, when flag M 125,09 is set or
error No. 71 is displayed

Battery replacement

In order to avoid data losses the battery has to be re-
placed within one week after occurrence of error mes-
sage (error number 71, flag M 125,09). The replace-
ment of the battery is only permitted when the PLC is
powered by mains.

¹⁾ according to 32 bits per instruction (see operator list)

²⁾ 1 word = 16 bits

6.4 Program Memory 07 PS 63

CMOS RAM, 48.5 k instructions, 50 k word flags

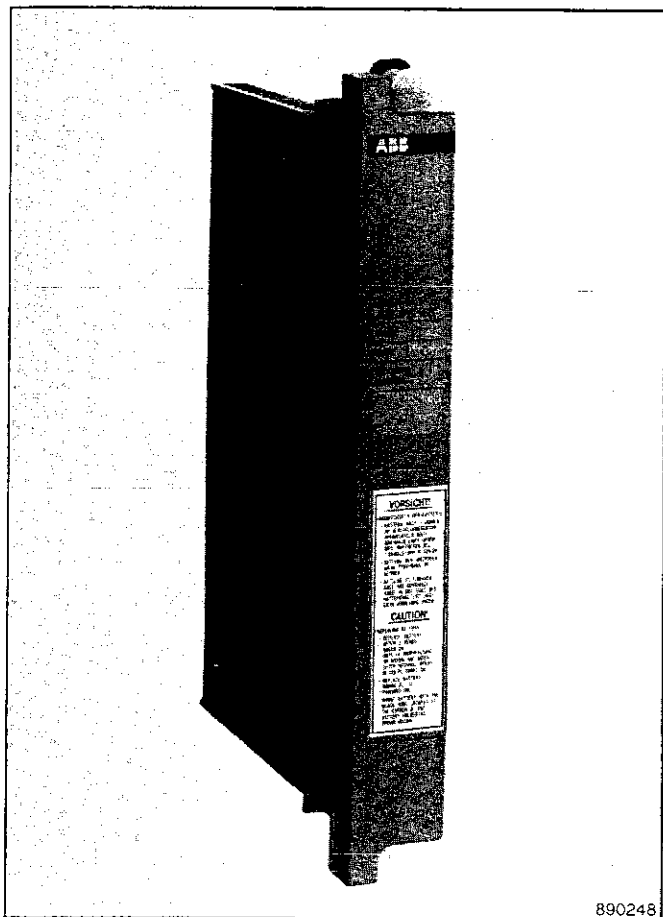

Fig. 6.4.1: Program memory 07 PS 63

The program memory 07 PS 63 (CMOS RAM) with a capacity of 48.5 k instructions and a data memory of 50 k word flags has to be plugged into a central unit.

The data is backed by a lithium battery. A 7-segment display at the central unit indicates when a battery replacement is required or errors have occurred. This information can also be got by reading of internal flags.

Chapter 5 (description of the central units) includes tables with detailed information about error codes and flags as well as error correction.

For the central units 07 ZE 60, 07 ZE 61 and 07 ZE 63 the whole memory area is only partly usable.

After installation of a program memory, the function 'general reset' has to be performed by means of the software 907 PC 32/33.

Program memory versions

Program memories of version **R1** are only suitable for central units of versions R101 and R201.

Program memories of version **R2** can be used with all central units. They enable an improved ONLINE programming when central units of version **R302** or later are employed.

Program memories of version **R3** additionally enable fast ONLINE changes (central units as of R302).

Tables on page 6-1 show which program memories can be combined with the various central units (with respect to types and version numbers of central units and program memories).

Battery replacement

In order to avoid data losses the battery has to be replaced within one week after occurrence of error message (error number 71, flag M 125,09). The replacement of the battery is only permitted when the PLC is powered by mains.

The battery is accessible on the front panel of the program memory. Plus and minus poles of the connection are colored (+ red, - black). Reverse polarity is avoided mechanically. For replacement battery only a genuine spare battery may be used (order No. see Technical data).

Technical Data

Memory capacity		max. 48.5 k instructions ¹⁾ max. 50 k word flags ²⁾
Utilization capability		partial capability
if mounted in 07 ZE 60		partial capability
if mounted in 07 ZE 61		full capability
if mounted in 07 ZE 62		partial capability
if mounted in 07 ZE 63		partial capability
Battery back-up		by means of a lithium battery
Battery lifetime	07 PS 63 R1	min. 2400 h, when it is on duty
	07 PS 63 R2	min. 4200 h, when it is on duty
	07 PS 63 R3	min. 3200 h, when it is on duty
Error indications		by means of internal flags or error number on 7-segment display at the central unit
Location of mounting		in the central unit
Weight		460 g
Order numbers	07 PS 63 R1	GJV3074333R1 (R1 will not be available in the future)
	07 PS 63 R2	GJV3074333R2
	07 PS 63 R3	GJV3074333R3
Accessories (supplied)		1 lithium battery
Order number of spare battery		GJV3074399R1

Error indications

Internal flags

M 124,10

RAM - ERR (RAM error)

M 125,09

BAT - ERR (Battery error)

Error number on the 7-segment display of the central unit

14

Wrong type of program memory is inserted

25

Program memory is not plugged-in properly

31

1. The user program memory contains invalid data;
2. Data cannot be read or written (check sum error)

27

Data cannot be written into the memory or be read from the memory

71

1. Battery is not mounted correctly
2. Battery voltage is too low

Error remedy, when flag M 125,09 is set or error No. 71 is displayed

Battery replacement

In order to avoid data losses the battery has to be replaced within one week after occurrence of error message (error number 71, flag M 125,09). The replacement of the battery is only permitted when the PLC is powered by mains.

¹⁾ according to 32 bits per instruction (see operator list)

²⁾ 1 word = 16 bits

6.5 Program Memory 07 PR 62

EPROM, 15.7 k instructions, 16 k word flags

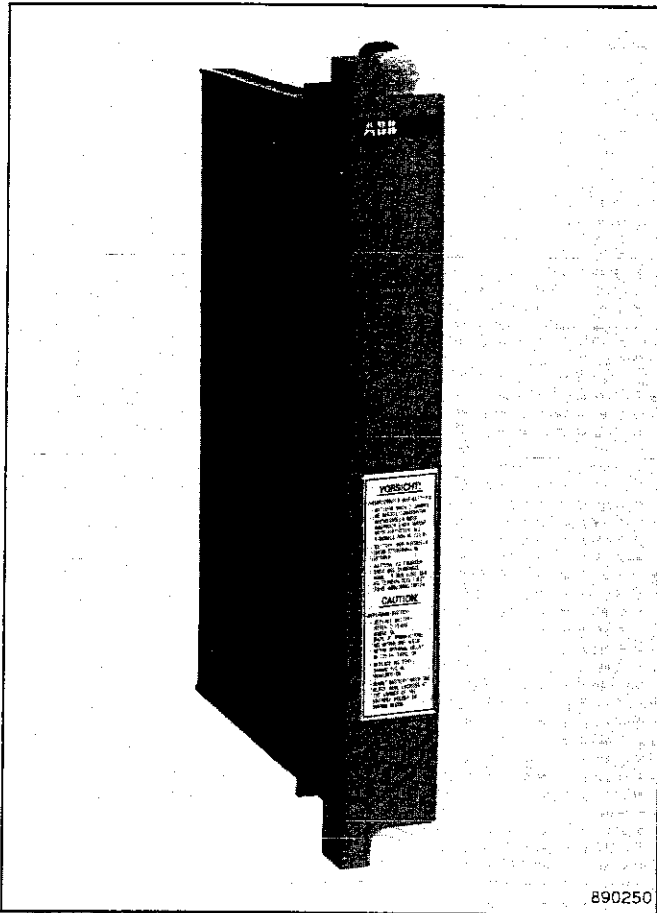

Fig. 6.5.1: Program memory 07 PR 62

The program memory 07 PR 62 (EPROM) with a capacity of 15.7 k instructions and a data memory of 16 k word flags has to be plugged into a central unit. It contains two EPROMs, which are plugged in IC sockets (Low-Byte and High-Byte).

The RAM data is backed by a lithium battery. A 7-segment display at the central unit indicates when a battery replacement is required or errors have occurred. This information can also be got by reading of internal flags. Chapter 5 (description of the central units) includes tables with detailed information about error codes and flags as well as error correction.

For the central unit 07 ZE 60 the whole memory area is only partly usable.

Putting into operation of the 07 PR 62 EPROM program memory

After running of the program test with a 07 PS 60...63 program memory and the following programming of the EPROMs in accordance with 907 PC 32/T200 EPROM-programming the 07 PR 62 is put into operation in the following order:

1. Turn off power
2. Remove 07 PS 60...63
3. Insert 07 PR 62
4. Turn on power
5. Perform "General reset" with programming SW
6. Start program

Note:

On commissioning of the ABB Procontic T200, an operating mode such as 'Operation without output' or 'Forcing' can be activated when EPROM memories are used and the system is switched on. This modes are normally reset by the 907 PC 32 programming system. If, however, no programming unit is present on commissioning, an EPROM memory initialization can be performed in order to reset the mentioned operating modes. This takes place as follows:

1. Disconnect back-up battery
2. Switch on PLC
3. Connect back-up battery again

Program memory versions

Program memories of version **R1** are only suitable for central units of versions R101 and R201.

Program memories of version **R2** can be used with all central units.

Tables on page 6-1 show which program memories can be combined with the various central units (with respect to types and version numbers of central units and program memories).

Battery replacement

In order to avoid data losses the battery has to be replaced within one week after occurrence of error message (error number 71, flag M 125,09). The replacement of the battery is only permitted when the PLC is powered by mains.

The battery is accessible on the front panel of the program memory. Plus and minus poles of the connection are colored (+ red, - black). Reverse polarity is avoided mechanically. For replacement battery only a genuine spare battery may be used (order No. see Technical data).

Hints for EPROM replacement

The program memory is accessible from the right side to insert or replace EPROMs. The IC sockets for the EPROMs are labelled as follows:

- for the Low-Byte EPROM with SKT0,
- for the High-Byte EPROM with SKT1.

Special care has to be taken not to insert EPROMs in the wrong direction (Pin 1 is marked).

Technical Data

Memory capacity		max. 15.7 k instructions, EPROM 1) max. 16 k word flags, CMOS RAM 2)
Utilization capability		partial capability full capability full capability full capability
if mounted in 07 ZE 60		
if mounted in 07 ZE 61		
if mounted in 07 ZE 62		
if mounted in 07 ZE 63		
Battery back-up		by means of a lithium battery
Battery lifetime	07 PR 62 R1 07 PR 62 R2	min. 12500 h, when it is on duty min. 4200 h, when it is on duty
Error indications		by means of internal flags or error number on 7-seg- ment display at the central unit
Location of mounting		in the central unit
Weight		440 g
Order numbers 3)	07 PR 62 R1 07 PR 62 R2	GJV3074336R1 (R1 will not be available in the future) GJV3074336R2
Accessories (supplied)		1 lithium battery, 1 pair of EPROMs
Order number of spare battery		GJV3074399R1
Order number of a further 07 PR 67 EPROM set		
07 PR 67 R1	only for 07 PR 62 R1	GJV3074338R1 (R1 will not be available in the future)
07 PR 67 R2	for 07 PR 62 R2 and R1	GJR5240800R2

Error indications

Internal flags		
M 124.10		RAM - ERR (RAM error)
M 125.09		BAT - ERR (Battery error)
Error number on the 7-segment display of the central unit		
14		Wrong type of program memory is inserted.
25		Program memory is not plugged-in properly.
31		1. The program is not stored correctly in the user program memory. 2. The EPROM is not mounted correctly (check sum error).
33		Indicates after power-on, that EPROMs are not mounted properly or not mounted at all.
27		Data cannot be written into the memory or be read from the memory
71		1. Battery is not mounted correctly 2. Battery voltage is too low
Error remedy, when flag M 125.09 is set or error No. 71 is displayed		Battery replacement In order to avoid data losses the battery has to be re- placed within one week after occurrence of error mes- sage (error number 71, flag M 125.09). The replace- ment of the battery is only permitted when the PLC is powered by mains.

1) according to 32 bits per instruction (see operator list)

2) 1 word = 16 bits

3) Fast ONLINE changes are not feasible with EPROM program memories.
Program memories for fast ONLINE changes see 07 PS 61...63 R3.

6.6 Program Memory 07 PR 63

EPROM, 48.5 k instructions, 50 k word flags

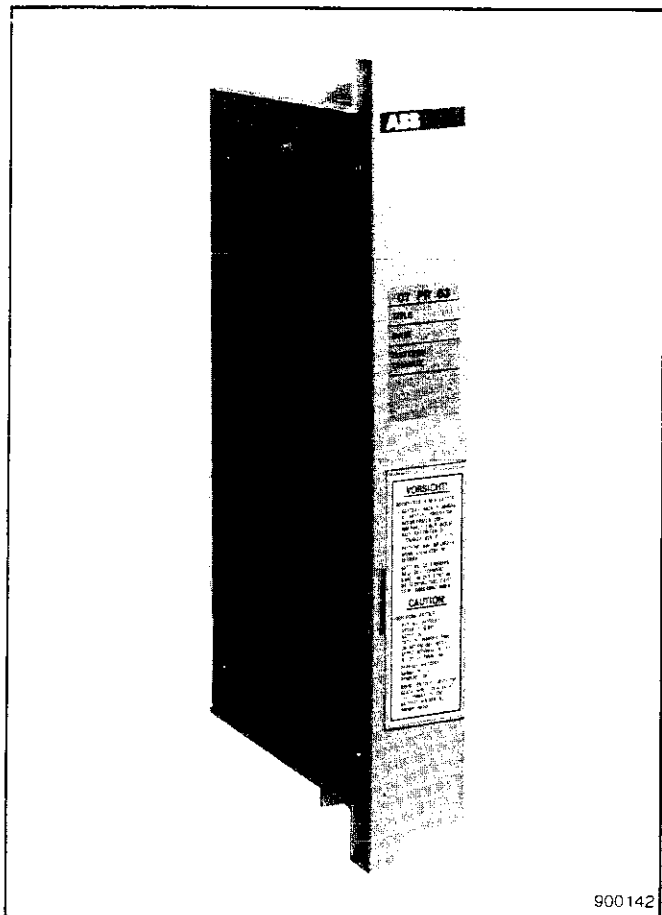

Fig. 6.6.1: Program memory 07 PR 63

The program memory 07 PR 63 (EPROM) with a capacity of 48.5 k instructions and a data memory of 50 k word flags has to be plugged into a central unit. It contains two EPROMs, which are plugged in IC sockets (Low-Byte and High-Byte).

The RAM data is backed by a lithium battery. A 7-segment display at the central unit indicates when a battery replacement is required or errors have occurred. This information can also be got by reading of internal flags. Chapter 5 (description of the central units) includes tables with detailed information about error codes and flags as well as error correction.

For the central units 07 ZE 60, 07 ZE 61 and 07 ZE 63 the whole memory area is only partly usable.

Putting into operation of the 07 PR 63 EPROM program memory

After running of the program test with a 07 PS 60...63 program memory and the following programming of the EPROMs in accordance with 907 PC 32/T200 EPROM-programming the 07 PR 63 is put into operation in the following order:

1. Turn off power
2. Remove 07 PS 60...63
3. Insert 07 PR 63
4. Turn on power
5. Perform "General reset" with programming SW
6. Start program

Note:

On commissioning of the ABB Procontic T200, an operating mode such as 'Operation without output' or 'Forcing' can be activated when EPROM memories are used and the system is switched on. This modes are normally reset by the 907 PC 32 programming system. If, however, no programming unit is present on commissioning, an EPROM memory initialization can be performed in order to reset the mentioned operating modes. This takes place as follows:

1. Disconnect back-up battery
2. Switch on PLC
3. Connect back-up battery again

Program memory versions

Program memories of version **R1** are only suitable for central units of versions R101 and R201.

Program memories of version **R2** can be used with all central units.

Tables on page 6-1 show which program memories can be combined with the various central units (with respect to types and version numbers of central units and program memories).

Battery replacement

In order to avoid data losses the battery has to be replaced within one week after occurrence of error message (error number 71, flag M 125,09). The replacement of the battery is only permitted when the PLC is powered by mains.

The battery is accessible on the front panel of the program memory. Plus and minus poles of the connection are colored (+ red, - black). Reverse polarity is avoided mechanically. For replacement battery only a genuine spare battery may be used (order No. see Technical data).

Hints for EPROM replacement

The program memory is accessible from the right side to insert or replace EPROMs. The IC sockets for the EPROMs are labelled as follows:

- for the Low-Byte EPROM with SKT0,
- for the High-Byte EPROM with SKT1.

Special care has to be taken not to insert EPROMs in the wrong direction (Pin 1 is marked).

Technical Data

Memory capacity		max. 48.5 k instructions, EPROM ¹⁾ max. 50 k word flags, CMOS RAM ²⁾
Utilization capability		partial capability
if mounted in 07 ZE 60		partial capability
if mounted in 07 ZE 61		full capability
if mounted in 07 ZE 62		partial capability
if mounted in 07 ZE 63		
Battery back-up		by means of a lithium battery
Battery lifetime	07 PR 63 R1 07 PR 63 R2	min. 6300 h, when it is on duty min. 4200 h, when it is on duty
Error indications		by means of internal flags or error number on 7-seg- ment display at the central unit
Location of mounting		in the central unit
Weight		440 g
Order numbers ³⁾	07 PR 63 R1 07 PR 63 R2	GJV3074337R1 (R1 will not be available in the future) GJV3074337R2
Accessories (supplied)		1 lithium battery, 1 pair of EPROMs
Order number of spare battery		GJV3074399R1
Order number of a further 07 PR 68 EPROM set		
07 PR 68 R1	only for 07 PR 63 R1	GJV3074339R1 (R1 will not be available in the future)
07 PR 68 R2	for 07 PR 63 R2 and R1	GJR5240900R2

Error indications

Internal flags

M 124,10
M 125,09

RAM - ERR (RAM error)
BAT - ERR (Battery error)

Error number on the 7-segment display of the central unit

14

Wrong type of program memory is inserted.

25

Program memory is not plugged-in properly.

31

1. The program is not stored correctly in the user program memory.
2. The EPROM is not mounted correctly (check sum error).

33

Indicates after power-on, that EPROMs are not mounted properly or not mounted at all.

27

Data cannot be written into the memory or be read from the memory

71

1. Battery is not mounted correctly
2. Battery voltage is too low

Error remedy, when flag M 125,09 is set or error No. 71 is displayed

Battery replacement

In order to avoid data losses the battery has to be replaced within one week after occurrence of error message (error number 71, flag M 125,09). The replacement of the battery is only permitted when the PLC is powered by mains.

¹⁾ according to 32 bits per instruction (see operator list)

²⁾ 1 word = 16 bits

³⁾ Fast ONLINE changes are not feasible with EPROM program memories. Program memories for fast ONLINE changes see **07 PS 61...63 R3**.

7 Binary Input Modules

07 EB 60 R1: Binary input module,	24 V DC/24 V AC,	electrically isolated, 16 inputs
07 EB 61 R1: Binary input module,	24 V DC/24 V AC,	electrically isolated, 32 inputs
07 EB 62 R1: High-speed binary input module,	24 V DC,	electrically isolated, 32 inputs
07 EB 63 R1: Binary input module,	48 V DC/48 V AC,	electrically isolated, 16 inputs
07 EB 64 R1: Binary input module,	48 V DC/48 V AC,	electrically isolated, 32 inputs
07 EB 66 R1: Binary input module,	110 V AC,	electrically isolated, 16 inputs
07 EB 67 R1: Binary input module,	220 V AC,	electrically isolated, 16 inputs

7.1 Binary Input Module 07 EB 60 R1

24 V DC, 24 V AC , 16 inputs, electrically isolated

Binary, isolated input module with 16 input channels for rated voltages of 24 V DC or 24 V AC. The device transforms the external process signals to the internal signal level of the PLC.

The signal states of the process signals are displayed by green LEDs. The 0V reference potential is separately connected to 8 channels at a time.

Technical Data

Number of inputs per module	16																											
Electrical isolation	in 2 groups of 8 inputs each, each group with separate reference potential ZP																											
Nominal insulation voltage, process terminals versus subrack, internal connections and other groups:	acc. VDE 0160 tested with 60 V AC 500 V AC																											
Process supply voltages, rated values upper limits	24 V DC, 24 V AC 30 V DC, 30 V AC																											
Input signal level: signal 0 signal 1	- 3.6 V...+ 3.6 V, 0...2.5 V AC - 30 V...- 9 V, + 9 V...+ 30 V, 9 V AC...30 V AC																											
Input signal frequency, if AC	47 Hz...63 Hz																											
Input resistance	approx. 2.2 kΩ																											
Input current if UP1 = 24 V DC if UP7 = 24 V AC	approx. 10 mA approx. 10 mA																											
Input signal delay signal edge 0 → 1 signal edge 1 → 0	min. 1 ms max. 16 ms min. 11 ms max. 16 ms																											
Supply current from internal voltages UB1 = 5 V DC UB4 = 24 V DC	max. 0.12 A no current consumption																											
Power dissipation	max. 6.9 W																											
Cable length, if cables have been laid parallel in cable duct: shielded unshielded	max. 1000 m max. 600 m																											
Conductor cross section of process terminals	max. 1.5 mm ²																											
Signalling of the input signals	one green LED per channel																											
Number of required slots	1 I/O slot																											
Number of occupied I/O points	16																											
Configuration identifier in 907 PC 32	E16																											
Ability of fitting in subracks slots, ● = plug-in is possible	<table border="1" style="border-collapse: collapse; text-align: center; width: 100%;"> <tr> <th colspan="3">BT</th> <th colspan="3">BE-central</th> <th colspan="3">BE-remote</th> </tr> <tr> <td>NG</td><td>ZE</td><td>I/O</td> <td>NG</td><td>BV</td><td>I/O</td> <td>NG</td><td>BV</td><td>I/O</td> </tr> <tr> <td></td><td></td><td>●</td> <td></td><td></td><td>●</td> <td></td><td></td><td>●</td> </tr> </table>	BT			BE-central			BE-remote			NG	ZE	I/O	NG	BV	I/O	NG	BV	I/O			●			●			●
BT			BE-central			BE-remote																						
NG	ZE	I/O	NG	BV	I/O	NG	BV	I/O																				
		●			●			●																				
Weight	360 g																											
Order number	GJV3074340R1																											

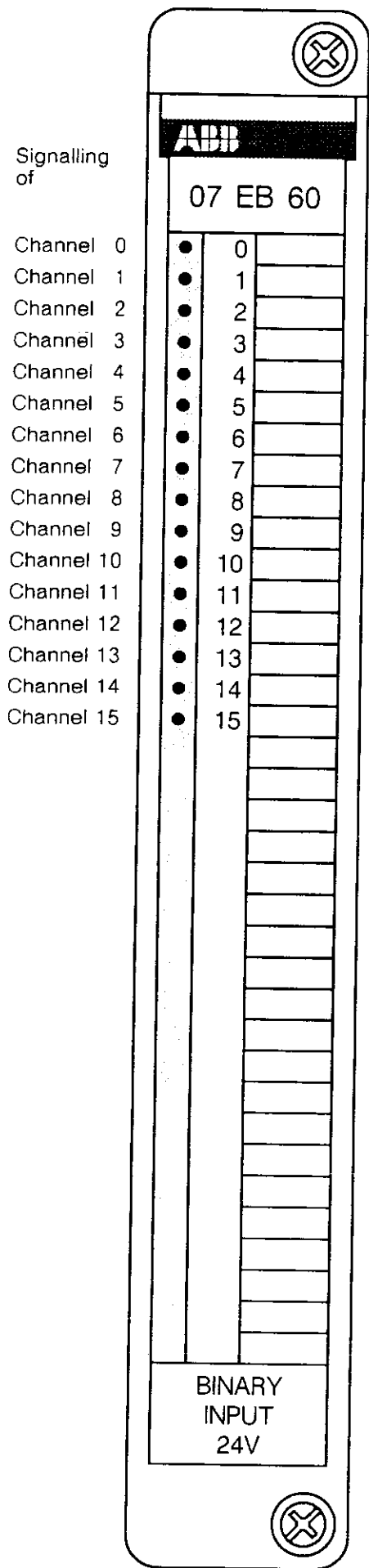

Signalling of

Channel 0	●	0
Channel 1	●	1
Channel 2	●	2
Channel 3	●	3
Channel 4	●	4
Channel 5	●	5
Channel 6	●	6
Channel 7	●	7
Channel 8	●	8
Channel 9	●	9
Channel 10	●	10
Channel 11	●	11
Channel 12	●	12
Channel 13	●	13
Channel 14	●	14
Channel 15	●	15

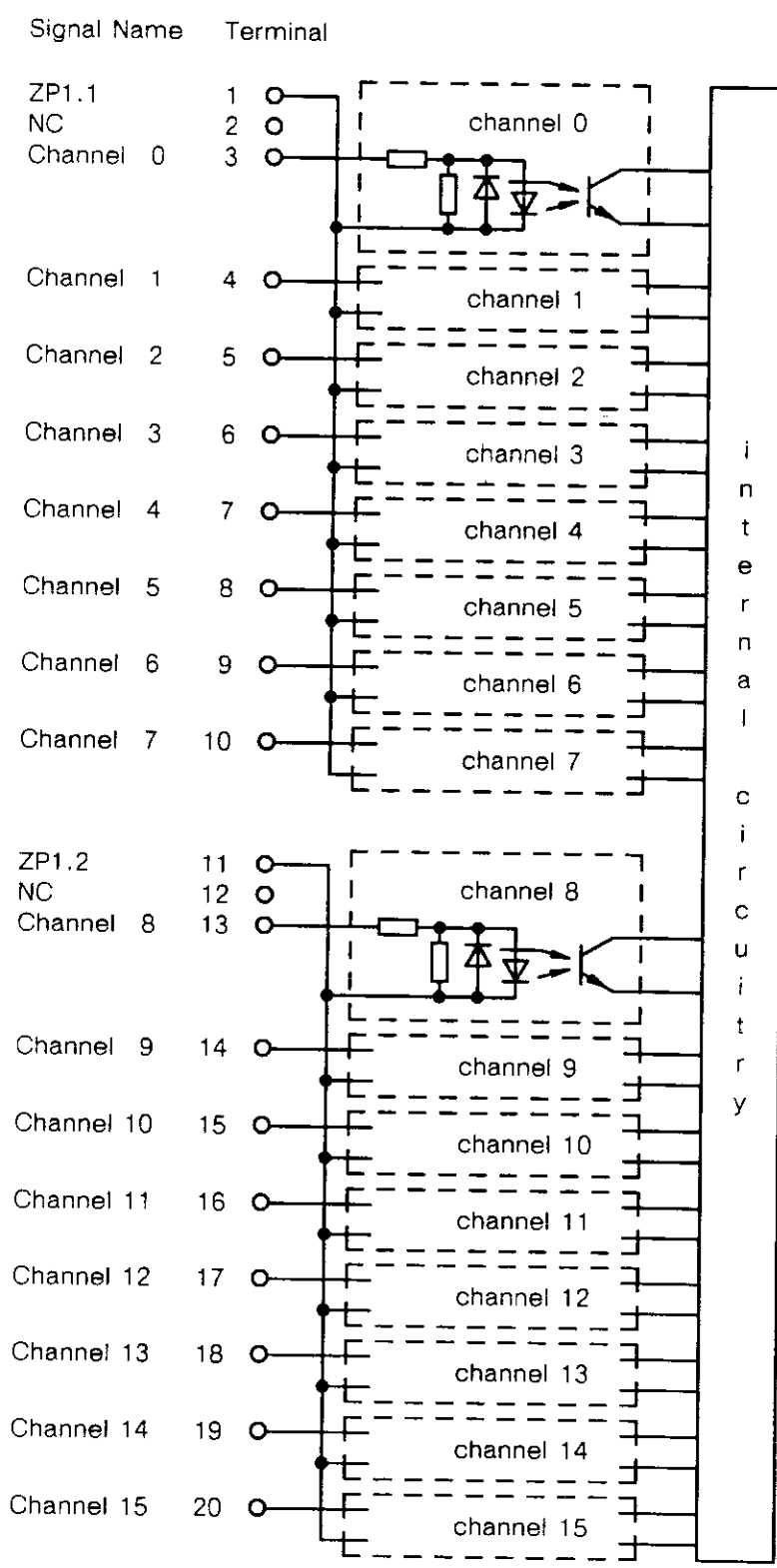

Fig. 7.1.1: 07 EB 60: Signalling, input circuitry, terminal assignment and signal names of channels

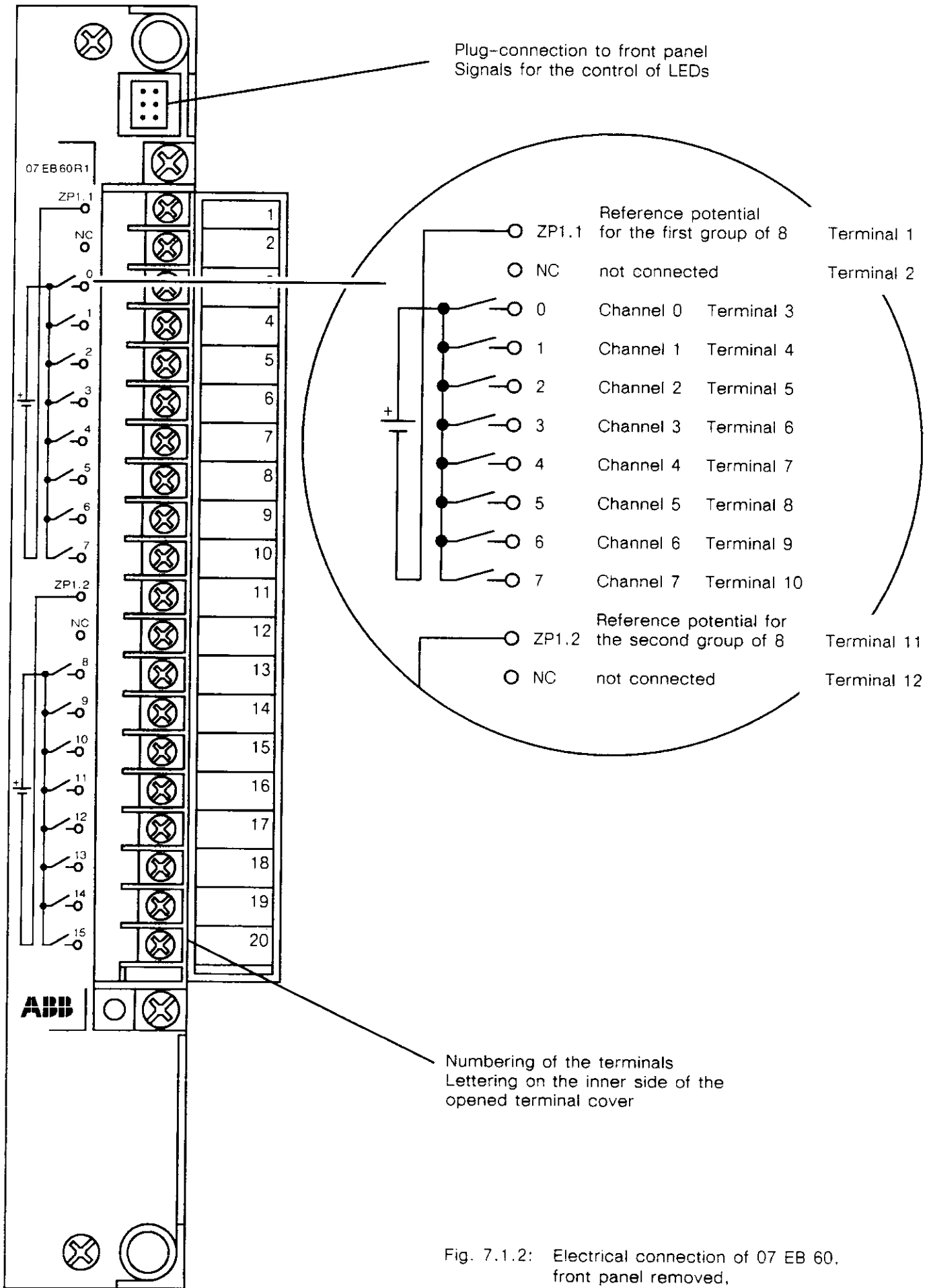

Fig. 7.1.2: Electrical connection of 07 EB 60, front panel removed, terminal cover opened

7.2 Binary Input Module 07 EB 61 R1

24 V DC, 24 V AC , 32 inputs, electrically isolated

Binary, isolated input module with 32 input channels for rated voltages of 24 V DC or 24 V AC. The device transforms the external process signals to the internal signal level of the PLC.

The signal states of the process signals are displayed by green LEDs. The 0V reference potential is separately connected to 8 channels at a time.

Technical Data

Number of inputs per module	32																											
Electrical isolation	in 4 groups of 8 inputs each, each group with separate reference potential ZP																											
Nominal insulation voltage, process terminals versus subrack, internal connections and other groups:	acc. VDE 0160 tested with																											
	60 V AC 500 V AC																											
Process supply voltages, rated values upper limits	24 V DC, 24 V AC 30 V DC, 30 V AC																											
Input signal level: signal 0 signal 1	- 5 V...+ 5 V, 0...3.5 V AC - 30 V...- 15 V, + 15 V...+ 30 V, 15 V AC...30 V AC																											
Input signal frequency, if AC	47 Hz...63 Hz																											
Input resistance	approx. 4.7 kΩ																											
Input current																												
if UP1 = 24 V DC	approx. 5 mA																											
if UP7 = 24 V AC	approx. 5 mA																											
Input signal delay																												
signal edge 0 → 1	min. 2.2 ms max. 16 ms																											
signal edge 1 → 0	min. 11 ms max. 16 ms																											
Supply current from internal voltages																												
UB1 = 5 V DC	max. 0.15 A																											
UB4 = 24 V DC	no current consumption																											
Power dissipation	max. 6.4 W																											
Cable length, if cables have been laid parallel in cable duct:																												
shielded	max. 1000 m																											
unshielded	max. 600 m																											
Conductor cross section of process terminals	max. 1.5 mm ²																											
Signalling of the input signals	one green LED per channel																											
Number of required slots	1 I/O slot																											
Number of occupied I/O points	32																											
Configuration identifier in 907 PC 32	E32																											
Ability of fitting in subracks																												
slots, ● = plug-in is possible	<table border="1" style="border-collapse: collapse; text-align: center; width: 100%;"> <tr> <th colspan="3">BT</th> <th colspan="3">BE-central</th> <th colspan="3">BE-remote</th> </tr> <tr> <td>NG</td><td>ZE</td><td>I/O</td> <td>NG</td><td>BV</td><td>I/O</td> <td>NG</td><td>BV</td><td>I/O</td> </tr> <tr> <td></td><td></td><td>●</td> <td></td><td></td><td>●</td> <td></td><td></td><td>●</td> </tr> </table>	BT			BE-central			BE-remote			NG	ZE	I/O	NG	BV	I/O	NG	BV	I/O			●			●			●
BT			BE-central			BE-remote																						
NG	ZE	I/O	NG	BV	I/O	NG	BV	I/O																				
		●			●			●																				
Weight	380 g																											
Order number	GJV3074341R1																											

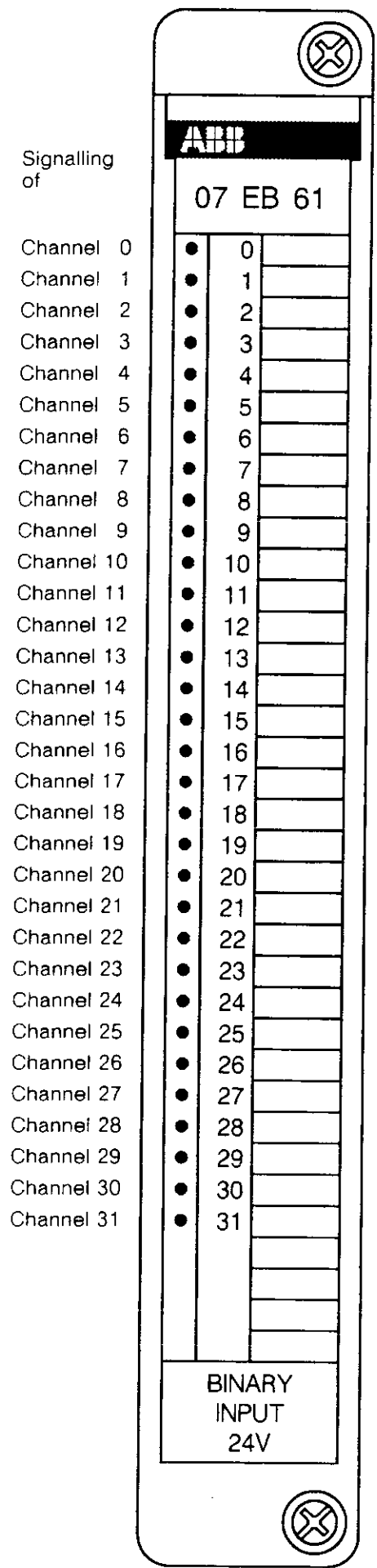

Signalling of

- Channel 0
- Channel 1
- Channel 2
- Channel 3
- Channel 4
- Channel 5
- Channel 6
- Channel 7
- Channel 8
- Channel 9
- Channel 10
- Channel 11
- Channel 12
- Channel 13
- Channel 14
- Channel 15
- Channel 16
- Channel 17
- Channel 18
- Channel 19
- Channel 20
- Channel 21
- Channel 22
- Channel 23
- Channel 24
- Channel 25
- Channel 26
- Channel 27
- Channel 28
- Channel 29
- Channel 30
- Channel 31

Signal Name Terminal

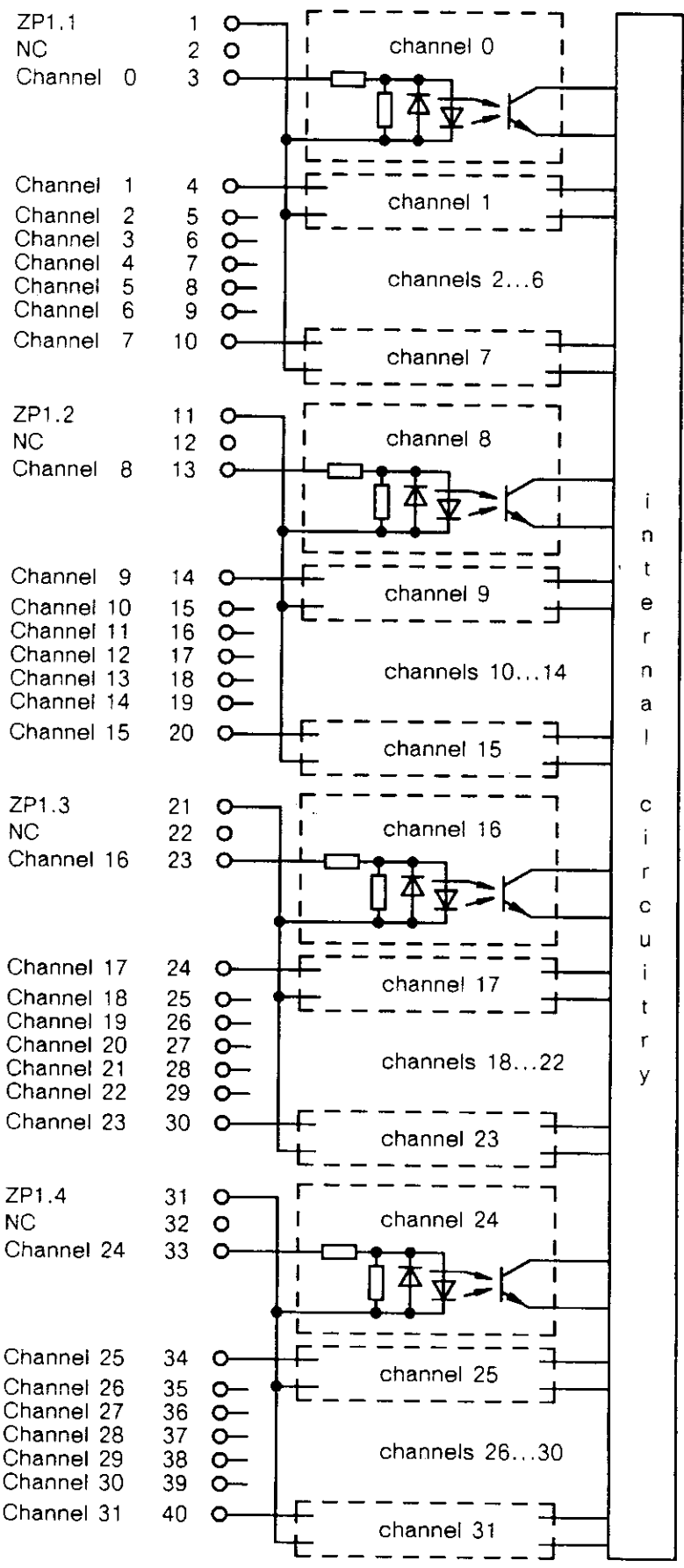

Fig. 7.2.1: 07 EB 61: Signalling, input circuitry, terminal assignment and signal names of channels

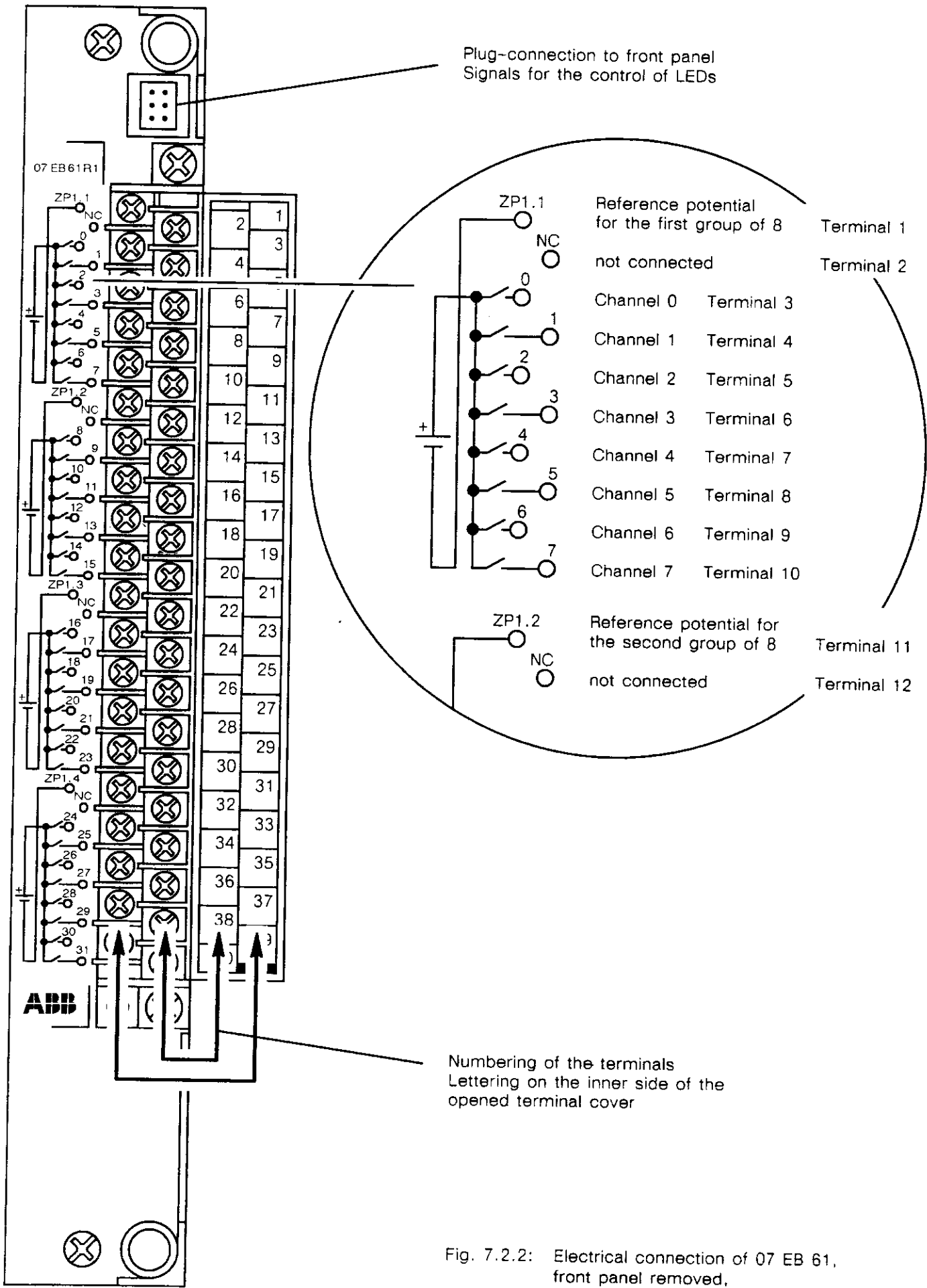

Fig. 7.2.2: Electrical connection of 07 EB 61, front panel removed, terminal cover opened

7.3 High-Speed Binary Input Module 07 EB 62 R1

24 V DC, 32 inputs, electrically isolated

Binary, isolated high-speed input module with 32 input channels for a rated voltage of 24 V DC. The device transforms the external process signals to the internal signal level of the PLC.

The signal states of the process signals are displayed by green LEDs. The 0V reference potential is separately connected to 8 channels at a time.

Technical Data

Number of inputs per module	32																											
Electrical isolation	in 4 groups of 8 inputs each, each group with separate reference potential ZP																											
Nominal insulation voltage, process terminals versus subrack, internal connections and other groups:	acc. VDE 0160 tested with																											
	60 V AC																											
	500 V AC																											
Process supply voltage, rated value	24 V DC																											
upper limit	30 V DC																											
Input signal level:	signal 0																											
	signal 1																											
	- 5 V...+ 5 V																											
	- 30 V...- 15 V, + 15 V...+ 30 V																											
Input resistance	approx. 4.7 k Ω																											
Input current																												
if UP1 = 24 V DC	approx. 5 mA																											
Input signal delay																												
signal edge 0 \rightarrow 1	min. 0.1 ms																											
	max. 1.0 ms																											
signal edge 1 \rightarrow 0	min. 0.4 ms																											
	max. 1.0 ms																											
Supply current from internal voltages																												
UB1 = 5 V DC	max. 0.15 A																											
UB4 = 24 V DC	no current consumption																											
Power dissipation	max. 6.4 W																											
Cable length, if cables have been laid parallel in cable duct:																												
shielded	max. 1000 m																											
unshielded	max. 600 m																											
Conductor cross section of process terminals	max. 1.5 mm ²																											
Signalling of the input signals	one green LED per channel																											
Number of required slots	1 I/O slot																											
Number of occupied I/O points	32																											
Configuration identifier in 907 PC 32	E32																											
Ability of fitting in subracks																												
slots, ● = plug-in is possible	<table border="1" style="display: inline-table; border-collapse: collapse; text-align: center;"> <thead> <tr> <th colspan="3">BT</th> <th colspan="3">BE-central</th> <th colspan="3">BE-remote</th> </tr> <tr> <th>NG</th> <th>ZE</th> <th>I/O</th> <th>NG</th> <th>BV</th> <th>I/O</th> <th>NG</th> <th>BV</th> <th>I/O</th> </tr> </thead> <tbody> <tr> <td></td> <td></td> <td>●</td> <td></td> <td></td> <td>●</td> <td></td> <td></td> <td>●</td> </tr> </tbody> </table>	BT			BE-central			BE-remote			NG	ZE	I/O	NG	BV	I/O	NG	BV	I/O			●			●			●
BT			BE-central			BE-remote																						
NG	ZE	I/O	NG	BV	I/O	NG	BV	I/O																				
		●			●			●																				
Weight	380 g																											
Order number	GJV3074342R1																											

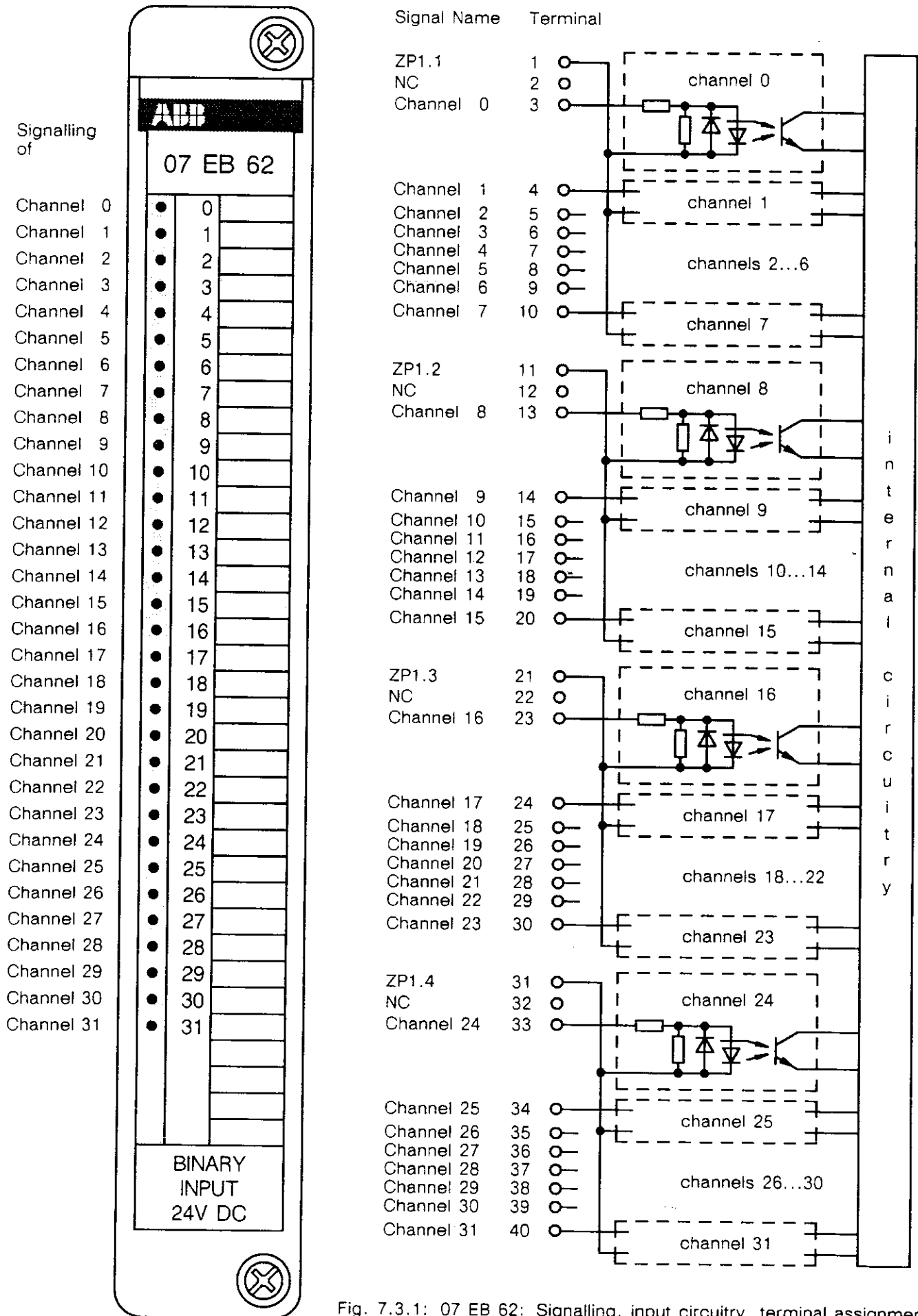

Fig. 7.3.1: 07 EB 62: Signalling, input circuitry, terminal assignment and signal names of channels

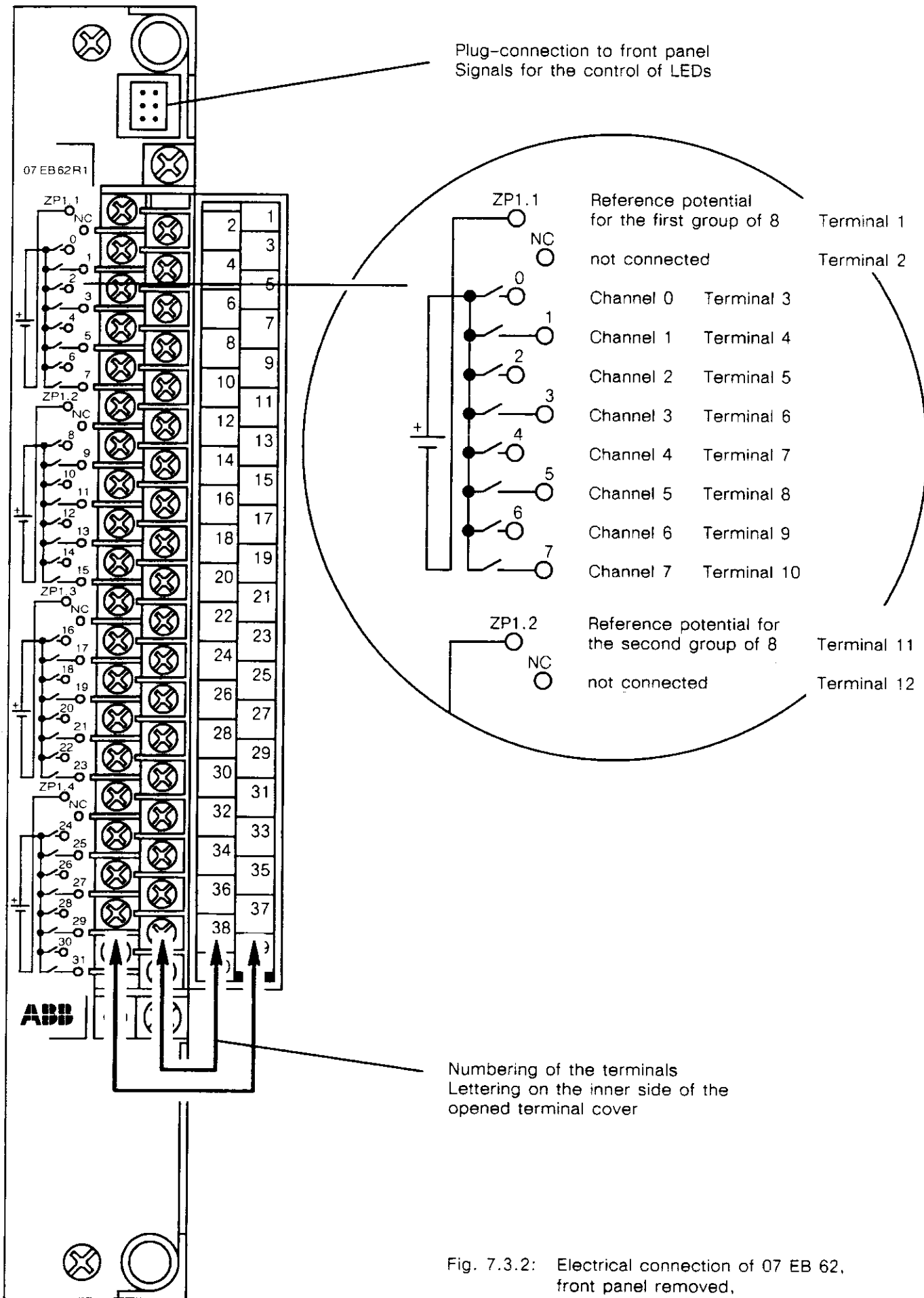

Fig. 7.3.2: Electrical connection of 07 EB 62, front panel removed, terminal cover opened

7.4 Binary Input Module 07 EB 63 R1

48 V DC, 48 V AC , 16 inputs, electrically isolated

Binary, isolated input module with 16 input channels for rated voltages of 48 V DC or 48 V AC. The device transforms the external process signals to the internal signal level of the PLC.

The signal states of the process signals are displayed by green LEDs. The 0V reference potential is separately connected to 8 channels at a time.

Technical Data

Number of inputs per module	16																											
Electrical isolation	in 2 groups of 8 inputs each, each group with separate reference potential ZP																											
Nominal insulation voltage, process terminals versus subrack, internal connections and other groups:	acc. VDE 0160 tested with																											
	60 V AC 500 V AC																											
Process supply voltages, rated values upper limits	48 V DC, 48 V AC 60 V DC, 60 V AC																											
input signal level: signal 0 signal 1	- 9 V...+ 9 V, 0...6.3 V AC - 60 V...- 28 V, + 28 V...+ 60 V, 28 V AC...60 V AC																											
Input signal frequency, if AC	47 Hz...63 Hz																											
Input resistance	approx. 8.2 kΩ																											
Input current																												
if UP1 = 48 V DC	approx. 6 mA																											
if UP8 = 48 V AC	approx. 6 mA																											
Input signal delay																												
signal edge 0 → 1	min. 1 ms max. 16 ms																											
signal edge 1 → 0	min. 11 ms max. 16 ms																											
Supply current from internal voltages																												
UB1 = 5 V DC	max. 0.12 A																											
UB4 = 24 V DC	no current consumption																											
Power dissipation	max. 7.4 W																											
Cable length, if cables have been laid parallel in cable duct:																												
shielded	max. 1000 m																											
unshielded	max. 600 m																											
Conductor cross section of process terminals	max. 1.5 mm ²																											
Signalling of the input signals	one green LED per channel																											
Number of required slots	1 I/O slot																											
Number of occupied I/O points	16																											
Configuration identifier in 907 PC 32	E16																											
Ability of fitting in subracks																												
slots, ● = plug-in is possible	<table border="1" style="border-collapse: collapse; text-align: center; width: 100%;"> <tr> <td colspan="3">BT</td> <td colspan="3">BE-central</td> <td colspan="3">BE-remote</td> </tr> <tr> <td>NG</td><td>ZE</td><td>I/O</td> <td>NG</td><td>BV</td><td>I/O</td> <td>NG</td><td>BV</td><td>I/O</td> </tr> <tr> <td></td><td></td><td>●</td> <td></td><td></td><td>●</td> <td></td><td></td><td>●</td> </tr> </table>	BT			BE-central			BE-remote			NG	ZE	I/O	NG	BV	I/O	NG	BV	I/O			●			●			●
BT			BE-central			BE-remote																						
NG	ZE	I/O	NG	BV	I/O	NG	BV	I/O																				
		●			●			●																				
Weight	360 g																											
Order number	GJV3074343R1																											

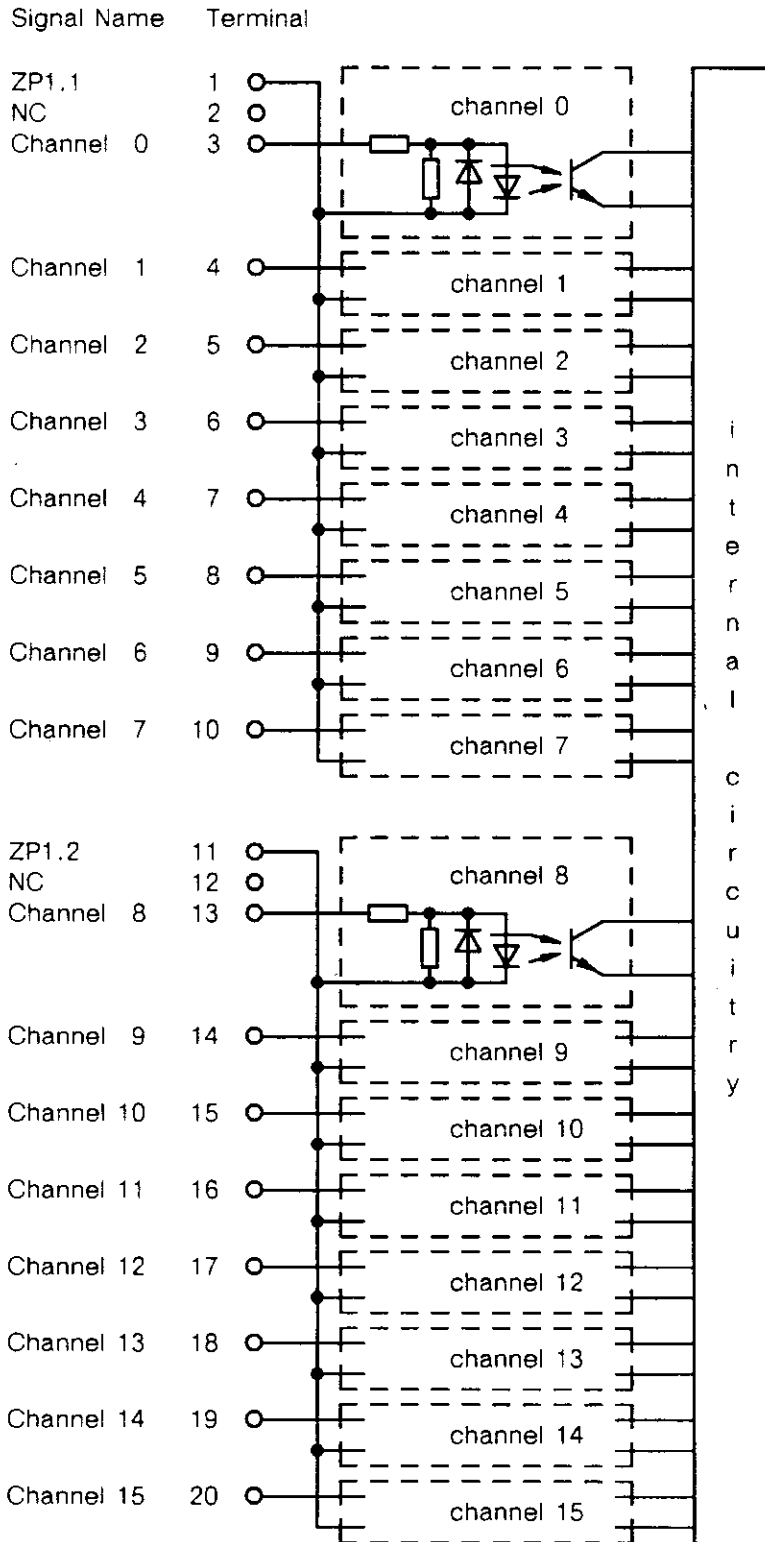
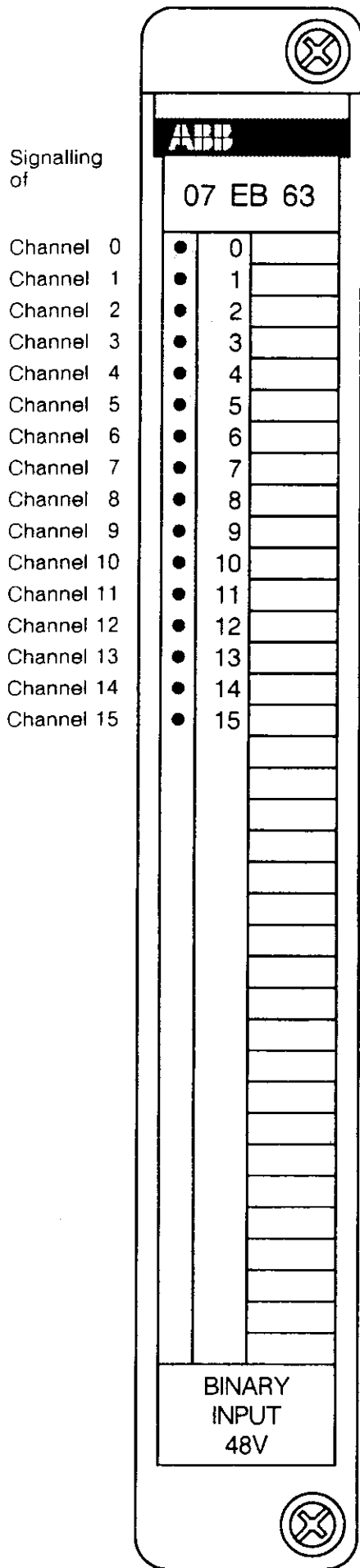

Fig. 7.4.1: 07 EB 63: Signalling, input circuitry, terminal assignment and signal names of channels

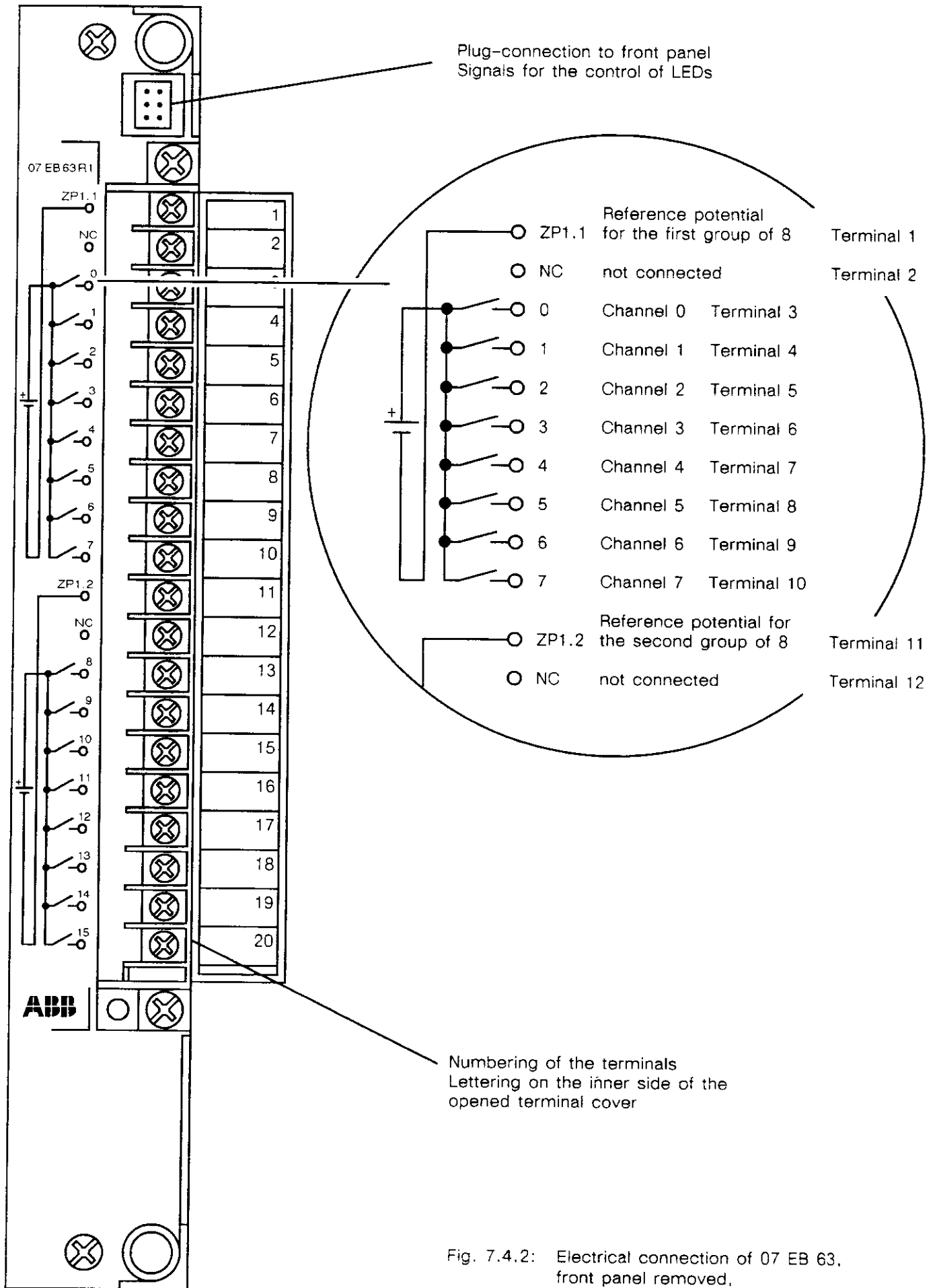

Fig. 7.4.2: Electrical connection of 07 EB 63, front panel removed, terminal cover opened

7.5 Binary Input Module 07 EB 64 R1

48 V DC, 48 V AC , 32 inputs, electrically isolated

Binary, isolated input module with 32 input channels for rated voltages of 48 V DC or 48 V AC. The device transforms the external process signals to the internal signal level of the PLC.

The signal states of the process signals are displayed by green LEDs. The 0V reference potential is separately connected to 8 channels at a time.

Technical Data

Number of inputs per module	32																											
Electrical isolation	in 4 groups of 8 inputs each, each group with separate reference potential ZP																											
Nominal insulation voltage, process terminals versus subrack, internal connections and other groups:	acc. VDE 0160 tested with																											
	60 V AC 500 V AC																											
Process supply voltages, rated values upper limits	48 V DC, 48 V AC 60 V DC, 60 V AC																											
Input signal level: signal 0 signal 1	- 10 V...+ 10 V, 0...7 V AC - 60 V...- 30 V, + 30 V...+ 60 V, 30 V AC...60 V AC																											
Input signal frequency, if AC	47 Hz...63 Hz																											
Input resistance	approx. 18 k Ω																											
Input current																												
if UP1 = 48 V DC	approx. 2.5 mA																											
if UP8 = 48 V AC	approx. 2.5 mA																											
Input signal delay																												
signal edge 0 \rightarrow 1	min. 1 ms max. 16 ms																											
signal edge 1 \rightarrow 0	min. 11 ms max. 16 ms																											
Supply current from internal voltages																												
UB1 = 5 V DC	max. 0.15 A																											
UB4 = 24 V DC	no current consumption																											
Power dissipation	max. 6.4 W																											
Cable length, if cables have been laid parallel in cable duct:																												
shielded	max. 1000 m																											
unshielded	max. 600 m																											
Conductor cross section of process terminals	max. 1.5 mm ²																											
Signalling of the input signals	one green LED per channel																											
Number of required slots	1 I/O slot																											
Number of occupied I/O points	32																											
Configuration identifier in 907 PC 32	E32																											
Ability of fitting in subracks																												
slots, ● = plug-in is possible	<table border="1" style="border-collapse: collapse; text-align: center; width: 100%;"> <thead> <tr> <th colspan="3">BT</th> <th colspan="3">BE-central</th> <th colspan="3">BE-remote</th> </tr> <tr> <th>NG</th> <th>ZE</th> <th>I/O</th> <th>NG</th> <th>BV</th> <th>I/O</th> <th>NG</th> <th>BV</th> <th>I/O</th> </tr> </thead> <tbody> <tr> <td></td> <td></td> <td>●</td> <td></td> <td></td> <td>●</td> <td></td> <td></td> <td>●</td> </tr> </tbody> </table>	BT			BE-central			BE-remote			NG	ZE	I/O	NG	BV	I/O	NG	BV	I/O			●			●			●
BT			BE-central			BE-remote																						
NG	ZE	I/O	NG	BV	I/O	NG	BV	I/O																				
		●			●			●																				
Weight	400 g																											
Order number	GJV3074344R1																											

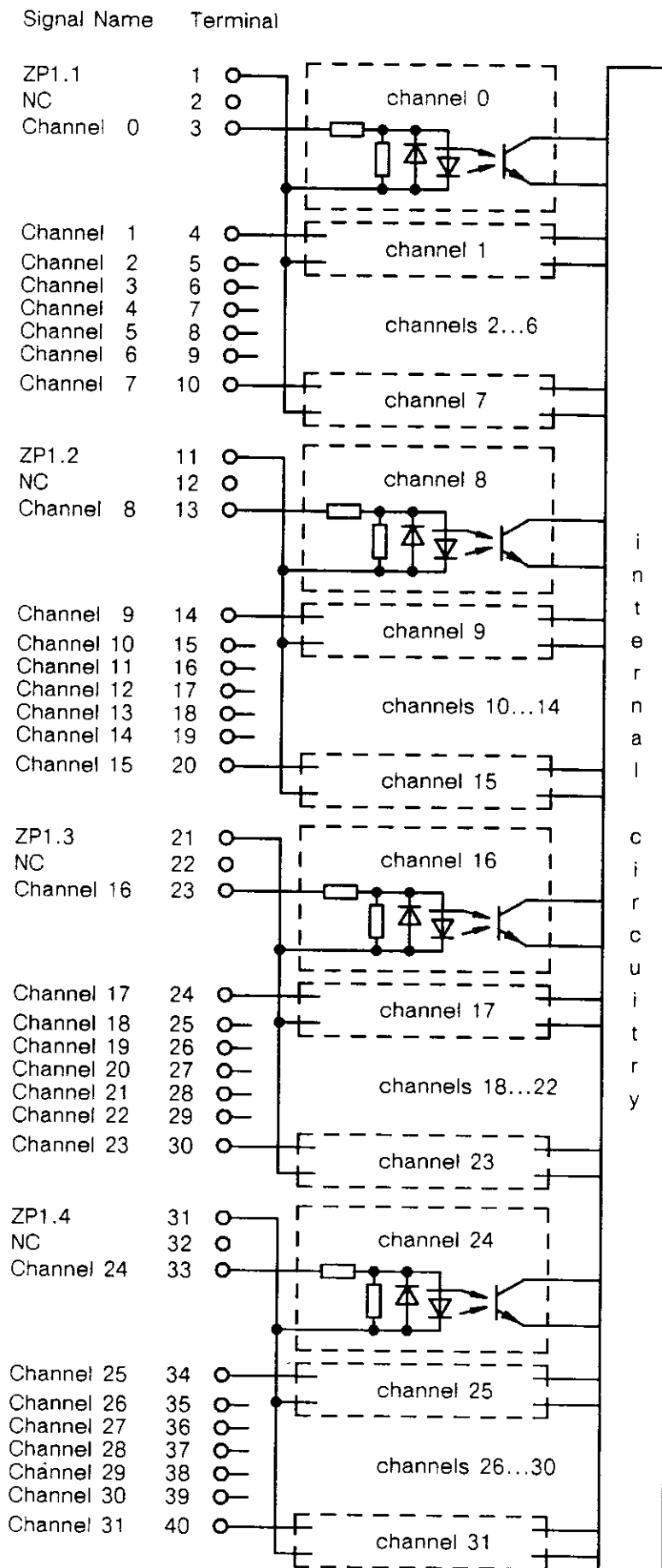
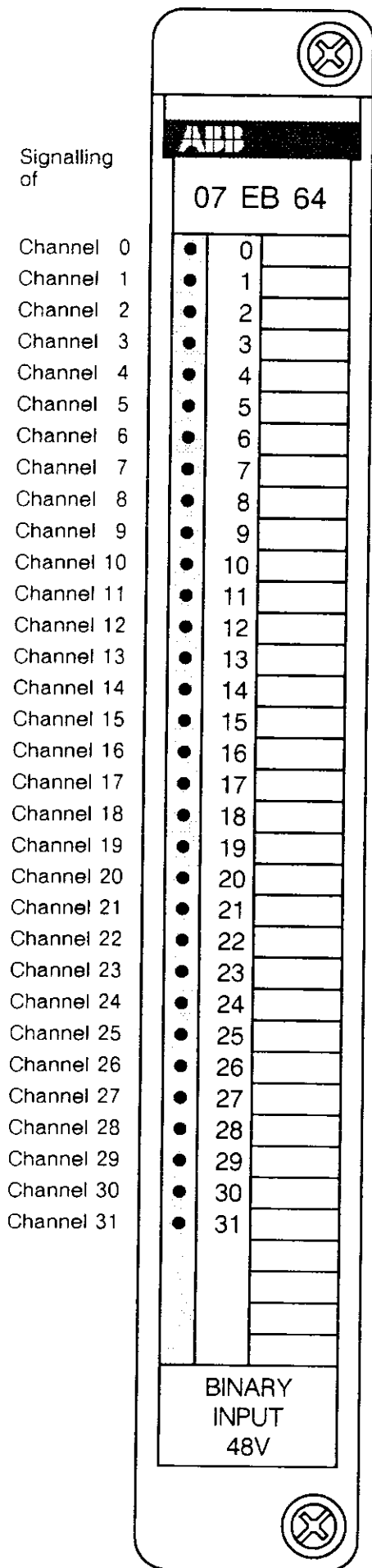

Fig. 7.5.1: 07 EB 64: Signalling, input circuitry, terminal assignment and signal names of channels

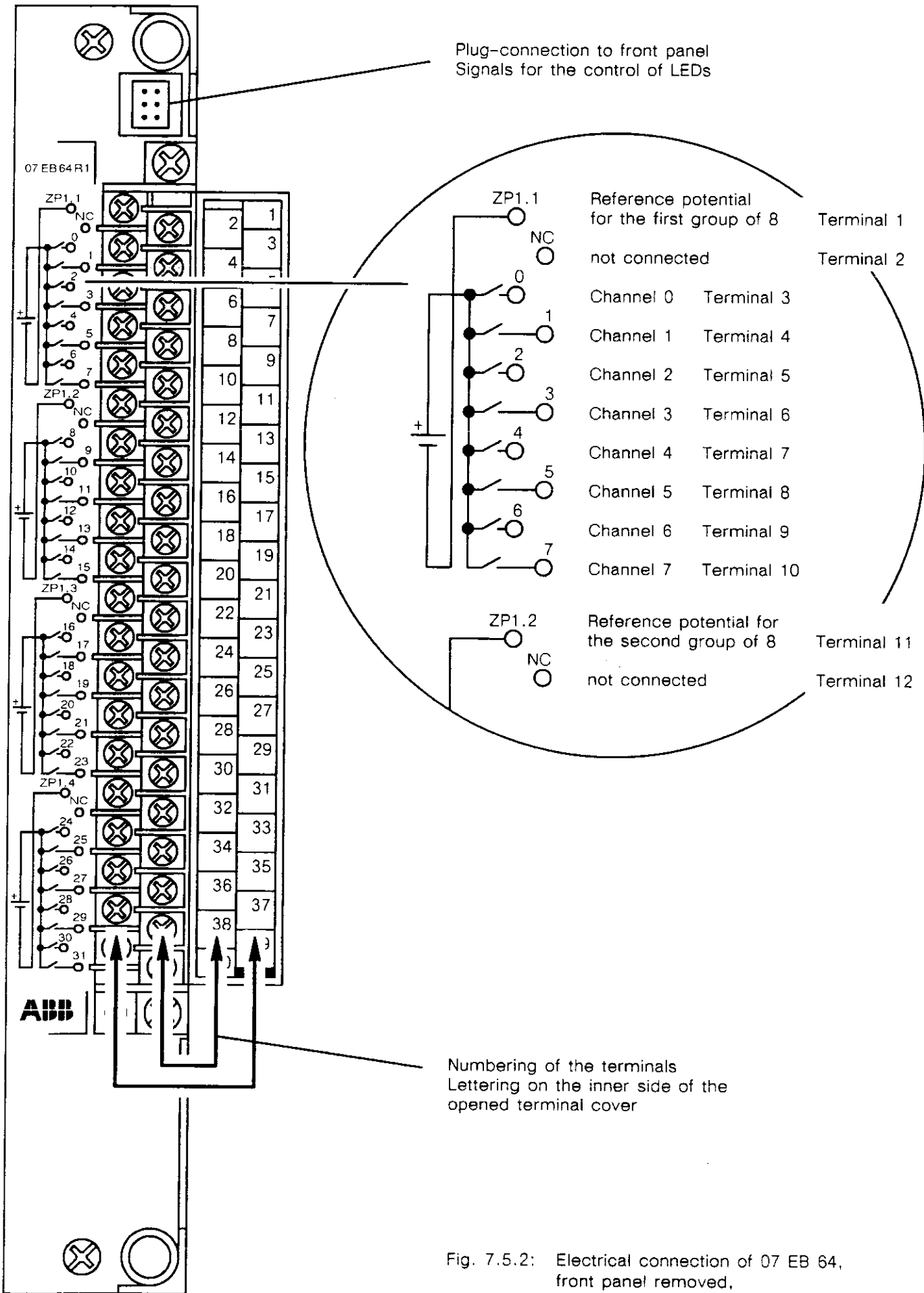

Fig. 7.5.2: Electrical connection of 07 EB 64, front panel removed, terminal cover opened

7.7 Binary Input Module 07 EB 66 R1

110 V AC , 16 inputs, electrically isolated

Binary, isolated input module with 16 input channels for a rated voltage of 110 V AC. The device transforms the external process signals to the internal signal level of the PLC.

The signal states of the process signals are displayed by green LEDs. The reference potential is separately connected to 8 channels at a time.

Technical Data

Number of inputs per module	16																											
Electrical isolation	in 2 groups of 8 inputs each, each group with separate reference potential ZP																											
Nominal insulation voltage, process terminals versus subrack, internal connections and other groups:	acc. VDE 0160 tested with																											
	250 V AC 1500 V AC																											
Process supply voltage, rated value upper limit	110 V AC 132 V AC																											
Input signal level:	signal 0 signal 1																											
	0...30 V AC 75 V AC...132 V AC																											
Input signal frequency	47 Hz...63 Hz																											
Input current																												
if UP5 = 110 V AC 50 Hz	approx. 6 mA																											
if UP5 = 110 V AC 60 Hz	approx. 7 mA																											
Input signal delay																												
signal edge 0 → 1	min. 2.5 ms max. 16.0 ms																											
signal edge 1 → 0	min. 13.5 ms max. 16.0 ms																											
Supply current from internal voltages																												
UB1 = 5 V DC	max. 0.12 A																											
UB4 = 24 V DC	no current consumption																											
Power dissipation	max. 1.6 W																											
Cable length, if cables have been laid parallel in cable duct:																												
shielded	max. 1000 m																											
unshielded	max. 300 m																											
Conductor cross section of process terminals	max. 1.5 mm ²																											
Signalling of the input signals	one green LED per channel																											
Number of required slots	1 I/O slot																											
Number of occupied I/O points	16																											
Configuration identifier in 907 PC 32	E16																											
Ability of fitting in subracks																												
slots, ● = plug-in is possible	<table border="1" style="border-collapse: collapse; text-align: center; width: 100%;"> <tr> <th colspan="3">BT</th> <th colspan="3">BE-central</th> <th colspan="3">BE-remote</th> </tr> <tr> <td>NG</td><td>ZE</td><td>I/O</td> <td>NG</td><td>BV</td><td>I/O</td> <td>NG</td><td>BV</td><td>I/O</td> </tr> <tr> <td></td><td></td><td>●</td> <td></td><td></td><td>●</td> <td></td><td></td><td>●</td> </tr> </table>	BT			BE-central			BE-remote			NG	ZE	I/O	NG	BV	I/O	NG	BV	I/O			●			●			●
BT			BE-central			BE-remote																						
NG	ZE	I/O	NG	BV	I/O	NG	BV	I/O																				
		●			●			●																				
Weight	380 g																											
Order number	GJV3074346R1																											

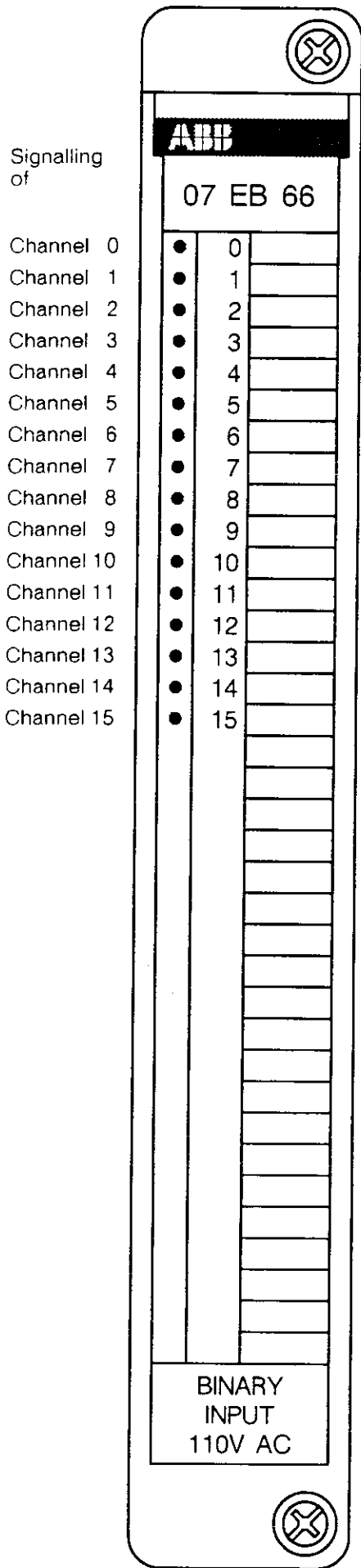

Signalling
of

- Channel 0
- Channel 1
- Channel 2
- Channel 3
- Channel 4
- Channel 5
- Channel 6
- Channel 7
- Channel 8
- Channel 9
- Channel 10
- Channel 11
- Channel 12
- Channel 13
- Channel 14
- Channel 15

Signal Name Terminal

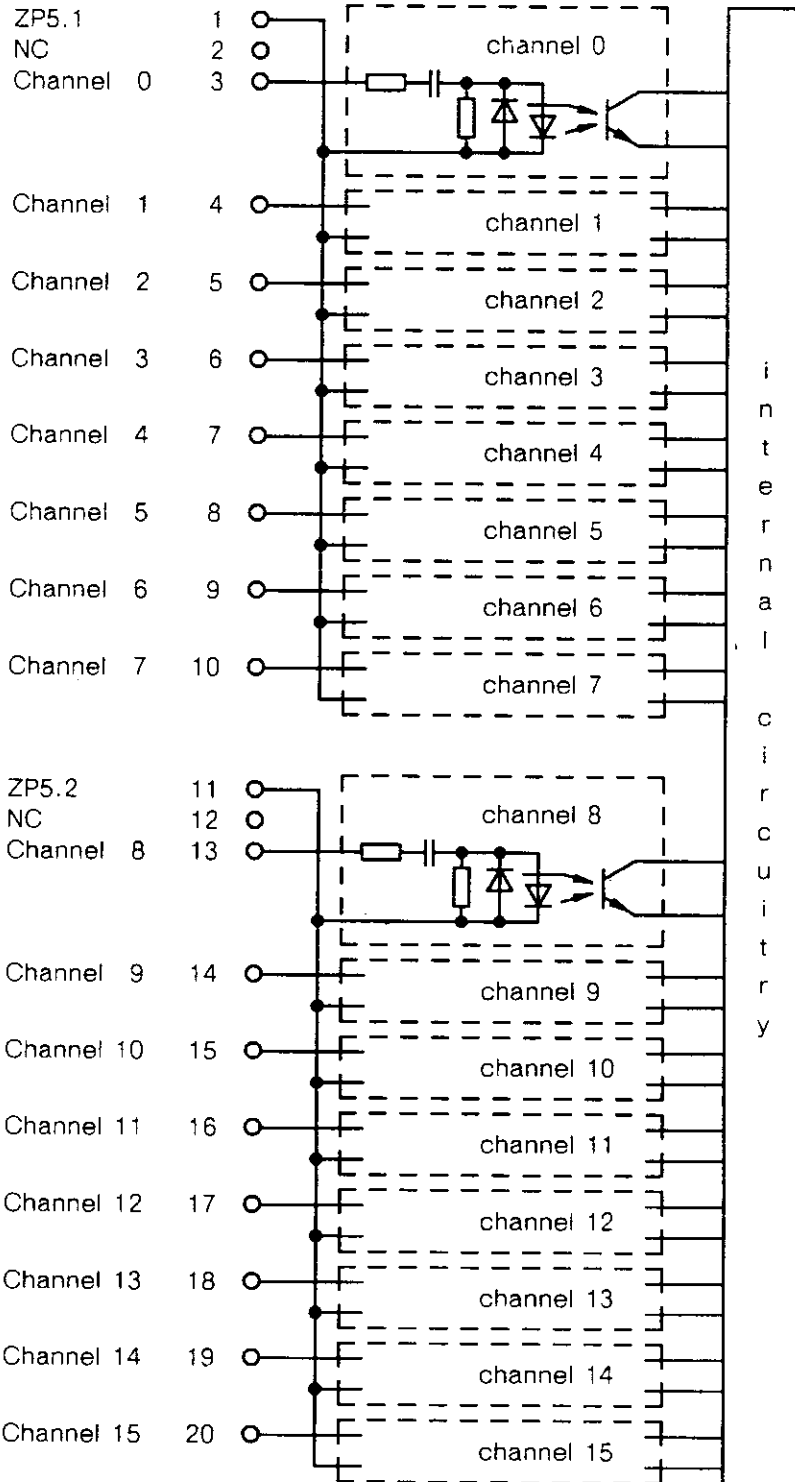

Fig. 7.7.1: 07 EB 66: Signalling, input circuitry, terminal assignment and signal names of channels

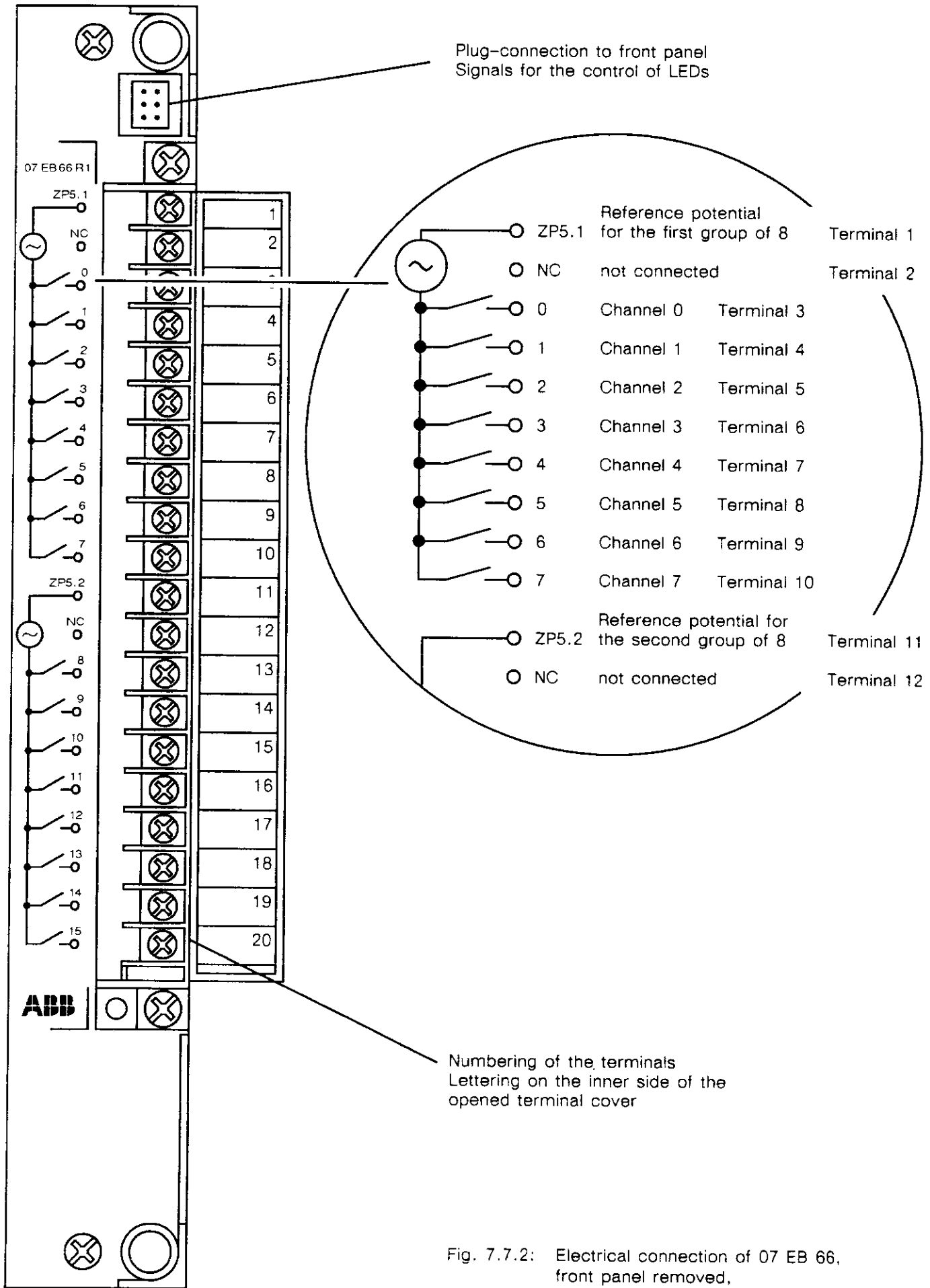

Fig. 7.7.2: Electrical connection of 07 EB 66, front panel removed, terminal cover opened

7.8 Binary Input Module 07 EB 67 R1

220 V AC , 16 inputs, electrically isolated

Binary, isolated input module with 16 input channels for a rated voltage of 220 V AC. The device transforms the external process signals to the internal signal level of the PLC.

The signal states of the process signals are displayed by green LEDs. The reference potential is separately connected to 8 channels at a time.

Technical Data

Number of inputs per module	16																											
Electrical isolation	in 2 groups of 8 inputs each, each group with separate reference potential ZP																											
Nominal insulation voltage, process terminals versus subrack, internal connections and other groups:	acc. VDE 0160 tested with																											
	250 V AC 1500 V AC																											
Process supply voltage, rated value	220 V AC																											
upper limit	264 V AC																											
Input signal level: signal 0	0...60 V AC																											
signal 1	150 V AC...264 V AC																											
Input signal frequency	47 Hz...63 Hz																											
Input current																												
if UP5 = 220 V AC 50 Hz	approx. 7 mA																											
if UP5 = 220 V AC 60 Hz	approx. 8 mA																											
Input signal delay																												
signal edge 0 → 1	min. 3.7 ms max. 16.0 ms																											
signal edge 1 → 0	min. 11.0 ms max. 16.0 ms																											
Supply current from internal voltages																												
UB1 = 5 V DC	max. 0.12 A																											
UB4 = 24 V DC	no current consumption																											
Power dissipation	max. 2.7 W																											
Cable length, if cables have been laid parallel in cable duct:																												
shielded	max. 1000 m																											
unshielded	max. 300 m																											
Conductor cross section of process terminals	max. 1.5 mm ²																											
Signalling of the input signals	one green LED per channel																											
Number of required slots	1 I/O slot																											
Number of occupied I/O points	16																											
Configuration identifier in 907 PC 32	E16																											
Ability of fitting in subracks																												
slots, ● = plug-in is possible	<table border="1" style="border-collapse: collapse; text-align: center;"> <tr> <td colspan="3">BT</td> <td colspan="3">BE-central</td> <td colspan="3">BE-remote</td> </tr> <tr> <td>NG</td><td>ZE</td><td>I/O</td> <td>NG</td><td>BV</td><td>I/O</td> <td>NG</td><td>BV</td><td>I/O</td> </tr> <tr> <td></td><td></td><td>●</td> <td></td><td></td><td>●</td> <td></td><td></td><td>●</td> </tr> </table>	BT			BE-central			BE-remote			NG	ZE	I/O	NG	BV	I/O	NG	BV	I/O			●			●			●
BT			BE-central			BE-remote																						
NG	ZE	I/O	NG	BV	I/O	NG	BV	I/O																				
		●			●			●																				
Weight	380 g																											
Order number	GJV3074347R1																											

Signalling of

- Channel 0
- Channel 1
- Channel 2
- Channel 3
- Channel 4
- Channel 5
- Channel 6
- Channel 7
- Channel 8
- Channel 9
- Channel 10
- Channel 11
- Channel 12
- Channel 13
- Channel 14
- Channel 15

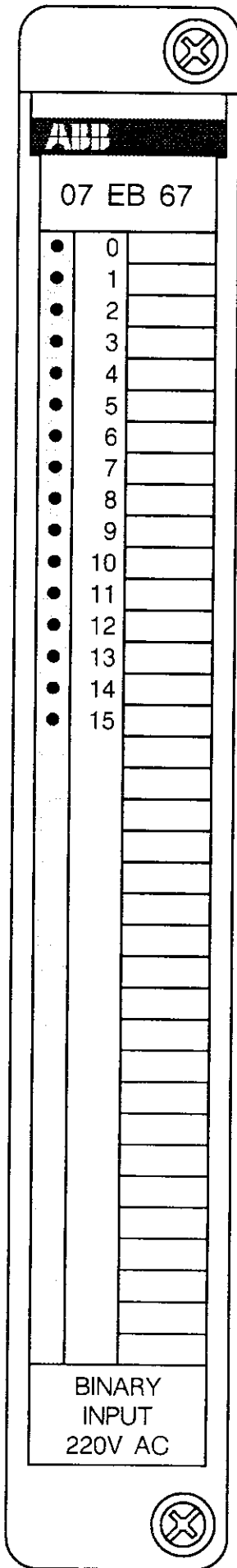

Signal Name Terminal

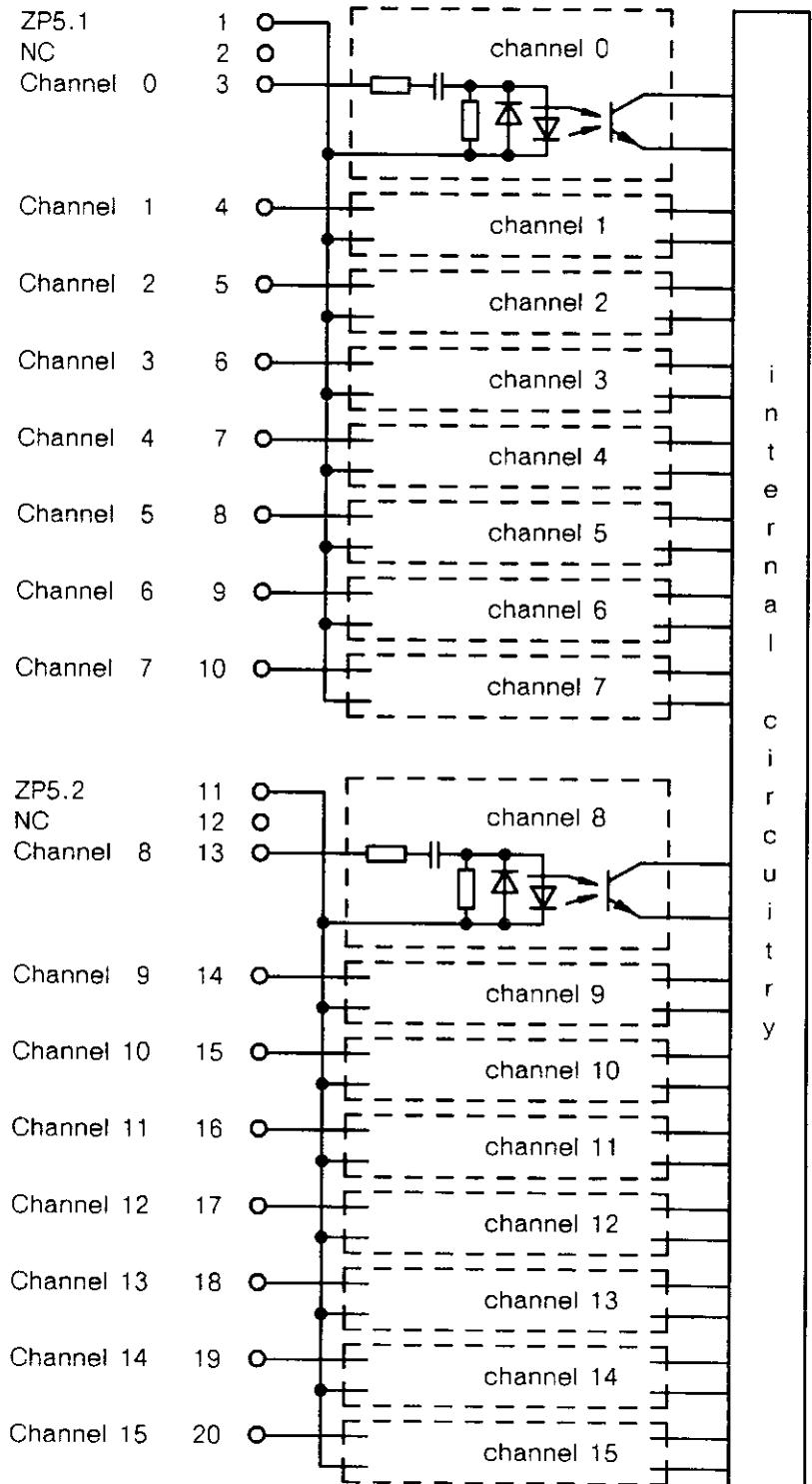

Fig. 7.8.1: 07 EB 67: Signalling, input circuitry, terminal assignment and signal names of channels

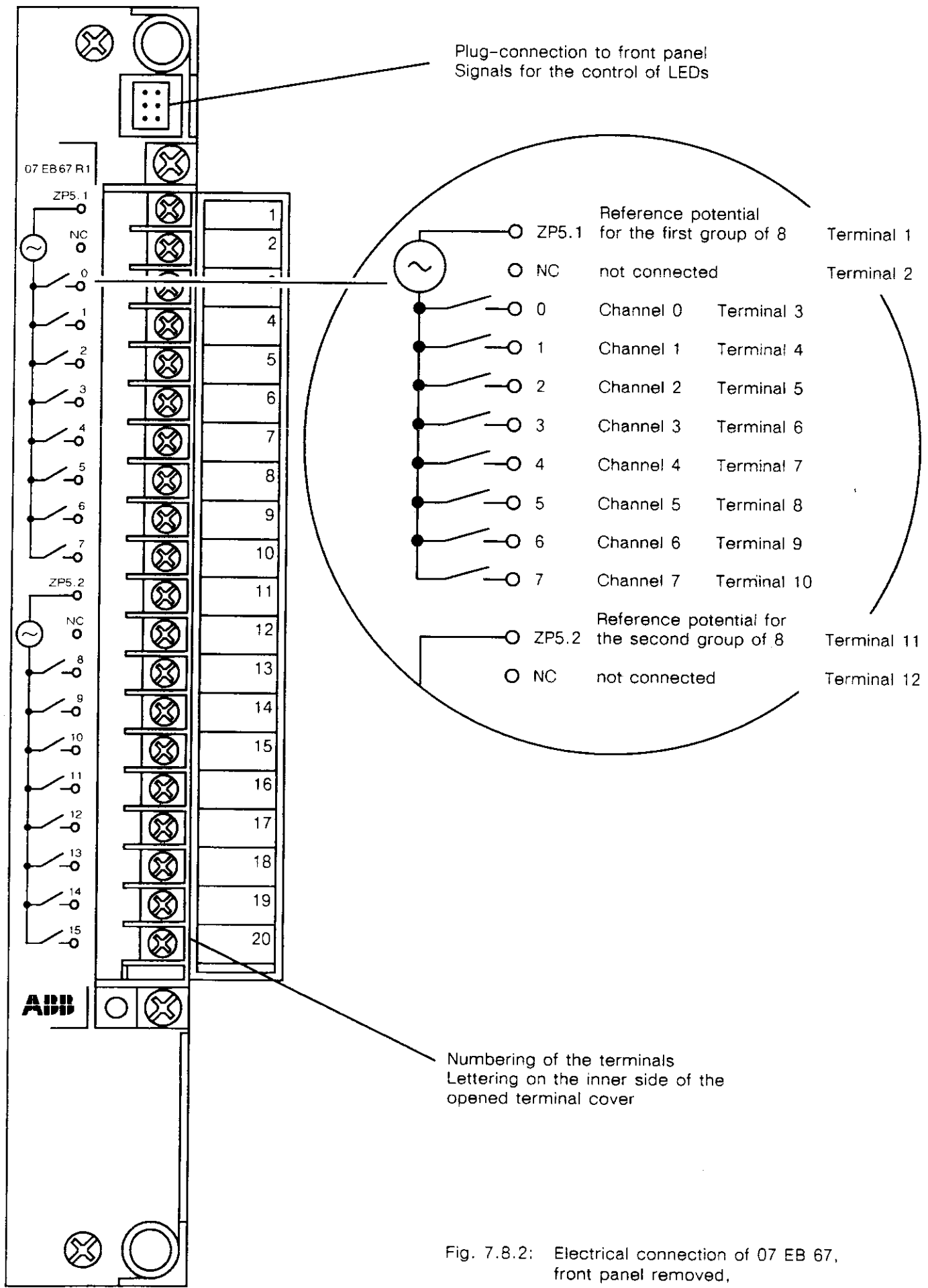

Fig. 7.8.2: Electrical connection of 07 EB 67, front panel removed, terminal cover opened

8 Analog Input Modules

07 EA 60 R1: Analog Input Module,	0 ... 10 V,	8 bits, 8 channels, electrically isolated
07 EA 61 R1: Analog Input Module,	4 ... 20 mA,	8 bits, 8 channels, electrically isolated
07 EA 62 R1: Analog Input Module,	-10 ... +10 V,	12 bits, 8 channels, electrically isolated
07 EA 63 R1: Analog Input Module,	4 ... 20 mA,	12 bits, 8 channels, electrically isolated
07 EA 64 R1: Analog Input Module,	0 ... 20 mA,	8 bits, 8 channels, electrically isolated
07 EA 65 R1: Analog Input Module,	0 ... 20 mA,	12 bits, 8 channels, electrically isolated
07 EA 66 R1: Analog Input Module,	Pt 100, - 50 °C...+ 400 °C,	13 bits, 8 channels, electrically isolated
07 EA 67 R1: Analog Input Module for thermocouples,	0 °C...+1600 °C,	13 bits, 8 channels, electrically isolated

8.1 Analog Input Module 07 EA 60 R1

0...10 V, 8 bits, 8 channels, electrically isolated

The analog input module 07 EA 60 converts input signal voltages of 0...10 V into internal binary codes, working with a resolution of 8 bits. At each of the 8 channels the analog process signals are connected with two wires.

All 0V terminals marked with (-) are connected together inside the module and form the common reference potential. The analog input circuitry is electrically isolated.

The function block ANAI (or ANAI1) within 907 PC 32 converts internal codes corresponding to the range of 0...10 V.

Care has to be taken for correct grounding and shielding of signal cables, sensors and reference potentials of inputs. Unused inputs should be short-circuited to improve the noise immunity.

Technical Data

Number of inputs per module	8																											
Electrical isolation	yes, common reference potential																											
Nominal insulation voltage, process terminals versus subrack and internal connections:																												
acc. VDE 0160	60 V AC																											
tested with	500 V AC																											
Input data																												
input voltage range	0...10 V																											
0...100 % corresponds to																												
hexadecimal representation (see Table 8.1.1)																												
after hardware conversion	0000...00FF, corresponding to 0...10 V																											
after conversion with ANAI or ANAI1	0000...0FF0, corresponding to 0...10 V																											
conversion, if input voltage out of range																												
input voltage > 10 V	00FF																											
input voltage < 0 V	0000																											
input resistance	100 kΩ																											
resolution (1 LSB)	39 mV																											
adjustment inaccuracy on delivery	max. ± 1 % of full scale																											
inaccuracy caused by resolution	max. ± 1/2 LSB																											
non-linearity	max. ± 1/2 LSB																											
temperature coefficient (full scale)	max. ± 1.75 mV/K																											
Max. permissible input voltage (destruction limit)	+15 V, -0.5 V																											
Conversion rate	5 ms																											
Supply current from internal voltages																												
UB1 = 5 V DC	max. 60 mA																											
UB4 = 24 V DC	max. 70 mA																											
Power dissipation	max. 1.98 W																											
Cable length, if cables have been laid parallel																												
in cable duct, shielded	max. 50 m																											
two-core shielded and cross section ≥ 0.5 mm ²	max. 200 m																											
Conductor cross section of process terminals	max. 1.5 mm ²																											
Signalling of the input signals	no signalling																											
Number of required slots	1 I/O slot																											
Number of occupied I/O points	128																											
Configuration identifier in 907 PC 32	EW8																											
Ability of fitting in subracks																												
slots, ● = plug-in is possible	<table border="1" style="border-collapse: collapse; text-align: center; width: 100%;"> <tr> <td colspan="3">BT</td> <td colspan="3">BE-central</td> <td colspan="3">BE-remote</td> </tr> <tr> <td>NG</td><td>ZE</td><td>I/O</td> <td>NG</td><td>BV</td><td>I/O</td> <td>NG</td><td>BV</td><td>I/O</td> </tr> <tr> <td></td><td></td><td>●</td> <td></td><td></td><td>●</td> <td></td><td></td><td>●</td> </tr> </table>	BT			BE-central			BE-remote			NG	ZE	I/O	NG	BV	I/O	NG	BV	I/O			●			●			●
BT			BE-central			BE-remote																						
NG	ZE	I/O	NG	BV	I/O	NG	BV	I/O																				
		●			●			●																				
Weight	470 g																											
Order number	GJV3074350R1																											

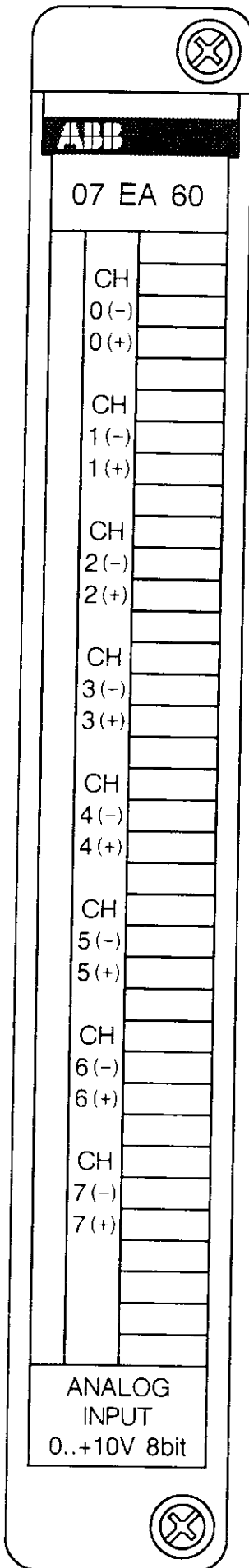

Channel Terminal

- NC 1 ○
- NC 2 ○
- NC 3 ○
- NC 4 ○

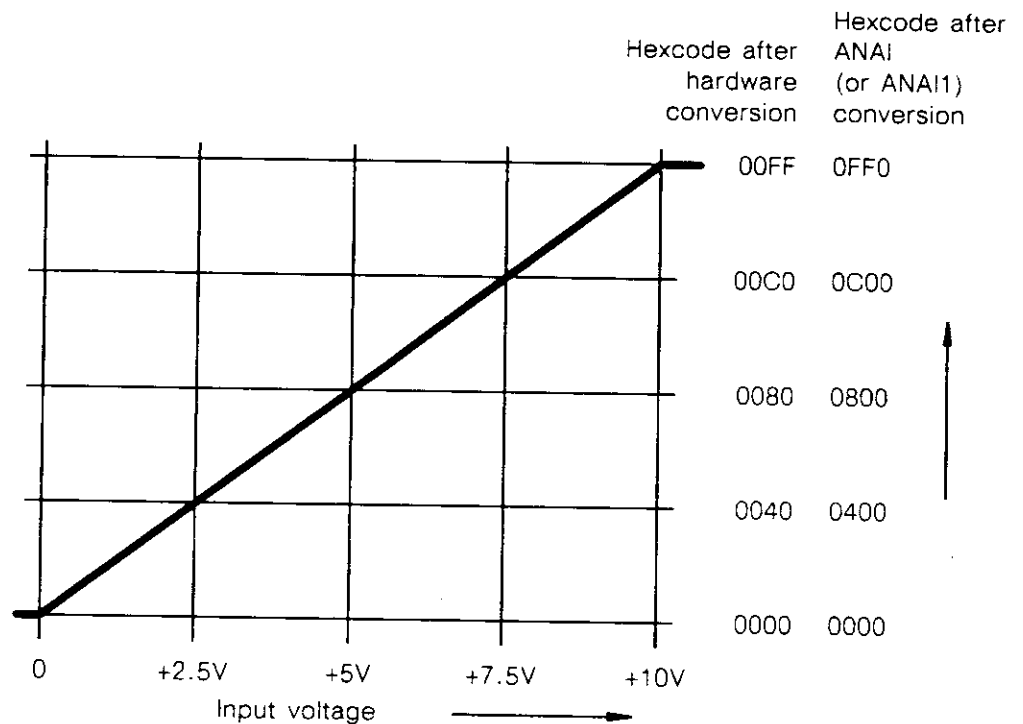
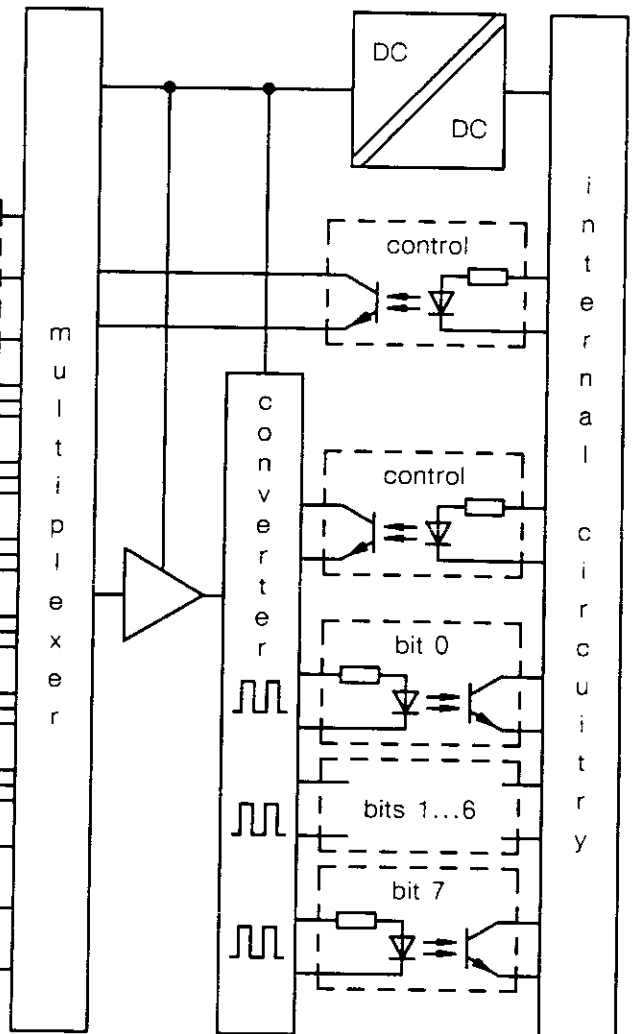
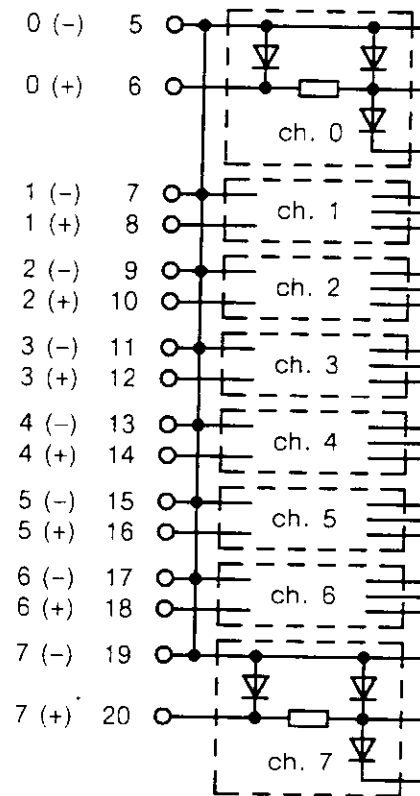

Fig. 8.1.1: 07 EA 60: Input circuitry, terminal assignment and conversion diagram of channels

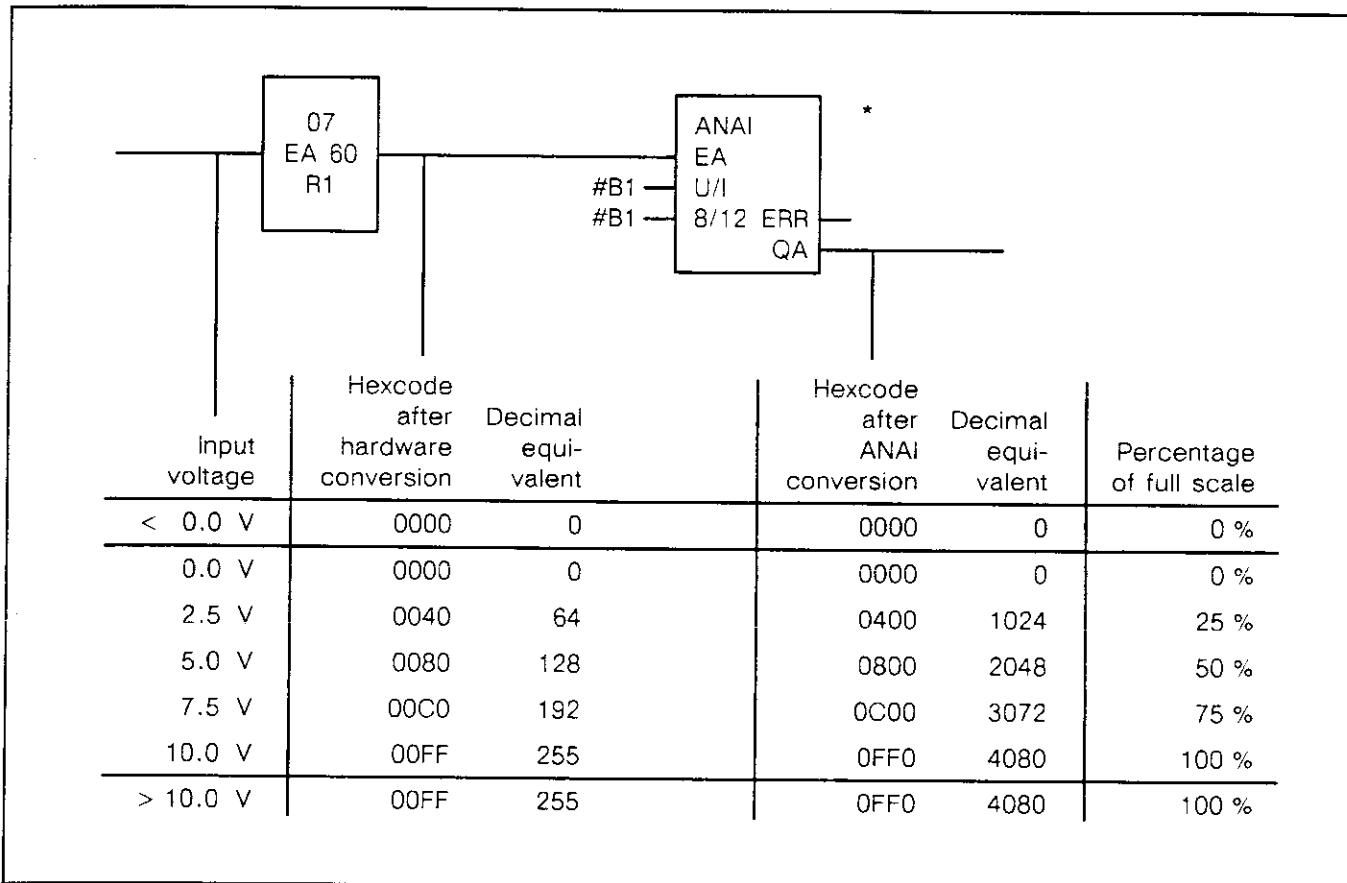
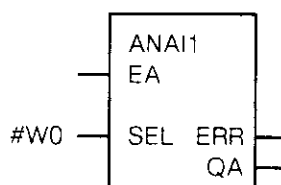

Table 8.1.1: Conversion table 07 EA 60 R1

* The ANAI1 function block with the appropriate SEL code according to the table on the right can be used instead of the ANAI function block.



SEL	Module
#W0	07 EA 60
#W1	07 EA 61
#W2	07 EA 62
#W3	07 EA 63
#W4	07 EA 64
#W5	07 EA 65

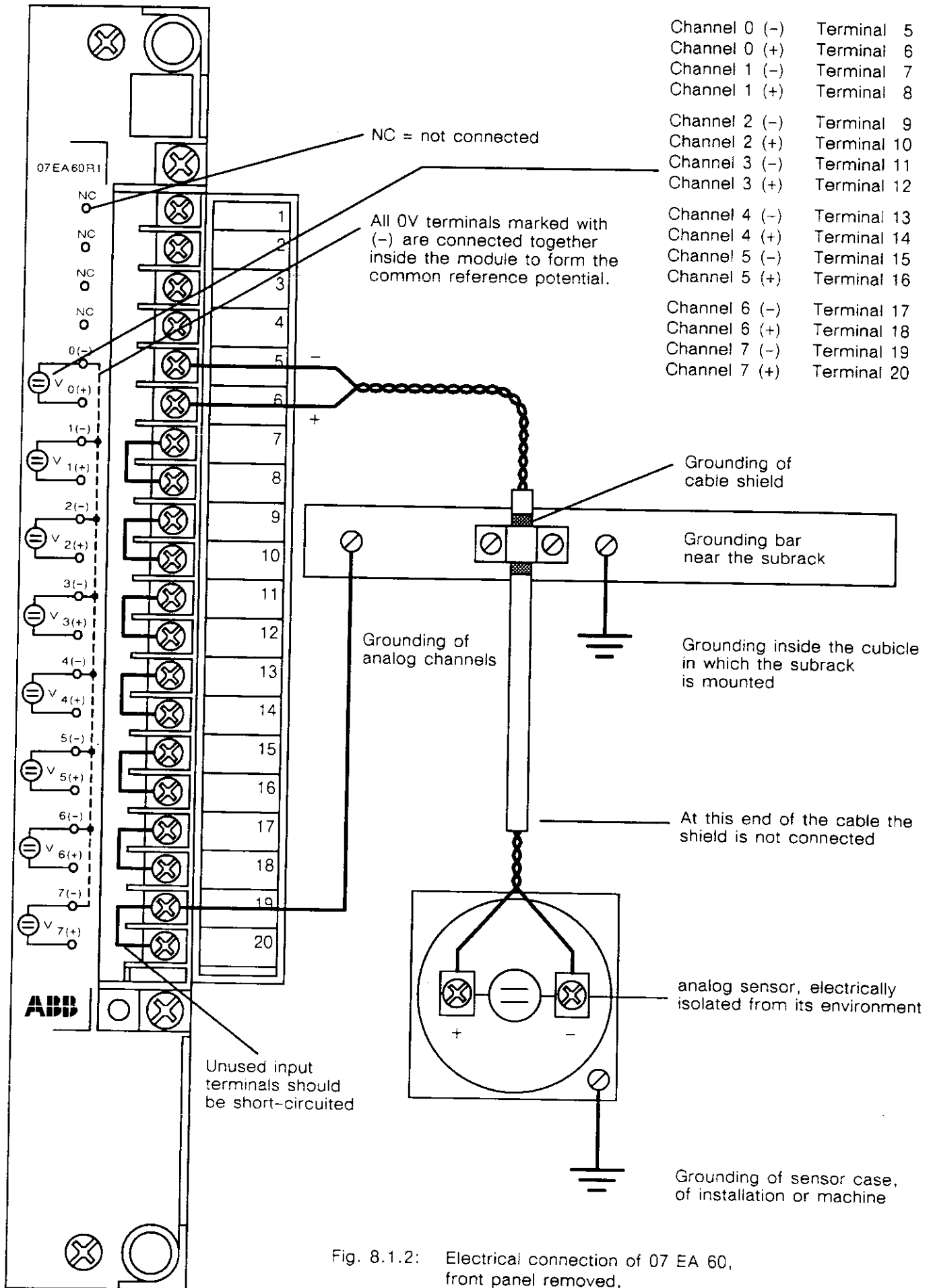

Fig. 8.1.2: Electrical connection of 07 EA 60, front panel removed, terminal cover opened

8.2 Analog Input Module 07 EA 61 R1

4...20 mA, 8 bits, 8 channels, electrically isolated, open-circuit monitoring

The analog input module 07 EA 61 converts input signal currents of 3.5...20 mA into internal binary codes, working with a resolution of 8 bits. At each of the 8 channels the analog process signals are connected with two wires.

The function block ANAI (or ANAI1) within 907 PC 32 evaluates open circuit and converts internal codes corresponding to the range of 4...20 mA.

All 0V terminals marked with (–) are connected together inside the module and form the common reference potential. The analog input circuitry is electrically isolated.

Care has to be taken for correct grounding and shielding of signal cables, sensors and reference potentials. Unused inputs should be short-circuited to improve the noise immunity.

Technical Data

Number of inputs per module	8																											
Electrical isolation	yes, common reference potential																											
Nominal insulation voltage, process terminals versus subrack and internal connections:																												
acc. VDE 0160	60 V AC																											
tested with	500 V AC																											
Input data																												
input current range	4...20 mA																											
0...100 % corresponds to open-circuit monitoring, if input current < 4 mA, threshold \approx 3.6 mA	yes, with function block ANAI or ANAI1 within 907 PC 32																											
hexadecimal representation (see table 8.2.1) after hardware conversion	0000...00FF, corresponding to 3.5...20 mA																											
after conversion with ANAI or ANAI1	0000...0FF0, corresponding to 4...20 mA																											
hardware conversion, if input current out of range																												
input current > 20 mA	00FF																											
input current < 3.5 mA	0000																											
input resistance	100 Ω																											
resolution (1 LSB)	64.8 μ A																											
adjustment inaccuracy on delivery	max. \pm 1 % of full scale																											
inaccuracy caused by resolution	max. \pm 1/2 LSB																											
non-linearity	max. \pm 1/2 LSB																											
temperature coefficient (full scale)	max. \pm 2.78 μ A/K																											
Max. permissible input current (destruction limit)	+40 mA, –5 mA																											
Conversion rate	5 ms																											
Supply current from internal voltages																												
UB1 = 5 V DC	max. 60 mA																											
UB4 = 24 V DC	max. 70 mA																											
Power dissipation	max. 1.98 W																											
Cable length, if cables have been laid parallel in cable duct, shielded	max. 50 m																											
two-core shielded and cross section \geq 0.5 mm ²	max. 200 m																											
Conductor cross section of process terminals	max. 1.5 mm ²																											
Signalling of the input signals	no signalling																											
Number of required slots	1 I/O slot																											
Number of occupied I/O points	128																											
Configuration identifier in 907 PC 32	EW8																											
Ability of fitting in subracks																												
slots, ● = plug-in is possible	<table border="1" style="display: inline-table; border-collapse: collapse; text-align: center;"> <tr> <td colspan="3">BT</td> <td colspan="3">BE-central</td> <td colspan="3">BE-remote</td> </tr> <tr> <td>NG</td><td>ZE</td><td>I/O</td> <td>NG</td><td>BV</td><td>I/O</td> <td>NG</td><td>BV</td><td>I/O</td> </tr> <tr> <td></td><td></td><td>●</td> <td></td><td></td><td>●</td> <td></td><td></td><td>●</td> </tr> </table>	BT			BE-central			BE-remote			NG	ZE	I/O	NG	BV	I/O	NG	BV	I/O			●			●			●
BT			BE-central			BE-remote																						
NG	ZE	I/O	NG	BV	I/O	NG	BV	I/O																				
		●			●			●																				
Weight	470 g																											
Order number	GJV3074351R1																											

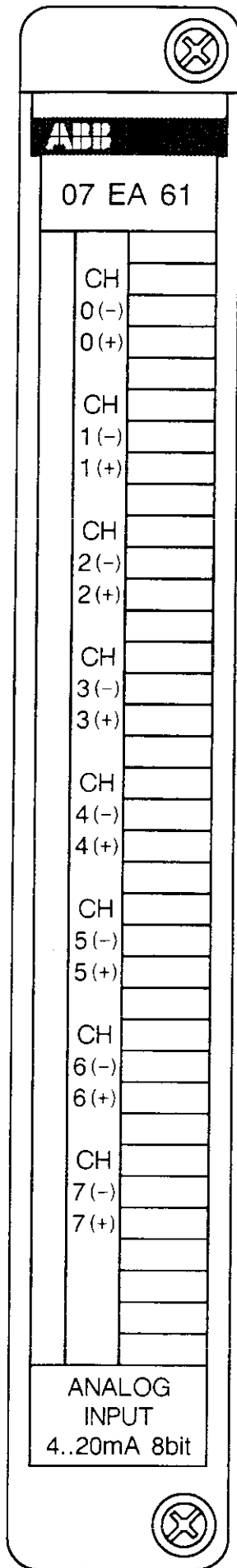

Channel Terminal

- NC 1 ○
- NC 2 ○
- NC 3 ○
- NC 4 ○

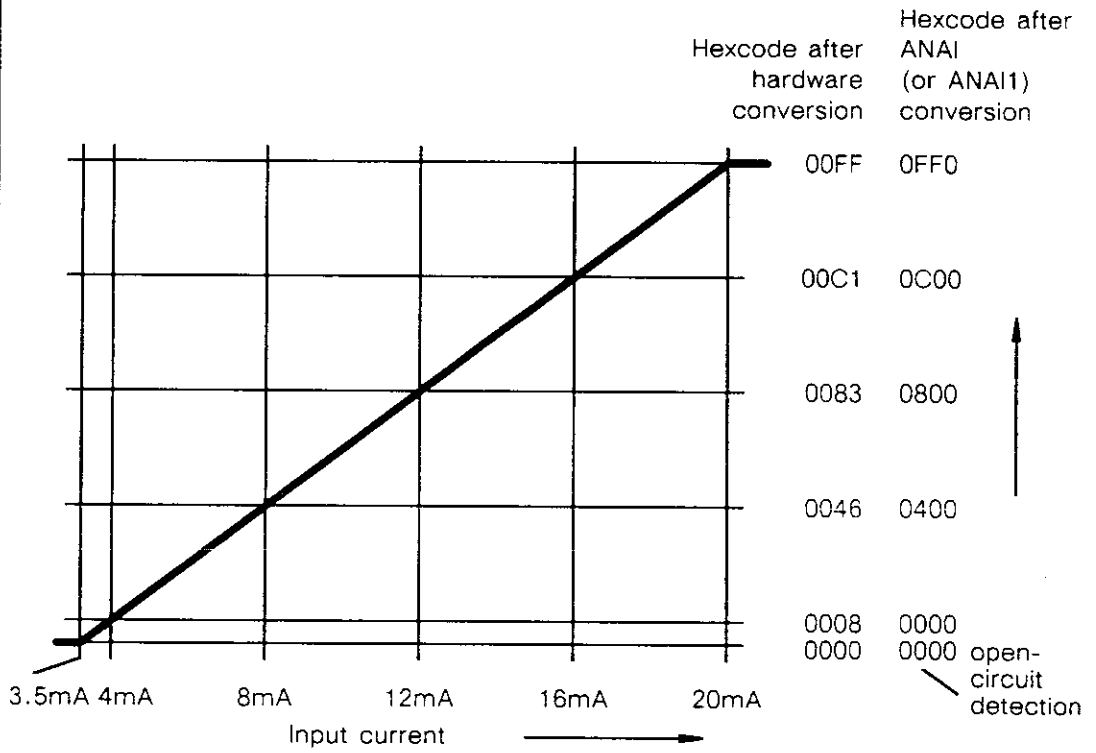
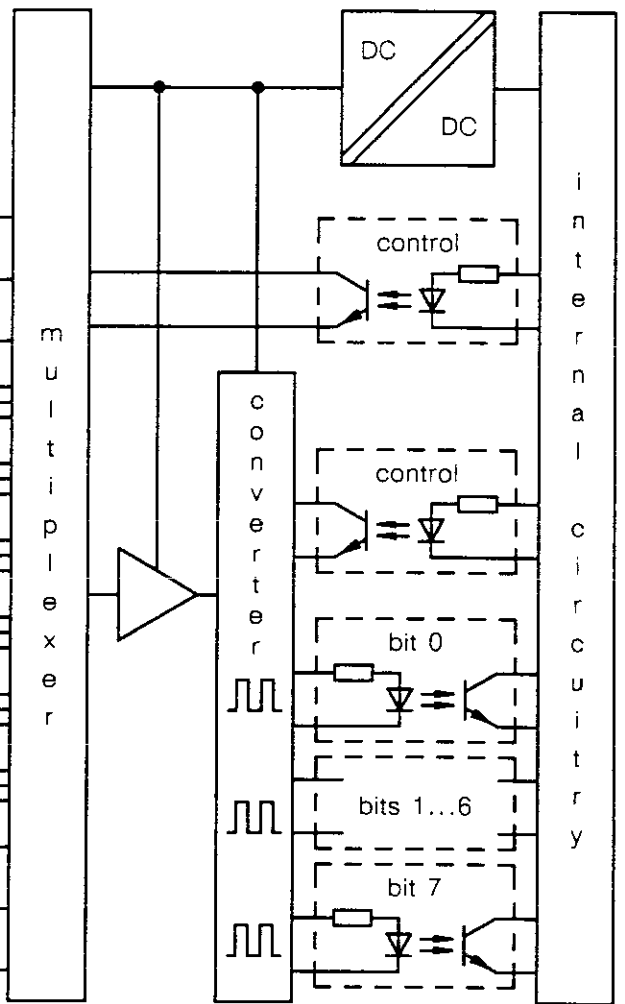
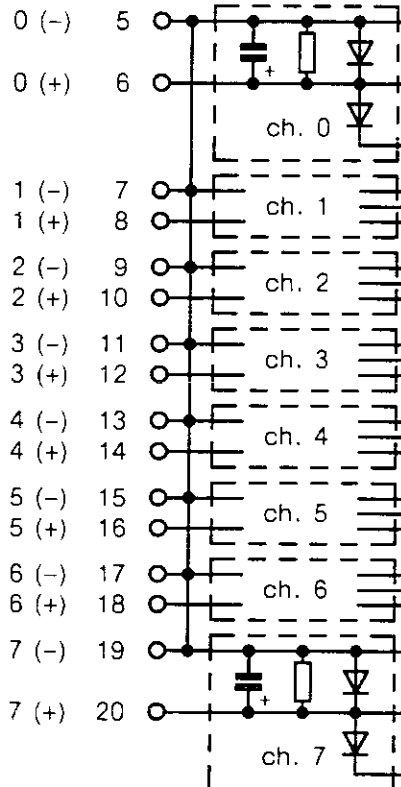

Fig. 8.2.1: 07 EA 61: Input circuitry, terminal assignment and conversion diagram of channels

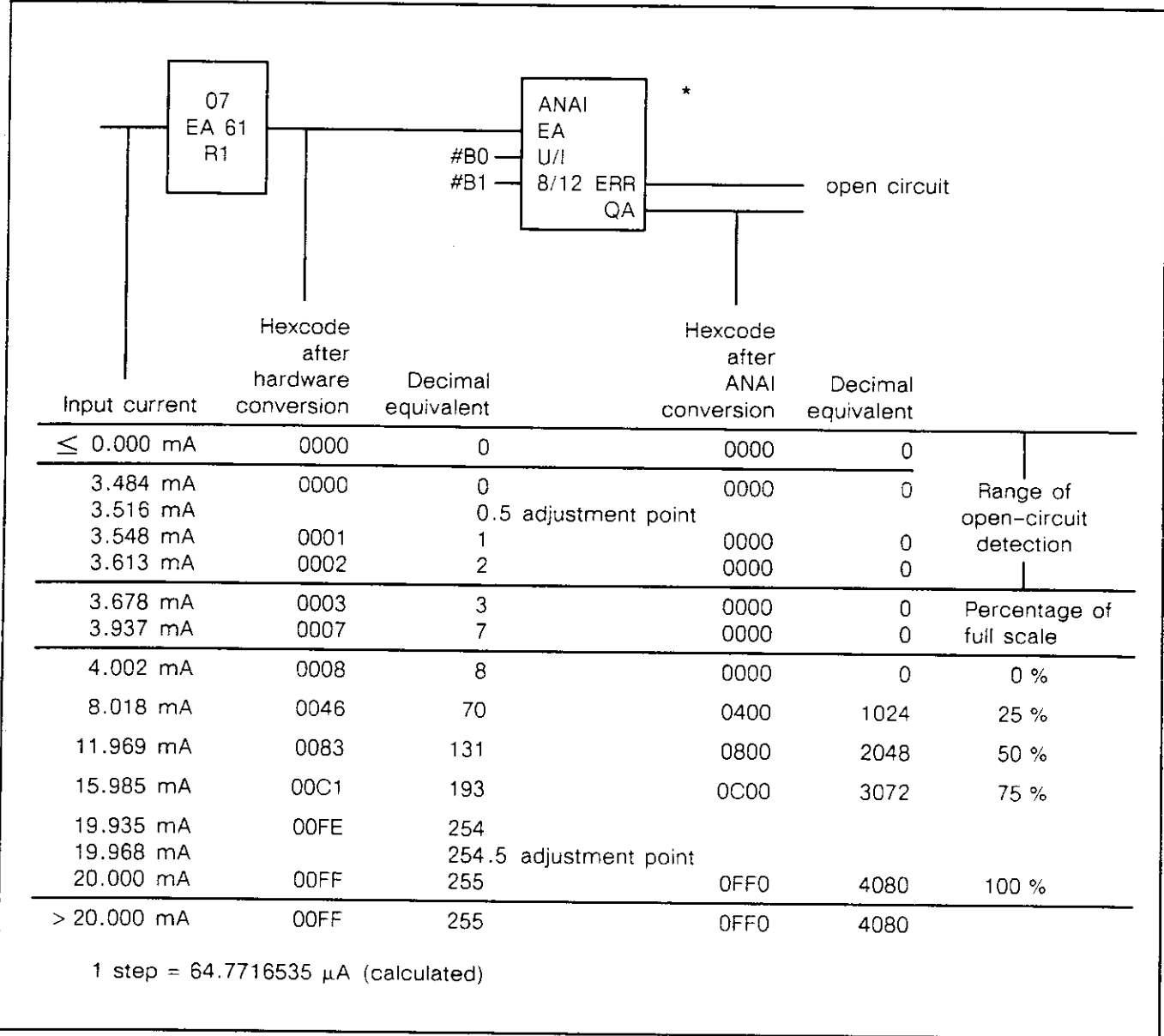
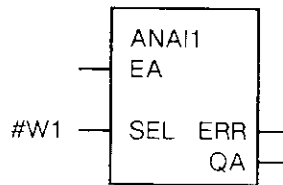

Table 8.2.1: Conversion table 07 EA 61 R1

* The ANAI1 function block with the appropriate SEL code according to the table on the right can be used instead of the ANAI function block.



SEL	Module
#W0	07 EA 60
#W1	07 EA 61
#W2	07 EA 62
#W3	07 EA 63
#W4	07 EA 64
#W5	07 EA 65

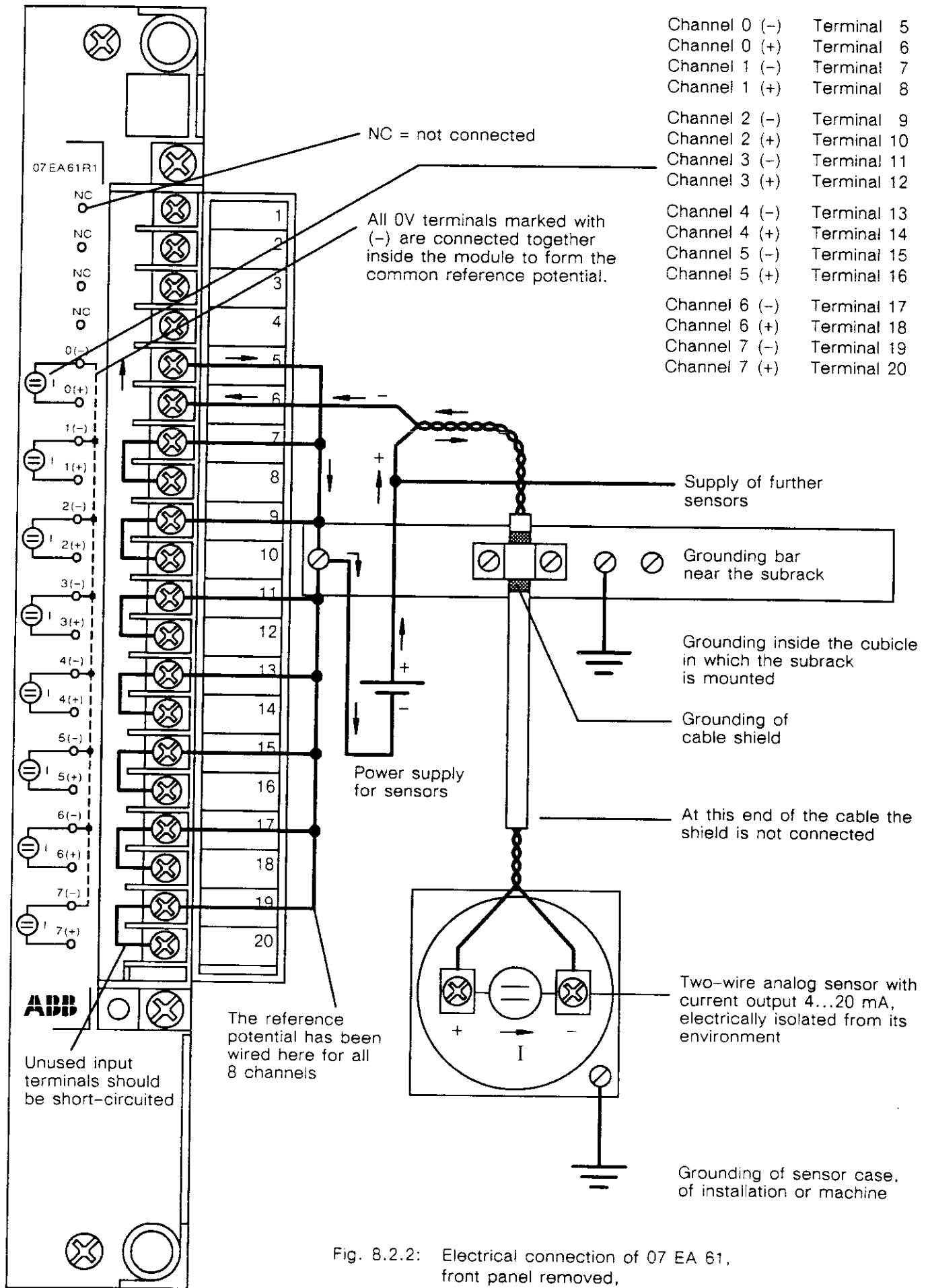

Fig. 8.2.2: Electrical connection of 07 EA 61, front panel removed, terminal cover opened

8.3 Analog Input Module 07 EA 62 R1

– 10...+ 10 V, 12 bits, 8 channels, electrically isolated

The analog input module 07 EA 62 converts input signal voltages of –10...+10 V into internal binary codes, working with a resolution of 12 bits. At each of the 8 channels the analog process signals are connected with two wires. The input signals are not indicated.

The function block ANAI (or ANAI1) within 907 PC 32 converts internal codes corresponding to the range of –10...+10 V.

All 0V terminals marked with (–) are connected together inside the module and form the common reference potential. Terminals marked with (+) represent the analog inputs (–10 V...+10 V). The analog input circuitry is electrically isolated.

Care has to be taken for correct grounding and shielding of signal cables, sensors and reference potentials of inputs. Unused inputs should be short-circuited to improve the noise immunity.

Technical Data

Number of inputs per module	8																											
Electrical isolation	yes, common reference potential																											
Nominal insulation voltage, process terminals versus subrack and internal connections:																												
acc. VDE 0160	60 V AC																											
tested with	500 V AC																											
Input data																												
input voltage range																												
–100...+100 % corresponds to	–10...+10 V																											
hexadecimal representation (see Table 8.3.1)																												
after hardware conversion, positive range	0000...07FF, corresponding to 0...+10 V																											
negative range	0FFF...0800, corresponding to 0...–10 V																											
after conversion																												
with ANAI or ANAI1																												
positive range	0000...0FFE, corresponding to 0...+10 V																											
negative range	FFFE...F000, corresponding to 0...–10 V																											
conversion, if input voltage out of range																												
input voltage > + 10 V	07FF																											
input voltage < – 10 V	0800																											
input resistance	100 kΩ																											
resolution (1 LSB)	4.9 mV																											
adjustment inaccuracy on delivery	max. ± 1 % of full scale																											
inaccuracy caused by resolution	max. ± 1/2 LSB																											
non-linearity	max. ± 1/2 LSB																											
temperature coefficient (full scale)	max. ± 0.43 mV/K																											
Max. permissible input voltage (destruction limit)	+15 V, –15 V																											
Conversion rate	5 ms																											
Supply current from internal voltages																												
UB1 = 5 V DC	max. 60 mA																											
UB4 = 24 V DC	max. 170 mA																											
Power dissipation	max. 4.38 W																											
Cable length, if cables have been laid parallel																												
in cable duct, shielded	max. 20 m																											
two-core shielded and cross section ≥ 0.5 mm ²	max. 100 m																											
Conductor cross section of process terminals	max. 1.5 mm ²																											
Number of required slots	1 I/O slot																											
Number of occupied I/O points	128																											
Configuration identifier in 907 PC 32	EW8																											
Ability of fitting in subracks																												
slots, ● = plug-in is possible	<table border="1" style="display: inline-table; border-collapse: collapse; text-align: center;"> <tr> <td colspan="3">BT</td> <td colspan="3">BE–central</td> <td colspan="3">BE–remote</td> </tr> <tr> <td>NG</td><td>ZE</td><td>I/O</td> <td>NG</td><td>BV</td><td>I/O</td> <td>NG</td><td>BV</td><td>I/O</td> </tr> <tr> <td></td><td></td><td>●</td> <td></td><td></td><td>●</td> <td></td><td></td><td>●</td> </tr> </table>	BT			BE–central			BE–remote			NG	ZE	I/O	NG	BV	I/O	NG	BV	I/O			●			●			●
BT			BE–central			BE–remote																						
NG	ZE	I/O	NG	BV	I/O	NG	BV	I/O																				
		●			●			●																				
Weight	490 g																											
Order number	GJV3074352R1																											

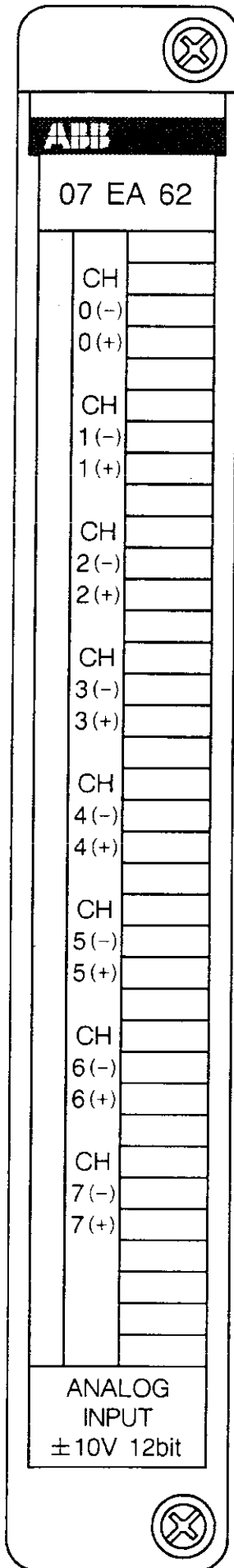

Channel Terminal

- NC 1 ○
- NC 2 ○
- NC 3 ○
- NC 4 ○

- 0 (-) 5 ○
- 0 (+) 6 ○
- 1 (-) 7 ○
- 1 (+) 8 ○
- 2 (-) 9 ○
- 2 (+) 10 ○
- 3 (-) 11 ○
- 3 (+) 12 ○
- 4 (-) 13 ○
- 4 (+) 14 ○
- 5 (-) 15 ○
- 5 (+) 16 ○
- 6 (-) 17 ○
- 6 (+) 18 ○
- 7 (-) 19 ○
- 7 (+) 20 ○

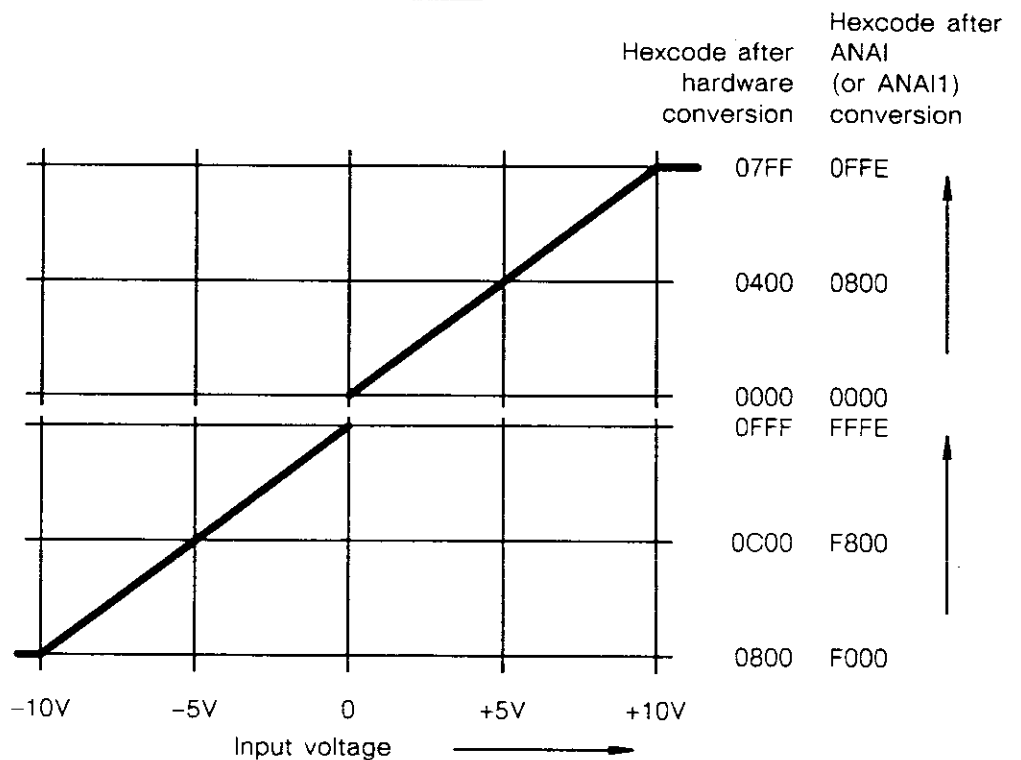
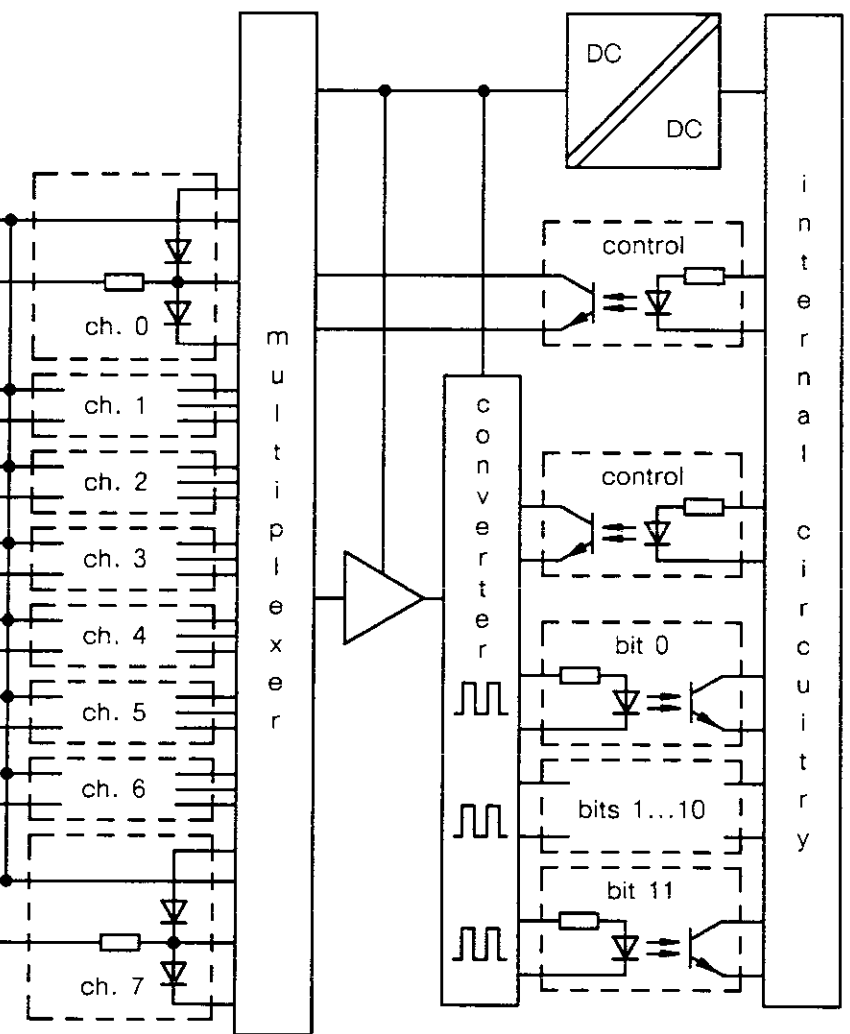

Fig. 8.3.1: 07 EA 62: Input circuitry, terminal assignment and conversion diagram of channels

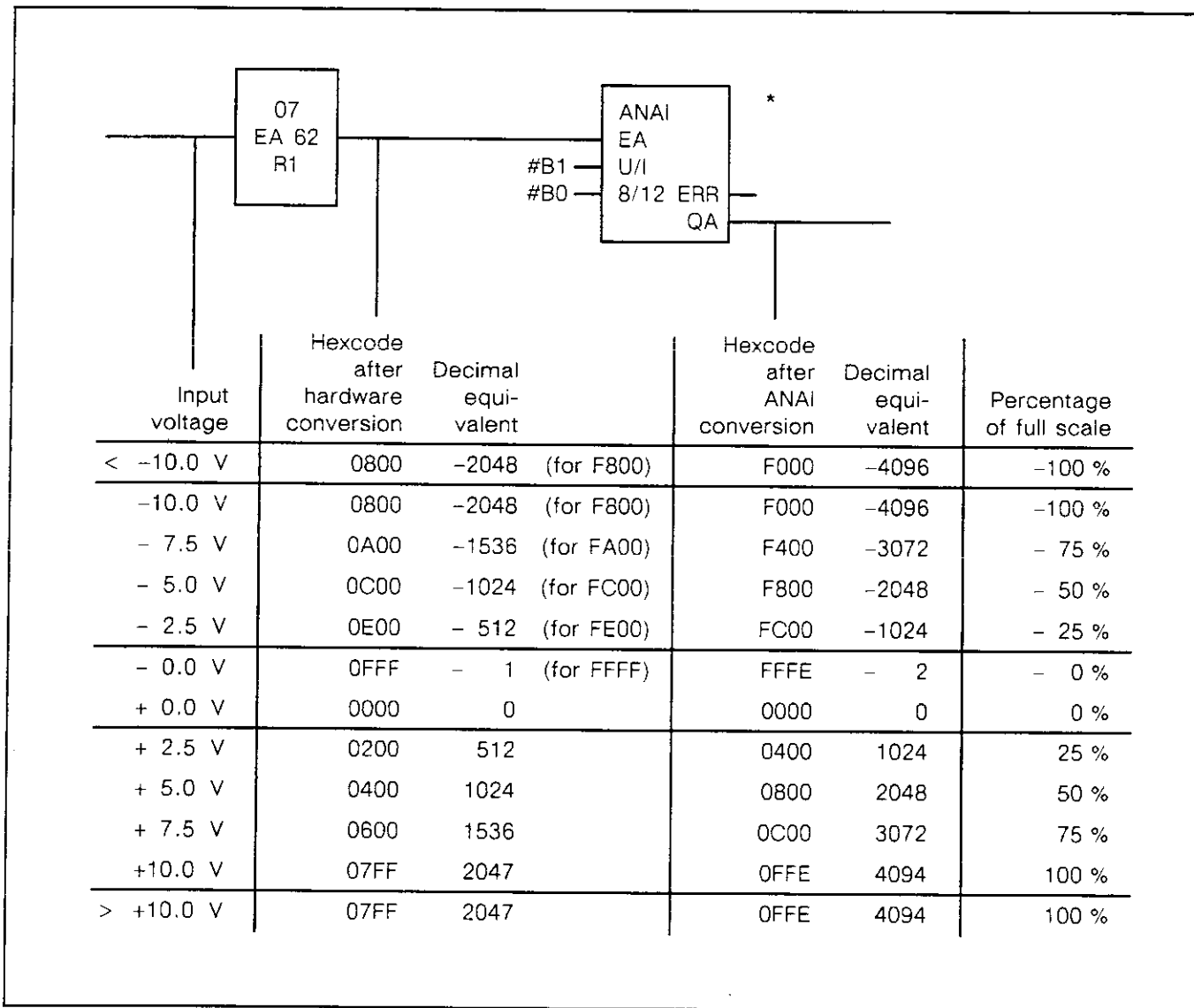
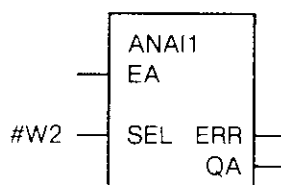

Table 8.3.1: Conversion table 07 EA 62 R1

* The ANAI1 function block with the appropriate SEL code according to the table on the right can be used instead of the ANAI function block.



SEL	Module
#W0	07 EA 60
#W1	07 EA 61
#W2	07 EA 62
#W3	07 EA 63
#W4	07 EA 64
#W5	07 EA 65

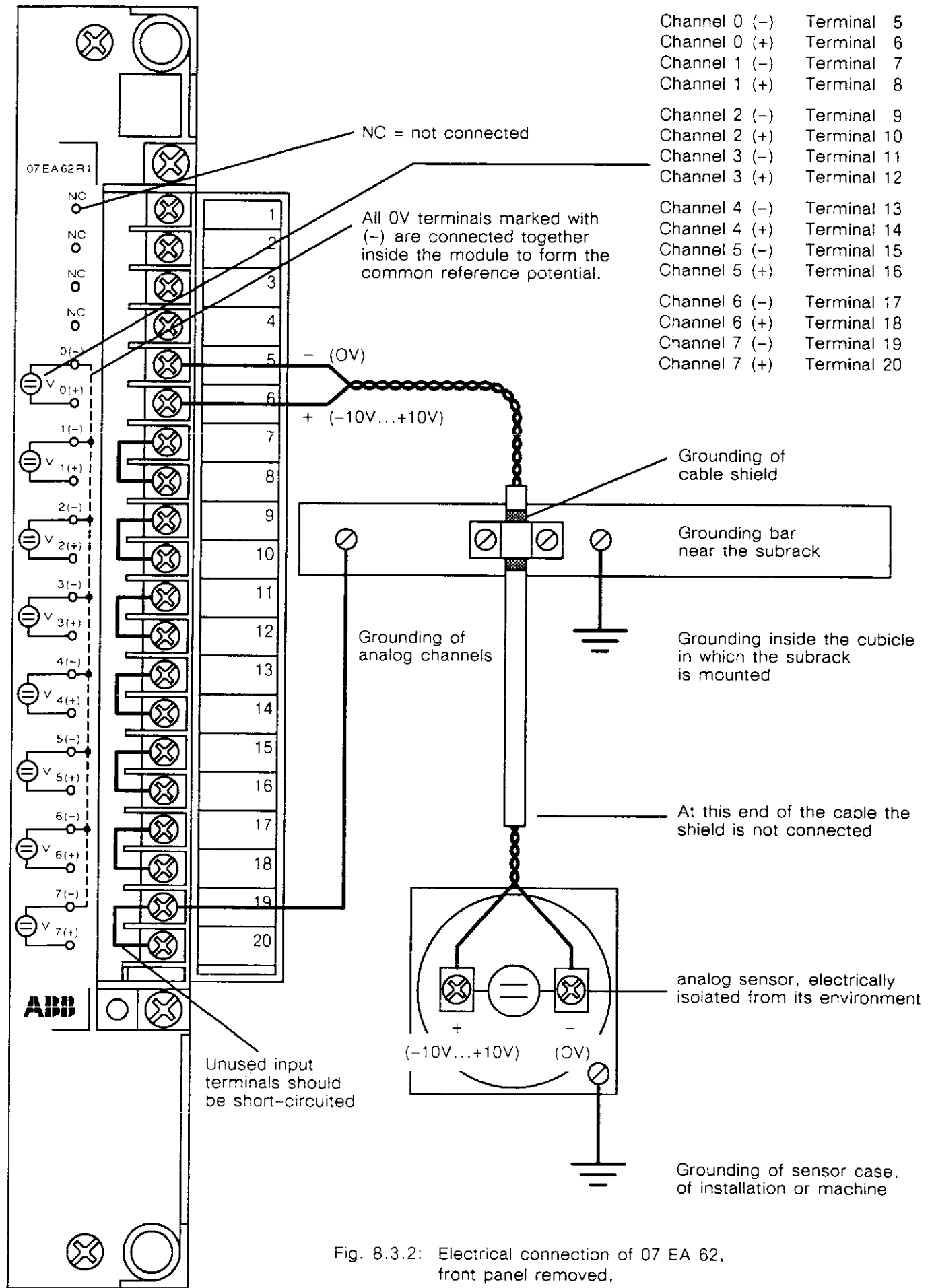

Fig. 8.3.2: Electrical connection of 07 EA 62, front panel removed, terminal cover opened

8.4 Analog Input Module 07 EA 63 R1

4...20 mA, 12 bits, 8 channels, electrically isolated, open-circuit monitoring

The analog input module 07 EA 63 converts input signal currents of 3.75...20 mA into internal binary codes, working with a resolution of 12 bits. At each of the 8 channels the analog process signals are connected with two wires.

The function block ANAI (or ANAI1) within 907 PC 32 evaluates open circuit and converts internal codes corresponding to the range of 4...20 mA.

All 0V terminals marked with (-) are connected together inside the module and form the common reference potential. The analog input circuitry is electrically isolated.

Care has to be taken for correct grounding and shielding of signal cables, sensors and reference potentials. Unused inputs should be short-circuited to improve the noise immunity.

Technical Data

Number of inputs per module	8																											
Electrical isolation	yes, common reference potential																											
Nominal insulation voltage, process terminals versus subrack and internal connections: acc. VDE 0160 tested with	60 V AC 500 V AC																											
Input data																												
input current range	4...20 mA																											
0...100 % corresponds to open-circuit monitoring, if input current < 4 mA, threshold \approx 3.76 mA	yes, with function block ANAI or ANAI1 within 907 PC 32																											
hexadecimal representation (see table 8.4.1) after hardware conversion	0000...0FFF, corresponding to 3.75...20 mA																											
after conversion with ANAI or ANAI1	0000...0FFF, corresponding to 4...20 mA																											
hardware conversion, if input current out of range																												
input current > 20 mA	0FFF																											
input current < 3.75 mA	0000																											
input resistance	100 Ω																											
resolution (1 LSB)	3.97 μ A																											
adjustment inaccuracy on delivery	max. \pm 1 % of full scale																											
inaccuracy caused by resolution	max. \pm 1/2 LSB																											
non-linearity	max. \pm 1/2 LSB																											
temperature coefficient (full scale)	max. \pm 0.347 μ A/K																											
Max. permissible input current (destruction limit)	+40 mA, -5 mA																											
Conversion rate	5 ms																											
Supply current from internal voltages																												
UB1 = 5 V DC	max. 60 mA																											
UB4 = 24 V DC	max. 190 mA																											
Power dissipation	max. 4.86 W																											
Cable length, if cables have been laid parallel in cable duct, shielded	max. 50 m																											
two-core shielded and cross section \geq 0.5 mm ²	max. 200 m																											
Conductor cross section of process terminals	max. 1.5 mm ²																											
Signalling of the input signals	no signalling																											
Number of required slots	1 I/O slot																											
Number of occupied I/O points	128																											
Configuration identifier in 907 PC 32	EW8																											
Ability of fitting in subracks																												
slots, ● = plug-in is possible	<table border="1" style="display: inline-table; border-collapse: collapse; text-align: center;"> <thead> <tr> <th colspan="3">BT</th> <th colspan="3">BE-central</th> <th colspan="3">BE-remote</th> </tr> <tr> <th>NG</th> <th>ZE</th> <th>I/O</th> <th>NG</th> <th>BV</th> <th>I/O</th> <th>NG</th> <th>BV</th> <th>I/O</th> </tr> </thead> <tbody> <tr> <td></td> <td></td> <td>●</td> <td></td> <td></td> <td>●</td> <td></td> <td></td> <td>●</td> </tr> </tbody> </table>	BT			BE-central			BE-remote			NG	ZE	I/O	NG	BV	I/O	NG	BV	I/O			●			●			●
BT			BE-central			BE-remote																						
NG	ZE	I/O	NG	BV	I/O	NG	BV	I/O																				
		●			●			●																				
Weight	500 g																											
Order number	GJV3074353R1																											

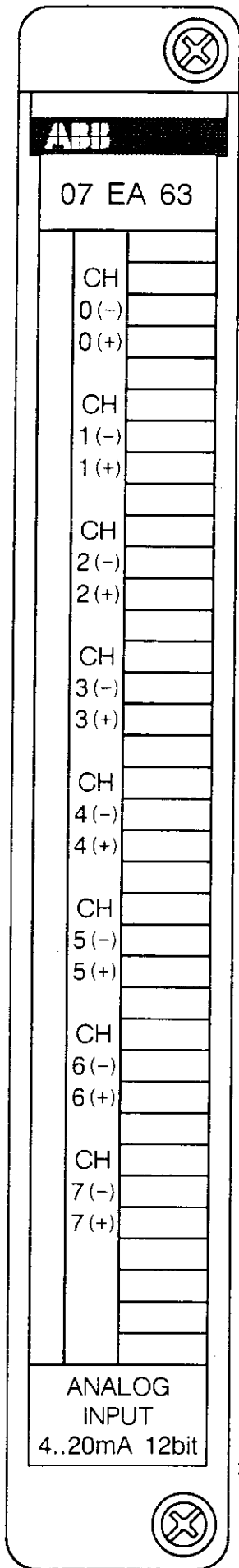

Channel Terminal

- NC 1 ○
- NC 2 ○
- NC 3 ○
- NC 4 ○

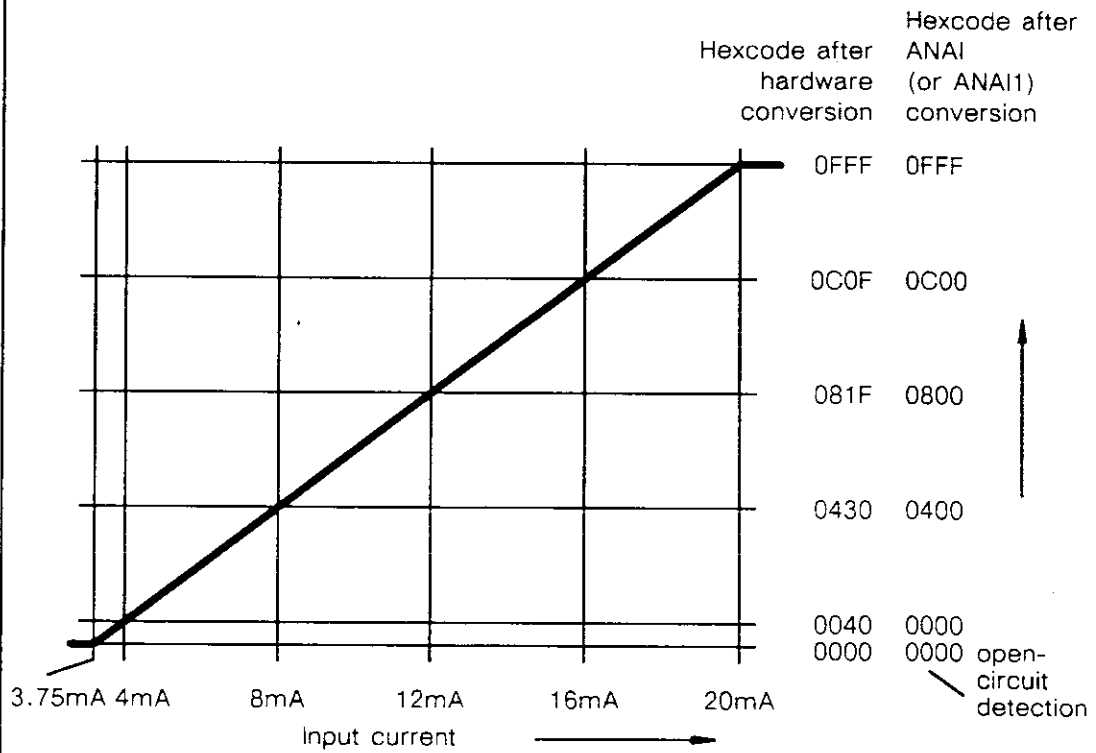
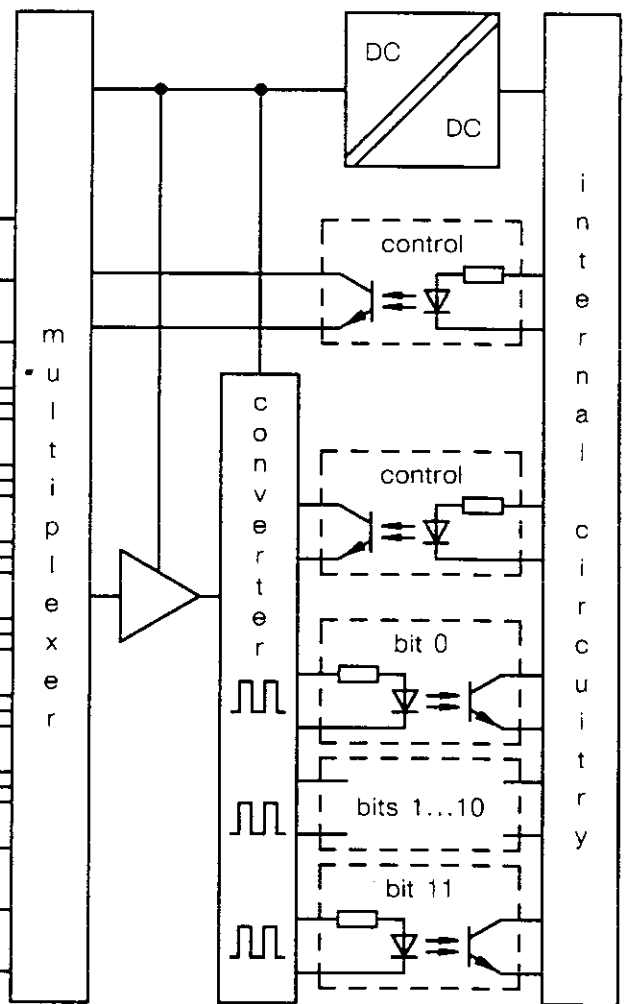
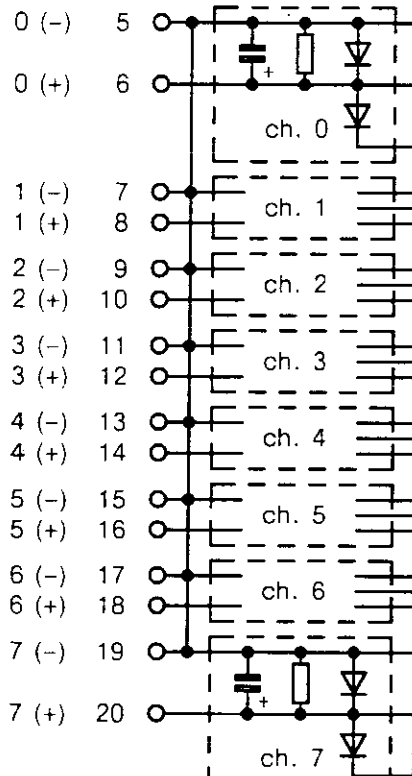

Fig. 8.4.1: 07 EA 63: Input circuitry, terminal assignment and conversion diagram of channels

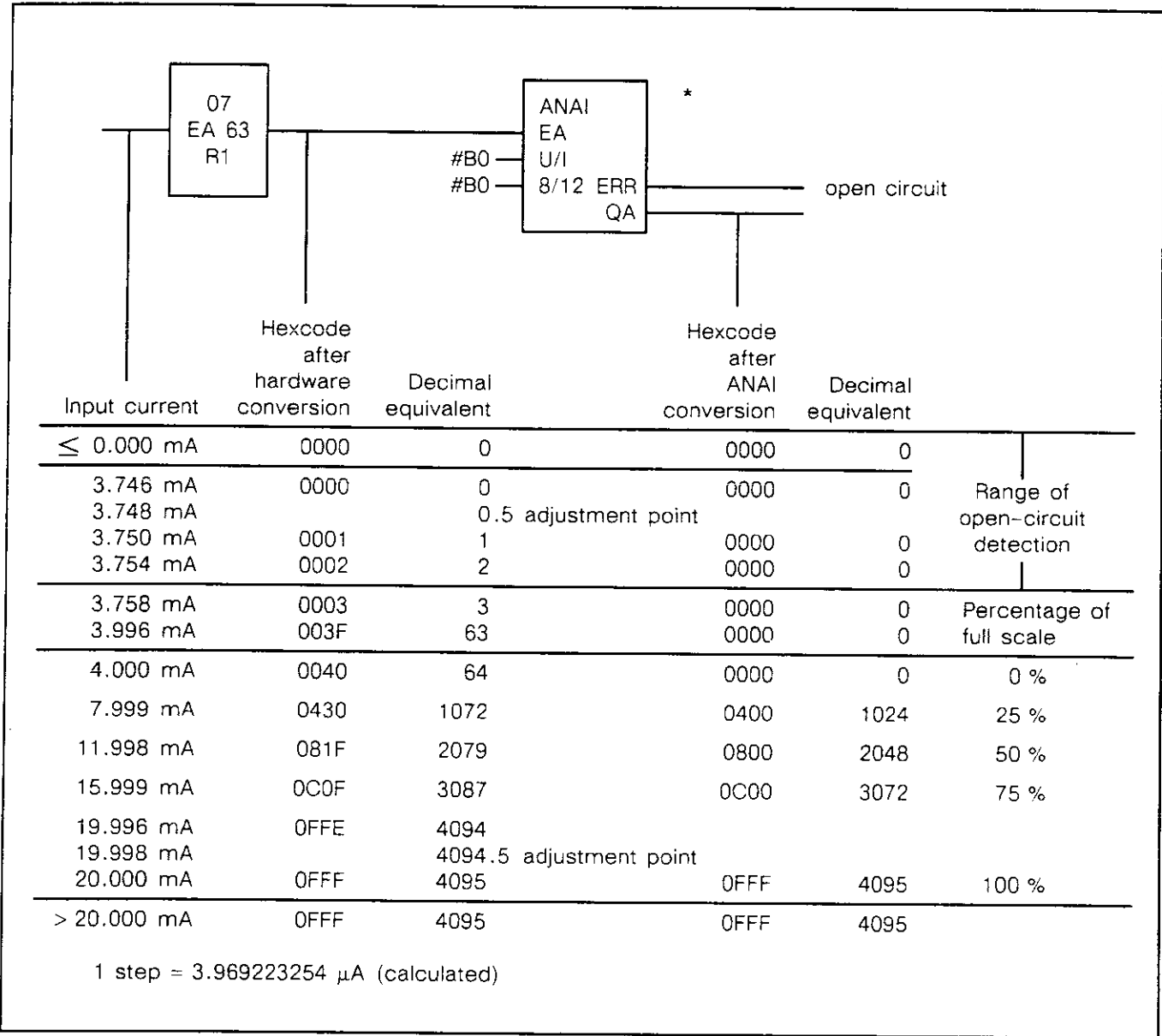
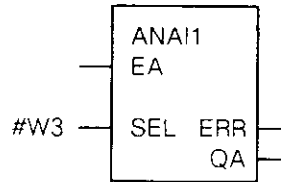

Table 8.4.1: Conversion table 07 EA 63 R1

* The ANAI1 function block with the appropriate SEL code according to the table on the right can be used instead of the ANAI function block.



SEL	Module
#W0	07 EA 60
#W1	07 EA 61
#W2	07 EA 62
#W3	07 EA 63
#W4	07 EA 64
#W5	07 EA 65

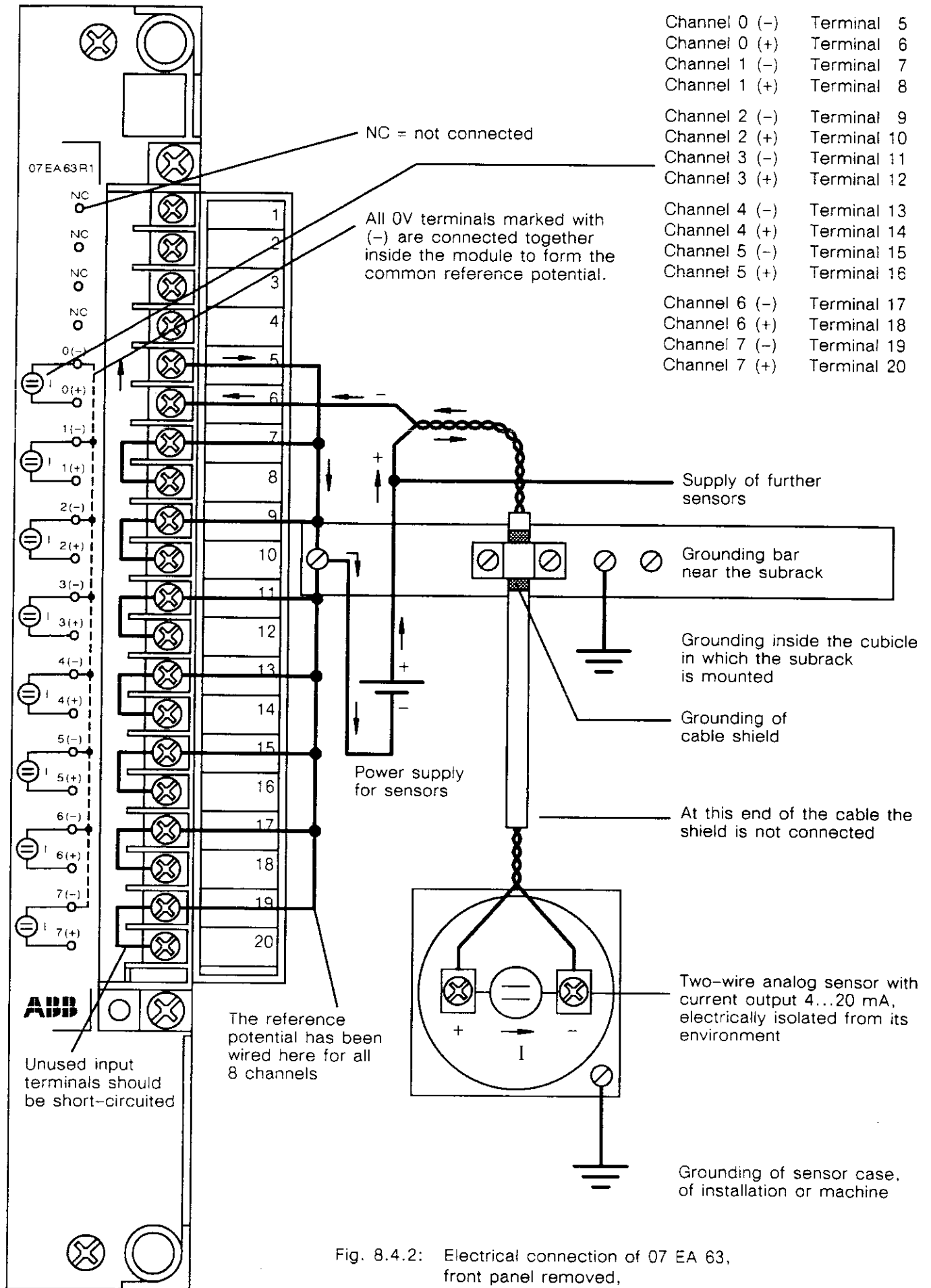

Fig. 8.4.2: Electrical connection of 07 EA 63, front panel removed, terminal cover opened

8.5 Analog Input Module 07 EA 64 R1

0...20 mA, 8 bits, 8 channels, electrically isolated

The analog input module 07 EA 64 converts input signal currents of 0...20 mA into internal binary codes, working with a resolution of 8 bits. At each of the 8 channels the analog process signals are connected with two wires.

The function block ANAI1 within 907 PC 32 converts internal codes corresponding to the range of 0...20 mA.

All 0V terminals marked with (-) are connected together inside the module and form the common reference potential. The analog input circuitry is electrically isolated.

Care has to be taken for correct grounding and shielding of signal cables, sensors and reference potentials. Unused inputs should be short-circuited to improve the noise immunity.

Technical Data

Number of inputs per module	8																											
Electrical isolation	yes, common reference potential																											
Nominal insulation voltage, process terminals versus subrack and internal connections:																												
acc. VDE 0160	60 V AC																											
tested with	500 V AC																											
Input data																												
input current range																												
0...100 % corresponds to	0...20 mA																											
open-circuit monitoring	none																											
hexadecimal representation (see table 8.5.1)																												
after hardware conversion	0000...00FF, corresponding to 0...20 mA																											
after conversion with ANAI1	0000...0FF0, corresponding to 0...20 mA																											
hardware conversion, if input current out of range																												
input current > 20 mA	00FF																											
input current < 0 mA	0000																											
input resistance	100 Ω																											
resolution (1 LSB)	78.4 μA																											
adjustment inaccuracy on delivery	max. ± 1 % of full scale																											
inaccuracy caused by resolution	max. ± 1/2 LSB																											
non-linearity	max. ± 1/2 LSB																											
temperature coefficient (full scale)	max. ± 2.78 μA/K																											
Max. permissible input current (destruction limit)	+40 mA, -5 mA																											
Conversion rate	5 ms																											
Supply current from internal voltages																												
UB1 = 5 V DC	max. 60 mA																											
UB4 = 24 V DC	max. 70 mA																											
Power dissipation	max. 1.98 W																											
Cable length, if cables have been laid parallel																												
in cable duct, shielded	max. 50 m																											
two-core shielded and cross section ≥ 0.5 mm ²	max. 200 m																											
Conductor cross section of process terminals	max. 1.5 mm ²																											
Signalling of the input signals	no signalling																											
Number of required slots	1 I/O slot																											
Number of occupied I/O points	128																											
Configuration identifier in 907 PC 32	EW8																											
Ability of fitting in subracks																												
slots, ● = plug-in is possible	<table border="1" style="border-collapse: collapse; text-align: center; width: 100%;"> <tr> <td colspan="3">BT</td> <td colspan="3">BE-central</td> <td colspan="3">BE-remote</td> </tr> <tr> <td>NG</td><td>ZE</td><td>I/O</td> <td>NG</td><td>BV</td><td>I/O</td> <td>NG</td><td>BV</td><td>I/O</td> </tr> <tr> <td></td><td></td><td>●</td> <td></td><td></td><td>●</td> <td></td><td></td><td>●</td> </tr> </table>	BT			BE-central			BE-remote			NG	ZE	I/O	NG	BV	I/O	NG	BV	I/O			●			●			●
BT			BE-central			BE-remote																						
NG	ZE	I/O	NG	BV	I/O	NG	BV	I/O																				
		●			●			●																				
Weight	470 g																											
Order number	GJV3074355R1																											

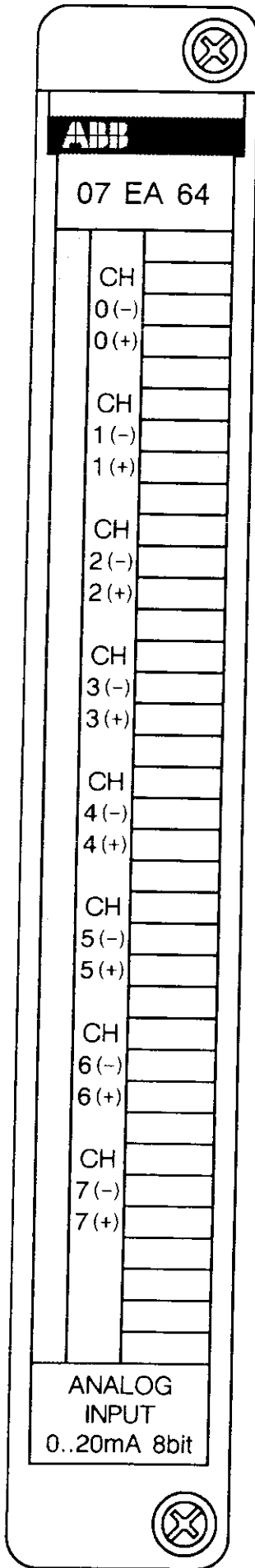

Channel Terminal

- NC 1 ○
- NC 2 ○
- NC 3 ○
- NC 4 ○

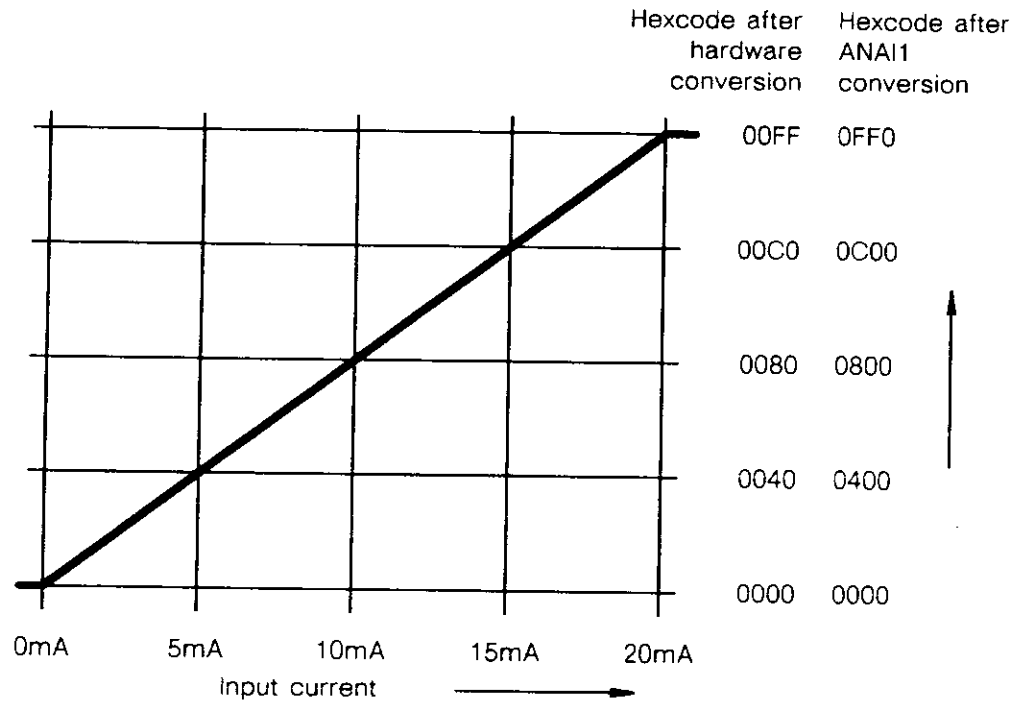
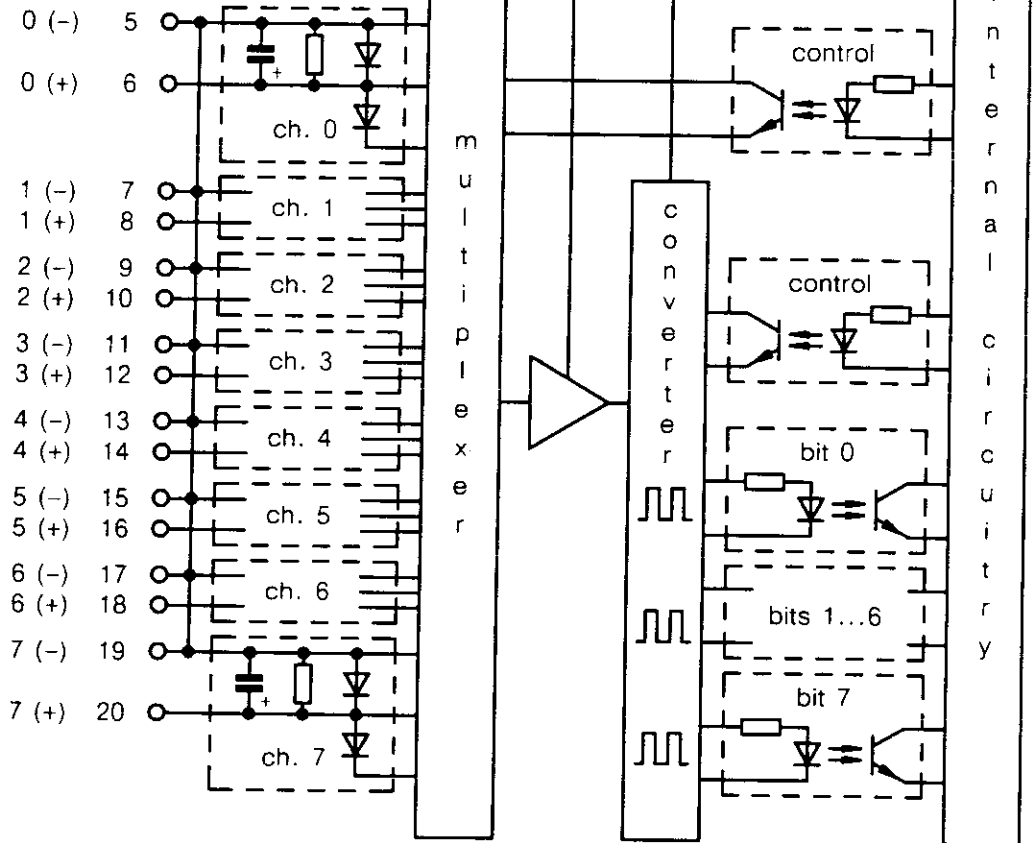

Fig. 8.5.1: 07 EA 64, Input circuitry, terminal assignment and conversion diagram of channels

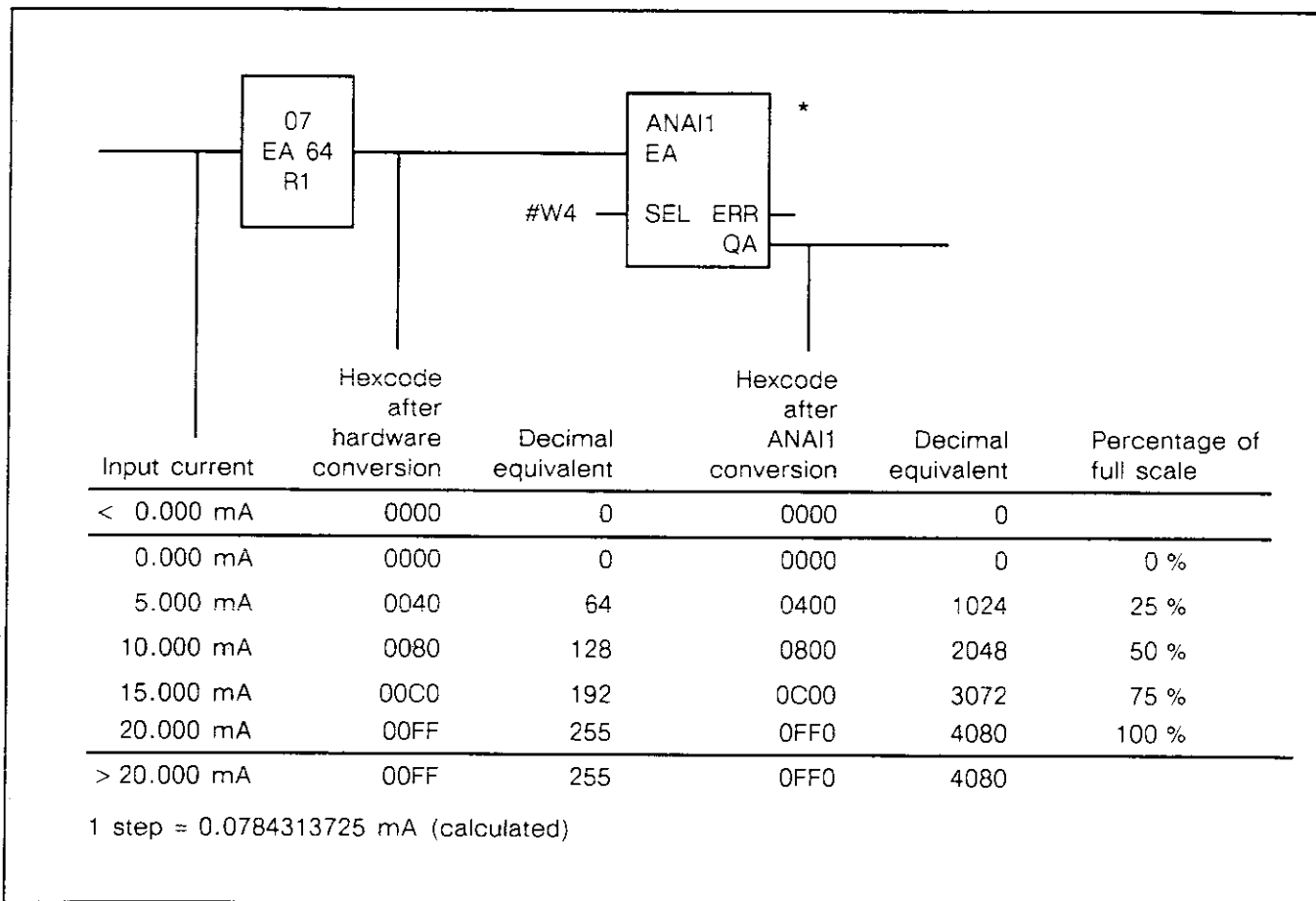
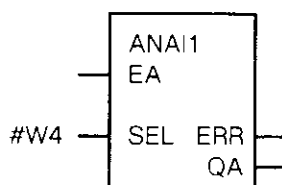

Table 8.5.1: Conversion table 07 EA 64 R1

* SEL input code of the ANAI1 function block see the table on the right

With this module, the ERR output has no function.



SEL	Module
#W0	07 EA 60
#W1	07 EA 61
#W2	07 EA 62
#W3	07 EA 63
#W4	07 EA 64
#W5	07 EA 65

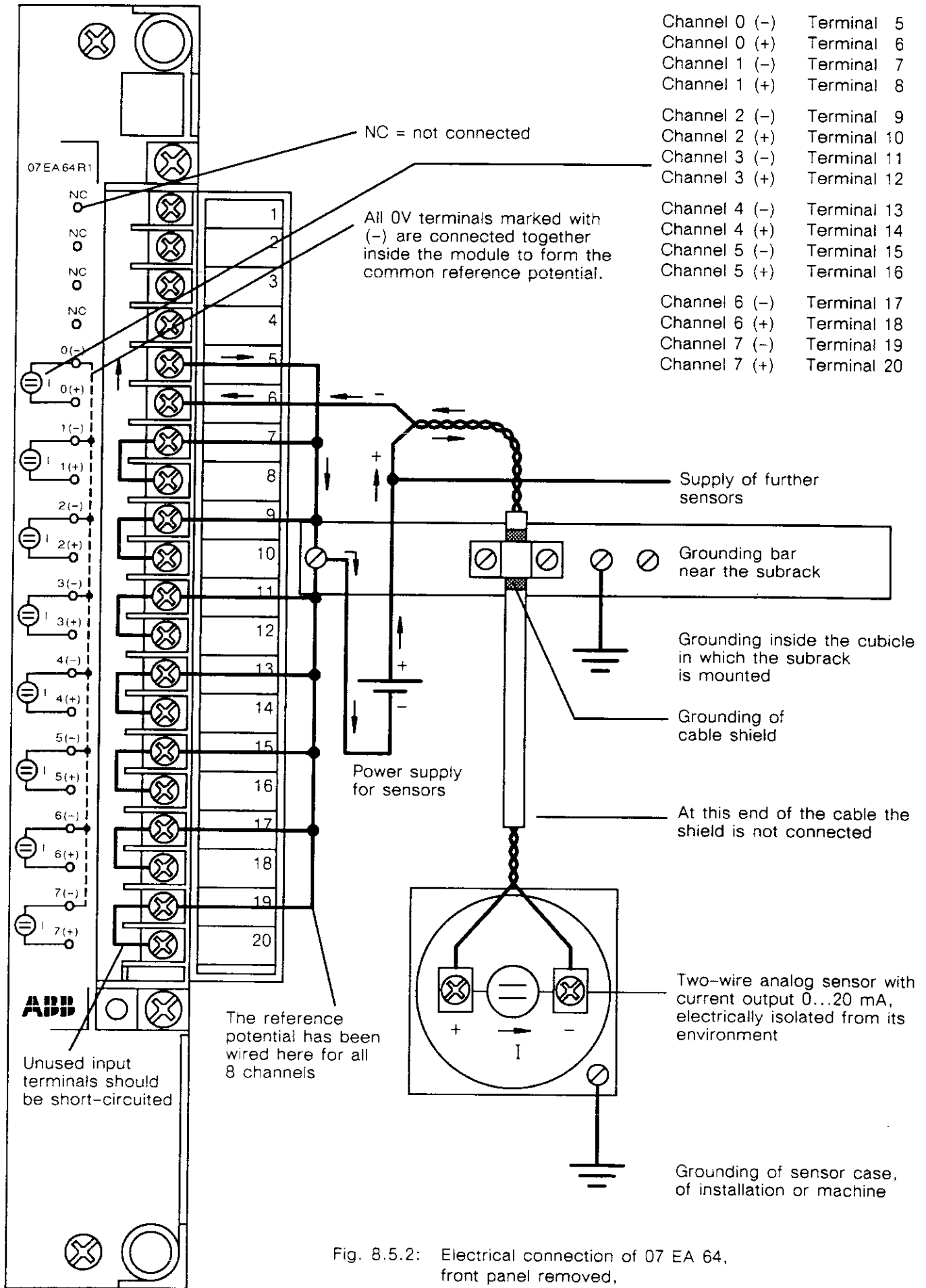

Fig. 8.5.2: Electrical connection of 07 EA 64, front panel removed, terminal cover opened

8.6 Analog Input Module 07 EA 65 R1

0...20 mA, 12 bits, 8 channels, electrically isolated

The analog input module 07 EA 65 converts input signal currents of 0...20 mA into internal binary codes, working with a resolution of 12 bits. At each of the 8 channels the analog process signals are connected with two wires.

The function block ANAI1 within 907 PC 32 converts internal codes corresponding to the range of 0...20 mA.

All 0V terminals marked with (-) are connected together inside the module and form the common reference potential. The analog input circuitry is electrically isolated.

Care has to be taken for correct grounding and shielding of signal cables, sensors and reference potentials. Unused inputs should be short-circuited to improve the noise immunity.

Technical Data

Number of inputs per module	8																											
Electrical isolation	yes, common reference potential																											
Nominal insulation voltage, process terminals versus subrack and internal connections:																												
acc. VDE 0160	60 V AC																											
tested with	500 V AC																											
Input data																												
input current range	0...20 mA																											
0...100 % corresponds to	0...20 mA																											
open-circuit monitoring	none																											
hexadecimal representation (see table 8.6.1)																												
after hardware conversion	0000...0FFF, corresponding to 0...20 mA																											
after conversion with ANAI1	0000...0FFF, corresponding to 0...20 mA																											
hardware conversion, if input current out of range																												
input current > 20 mA	0FFF																											
input current < 0 mA	0000																											
input resistance	100 Ω																											
resolution (1 LSB)	4.88 μA																											
adjustment inaccuracy on delivery	max. ± 1 % of full scale																											
inaccuracy caused by resolution	max. ± 1/2 LSB																											
non-linearity	max. ± 1/2 LSB																											
temperature coefficient (full scale)	max. ± 0.347 μA/K																											
Max. permissible input current (destruction limit)	+40 mA, -5 mA																											
Conversion rate	5 ms																											
Supply current from internal voltages																												
UB1 = 5 V DC	max. 60 mA																											
UB4 = 24 V DC	max. 190 mA																											
Power dissipation	max. 4.86 W																											
Cable length, if cables have been laid parallel																												
in cable duct, shielded	max. 50 m																											
two-core shielded and cross section ≥ 0.5 mm ²	max. 200 m																											
Conductor cross section of process terminals	max. 1.5 mm ²																											
Signalling of the input signals	no signalling																											
Number of required slots	1 I/O slot																											
Number of occupied I/O points	128																											
Configuration identifier in 907 PC 32	EW8																											
Ability of fitting in subracks																												
slots, ● = plug-in is possible	<table border="1" style="border-collapse: collapse; text-align: center; width: 100%;"> <tr> <td colspan="3">BT</td> <td colspan="3">BE-central</td> <td colspan="3">BE-remote</td> </tr> <tr> <td>NG</td><td>ZE</td><td>I/O</td> <td>NG</td><td>BV</td><td>I/O</td> <td>NG</td><td>BV</td><td>I/O</td> </tr> <tr> <td></td><td></td><td>●</td> <td></td><td></td><td>●</td> <td></td><td></td><td>●</td> </tr> </table>	BT			BE-central			BE-remote			NG	ZE	I/O	NG	BV	I/O	NG	BV	I/O			●			●			●
BT			BE-central			BE-remote																						
NG	ZE	I/O	NG	BV	I/O	NG	BV	I/O																				
		●			●			●																				
Weight	500 g																											
Order number	GJV3074359R1																											

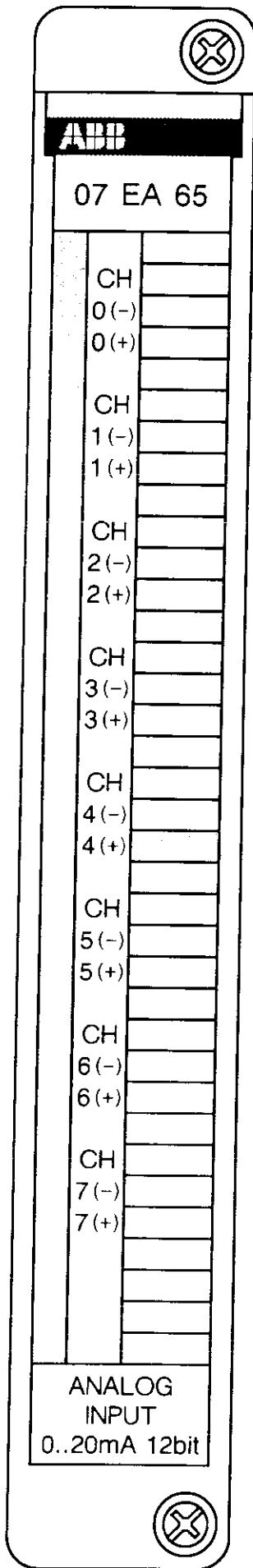

Channel Terminal

- NC 1 ○
- NC 2 ○
- NC 3 ○
- NC 4 ○

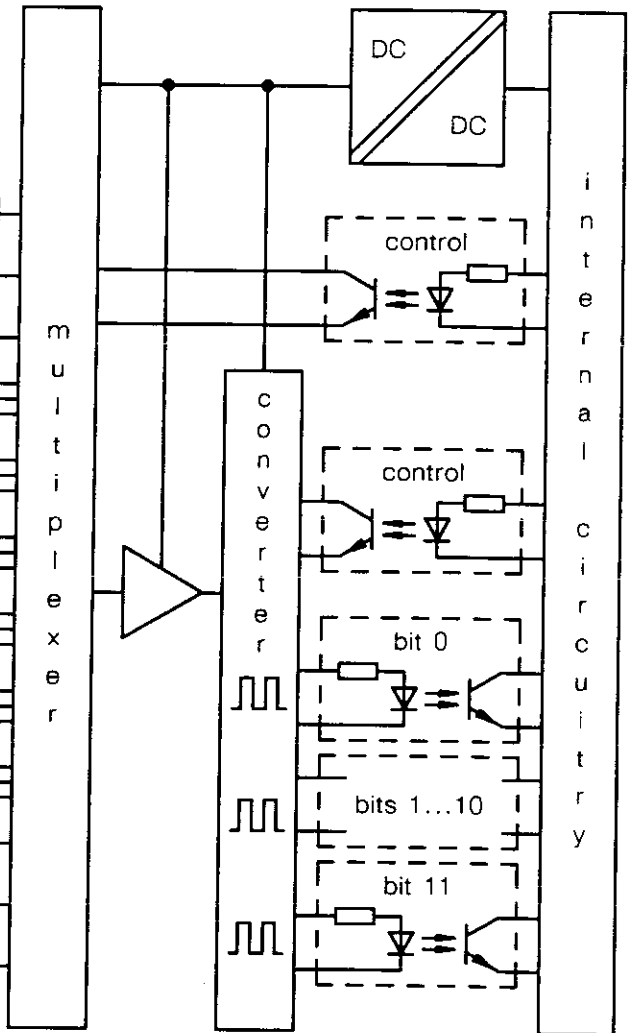
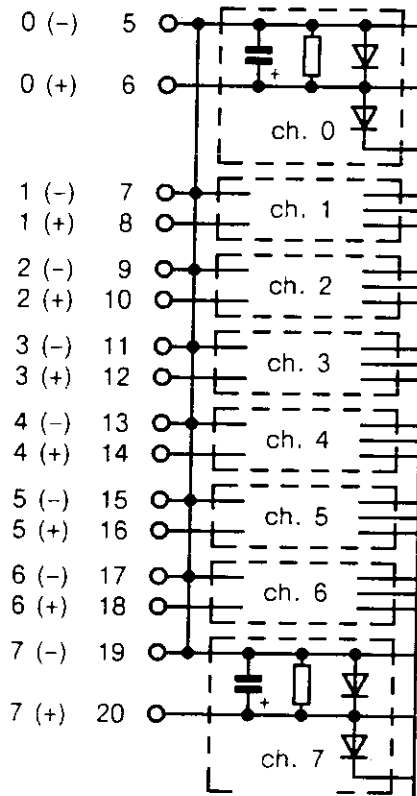

Hexcode after hardware conversion Hexcode after ANAI1 conversion

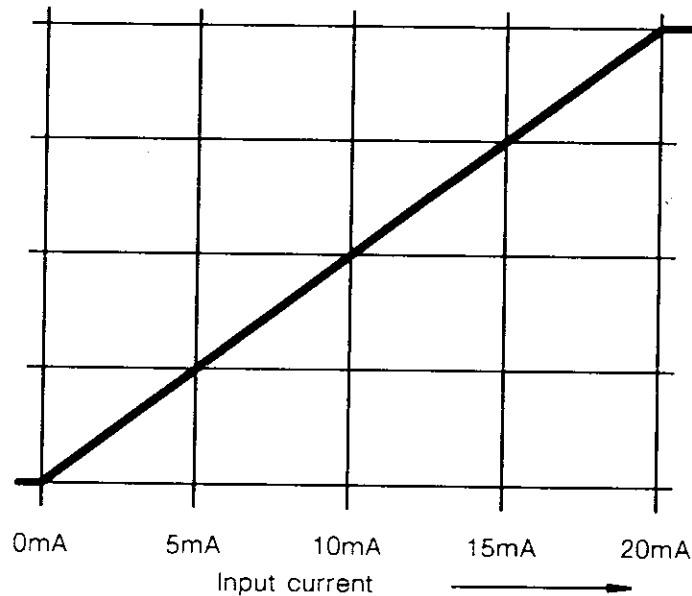
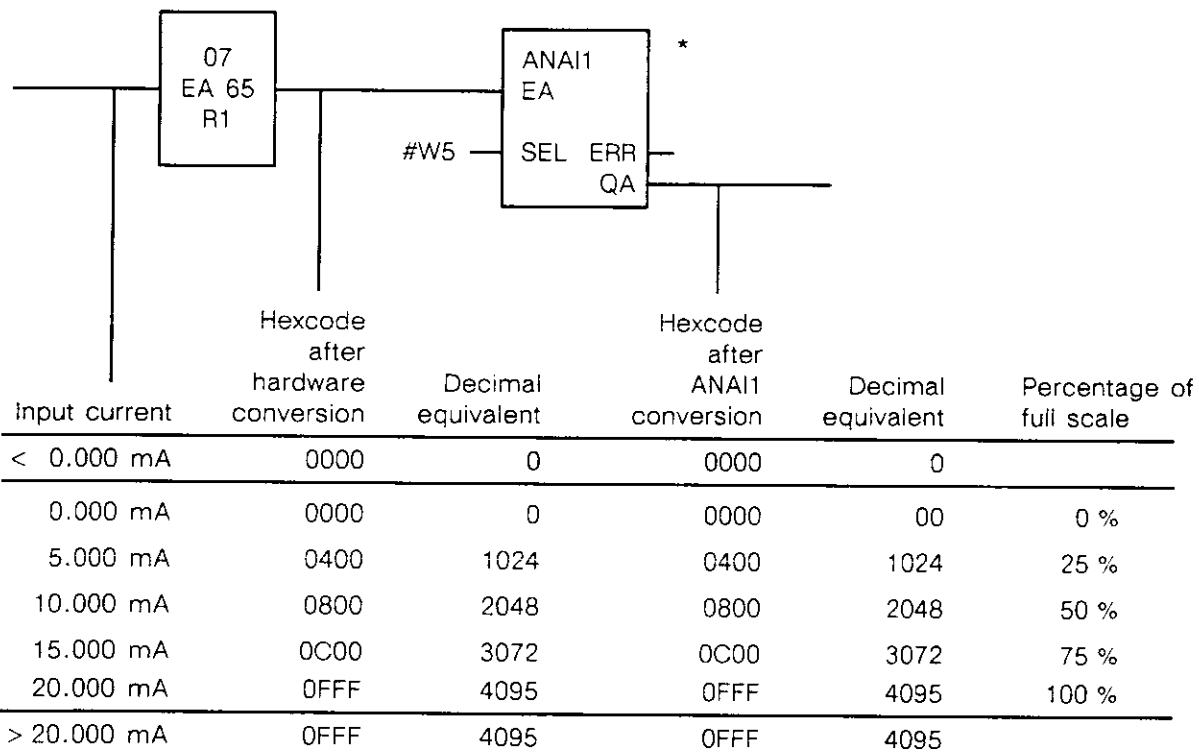

Fig. 8.6.1: 07 EA 65, Input circuitry, terminal assignment and conversion diagram of channels



1 step = 4.884 μ A (calculated)

Table 8.6.1: Conversion table 07 EA 65 R1

* SEL input code of the ANAI1 function block see the table on the right

With this module, the ERR output has no function.

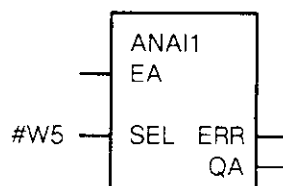

SEL	Module
#W0	07 EA 60
#W1	07 EA 61
#W2	07 EA 62
#W3	07 EA 63
#W4	07 EA 64
#W5	07 EA 65

Channel 0 (-)	Terminal 5
Channel 0 (+)	Terminal 6
Channel 1 (-)	Terminal 7
Channel 1 (+)	Terminal 8
Channel 2 (-)	Terminal 9
Channel 2 (+)	Terminal 10
Channel 3 (-)	Terminal 11
Channel 3 (+)	Terminal 12
Channel 4 (-)	Terminal 13
Channel 4 (+)	Terminal 14
Channel 5 (-)	Terminal 15
Channel 5 (+)	Terminal 16
Channel 6 (-)	Terminal 17
Channel 6 (+)	Terminal 18
Channel 7 (-)	Terminal 19
Channel 7 (+)	Terminal 20

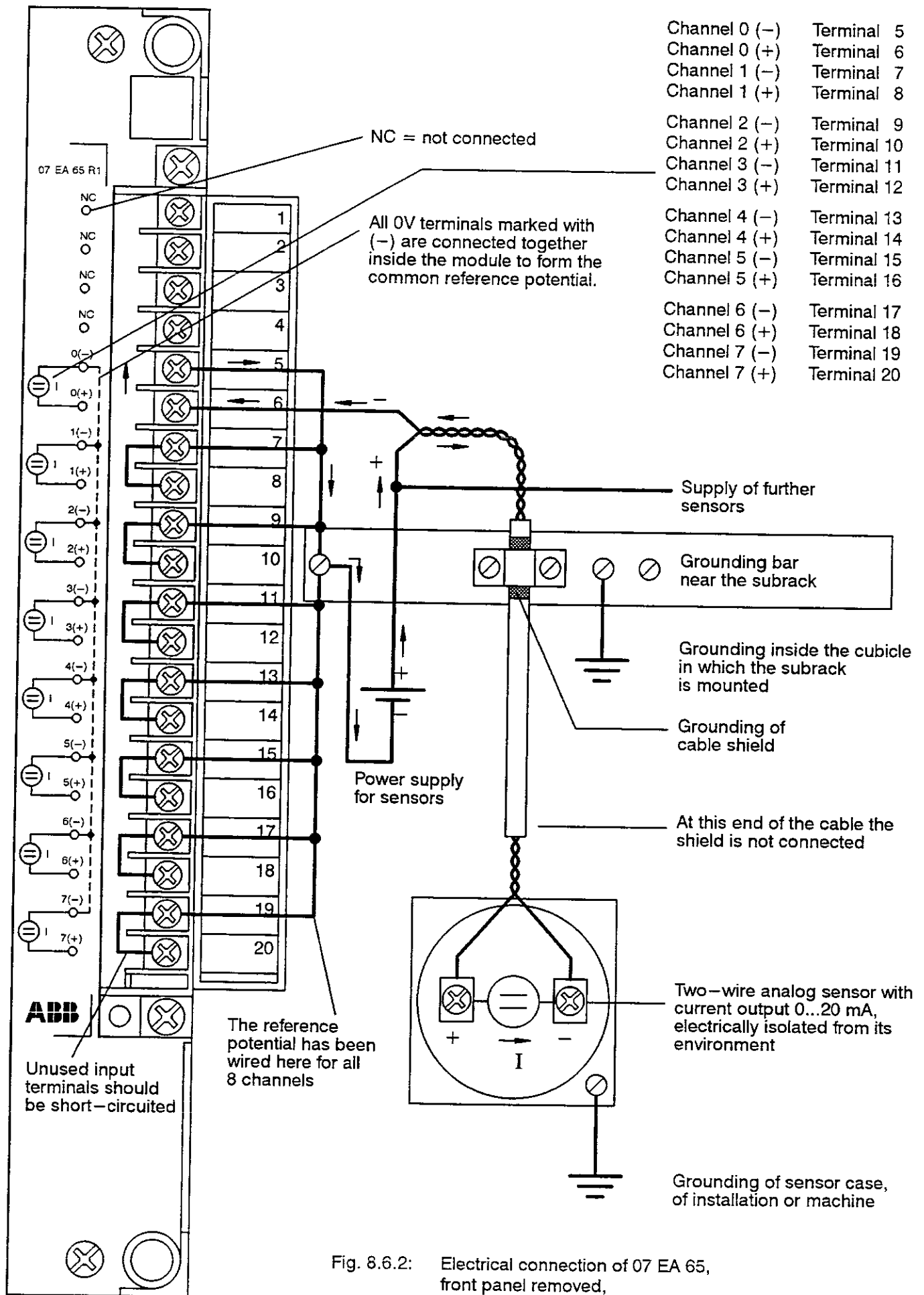

Fig. 8.6.2: Electrical connection of 07 EA 65, front panel removed, terminal cover opened

8.7 Analog Input Module 07 EA 66 R1

Pt 100, $-50^{\circ}\text{C} \dots +400^{\circ}\text{C}$, 13 bits, 8 channels, electrically isolated

General information

The 07 EA 66 input module evaluates the resistance values of 8 Pt 100 resistance thermometers with a resolution of 13 bits plus sign. The measuring range is from -50°C to $+400^{\circ}\text{C}$. The temperature resistance curve (according to DIN 43 760, IEC 65) is linearized inside the module.

There is an electrical isolation between the input circuitry and internal supply voltages (bus voltages).

Measured value acquisition and conversion

All 8 Pt 100 sensors are connected in series and the constant-current generated inside the module flows through them. The resulting voltage drops are scanned one after another (in the multiplex method) and converted into internal digital signals. The conversion is carried out in two steps: as voltage frequency conversion before the electrical isolation and as conversion into the HEX code after transmission via optocouplers.

The relation between the measured temperature, the resistance value of the thermometer, the voltage drop at the resistance thermometer (differential voltage at the measuring inputs), the converted HEX code, and the corresponding decimal equivalent is shown in the following table.

Temperature measured	Resistance of the Pt 100 sensor	Differential voltage at the measuring input (constant-current = 2 mA)	Converted HEX code	Decimal equivalent
-50°C	80.31 Ω	160.62 mV	F800	-2048
-25°C	90.19 Ω	180.38 mV	FC00	-1024
0°C	100.00 Ω	200.00 mV	0000	0
$+25^{\circ}\text{C}$	109.73 Ω	219.46 mV	0400	1024
$+50^{\circ}\text{C}$	119.40 Ω	238.80 mV	0800	2048
$+75^{\circ}\text{C}$	128.98 Ω	257.96 mV	0C00	3072
$+100^{\circ}\text{C}$	138.50 Ω	277.00 mV	1000	4096
$+125^{\circ}\text{C}$	147.94 Ω	295.88 mV	1400	5120
$+150^{\circ}\text{C}$	157.31 Ω	314.62 mV	1800	6144
$+200^{\circ}\text{C}$	175.84 Ω	351.68 mV	2000	8192
$+250^{\circ}\text{C}$	194.07 Ω	388.14 mV	2800	10240
$+300^{\circ}\text{C}$	212.02 Ω	424.04 mV	3000	12288
$+350^{\circ}\text{C}$	229.67 Ω	459.34 mV	3800	14336
$+400^{\circ}\text{C}$	247.04 Ω	494.08 mV	4000	16384

Table 8.7.1: Evaluation values for the Pt 100 resistance thermometer

The ANAI (or ANAI1) function block cannot be used for this module and is not necessary either. After the conversion inside the module the HEX code required for the system is already present.

The temperature and the HEX code (and decimal equivalent) are linear to each other (as shown in Table 8.7.1). A fixed significance is assigned to each bit in the HEX code in relation to the temperature (Table 8.7.2).

Bit significance		Bit significance	
Bit 15	-800 K	Bit 7	+ 3.125 K
Bit 14	+400 K	Bit 6	+ 1.563 K
Bit 13	+200 K	Bit 5	+ 0.781 K
Bit 12	+100 K	Bit 4	+ 0.391 K
Bit 11	+ 50 K	Bit 3	+ 0.195 K
Bit 10	+ 25 K	Bit 2	+ 0.098 K
Bit 9	+ 12.5 K	Bit 1	0
Bit 8	+ 6.25 K	Bit 0	0

1 K = 1 Kelvin (temperature change by 1 degree)

Table 8.7.2: Significances of the bits in the HEX code, related to 0°C

If the significances of the bits set to 1 are summed up, the result will be the measured temperature in $^{\circ}\text{C}$.

Connection of the resistance thermometers

The analog input module 07 EA 66 is primarily designated for the connection of Pt 100 resistance thermometers in a four-wire configuration. In this case, the voltage drops at the current-carrying lines do not lead to an inaccuracy of the measurement result, as the measuring voltage is tapped by separate lines. The input resistances of the measuring channels (terminals V0...7+, V0...7-) are very high, thus the voltage drops at the measuring lines are negligible (Fig. 8.7.1).

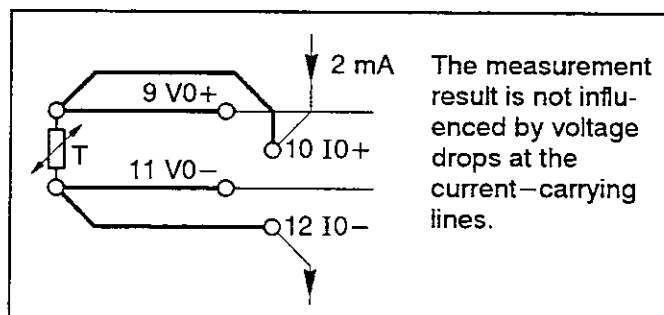

Fig. 8.7.1: Four-wire configuration for Pt 100 resistance thermometers

The connection in a two-wire configuration is possible, if there is a short distance between the Pt 100 sensor and the evaluation module. In this case, the measurement result is affected by the total resistance of the line (forward and backward). The inaccuracy amounts to approximately $+ 2.5 \text{ }^\circ\text{C}$ for each ohm of the lines' resistance (Fig. 8.7.3).

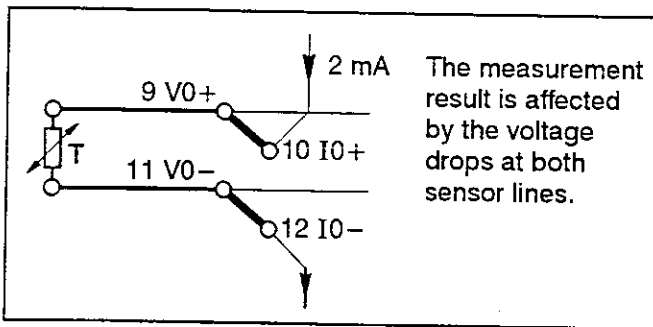

Fig. 8.7.3: Two-wire configuration for Pt 100 resistance thermometers

The four terminals of each of the unused channels have to be short-circuited (Fig. 8.7.4).

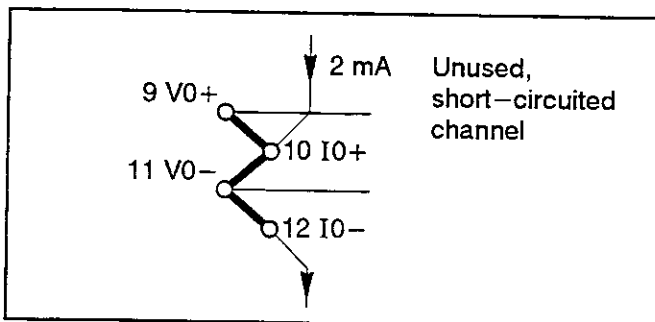

Fig. 8.7.4: Short-circuiting the terminals of an unused channel

Only electrically isolated sensors may be used. As the sensors are connected in series, it is not allowed to ground one line of each sensor. Otherwise this would lead to short-circuits at measuring inputs.

Conversion between temperature and internal numerical representation

It is possible to convert the temperature into the internal numerical representation and vice versa. In both cases $1 \text{ }^\circ\text{C}$ corresponds to the decimal value of 40.96.

To get the decimal value, the temperature value (in $^\circ\text{C}$) is first multiplied by 40.96. Then, it is rounded up or down to a figure which is divisible by 4. This corresponds to the resolution of 13 bits plus sign. The equivalent HEX code can be achieved by conversion.

The calculation is illustrated in the following flow diagram.

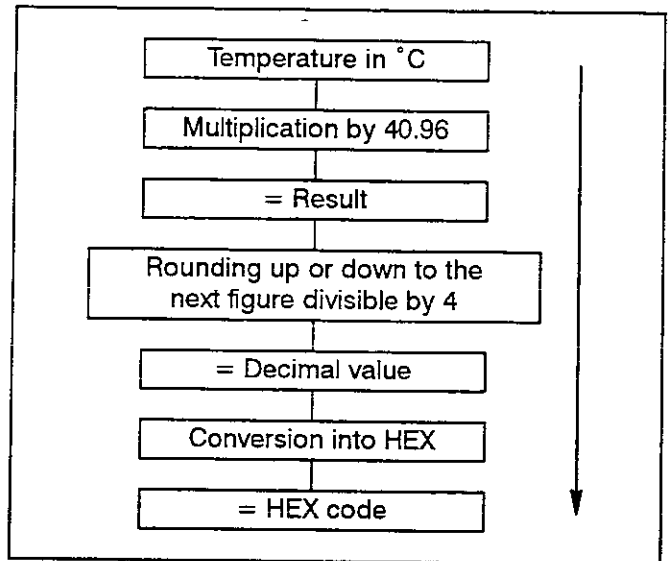

Fig. 8.7.5: Conversion between temperature and internal numerical representation

If the HEX code is given and the temperature is to be found, the calculation method has to be used the other way round.

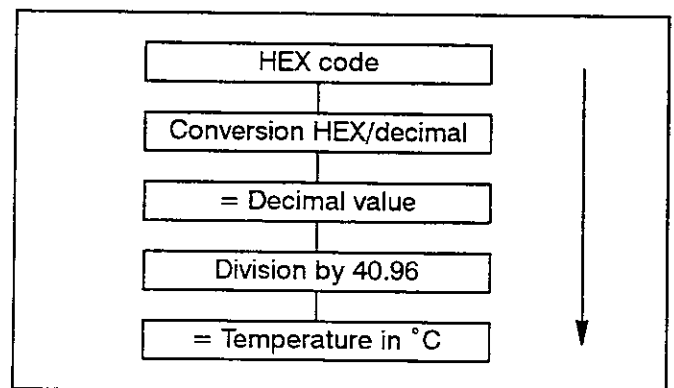

Fig. 8.7.6: Conversion between HEX code and temperature

The following table was created using the above calculation method.

Table 8.7.3: Conversion between temperature and internal numerical representation

Temp. in °C	Dec. value	HEX code	Temp. in °C	Dec. value	HEX code	Temp. in °C	Dec. value	HEX code
< -51	32767	7FFF						
-51	-2088	F7D8						
-50	-2048	F800	50	2048	0800	200	8192	2000
-45	-1844	F8CC	55	2252	08CC	210	8600	2198
-40	-1640	F998	60	2456	0998	220	9012	2334
-35	-1432	FA68	65	2664	0A68	230	9420	24CC
-30	-1228	FB34	70	2868	0B34	240	9832	2668
-25	-1024	FC00	75	3072	0C00	250	10240	2800
-20	-820	FCCC	80	3276	0CCC	260	10648	2998
-15	-616	FD98	85	3480	0D98	270	11060	2B34
-10	-408	FE68	90	3686	0E68	280	11468	2CCC
-5	-204	FF34	95	3892	0F34	290	11880	2E68
0	0	0000	100	4096	1000	300	12288	3000
5	204	00CC	110	4504	1198	310	12696	3198
10	408	0198	120	4916	1334	320	13108	3334
15	616	0268	130	5324	14CC	330	13516	34CC
20	820	0334	140	5736	1668	340	13928	3668
25	1024	0400	150	6144	1800	350	14336	3800
30	1228	04CC	160	6552	1998	360	14744	3998
35	1432	0598	170	6964	1B34	370	15156	3B34
40	1640	0668	180	7372	1CCC	380	15564	3CCC
45	1844	0734	190	7784	1E68	390	15976	3E68
						400	16384	4000
						410	16792	4198
						> 410	32767	7FFF

Technical Data

07 EA 66 R1

Number of channels per module

8

Electrical isolation

yes, between input circuitry and bus.

There is no electrical isolation between channels.

Nominal insulation voltage, process terminals versus subrack and internal connections:

according to VDE 0160

60 V AC

tested with

500 V AC

Input data

measuring range

-50 %...400 % corresponds to

-50°C...400°C

(Pt 100 sensor resistance 80.31 Ω...247.04 Ω)

hexadecimal representation after hardware

conversion (see Table 8.7.3)

F800_H...4000_H, corresp. to -50 %...400 % or °C

significance of the bits in the HEX code see Table 8.7.2

conversion, if measured value is out of range

measured temperature < -51°C

7FFF_H or 32767 decimal

measured temperature > +410°C

7FFF_H or 32767 decimal

resolution (1 LSB)

approx. 0.1 K

Total line resistance permissible of current-carrying lines (forward and backward), (see also description "Connection of the resistance thermometers")	max. 50 Ω per sensor (with four-wire configuration)																											
Evaluation inaccuracy of the module (includes all inaccuracies caused by linearity, linearization, ambient temperature range, resolution, constant-current source, adjustment)																												
measuring range 0 ... 100 °C	± 0.6 °C																											
measuring range -50 ... 150 °C	± 1.2 °C																											
measuring range 0 ... 400 °C	± 2.4 °C																											
Constant-current value for Pt 100 sensor	2 mA																											
Power dissipation in the Pt 100 sensor, caused by the current of 2 mA,																												
measured value = 0 °C	0.4 mW																											
measured value = 400 °C	1.0 mW																											
Conversion rate	1 s																											
(one conversion of each of the 8 channels)																												
Open-circuit voltage of current source output	approx. 12 V																											
What to do with an unused channel	short-circuit all 4 terminals of channel																											
Behaviour of the module, if there is a break on the constant-current loop (2 mA)	conversion to 7FFF _H or 32767 decimal																											
Measuring evaluation, if there is a break on a measuring line of the Pt 100 sensor	conversion to 7FFF _H or 32767 decimal																											
Measuring evaluation of an unused channel	conversion to 7FFF _H or 32767 decimal																											
Supply current from internal voltages																												
UB1 = 5 V DC	max. 160 mA																											
UB4 = 24 V DC	max. 100 mA																											
Power dissipation	max. 3.2 W																											
Cable length, if cables have been laid parallel in cable duct, shielded	max. 50 m																											
two-core shielded and cross section ≥ 0.5 mm ²	max. 200 m																											
Conductor cross section of process terminals	max. 1.5 mm ²																											
Signalling of the input signals	no signalling																											
Number of required slots	1 I/O slot																											
Number of occupied I/O points	128																											
Configuration identifier in 907 PC 32	EW8																											
Ability of fitting in subracks																												
slots, ● = plug-in is possible	<table border="1" style="border-collapse: collapse; text-align: center; width: 100%;"> <tr> <td colspan="3">BT</td> <td colspan="3">BE-central</td> <td colspan="3">BE-remote</td> </tr> <tr> <td>NG</td><td>ZE</td><td>I/O</td> <td>NG</td><td>BV</td><td>I/O</td> <td>NG</td><td>BV</td><td>I/O</td> </tr> <tr> <td></td><td></td><td>●</td> <td></td><td></td><td>●</td> <td></td><td></td><td>●</td> </tr> </table>	BT			BE-central			BE-remote			NG	ZE	I/O	NG	BV	I/O	NG	BV	I/O			●			●			●
BT			BE-central			BE-remote																						
NG	ZE	I/O	NG	BV	I/O	NG	BV	I/O																				
		●			●			●																				
Weight	500 g																											
Order number	GJV 3074 354 R1																											

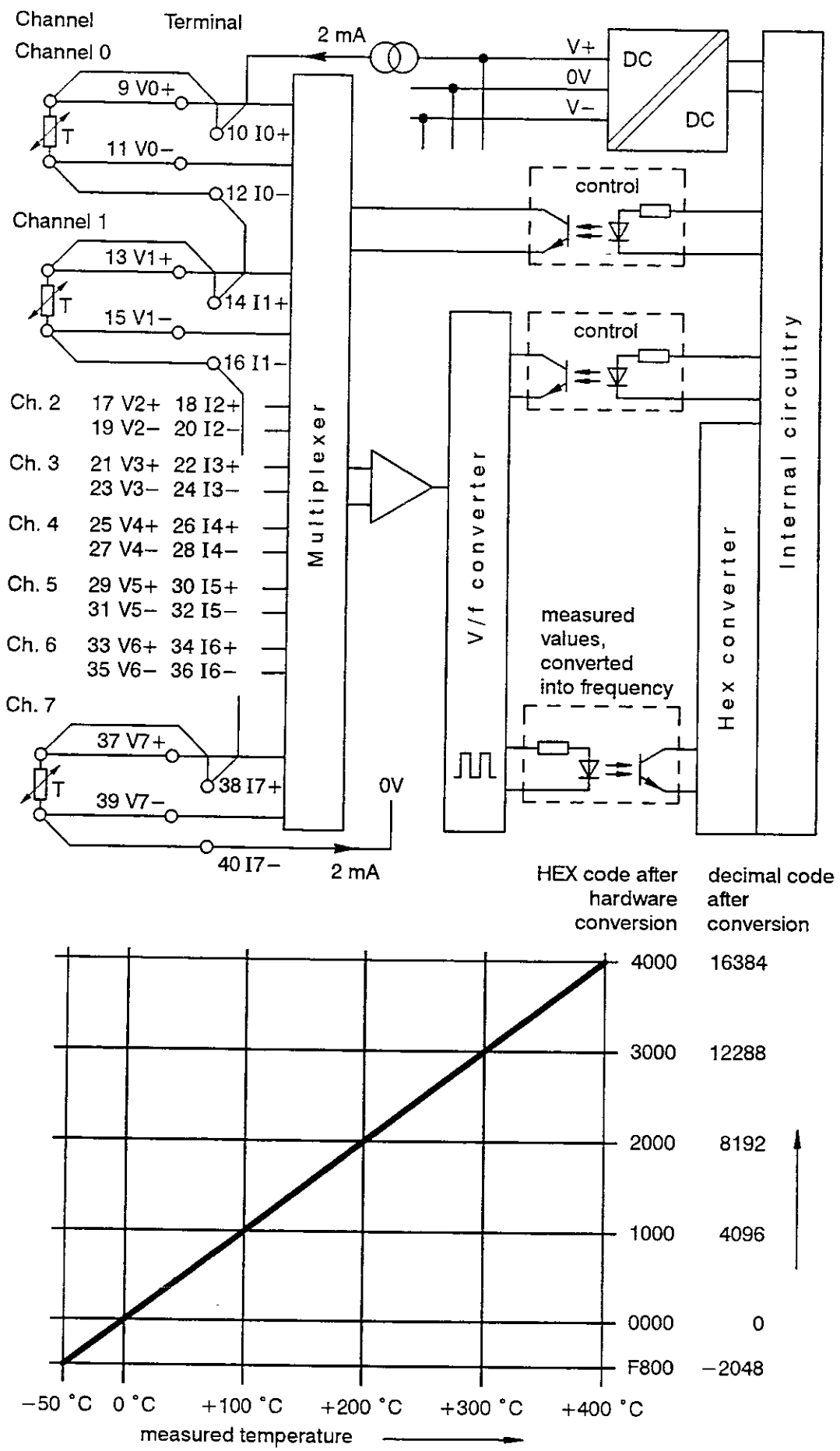
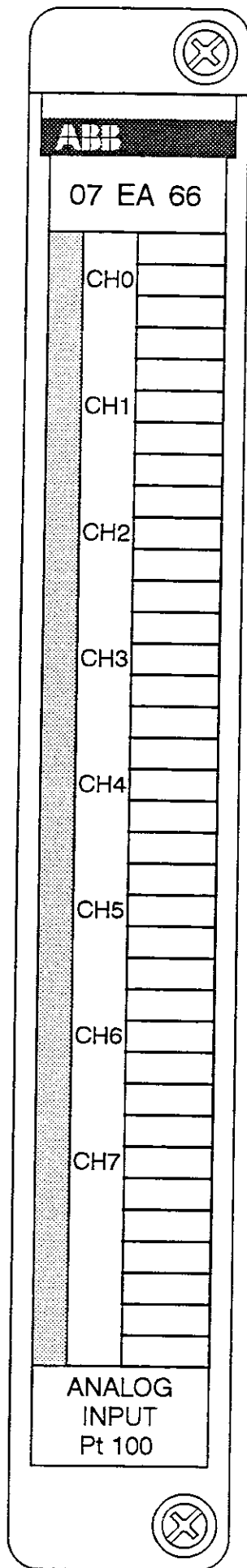

Fig. 8.7.7: 07 EA 66, Input circuitry, terminal assignment and conversion diagram of channels

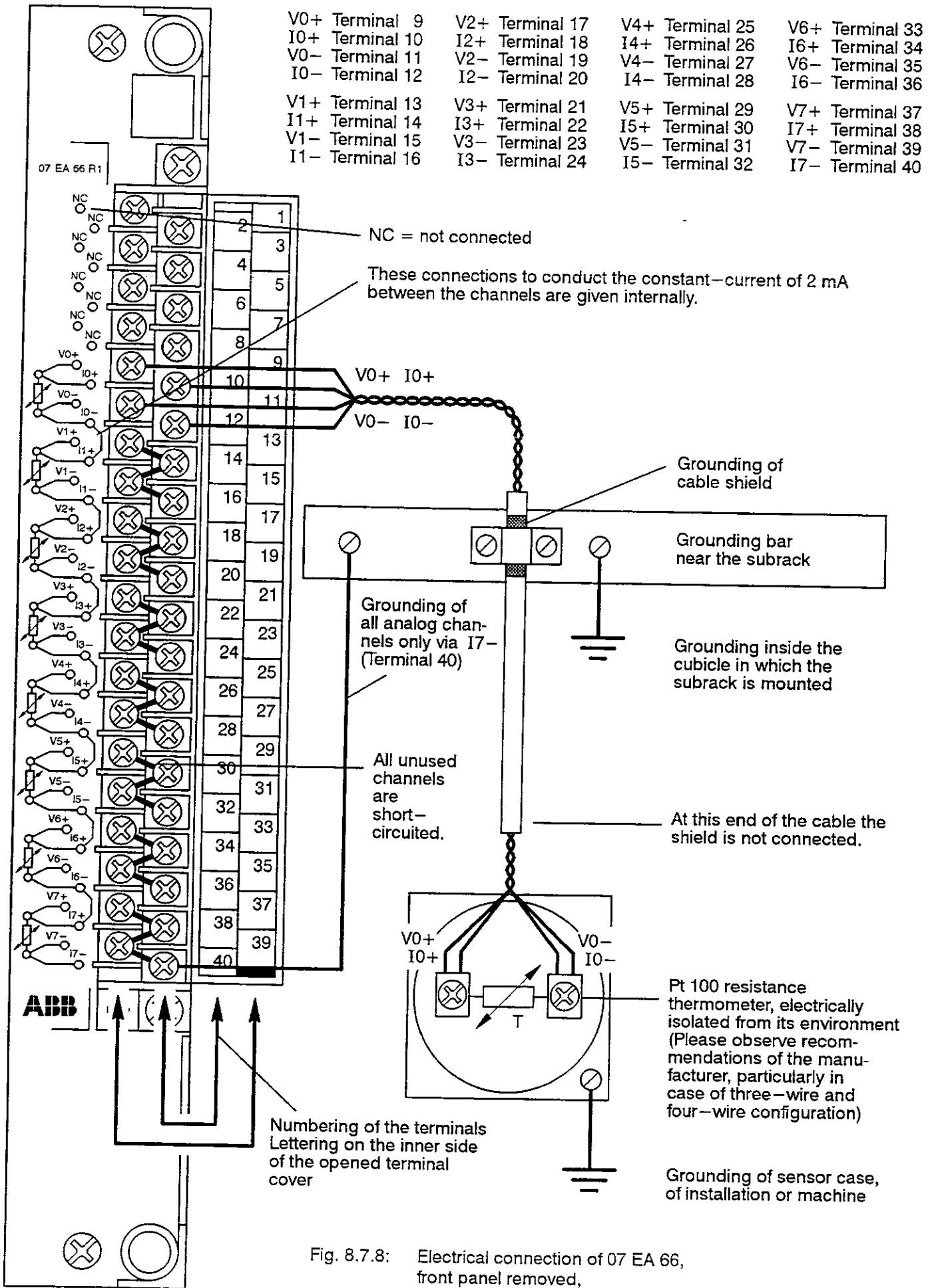

Fig. 8.7.8: Electrical connection of 07 EA 66, front panel removed, terminal cover opened

8.8 Analog Input Module 07 EA 67 R1

for thermocouples, 0 °C...+1600 °C, 13 bits, 8 channels, electrically isolated

Characteristics

The 07 EA 67 analog input module evaluates the thermal Emf values (thermo-electromotive forces) of 8 thermocouples with a resolution of 13 bits. The 8 channels of the module can be set simultaneously to one of the following thermocouple types (according to IEC 584):

Type	Thermocouple wires	Measuring range
J	Iron / Copper–Nickel	0...1200 °C
K	Nickel–Chromium / Nickel–Aluminium	0...1372 °C
S	Platinum–10 % Rhodium / Platinum	0...1600 °C

The linearization between the thermal Emf and the temperature is performed inside the module. A separate sensor is used to compensate the temperature of the reference junction.

There is an electrical isolation between the input circuitry and internal supply voltages (bus voltages). The 8 channels are not isolated among one another. In order to avoid grounding loops and effects on interference voltages only such thermocouples can be employed that are electrically isolated from their environments.

Note: Since L type thermocouples (Iron/constantan, Fe–CuNi according to DIN 43710) are similar to J type thermocouples, they also can be used in the temperature range of 0...900 °C. The slightly greater thermal Emf generated by the L type thermocouple, however, pretends a little higher temperature. The following table illustrates this fact (all temperature data is referred to a reference temperature of 0 °C):

Temperature at the measuring point	Temperature evaluated by the module, if an L type thermocouple is used instead of a J type thermocouple
25 °C	25.63 °C
50 °C	51.23 °C
100 °C	101.89 °C
200 °C	203.13 °C
400 °C	405.69 °C
600 °C	609.78 °C
900 °C	920.41 °C

Measured value acquisition and conversion

Both the thermocouples and the separate sensor (placed at the reference junction) are connected bipolarly to the 07 EA 67 module. The thermal Emf values are scanned one after another (in the multiplex method). After compensation by the measured value from the reference junction sensor they are amplified and then converted in two steps: as voltage/frequency conversion before the electrical isolation and as conversion into HEX

code after transmission via optocouplers. The linearization is performed digitally.

The relationship between the measured temperature, the thermal Emf values of the J, K and S type thermocouples, the converted HEX code and the corresponding decimal equivalent is shown in the following table. Furthermore the table indicates, that the converted HEX code becomes 7FFF_H, if the upper end of the measuring range is reached or exceeded, and becomes 0000_H, if the lower end of the measuring range is reached or underflowed. 7FFF_H thus means the error message "Upper end of range is reached or exceeded", and 0000_H means "Lower end of range is reached or underflowed", respectively.

Temperature measured	Thermal Emf value at a reference temperature of 0 °C			Converted HEX code	Decimal equivalent
	J type mV	K type mV	S type mV		
< 0 °C	< 0	< 0	< 0	0000	0
0 °C	0	0	0	0000	0
+ 1 °C	0.050	0.039	0.005	0014	20
+ 25 °C	1.277	1.000	0.142	0200	512
+ 50 °C	2.585	2.022	0.299	0400	1024
+ 100 °C	5.268	4.095	0.645	0800	2048
+ 200 °C	10.777	8.137	1.440	1000	4096
+ 400 °C	21.846	16.395	3.260	2000	8192
+ 600 °C	33.096	24.902	5.237	3000	12288
+ 800 °C	45.498	33.277	7.345	4000	16384
+1000 °C	57.942	41.269	9.585	5000	20480
Typ J +1200 °C >1200 °C	69.536			7FFF 7FFF	32767 32767
Typ K +1200 °C +1372 °C >1372 °C		48.828 54.875		6000 7FFF 7FFF	24576 32767 32767
Typ S +1200 °C +1372 °C +1400 °C +1600 °C >1600 °C			11.947 14.028 14.368 16.771	6000 6DC3 7000 7FFF 7FFF	24576 28099 28672 32767 32767

Table 8.8.1: Relationship between temperature and converted HEX code. In addition the evaluation at the ends of the measuring range is shown.

The ANAI (or ANAI1) function block cannot be used for this module and is not necessary either. After the conversion inside the module the HEX code required for the system is already present.

The temperature and the HEX code (and decimal equivalent) are linear to each other (as shown in Table 8.8.1). A fixed significance is assigned to each bit in the HEX code in relation to the temperature (Table 8.8.2).

Bit significance		Bit significance	
Bit 15	- 1600 K	Bit 7	+ 6.25 K
Bit 14	+ 800 K	Bit 6	+ 3.125 K
Bit 13	+ 400 K	Bit 5	+ 1.563 K
Bit 12	+ 200 K	Bit 4	+ 0.781 K
Bit 11	+ 100 K	Bit 3	+ 0.391 K
Bit 10	+ 50 K	Bit 2	+ 0.195 K
Bit 9	+ 25 K	Bit 1	+ 0.098 K
Bit 8	+ 12.5 K	Bit 0	+ 0.049 K

1 K = 1 Kelvin (temperature change by 1 degree)

Table 8.8.2: Significances of the bits in the HEX code, related to 0 °C

If the significance of the bits set to 1 are summed up, the result will be the measured temperature in °C.

Presettings on the module

Before the module is inserted into the subrack the type of thermocouple used has to be set. For this purpose, the printed circuit board has three coding jumpers of which one must be short-circuited. The following figure shows the jumper position to be selected depending on the used thermocouple type.

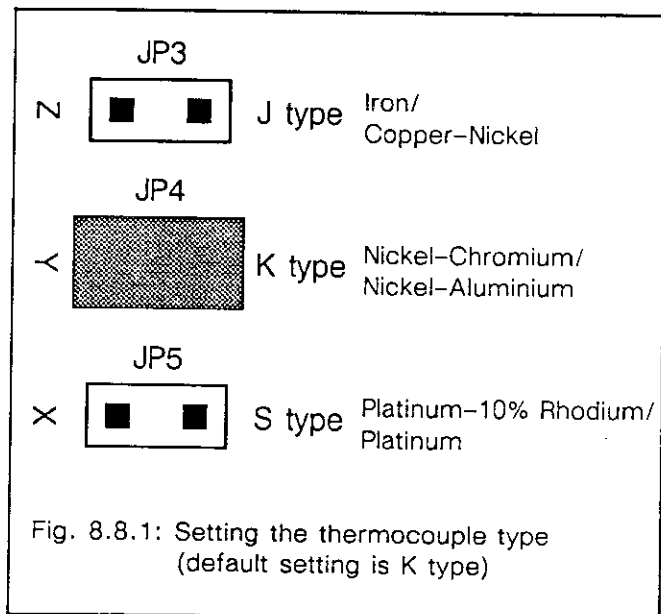

Another jumper allows to switch over between 4 or 8 working channels. As shown in the following figure, the jumper should basically remain in the "8-channels" position (default setting).

The position of all jumpers is depicted in Fig. 8.8.3.

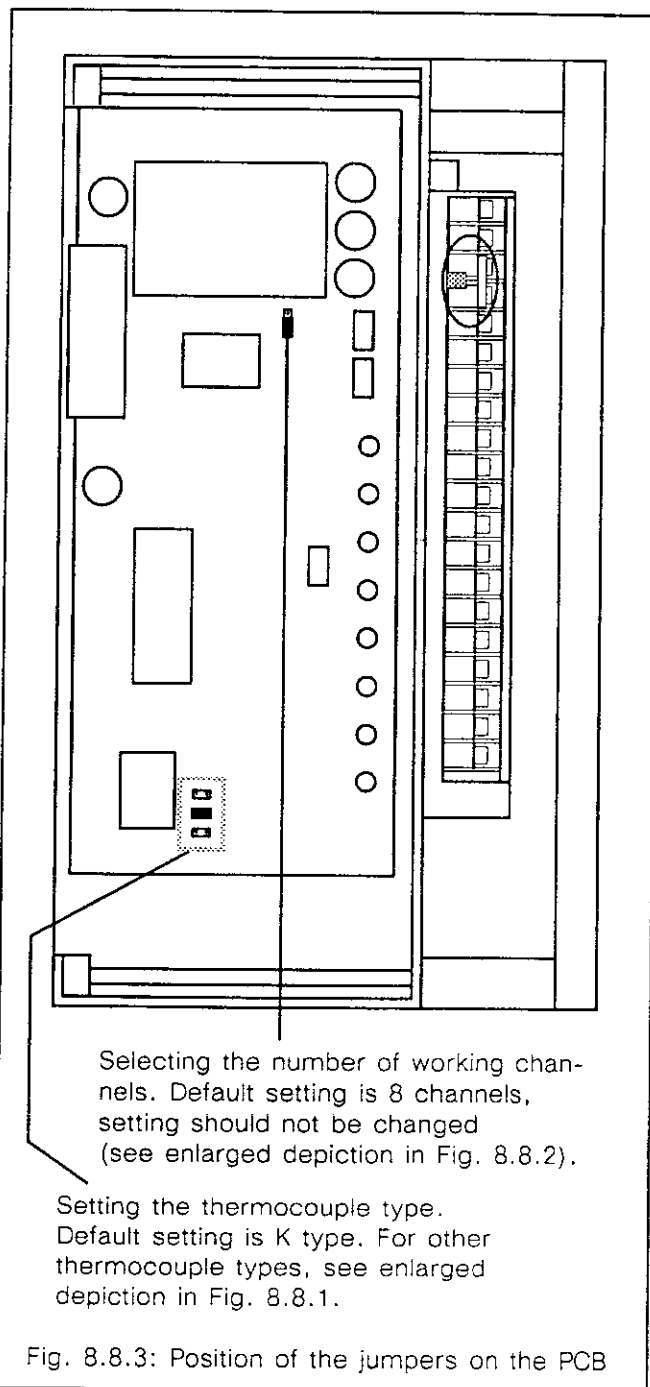
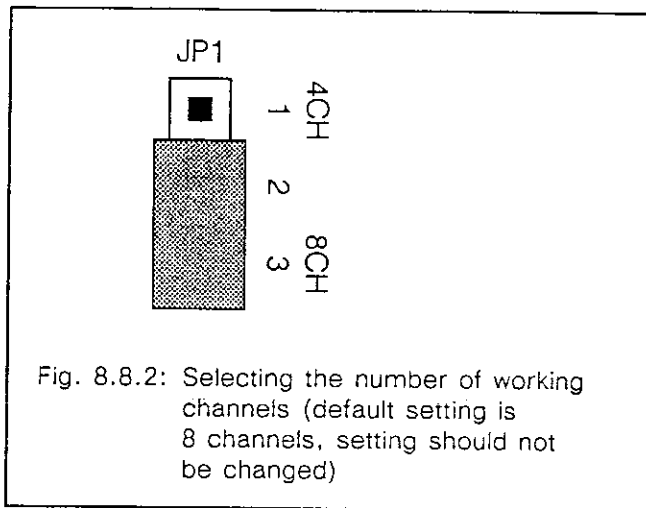

Connection of thermocouples and reference junction temperature sensor

Both the thermocouples and the sensor (placed at the reference junction) are connected bipolarly to the 07 EA 67 module.

If the distance between the temperature measuring point and the 07 EA 67 analog input module is short, the thermoelectric wires are connected directly to the module's terminals. In this case, the terminal block is also the temperature reference junction, and the reference junction temperature sensor is mounted directly at the terminals 3 and 4. (This is the state of delivery. The sensor is supplied with the module, see the following figure.)

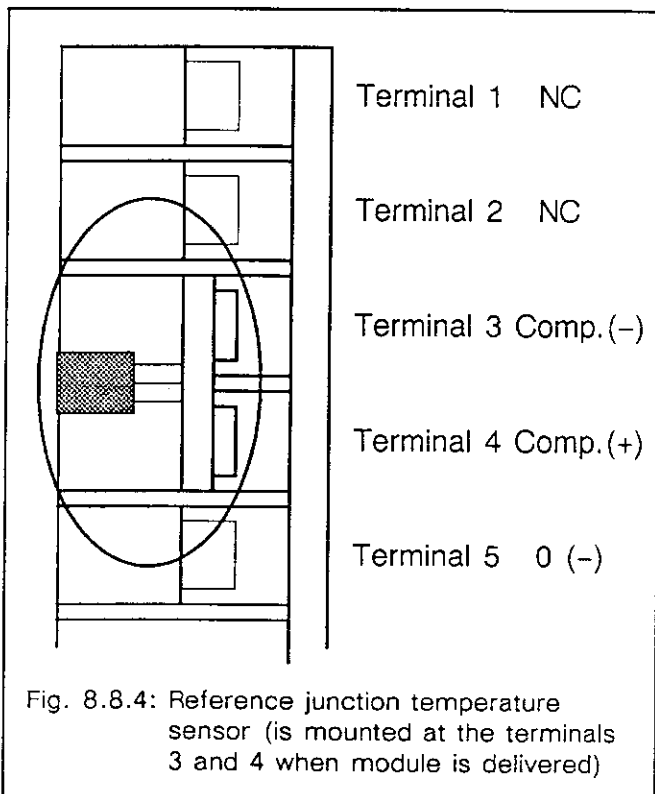

With a longer distance between the temperature measuring point and the 07 EA 67 analog input module it is sensible to install the reference junction near the thermocouples. In this case, copper wires can be used in the transmission cables (with less costs and more simple installation). **The reference junction sensor now has to be placed at the reference junction outside the module (see Fig. 8.8.5).** Within the reference junction, all terminals as well as the reference junction temperature sensor have to be at the same temperature.

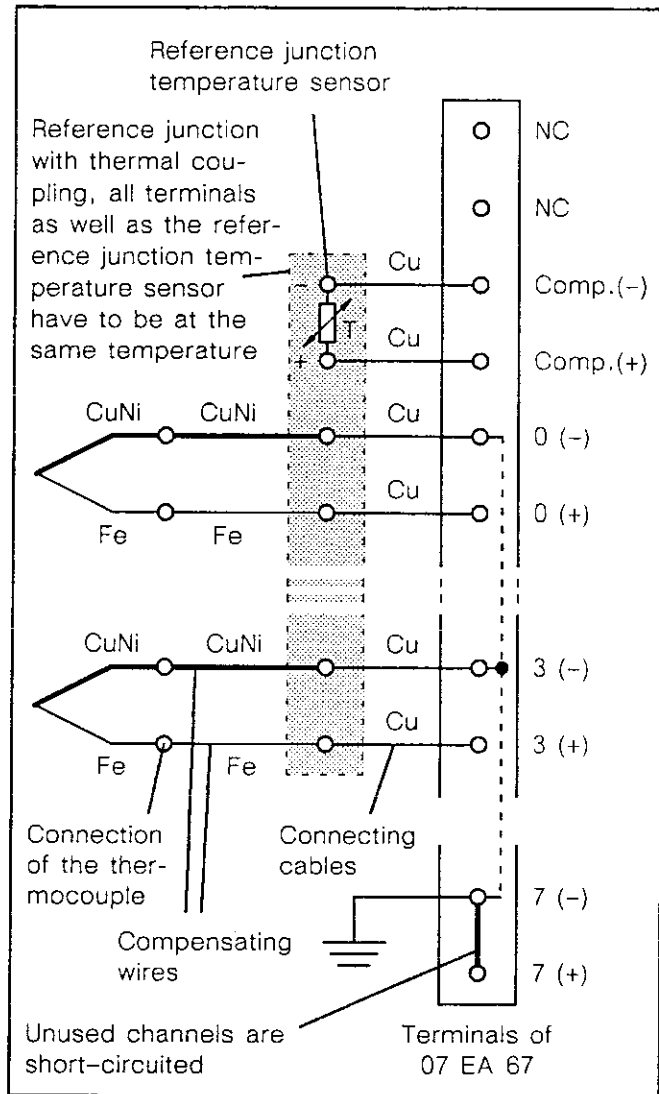

Fig. 8.8.5: Connection of thermocouples (e.g. Fe/CuNi, J type)

The input resistances of the measuring channels for the thermocouples (terminals 0(-), 0(+)...7(-), 7(+)) are very high, thus the voltage drops at the measuring lines are negligible. The resistance of the wires to the reference junction sensor is also not critical, because the sensor operates with a constant current which is dependent on the temperature. Thus the voltage drops cause no effect.

Under no circumstances, the polarity of the thermocouples must be confused. Otherwise large measuring faults are the result. Polarity (+ and -) of the thermocouple wires is assigned as follows:

Type Polarity of the thermocouple wires

J	+ Iron	- Copper-Nickel
K	+ Nickel-Chromium	- Nickel-Aluminium
S	+ Platinum-10% Rhodium	- Platinum

The polarity of commercially available thermocouples often is indicated with colors. Since color indication is not unified (red does not always mean +), care has to be taken to precisely follow the manufacturer's specifications.

The reference junction (see Fig. 8.8.5) ensures a thermal coupling of all thermocouple connections. In order to perform the compensation in the 07 EA 67 module, the current reference junction temperature is measured by means of a separate temperature sensor. In order to simplify the depiction, this sensor is drawn as a temperature dependent resistor. Actually, however, it consists of a semiconductor circuitry which generates a constant current (current source) linearly dependent on temperature and operating with high accuracy.

Care has to be taken to connect the sensor with the correct polarity, otherwise it will not operate at all. In addition, both a broken wire and a short-circuited sensor cable cause a heavy misrepresentation of the measured values of all channels, thus they are no longer valid.

If the ends of the thermocouple wires cannot be connected directly to the reference junction, compensating wires will be required. These wires have to be either of the same material as the thermocouples themselves or at least they must have the same physical properties within the temperature range they are used. For connection to thermocouples made of precious metals there exist less expensive compensating wires (made of base metals) as an alternative.

All terminals of the thermocouple channels marked with (-) are connected together inside the 07 EA 67 module (see Fig. 8.8.5). This common potential has to be grounded near the module.

The connecting cables between the reference junction and the terminals of the analog input module are made of copper. Twisted and shielded cables are recommended. The shield is grounded at the module side together with the (-) terminals of the thermocouple channels.

The terminals of unused input channels must be short-circuited. At those channels the temperature of the reference junction is evaluated.

Conversion between temperature and internal numerical representation

It is possible to convert the temperature into the internal numerical representation and vice versa. In both cases 1 °C corresponds to the decimal value of 20.48.

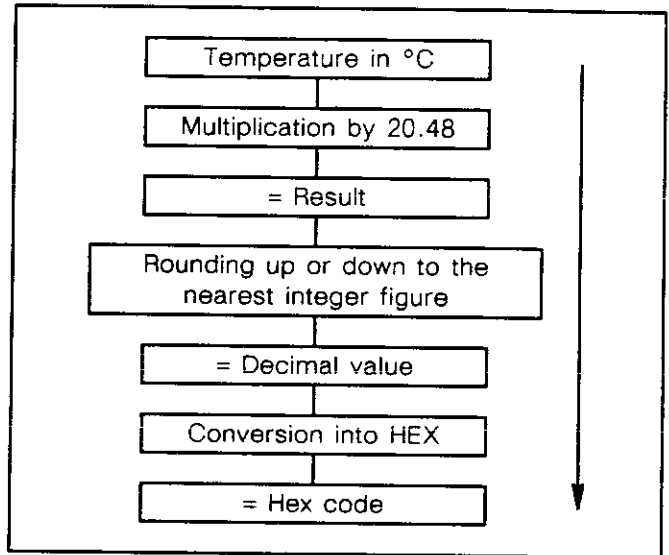

Fig. 8.8.6: Conversion between temperature and internal numerical representation

To get the decimal value, the temperature value (in °C) is first multiplied by 20.48. Then, it is rounded up or down to the nearest integer figure. The equivalent HEX code can be achieved by conversion.

Fig. 8.8.6 shows the flow diagram.

If the HEX code is given and the temperature is to be found, the calculation method has to be used the other way round (Fig 8.8.7).

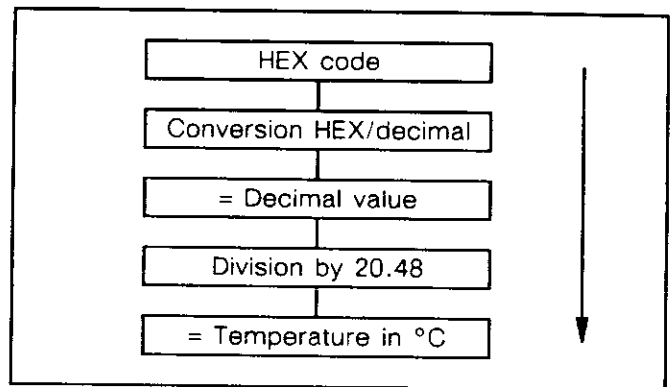

Fig. 8.8.7: Conversion between HEX code and temperature

For the HEX representation all 15 bits of the HEX code (bits 0...14 for positive significance according to Table 8.8.2) are used. Bit 15 is always 0. Considering the different stages of processing of the measured values (e.g. voltage/frequency converter, digital linearization and so on) the resolution amounts to 13 bits.

The following table 8.8.3 was created using the calculation method according to Fig. 8.8.6.

Table 8.8.3: Conversion between temperature and internal numerical representation

Temp. in °C	Dec. value	HEX code	Temp. in °C	Dec. value	HEX code	Temp. in °C	Dec. value	HEX code
< 0	0	0000 *	250	5120	1400	Typ J		
0	0	0000 *	300	6144	1800	1200	32767	7FFF **
0.2	4	0004	350	7168	1C00	> 1200	32767	7FFF **
5	102	0066	400	8192	2000	Typ K		
10	205	00CD	450	9216	2400	1200	24576	6000
20	410	019A	500	10240	2800	1250	25600	6400
30	614	0266	550	11264	2C00	1300	26624	6800
40	819	0333	600	12288	3000	1350	27648	6C00
50	1024	0400	650	13312	3400	1372	32767	7FFF **
60	1229	04CD	700	14336	3800	> 1372	32767	7FFF **
70	1434	059A	750	15360	3C00	Typ S		
80	1638	0666	800	16384	4000	1200	24576	6000
90	1843	0733	850	17408	4400	1250	25600	6400
100	2048	0800	900	18432	4800	1300	26624	6800
120	2458	099A	950	19456	4C00	1350	27648	6C00
140	2867	0B33	1000	20480	5000	1400	28672	7000
160	3277	0CCD	1050	21504	5400	1450	29696	7400
180	3686	0E66	1100	22528	5800	1500	30720	7800
200	4096	1000	1150	23552	5C00	1550	31744	7C00
						1600	32767	7FFF **
						> 1600	32767	7FFF **

* 0000 indicates that the lower end of the measuring range has been reached or underflowed

** 7FFF indicates that the upper end of the measuring range has been reached or exceeded

Technical Data

07 EA 67 R1

Number of channels per module	8
Electrical isolation	yes, between input circuitry and bus. There is no electrical isolation between channels.
Nominal insulation voltage, process terminals versus subrack and internal connections:	
according to VDE 0160	60 V AC
tested with	500 V AC
Usable thermocouples *) (according to IEC 584)	J type (Jumper Z) Iron / Copper-Nickel = Fe-CuNi K type (Jumper Y) Nickel-Chromium / Nickel-Aluminium = NiCr-NiAl S type (Jumper X) Platinum-10 % Rhodium / Platinum = Pt10Rh-Pt
Measuring range of the thermocouples	J type 0 °C...1200 °C K type 0 °C...1372 °C S type 0 °C...1600 °C
Temperature compensation at the reference junction	with a separate temperature sensor (Sensor is supplied with the module.)
Input data	
measuring range	
0 %...800 % corresponds to	0 °C...1600 °C
hexadecimal representation after hardware-conversion (see Table 8.8.3)	0000 _H ...7FFF _H , corresponding to 0 %...800 % or 0 °C...1600 °C
significance of the bits in the HEX code	see Table 8.8.2

*) The module can be set to J, K and S type thermocouples by means of jumpers. All 8 channels, however, must be connected to thermocouples of the same type.

hardware conversion at the ends of measuring range																													
measured temperature	0 °C	0000 _H or 0 decimal																											
measured temperature	+1200 °C Typ J	7FFF _H or 32767 decimal																											
measured temperature	+1372 °C Typ K	7FFF _H or 32767 decimal																											
measured temperature	+1600 °C Typ S	7FFF _H or 32767 decimal																											
hardware conversion, if measuring range is underflowed or exceeded																													
measured temperature	< 0 °C	0000 _H or 0 decimal																											
measured temperature	>1200 °C Typ J	7FFF _H or 32767 decimal																											
measured temperature	>1372 °C Typ K	7FFF _H or 32767 decimal																											
measured temperature	>1600 °C Typ S	7FFF _H or 32767 decimal																											
hardware conversion in case of a broken wire of a thermocouple		7FFF _H or 32767 decimal (at the involved channel)																											
Resolution (13 bits)		approx. 0.2 K																											
Evaluation inaccuracy of the module (includes all inaccuracies caused by linearity, linearization, ambient temperature range, resolution, constant-current source of the reference junction sensor, adjustment)																													
measuring range	0 ... 100 °C	± 0.6 °C																											
measuring range	0 ... 400 °C	± 1.2 °C																											
measuring range	0 ... 1600 °C	± 2.4 °C																											
Constant-current value of the reference junction sensor		1 µA/K (273 µA at 0°C)																											
Conversion rate (one conversion of each of the 8 channels)		1 s																											
What to do with an unused channel		short-circuit both terminals of channel																											
Measuring evaluation of an unused channel		temperature value of the reference junction is converted																											
Supply current from internal voltages																													
UB1 =	5 V DC	max. 160 mA																											
UB4 =	24 V DC	max. 100 mA																											
Power dissipation		max. 3.2 W																											
Cable length, if cables have been laid in parallel shielded		max. 50 m																											
two-core shielded and cross section ≥ 0.5 mm ²		max. 200 m																											
Conductor cross section of process terminals		max. 1.5 mm ²																											
Signalling of the input signals		no signalling																											
Number of required slots		1 I/O slot																											
Number of occupied I/O points		128																											
Configuration identifier in 907 PC 32		EW8																											
Ability of fitting in subracks																													
slots, ● = plug-in is possible		<table border="1" style="border-collapse: collapse; text-align: center;"> <thead> <tr> <th colspan="3">BT</th> <th colspan="3">BE-central</th> <th colspan="3">BE-remote</th> </tr> <tr> <th>NG</th> <th>ZE</th> <th>I/O</th> <th>NG</th> <th>BV</th> <th>I/O</th> <th>NG</th> <th>BV</th> <th>I/O</th> </tr> </thead> <tbody> <tr> <td></td> <td></td> <td>●</td> <td></td> <td></td> <td>●</td> <td></td> <td></td> <td>●</td> </tr> </tbody> </table>	BT			BE-central			BE-remote			NG	ZE	I/O	NG	BV	I/O	NG	BV	I/O			●			●			●
BT			BE-central			BE-remote																							
NG	ZE	I/O	NG	BV	I/O	NG	BV	I/O																					
		●			●			●																					
Weight		500 g																											
Order number		GJV 3074 358 R1																											

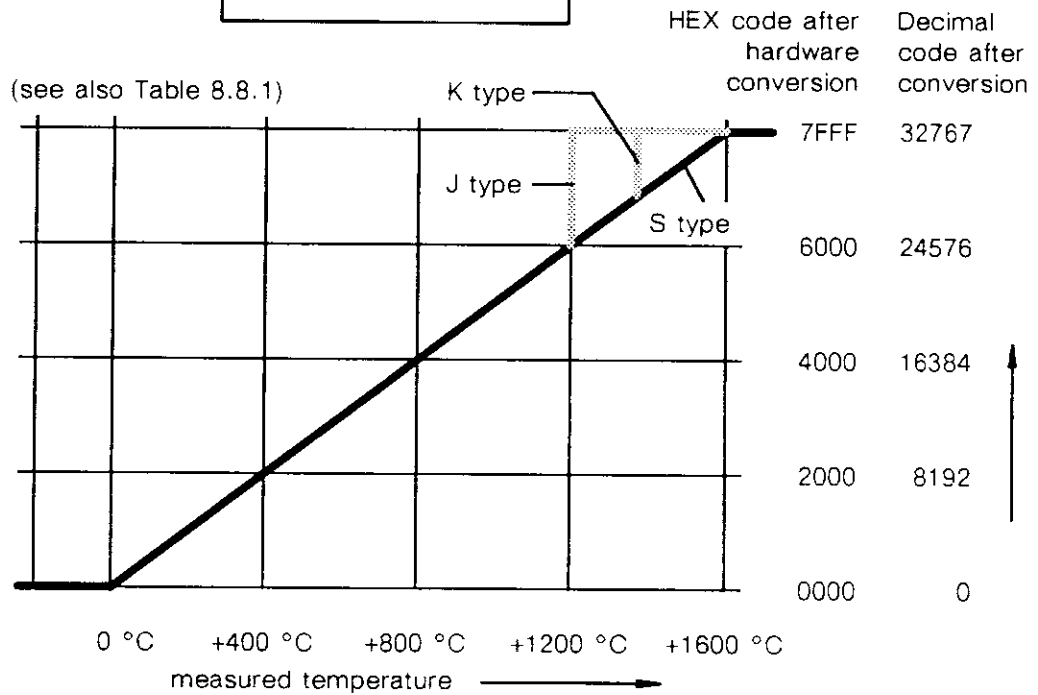
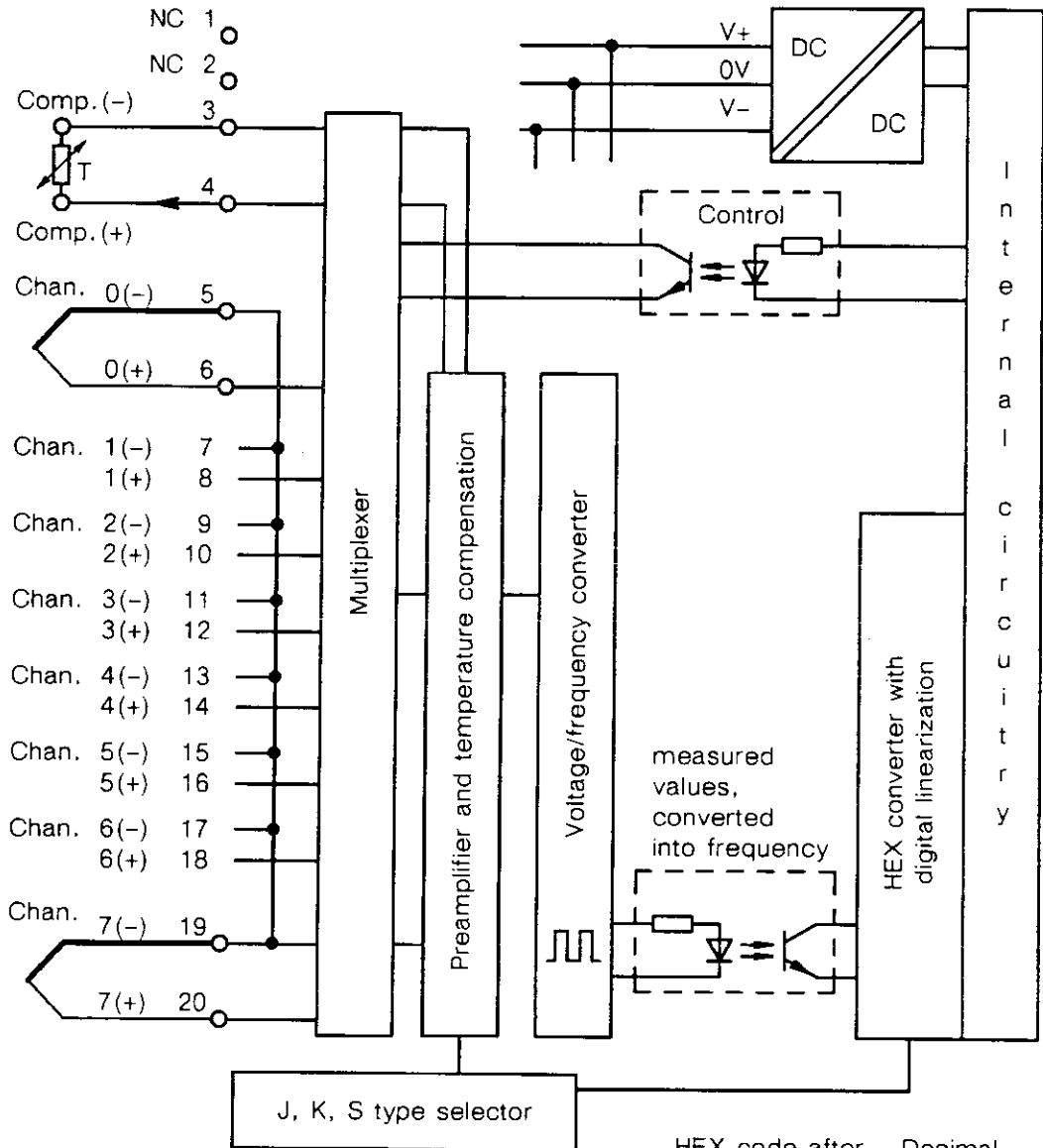
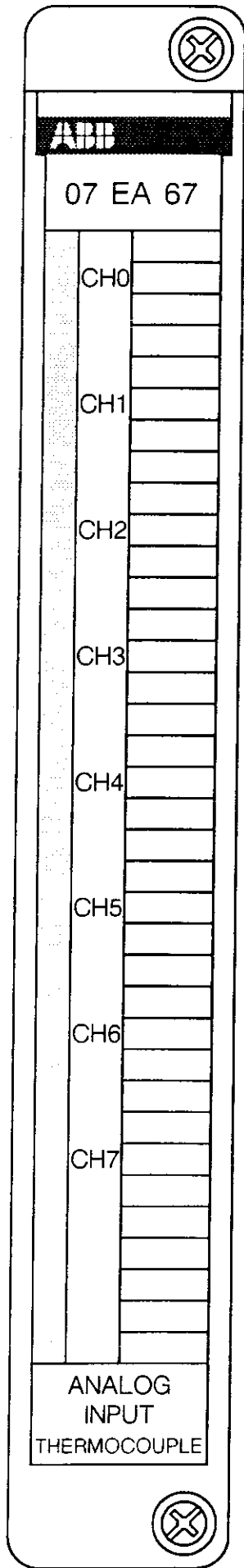

Fig. 8.8.8: 07 EA 67, Input circuitry, terminal assignment and conversion diagram of channels

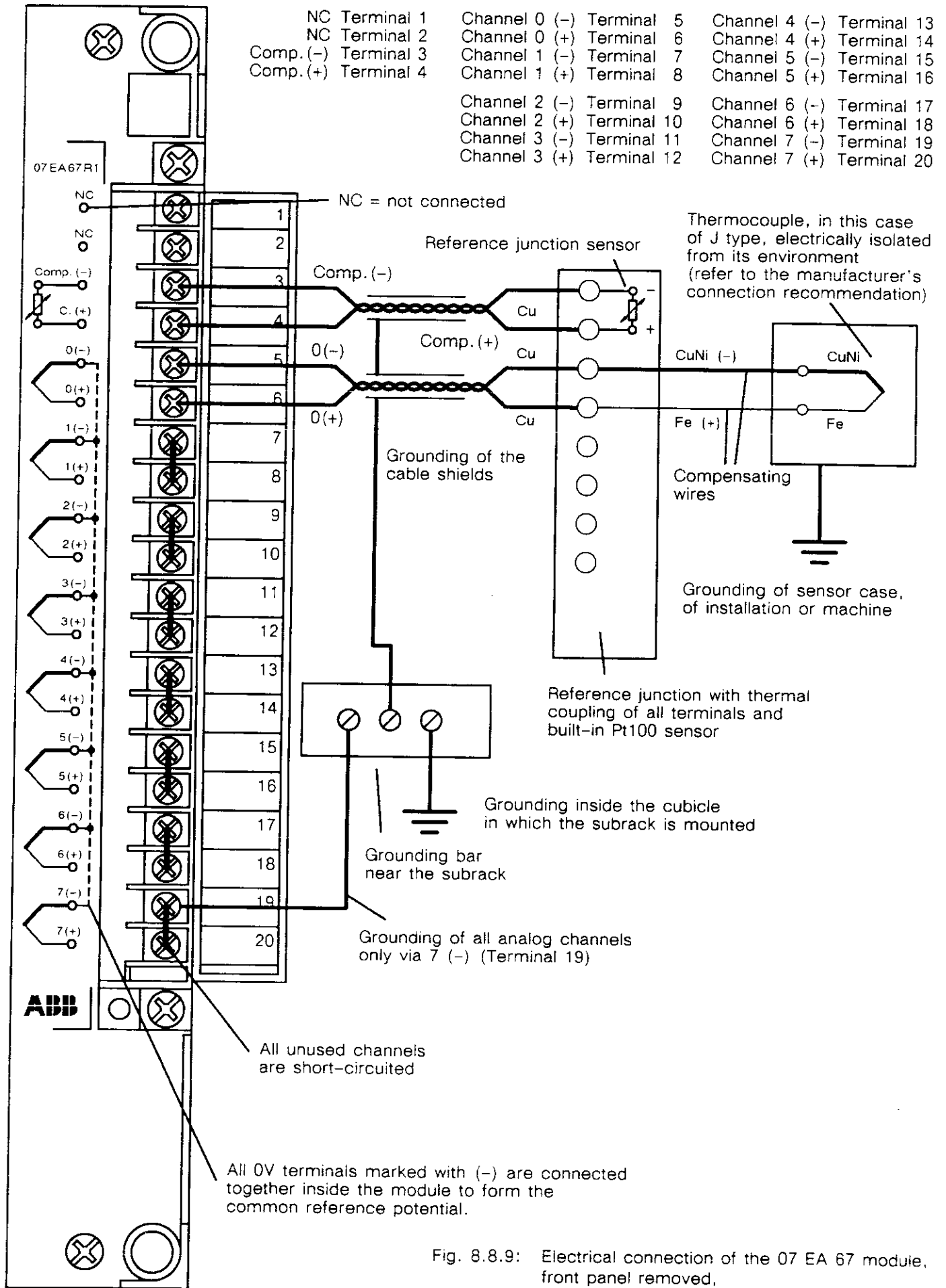

Fig. 8.8.9: Electrical connection of the 07 EA 67 module, front panel removed, terminal cover opened

9 Special Input Modules

07 EI 60 R1: Interrupt input module, 24 V DC, electrically isolated, 16 interrupt channels
07 ZG 60 R1: High-speed counter, 16 bits, 50 kHz

9.1 Interrupt Input Module 07 EI 60 R1

24 V DC, 16 interrupt channels, electrically isolated

Characteristics

The cyclic program processing of the PLC can be interrupted by time- or alarm-controlled program blocks. The Interrupt input module 07 EI 60 R1 is used for an alarm-controlled program interruption (external interrupt processing).

07 EI 60 R1 is a high-speed binary, electrically isolated input module with 16 interruption input channels for a rated signal voltage of 24 V DC. The module transforms the external process signals to the internal signal level of the PLC.

The minimum pulse width of the input signals is 1 ms. They have to be bounce-free in order to avoid unintended multiple interruptions.

The signal states of the process signals are displayed by green LEDs. The 0V reference potential is separately connected to 8 channels at a time.

An interruption is started edge-triggered when the input signal has changed from 0 to 1. After receiving an interrupt signal the central unit interrupts the cyclic processing after a defined time and executes the corresponding interrupt program. After finishing this program the central unit continues the processing from the previous interrupt point.

The repetition rate of interrupts must be less than the sum of all processing times of interrupts which may occur at the same time, plus the processing time of the used time-controlled program blocks.

Configuring

One central unit 07 ZE 60/61/62/63 is able to address only one Interrupt module 07 EI 60 R1. This module can be placed either in the basic subrack or in one of the expansion subracks of the central expansion. Mounting in a remote substation is not possible.

The input channels 0...15 are allocated to the software interrupt program blocks PB IB 16...31. The configuration of the Interrupt input module is performed by entering the configuration identifier EI 60 in the menu field 'configuration/system configuration' or automatically during 'read configuration'.

Interrupt Module

The interrupt program block is positioned after the main program ending with I PE and has following structure:

.	Main program
.	
I PE	End of main program
.	
I PB IB n	Begin of interrupt program block (16 < n < 31)
.	
.	Interrupt program block
.	
I IBE	End of interrupt program block
I SPE	

Error Handling

An interrupt error is detected when during the processing of an interrupt the same interrupt occurs again. The central unit then displays the error code 46, sets the internal bit flag M 125,03 and stops the program processing (ZE to STOP).

Such a stop of a program processing can be suppressed by setting the flag M 124,02. The flag M 124,02 which belongs to the special flag-area, indicates whether the central unit stops the processing or not after detecting an interrupt error. The state of the flag M 124,02 does not influence the display of the error code on the central unit. The bit flag M 124,02 is set to 0 after power-on reset (basic setting).

Priorities

The time-controlled program blocks TB 00/01/02 have higher priority than the external interrupt program blocks. If a time-controlled interrupt (see * in the timing diagram, figure 9.1.1, next page) occurs during an alarm-controlled interrupt processing, the latter will be interrupted and the time-controlled program block will be processed. After that the alarm-controlled processing will be continued.

If two or more alarm-controlled interrupts occur at the same time, the interrupt program blocks will be processed one after another in increasing order, beginning with the lowest interrupt number.

If during the processing of an interrupt program block a further interrupt occurs the second will be processed not until the processing of the first has been finished.

Example for an Interrupt Processing:

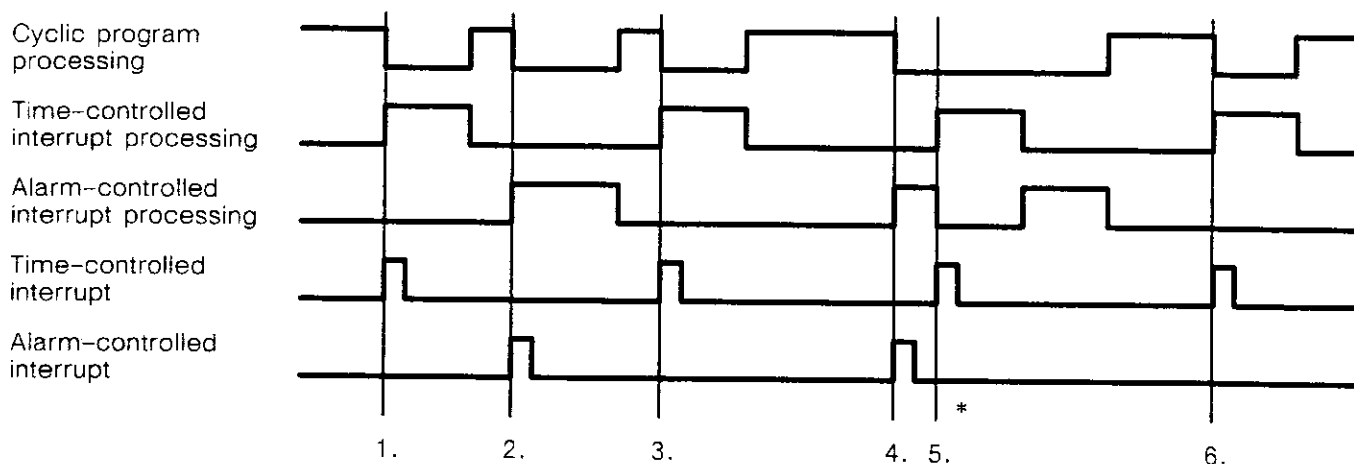

Fig. 9.1.1: Priorities of the interrupt processing, * see text 'Priorities' one page before

Occurrences 1. to 6. in Fig. 9.1.1:

1. Time-controlled interrupt triggers the time-controlled interrupt processing
2. Alarm-controlled interrupt triggers the alarm-controlled interrupt processing
3. like 1.
4. like 2.
5. The alarm-controlled interrupt processing is interrupted by an time-controlled interrupt and then continued after its finishing
6. like 1.

Timing Calculations

The reaction times to interrupt signals depend on the type of central unit which is used. Following times are measured from the rising edge of an interrupt signal to the begin of the processing of the interrupt program block with the highest priority.

$$T_R = (T_A + n \cdot T_{ZE}) + T_d$$

T_R = Reaction time

T_A = Interrupt analysis time

T_{ZE} = Interrupt detection time

T_d = Input signal delay 07 EI 60

n = Number of input channel ($0 < n < 15$)

07 ZE 60/61,

$$07 ZE 63: \quad T_R = (700 + n \cdot 7) \mu s + 1.000 \mu s$$

$$07 ZE 62: \quad T_R = (600 + n \cdot 3.5) \mu s + 1.000 \mu s$$

Technical Data

Number of inputs per module	16																											
Electrical isolation	in 2 groups of 8 inputs each, each group with separate reference potential ZP																											
Nominal insulation voltage, process terminals versus subrack, internal connections and other groups:	acc. VDE 0160 tested with																											
	60 V AC																											
	500 V AC																											
Process supply voltage, rated value	24 V DC																											
upper limit	30 V DC																											
Input signal level:	signal 0																											
	signal 1																											
	- 5 V...+ 5 V																											
	- 30 V...- 15 V, + 15 V...+ 30 V																											
Input resistance	approx. 4.7 kΩ																											
Input current																												
if UP1 = 24 V DC	approx. 5 mA																											
Input signal delay																												
signal edge 0 → 1	min. 0.15 ms																											
	max. 1.0 ms																											
signal edge 1 → 0	min. 0.9 ms																											
	max. 1.0 ms																											
Supply current from internal voltages																												
UB1 = 5 V DC	max. 0.12 A																											
UB4 = 24 V DC	no current consumption																											
Power dissipation	max. 6.5 W																											
Cable length, if cables have been laid parallel in cable duct:																												
shielded	max. 1000 m																											
unshielded	max. 600 m																											
Conductor cross section of process terminals	max. 1.5 mm ²																											
Signalling of the input signals	one green LED per channel																											
Number of required slots	1 I/O slot																											
Number of occupied I/O points	16																											
Configuration identifier in 907 PC 32	EI60																											
Ability of fitting in subracks																												
slots, ● = plug-in is possible	<table border="1" style="border-collapse: collapse; text-align: center;"> <thead> <tr> <th colspan="3">BT</th> <th colspan="3">BE-central</th> <th colspan="3">BE-remote</th> </tr> <tr> <th>NG</th> <th>ZE</th> <th>I/O</th> <th>NG</th> <th>BV</th> <th>I/O</th> <th>NG</th> <th>BV</th> <th>I/O</th> </tr> </thead> <tbody> <tr> <td></td> <td></td> <td>●</td> <td></td> <td></td> <td>●</td> <td></td> <td></td> <td></td> </tr> </tbody> </table>	BT			BE-central			BE-remote			NG	ZE	I/O	NG	BV	I/O	NG	BV	I/O			●			●			
BT			BE-central			BE-remote																						
NG	ZE	I/O	NG	BV	I/O	NG	BV	I/O																				
		●			●																							
Weight	360 g																											
Order number	GJV3074357R1																											

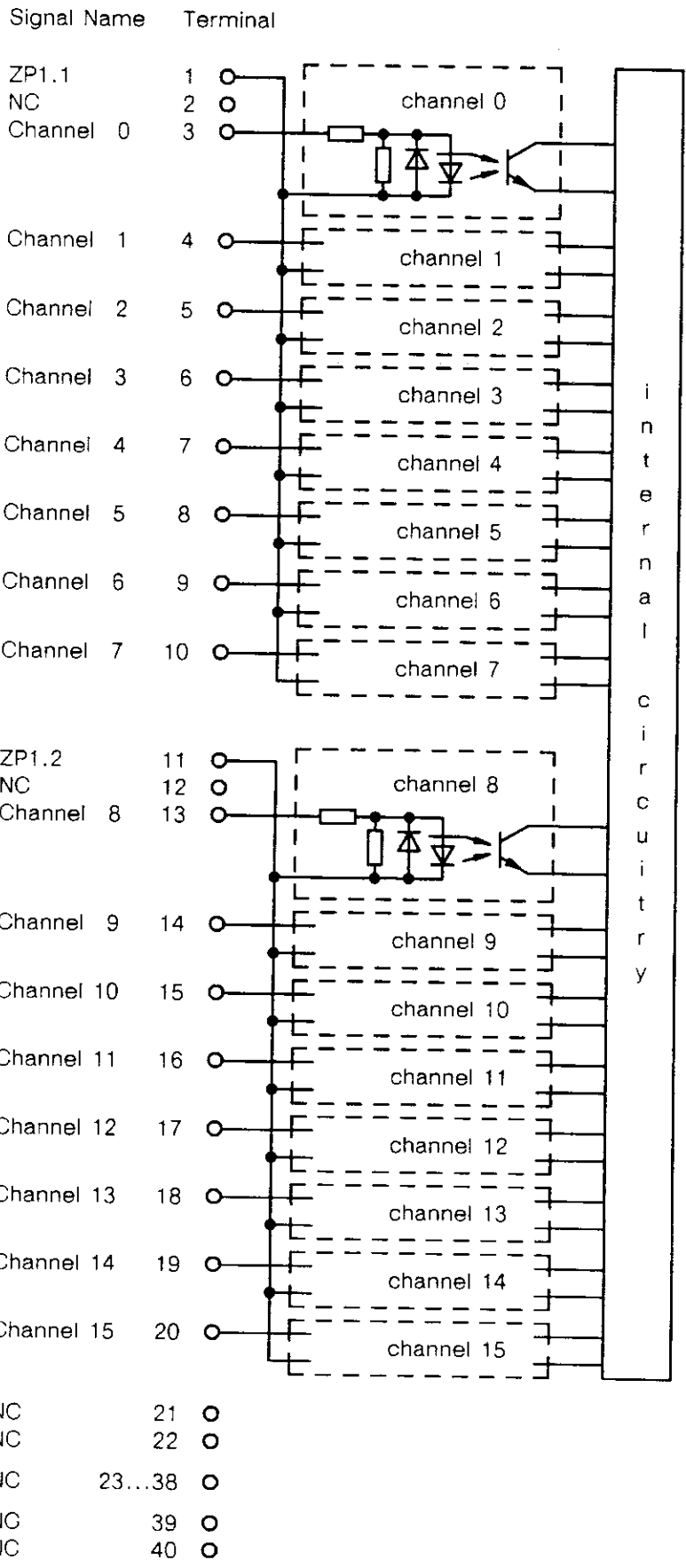
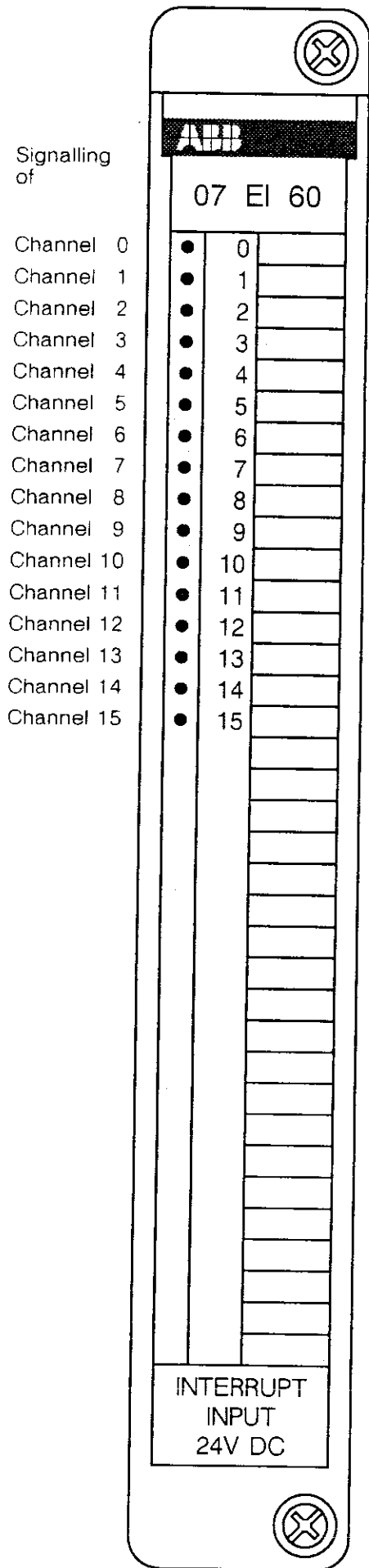

Fig. 9.1.2: 07 EI 60: Signalling, input circuitry, terminal assignment and signal names of channels

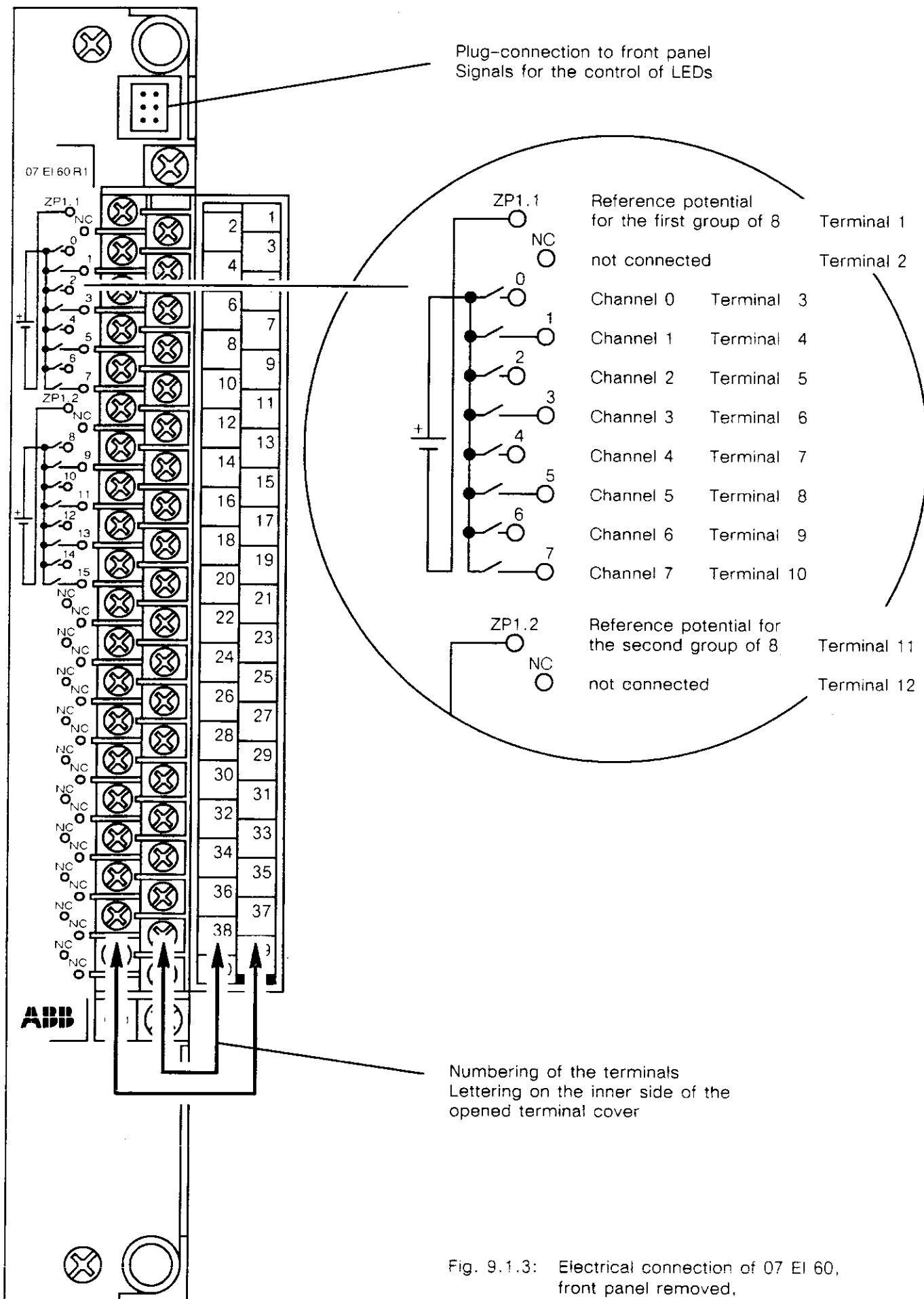

Fig. 9.1.3: Electrical connection of 07 EI 60, front panel removed, terminal cover opened

9.2 High-Speed Counter 07 ZG 60 R1

16 bits, 50 kHz

Characteristics

The high-speed counter 07 ZG 60 R1 includes a 16 bit up/down counter for counting frequencies up to 50 kHz. The counting range is 0...65,535 (0000...FFFF hexadecimal). The counter inputs can be used alternatively for 2-phase operation (where the signals are usually generated by pulse encoders) or 1-phase operation (where the counting direction has to be fixed using one of the counting inputs).

The high-speed counter includes 2 setting value registers, which can be loaded (range is 0000...FFFF) with the content of an operand or a constant. A built-in comparator compares the content of the count value register with both setting value registers.

The results of comparing (count value with 1. setpoint and count value with 2. setpoint) are displayed by two LEDs. Additionally these results are available as electrical signals (open collector, npn) at the outputs A1 and A2.

The internal counter can be set to a defined value or reset. You can read the actual count value from the count value register. The current count value is permanently displayed binary by 16 LEDs on the front panel.

The readable status register contains all comparing results as well as information about overflow and underflow of the counter (count value out of range).

Details about the mode of operation are contained in the control register. It has to be formatted (written) by the user.

The function capabilities are arranged as follows:

- Counting pulses up (using input K1)
- Counting pulses down (using input K2)
- 2-phase operation up/down (using inputs K1 and K2)
- Counter reset (edge-triggered), using reset input R
- Control register formatting (write)
- Counter preset to a defined value
- Loading 1. setpoint (SW1), lower threshold
- Loading 2. setpoint (SW2), higher threshold
- Reading and/or displaying count value
- Reading status register
- Comparing results to the outputs A1 and A2. By means of the entries, in the control register there is fixed whether the outputs show the states = or >.

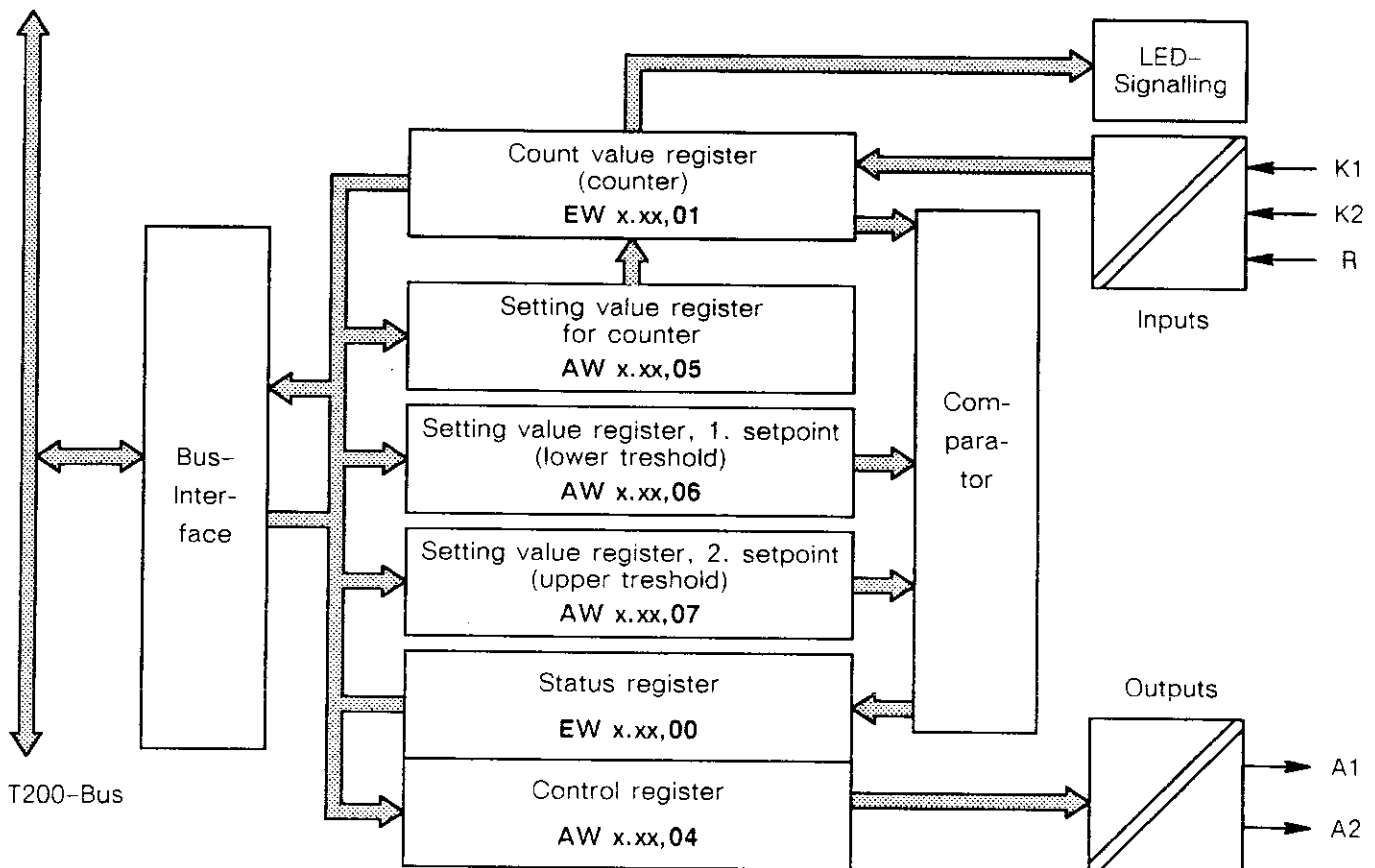

Fig. 9.2.1: Block diagram 07 ZG 60 R1

Registers

One high-speed counter occupies 8 words (16 bits each) of the address range. For the counting operation there are 8 registers which can be accessed by the central unit or be influenced by the input signals.

Please note that the contents of all registers (incl. count value) are set to 0, when the supply voltage has been switched on or the rotary switch RUN/STOP on the central unit has been changed.

Overview of the Registers

Register	Slot	Notation in 907 PC 32	Readable/writeable	Intended purpose	Assignment
R0	nml	EW n.ml,00	readable	status register	bit 0...bit 7
R1	nml	EW n.ml,01	readable	count value register (current value)	bit 0...bit 15
R2	nml	EW n.ml,02	readable	not used	
R3	nml	EW n.ml,03	readable	not used	
R4	nml	AW n.ml,04	writeable	control register	bit 0...bit 7
R5	nml	AW n.ml,05	writeable	setting value register for counter	bit 0...bit 15
R6	nml	AW n.ml,06	writeable	setting value register, 1. setpoint	bit 0...bit 15
R7	nml	AW n.ml,07	writeable	setting value register, 2. setpoint	bit 0...bit 15

n = No. of remote I/O line

m = No. of central expansion or

No. of remote substation

l = No. of slot

Register 0 (Status Register)

The status register shows the status of the count value register (counter) and the results of comparing. Only 'Read' is possible. The single bits have following meanings:

Bit 5 = 1	Count value is higher than setpoint 1 ¹⁾
Bit 4 = 1	Count value is equal to setpoint 1 ¹⁾
Bit 3 = 1	Count value is higher than setpoint 2 ¹⁾
Bit 2 = 1	Count value is equal to setpoint 2 ¹⁾
Bit 1 = 1	External reset by means of reset input R is possible
Bit 0 = 1	Starting point has been loaded into the counter (from the setting value register for the counter)

Bits 15..8 not used (permanently ¹⁾)

Bit 7 = 1 Positive overflow of the counter

Bit 6 = 1 Negative overflow of the counter

1	positive overflow	negative overflow	ZW > SW1	ZW = SW1	ZW > SW2	ZW = SW2	reset	starting point loaded
Bits 15...8	Bit 7	Bit 6	Bit 5	Bit 4	Bit 3	Bit 2	Bit 1	Bit 0

Fig. 9.2.2: Meaning of the bits of the status register

ZW = count value

SW1 = 1. setpoint

SW2 = 2. setpoint

Register 1 (Count Value Register)

The Count value register shows the current count value. Only 'Read' is possible. The binary content is permanently displayed by 16 LEDs on the front panel of the module.

Register 2 and Register 3

These registers are not used.

¹⁾ alternatively latched or not latched, depending on the setting of the control register

Register 4 (Control Register)

The user-specific settings in the control register permit the allocation of different meanings to bits in the status register and to the output signals A1 and A2. Only 'Write' is possible. The single bits have following meanings:

- Bits 15..8 Not used (Do not write here!)
- Bit 7 = 0 Overflow bit (positive) in the status register is not activated.
- Bit 7 = 1 Overflow bit (positive) in the status register is latched
- Bit 6 = 0 Overflow bit (negative) in the status register is not activated.
- Bit 6 = 1 Overflow bit (negative) in the status register is latched
- Bit 5 = 0 Output A1 goes to 1, when the count value is higher than the 1. setpoint (ZW > SW1)
- Bit 5 = 1 Output A1 goes to 1, when the count value is equal to the 1. setpoint (ZW = SW1)
- Bit 4 = 0 Comparing bit ZW = SW1 in the status register is not latched, it is only present as long as the compared values are equal
- Bit 4 = 1 Comparing bit ZW = SW1 in the status register is latched
- Bit 3 = 0 Output A2 goes to 1, when the count value is higher than the 2. setpoint (ZW > SW2)
- Bit 3 = 1 Output A2 goes to 1, when the count value is equal to the 2. setpoint (ZW = SW2)-
- Bit 2 = 0 Comparing bit ZW = SW2 in the status register is not latched, it is only present as long as the compared values are equal
- Bit 2 = 1 Comparing bit ZW = SW2 in the status register is latched
- Bit 1 = 0 External reset by means of the reset input R is not possible
- Bit 1 = 1 External reset by means of the reset input R is possible
- Bit 0, 0→1 Changing of this bit from 0 to 1 leads to a setting of the count value register with the content of the setting value register (for counter). Updated values in the setting value registers (setpoints) will be forced now.
- Bit 0, 1→0 No effect

Do not write here! Bits 15...8	positive overflow Bit 7	negative overflow Bit 6	control of A1 Bit 5	ZW = SW1 Bit 4	control of A2 Bit 3	ZW = SW2 Bit 2	reset Bit 1	loading of starting p. Bit 0
-----------------------------------	----------------------------	----------------------------	------------------------	-------------------	------------------------	-------------------	----------------	---------------------------------

Fig. 9.2.3: Meaning of the bits in the control register

Register 5 (Setting Value Register for Counter)

Any starting point may be entered into this register. The latest starting point will be transferred by changing of bit 0 (control register) from 0 to 1 into the count value register (counter). The setting value register may be loaded with the content of an operand or with a constant.

Register 6 (Setting Value Register, 1. Setpoint) Register 7 (Setting Value Register, 2. Setpoint)

Any hexadecimal number (0000...FFFF) may be entered into the setting value registers for the 1. setpoint (lower threshold) and the 2. setpoint (upper threshold). The built-in comparator compares the current count value with the preset setpoints. The comparing results are readable from the status register and available at the outputs A1 and A2.

Updated values in the setting value registers (setpoints) will be forced to the comparator when the next rising edge at bit 0 in the control register occurs.

Count Operating

Simple pulse counting (1-phase operation) means that the counter counts up when a rising pulse edge at the counting input K1 occurs, and counts down when it is at K2. The terminals X4 and X5 have to be short-circuit in this operation.

The counting direction when 2-phase operation is used depend on the sequential order of phases of the connected pulse encoder. The terminals X4 and X5 are not connected in this operation.

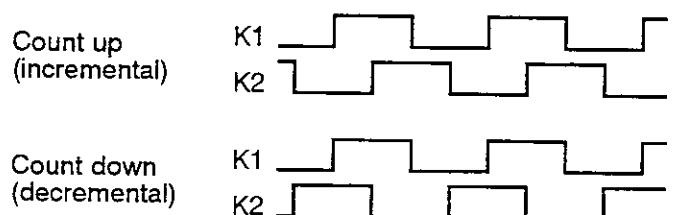

Fig. 9.2.4: 2-phase counting operation

The pulse edges of the two channels have a phase-angle deviation of 90 degrees. The conformity error must not be greater than ± 45 degrees.

When an overflow or an underflow occurs, the respective bit in the status register is set latched.

To load setting value registers (counter or setpoints) first the new values have to be set into these registers. Then bit 0 of the control register has to be set to 0. Check the success of this operation by reading bit 0 in the status register. After checking of bit 0 = 0 in the status register, the bit 0 of the control register has to be set to 1. The rising edge of bit 0 (control register) causes that the setting values become valid.

The duration between setting value registers and 'Writing' of control register must not be shorter than 0.2 ms.

Configuration

The high-speed counter can be placed in a basic sub-rack or in expansion subracks when they are used in central expansion. Placement in remote substations is only possible when the application is not time-critical, since minimum times between entering data into setting value registers and the control register are required.

Terminal Assignment

The high-speed counter is equipped with a 20-pole terminal block with following numbering:

Terminal	Name	Meaning
1	UP 3	positive pole of the built-in power supply of 12 V to feed a pulse encoder, the maximum load capability is 50 mA
2, 3, 4	X1, X2, X3	These terminals have to be connected to UP 3, if the pulse encoder is equipped with open-collector outputs without own pull-up resistors.
5	ZP 3	Reference potential to UP 3
6	K1	Counting input channel 1
7	K2	Counting input channel 2
8	R	Reset input, active with 0-signal, edge-triggered
9, 10	X4, X5	Selection of operating mode: open: 2-phase short-circ.: pulse counting, using K1: up, using K2: down
11, 12	NC	not connected
13	UP 1	Positive pole of an external power supply of 24 V to feed the signal outputs A1 and A2
14	A1	Signal output: comparison with SW1
15	A2	Signal output: comparison with SW2
16	ZP 1	Reference potential to UP 1
17...20	NC	not connected

Technical Data of the Signal Inputs

Number of inputs per module		3 (2 counting inputs + reset)
Electrical isolation		yes, common reference potential for all inputs
Process supply voltage		12 V DC $\pm 10\%$ / 24 V DC $\pm 10\%$
To supply a pulse encoder with a supply voltage of 12 V the module includes an internal voltage source of		12 V $\pm 10\%$
with a current loadability of		max. 50 mA
Input signal level:	signal 0	0 V... + 2 V (LED light)
	signal 1	+ 6 V... + 30 V (LED dark)
Input resistance		approx. 20 k Ω
Input current	if UP3 = 12 V DC	approx. 0.6 mA
	if UP3 = 24 V DC	approx. 1.2 mA
Input signal delay		
signal edge 0 \rightarrow 1		max. 3 μ s
signal edge 1 \rightarrow 0		max. 3 μ s
Minimum pulse width at the counting inputs		min. 5 μ s
Minimum pulse width at the reset input		min. 10 μ s
Counting frequency		max. 50 kHz

Technical Data of the Signal Outputs

Number of outputs per module	2
Electrical isolation	yes, common reference potential for all outputs
Process supply voltage, rated value	24 V DC
lower limit	10 V DC
upper limit	30 V DC
Circuitry type of outputs	npn-transistor, open-collector
Defined states of output signals	
signal 0	transistor non-conducting
signal 1	transistor conducting
Output load capability	max. 0.5 A
Output saturation voltage, if loaded by 0,5 A	max. 1.5 V
Minimum load (outputs with pull-up resistors)	1 mA
Output signal delay	
signal edge 0 → 1	max. 0.5 ms
signal edge 1 → 0	max. 0.5 ms

Technical Data of the Entire Module

Nominal insulation voltage, process terminals versus subrack, internal connections, inputs versus outputs:	acc. VDE 0160	30 V AC																											
	tested with	250 V AC																											
Supply current from internal voltages																													
UB1 = 5 V DC		max. 0.30 A																											
UB4 = 24 V DC		max. 0.10 A																											
Power dissipation		max. 3.9 W																											
Cable length, if cables have been laid parallel in cable duct:	shielded	max. 200 m																											
Conductor cross section of process terminals		max. 1.5 mm ²																											
Signalling	of the input signals	3 green LEDs																											
	of the output signals	2 green LEDs																											
	of the counter content	16 green LEDs																											
Number of required slots		1 I/O slot																											
Number of occupied I/O points		128																											
Configuration identifier in 907 PC 32		EAW4																											
Ability of fitting in subracks																													
slots, ● = plug-in is possible																													
		<table border="1"> <thead> <tr> <th colspan="3">BT</th> <th colspan="3">BE-central</th> <th colspan="3">BE-remote</th> </tr> <tr> <th>NG</th> <th>ZE</th> <th>I/O</th> <th>NG</th> <th>BV</th> <th>I/O</th> <th>NG</th> <th>BV</th> <th>I/O</th> </tr> </thead> <tbody> <tr> <td></td> <td></td> <td>●</td> <td></td> <td></td> <td>●</td> <td></td> <td></td> <td>● 1)</td> </tr> </tbody> </table>	BT			BE-central			BE-remote			NG	ZE	I/O	NG	BV	I/O	NG	BV	I/O			●			●			● 1)
BT			BE-central			BE-remote																							
NG	ZE	I/O	NG	BV	I/O	NG	BV	I/O																					
		●			●			● 1)																					
Weight		520 g																											
Order number		GJV3074356R1																											

1) only in applications which are not time-critical

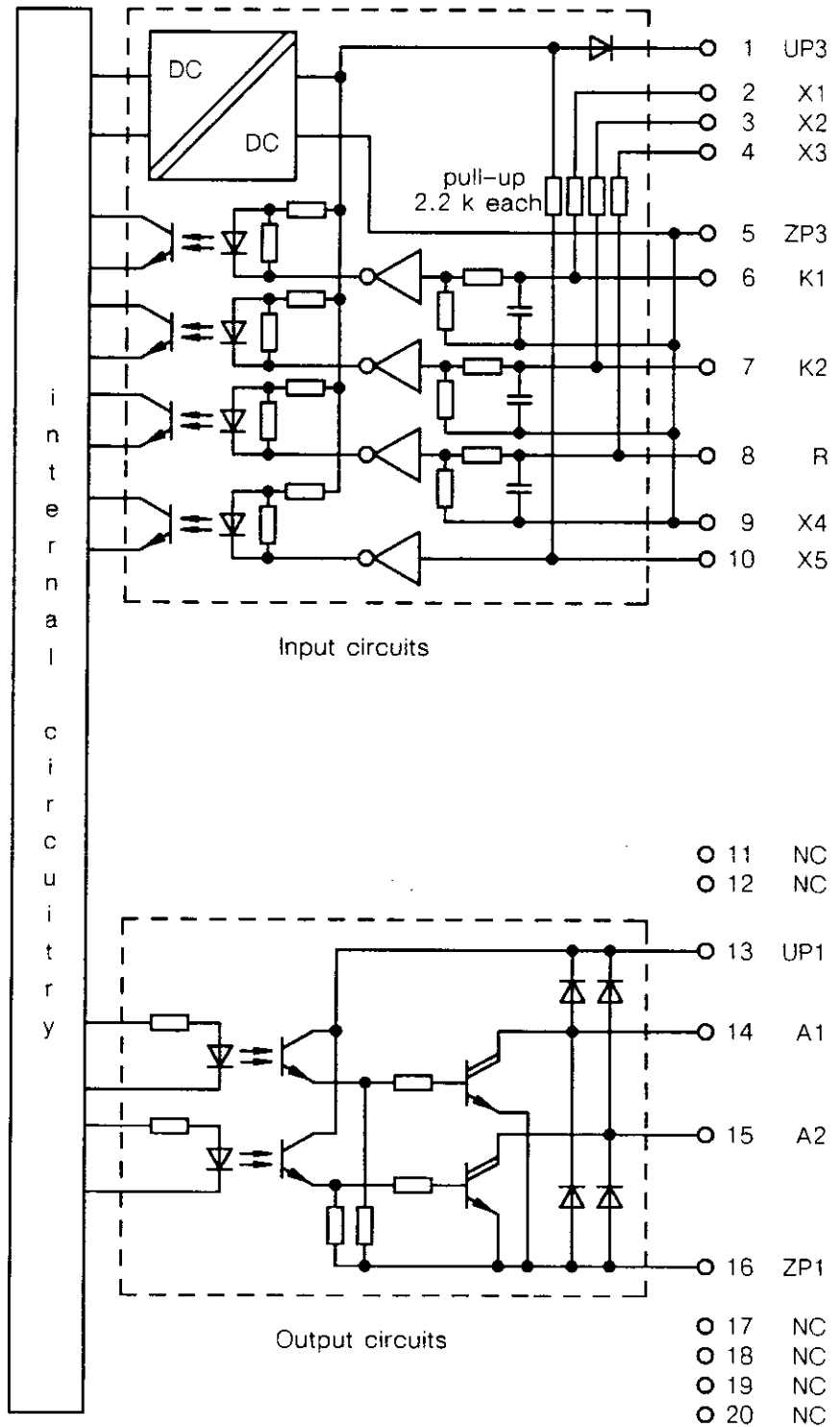
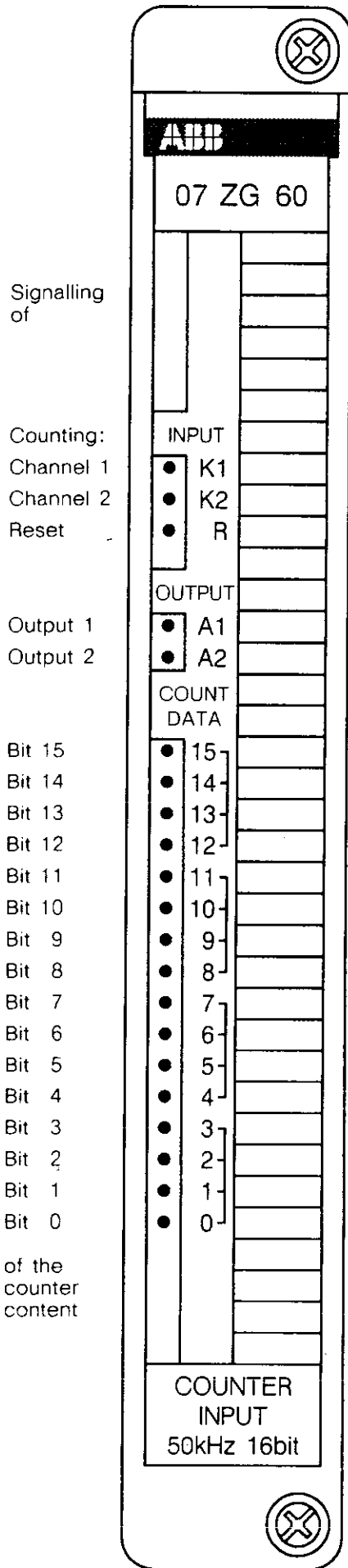

Fig. 9.2.5: 07 ZG 60: Signalling, input and output circuitry, terminal assignment and names of inputs and outputs

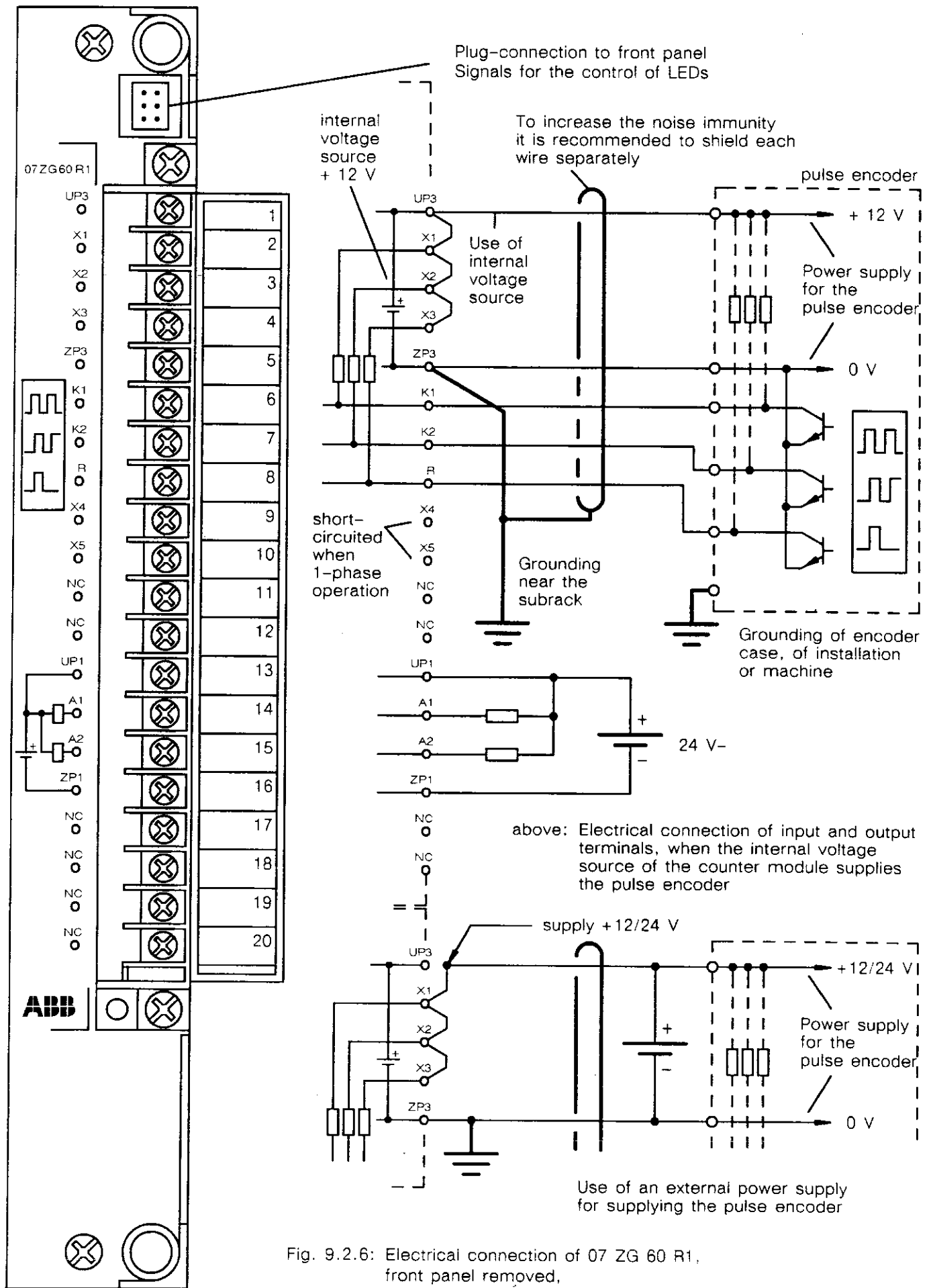

Fig. 9.2.6: Electrical connection of 07 ZG 60 R1, front panel removed, terminal cover opened

10 Binary Output Modules

07 AB 60 R1:	Binary output module, transistor outputs, 24 V DC/48 V DC, 2 A,	electrically isolated, 16 outputs
07 AB 61 R1:	Binary output module, transistor outputs, 24 V DC/48 V DC, 500 mA,	electrically isolated, 32 outputs
07 AB 62 R1:	Binary output module, short-circuit proof, transistor outputs, 24 V DC, 2 A,	electrically isolated, 16 outputs
07 AB 63 R1:	Binary output module, short-circuit proof, transistor outputs, 24 V DC, 500 mA,	electrically isolated, 32 outputs
07 AB 67 R1:	Binary output module, relay outputs, 230 V AC/24 V DC,	electrically isolated, 16 outputs
07 AB 68 R1:	Binary output module, thyristor outputs, 115 V AC,	electrically isolated, 16 outputs

10.1 Binary Output Module 07 AB 60 R1

Transistor outputs, 24 V DC/48 V DC, 2 A, 16 outputs, electrically isolated

Binary, isolated output module with 16 transistor outputs for rated voltages of 24 V DC or 48 V DC and a rated current of 2 A. The device transforms the internal signal levels to external power signals. The signal states of process signals are displayed by yellow LEDs. A short-circuit breaking for the protection of the external wiring is given by fast fuses of 7.5 A, with one fuse

belonging to 8 channels. Short-circuit breakings are signalled by red LEDs (F0, F1). If such a breaking is signalled, remove the module, take the cover of the case away and replace the respective fuse. The process supply voltage and the 0V reference potential are separately connected to 8 channels at a time.

Technical Data

Number of outputs per module	16																											
Electrical isolation	in 2 groups of 8 outputs each, each group with separate process supply voltage UP and separate reference potential ZP																											
Nominal insulation voltage, process terminals versus subrack, internal connections and other groups:	acc. VDE 0160 tested with																											
	60 V AC 500 V AC																											
Process supply voltages, rated values limits (ripple included)	24 V DC, 48 V DC 21 V DC...60 V DC																											
Output signal level:	signal 1 (UP - 3 V)...UP																											
Leakage current	signal 0 max. 3 mA																											
Output load capability																												
rated value	2 A																											
lamp wattage	max. 10 W																											
total current for one group of 8	max. 5 A																											
Switching rate: Inductive load	max. 0.5 Hz																											
Short-circuit breaking (Protection for the external wiring)	one fast fuse per group of 8, indication with LEDs																											
Limitation of output voltage, if inductive load is switched off	approx. - 1 V (free-wheeling diode)																											
Output signal delay																												
signal edge 0 → 1	max. 0.3 ms																											
signal edge 1 → 0	max. 1 ms																											
Supply current from internal voltages																												
UB1 = 5 V DC	max. 0.12 A																											
UB4 = 24 V DC	no current consumption																											
Power dissipation	max. 15.6 W																											
Cable length, if cables have been laid parallel in cable duct:	pay attention to voltage drop																											
shielded	max. 1000 m																											
unshielded	max. 600 m																											
Conductor cross section of process terminals	max. 1.5 mm ²																											
Signalling	one yellow LED per output channel, one red LED per fuse																											
Number of required slots	1 I/O slot																											
Number of occupied I/O points	16																											
Configuration identifier in 907 PC 32	A16																											
Ability of fitting in subracks																												
slots, ● = plug-in is possible	<table border="1" style="border-collapse: collapse; text-align: center; width: 100%;"> <tr> <td colspan="3">BT</td> <td colspan="3">BE-central</td> <td colspan="3">BE-remote</td> </tr> <tr> <td>NG</td><td>ZE</td><td>I/O</td> <td>NG</td><td>BV</td><td>I/O</td> <td>NG</td><td>BV</td><td>I/O</td> </tr> <tr> <td></td><td></td><td>●</td> <td></td><td></td><td>●</td> <td></td><td></td><td>●</td> </tr> </table>	BT			BE-central			BE-remote			NG	ZE	I/O	NG	BV	I/O	NG	BV	I/O			●			●			●
BT			BE-central			BE-remote																						
NG	ZE	I/O	NG	BV	I/O	NG	BV	I/O																				
		●			●			●																				
Weight	530 g																											
Order number of replacement fuse, fast 7.5 A	GJV3074395P2																											
Order number of module 07 AB 60 R1	GJV3074360R1																											

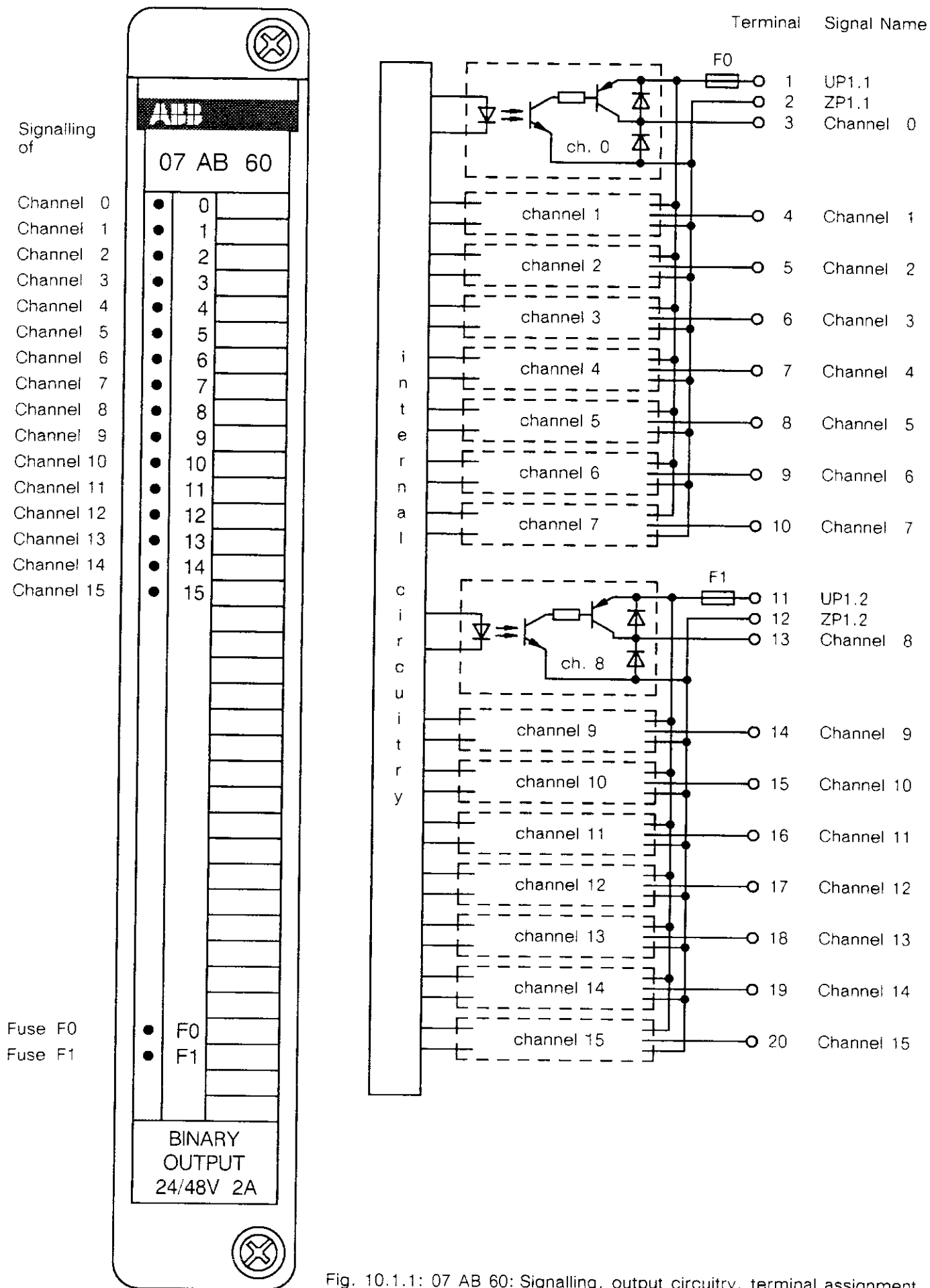

Fig. 10.1.1: 07 AB 60: Signalling, output circuitry, terminal assignment and signal names of channels

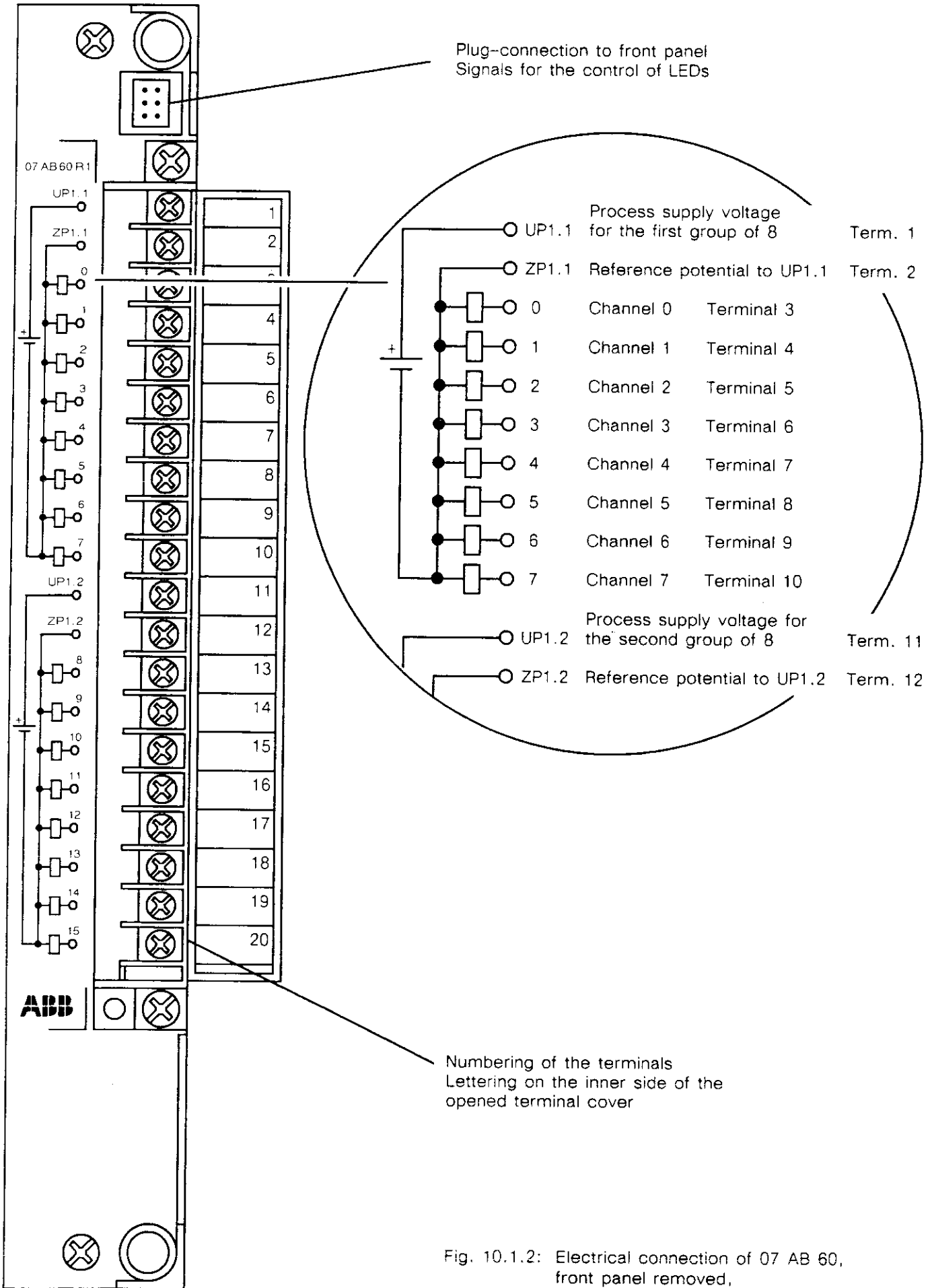

Fig. 10.1.2: Electrical connection of 07 AB 60, front panel removed, terminal cover opened

10.2 Binary Output Module 07 AB 61 R1

Transistor outputs, 24/48 V DC, 500 mA, 32 outputs, electrically isolated

Binary, isolated output module with 32 transistor outputs for rated voltages of 24 V DC or 48 V DC and a rated current of 500 mA. The device transforms the internal signal levels to external power signals. The signal states of process signals are displayed by yellow LEDs. A short-circuit breaking for the protection of the external wiring is given by fast fuses of 5 A, with one

fuse belonging to 8 channels. Short-circuit breakings are signalled by red LEDs (F0...F3). If such a breaking is signalled, remove the module, take the cover of the case away and replace the respective fuse. The process supply voltage and the 0V reference potential are separately connected to 8 channels at a time.

Technical Data

Number of outputs per module	32
Electrical isolation	in 4 groups of 8 outputs each, each group with separate process supply voltage UP and separate reference potential ZP
Nominal insulation voltage, process terminals versus subrack, internal connections and other groups:	acc. VDE 0160 tested with
	60 V AC 500 V AC
Process supply voltages, rated values limits (ripple included)	24 V DC, 48 V DC 21 V DC....60 V DC
Output signal level:	signal 1 (UP - 3 V)....UP
Leakage current	signal 0 max. 1 mA
Output load capability	
rated value	500 mA
lamp wattage	max. 5 W
total current for one group of 8	max. 2 A
Switching rate: Inductive load	max. 0.5 Hz
Short-circuit breaking (Protection for the external wiring)	one fast fuse per group of 8, indication with LEDs
Limitation of output voltage, if inductive load is switched off	approx. - 1 V (free-wheeling diode)
Output signal delay	
signal edge 0 → 1	max. 0.3 ms
signal edge 1 → 0	max. 1 ms
Supply current from internal voltages	
UB1 = 5 V DC	max. 0.18 A
UB4 = 24 V DC	no current consumption
Power dissipation	max. 12.6 W
Cable length, if cables have been laid parallel in cable duct:	pay attention to voltage drop
shielded	max. 1000 m
unshielded	max. 600 m
Conductor cross section of process terminals	max. 1.5 mm ²
Signalling	one yellow LED per output channel, one red LED per fuse
Number of required slots	1 I/O slot
Number of occupied I/O points	32
Configuration identifier in 907 PC 32	A32
Ability of fitting in subracks	
slots, ● = plug-in is possible	
Weight	490 g
Order number of replacement fuse, fast 5 A	GJV3074395P1
Order number of module 07 AB 61 R1	GJV3074361R1

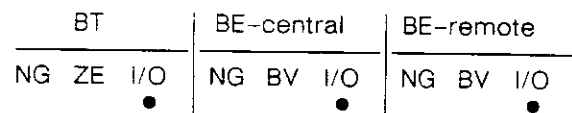

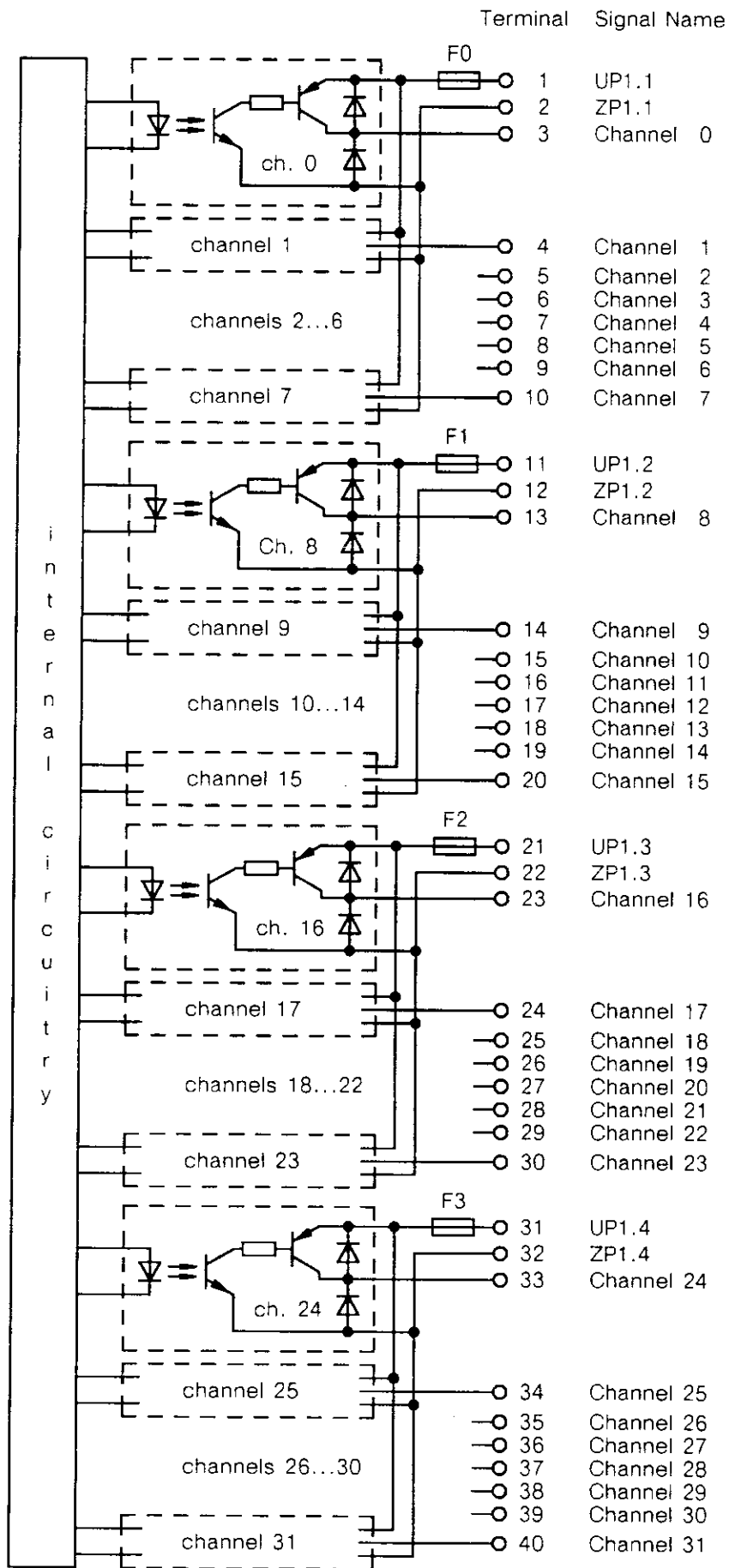
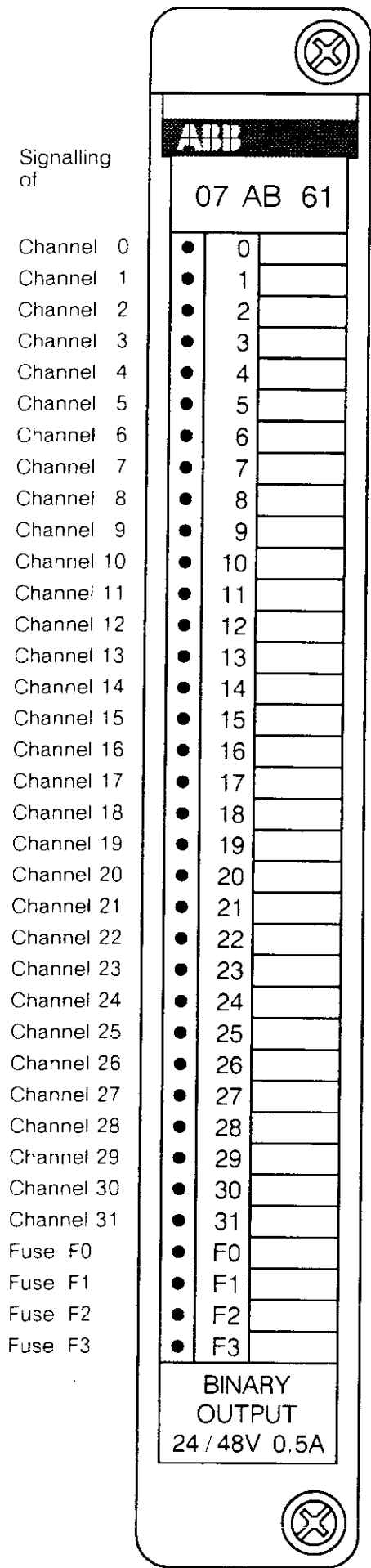

Fig. 10.2.1: 07 AB 61: Signalling, output circuitry, terminal assignment and signal names of channels

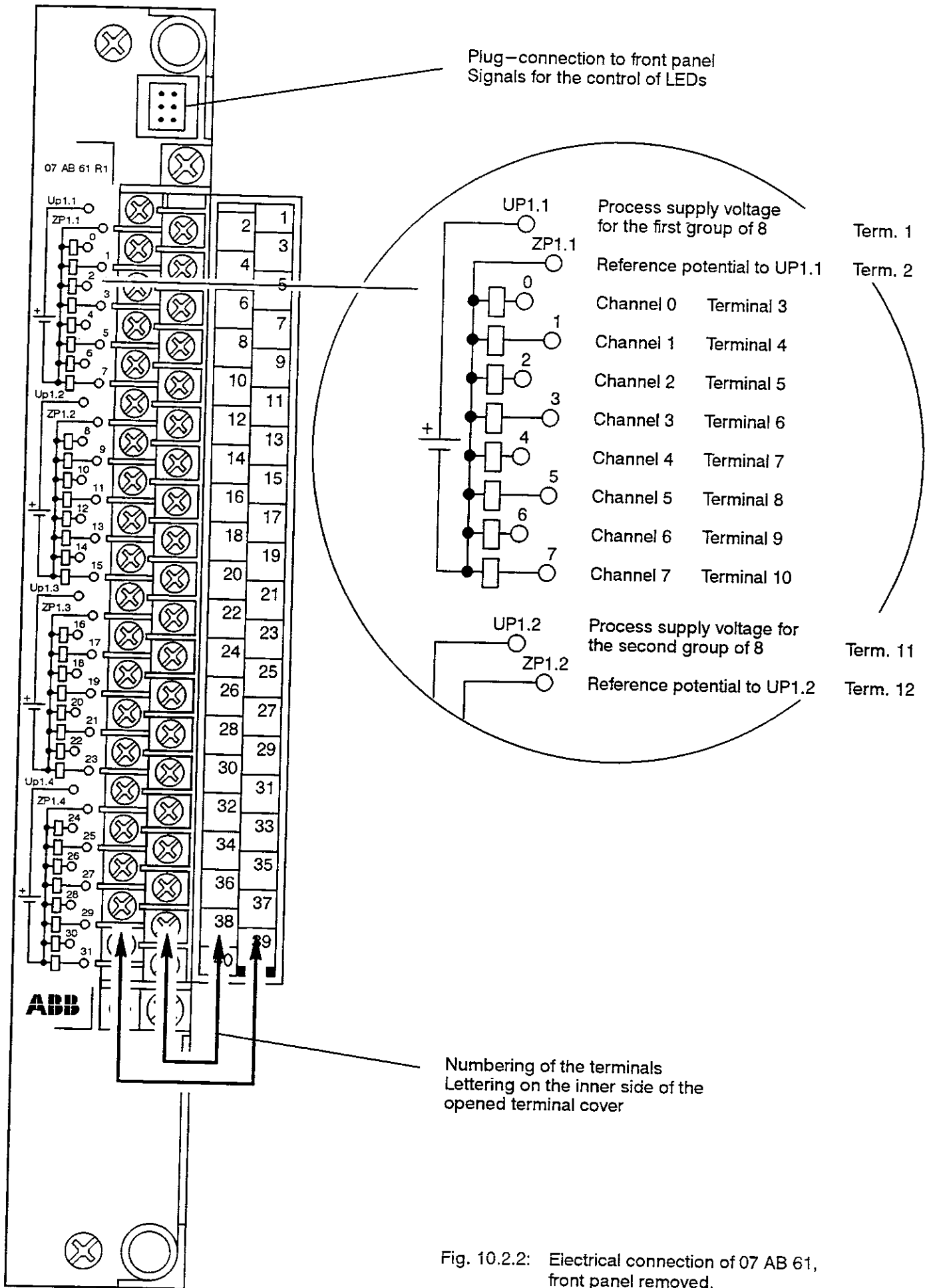

Fig. 10.2.2: Electrical connection of 07 AB 61, front panel removed, terminal cover opened

10.3 Binary Output Module 07 AB 62 R1

16 transistor outputs, 24 V DC, 2 A, short-circuit-proof, electrically isolated

A binary, electronically short-circuit-proof, electrically isolated output module with 16 transistor output channels for a rated voltage of 24 V DC and a rated current of 2 A. The module converts the internal signal levels into external process signals. Yellow LEDs indicate the signal status of the process signals.

Each output stage disposes of an overload and short-circuit protection. In case of an overload or short-circuit the respective output is switched off. When the acknowledgement button is pressed, the output is switched on again after elimination of the short-circuit (or overload).

For each group of 8 channels there is one acknowledgement button (E0, E1) on the top of the module and one red LED. In case of a short-circuit the LED lights up and only goes out when the acknowledgement was successful.

The process supply voltage and the 0 V reference potential are separately connected for 8 channels each.

Attention:

If the acknowledgement button is kept pressed during a short-circuit, the lifetime of the module will be reduced. For this reason, an acknowledgement should always be carried out after elimination of the short circuit.

Technical Data

Number of outputs per module	16
Electrical isolation	in 2 groups of 8 outputs each, each group with separate process supply voltage UP and separate reference potential ZP
Nominal insulation voltage, process terminals versus subrack, internal connections and other groups:	acc. VDE 0160 tested with
	60 V AC 500 V AC
Process supply voltage, rated value limits (ripple included)	24 V DC 18 V DC...30 V DC
Output signal level:	signal 1 (UP - 1 V)....UP
Leakage current	signal 0 max. 1 mA
Output load capability	
rated value	2 A
lamp wattage	max. 5 W
total current for one group of 8	max. 5 A
Switching rate: Inductive load	max. 0.5 Hz
Short-circuit protection and switch off	yes, separately for each channel
Short-circuit indication	one red LED per group of 8
Acknowledgement after elimination of short-circuit	one button per group of 8
Short-circuit current per channel	max. 2.5 A
Limitation of output voltage, if inductive load is switched off	approx. - 20 V (free-wheeling suppressing diode)
Output signal delay	
signal edge 0 → 1	max. 0.3 ms
signal edge 1 → 0	max. 1 ms
Supply current from internal voltages	
UB1 = 5 V DC	max. 0.15 A
UB4 = 24 V DC	no current consumption
Power dissipation	max. 6 W
Cable length, if cables have been laid parallel in cable duct:	pay attention to voltage drop
shielded	max. 1000 m
unshielded	max. 600 m
Conductor cross section of process terminals	max. 1.5 mm ²
Signalling, indication of output signals	one yellow LED per output channel
indication of short-circuit	one red LED per group of 8

Number of required slots
 Number of occupied I/O points
 Configuration identifier in 907 PC 32
 Ability of fitting in subracks
 slots, ● = plug-in is possible
 Weight
 Order number of module 07 AB 62 R1

1 I/O slot
 16
 A16
 approx. 500 g
 GJV3074362R1

BT			BE-central			BE-remote		
NG	ZE	I/O	NG	BV	I/O	NG	BV	I/O
		●			●			●

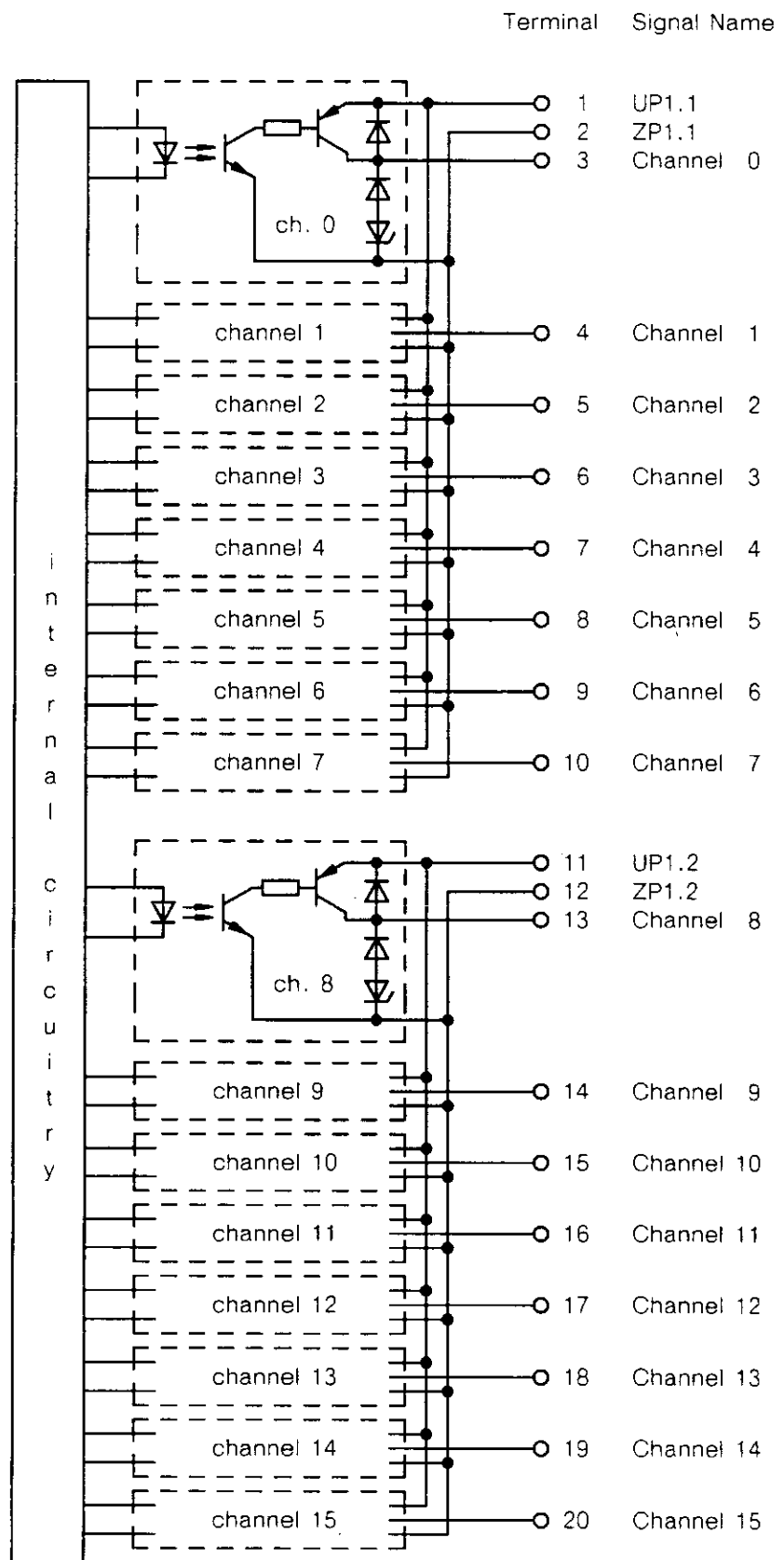
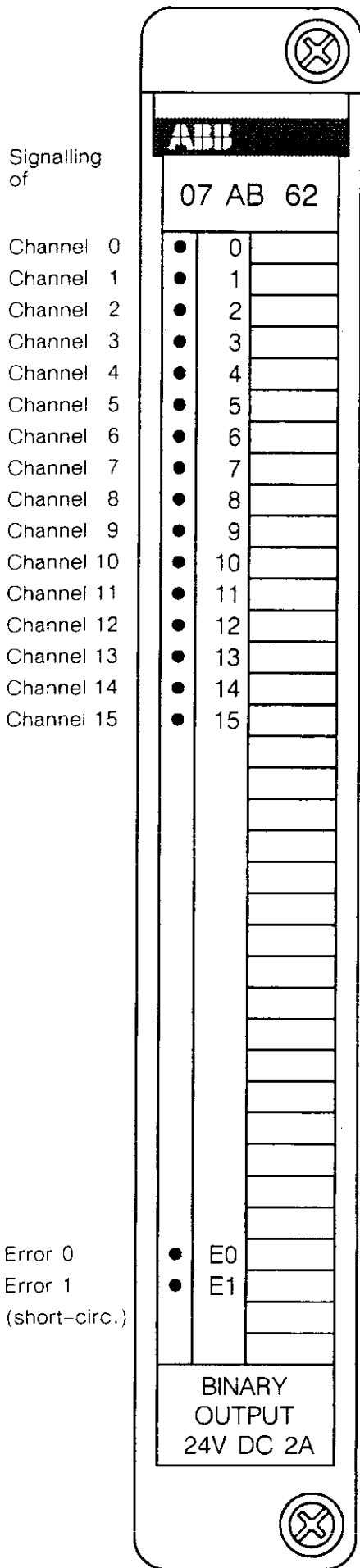

Fig. 10.3.1: 07 AB 62: Signalling, output circuitry, terminal assignment and signal names of channels

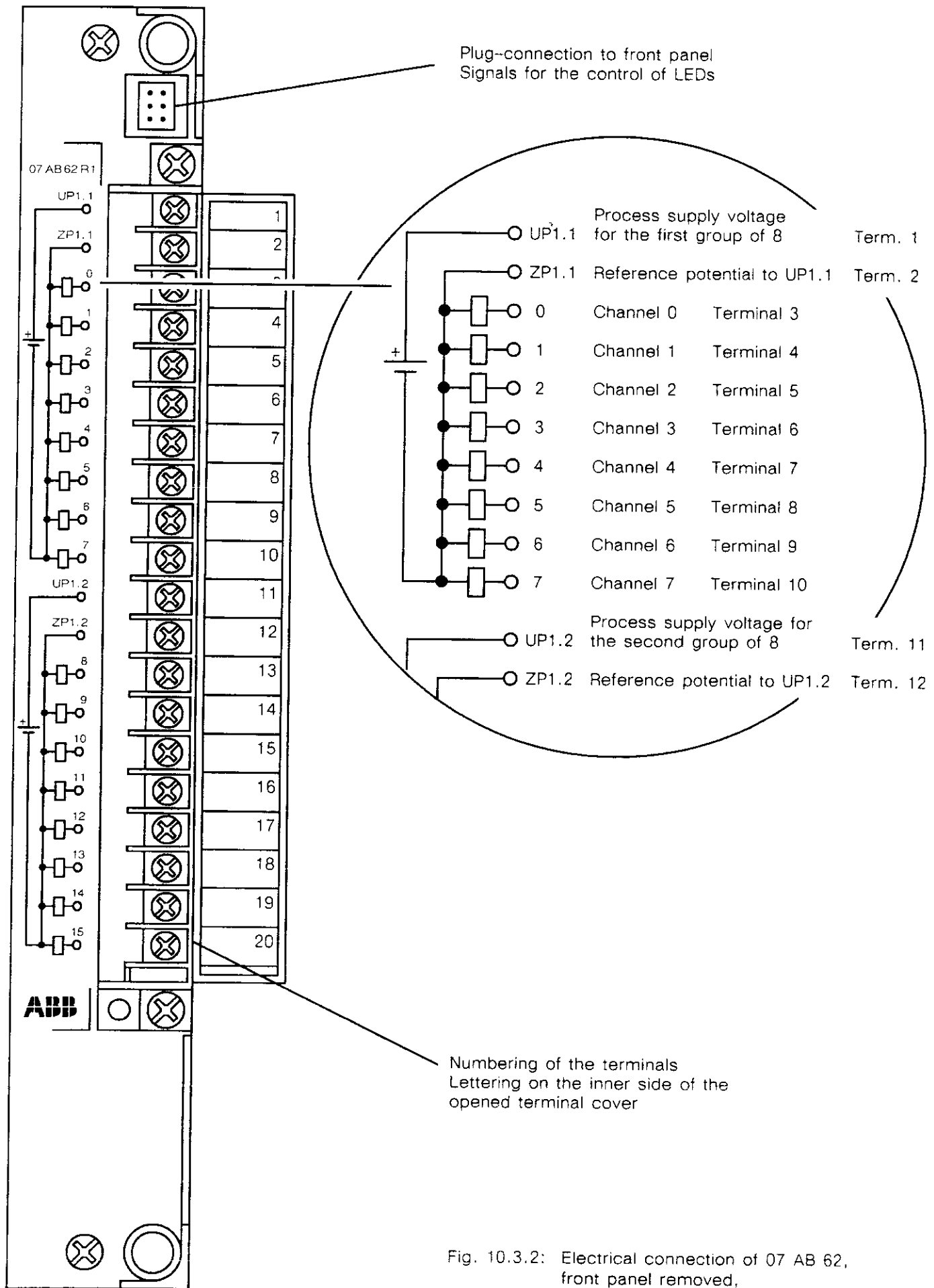

Fig. 10.3.2: Electrical connection of 07 AB 62, front panel removed, terminal cover opened

10.4 Binary Output Module 07 AB 63 R1

32 transistor outputs, 24 V DC, 0.5 A, short-circuit-proof, electrically isolated

A binary, electronically short-circuit-proof, electrically isolated output module with 32 transistor output channels for a rated voltage of 24 V DC and a rated current of 0.5 A. The module converts the internal signal levels into external process signals. Yellow LEDs indicate the signal status of the process signals.

Each output stage disposes of an overload and short-circuit protection. In case of an overload or short-circuit the respective output is switched off. When the acknowledgement button is pressed, the output is switched on again after elimination of the short-circuit (or overload).

Technical Data

Number of outputs per module

Electrical isolation

Nominal insulation voltage, process terminals versus subrack, internal connections

and other groups: acc. VDE 0160
tested with

Process supply voltage, rated value
limits (ripple included)

Output signal level: signal 1
Leakage current signal 0

Output load capability

rated value
max. load current for one channel
lamp wattage
total current for one group of 8

Switching rate: Inductive load

Short-circuit protection and switch off

Short-circuit indication

Acknowledgement after elimination of short-circuit

Short-circuit current per channel

Limitation of output voltage,

if inductive load is switched off

Output signal delay

signal edge 0 → 1
signal edge 1 → 0

Supply current from internal voltages

UB1 = 5 V DC
UB4 = 24 V DC

Power dissipation

Cable length, if cables have been laid parallel in

cable duct: shielded
unshielded

Conductor cross section of process terminals

Signalling, indication of output signals
indication of short-circuit

For each group of 8 channels there is one acknowledgement button (E0, E1, E2, E3) on the top of the module and one red LED. In case of a short-circuit the LED lights up and only goes out when the acknowledgement was successful.

The process supply voltage and the 0 V reference potential are separately connected for 8 channels each.

Attention:

If the acknowledgement button is kept pressed during a short-circuit, the lifetime of the module will be reduced. For this reason, an acknowledgement should always be carried out after elimination of the short circuit.

32

in 4 groups of 8 outputs each, each group with separate process supply voltage UP and separate reference potential ZP

60 V AC

500 V AC

24 V DC

18 V DC...30 V DC

(UP - 1 V)...UP

max. 0.5 mA

0.5 A

1.5 A

max. 5 W

max. 2 A

max. 0.5 Hz

yes, separately for each channel

one red LED per group of 8

one button per group of 8

max. 2.5 A

approx. - 50 V (free-wheeling suppressing diode)

max. 0.3 ms

max. 1 ms

max. 0.18 A

no current consumption

max. 6 W

pay attention to voltage drop

max. 1000 m

max. 600 m

max. 1.5 mm²

one yellow LED per output channel

one red LED per group of 8

Number of required slots
 Number of occupied I/O points
 Configuration identifier in 907 PC 32
 Ability of fitting in subracks
 slots, ● = plug-in is possible
 Weight
 Order number of module 07 AB 63 R1

1 I/O slot
 32
 A32
 approx. 500 g
 GJV3074363R1

BT			BE-central			BE-remote		
NG	ZE	I/O	NG	BV	I/O	NG	BV	I/O
		●			●			●

Signalling
of

- Channel 0 ● 0
- Channel 1 ● 1
- Channel 2 ● 2
- Channel 3 ● 3
- Channel 4 ● 4
- Channel 5 ● 5
- Channel 6 ● 6
- Channel 7 ● 7
- Channel 8 ● 8
- Channel 9 ● 9
- Channel 10 ● 10
- Channel 11 ● 11
- Channel 12 ● 12
- Channel 13 ● 13
- Channel 14 ● 14
- Channel 15 ● 15
- Channel 16 ● 16
- Channel 17 ● 17
- Channel 18 ● 18
- Channel 19 ● 19
- Channel 20 ● 20
- Channel 21 ● 21
- Channel 22 ● 22
- Channel 23 ● 23
- Channel 24 ● 24
- Channel 25 ● 25
- Channel 26 ● 26
- Channel 27 ● 27
- Channel 28 ● 28
- Channel 29 ● 29
- Channel 30 ● 30
- Channel 31 ● 31
- Error 0 ● E0
- Error 1 ● E1
- Error 2 ● E2
- Error 3 ● E3

**BINARY
OUTPUT**
24V DC 0.5A

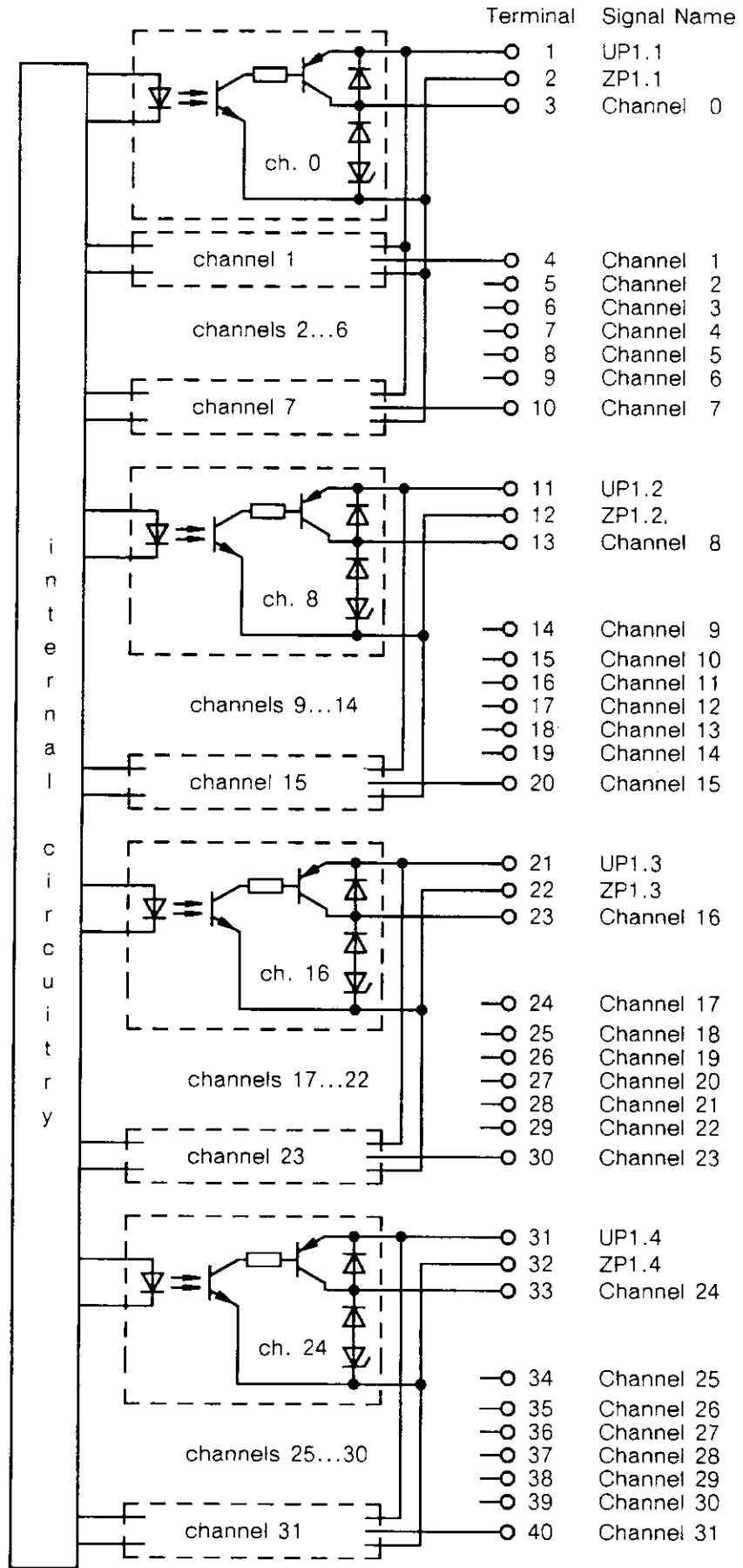

The above circuitry of the outputs is simplified.

Fig. 10.4.1: 07 AB 63: Signalling, output circuitry, terminal assignment and signal names of channels

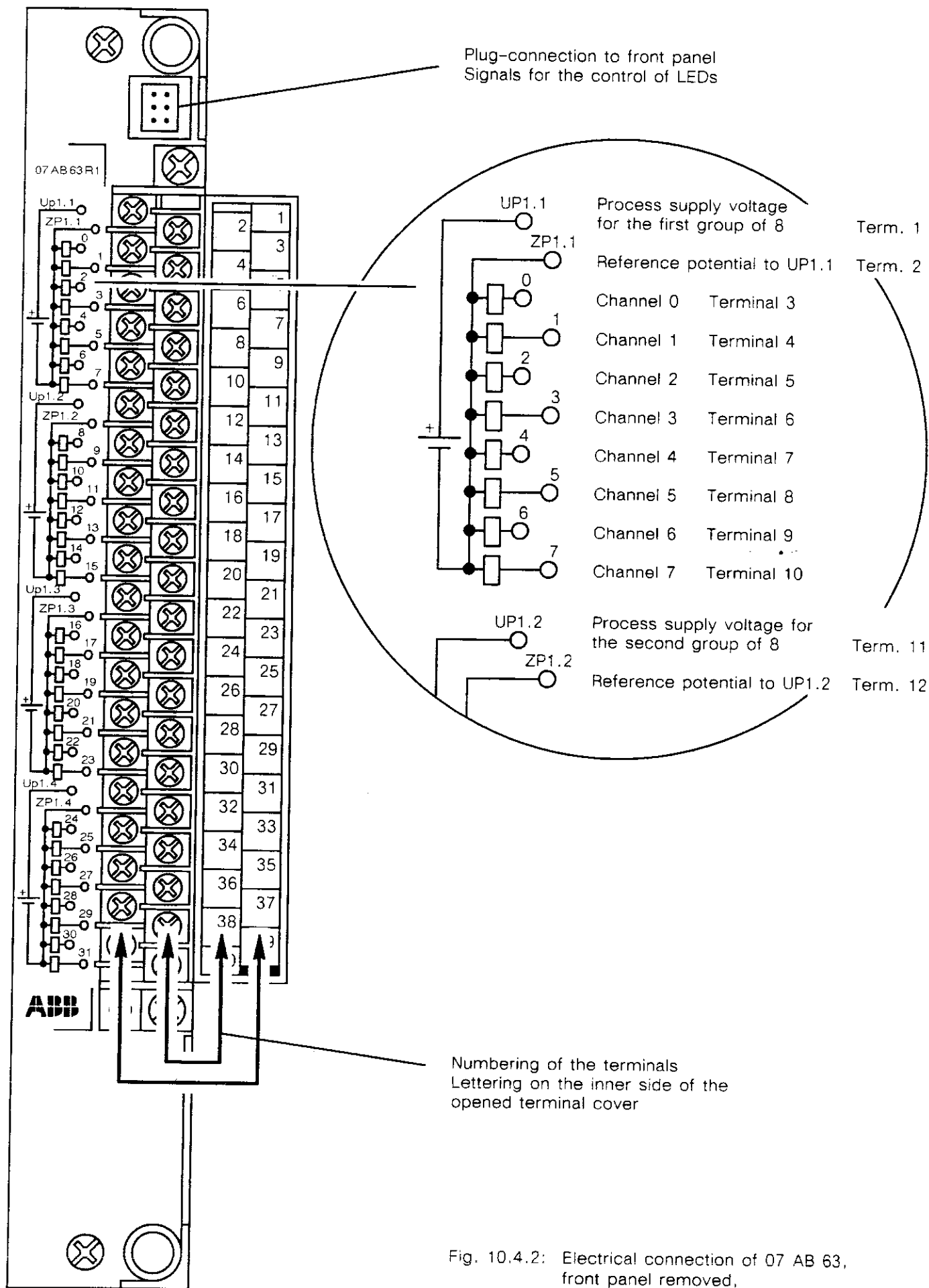

Fig. 10.4.2: Electrical connection of 07 AB 63, front panel removed, terminal cover opened

10.8 Binary Output Module 07 AB 67 R1

Relay outputs, 220 V AC/24 V DC, 16 outputs, electrically isolated

Binary, isolated output module with 16 relay outputs specified for rated voltages of 24 V DC or 220 V AC. The device transforms the internal signal levels to external power signals. The signal states of process sig-

nals are displayed by yellow LEDs. The process supply voltage is separately connected to 4 channels at a time.

Technical Data

Number of outputs per module	16																											
Electrical isolation	in 4 groups of 4 outputs each, each group with separate process supply voltage UP																											
Nominal insulation voltage, process terminals versus subrack, internal connections and other groups:	acc. VDE 0160 tested with 250 V AC 1500 V AC																											
Process supply voltages, rated values limits	24 V DC, 220 V AC 4.5...264 V DC or AC																											
Output switching capacity resistive load																												
if UP1 = 24 V DC	max. 50 W																											
if UP6 = 220 V AC	max. 110 VA																											
inductive load																												
if UP1 = 24 V DC	max. 12 W																											
if UP6 = 220 V AC	max. 110 VA																											
Switching current																												
minimum value	min. 1 mA																											
rated value	max. 2 A (resistive load) max. 0.5 A (inductive load)																											
total current for one group of 4	max. 5 A (resistive load)																											
Short-circuit protection	no																											
Limitation of output voltage, if inductive load is switched off	by means of a varistor																											
Contact lifetime, rated value	≥ 200,000 cycles																											
Contact lifetime, mechanical	≥ 10 ⁷ cycles																											
Output signal delay																												
signal edge 0 → 1	max. 7 ms																											
signal edge 1 → 0	max. 12 ms																											
Supply current from internal voltages																												
UB1 = 5 V DC	max. 0.12 A																											
UB4 = 24 V DC	max. 0.16 A																											
Power dissipation	max. 4.5 W																											
Cable length, if cables have been laid parallel in cable duct:	pay attention to voltage drop																											
shielded	max. 1000 m																											
unshielded	max. 600 m																											
Conductor cross section of process terminals	max. 1.5 mm ²																											
Signalling	one yellow LED per output channel																											
Number of required slots	1 I/O slot																											
Number of occupied I/O points	16																											
Configuration identifier in 907 PC 32	A16																											
Ability of fitting in subracks																												
slots, ● = plug-in is possible	<table border="1" style="border-collapse: collapse; text-align: center;"> <tr> <td colspan="3">BT</td> <td colspan="3">BE-central</td> <td colspan="3">BE-remote</td> </tr> <tr> <td>NG</td><td>ZE</td><td>I/O</td> <td>NG</td><td>BV</td><td>I/O</td> <td>NG</td><td>BV</td><td>I/O</td> </tr> <tr> <td></td><td></td><td>●</td> <td></td><td></td><td>●</td> <td></td><td></td><td>●</td> </tr> </table>	BT			BE-central			BE-remote			NG	ZE	I/O	NG	BV	I/O	NG	BV	I/O			●			●			●
BT			BE-central			BE-remote																						
NG	ZE	I/O	NG	BV	I/O	NG	BV	I/O																				
		●			●			●																				
Weight	400 g																											
Order number of module 07 AB 67 R1	GJV3074364R1																											

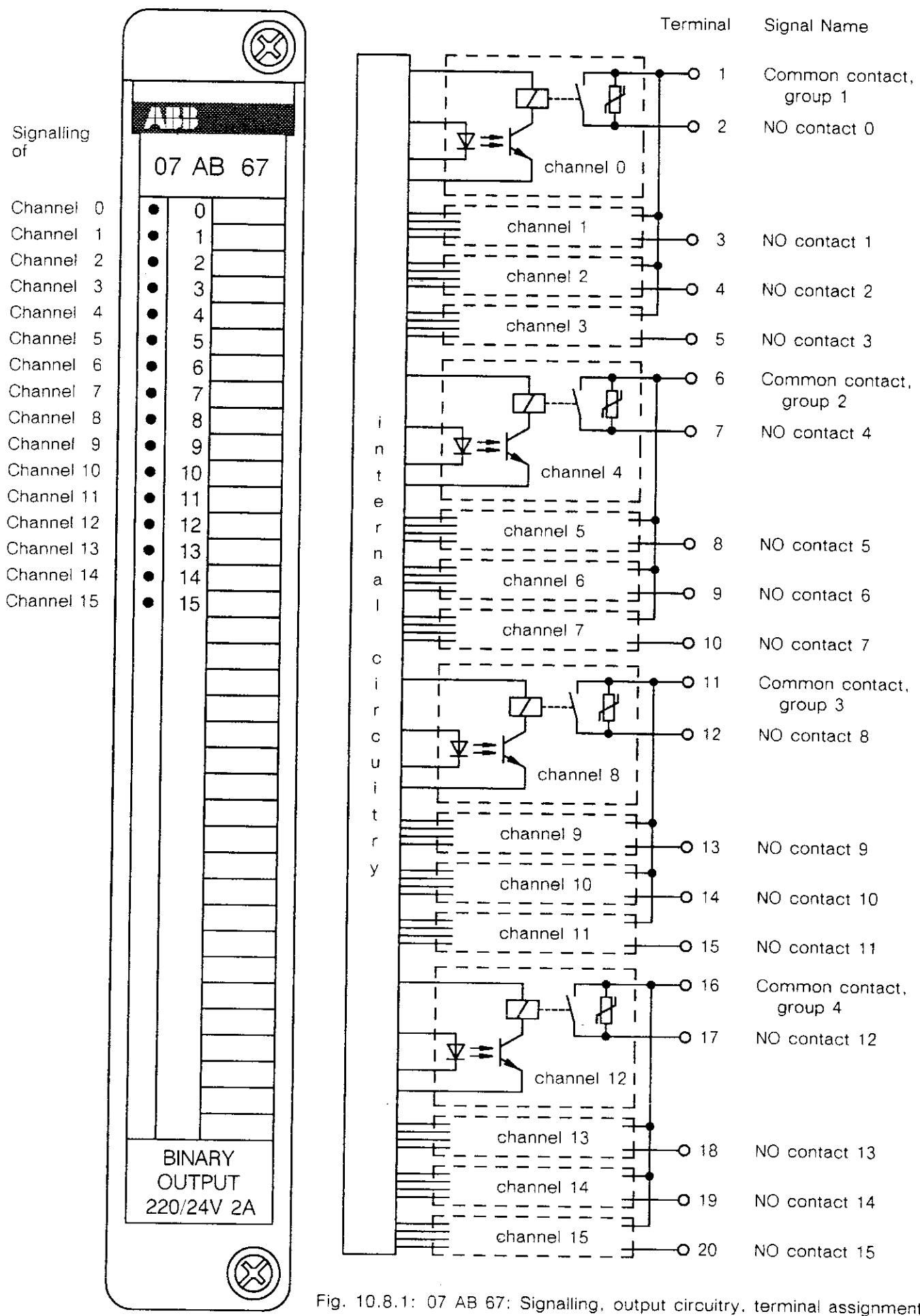

Fig. 10.8.1: 07 AB 67: Signalling, output circuitry, terminal assignment and signal names of channels

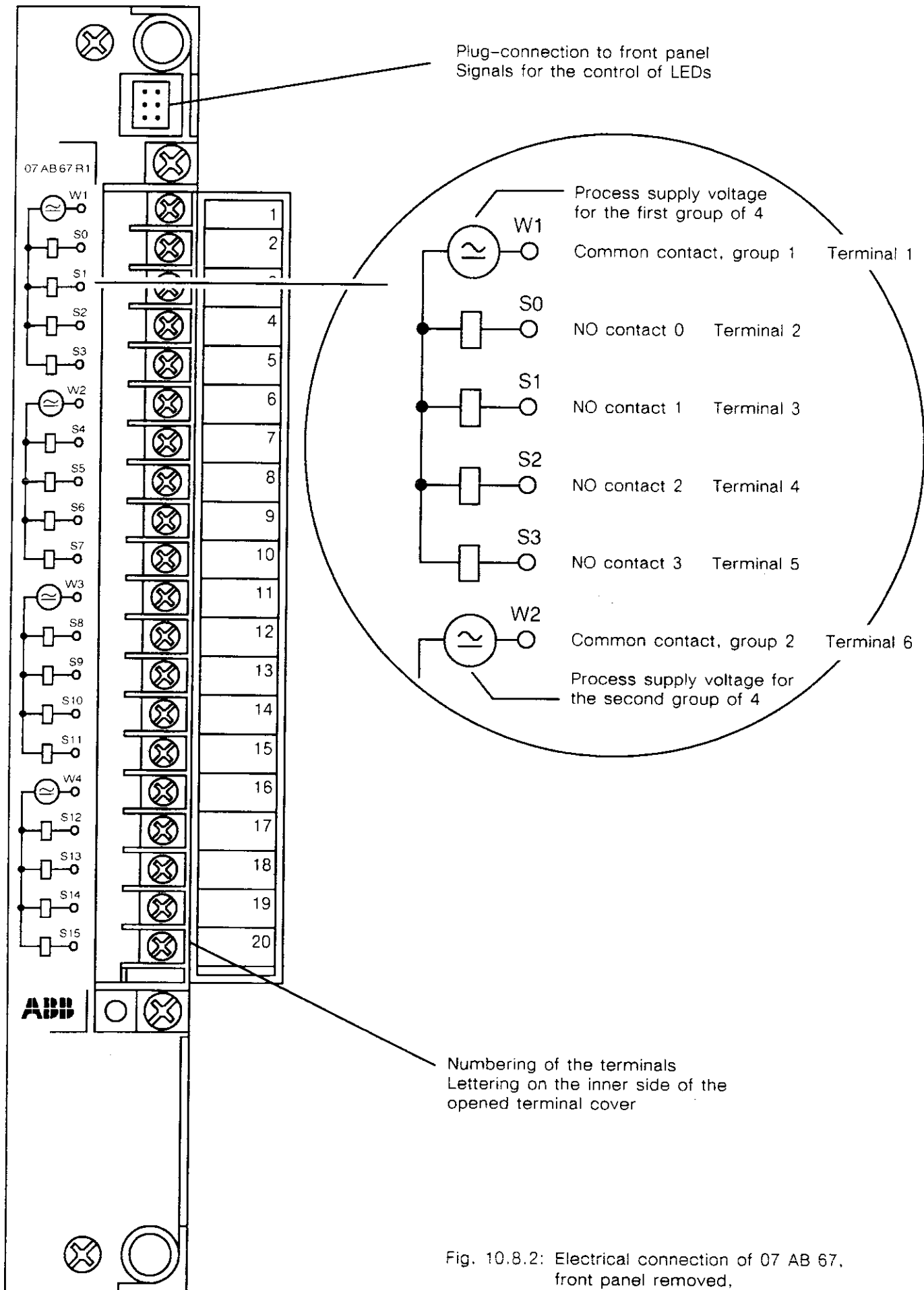

Fig. 10.8.2: Electrical connection of 07 AB 67, front panel removed, terminal cover opened

10.9 Binary Output Module 07 AB 68 R1

Thyristor outputs, 115 V AC, 16 outputs, electrically isolated

Binary, isolated output module with 16 thyristor outputs specified for rated voltages of 115 V AC. The device transforms the internal signal levels to external power signals. The signal states of process signals are dis-

played by yellow LEDs.

The process supply voltage is separately connected to 8 channels at a time. Blown fuses are indicated by red LEDs (one fuse and one LED per group/8 channels).

Technical Data

Number of outputs per module	16
Electrical isolation	in 2 groups of 8 outputs each, each group with separate process supply voltage UP
Process supply voltage, rated value limits	115 V AC 85...132 V AC
Switching current rated value total current for one group of 8 at 40°C at 55°C	max. 1.5 A max. 3.0 A max. 2.4 A (see diagram)

Max. total current
for one group of 8

Limitation of output voltage, if inductive load is switched off	by means of a varistor																											
Output signal delay signal edge 0 → 1 signal edge 1 → 0	max. 1 ms max. 0.5 cycle times + 1 ms																											
Supply current from internal voltages UB1 = 5 V DC	max. 0.4 A																											
Power dissipation	max. 8 W																											
Conductor cross section of process terminals	max. 1.5 mm ²																											
Signalling – output signal – blown fuse	one yellow LED per output channel one red LED per group of 8 outputs																											
Number of required slots	1 I/O slot																											
Number of occupied I/O points	16																											
Configuration identifier in 907 PC 33	A16																											
Ability of fitting in subracks slots, ● = plug-in is possible	<table border="1" style="border-collapse: collapse; text-align: center; width: 100%;"> <tr> <td colspan="3">BT</td> <td colspan="3">BE-central</td> <td colspan="3">BE-remote</td> </tr> <tr> <td>NG</td><td>ZE</td><td>I/O</td> <td>NG</td><td>BV</td><td>I/O</td> <td>NG</td><td>BV</td><td>I/O</td> </tr> <tr> <td></td><td></td><td>●</td> <td></td><td></td><td>●</td> <td></td><td></td><td>●</td> </tr> </table>	BT			BE-central			BE-remote			NG	ZE	I/O	NG	BV	I/O	NG	BV	I/O			●			●			●
BT			BE-central			BE-remote																						
NG	ZE	I/O	NG	BV	I/O	NG	BV	I/O																				
		●			●			●																				
Weight	400 g																											
Order number of module 07 AB 68 R1	GJV 307 43 73 R1																											
Order number of replacement fuse, 5 A	GJV 307 43 95 P3																											

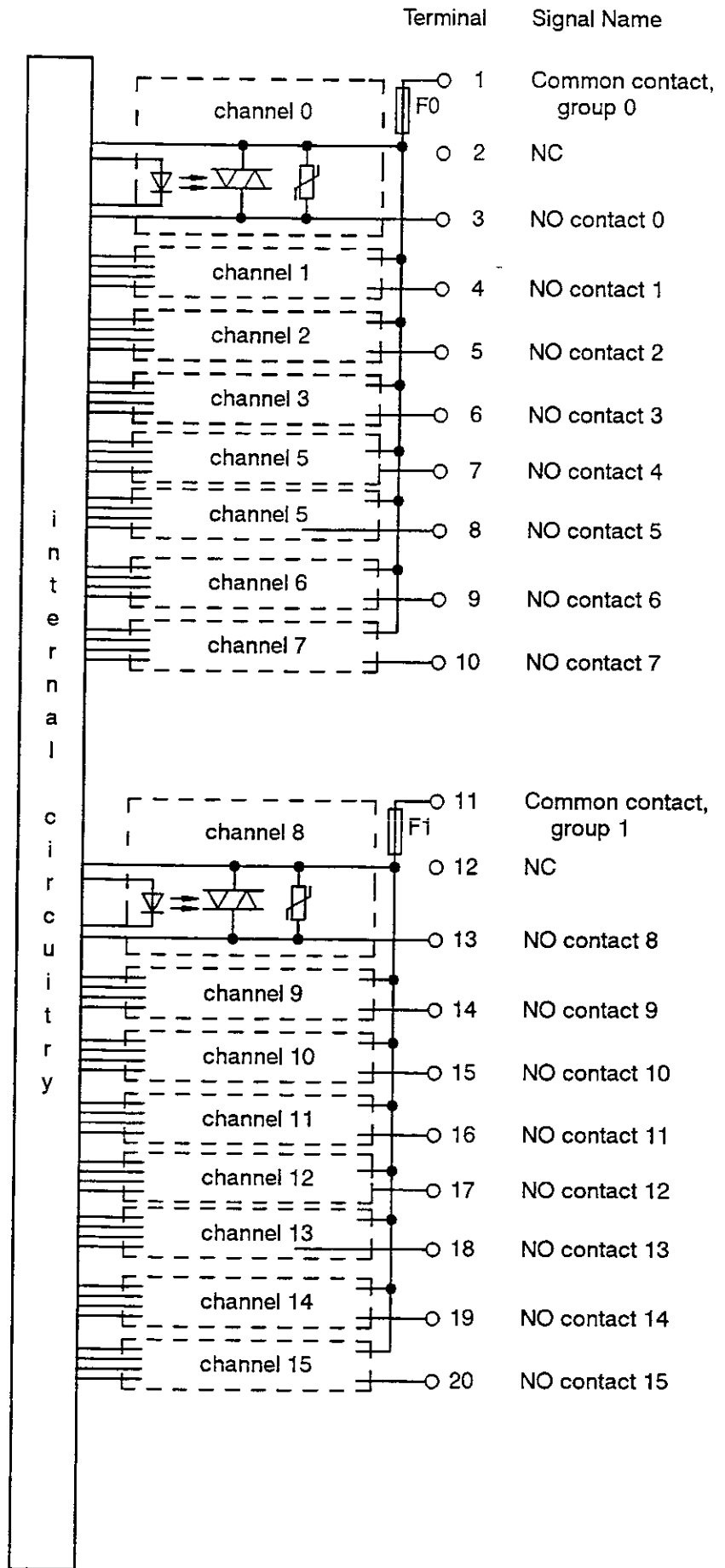
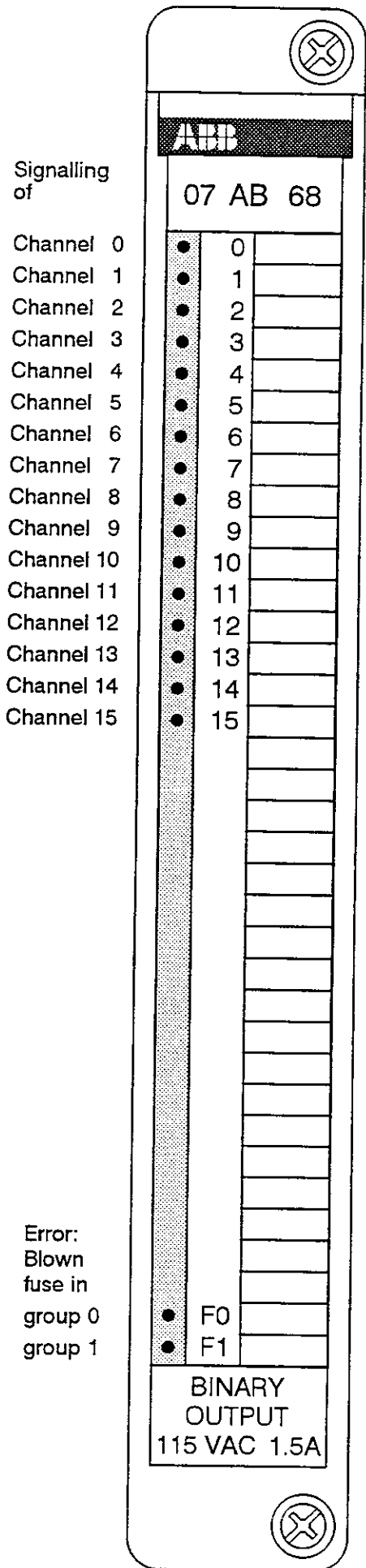

Fig. 10.9.1: 07 AB 68: Signalling, output circuitry, terminal assignment and signal names of channels

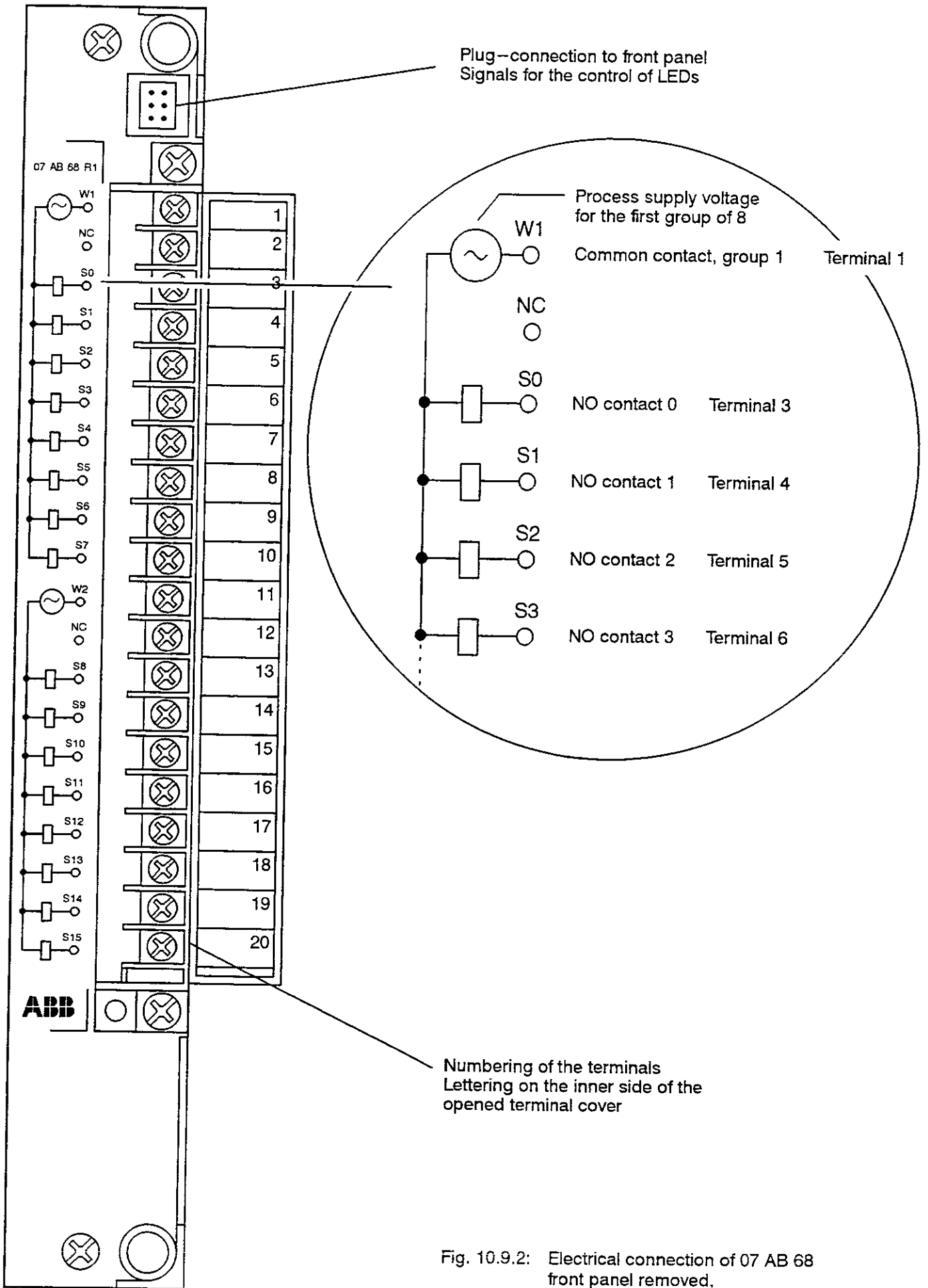

Fig. 10.9.2: Electrical connection of 07 AB 68 front panel removed, terminal cover opened

11 Analog Output Modules

07 AA 60 R1:	Analog Output Module,	0 ... 10 V,	8 bits, 4 channels, electrically isolated
07 AA 61 R1:	Analog Output Module,	4 ... 20 mA,	8 bits, 4 channels, electrically isolated
07 AA 62 R1:	Analog Output Module,	-10 ... +10 V,	12 bits, 4 channels, electrically isolated
07 AA 63 R1:	Analog Output Module,	4 ... 20 mA,	12 bits, 4 channels, electrically isolated
07 AA 65 R1:	Analog Output Module,	0 ... 20 mA,	8 bits, 4 channels, electrically isolated

11.1 Analog Output Module 07 AA 60 R1

0...10 V, 8 bits, 4 channels, electrically isolated

The analog output module 07 AA 60 converts internal binary codes to output signal voltages of 0...10 V, working with a resolution of 8 bits. At each of the 4 channels the analog process signals can be connected with two wires.

The function block ANAO within 907 PC 32 converts the internal codes to the corresponding range of 0...10 V.

All 0V terminals marked with (-) are connected together inside the module and form the common reference potential. The analog output circuitry is electrically isolated.

Care has to be taken for correct grounding and shielding of signal cables, signal receivers and reference potentials of outputs.

Technical Data

Number of outputs per module	4																											
Electrical isolation	yes, common reference potential																											
Nominal insulation voltage, process terminals versus subrack and internal connections:																												
acc. VDE 0160	60 V AC																											
tested with	500 V AC																											
Output data																												
output voltage range	0...10 V																											
0...100 % corresponds to hexadecimal representation before conversion	XX00...XXFF (The two most significant digits are not evaluated.)																											
hexadecimal representation by using ANAO exceeding of nominal output voltage range	see Table 11.1.1																											
output load capability	not possible																											
load resistance	max. 1 mA																											
resolution (1 LSB)	min. 10 kΩ																											
adjustment inaccuracy on delivery	39 mV																											
non-linearity	max. ± 1 % of full scale																											
temperature coefficient (full scale)	max. ± 1/2 LSB																											
Short-circuit-proof	max. ± 1.75 mV/K																											
Behaviour of outputs, when supply voltage is switched on	yes, versus reference potential, output is current-limited																											
Conversion rate	output signal valid after 70 ms																											
Supply current from internal voltages	5 ms																											
UB1 = 5 V DC	max. 70 mA																											
UB4 = 24 V DC	max. 80 mA																											
Power dissipation	max. 1.98 W																											
Cable length, if cables have been laid parallel in cable duct, shielded	max. 20 m																											
two-core shielded and cross section ≥ 0.5 mm ²	max. 100 m																											
Conductor cross section of process terminals	max. 1.5 mm ²																											
Signalling of the output signals	no signalling																											
Number of required slots	1 I/O slot																											
Number of occupied I/O points	64																											
Configuration identifier in 907 PC 32	AW4																											
Ability of fitting in subracks																												
slots, ● = plug-in is possible	<table border="1" style="border-collapse: collapse; text-align: center; width: 100%;"> <thead> <tr> <th colspan="3">BT</th> <th colspan="3">BE-central</th> <th colspan="3">BE-remote</th> </tr> <tr> <th>NG</th> <th>ZE</th> <th>I/O</th> <th>NG</th> <th>BV</th> <th>I/O</th> <th>NG</th> <th>BV</th> <th>I/O</th> </tr> </thead> <tbody> <tr> <td></td> <td></td> <td>●</td> <td></td> <td></td> <td>●</td> <td></td> <td></td> <td>●</td> </tr> </tbody> </table>	BT			BE-central			BE-remote			NG	ZE	I/O	NG	BV	I/O	NG	BV	I/O			●			●			●
BT			BE-central			BE-remote																						
NG	ZE	I/O	NG	BV	I/O	NG	BV	I/O																				
		●			●			●																				
Weight	500 g																											
Order number	GJV3074365R1																											

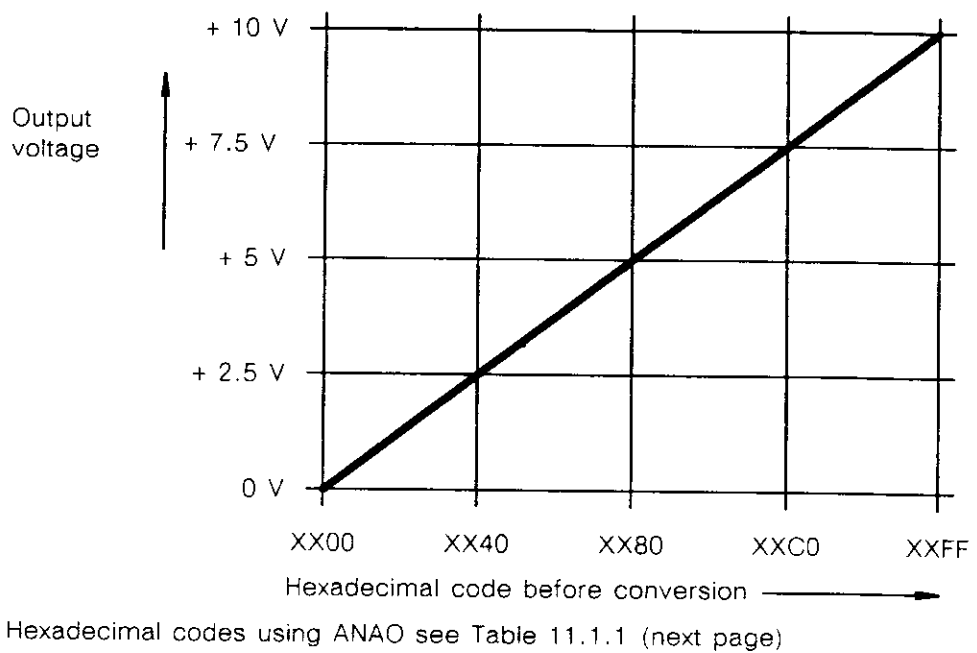
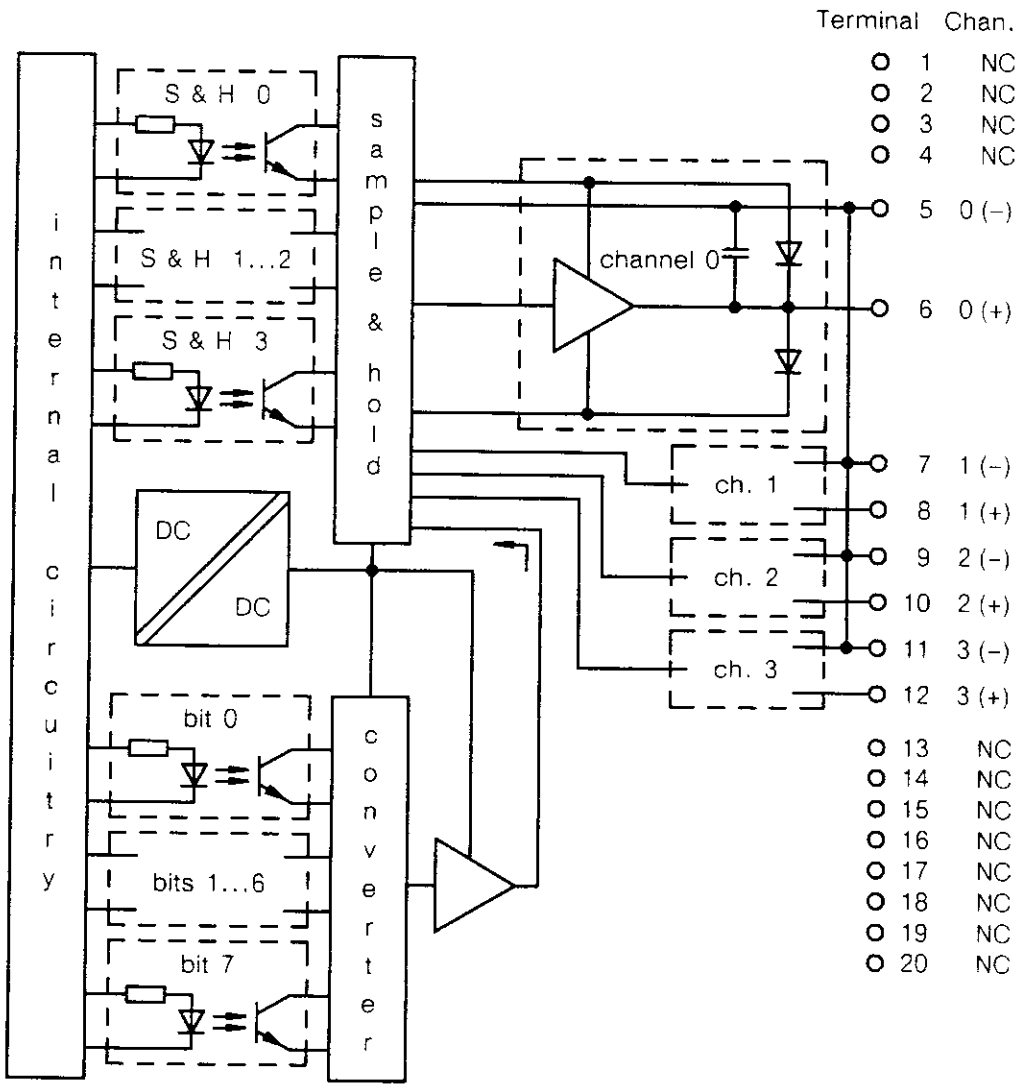
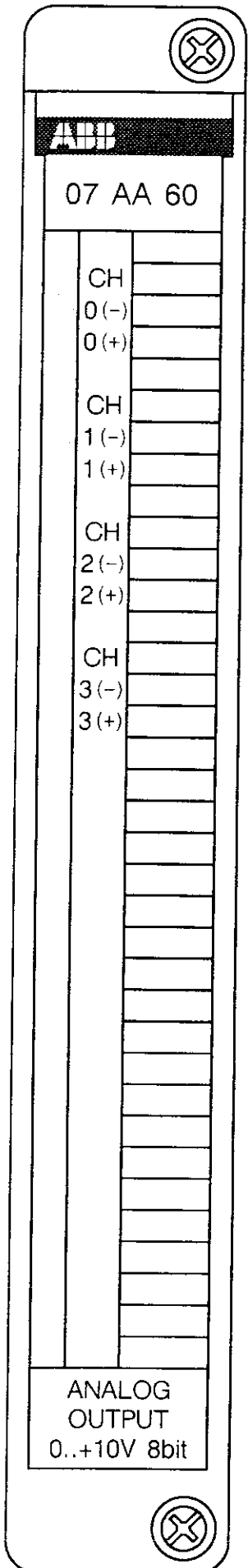
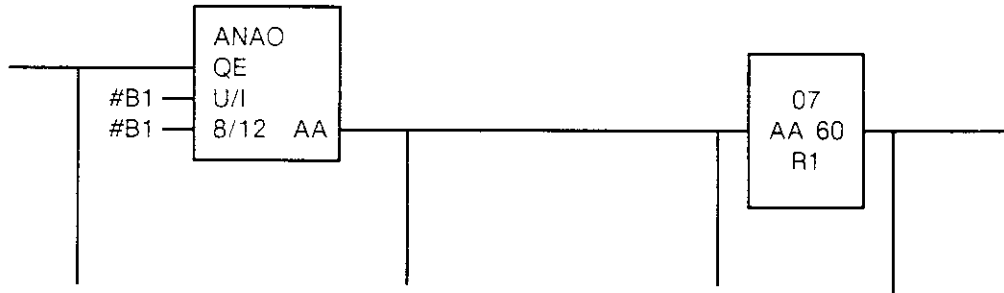

Fig. 11.1.1: 07 AA 60: Output circuitry, terminal assignment and conversion diagram of channels



Hexcode internal = input ANAO	Decimal equivalent	Hex-code output ANAO	Decimal equivalent	Hex-code input AA 60	Output voltage AA 60	Percentage of full scale
8001...FFFF	-32767...-1	0000	0	XX00	0.0 V	0 %
0000	0	0000	0	XX00	0.0 V	0 %
0400	1024	0040	64	XX40	2.5 V	25 %
0800	2048	0080	128	XX80	5.0 V	50 %
0C00	3072	00C0	192	XXC0	7.5 V	75 %
0FF0	4080	00FF	255	XXFF	10.0 V	100 %
0FF1...7FFF	4081...32767	00FF	255	XXFF	10.0 V	100 %

The two most significant digits are not evaluated by the analog output module

Table 11.1.1: Conversion table 07 AA 60 R1

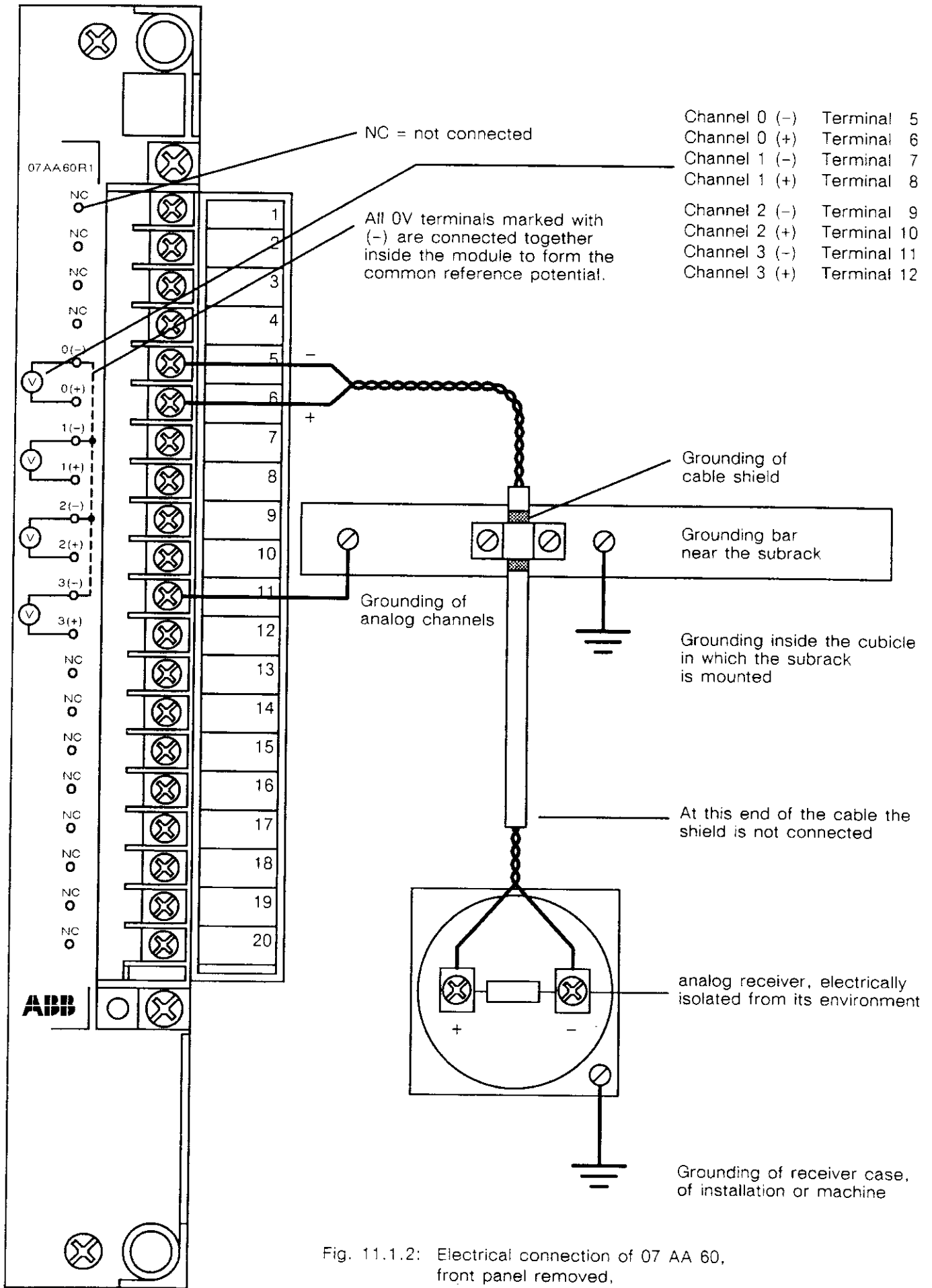

Fig. 11.1.2: Electrical connection of 07 AA 60, front panel removed, terminal cover opened

11.2 Analog Output Module 07 AA 61 R1

4...20 mA, 8 bits, 4 channels, electrically isolated

The analog output module 07 AA 61 converts internal binary codes to output signal currents of 4...20 mA, working with a resolution of 8 bits. At each of the 4 channels the analog process signals can be connected with two wires.

All 0V terminals marked with (-) are connected together inside the module and form the common reference potential. The analog output circuitry is electrically isolated.

The function block ANAO within 907 PC 32 converts the internal codes to the corresponding range of 4...20 mA.

Care has to be taken for correct grounding and shielding of signal cables, signal receivers and reference potentials of outputs.

Technical Data

Number of outputs per module	4
Electrical isolation	yes, common reference potential
Nominal insulation voltage, process terminals versus subrack and internal connections: acc. VDE 0160 tested with	60 V AC 500 V AC
Output data	
output current range	4...20 mA
0...100 % corresponds to hexadecimal representation before conversion	XX00...XXFF (The two most significant digits are not evaluated.)
hexadecimal representation by using ANAO exceeding of nominal output current range	see Table 11.2.1
open-circuit monitoring, if output current < 4 mA	not possible
load resistance	not existing
resolution (1 LSB)	0...500 Ω
adjustment inaccuracy on delivery	62.5 μA
non-linearity	max. ± 1 % of full scale
temperature coefficient (full scale)	max. ± 1/2 LSB
Behaviour of outputs, when supply voltage is switched on	max. ± 2.78 μA/K
Conversion rate	output signal valid after 70 ms
Supply current from internal voltages UB1 = 5 V DC UB4 = 24 V DC	5 ms
Power dissipation	max. 70 mA
Cable length, if cables have been laid parallel in cable duct, shielded two-core shielded and cross section ≥ 0.5 mm ²	max. 170 mA
Conductor cross section of process terminals	max. 4.43 W
Signalling of the output signals	max. 50 m
Number of required slots	max. 200 m
Number of occupied I/O points	max. 1.5 mm ²
Configuration identifier in 907 PC 32	no signalling
Ability of fitting in subracks	1 I/O slot
slots, ● = plug-in is possible	64
Weight	AW4
Order number	

BT			BE-central			BE-remote		
NG	ZE	I/O	NG	BV	I/O	NG	BV	I/O
		●			●			●

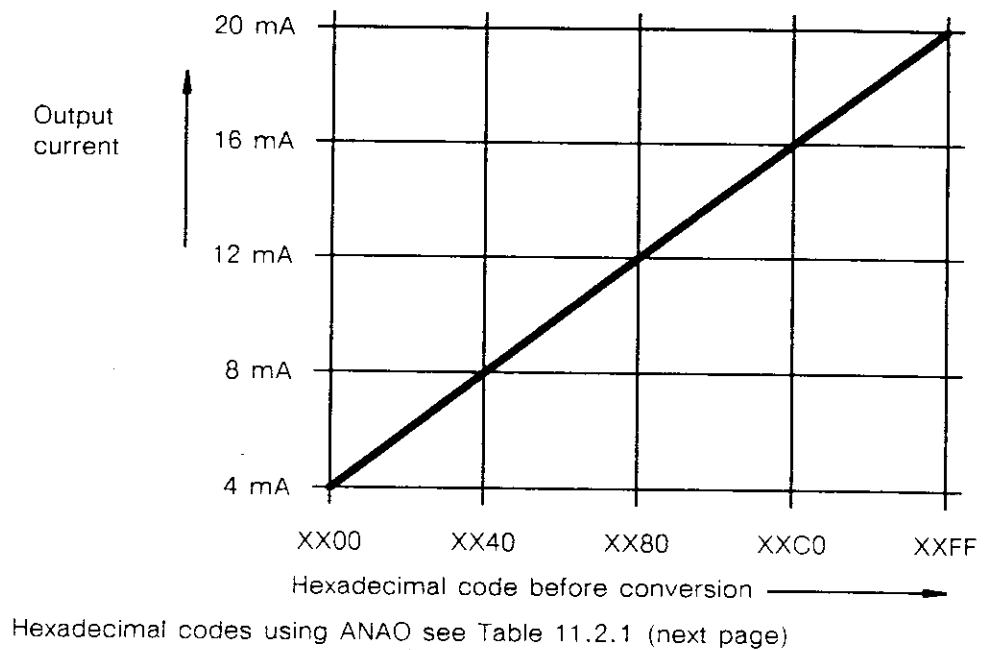
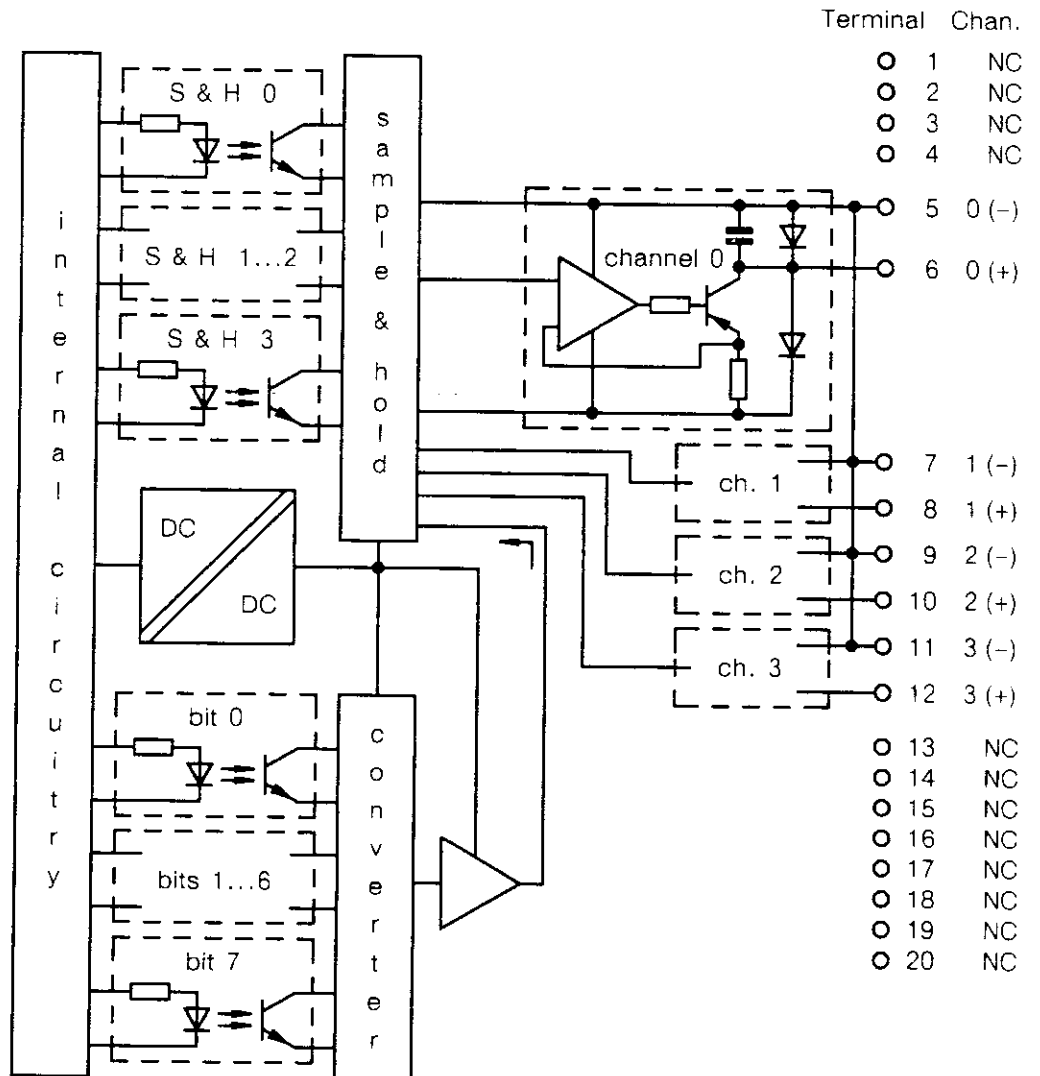
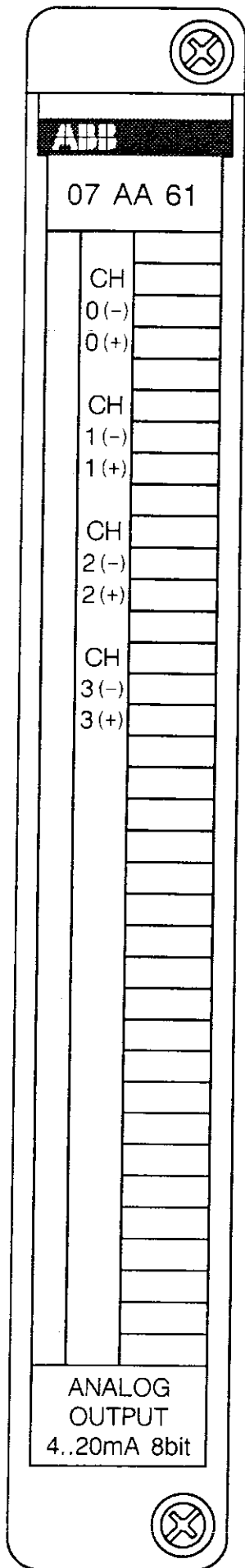
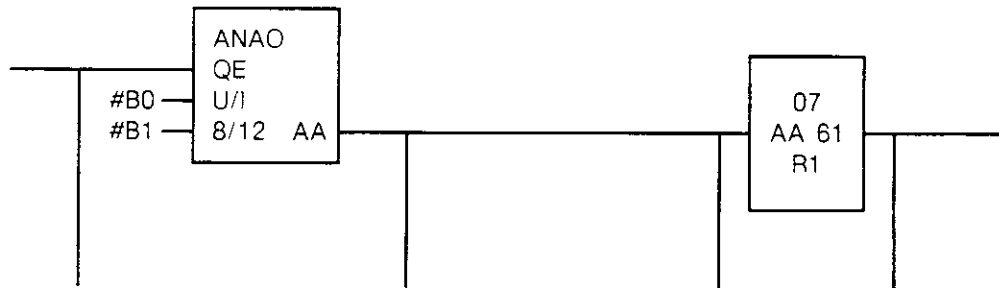

Fig. 11.2.1: 07 AA 61: Output circuitry, terminal assignment and conversion diagram of channels



Hexcode internal = input ANAO	Decimal equivalent	Hex-code output ANAO	Decimal equivalent	Hex-code input AA 61	Output current AA 61	Percentage of full scale
8001...FFFF	-32767...-1	0000	0	XX00	4.0 mA	0 %
0000	0	0000	0	XX00	4.0 mA	0 %
0400	1024	0040	64	XX40	8.0 mA	25 %
0800	2048	0080	128	XX80	12.0 mA	50 %
0C00	3072	00C0	192	XXC0	16.0 mA	75 %
0FF0	4080	00FF	255	XXFF	20.0 mA	100 %
0FF1...7FFF	4081...32767	00FF	255	XXFF	20.0 mA	100 %

The two most significant digits are not evaluated by the analog output module

Table 11.2.1: Conversion table 07 AA 61 R1

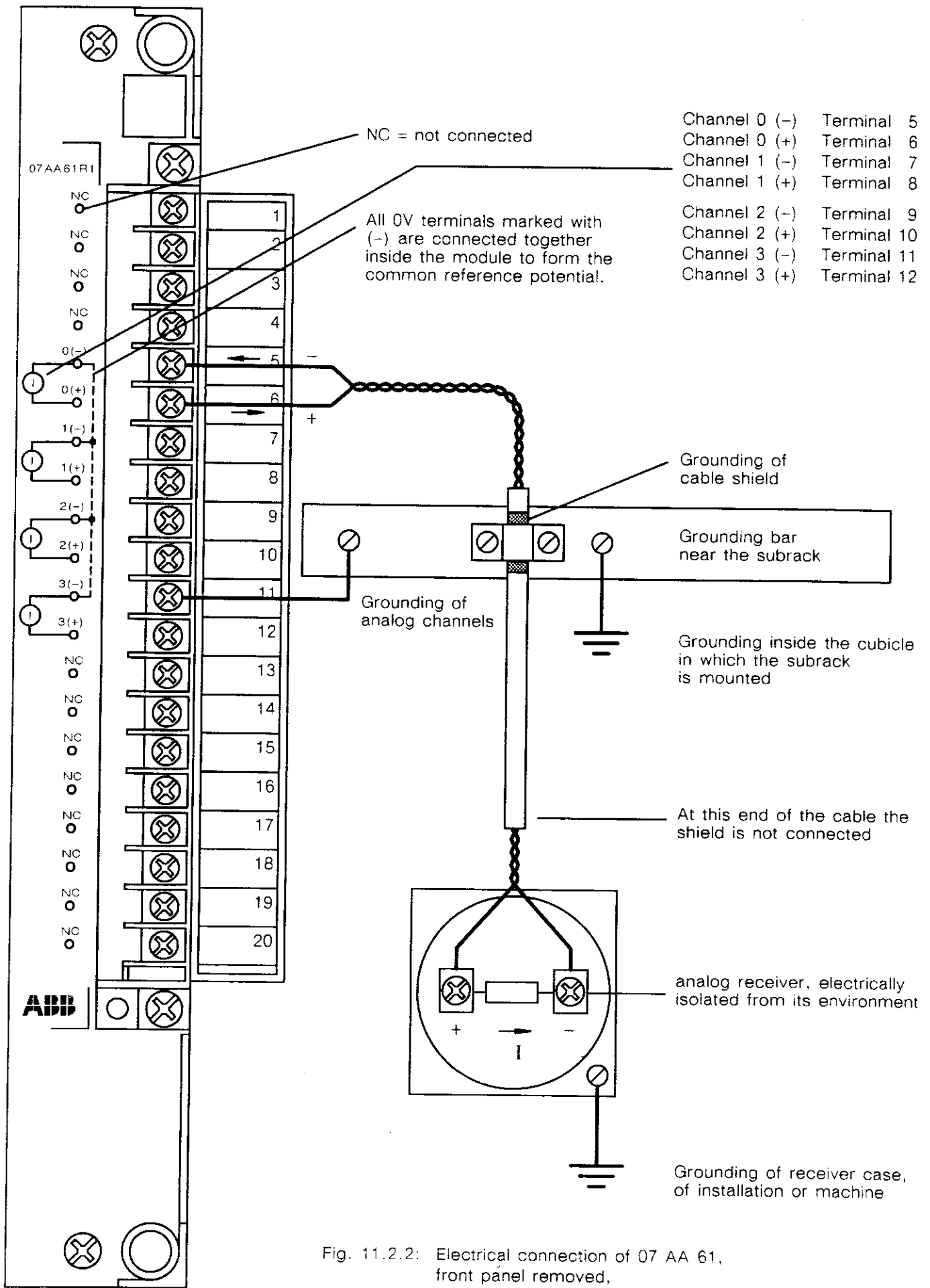

Fig. 11.2.2: Electrical connection of 07 AA 61, front panel removed, terminal cover opened

11.3 Analog Output Module 07 AA 62 R1

– 10...+ 10 V, 12 bits, 4 channels, electrically isolated

The analog output module 07 AA 62 converts internal binary codes to output signal voltages of – 10...+ 10 V, working with a resolution of 12 bits. At each of the 4 channels the analog process signals can be connected with two wires.

All 0V terminals marked with (–) are connected together inside the module and form the common reference potential. Terminals marked with (+) represent the analog outputs (– 10 V...+ 10 V). The analog output circuitry is electrically isolated.

The function block ANAO within 907 PC 32 converts the internal codes to the corresponding range of – 10...+ 10 V.

Care has to be taken for correct grounding and shielding of signal cables, signal receivers and reference potentials of outputs.

Technical Data

Number of outputs per module	4																											
Electrical isolation	yes, common reference potential																											
Nominal insulation voltage, process terminals versus subrack and internal connections:																												
acc. VDE 0160	60 V AC																											
tested with	500 V AC																											
Output data																												
output voltage range	– 10...+ 10 V																											
– 100...+ 100 % corresponds to hexadecimal representation before conversion																												
positive voltage range	X000...X7FF (The most significant digit XFFF...X800 is not evaluated.)																											
negative voltage range	see Table 11.3.1																											
hexadecimal representation by using ANAO exceeding of nominal output voltage range	not possible																											
output load capability	max. ± 1 mA																											
load resistance	min. 10 kΩ																											
resolution (1 LSB)	4.9 mV																											
adjustment inaccuracy on delivery	max. ± 1 % of full scale																											
non-linearity	max. ± 1/4 LSB																											
temperature coefficient (full scale)	max. ± 0.43 mV/K																											
Short-circuit-proof	yes, versus reference potential, output is current-limited																											
Behaviour of outputs, when supply voltage is switched on	output signal valid after 70 ms																											
Conversion rate	5 ms																											
Supply current from internal voltages																												
UB1 = 5 V DC	max. 60 mA																											
UB4 = 24 V DC	max. 100 mA																											
Power dissipation	max. 2.70 W																											
Cable length, if cables have been laid parallel in cable duct, shielded	max. 20 m																											
two-core shielded and cross section ≥ 0.5 mm ²	max. 100 m																											
Conductor cross section of process terminals	max. 1.5 mm ²																											
Signalling of the output signals	no signalling																											
Number of required slots	1 I/O slot																											
Number of occupied I/O points	64																											
Configuration identifier in 907 PC 32	AW4																											
Ability of fitting in subracks																												
slots, ● = plug-in is possible	<table border="1" style="border-collapse: collapse; text-align: center; width: 100%;"> <thead> <tr> <th colspan="3">BT</th> <th colspan="3">BE-central</th> <th colspan="3">BE-remote</th> </tr> <tr> <th>NG</th> <th>ZE</th> <th>I/O</th> <th>NG</th> <th>BV</th> <th>I/O</th> <th>NG</th> <th>BV</th> <th>I/O</th> </tr> </thead> <tbody> <tr> <td></td> <td></td> <td>●</td> <td></td> <td></td> <td>●</td> <td></td> <td></td> <td>●</td> </tr> </tbody> </table>	BT			BE-central			BE-remote			NG	ZE	I/O	NG	BV	I/O	NG	BV	I/O			●			●			●
BT			BE-central			BE-remote																						
NG	ZE	I/O	NG	BV	I/O	NG	BV	I/O																				
		●			●			●																				
Weight	500 g																											
Order number	GJV3074367R1																											

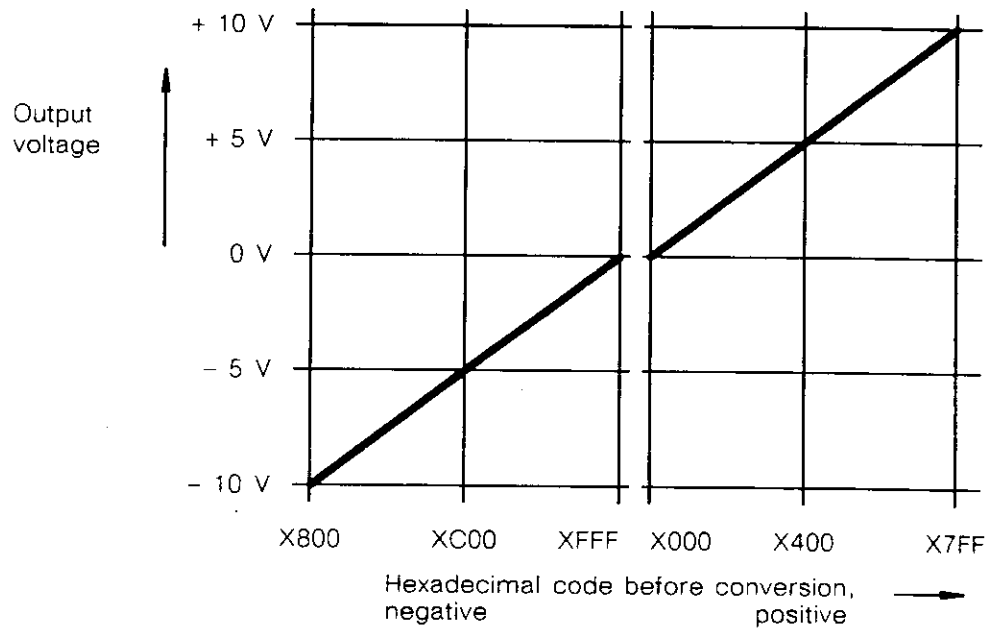
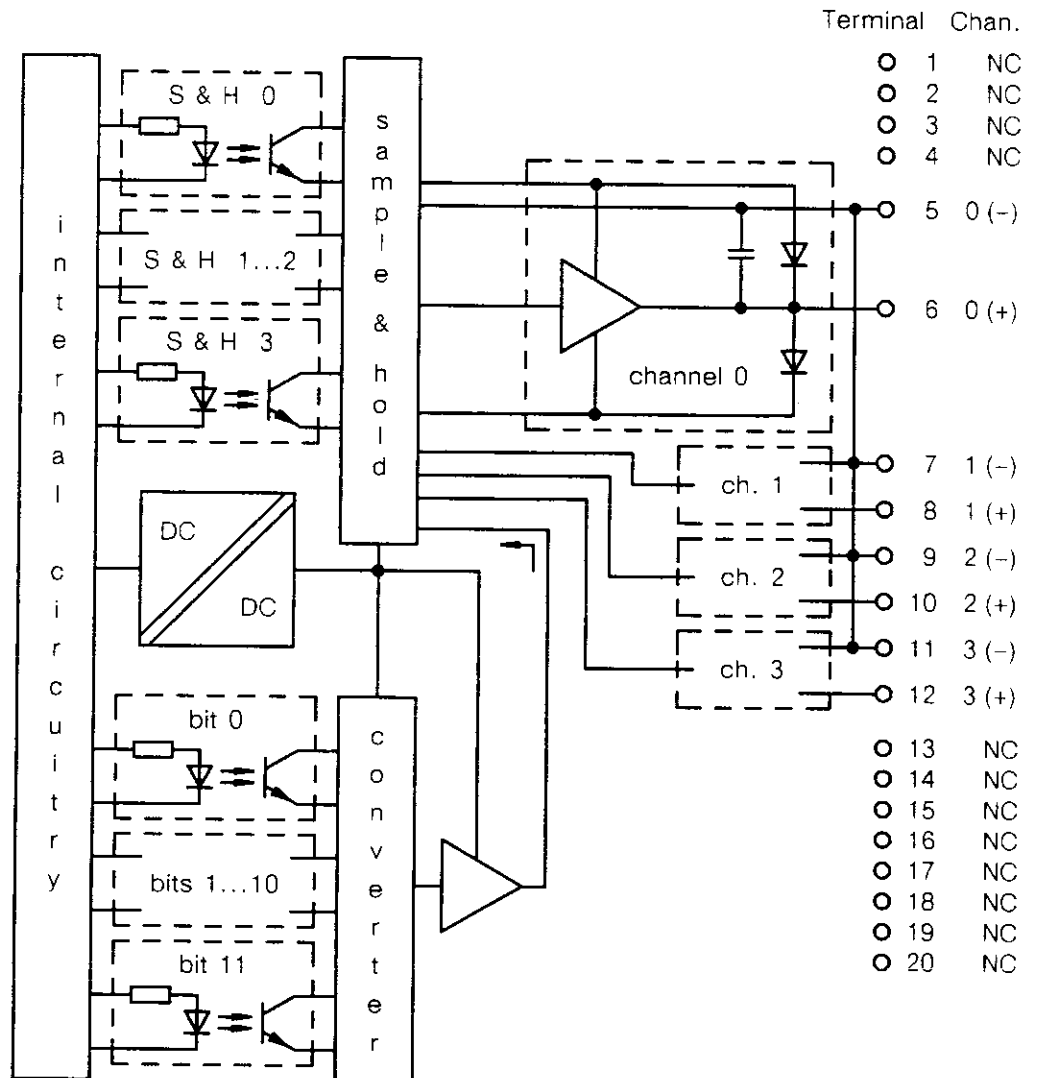
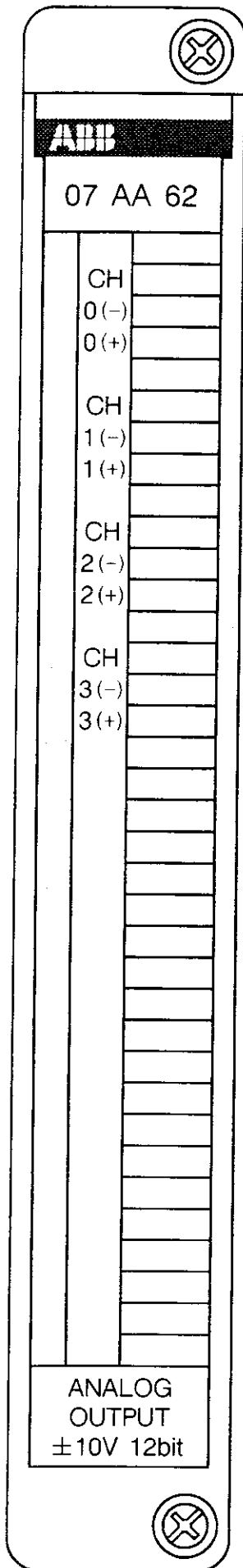

Hexadecimal codes using ANAO see Table 11.3.1 (next page)

Fig. 11.3.1: 07 AA 62: Output circuitry, terminal assignment and conversion diagram of channels

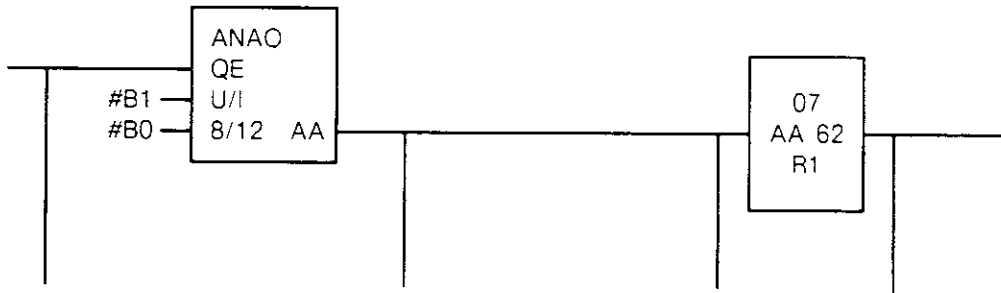

Hexcode internal = input ANAO	Decimal equivalent	Hex-code output ANAO	Decimal equivalent	Hex-code input AA 62	Output voltage AA 62	Percentage of full scale
8001...EFFF	-32767...-4097	F800	-2048	X800	-10.0 V	-100 %
F000	-4096	F800	-2048	X800	-10.0 V	-100 %
F400	-3072	FA00	-1536	XA00	- 7.5 V	- 75 %
F800	-2048	FC00	-1024	XC00	- 5.0 V	- 50 %
FC00	-1024	FE00	- 512	XE00	- 2.5 V	- 25 %
FFFE	- 2	FFFF	- 1	XFFF	- 0.0 V	0 %
0000	0	0000	0	X000	0.0 V	0 %
0400	1024	0200	512	X200	2.5 V	25 %
0800	2048	0400	1024	X400	5.0 V	50 %
0C00	3072	0600	1536	X600	7.5 V	75 %
0FFE	4094	07FF	2047	X7FF	10.0 V	100 %
0FFF...7FFF	4095...32767	07FF	2047	X7FF	10.0 V	100 %

The most significant digit is not evaluated by the analog output module

Table 11.3.1: Conversion table 07 AA 62 R1

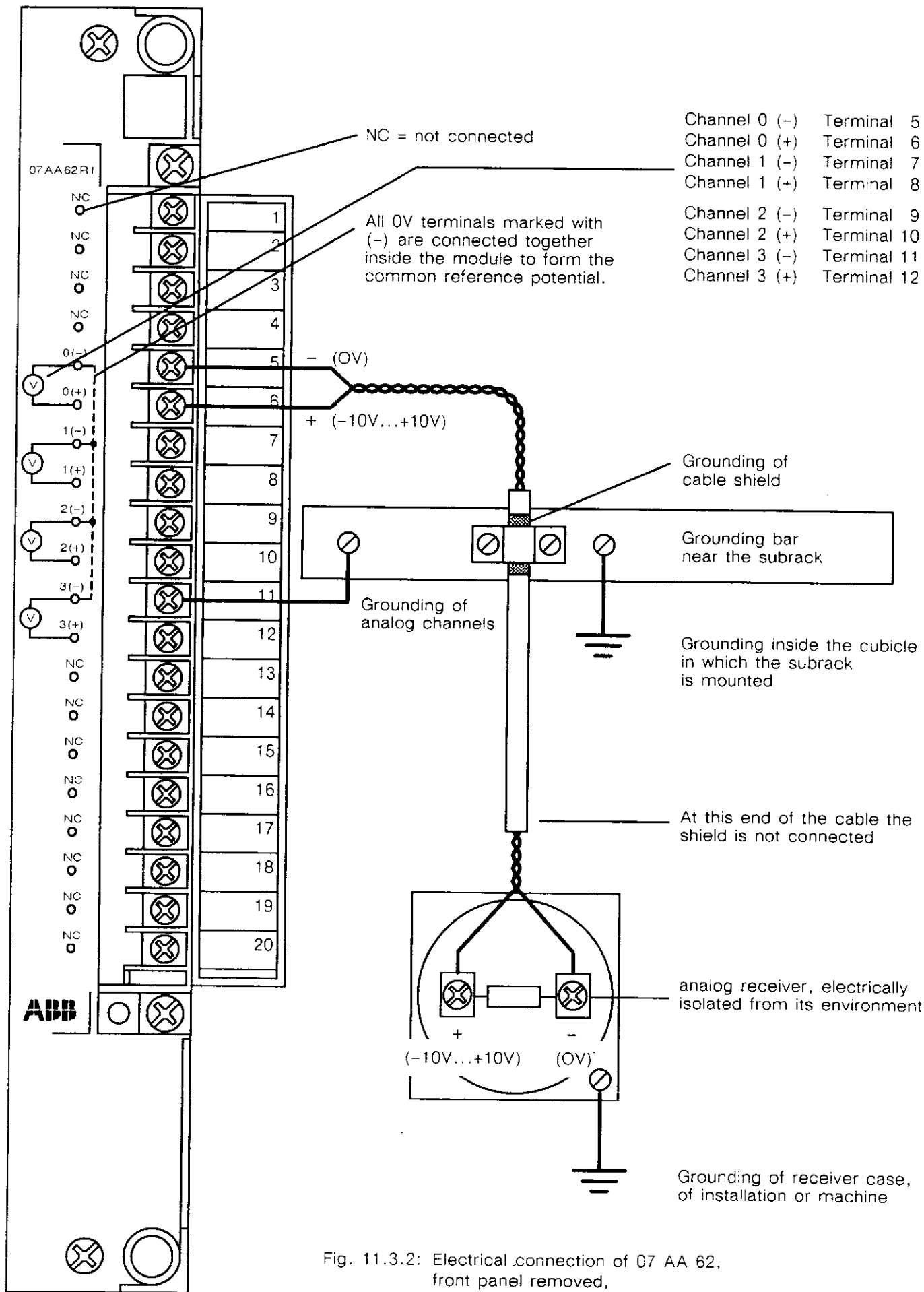

Fig. 11.3.2: Electrical connection of 07 AA 62, front panel removed, terminal cover opened

11.4 Analog Output Module 07 AA 63 R1

4...20 mA, 12 bits, 4 channels, electrically isolated

The analog output module 07 AA 63 converts internal binary codes to output signal currents of 4...20 mA, working with a resolution of 12 bits. At each of the 4 channels the analog process signals can be connected with two wires.

All 0V terminals marked with (-) are connected together inside the module and form the common reference potential. The analog output circuitry is electrically isolated.

The function block ANAO within 907 PC 32 converts the internal codes to the corresponding range of 4...20 mA.

Care has to be taken for correct grounding and shielding of signal cables, signal receivers and reference potentials of outputs.

Technical Data

Number of outputs per module	4																											
Electrical isolation	yes, common reference potential																											
Nominal insulation voltage, process terminals versus subrack and internal connections:																												
acc. VDE 0160	60 V AC																											
tested with	500 V AC																											
Output data																												
output current range	4...20 mA																											
0...100 % corresponds to	X000...XFFF (The most significant digit is not evaluated.)																											
hexadecimal representation before conversion	see Table 11.4.1																											
hexadecimal representation by using ANAO	not possible																											
exceeding of nominal output current range																												
open-circuit monitoring, if																												
output current < 4 mA	not existing																											
load resistance	0...500 Ω																											
resolution (1 LSB)	3.9 μA																											
adjustment inaccuracy on delivery	max. ± 1 % of full scale																											
non-linearity	max. ± 1/4 LSB																											
temperature coefficient (full scale)	max. ± 0.35 μA/K																											
Behaviour of outputs,																												
when supply voltage is switched on	output signal valid after 70 ms																											
Conversion rate	5 ms																											
Supply current from internal voltages																												
UB1 = 5 V DC	max. 60 mA																											
UB4 = 24 V DC	max. 190 mA																											
Power dissipation	max. 4.86 W																											
Cable length, if cables have been laid parallel																												
in cable duct, shielded	max. 50 m																											
two-core shielded and cross section ≥ 0.5 mm ²	max. 200 m																											
Conductor cross section of process terminals	max. 1.5 mm ²																											
Signalling of the output signals	no signalling																											
Number of required slots	1 I/O slot																											
Number of occupied I/O points	64																											
Configuration identifier in 907 PC 32	AW4																											
Ability of fitting in subracks																												
slots, ● = plug-in is possible	<table border="1" style="border-collapse: collapse; text-align: center; width: 100%;"> <tr> <td colspan="3">BT</td> <td colspan="3">BE-central</td> <td colspan="3">BE-remote</td> </tr> <tr> <td>NG</td> <td>ZE</td> <td>I/O</td> <td>NG</td> <td>BV</td> <td>I/O</td> <td>NG</td> <td>BV</td> <td>I/O</td> </tr> <tr> <td></td> <td></td> <td>●</td> <td></td> <td></td> <td>●</td> <td></td> <td></td> <td>●</td> </tr> </table>	BT			BE-central			BE-remote			NG	ZE	I/O	NG	BV	I/O	NG	BV	I/O			●			●			●
BT			BE-central			BE-remote																						
NG	ZE	I/O	NG	BV	I/O	NG	BV	I/O																				
		●			●			●																				
Weight	520 g																											
Order number	GJV3074368R1																											

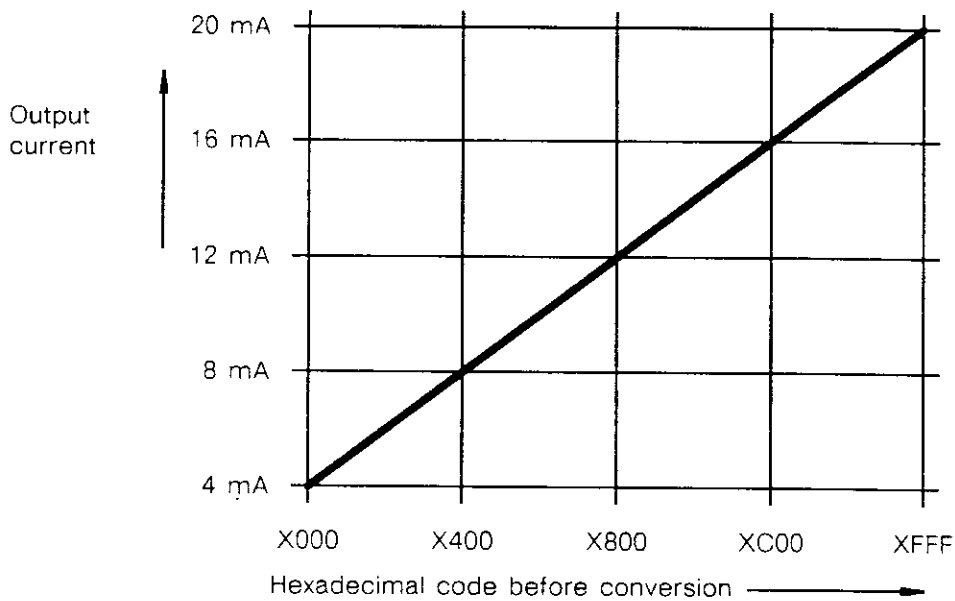
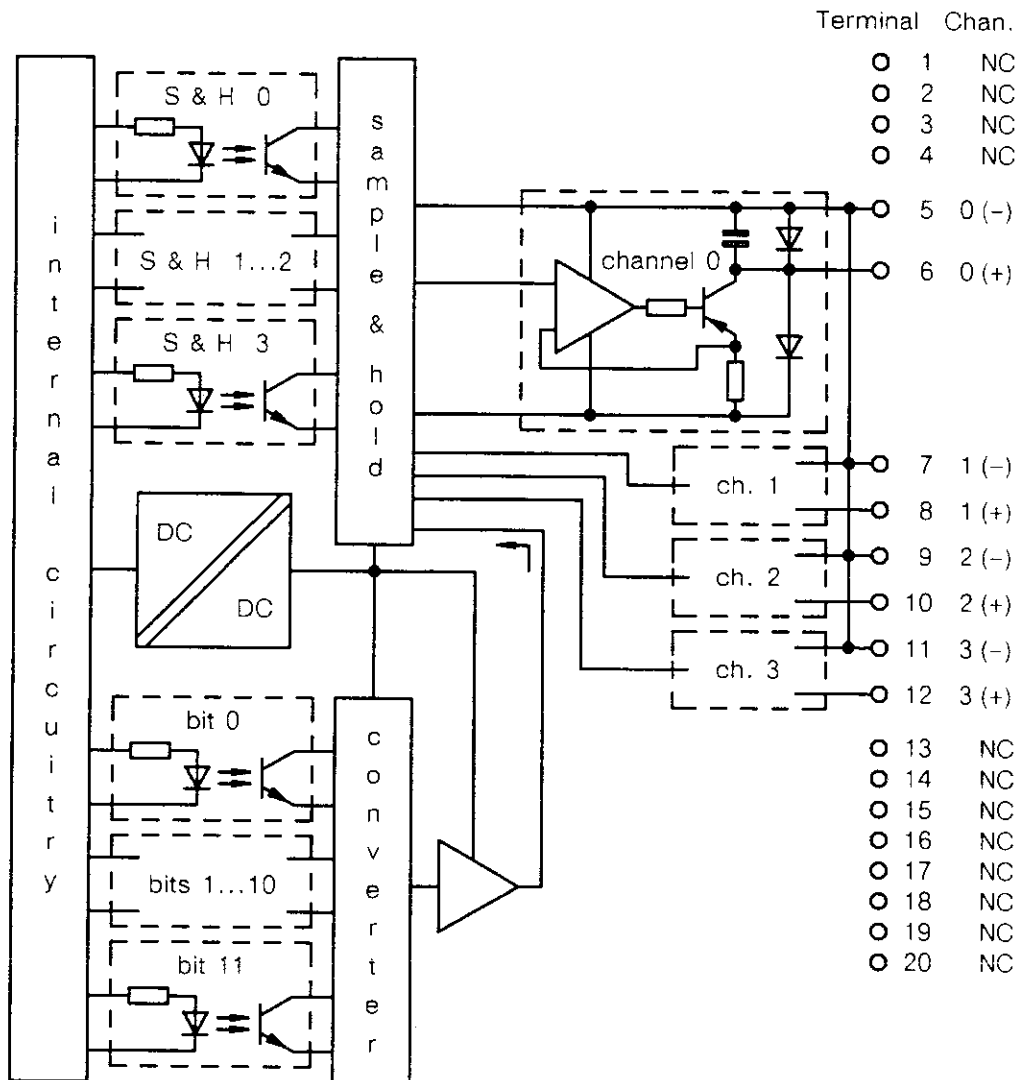
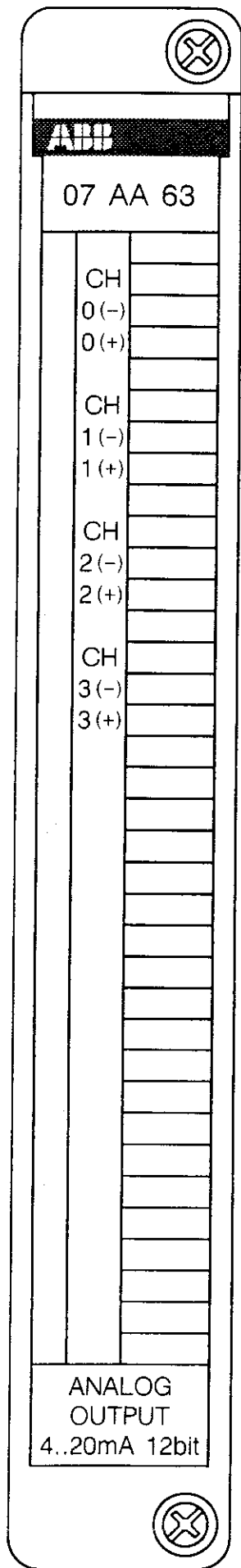

Hexadecimal codes using ANAO see Table 11.4.1 (next page)

Fig. 11.4.1: 07 AA 63: Output circuitry, terminal assignment and conversion diagram of channels

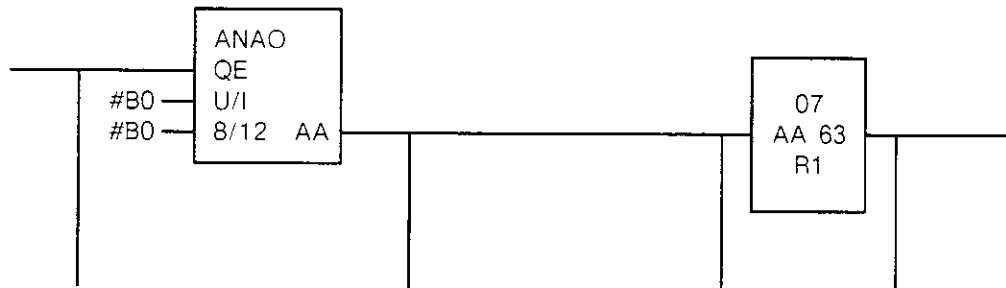

Hexcode internal = input ANAO	Decimal equivalent	Hex- code output ANAO	Decimal equi- valent	Hex- code input AA 63	Output current AA 63	Percentage of full scale
8001...FFFF	-32767...-1	0000	0	X000	4.0 mA	0 %
0000	0	0000	0	X000	4.0 mA	0 %
0400	1024	0400	1024	X400	8.0 mA	25 %
0800	2048	0800	2048	X800	12.0 mA	50 %
0C00	3072	0C00	3072	XC00	16.0 mA	75 %
0FFF	4095	0FFF	4095	XFFF	20.0 mA	100 %
1000...7FFF	4096...32767	0FFF	4095	XFFF	20.0 mA	100 %

The most significant digit is not evaluated by the analog output module

Table 11.4.1: Conversion table 07 AA 63 R1

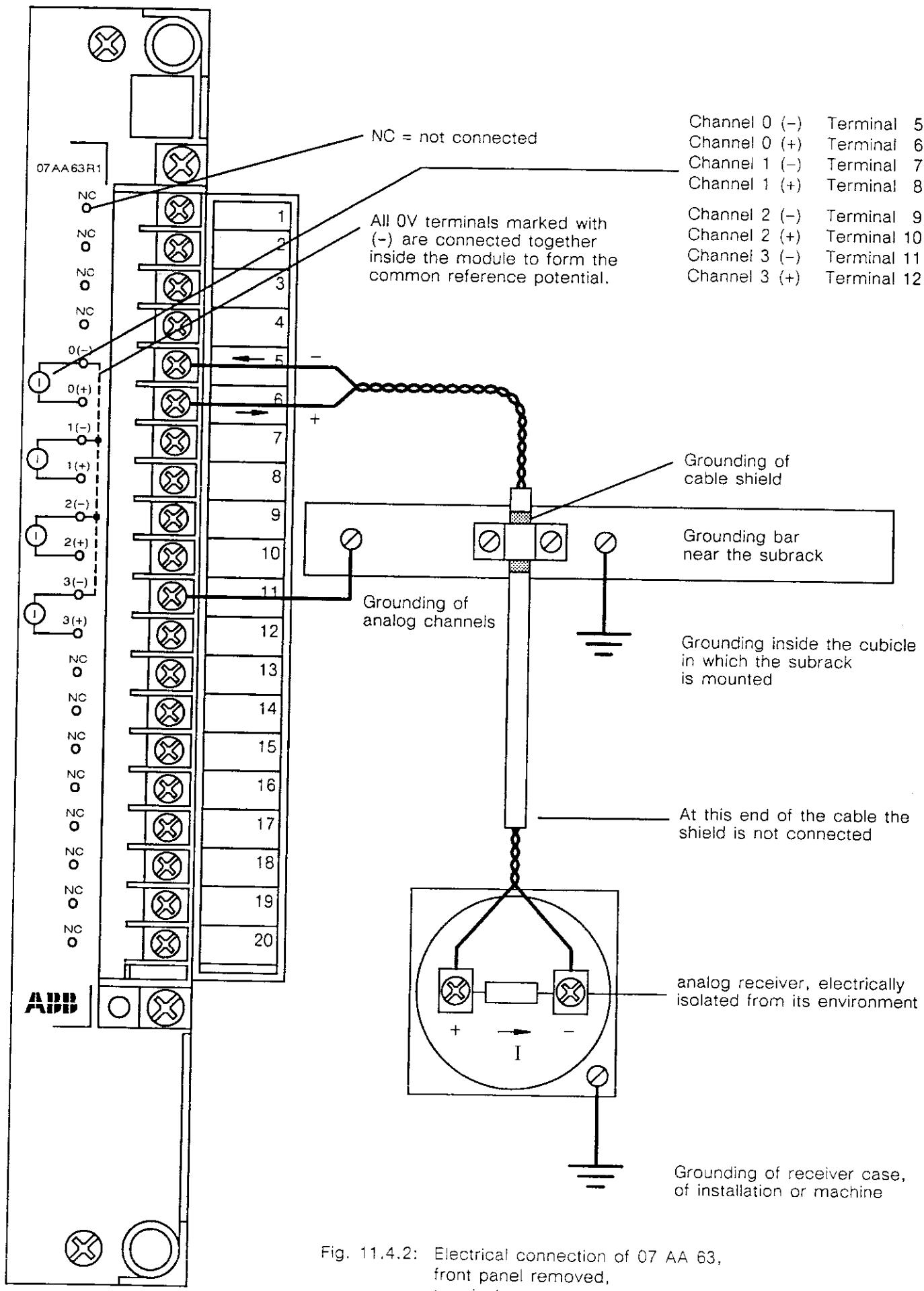

Fig. 11.4.2: Electrical connection of 07 AA 63, front panel removed, terminal cover opened

11.6 Analog Output Module 07 AA 65 R1

0...20 mA, 8 bits, 4 channels, electrically isolated

The analog output module 07 AA 65 converts internal binary codes to output signal currents of 0...20 mA, working with a resolution of 8 bits. At each of the 4 channels the analog process signals can be connected with two wires.

All 0V terminals marked with (-) are connected together inside the module and form the common reference potential. The analog output circuitry is electrically isolated.

The function block ANAO within 907 PC 33 converts the internal codes to the corresponding range of 0...20 mA.

Care has to be taken for correct grounding and shielding of signal cables, signal receivers and reference potentials of outputs.

Technical Data

Number of outputs per module	4																											
Electrical isolation	yes, common reference potential																											
Nominal insulation voltage, process terminals versus subrack and internal connections: acc. VDE 0160 tested with	60 V AC 500 V AC																											
Output data																												
output current range	0...20 mA																											
0...100 % corresponds to hexadecimal representation before conversion	XX00...XXFF (The two most significant digits are not evaluated.)																											
hexadecimal representation by using ANAO	see Table 11.6.1																											
exceeding of nominal output current range	not possible																											
open-circuit monitoring	not existing																											
load resistance	0...500 Ω																											
resolution (1 LSB)	78.1 μA																											
adjustment inaccuracy on delivery	max. ± 1 % of full scale																											
non-linearity	max. ± 1/2 LSB																											
temperature coefficient (full scale)	max. ± 3.48 μA/K																											
Behaviour of outputs, when supply voltage is switched on	output signal valid after 70 ms																											
Conversion rate	5 ms																											
Supply current from internal voltages UB1 = 5 V DC UB4 = 24 V DC	max. 70 mA max. 170 mA																											
Power dissipation	max. 4.43 W																											
Cable length, if cables have been laid parallel in cable duct, shielded two-core shielded and cross section ≥ 0.5 mm ²	max. 50 m max. 200 m																											
Conductor cross section of process terminals	max. 1.5 mm ²																											
Signalling of the output signals	no signalling																											
Number of required slots	1 I/O slot																											
Number of occupied I/O points	64																											
Configuration identifier in 907 PC 32	AW4																											
Ability of fitting in subracks slots, ● = plug-in is possible	<table border="1" style="border-collapse: collapse; text-align: center; width: 100%;"> <thead> <tr> <th colspan="3">BT</th> <th colspan="3">BE-central</th> <th colspan="3">BE-remote</th> </tr> <tr> <th>NG</th> <th>ZE</th> <th>I/O</th> <th>NG</th> <th>BV</th> <th>I/O</th> <th>NG</th> <th>BV</th> <th>I/O</th> </tr> </thead> <tbody> <tr> <td></td> <td></td> <td>●</td> <td></td> <td></td> <td>●</td> <td></td> <td></td> <td>●</td> </tr> </tbody> </table>	BT			BE-central			BE-remote			NG	ZE	I/O	NG	BV	I/O	NG	BV	I/O			●			●			●
BT			BE-central			BE-remote																						
NG	ZE	I/O	NG	BV	I/O	NG	BV	I/O																				
		●			●			●																				
Weight	510 g																											
Order number	GJV3074369R1																											

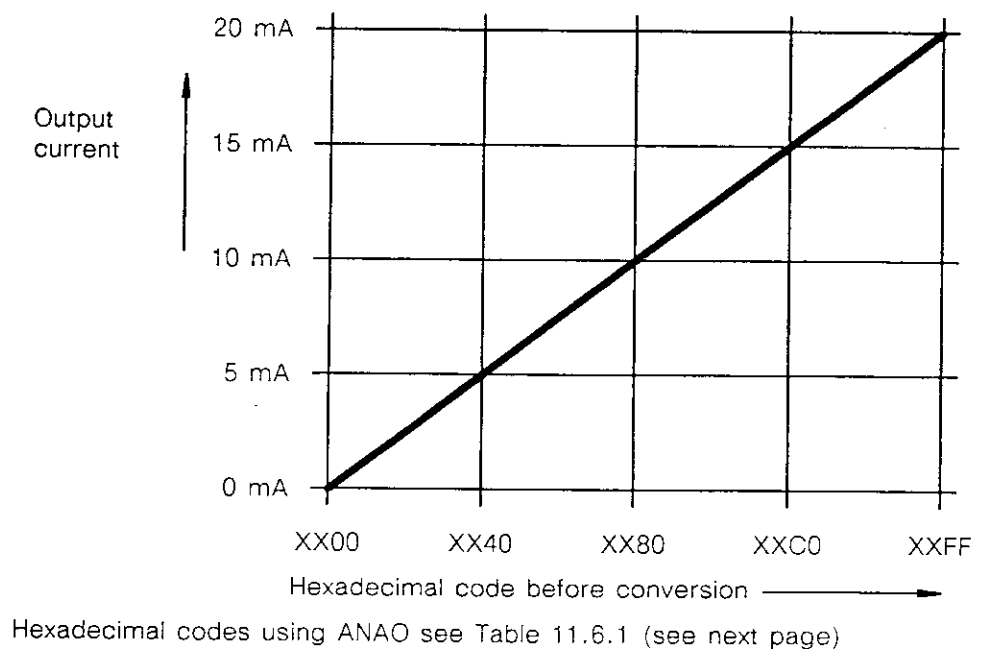
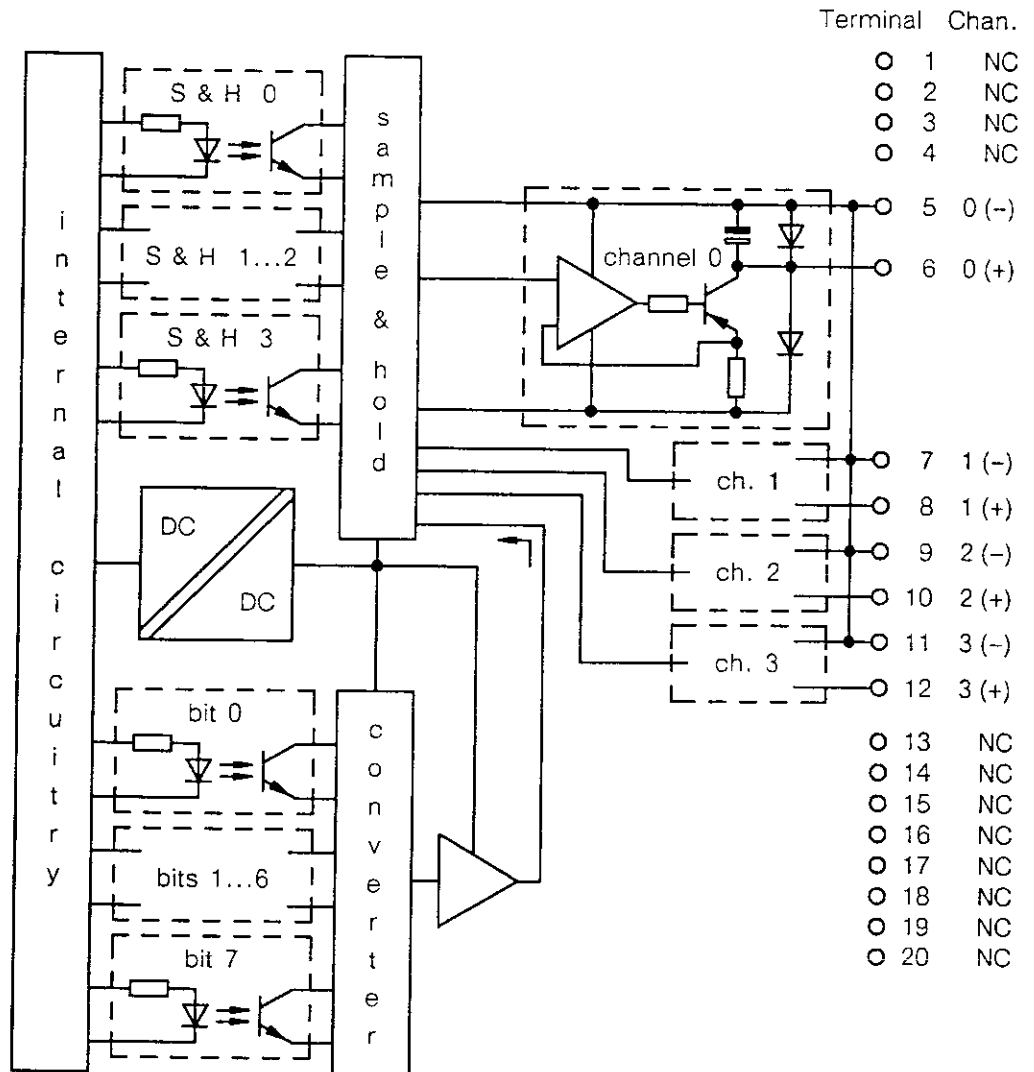
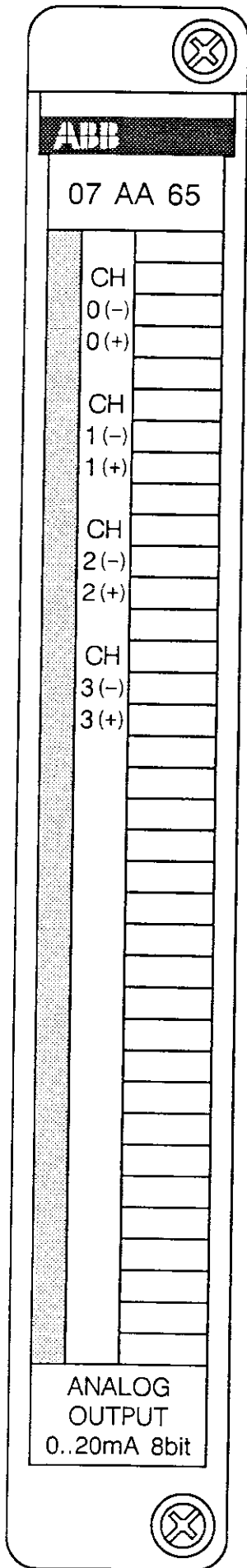

Fig. 11.6.1: 07 AA 65: Output circuitry, terminal assignment and conversion diagram of channels



Hexcode internal = input ANAO	Decimal equivalent	Hex- code output ANAO	Decimal equi- valent	Hex- code input AA 65	Output current AA 65	Percentage of full scale
8001...FFFF	-32767...-1	0000	0	XX00	0 mA	0 %
0000	0	0000	0	XX00	0 mA	0 %
0400	1024	0040	64	XX40	5 mA	25 %
0800	2048	0080	128	XX80	10 mA	50 %
0C00	3072	00C0	192	XXC0	15 mA	75 %
0FF0	4080	00FF	255	XXFF	20 mA	100 %
0FF1...7FFF	4081...32767	00FF	255	XXFF	20 mA	100 %

The two most significant digits are not evaluated by the analog output module

Table 11.6.1: Conversion table 07 AA 65 R1

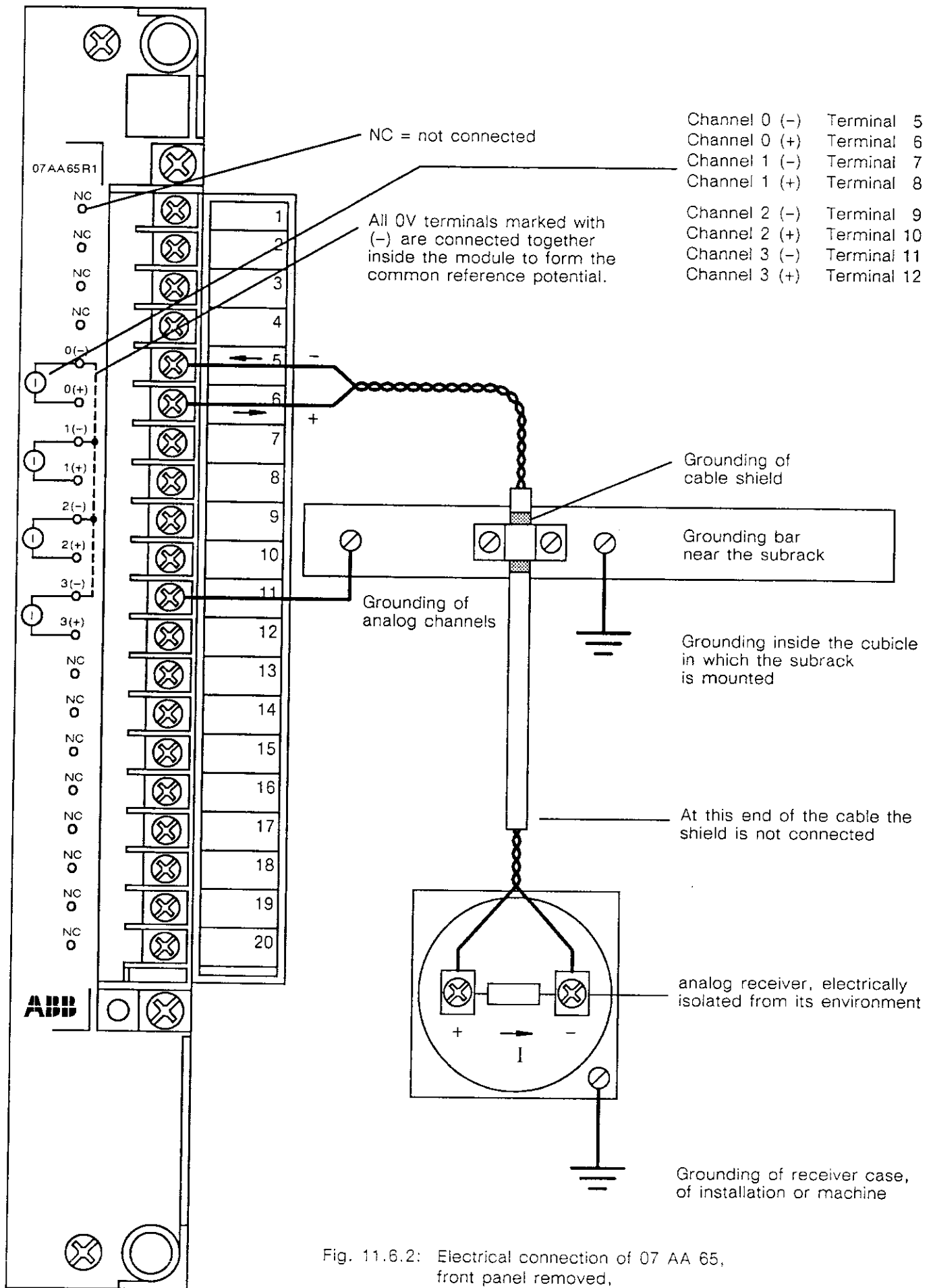

Fig. 11.6.2: Electrical connection of 07 AA 65, front panel removed, terminal cover opened

12 Communication Units

- 07 KP 60 R101: Communication processor,
intelligent serial interface module (interfaces for RS-232-C and RS-422)
- 07 KP 62 R101: Communication processor ASCII (2 interfaces for RS-232-C)
- 07 KP 63 R101: Communication processor PROFIBUS
(2 interfaces for RS-232-C and 2 interfaces for RS-485)
- 07 KP 64 R101: Communication processor RCOM (2 interfaces for RS-232-C)
- 07 KT 60 R101: Text processor,
intelligent serial interface module for output of texts
(interface for RS-422 or RS-423 (RS-232-C))

12.1 Communication processor 07 KP 60 R101 intelligent serial interface module (interfaces for RS-232-C and RS-422)

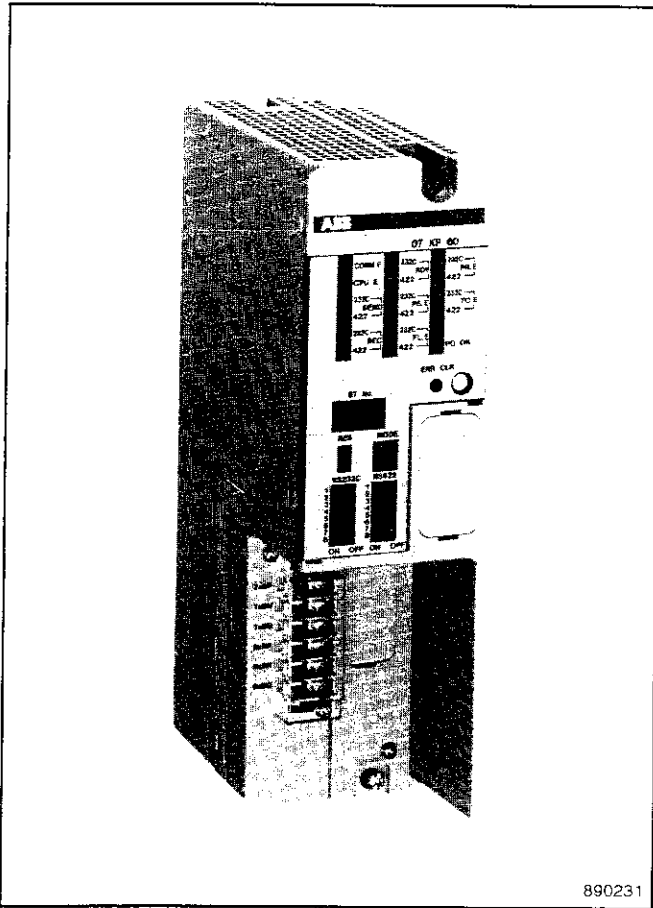

Fig. 12.1.1: Communication processor 07 KP 60 R101

Characteristics

The communication processor 07 KP 60 R101 enables the connection of ABB Procontic T200 controllers to external computers, e.g. ABB Procontic process display and control stations, using a fixed protocol (see Fig. 12.1.3 and 12.1.4).

Both RS-232-C and RS-422 interfaces are available. Via the RS-422 interface of the communication processor up to 32 systems can be connected, each at a distance of up to 250 m from one another.

The RS-232-C interface of the 07 KP 60 can be used, among other things, to connect local process display and control stations (35 BS 93 or 07 PM 11) to the central unit of the controller system. In addition, these stations can communicate with all other central units via the RS-422 network.

The 907 PC 32 programming and test system can be connected via the RS-232-C interface.

The 07 KP 60 R101 module has a housing with a removable, transparent front cover for the display and operating elements and a screw-on connector block with the interfaces.

It occupies two I/O slots and can be used up to 4 times in each basic subrack.

Light-emitting diodes are provided for signalling operation conditions. Further pushbuttons and switches are provided for testing and operating the module and for setting operating mode, mode number and interface parameters (see Fig. 12.1.2).

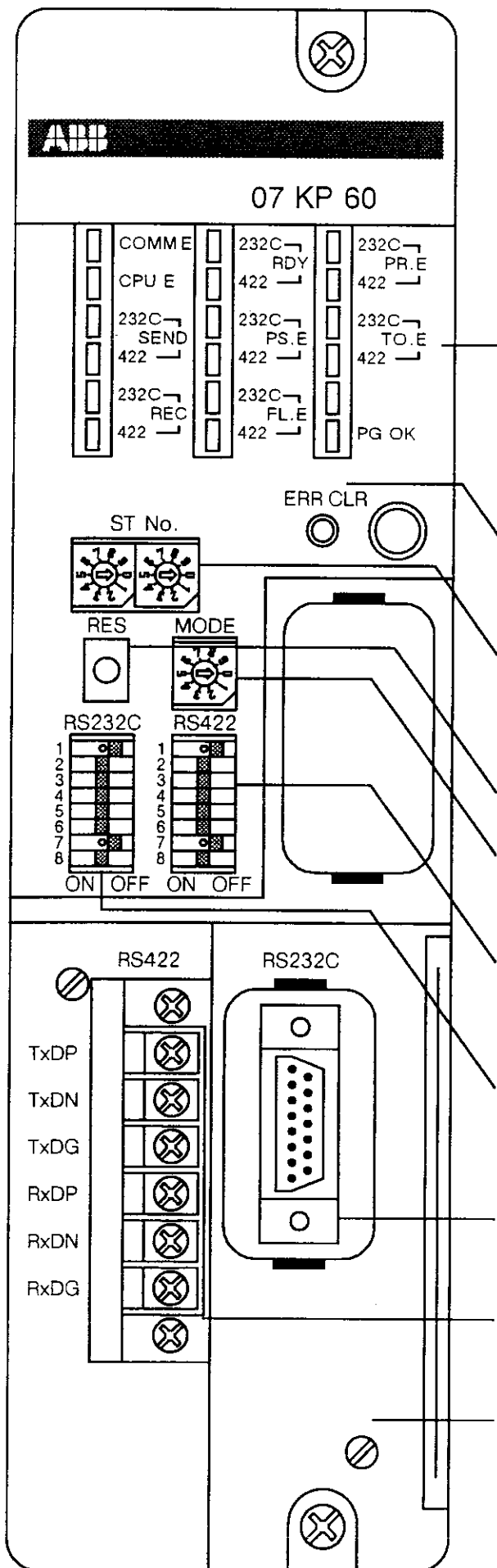

Indicator LEDs

The 18 indicator LEDs are described on the next page (Table 12.1.1). In order to ease the location of individual LEDs in the table, they are numbered consecutively as follows:

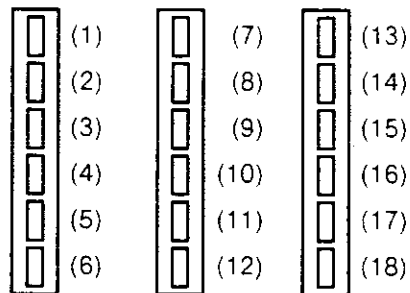

ERR CLR (Error Clear button)

By pressing this button, the errors of LEDs 1,2,7..16 are erased, provided the cause of error has been eliminated

ST No. (Station Number rotary switch)

Rotary switch for setting the station number when more than one 07 KP 60 is used. The setting is decimal (00...31). With settings > 31 mode number 31 is retained.

RES (Reset button)

Button for resetting the communication module

MODE (operating mode rotary switch)

Selection switch for setting the operating mode of the communication processor (see Table 12.1.2)

RS-422 Parameter switch

DIL switch for setting the interface parameters at the RS-422 interface. For assignment/significance of switches see Table 12.1.3

RS-232-C Parameter switch

DIL switch for setting the interface parameters at the RS-232-C interface. For assignment/significance of switches see Table 12.1.3

RS-232-C interface connector

RS-232-C interface (15 pole female), for connections, see Table 12.1.4

RS-422 terminal block

RS-422 interface (6 pole terminal block), for connections see Table 12.1.5

Connector block

Screw-on connector block with RS-422 and RS-232-C interfaces

Fig. 12.1.2: 07 KP 60 R101 module with description of display and operating elements and interfaces

Table 12.1.1: Description of LED signalling (see Fig. 12.1.2)

No.	Name	LED "on"	LED "off"
(1)	COMM E	Time monitoring error, detected by hardware; ROM/RAM error, detected by software	after resetting after resetting
(2)	CPU E	communication error between central unit and KP	after resetting
(3)	232-C-SEND	data transmission via RS-232-C in progress	data transmission via RS-232-C not in progress
(4)	422-SEND	data transmission via RS-422 in progress	data transmission via RS-422 not in progress
(5)	232-C-REC	data reception via RS-232-C in prog	data reception via RS-232-C not in progress
(6)	422-REC	data reception via RS-422 in progr.	data reception via RS-422 not in progress
(7)	232-C-RDY	KP 60 ready to receive data via RS-232-C	KP 60 receiving data from host via RS-232-C
(8)	422-RDY	KP 60 ready to receive data via RS-422	KP 60 receiving data from host via RS-422
(9)	232-C-PS. E	after reception of an instruction (RS-232-C) parity error detected; or after reception of an instruction (RS-232-C) checksum error detec.	after reset or after pressing the ERR CLR key after retransmission
(10)	422-PS. E	after reception of an instruction (RS-422) parity error detected; or after reception of an instruction (RS-422) checksum error detected	after reset or after pressing the ERR CLR key after retransmission
(11)	232-C-FL. E	after reception of an instruction RS-232-C hardware status - overflow or framing fault	after reset or after pressing the ERR CLR key or after retransmission
(12)	422-FL. E	after reception of an instruction RS-422 hardware status - overflow or framing fault	after reset or after pressing the ERR CLR key or after retransmission
(13)	232-C-PR. E	protocol error (RS-232-C) between external computer and KP 60	after reset or after pressing the ERR CLR key or after retransmission
(14)	422-PR. E	protocol error (RS-422) between external computer and KP 60	after reset or after pressing the ERR CLR key or after retransmission
(15)	232-C-TO. E	time-exceeded error on RS-232-C	after reset or after pressing the ERR CLR key or after retransmission

No.	Name	LED "on"	LED "off"
(16)	422-TO. E	time-exceeded error on RS-422	after reset or after pressing the ERR CLR key or after retransmission
(17)	RV2	DSR inverted	DSR not inverted
(18)	PG OK	programming unit or external computer correctly connected to KP via RS-232-C	false interface parameters set for connection to programming unit

Table 12.1.2: Significance of switch settings of the operating mode switch (MODE)

Examples (see also mode settings in the examples of configuration in Fig. 12.1.3 and 12.1.4):

- Mode = 0: when the ABB Procontic process display and control unit (e.g. 35 BS 95 with 935 PM 73) is connected via the RS-232-C interface to communication processor 07 KP 60 (1st station) and to the central unit or via the RS-422 interface to other central units (station number is relevant)
- Mode = 1: when the ABB Procontic process display and control unit (e.g. 35 BS 95 with 935 PM 73) is communicating only with the station to which it is connected and there is no RS-422 networking (station number is not relevant). 907 PC 32 can be connected via the RS-232-C interface.
- Mode = 2: when the communication processor is a further station in an RS-422 network. 907 PC 32 can be connected via the RS-232-C interface.

No. of mode-switch ⁴⁾	RS-232-C	RS-422
0	one-way activation with station number	-
1	one-way activation ¹⁾ without station number	both-way activation ²⁾ without station number
2	one-way activation without station number	one-way activation with station number
3	both-way activation without station number	both-way activation without station number
4	both-way activation without station number	one-way activation with station number
5	-	-
6	RS-232-C loop test ³⁾	-
7	RS-232-C loop test ³⁾	-
8	-	RS-422 loop test ³⁾
9	-	RS-422 loop test ³⁾

1) one-way activation: mono master operation, i.e. the peripheral unit connected is the master, the 07 KP 60 is the passive communication station

2) both-way activation: not used at present

3) The RS-232-C and RS-422 loop tests in switch settings 6 to 9 are identical

4) An adjustment of the mode switch does not become effective until the reset button is pressed

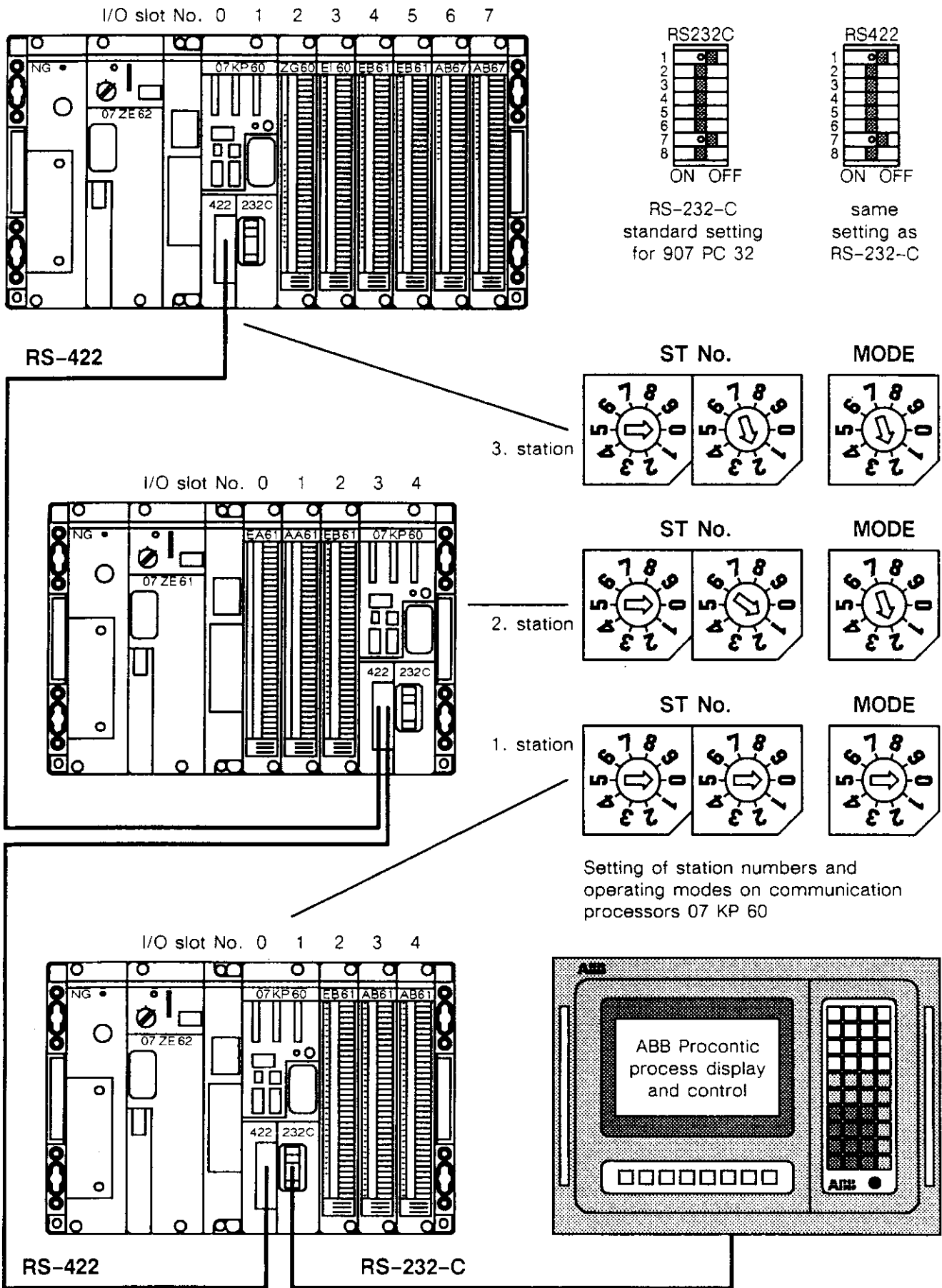
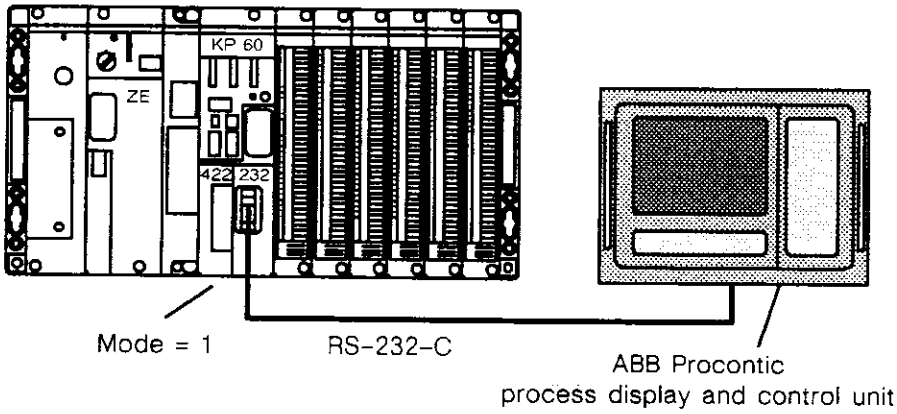

Fig. 12.1.3: Example of networking via communication processors 07 KP 60 (RS-422 interfaces) and connection of an ABB Procontic display and control unit (RS-232-C interface)



Application example:

Connection of an ABB Procontic process display and control unit; no networking

The mode switch on the 07 KP 60 is set to "1". Setting "0" is also possible, but in this case the individual station must be operated with mode number. The same mode number must be declared in the operating station.

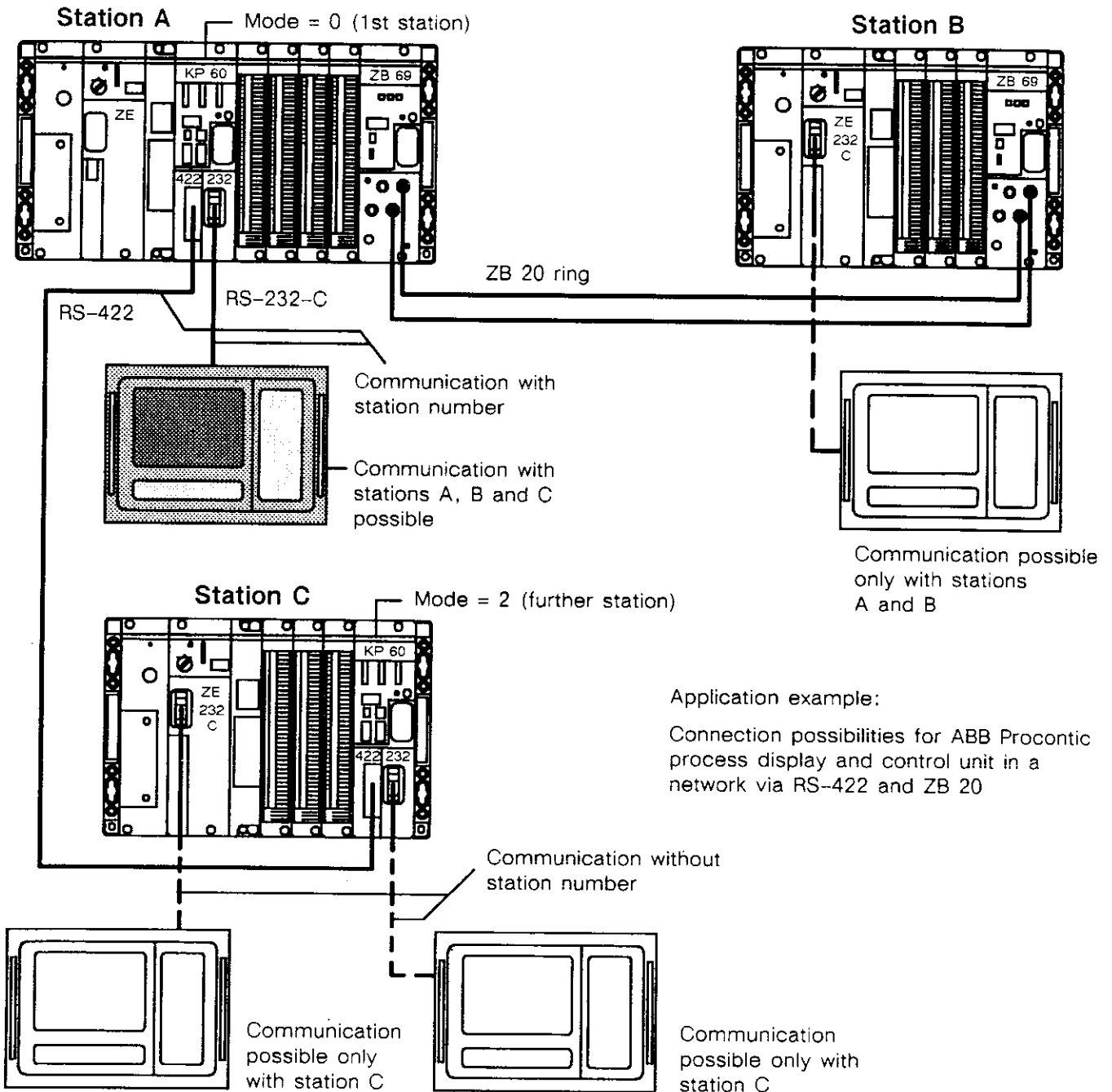

Application example:

Connection possibilities for ABB Procontic process display and control unit in a network via RS-422 and ZB 20

Fig. 12.1.4: Further examples of configuration for the 07 KP 60 R101 communication processor with connection to the ABB Procontic process display and control unit

Table 12.1.3: Significance of switch settings of the parameter switches for the RS-422 and RS-232-C interfaces

The significance of the switch settings is the same for both switches. With switches 1, 5, 6, 7 and 8 the following parameters can be set:

Switch No.	Switch setting		Meaning
	ON	OFF	
1	8 bits	7 bits	number of data bits
5	yes	no	parity
6	even	odd	parity mode
7	2	1	number of stop bits
8	yes	no	checksum

With switches 2, 3 and 4 the transmission speed (baud rate) is set as follows:

Switch No.	Baud rate						
	300	600	1200	2400	4800	9600	19,2 k
2	OFF	ON	OFF	ON	OFF	ON	OFF or ON
3	OFF	OFF	ON	ON	OFF	OFF	ON
4	OFF	OFF	OFF	OFF	ON	ON	ON

Note: When using both interfaces, the settings of both switches must be the same

When connecting a programming unit to the communication processor (with mode setting = 1) the RS-232-C switch settings must be as follows (standard settings for 907 PC 32):

Switch No.	1	2	3	4	5	6	7	8
Setting	OFF	ON	ON	ON	ON	ON	OFF	ON

i.e. 7 data bits, 19.2 kbit/s, even parity, 1 stop bit, with checksum.

If here – in deviation from the standard setting – another baud rate is selected, this setting has to be confirmed on the 907 PC 32 side in the configuration of the programming interface.

Data transmission

"Task codes" are transmitted via the communication processor interfaces using telegrams of variable length. The telegrams have fixed format. Number of data bits, baud rate, parity and number of stop bits can be set by means of switches (see Table 12.1.3 above).

Fig. 12.1.5 (below) shows the structure of a character in a telegram.

The following characters are used for transmission control:

- STX Start of Text
- CR Carriage Return
- ACK Acknowledge
- NAK Negative Acknowledge
- ENQ1 Enquiry 1 (normal enquiry)
- ENQ2 Enquiry 2 (enquiry to destination)
- EOT End of Text

Communication with the 07 KP 60 is carried out using the T200 protocol, which is described in the publication "ABB Procontic T200 Communication protocol description".

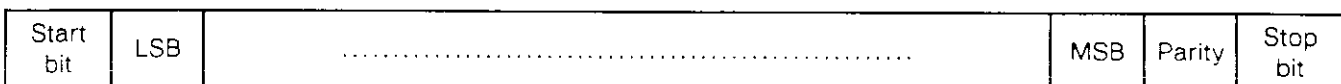
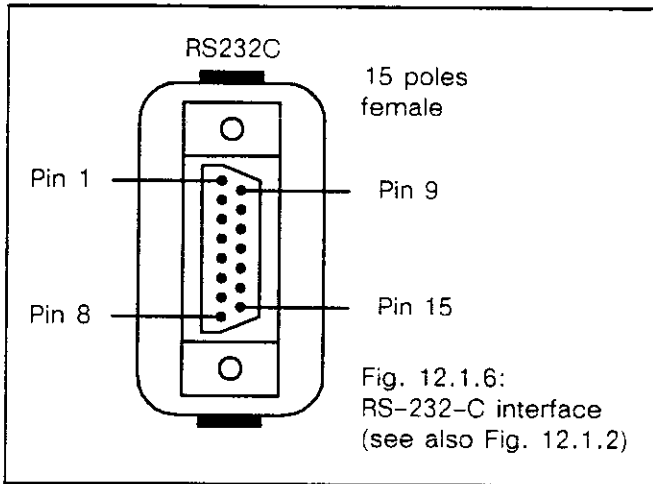

Fig. 12.1.5: Structure of a character in a telegram

RS-232-C interface

The RS-232-C interface is not electrically isolated from internal operating voltages. Connections to the 907 PC 32 programming and test system are made using system cable 07 SK 61 R1.

Data transmission over greater distances (up to 2400 m) refer to 907 PC 32, Volume 3.



Pin	Signal name	Meaning
1	PGND	Protective Ground (shield)
2	TxD	Transmit Data
3	RxD	Receive Data
4	RTS	Request to Send
5	CTS	Clear to Send
6	DTR	Data Terminal Ready
7	DSR	Data Set Ready
8	PHL	RLSD Receive Line Signal Detector
9, 10	SGND	Signal Ground
11, 12	PV5	+ 5 V
13	NV12	- 12 V
14	PV12	+ 12 V
15	NC	Not Connected

Table 12.1.4: RS-232-C terminal assignment

RS-422 interface

The RS-422 interface is not electrically isolated from internal operating voltages. The RS-422 is wired using shielded cable with twisted pairs (TxDP twisted with TxDN and RxDP twisted with RxDN, see Fig. 12.1.8 and 12.1.9).

The outer shields of the interface cable are directly grounded at both ends. If a potential difference exists, one end should be grounded via a capacitor.

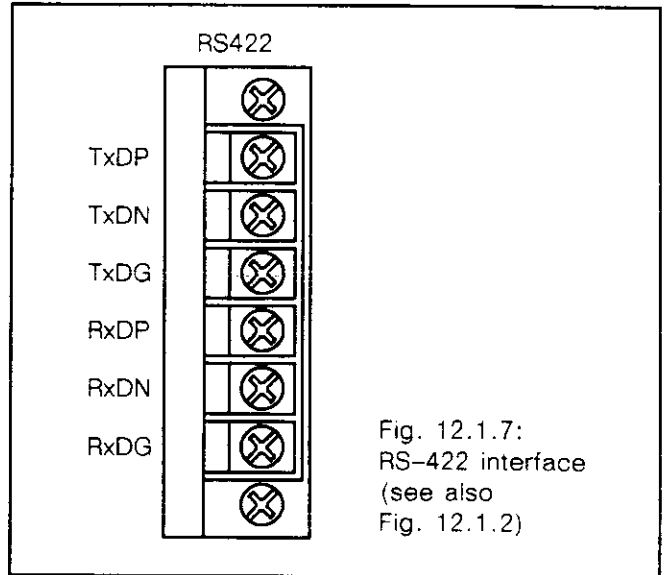

Signal name	Meaning
TxDP	Transmit Data +
TxDN	Transmit Data -
TxDG	Transmit Data Ground(not connected)
RxDP	Receive Data +
RxDN	Receive Data -
RxDG	Receive Data Ground(not connected)

Table 12.1.5: RS-422 terminal assignment

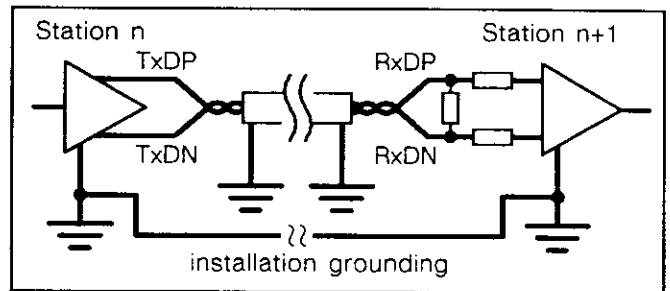

Fig. 12.1.8: RS-422 signal transmission

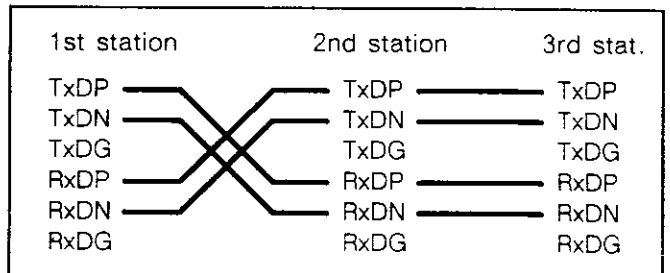

Fig. 12.1.9: Connections via RS-422

Loop test

During the loop test, test data are varied and counted up. These data are made visible on LEDs 9...12 and 15...18. In an error condition the last value transmitted is displayed.

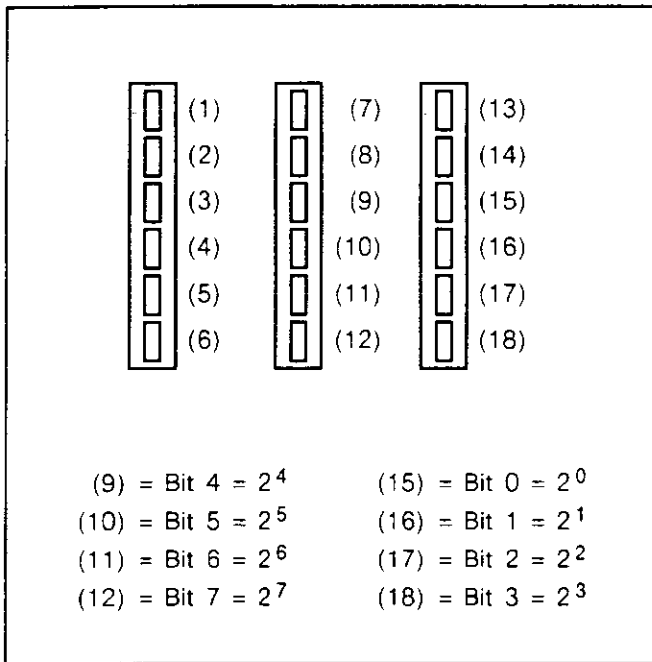

Fig. 12.1.10:
Allocation of test data on LEDs

The loop test is only carried out if a transmission error occurs between two communication processors or between a communication processor and peripheral device (e.g. a local operator station). It can thus be determined whether the communication processor or the peripheral device or the connecting cable is faulty. Only one module in a networked configuration can be tested at a time using the loop test.

Loop test on RS-232-C interface

The voltage supply to the subrack is switched off and the test plug supplied is inserted into the interface connector. The operating mode switch (MODE) must be set to 6 or 7 (see also Table 12.1.2). When the voltage is switched on, the loop test is started automatically. If an error is detected, it will be displayed by the LEDs.

Loop test on RS-422 interface

The voltage supply to the subrack is switched off. On the terminal block of the RS-422 connector TxDP is connected to RxDP and connector TxDN is connected to RxDN. The operating mode switch (MODE) must be set to 8 or 9 (see also Table 12.1.2). When the voltage is switched on, the loop test is started automatically. If an error is detected, it will be displayed by the LEDs.

Technical data

Max. number of modules per subrack

Interfaces

Selectable transmission speed

Transmission mode

Number of data bits

Parity

Number of stop bits

Self-diagnosis

Distance between two communication processors

Connecting cable for RS-232-C

Interface cable for RS-232-C

Connecting cable for RS-422

Signalling

07 KP 60 R101

4

RS-232-C and RS-422 (not electrically isolated from internal logic voltage).

The two interfaces can be operated independent of each other.

300, 600, 1200, 2400, 4800, 9600 or 19200 bit/s

semiduplex with serial transmission in ASCII

selectable 7 or 8 bits

selectable even or odd

selectable 1 or 2 bits

vertical parity check (even/odd), overflow check, framing check and checksum

max. 250 m

twisted pair, shielded, (max. length 15 m)

connection to 907 PC 32 programming and test system is made with 07 SK 61 R1 or 07 SK 62 R1 system cable

twisted pair, shielded, (max. length 250 m)

18 LEDs, see Table 12.1.1

Current consumption from internal voltages

UB1 = 5 V DC

UB4 = 24 V DC

Total power dissipation

Number of required slots

Number of occupied I/O points

Configuration identifier in 907 PC 32

Ability of fitting in subracks

slot,

●-● = plug-in is possible (occupies 2 slots)

Weight

Order number

Accessories (supplied):

(not supplied):

Order number

max. 0.8 A

no current consumption

max. 4 W

2 I/O slots

16 input and 16 output points

KP60 (entered for right slot number)

BT			BE-central			BE-remote		
NG	ZE	I/O	NG	BV	I/O	NG	BV	I/O
		●-●						

800 g

GJV3074380R101

1 interface plug for loop test

Communication Protocol Description

GATS133927R2001

Error handling

The operational condition of the communication processor is monitored by the central unit. The following status values can be scanned at the central unit by means of flags:

No.	Error	Explanation	Detailed description
M 124,14 ²⁾	configuration error of communication module (07 KP 60, 07 ZB 69, 07 BR 69)	0: no error 1: error	indicates whether the communication allocation information defined in the system configuration matches the modules used or not. Information on non-matching slot numbers is given in internal flag MW4096,03.
M 125,07 ²⁾	communication module fault 1)	0: no error 1: fault	indicates if a fault has appeared in a communication module. The slot number of the module in question is given in internal flag MW4096,04.
M 125,13 ²⁾	too many communication modules allocated 1)	0: no error 1: error	indicates if the number of communication modules set in the configuration has exceeded the maximum permitted number.

1) Communication modules are 07 KP 60, 07 ZB 69, 07 BR 60

2) These flags signal and store the status information and must therefore be reset once (see also ONLINE list)

No.	Error	Explanation	Detailed description
MW 4096,03	details of error in allocation of communication modules 1) 3) 4)	slot number of non-matching communication module 2)	Contains slot number of communication module (0 to 7) that does not match the communication module allocation information defined in the system configuration.
MW 4096,04	slot number of faulty communication module 1) 3) 4)	slot number	Contains the slot number (0 to 7) of a communication module that has a hardware fault.

MW 4097,08

Set flag of the communication module 1)

Central station: system bus state of each slot

15	8	7	6	5	4	3	2	1	0
Not used	a	b	c	d	e	f	g	h	

1 = system bus configuration is complete

0 = system bus configuration is not complete

Set bit corresponds to righthand slot number of a communication module that is plugged in

a = slot No. 7

b = slot No. 6

c = slot No. 5

d = slot No. 4

e = slot No. 3

f = slot No. 2

g = slot No. 1

h = slot No. 0

Example for MW 4097,08:

2 communication modules are projected for slots 4 and 5 and for 6 and 7. In MW 4097,08 then is decimal value 160:

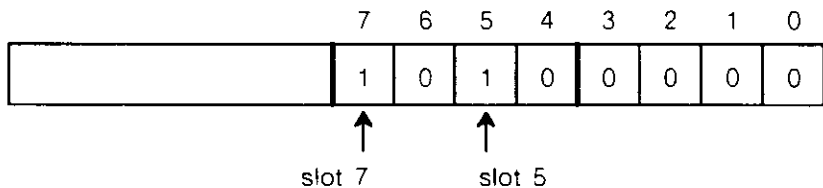

1) Communication modules are 07 KP 60, 07 ZB 69, 07 BR 60

2) Contains the lowest slot number.

3) Note to:

MW 4096,03
MW 4096,04

Structure of flags in hex (907 PC 32 depicted in decimal)

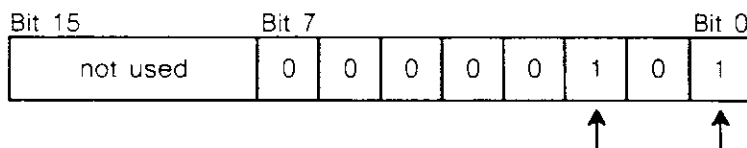

Example: Communication module in slot 5 is defective. Internal word flag MW 4096,04 then contains information 5

4) These flags signal and store the status information and must therefore be reset once (see also ONLINE list)

No.	Error	Explanation	Detailed description
-----	-------	-------------	----------------------

MW 4098,00 } Condition of communication module that is plugged into slots 0/1.
 MW 4098,01 }

Details of condition of communication module that is plugged into slots 0/1.

MW 4098,n with n = 00, 02, 04, 06, 08, 10, 12, 14

Bit	Meaning
0	RS-232-C parity/checksum error
1	RS-232-C framing error
2	RS-232-C protocol error
3	RS-232-C time exceeded error
4	RS-422 parity/checksum error
5	RS-422 framing error
6	RS-422 protocol error
7	RS-422 time-exceeded error
8	RS-232-C READY
9	RS-422 READY
10	DSR 1 = ON, 0 = OFF
11	} not used
bis	
15	

" " "

MW 4098,14 } Condition of communication module that is plugged into slots 6/7.
 MW 4098,15 }

Details of condition of communication module that is plugged into slots 6/7.

MW 4098,m with m = 01, 03, 05, 07, 09, 11, 13, 15

Bit	Meaning
0	} used by system
bis	
5	} not used "0"
6	
bis	
7	} used by system
8	
bis	
13	} not used "0"
14	
bis	
15	

The slot information is not defined if no communication module is plugged in.

12.3 Communication Processor ASCII 07 KP 62 R202

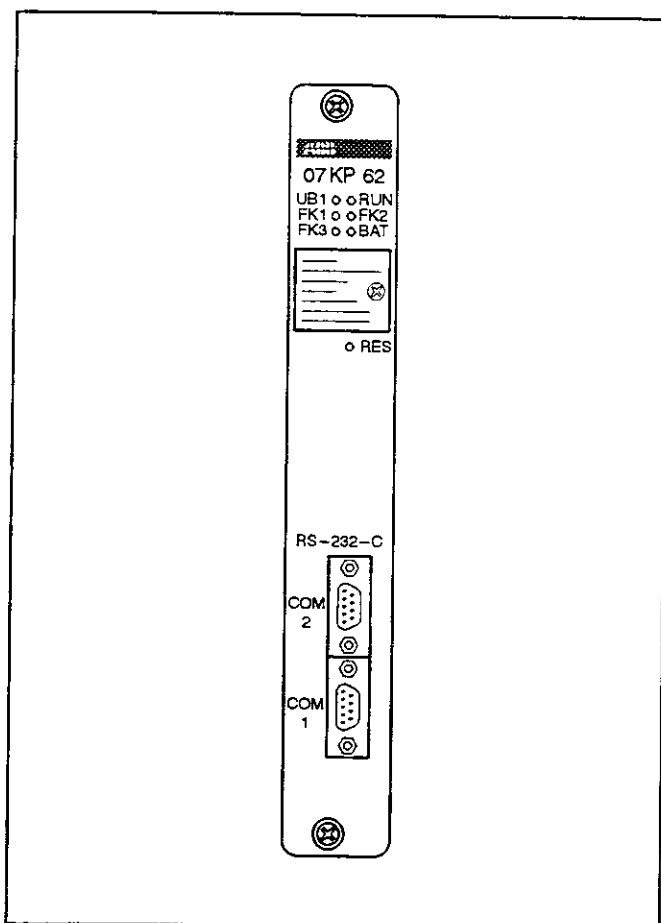

Fig. 12.3.1: Communication Processor ASCII 07 KP 62 R202

General Information

The 07 KP 62 communication processor is a preprocessor of the ABB Procontic T200 programmable control system. It has two serial EIA RS-232C interfaces which work independent of each other. They are both configurable and electrically isolated and used for programming the 07 KP 62 and for bidirectional communication with MMC devices as well as other external units.

The **serial interfaces** can be configured and addressed with a user program (with the connection elements SINIT, DRUCK, EMAS) which is stored in the 07 KP 62. Thus, no program memory space is needed in the T200.

As a **preprocessor** the 07 KP 62 communication processor can execute a user program independent of the T200 central unit. When creating the user program, which is stored in the KP 62's own program memory, many commands known from ABB Procontic T300 and 07 KR 91 / 07 KT 92 / 07 KT 93 (CS31) can be employed. The program memory of the 07 KP 62 has a size of max. 60 kBytes, see also Technical data).

Characteristics

The 07 KP 62 does not access directly to the input/output modules of the T200. All inputs/outputs to be operated by the 07 KP 62 have to be configured with the 07 ZE 6x central unit of the T200.

The COM1 interface is used as a programming interface in order to enter and test the user program stored in the 07 KP 62. COM1 can be switched over from the programming mode into the MMC mode. In the MMC mode the connection elements SINIT, DRUCK and EMAS are used.

The COM2 interface is an MMC interface which is configured by the user program (SINIT, DRUCK, EMAS).

Development and test of a program are performed with a PC and the 907 PC 331 programming and test software of the ABB Procontic CS31. In an easy way, the user can also connect operating stations.

The user program is stored in a non-volatile memory (Flash-EPROM). In the Flash EPROM, it is also possible to store user data in a non-volatile way (see appendix). In addition, a battery-backed RAM is used to save the internal flags of the 07 KP 62.

From the point of view of the T200 central unit the data transmission between the 07 KP 62 and the T200 PLC is carried out with a configurable flag area and/or with 4 EW and 4 AW channels. Both data transmission methods can be combined (see configuring of the communication areas).

Module Description

The communication processor has a metal housing with a front panel including the display elements, the two 9-pole D-plugs (female) for the COM1 programming/MMC interface and the COM2 MMC interface, the battery compartment and the reset pushbutton (RES).

6 LEDs on the front panel display operating and error conditions (see Fig. 12.3.2).

Project Planning

The 07 KP 62 communication processor ASCII can only be placed in basic subracks of the ABB Procontic T200. Dependent on the configuration, up to 4 communication processors can be mounted in one basic subrack (sum of modules 07 KP 6x).

In the configuration menu of the 907 PC 332 programming software, "KP6X" has to be entered into the "Config.-PLC" menu point "System Configuration".

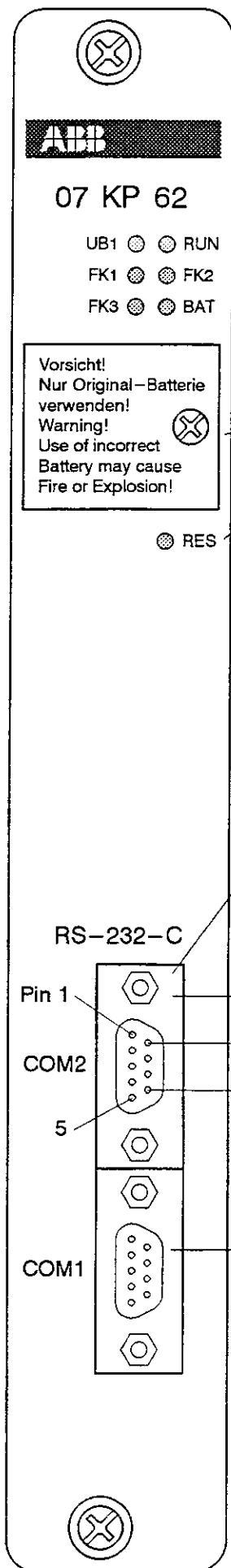

UB1 Power-ON display

The green LED lights up, when the internal voltage (5V) is ON.

RUN Operation display

The green LED lights up, when the user program stored in the 07 KP 62 is running (the RUN switch of the T200 central unit is in the RUN position then).

FK1 Class 1 error, red LED, fatal error

FK2 Class 2 error, red LED, serious error

FK3 Class 3 error, red LED, light error

BAT Battery error

The red LED lights up, when the battery is exhausted or missing.

Battery compartment

RESET pushbutton, manual reset of the 07 KP 62.

COM2, MMC interface, RS-232C, 9-pole D-plug, female

Pin	Signal name	Meaning	Remarks
G	PGND	Shield (Protective Ground)	Plug case
1	PGND	Shield (Protective Ground)	
2	$\overline{\text{TxD}}$	Transmit Data	Output
3	$\overline{\text{RxD}}$	Receive Data	Input
4	RTS	Request To Send	Output
5	CTS	Clear To Send	Input
7	SGND	Signal Ground	
6	PROG	Not connected	
8	0 V	0 V for UB1	0 V for UB1
9	+5 V	Power supply for the TCZ programming and diagnosis unit (the TCZ is supplied by the pins 8 and 9 with 0 V and +5 V)	UB1

Note: The pins 6, 8 and 9 are not electrically isolated from UB1 (internal +5 V).

COM1, Programming/MMC interface, RS-232C, 9-pole, female

Pin	Signal name	Meaning	Remarks
G	PGND	Shield (Protective Ground)	Plug case
1	PGND	Shield (Protective Ground)	
2	$\overline{\text{TxD}}$	Transmit Data	Output
3	$\overline{\text{RxD}}$	Receive Data	Input
4	RTS	Request To Send	Output
5	CTS	Clear To Send	Input
7	SGND	Signal Ground	
6	PROG *	Switch-over programming/MMC	Input
8	0 V	0 V for UB1	0 V for UB1
9	+5 V	Power supply for the TCZ programming and diagnosis unit (the TCZ is supplied by the pins 8 and 9 with 0 V and +5 V)	UB1

Note: The pins 6, 8 and 9 are not electrically isolated from UB1 (internal +5 V).

* 1 = Active mode (programming/test), pin 6 open circuit
 0 = Passive mode (MMC applications), pins 6 and 8 shorted

Fig. 12.3.2: Communication processor ASCII 07 KP 62 R202 with description of the display and operating elements as well as the interfaces

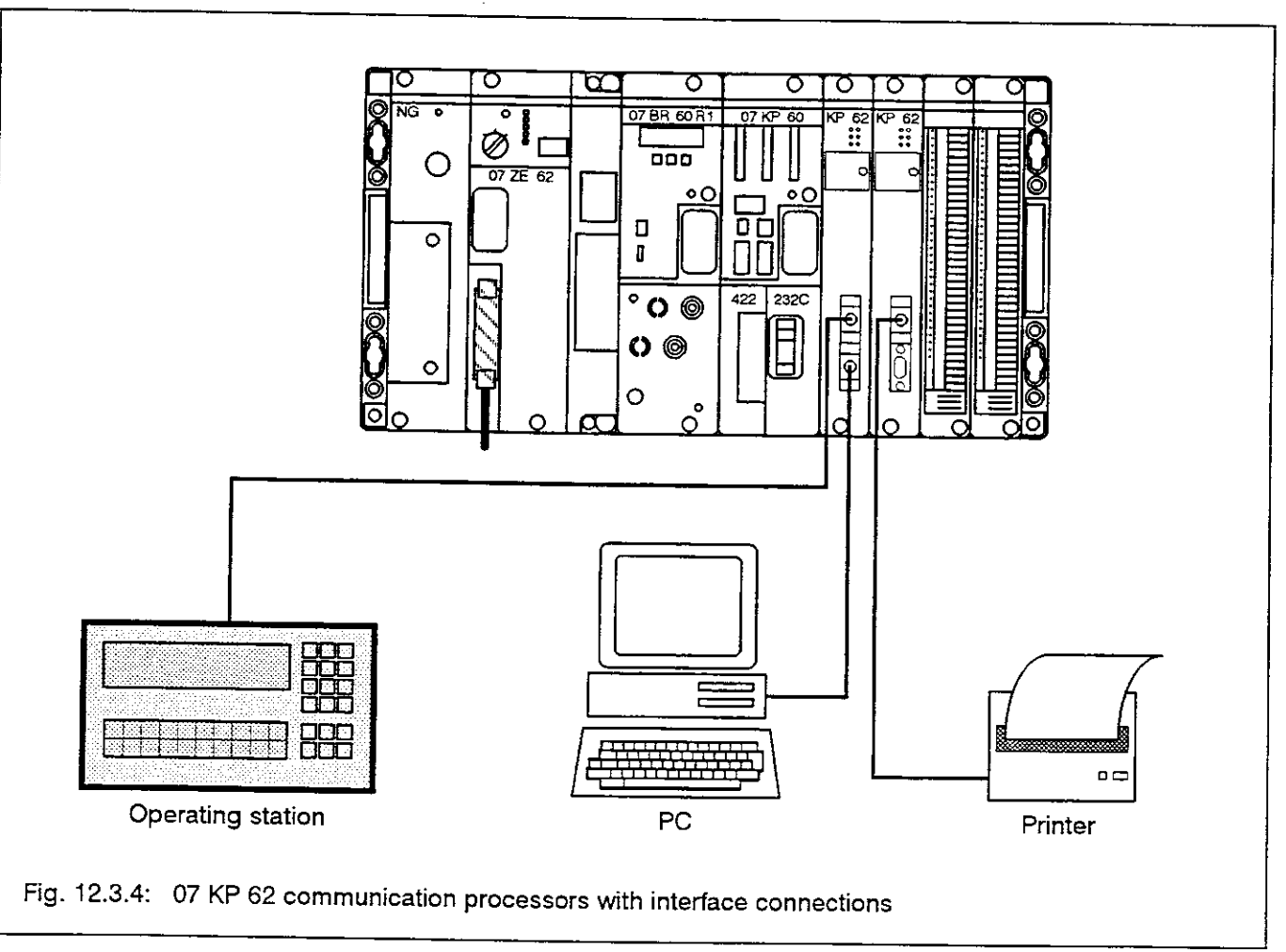
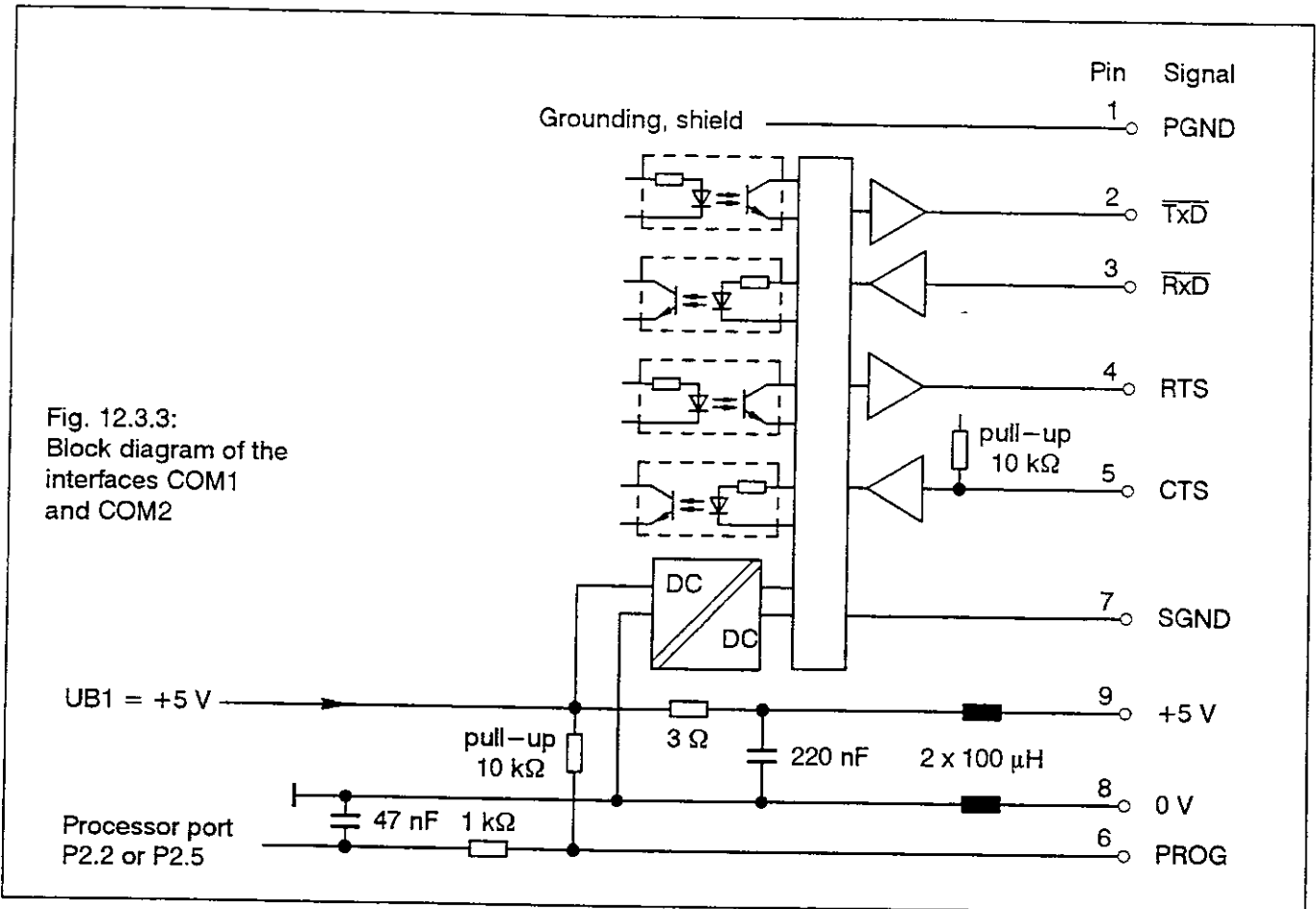

Handling Examples

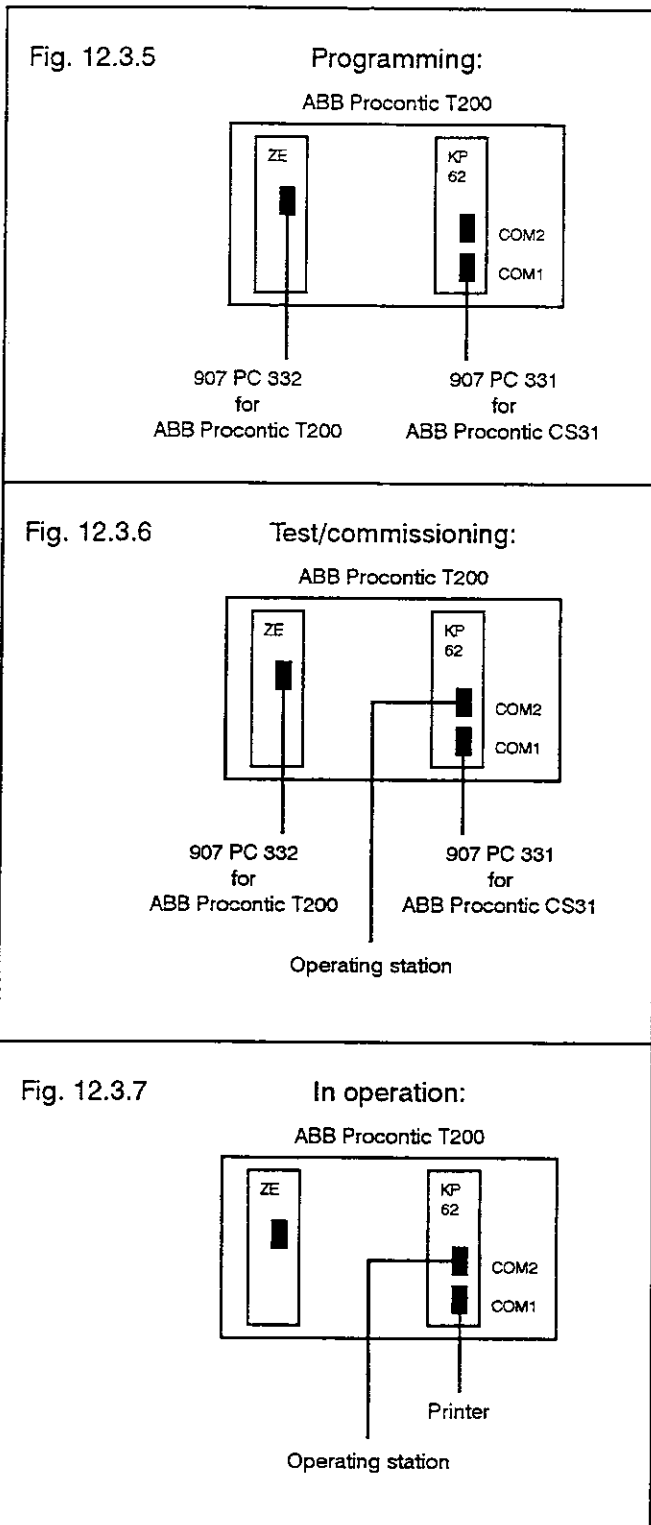

- **Active mode**
(Programming or MMC active mode) and

- **Passive mode**
(MMC passive mode using DRUCK, EMAS)

When the RUN/STOP switch of the T200 central unit is in "STOP" position, the active mode is set constantly.

Setting the operating mode of COM1

The operating mode is set by the system constant KW 0,6 stored in the operand memory or by the status of pin 6 of the interface plug (1 or 0, i.e. open circuit or shorted with pin 8). The system constant has a higher priority than pin 6 of the interface plug.

In *both* operating modes, the *value* of the system constant can be changed via the serial interface line. Thus the operating mode is also changeable using a modem, for instance, independently of the status of pin 6 of the interface plug.

Setting the operating mode:

- **Active mode**
(Programming or MMC active mode)
 - KW 0,6 = 1 or
 - KW 0,6 = 0 and pin 6 "open circuit"
- **Passive mode**
(MMC passive mode using DRUCK, EMAS)
 - KW 0,6 = 2 or
 - KW 0,6 = 0 and pin 6 "0" (shorted with pin 8)

In order to set the operating mode by pin 6 of the interface plug two different system cables can be used:

- one cable 07 SK 90 for the active mode *and*
- one cable 07 SK 91 for the passive mode.

Serial interface COM2

The COM2 interface is an MMC interface configurable by the user program (SINIT, DRUCK, EMAS).

System constants

The system constants are reserved indirect constants which are used to predefine system parameters of the PLC.

Definition of system constants

- **Number of system constants**

The following indirect constants are reserved as system constants:

- KW 00,00 ... KW 00,15
- KD 00,00

When starting a new project using 907 PC 331 the system constants and the default values belonging to them appear in the variable list.

Serial Interfaces COM1 and COM2

Pin configuration of the interfaces COM1 and COM2 see Fig. 12.3.2.

Serial interface COM1

The COM1 serial interface has two functions. When the RUN/STOP switch of the T200 central unit is in "RUN" position, the following **operating modes** of the interface can be set:

- **Setting the operating modes Master PLC, Slave PLC or Stand-alone PLC**
 - Absolute identifier: KW 00,00
 - No significance for 07 KP 62
- **Setting the initialization: binary flags**
 - Absolute identifier: KW 00,01
 - Symbolic identifier: INIT_M
 - Meaning of the constant's value:
 - The binary flag area is initialized until the end (including the given group number).
 - If the given group number is negative or greater than the maximum possible, only the M 255,15 flag is initialized.
 - Range of values: <0, 0..255, >255
 - Default value: 0
i.e. initialization of the whole area
- **Setting the initialization: word flags**
 - Absolute identifier: KW 00,02
 - Symbolic identifier: INIT_MW
 - Meaning of the constant's value:
 - The word flag area is initialized until the end (including the given group number).
 - If the given group number is negative or greater than the maximum possible, the word flag area will not be initialized.
 - Range of values: <0, 0..253, >253
 - Default value: 0
i.e. initialization of the whole area
- **Setting the initialization: double word flags**
 - Absolute identifier: KW 00,03
 - Symbolic identifier: INIT_MD
 - Meaning of the constant's value:
 - The double word flag area is initialized until the end (including the given group number).
 - If the given group number is negative or greater than the maximum possible, the double word flag area will not be initialized.
 - Range of values: <0, 0..31, >31
 - Default value: 0
i.e. initialization of the whole area
- **Setting the initialization: step chains**
 - Absolute identifier: KW 00,04
 - Symbolic identifier: INIT_S
 - Meaning of the constant's value:
 - The step chain area is initialized until the end (including the given group number).
 - If the given group number is negative or greater than the maximum possible, the step chain area will not be initialized.
 - Range of values: <0, 0..127, >127
 - Default value: 0
i.e. initialization of the whole area
- **Setting the initialization: historical values**
 - Absolute identifier: KW 00,05
 - Symbolic identifier: INIT_VW
 - Meaning of the constant's value:
 - The historical values can only be initialized altogether or not at all.
 - Initialization of historical values: =0
 - No initialization of historical values: <> 0
 - Range of values: <0, 0, >0
 - Default value: 0
i.e. initialization of all historical values
- **Setting: operating mode of the COM1 serial interface**
 - Absolute identifier: KW 00,06
 - Symbolic identifier: MODE_SST
 - Meaning of the constant's value:
 - Active mode: 1
 - Passive mode: 2
 - The status of pin 6 is valid: <0, =0, >2
 - Range of values: <0, =0, 1, 2, >2
 - Default value: 0
 - The status of pin 6 of the interface plug determines the operating mode of the COM1 interface.
 - Remark:
 - For the evaluation of this system constant the value of the operand memory is used (and not the value of the user program memory).
 - Advantage:
 - A change of the operating mode which is temporary required is achieved by changing the value of the system constant of the operand memory. After power OFF/ON or program ABORT/RESTART the value temporary entered in the operand memory is substituted again by the value which is stated in the variable list. Thus the user defines by entering the system constant in the variable list the normally desired operating mode of the interface. This operating mode is always set after starting the PLC program.

- **PLC reaction of the 07 KP 62 on class 3 errors (FK3)**

see Error Diagnosis and Error Handling

- Absolute identifier: KW 00,07
- Symbolic identifier: FK3_REAK
- Meaning of the constant's value:
Only error indication: 0
Error indication plus program abortion of the 07 KP 62: <0, >0
- Range of values: <0, =0, >0
- Default value: 0
i.e. only error indication

- **Setting the cycle time**

- Absolute identifier: KD 0,0
- Symbolic identifier: ZYKL_ZEIT
- Meaning of the constant's value:

The PLC program of the 07 KP 62 is executed cyclically with predefined intervals.

The unit of measurement is milliseconds [ms]. The shortest time which can be predefined is 5 ms. The operating system is configured in this way. Only integral multiples of 5 ms are permitted.

- Range of values: 5...200
- Default value: 10

Operand ranges

- **Freely available variables and constants**

Inputs

The module 07 KP 62 has *no* process inputs.

EW 00,04...EW 00,07 : high-speed inputs *from* the ABB Procontic T200
(see Configuring of the Communication Areas)

Outputs

The module 07 KP 62 has *no* process outputs.

AW 00,00...AW 00,03 : high-speed outputs *to* the ABB Procontic T200
see Configuring of the Communication Areas)

Internal operands

M 00,00...M 255,09 : Binary flags
S 00,00...S 127,15 : Steps
K 00,00...K 00,01 : Binary constants

MW 00,00...MW 05,15 : Output flags *to* the ABB Procontic T200
see Configuring of the Communication Areas)

MW 06,00...MW 11,15 : Input flags, *from* the ABB Procontic T200

MW 12,00...MW 253,15 : Word flags

KW 01,00...KW 39,15 : Word constants

MD 00,00...MD 31,15 : Double word flags

KD 00,01...KD 07,15 : Double word constants

Time values for time functions

KD yy,xx : Time values for time functions such as ESV, ASV etc. are configured as *double word constants* or as

MD yy,xx : *double word flags*. Only integral multiples of 5 ms are permitted.

- **Direct constants**

Direct constants are only allowed at specific inputs of function blocks. Possible use of direct constants is explained in the descriptions of the function blocks.

-32768...32767

#H 0000...FFFF

- **Labels**

Labels are used as jump targets for forward skips and run number blocks.

MRK 0...999 (Designation in terminal mode MA 0...999)

● System constants

Setting the operating modes

The constants KW 00,00...KW 00,15 are reserved as system constants. Even the constants KW 00,08...KW 00,15 which are not used yet may *under no circumstances* be used for other purposes.

KW 00,01	:	Initialization: bit flag area
KW 00,02	:	Initialization: word flag area
KW 00,03	:	Initialization: double word flag area
KW 00,04	:	Initialization: step chain flag area
KW 00,05	:	Initialization: historical values
KW 00,06	:	Application modes of the serial interface COM 1
KW 00,07	:	PLC reaction of the 07 KP 62 to class 3 errors

Setting the cycle time

KD 00,00 : The cycle time of the PLC program of the 07 KP 62 is preset with this constant. The cycle time is given in the unit of measurement milliseconds. Only integral multiples of 5 ms are permitted.

Error diagnosis

Summation error display	:	M 255,10 indicates, that the 07 KP 62 PLC has detected an error
Fatal error, FK1	:	M 255,11 = 1 i.e. error detected, detailed information in MW 254,00...MW 254,07
Serious error, FK2	:	M 255,12 = 1 i.e. error detected, detailed information in MW 254,08...MW 254,15
Light error, FK3	:	M 255,13 = 1 i.e. error detected, detailed information in MW 255,00...MW 255,07
Warning, FK4	:	M 255,14 = 1 i.e. error detected, detailed information in MW 255,08...MW 255,15

First-cycle detection

M 255,15

This binary flag can be used for detection of the *first* program cycle after a program start. It is always set to "zero" after each program start, independent of the initialization instructions given by the system constants. If this flag is read by the user program and then set to "1", it can be found out whether or not the user program was started once more.

Data Back-up

The user program is stored in a Flash EPROM and does not require a battery back-up.

Each alteration of the program (e.g., online operations, changes during the test) is carried out in the RAM and then saved in the Flash EPROM after using the menu point "Save program". If also the program contained in the RAM is to be backed, a lithium battery will be necessary. This battery backs also additional data of the RAM, such as flag statuses.

For data back-up the 07 LE 90 lithium battery module is inserted into the battery compartment. The battery voltage is monitored. The LED "BAT" indicates low battery voltage.

Without using a battery (state of delivery of the 07 KP 62) the LED "BAT" lights permanently.

User programs once stored in the Flash EPROM can be deleted by using the menu point "Delete EPROM" in 907 PC 331.

Configuring of the Communication Areas

Up to 4 communication processors can be placed in one ABB Procontic T200 system. The central unit provides 4 special flags for these communication processors, 1 flag for each processor. The user configures in the T200 PLC user program the corresponding special flag for the intended communication flag area. The group number of the communication area is allocated to the special flag. After this the 07 KP 62 updates the communication flag data cyclically. The data interchange via a

configured flag area takes typically 400 ms for each used processor.

- **Data transmission time from 07 KP 62 to T200:**

- 07 KP 62 --> 07 ZE 6x R302 :
< 80 ms + cycle time of 07 KP 62
- 07 KP 62 --> 07 ZE 6x R201 :
< 270 ms + cycle time of 07 KP 62

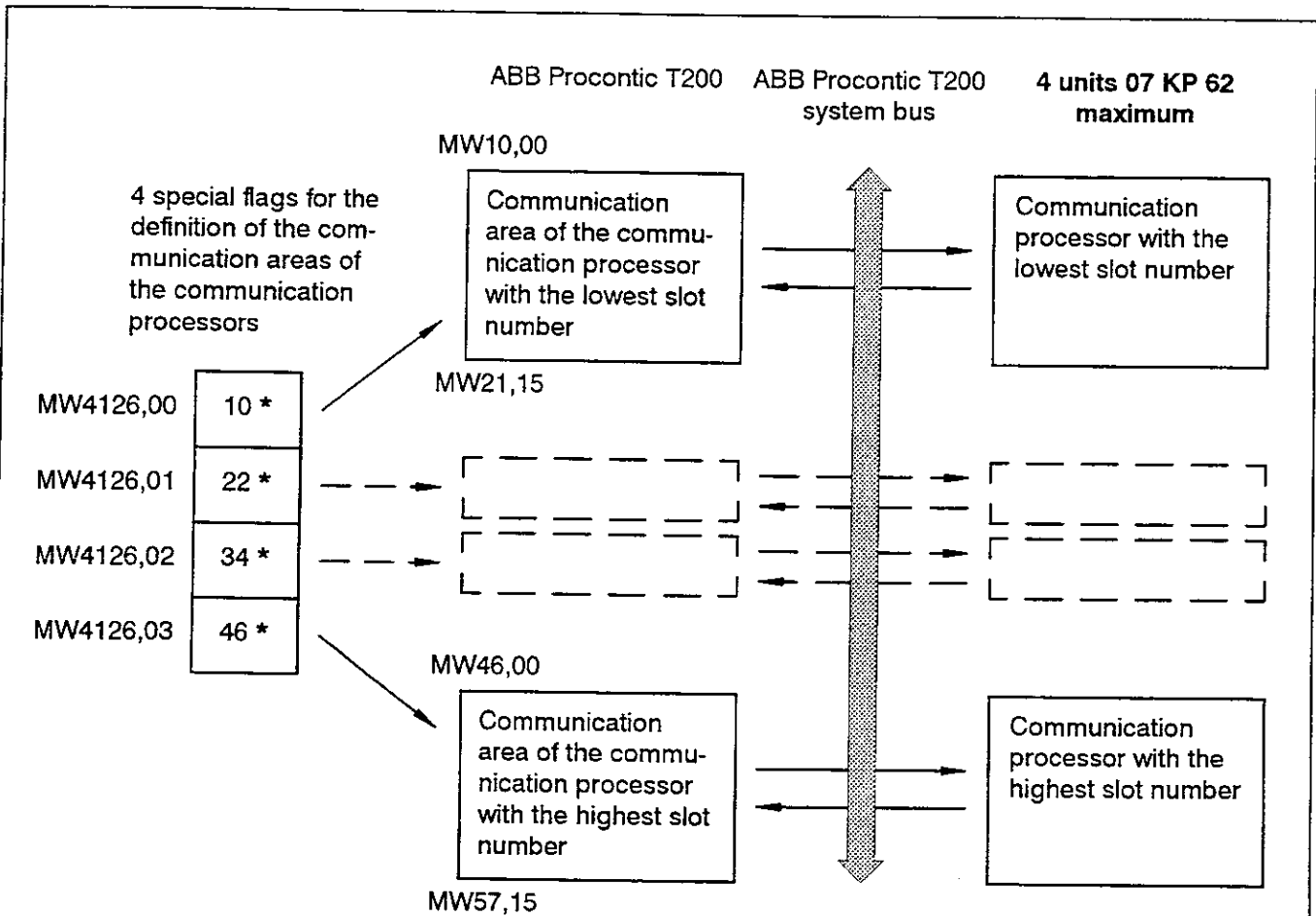

* Allocate values by the T200 PLC user program, the entered values are examples:

- The evaluation of the special flag is only performed after each transition from STOP to RUN position at the T200 PLC.
- Value 0 means: The transmission of the communication flag areas have not been started yet, however, there is a system bus utilization caused by the KP's cyclic reading of the special flag. The 4 EW/AW of the 07 KP 62 are already provided for the 07 ZE 6x.
- Value -1 means: Only the 4 EW/AW of the 07 KP 62 are provided for the 07 ZE 6x. No transmission of the communication flag areas and no system bus utilization by this 07 KP 62 (the special flag will be evaluated anew not until the RUN/STOP switch has been switched over to the STOP position).
- Other values: Definition of the communication flag area of this 07 KP 62.

Fig. 12.3.8: Configuring of the communication areas

Data Exchange between the 07 KP 62 and the T200 PLC

Operands

The I/Os of the 07 KP 62 are intended for the communication with the T200 PLC. The 07 KP 62 cannot access directly to the input/output modules of the T200. All I/Os of the 07 KP 62 are initialized to the value of 0 when the PLC is started. The following inputs/outputs of the 07 KP 62 are adopted by the T200 PLC:

- Word inputs: 4
EW00,04...EW00,07

- Word outputs: 4
AW00,00...AW00,03

The following word flags of the 07 KP 62 have an unchangeable function as communication flags:

- Input word flag data of the 07 KP 62:
96
MW06,00...MW11,15
- Output word flag data of the 07 KP 62:
96
MW00,00...MW05,15

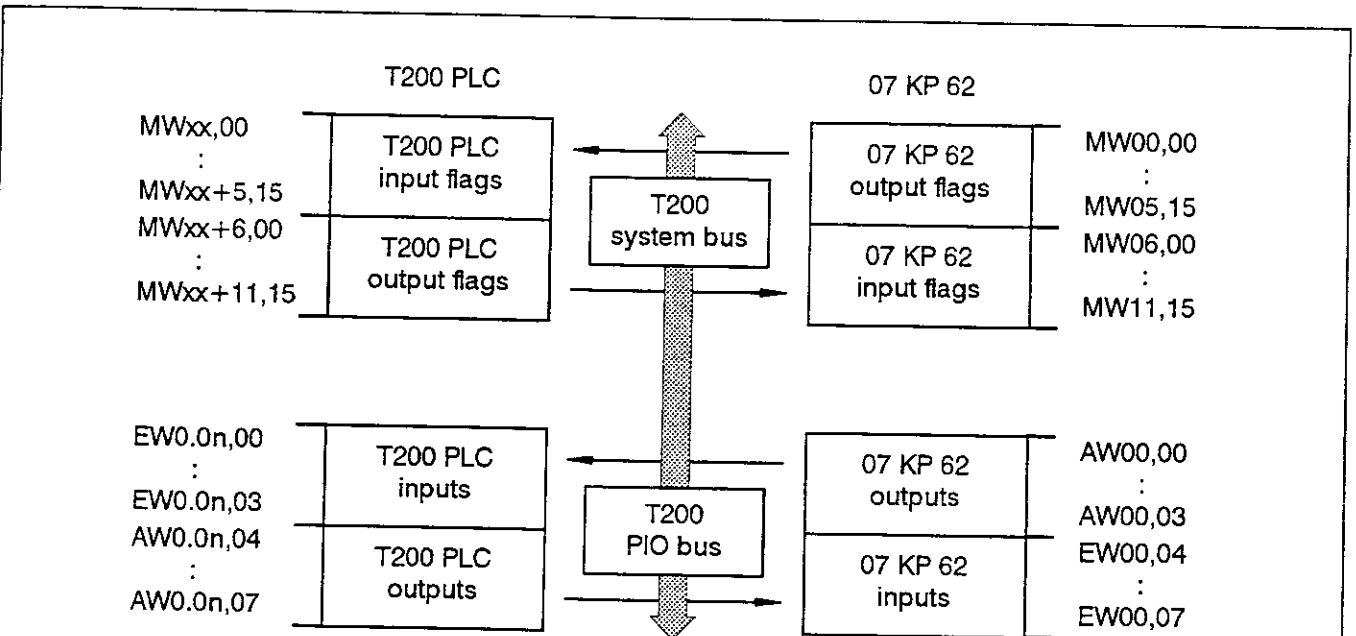

xx: Configurable by the T200 PLC user program
(see Fig. 12.3.8 Configuring of the communication areas)
n: Slot number of the 07 KP 62

Fig. 12.3.9: Overview of the interfaces of the T200 PLC and the 07 KP 62

Error Diagnosis and Error Handling

Structure of the error class flags

Error class flags

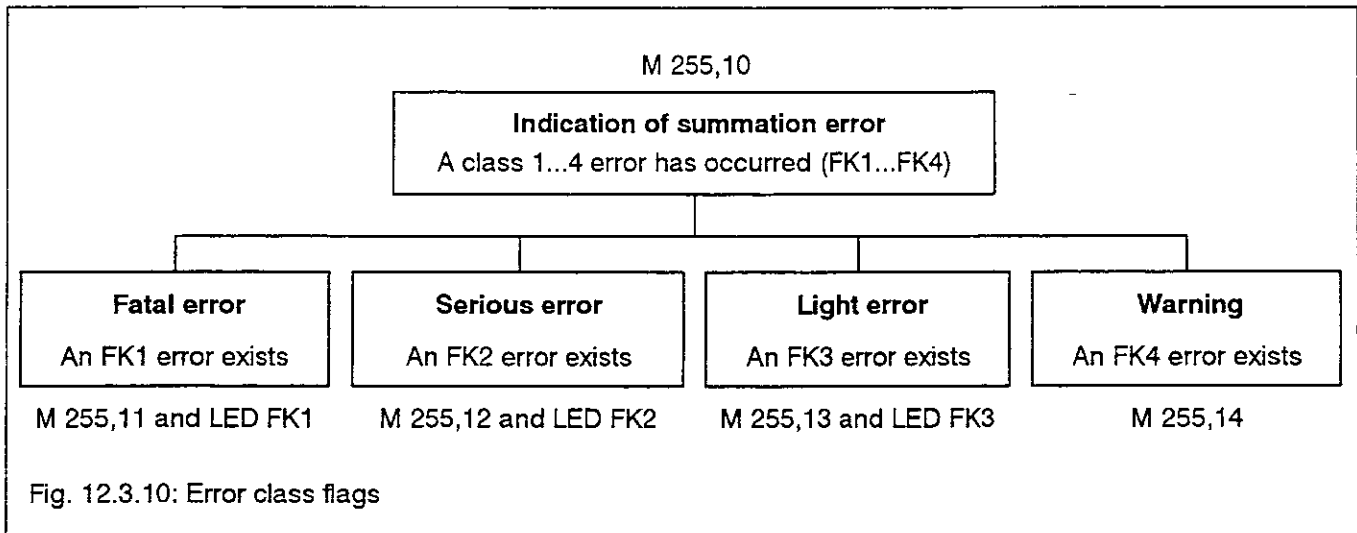

Fig. 12.3.10: Error class flags

Error display and evaluation

For the automatic error diagnosis the following applies:
The errors are displayed with the FK1...FK3 error LEDs:

- FK1 LED: A class 1 error has occurred (fatal error).
- FK2 LED: A class 2 error has occurred (serious error).
- FK3 LED: A class 3 error has occurred (light error).

The errors are entered into the corresponding error flags (bit flags) according to their error class.

A data field of 8 word flags belongs to each error class. The PLC enters automatically detailed error specifications into the flags. The detailed information in this data field is dependent on the error class.

MW xx,00	Error number
MW xx,01	Detailed information 1
MW xx,02	Detailed information 2
MW xx,03	Detailed information 3
MW xx,04	Detailed information 4
MW xx,05	Detailed information 5
MW xx,06	Detailed information 6
MW xx,07	Detailed information 7

Fig. 12.3.11: Word flag data field

Because of the organization of the error information in flag areas they can also be evaluated by the connected MMC systems using standard images.

Allocation of error classes and word flag data field:

- FK1: MW 254,00...MW 254,07
- FK2: MW 254,08...MW 254,15
- FK3: MW 255,00...MW 255,07
- FK4: MW 255,08...MW 255,15

The errors are displayed by LEDs on the 07 KP 62 and provided in system flags. The errors are not provided automatically by the T200 PLC. If required, the user can transfer the error information to the T200 PLC by configuration (PLC program of the 07 KP 62).

Errors of class 1...4 (FK1...FK4)

- FK1:

Error number: **1_D** or **1_H**
Checksum error of the KP62's system EPROMs
Detailed information: none

Error number: **2_D** or **2_H**
The KP62's operating system RAM is defective, or a defective RAM is detected during the cold start (test of the entire RAM).
Detailed information: address

- **FK2:**

Error number: **128_D or 80_H**

The RAM of the user program memory or the operand memory is defective.

Detailed information: address

Error number: **131_D or 83_H**

The KP62 is overloaded, the cycle time is too short.

Detailed information: none

Error number: **132_D or 84_H**

During the runtime, a non-identified error is detected by the KP62 operating system, e.g., a not permitted interrupt has been executed.

Detailed information: none

Error number: **133_D or 85_H**

Checksum error on the Flash EPROM

Detailed information: none

Error number: **257_D or 101_H**

During the runtime, more timers are needed than available in the KP62.

Detailed information: none

Error number: **258_D or 102_H**

During the runtime, an unknown operator or connection element is detected within the KP62 program.

Detailed information: none

The following error refers to the communication between the T200 PLC and the 07 KP 62 communication processor.

Error number: **512_D or 200_H**

Communication error on the T200 bus. No communication can be run. A hardware reset is required. Additional information in word 2 of the error class flag area: error message according to T200 agreement as a service information.

- **FK3:**

Error number: **128_D or 80_H**

The Flash EPROM cannot be programmed.

Detailed information: address of the defective memory cell

Error number: **129_D or 81_H**

The Flash EPROM cannot be deleted.

Detailed information: address of the memory cell that cannot be deleted

Error number: **131_D bzw. 83_H**

CRC error in the Flash EPROM

Detailed information 1: address of the block with the CRC error

Detailed information 2: segment address of the block with the CRC error

The following error refers to the communication between the T200 PLC and the 07 KP 62 communication processor.

Error number: **513_D or 201_H**

A removeable communication error has occurred on the T200 bus. The communication still runs.

Additional information in word 2 of the error class flag area: error message according to T200 agreement as a service information.

- **FK4:**

Error number: **128_D or 80_H**

No user program is existing when system is started.

Detailed information: none

Error number: **129_D or 81_H**

On start, it is detected that the CE "program end" is missing.

Detailed information: none

Error number: **130_D or 82_H**

On start, it is detected that the number of CE parameters is not given correctly in one CE.

Detailed information: program address

Error number: **131_D or 83_H**

On start, it is detected that a syntax error exists in the user program.

Detailed information: program address

Error number: **132_D or 84_H**

On start, it is detected that the historical value memory space is too small.

Detailed information: none

Error number: **133_D or 85_H**

On start, it is detected that no cycle time has been configured.

Detailed information: none

Error number: **134_D or 86_H**

On start, it is detected that a bracket error exists in the user program.

Detailed information: program address

Error number: **135_D or 87_H**

On start, it is detected that the target label for a conditional jump is missing.

Detailed information: program address

Error number: **136_D or 88_H**

NMI (non-maskable interrupt) has occurred, even though it is not connected.

Detailed information: none

Error number: **137_D or 89_H**

A masked interrupt has occurred.

Detailed information: none

The following two errors refer to the back-up battery.

Error number: **514_D or 202_H**

Battery error when battery is tested under load.

Error number: **515_D or 203_H**

Battery error. Battery is missing or exhausted.

Error table (T200 central unit and 07 KP 62)

Error No. of the T200 central unit	LED displays on the 07 KP 62						System flags	Causes
	UB1	RUN	FK1	FK2	FK3	BAT		
41	1	0	x	x	x	x	MW4096,02 (contains the slot No.)	- System configuration is faulty (07 KP 62 is inserted into the wrong slot or missing)
00	1	0	x	x	x	x		- Error detected during the self-test of the communication processor (checksum error, RAM error, initialization error)
51	1	0	x	x	x	x	MW4104,02 (bit 9) MW4096,06	-
53	1	0	x	x	x	x	MW4104,03	-
54	1	0	x	x	x	x	MW4104,03 MW4104,04	-
0 = LED off, 1 = LED on, x = LED on or off								
Fig. 12.3.12: Error table (T200 central unit and 07 KP 62)								

Reaction on Switching-over to STOP or on Power OFF

If the central unit of the ABB Procontic T200 is switched over to STOP, the user program running in the 07 KP 62 is also stopped.

Note:

The user program of the 07 KP 62 can only be aborted or started by means of the programming unit, when the central unit of the ABB Procontic T200 is in the RUN state.

Developing of the user program and its transfer to the 07 KP 62 is also feasible, when the central unit is in the STOP state.

On the transition of the T200 central unit from the STOP state into the RUN state, the configured flag area as well as the 4 I/O words are initialized.

If the power supply of the T200 system is switched off, the data transmission over both serial interfaces (COM1/programming/MMC and COM2/MMC) will break down.

Technical Data

07 KP 62 R202

General data

Max. number of 07 KP 62 in one subrack or sum of modules of 07 KP 6x	4																											
Number of serial interfaces	2, see Fig. 12.3.2																											
Indication of errors and operating conditions	6 LEDs, see Fig. 12.3.2																											
Number of required slots	1 I/O slot																											
Number of occupied I/O points	4 input and 4 output words (= 128 I/O points)																											
Configuration identifier in 907 PC 32 (T200)	KP6X																											
Ability of fitting in subracks	<table border="1"><thead><tr><th colspan="3">BT</th><th colspan="3">BE central</th><th colspan="3">BE remote</th></tr></thead><tbody><tr><td>NG</td><td>ZE</td><td>I/O</td><td>NG</td><td>BV</td><td>I/O</td><td>NG</td><td>BV</td><td>I/O</td></tr><tr><td></td><td></td><td>●</td><td></td><td></td><td></td><td></td><td></td><td></td></tr></tbody></table>	BT			BE central			BE remote			NG	ZE	I/O	NG	BV	I/O	NG	BV	I/O			●						
BT			BE central			BE remote																						
NG	ZE	I/O	NG	BV	I/O	NG	BV	I/O																				
		●																										
Slot, ● = plug-in is possible (occupies 1 slot)																												
Current consumption from internal voltages UB1 = 5 V DC ± 5 % UB4 = 24 V DC	max. 0.5 A no current consumption																											
	If the TCZ programming, diagnosis and service device is connected to an interface, the current consumption of UB1 (+5 V) increases by ca. 50 mA.																											
Total power dissipation	max. 2.5 W																											
Back-up of internal flags	with 07 LE 90 battery module																											
Weight	ca. 900 g																											
Software capabilities																												
Integrated memory, 07 KP 62 R202:	Flash EPROM 128 kB (60 kB program + 60 kB user data) RAM 256 kB (30 kB program with online programming or 60 kB program without online programming)																											
1 instruction uses	4 bytes of program memory																											
Cycle time (binary operation)	typ. 1.6...2 ms/k instructions																											
Cycle time (65 % bits, 35 % words)	typ. 2.9 ms/k instructions																											
Number of software timers	any (max. 80 simultaneously active)																											
Delay time of the software timers	5 ms...24.8 days																											
Number of up/down counter software blocks	any																											
Number of bit flags	4096																											
Number of word flags	4096																											
Number of double word flags	512																											
Diagnosis	cycle time monitoring, battery monitoring, detection of syntax errors and checksum monitoring																											

Serial interface COM1

Units which can be connected to the interface

- a) programming unit (IBM PC or compatible)
or TCZ programming, diagnosis and service device
- b) MMC devices

The operating modes a) or b) are defined by the status of pin 6 of the interface plug or by the system constant KW 0,6 stored in the operand memory.

Serial interface COM2

Units which can be connected to the interface

only MMC devices

Common data of the serial interfaces

Interface standard

EIA-232

Electrical isolation

yes, see also Fig. 12.3.3

The power supply for the TCZ programming, diagnosis and service device conducted through the interface cable is not electrically isolated, neither the pins 6 and 8 for programming the operating mode (only with COM1)

Interface connectors

9-pole D-plugs, female, see Fig. 12.3.2

Transmission speed (Baud rate)

300...9600 Baud

Character length

7 or 8 bits

Parity bit

even, odd, no (space parity)

Number of start bits

1

Number of stop bits

1

Handshake method

RTS/CTS (hardware handshake)

Ordering information

Communication processor 07 KP 62 R202

Order No. GJR5 2404 00 R202

Battery module 07 LE 90

Order No. GJR5 2507 00 R1

System cable 07 SK 90

for connection of 07 KP 62 via COM1
with 907 PC 331

Order No. GJR5 2502 00 R1

System cable 07 SK 91

for connection of 07 KP 62 via COM1/COM2
with MMC systems

Order No. GJR5 2503 00 R1

Programming software 907 PC 331, German
with description of 07 KP 62 performance

Order No. GJP5 2045 00 R302

Programming software 907 PC 331, English
with description of 07 KP 62 performance

Order No. GJP5 2046 00 R302

Programming software 907 PC 33, German
Programming software, general part

Order No. GJP5 2039 00 R202

Programming software 907 PC 33, English
Programming software, general part

Order No. GJP5 2040 00 R202

Appendix

Memory overview

User program RAM

Not used	38F50
	38F42
Constants for program 2 702H bytes	
	38840
Turbo RAM program 2 12EB0H bytes	
	25990
User program memory 2 7800H bytes	
	1E190
Not used	
	1E182
Constants for program 1 702H bytes	
	1DA80
Turbo RAM program 1 12EB0H bytes	
	0ABD0
User program memory 1 7800H bytes	
	033D0
Not used	
	033B0
Program identification	
	033A0
Organizational directory for program 2	
	0338A
Organizational directory for program 1	
	03374
Organizational directory PLC-specific	
	03360
Control block 0...2	
	03330

Explanation of terms:

- Organizational directory
 - PLC specific: This is used to store organizational data relating to the entire PLC.
 - for user program 1: This is used to store organizational data relating to program memory 1.
 - for user program 2: This is used to store organizational data relating to program memory 2.

- Program identification:
16 bytes for an identification, e.g. project name.

User program Flash EPROM

	C0000
User data segment 3 3C20H bytes	
	BC000
User data segment 2 3C20H bytes	
	B8000
User data segment 1 3C20H bytes	
	B4000
User data segment 0 3C20H bytes	
	B0000
Checksum	
	AFFFE
Not used 98CH bytes	
	AF672
User program EF00H bytes	
	A0772
Constants 702H bytes	
	A0070
Not used 20H bytes	
	A0050
Program identification	
	A0040
Organizational directory for program 2	
	A002A
Organizational directory for program 1	
	A0014
Organizational directory PLC-specific	
	A0000

- User program memory 1:
Memory for the PLC program
- Turbo RAM program 1:
Machine code for user program memory 1
- Constants for program 1:
This area is used to store the indirect constants of the user program memory 1.
- User program memory 2:
Memory for the PLC program
- Turbo RAM program 2:
Machine code for user program memory 2

- Constants for program 2:
This area is used to store the indirect constants of the user program memory 2.
- User data segment 0 ... segment 3:
In this area, the user data of the segments 0...3 are stored. The user data are secured by a checksum.

Operand memory

40000	Not used	8H	SEG:F0B0
3FFF8			SEG:F0A8
3FD70	I/O force lists	288H	SEG:EE20
3FD60	Not used	10H	SEG:EE10
3FC60	Stack 2	100H	SEG:ED10
3FB60	ASAS 2	100H	SEG:EC10
3E360	VWS	1800H	SEG:D410
3DB60	S	800H	SEG:CC10
3D360	MD	800H	SEG:C410
3B360	MW	2000H	SEG:A410
3A360	M	1000H	SEG:9410
3A260	AW	100H	SEG:9310
39E60	A	400H	SEG:8F10
39D60	EW	100H	SEG:8E10
39960	E	400H	SEG:8A10
39760	KD	200H	SEG:8810
39260	KW	500H	SEG:8310
3925E	K	2H	SEG:830E
39150	Free Pool	10EH	SEG:8200
39050	Stack 1	100H	SEG:8100
38F50	ASAS 1	100H	SEG:8000

SEG =30F5

Explanation of terms:

ASAS 1: Work memory program 1

Stack 1: Stack for program 1

K: Indirect constants BINARY

KW: Indirect constants WORD

KD: Indirect constants
DOUBLE WORD

E: Process image of the inputs BINARY

EW: Process image of the inputs WORD

A: Process image of the outputs BINARY

AW: Process image of the outputs WORD

M: Flags BINARY

MW: Flags WORD

MD: Flags DOUBLE WORD

S: Step chains

VWS: Historical value memory

ASAS 2: Work memory program 2

Stack 2: Stack for program 2

I/O force lists:

The I/O signals to be forced as well as the force values are entered here.

List of connection elements (next page)

The detailed description of the listed connection elements is given in the 907 PC 331 documentation.

List of Connection Elements for 07 KP 62

Name of function	Call in FBD/LD, ext. IL / IL ¹⁾
------------------	--

Binary Functions

AND	& ²⁾
OR	/ ²⁾
Exclusive OR	=1 ²⁾
Majority	MAJ
Allocation	= ²⁾

Latch Functions

Allocation, set memory	=S ²⁾
Allocation, reset memory	=R ²⁾
Set memory, dominating	RS ²⁾
Reset memory, dominating	SR ²⁾

Arithmetic Functions, Word

Addition	+ ²⁾
Subtraction	- ²⁾
Multiplication	* ²⁾
Division	: ²⁾
Multiplication with division	*: / MULDI
Multiplication by 2 to the power of n	MUL2N
Absolute value generator	BETR
Allocation word	=W ²⁾
Allocation direct constant to word variable	ZUDKW
Square root	SQRT

Arithmetic Functions, Double Word

Addition, double word	+D / ADDD
Subtraction, double word	-D / SUBD
Multiplication, double word	*D / MULD
Division, double word	:D / DIVD
Double word multiplication by 2 to the power of n	MUL2ND
Negation, double word	NEGD
Absolute value generator, double word	BETRD
Allocation, double word	=D / ZUWD
Square root	SQRT

Name of function	Call in FBD/LD, ext. IL / IL ¹⁾
------------------	--

Arithmetic Functions, Double Word

Cosine	COS1
Sine	SIN1

Comparison Functions

Greater than	> ²⁾
Greater than or equal to	>= ²⁾
Equal	=? ²⁾
Unequal	>< ²⁾
Less than or equal to	<= ²⁾
Less than	< ²⁾
Comparator with 3-point response	VGL3P
Comparator with unilateral hysteresis	VGLEH
Comparator with asymmetrical hysteresis	VGLUH

Comparison Functions, Double Word

Greater than, double word	>D / VGRD
Less than, double word	<D / VKLD
Equal, double word	=?D / VGLD

Timer Functions

On delay	ESV
Off delay	ASV
Monostable element "abort"	MOA
Monostable Element "constant"	MOK
Variable delay element	VVZ

Counter Functions

Up-down counter	VRZ
Up-down counter, double word	VRZD

1) If a different call exists for IL compared to FBD/LD and extended IL, it is additionally given and separated by a /.

2) This function is generated in the IL by a sequence of commands and/or blocks.

Name of function	Call in FBD/LD, ext. IL / IL ¹⁾
------------------	--

Name of function	Call in FBD/LD, ext. IL / IL ¹⁾
------------------	--

Program Control Functions

Conditional jump to label	SPBM
Target label	MRK
Program end	PE
Conditional program end	=PE ²⁾
Subroutine call for an assembler program	CALLUP
Run number block	LZB
Program abortion	ABORT

Logical Functions with Double Word Values

AND combination, double word	DWAND
OR combination, double word	DWOR
Exklusive OR combination double word	DWXOR
Mask, double word	MASKED
Shift block	SHIFT

Format Conversion

BCD to binary conversion	BCDDUAL / BCDBIN
Binary to BCD conversion	DUALBCD / BINBCD
Pack binary variables in word	PACK
Unpacking a word into binary variables	UNPACK
Word to double word conversion	WDW
Double word to word conversion	DWW
BCD to binary conversion, double word	BCDDUALD / BCDDWD
Binary to BCD conversion, double word	DUALBCDD / DWBCD
Pack binary variables in double word	PACKD
Unpacking a double word into binary variables	UNPACKD / UNPAD

Access to Physical Addresses

Read word with enabling	WOL
Write word with enabling	WOS
Write word in the event of value change	WAES
Copying memory areas	COPY

Double Word Access to Physical Addresses

Read double word with enabling	DWOL
Write double word with enabling	DWOS
Write double word in the event of value change	DWAES

Access to Physical Addresses (I/O Ports)

Read byte value from I/O address	IOR
Write byte value to I/O address	IOW

Pulse

Puls (positive edge)	I+ ²⁾
Puls (negative edge)	I- ²⁾

Higher Order Functions

Word decoder	WDEC
Word recoder	UMC
Double word recoder	DWUMC
Binary selection gate	AWTB
Selection gate, word	AWT
Selection gate, double word	AWTD
Switch-over gate	UST
Switch-over gate with reset	USTR
Switch-over gate, double word	USTD
Switch-over gate with reset, double word	USTRD

Logical Functions with Word Values

AND combination, word	WAND
OR combination, word	WOR
Exclusive OR combination, word	WXOR
Mask	MASKE
Shift block	SHIFT

¹⁾ If a different call exists for IL compared to FBD/LD and extended IL, it is additionally given and separated by a /.

²⁾ This function is generated in the IL by a sequence of commands and/or blocks.

Name of function	Call in	
	FBD/LD, ext. IL	/ IL ¹⁾

Higher Order Functions

Maximum value generator	MAX
Maximum value generator, double word	MAXD
Minimum value generator	MIN
Minimum value generator, double word	MIND
Maximum value generator as a function of time	MAZ
Maximum value generator as a function of time, double word	MAZD
Limiter	BEG
Limiter, double word	BEGD
Ramp-function generator	HLG
Function generatorsgeber	FKG
Last-in-first-out stack	LIFO
First-in-first-out stack	FIFO
Error searcher with automatic deletion	FEHSU
Error searcher with storage	SFEHSU
List allocator	LIZU
Address selection	ADRWA
Selection multiplexer	AWM
Switch-over multiplexer	USM
Analog value change annunciator	AMELD
Analog value change annunciator, double word	AMELDD
Binary value change annunciator	BMELD
Bit searcher	BITSU
Demultiplexer	DMUX
Demultiplexer, double word	DMUXD
Multiplexer with reset	MUXR
Multiplexer double word with reset	MUXRD
Read binary variable, indexed	IDLB
Write binary variable, indexed	IDSB
Read word variable, indexed	IDLm / IDL

Name of function	Call in	
	FBD/LD, ext. IL	/ IL ¹⁾

Write word variable, indexed	IDS _m / IDS
Illumination pushbutton control	LDT
Initialize memory area in the operand memory with zero	INITS
Initialize variables	INITV

Closed-loop Control Functions

Differentiator with delay of the first order	DT1
Integrator (extended)	INTK
Proportional-integral controller	PI
PT1 element	PT1
PIDT1 controller	PIDT1
Pulse duration modulator	PDM
Adaption for adaptive temperature control	ADAPT ³⁾

Communication through Serial Interface

Initialization and configuration of the serial interfaces	SIN / SINIT
Initialization and configuration of the serial interfaces	SINIT
Output of ASCII characters and hex values through a serial interface	DRUCK
Reception of characters	EMAS _m / EMAS
Additional comparison telegrams for EMAS _m	EMAS _m VT ⁴⁾

Access to Flash EPROM

Delete data segment in Flash EPROM	FDEL
Read data set from Flash EPROM	FRD
Write data set to Flash EPROM	FWR

- 1) If a different call exists for IL compared to FBD/LD and extended IL, it is additionally given and separated by a /.
2) This function is generated in the IL by a sequence of commands and/or blocks.
3) Call is only feasible in IL. 4) Call is not feasible in IL.

Name of function	Call in	
	FBD/LD, ext. IL	/ IL ¹⁾

Historical Values

Read binary values from historical values memory	RDB
Write binary values into historical values memory	WRB
Read word values from historical values memory	RDW
Write word values into historical values memory	WRW
Read double word values from historical values memory	RDDW
Write double word values into historical values memory	WRDW

Special Functions

If then	impossible / ²⁾
If then, word	impossible / ²⁾
Not Bit	impossible / ²⁾

Description of the additional connection elements (as of next page)

- 1) If a different call exists for IL compared to FBD/LD and extended IL, it is additionally given and separated by a /.
- 2) This function is generated in the IL by a sequence of commands and/or blocks.
- 3) Call is only feasible in IL. 4) Call is not feasible in IL.

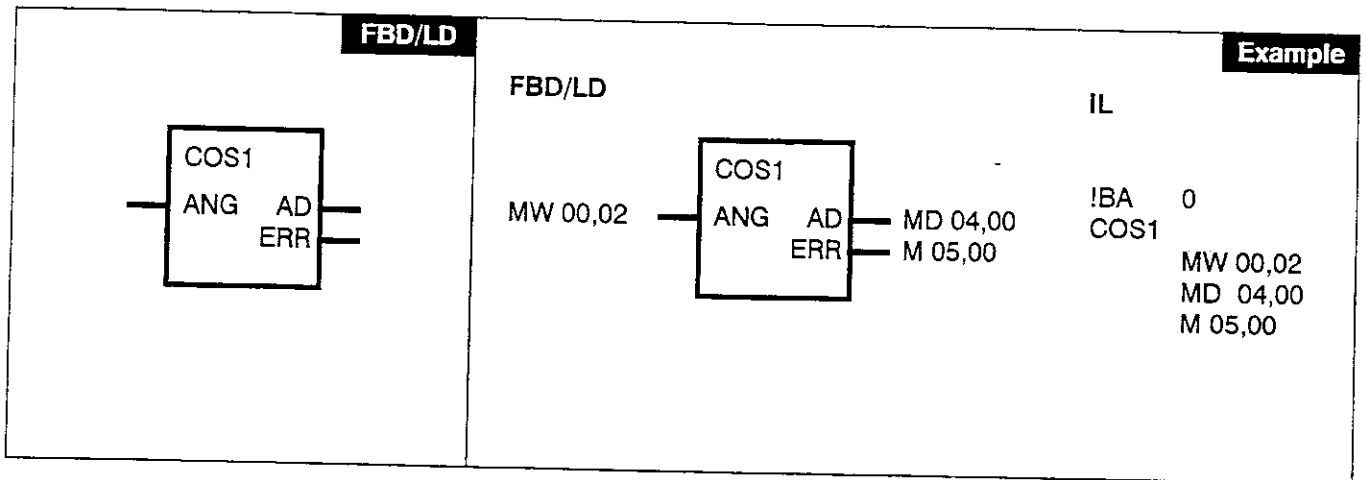

Parameters

ANG	WORD	EW, AW, MW	Angle 0...3600 (corresponds to 0.0°360.0°)
AD	DOUBLE WORD	AD, MD	Cosine of the input value
ERR	BINARY	M, A	Error, if input value is negative or greater than 3600

Description

The function block calculates the cosine value from input ANG and assigns it to the output AD. The result is within the range of -100,000 to +100,000. If the value at ANG is negative or greater than 3600 (360°), the output AD is set to 0 and the error output ERR is set to 1. The maximum deviation of the result is ± 0.5.

ANG WORD

The cosine value from the input operand ANG is calculated. The result is available as the output operand at AD.

Input values:

- 0000 for 0 degrees
- 0001 for 0.1 degrees
- 0010 for 1.0 degrees
- ..
- 3600 for 360.0 degrees

AD DOUBLE WORD

The cosine value of the input ANG is available at the output AD.

ERR BINARY

This output indicates whether the input value is within the correct range ($0 \leq ANG \leq 3600$).

Input $0 \leq ANG \leq 3600$

-> ERR = 0 and AD = COS(ANG)

Input $ANG < 0$ or $ANG > 3600$

-> ERR = 1 and AD = 0

Examples for cosine values

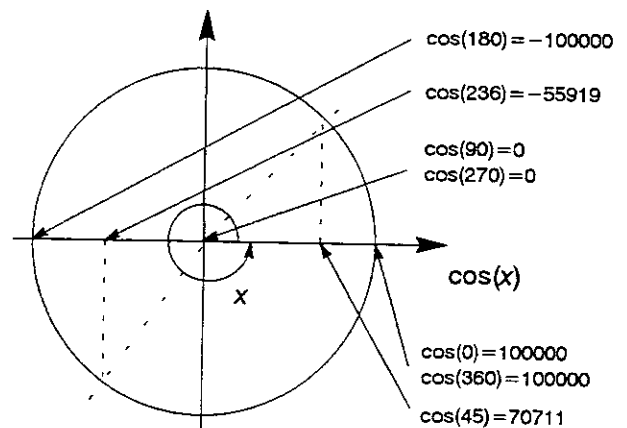

CE data

Runtime:

Basic runtime:

Additional runtime:

Updating of the outputs:

Number of historical values:

Available as of:

07 KR 91 / 07 KT 92 / 07 KT 93 / 07 KP 62

42 - 71 μ s

yes

0 words

ABB Procontic CS31 07KT92 R202/R262, 07KT93 R171

ABB Procontic T200 07KP62 R202

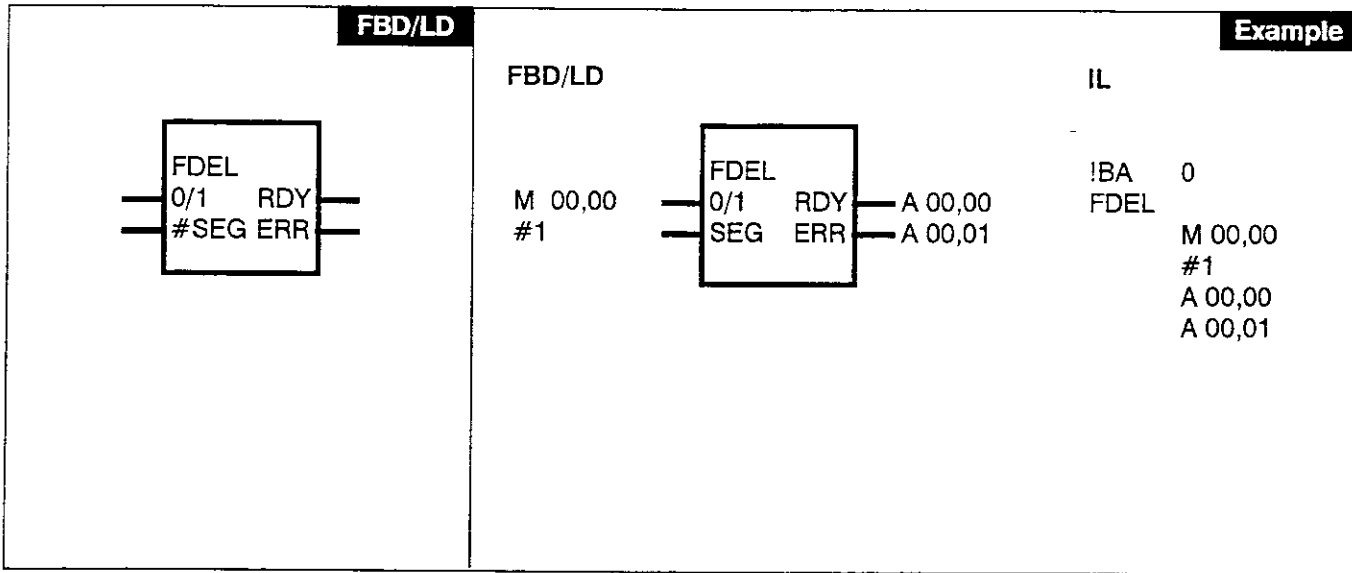

Parameters

0/1	BINARY	E, M, A, K, S	Deletion of <i>one</i> data segment by a 0/1 edge
#SEG	DIRECT CONSTANT	#, #H	Number of the data segment in the FLASH EPROM 0...3
RDY	BINARY	A, M	Write procedure completed
ERR	BINARY	A, M	Error occurred, data segment cannot be deleted

Description

This function block deletes a data segment in the Flash EPROM. All data in this data segment are lost after deletion.

Important notes:

An access to the Flash EPROM is only permitted by using the function blocks FWR and FRD. It is **not allowed** to access the Flash EPROM by other function blocks (WOL, WOS, COPY,...).

The input #SEG defines the data segment in the Flash EPROM.

The deletion procedure in the Flash EPROM can take several PLC cycles.

A 0/1 edge at the input 0/1 starts the deletion procedure *once*. Until the procedure has not been finished (RDY = 1), the input 0/1 will not be evaluated again.

After completion of the deletion procedure all function block outputs are updated. If then RDY = 1 and ERR = 0, the deletion was successful. If the outputs show RDY = 1 and ERR = 1, the data segment could not be deleted.

0/1 BINARY

The input 0/1 controls the processing of the function block.

0/1 = 0: All outputs are set to the value of "0". This is not valid during a deletion procedure.

0/1 = 0/1 edge: Deletion of the data segment is started *once*. Until the procedure has not been finished (RDY = 1), the input 0/1 will not be evaluated again.

0/1 = 1: The function block is not processed, i.e. the function block does no longer change its outputs. This is not valid during a deletion procedure.

#SEG DIRECT CONSTANT

The number of the data segment in the Flash EPROM is given at the input SEG. In the Flash EPROM, 4 data segments are available.

The following is valid:

- #0 corresponds to data segment 0
- #1 corresponds to data segment 1
- #2 corresponds to data segment 2
- #3 corresponds to data segment 3

RDY BINARY

The output RDY indicates, that the deletion procedure has been completed. This output has always to be considered together with the output ERR.

The following is valid:

RDY = 1 and ERR = 0: The deletion procedure has been completed. The data segment has been deleted successfully.

RDY = 1 and ERR = 1: An error has occurred during the deletion procedure. The data segment could not be deleted.

ERR BINARY

The output ERR indicates whether or not an error has occurred during the deleting procedure. This output has always to be considered together with the output RDY.

If the data segment could not be deleted, the outputs have the following statuses:

RDY = 1 and ERR = 1

The inputs as well as the outputs can neither be doubled nor be inverted.

CE data

Runtime:

Basic runtime:

Additional runtime:

Updating of the outputs:

Number of historical values:

Available as of:

07 KR 91 / 07 KT 92 / 07 KT 93 / 07 KP 62

23 – 53 μ s

no

2 words

ABB Procontic CS31 07KT92 R202/R262, 07KT93 R171

ABB Procontic T200 07KP62 R202

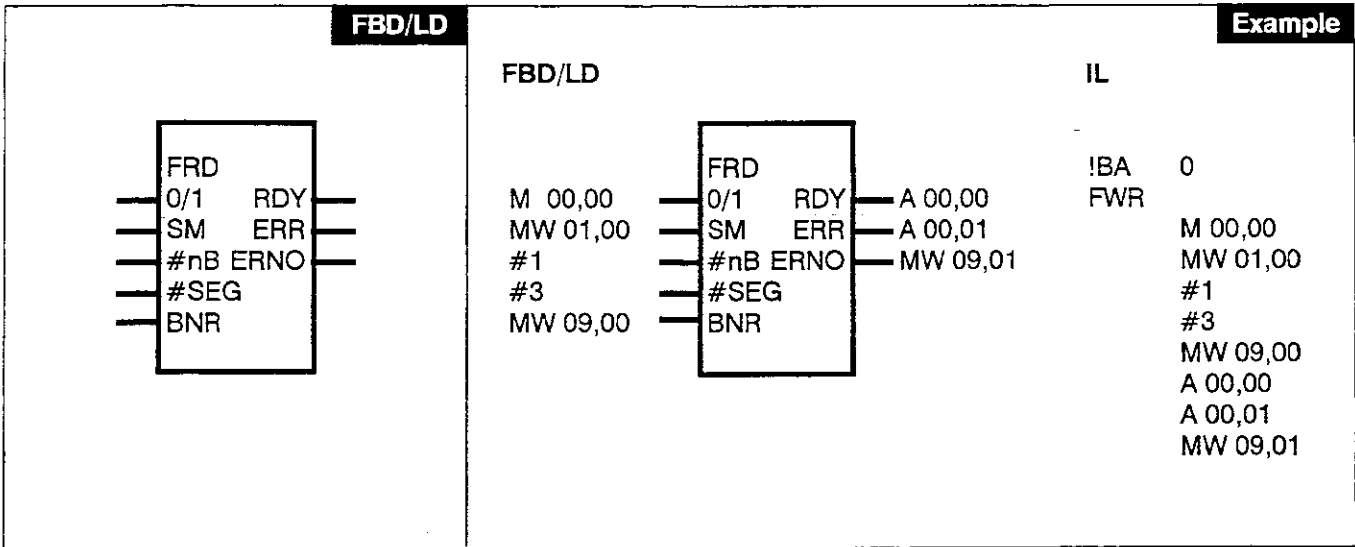

Parameters

0/1	BINARY	E, M, A, K, S	Reading of <i>one</i> data set by a 0/1 edge
SM	BINARY	E, M, A, K, S	
	WORD	EW, MW, AW, KW	
	DOUBLE WORD	MD, KD	
#nB	DIRECT	#, #H	Start flag of the location of the data set
	CONSTANT		Number of blocks of the data set
			1...481
#SEG	DIRECT	#, #H	Number of the data segment in the Flash EPROM
	CONSTANT		0...3
BNR	WORD	EW, MW, AW, KW	Number of the block in the data segment
			valid values: 0 ... 480
RDY	BINARY	A, M	Reading procedure completed
ERR	BINARY	A, M	Occurred error
ERNO	WORD	AW, MW	Error number

Description

This function block reads a data set from a data segment in the Flash EPROM and stores the read data set beginning at the start flag defined by SM. The data of the data set had been stored in the Flash EPROM by the function block FWR or by the operating command FWR.

Important note:

An access to the Flash EPROM is only permitted by using the function blocks FWR and FRD. It is **not allowed** to access the Flash EPROM by other function blocks (WOL, WOS, COPY,...).

The inputs SM and #nB define, which data are read from the Flash EPROM. The input #SEG defines the data segment in the Flash EPROM. The number of data, which are read from a block, depends on input SM.

The following is valid:

Either 32 binary data or 16 word data or 8 double word data are read per block. The data of each block are secured by a checksum.

The reading procedure is carried out once by a 0/1 edge at the input 0/1. If there was no error when reading the data, the output RDY is set to "1" and the outputs ERR and ERNO are set to "0". The data set is stored beginning at the defined start flag SM.

Storing the data set can take several PLC cycles.

If an error occurs during the reading procedure, RDY and ERR are both set to "1". The error type is indicated at the output ERNO.

The outputs RDY, ERR and ERNO are set to "0" by a signal 0 at the input 0/1.

0/1 BINARY

The processing of the block is controlled by the input 0/1 .

0/1 = 0: The outputs RDY, ERR and ERNO are set to "0".

0/1 = 0/1 edge: The reading procedure of the data set is carried out *once*.

0/1 = 1: The block is not processed, i.e. it does not change its outputs any more.

SM BINARY / WORD / DOUBLE WORD

The first binary/word/double-word flag for storing the data set is given at input SM.

#nB DIRECT CONSTANT

The number of blocks of the data set is given at input #nB. The number of data, which are read by a block, depends on the input SM. Either 32 binary data or 16 word data or 8 double word data are read per block.

Examples:

- SM = M 01,00 and #nB = 1:
Storing the data from M 01,00 to M 02,15
(1 block = 32 binary data)
- SM = M 01,00 and #nB = 2:
Storing the data from M 01,00 to M 04,15
(2 blocks = 64 binary data)
- SM = MW 02,00 and #nB = 1:
Storing the data from MW 02,00 to MW 02,15
(1 block = 16 word data)
- SM = MW 02,00 and #nB = 2:
Storing the data from MW 02,00 to MW 03,15
(2 blocks = 32 word data)
- SM = MD 03,00 and #nB = 1:
Storing the data from MD 03,00 to MD 03,07
(1 block = 8 double word data)
- SM = MD 03,00 and #nB = 2:
Storing the data from MD 03,00 to MD 03,15
(2 blocks = 16 double word data)

#SEG DIRECT CONSTANT

The number of the data segment in the Flash EPROM is given at the input SEG. In the Flash EPROM, 4 data segments are available.

The following is valid:

- #0 corresponds to data segment 0
- #1 corresponds to data segment 1
- #2 corresponds to data segment 2
- #3 corresponds to data segment 3

BNR WORD

The number of the block in the data segment is given at the input BNR.

Valid values: 0...480

RDY BINARY

The output RDY indicates, that the reading procedure has been completed. The output has always to be considered together with the output ERR.

The following is valid:

RDY = 1 and ERR = 0: The reading procedure has been completed. The data set is stored beginning at the definition at the input SM.

RDY = 1 and ERR = 1: An error has occurred during the reading procedure. The output ERNO indicates the error number.

ERR BINARY

The output ERR indicates whether or not an error has occurred during the reading procedure. The output has always to be considered together with the output RDY. If there was an error, the outputs have the following statuses:

RDY = 1 and ERR = 1

The output ERNO indicates the error number.

ERNO WORD

The output ERNO indicates an error number. This output has always to be considered together with the outputs RDY and ERR.

The error number is coded binary.

The following applies:

- ERNO = 0: There was no error.
- ERNO = 1: Block number and number of blocks is greater than 480
(bit 0 of ERNO = 1).
- ERNO = 2: Data segment is greater than 3
(bit 1 of ERNO = 1).
- ERNO = 4: Checksum error of read data.
The data are not entered into the flag area
(bit 2 of ERNO = 1).

The inputs as well as the outputs can neither be doubled nor be inverted.

CE data

Runtime:

Grundlaufzeit:

Additional runtime:

Updating of the outputs:

Number of historical values:

Available as of:

07 KR 91 / 07 KT 92 / 07 KT 93 / 07 KP 62

25 - 67 μ s

no

2 words

ABB Procontic CS31 07KT92 R202/R262,07KT93 R171
ABB Procontic T200 07KP62 R202

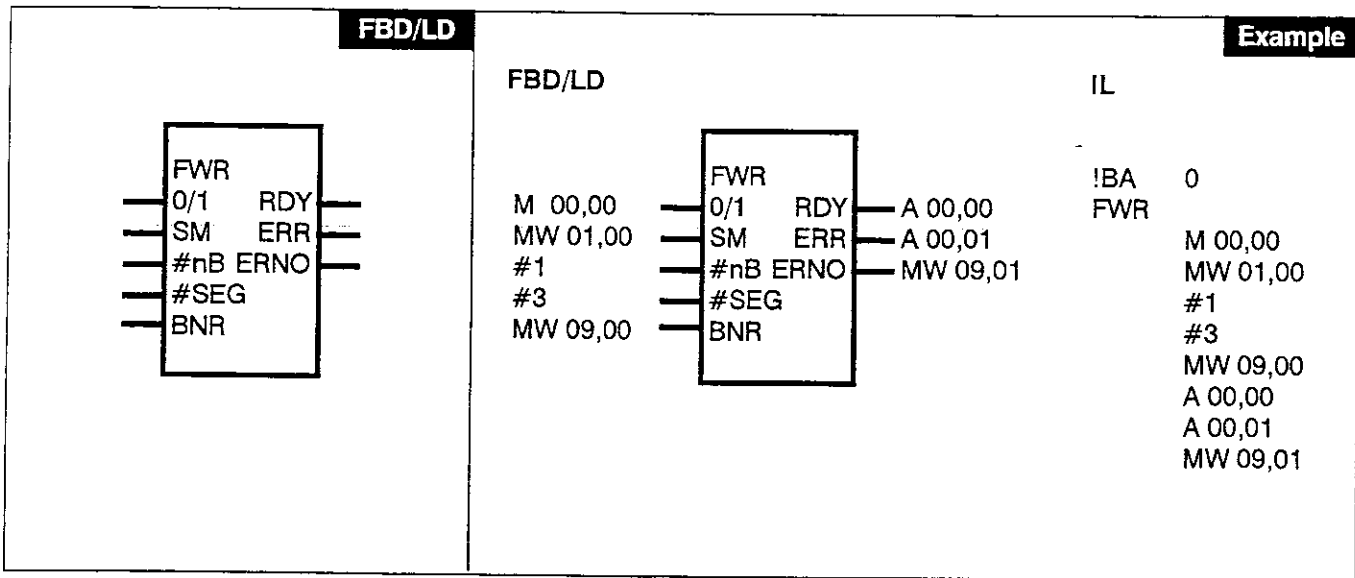

Parameters

0/1	BINARY	E, M, A, K, S	Saving of <i>one</i> data set by a 0/1 edge
SM	BINARY	E, M, A, K, S	
	WORD	EW, MW, AW, KW	
	DOUBLE WORD	MD, KD	
#nB	DIRECT	#, #H	Start flag of the data set
	CONSTANT		Number of blocks of the data set
			1...481
#SEG	DIRECT	#, #H	Number of the data segment in the Flash EPROM
	CONSTANT		0...3
BNR	WORD	EW, MW, AW, KW	Number of the block in the data segment
			valid values: 0...480
RDY	BINARY	A, M	Writing procedure completed
ERR	BINARY	A, M	Occurred error
ERNO	WORD	AW, MW	Error number

Description

The function block writes a data set to a data segment in the Flash EPROM. For this purpose, there are 4 data segments (0...3) available in the Flash EPROM. A deletion procedure (function block FDEL) always deletes a complete data segment. Each data segment consists of 481 blocks (0...480). After deletion, each of these 481 blocks can store data only **once**. If a block containing data is to be overwritten by new data, the entire data segment has to be deleted beforehand. In doing so, all data in this segment are lost.

Important note:

An access to the Flash EPROM is only permitted by using the function blocks FWR and FRD. It is **not allowed** to access the Flash EPROM by other function blocks (WOL, WOS, COPY,...).

For each user data set, a separate function block FWR as well as a separate function block FRD have to be planned in the PLC program.

The inputs SM and #nB define, which data are written to the Flash EPROM. The input #SEG defines the data segment in the Flash EPROM. The number of data, which can be stored in the block, depends on input SM.

The following applies:

Either 32 binary data or 16 word data or 8 double word data are written per block. The data of each block are secured by a checksum.

When a writing procedure of a data set is started (0/1 edge at input 0/1), the data of the data set must not be changed until the end of the writing procedure (RDY = 1).

Storing the data set in the Flash EPROM can take several PLC cycles.

A 0/1 edge at input 0/1 starts the writing procedure of the data set *once*. The input 0/1 is no longer evaluated until the storing of the data set has been completed (RDY = 1).

After completion of the writing procedure the block outputs RDY, ERR and ERNO are updated. If RDY = 1 and ERR = 0, the procedure was successful. If RDY = 1 and ERR = 1, an error had occurred. The output ERNO indicates the error type then.

After storing the data set in the Flash EPROM, the block outputs RDY, ERR and ERNO are set to "0" by a signal 0 at input 0/1. A new 0/1 edge at input 0/1 starts a new writing procedure. Since without a previous deletion of the data segment no new data can be written to blocks which already contain data, the input BNR must point to the next free block for the next writing procedure.

0/1 BINARY

The processing of the function block is controlled by the input 0/1.

0/1 = 0: The outputs RDY, ERR and ERNO are set to "0". This is not valid during a writing procedure.

0/1 = 0/1 edge: The writing procedure of the data set is started *once*. The input 0/1 is no longer evaluated until the writing procedure has been completed (RDY = 1).

0/1 = 1: The function block is not processed, i.e. it does not change its outputs any more. This is not valid during a writing procedure.

SM BINARY / WORD / DOUBLE WORD

The first binary/word/double-word flag of the data set is given at input SM. When the writing procedure of a data set has been started (0/1 edge at input 0/1), the data of the data set must not be changed until the procedure has been completed (RDY = 1).

#nB DIRECT CONSTANT

The number of blocks of the data set is given at input #nB. The number of data, which can be stored in a block, depends on input SM. Either 32 binary data or 16 word data or 8 double word data are stored per block.

Examples:

- SM = M 01,00 and #nB = 1:
Writing of the data from M 01,00 to M 02,15
(1 block = 32 binary data)
- SM = M 01,00 and #nB = 2:
Writing of the data from M 01,00 to M 04,15
(2 blocks = 64 binary data)
- SM = MW 02,00 and #nB = 1:
Writing of the data from MW 02,00 to MW 02,15
(1 block = 16 word data)
- SM = MW 02,00 and #nB = 2:
Writing of the data from MW 02,00 to MW 03,15
(2 blocks = 32 word data)
- SM = MD 03,00 and #nB = 1:
Writing of the data from MD 03,00 to MD 03,07
(1 block = 8 double word data)
- SM = MD 03,00 and #nB = 2:
Writing of the data from MD 03,00 to MD 03,15
(2 blocks = 16 double word data)

#SEG DIRECT CONSTANT

The number of the data segment in the Flash EPROM is given at the input SEG. In the Flash EPROM, 4 data segments are available.

The following is valid:

- #0 corresponds to data segment 0
- #1 corresponds to data segment 1
- #2 corresponds to data segment 2
- #3 corresponds to data segment 3

BNR WORD

The number of the block in the data segment is given at the input BNR.

Valid values: 0...480

RDY BINARY

The output RDY indicates that the writing procedure of the data set has been completed. The output has always to be considered together with the output ERR.

The following applies:

- RDY = 1 and ERR = 0: The writing procedure is completed. The data set has been stored in the Flash EPROM.
- RDY = 1 and ERR = 1: An error has occurred during the writing procedure. The output ERNO indicates the error number.

ERR BINARY

The output ERR indicates whether or not an error has occurred during the writing procedure. The output has always to be considered together with the output RDY.

If an error has occurred, the following is valid:

RDY = 1 and ERR = 1.

The output ERNO indicates the error number then.

ERNO WORD

The output ERNO indicates an error number. This output has always to be considered together with the outputs RDY and ERR.

The following applies:

- ERNO = 0: There was no error.
ERNO = 1: Block number and number of blocks is greater than 480
(bit 0 of ERNO = 1).
ERNO = 2: Data segment is greater than 3
(bit 1 of ERNO = 1).
ERNO = 4: Flash EPROM is not writeable
(bit 2 of ERNO = 1).
ERNO = 8: Block already contains data
(bit 3 of ERNO = 1).

The inputs as well as the outputs can neither be doubled nor be inverted.

CE data

Runtime:

Basic runtime:

Additional runtime:

Updating of the outputs:

Number of historical values:

Available as of:

07 KR 91 / 07 KT 92 / 07 KT 93 / 07 KP 62

22 – 67 μ s

no

2 words

ABB Procontic CS31 07KT92 R202/R262, 07KT93 R171

ABB Procontic T200 07KP62 R202

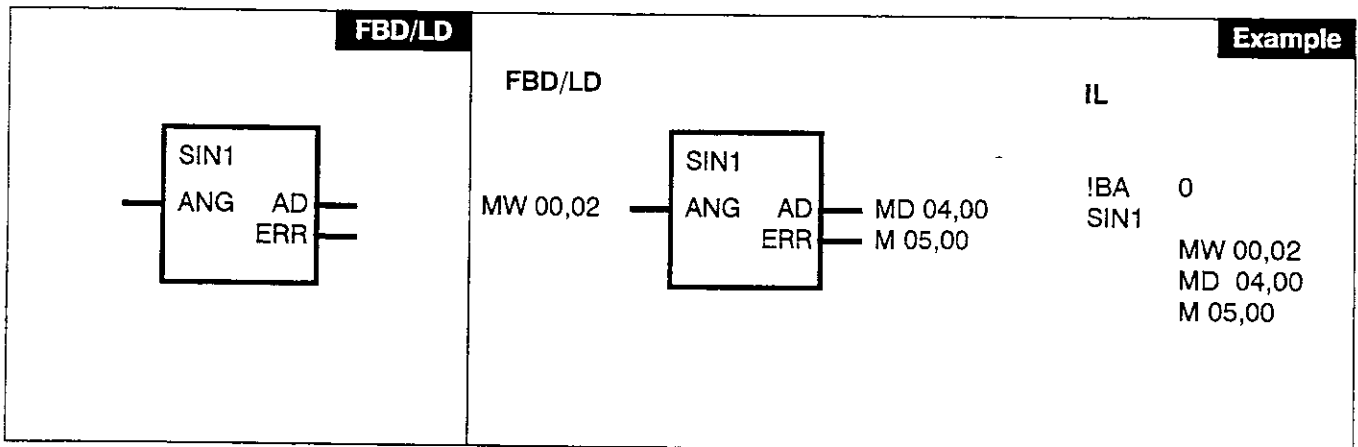

Parameters

ANG	WORD	EW, AW, MW	Angle 0...3600 (corresponds to 0.0°....360.0°)
AD	DOUBLE WORD	MD	Sine of the input value
ERR	BINARY	M, A	Error, if input value is negative or greater than 3600

Description

The function block calculates the sine value from input ANG and assigns it to the output AD. The result is within the range of -100,000 to +100,000.

If the value at ANG is negative or greater than 3600 (360°), the output AD is set to 0 and the error output ERR is set to 1.

The maximum deviation of the result is ± 0.5.

ANG WORD

The sine value from the input operand ANG is calculated. The result is available as the output operand at AD.

Input values:

- 0000 for 0 degrees
- 0001 for 0.1 degrees
- 0010 for 1.0 degrees
- ..
- 3600 for 360.0 degrees

AD DOUBLE WORD

The sine value of the input ANG is available at the output AD.

ERR BINARY

This output indicates whether the input value is within the correct range ($0 \leq ANG \leq 3600$).

Input $0 \leq ANG \leq 3600$

-> ERR = 0 and AD = SIN(ANG)

Input $ANG < 0$ or $ANG > 3600$

-> ERR = 1 and AD = 0

Examples for sine values

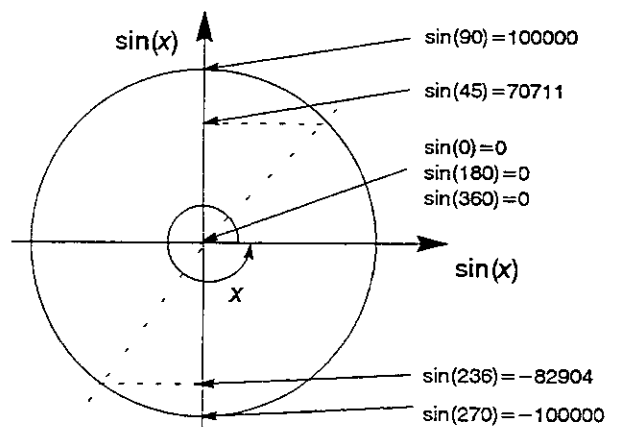

CE data

Runtime:

Basic runtime:

07 KR 91 / 07 KT 92 / 07 KT 93 / 07 KP 62

Additional runtime:

47 – 69 μs

Updating of the outputs:

Number of historical values:

yes

Available as of:

0 words

ABB Procontic CS31 07KT92 R202/R262, 07KT93 R171
ABB Procontic T200 07KP62 R202

Additional operating and test functions

Read data sets from Flash EPROM

Command:

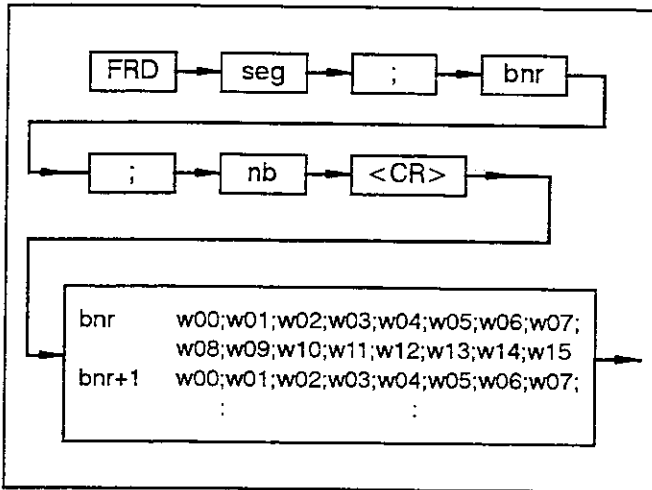

seg: Number of the data segment in the Flash EPROM,
valid values: 0...3

bnr: Number of the block in the data segment
valid values: 0...480

nb: Number of blocks,
valid values: 1...481

:: The different values of the command have to be separated by semicolons.

bnr: Number of the block in the data segment

w00: 1st word value of the block

: : :

w15: 16th word value of the block

:: The different values of the answer are separated by semicolons.

Function:

The user has the opportunity to read data sets from the Flash EPROM. The data are organized block by block (16 words) in the Flash EPROM. The data of each block are secured by a checksum. If a checksum error is detected while reading a block, "ERROR" is output instead of the number of the block (bnr). The checksum error is entered as an FK3 error (error number: 131 (83_H), de-

tailed info: offset, segment) into the corresponding data field.

When the power supply is switched on, a checksum test is carried out over the entire Flash EPROM. If a checksum error is detected then, the FK3 error with the error number 131 is displayed on the screen and entered into the corresponding error flags.

Remark:

When a PLC program is started, the FK3 error flag (binary flag M 255,13) is always deleted. The detailed information (error number, detail info) are still in the word flag data field (MW 255,00...MW 255,07).

Write data sets to the Flash EPROM

Command:

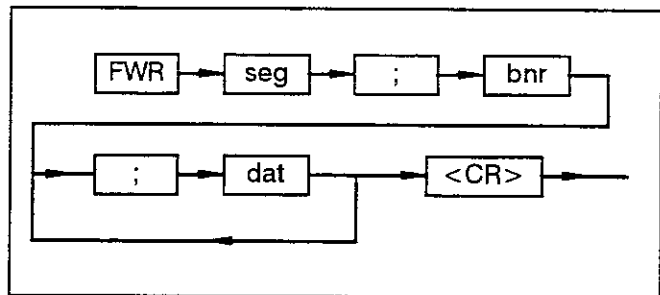

seg: Number of the data segment in the Flash EPROM,
valid values: 0...3

bnr: Number of the block in the data segment
valid values: 0...480

:: The different values of the command have to be separated by semicolons.

dat: new value

:: The different values are separated by semicolons.

Function:

The user has the opportunity to write data sets to the Flash EPROM. The data must be entered as decimal numbers (-32768...+32767). The data are always stored in the Flash EPROM block by block and secured by a checksum. Each block can store 16 words. If less than 16 words are entered, the remaining words are filled with zeros. After 8 word values have been entered, one <CR> <LF> followed by 2 blanks are sent to the screen.

Delete data segment in the Flash EPROM

Command:

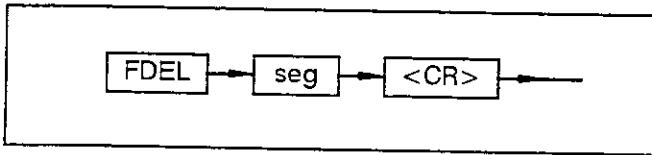

seg: Number of the data segment in the Flash EPROM,
valid values: 0...3

Function:

The user has the opportunity to delete a data segment in the Flash EPROM. With the deletion procedure all data in the data segment are lost.

Double user program memory

Command:

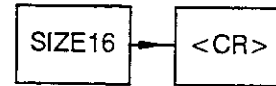

Function:

The user program memory is doubled (to 15296 instructions). After entering of this command, the option "Program changes at a running PLC program" is no longer available.

The command can only be entered under the following preconditions:

- no error of error class 2 present **and**
- PLC program in "ABORTED" status **and**
- invalid user program (DEEP command) in the Flash EPROM

After using this command, the SP command (save user program in Flash EPROM) has to be carried out. In this way, the program duplication is safe in case of power off.

If the SP command is not carried out, the program memory duplication will be no longer in effect after power off/on, warm start or cold start.

The duplication of the program memory can be cancelled in the following way:

- Carry out DEEP command **and**
- Power off/on, WARM command or KALT command (cold start)

12.5 Communication Processor RCOM 07 KP 64 R101

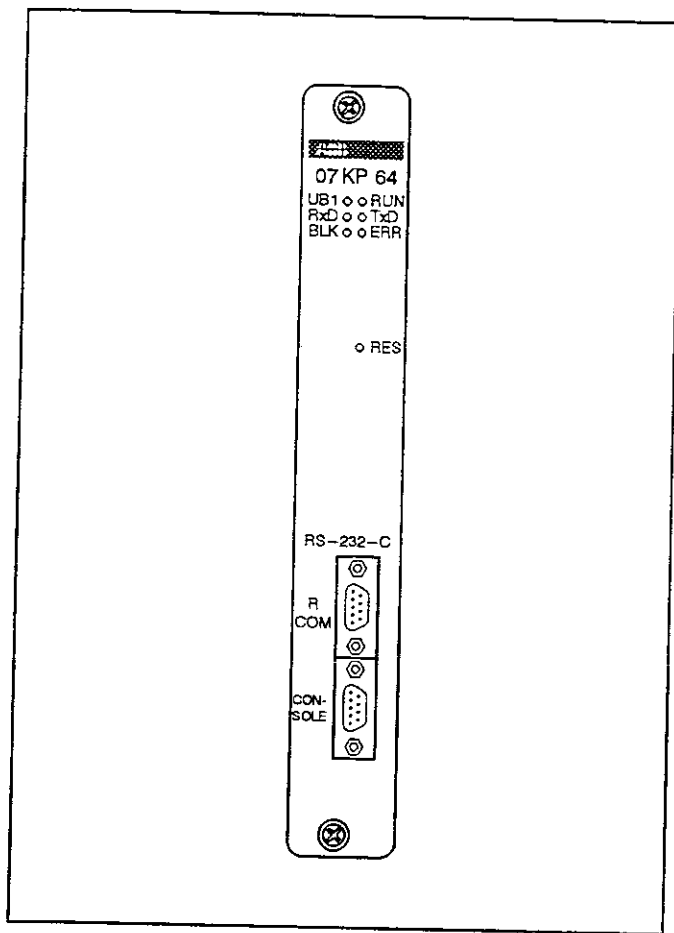

Fig. 12.5.1: Communication processor RCOM 07 KP 64 R101

General Information

The 07 KP 64 communication processor is intended for communication with the RCOM protocol. Using the RCOM protocol, data exchange can take place

- between ABB MasterPiece 200 control systems and ABB Procontic T200 systems or
- between several ABB Procontic T200 systems (see also Fig. 12.5.4).

The special feature of RCOM (Remote Communication) is the communication over long distances.

The communication can be established over

- leased or own lines
- already existing cables
- public telephone lines (dial lines)

Dependent on the chosen way of transmission, the appropriate modem can be selected from a collection of different devices (e.g., current-loop converters, dial-up modems, multidrop modems).

Each RCOM network consists of one master and one or more RCOM slaves. Data can be exchanged in the following three ways:

- Master sends data to a slave
- Master reads data from a slave
- Event-driven transmission: a slave can take time-stamped process events into an event queue. The contents of this queue can be polled by the master.

Characteristics

- The communication processor can be used as RCOM master or as RCOM slave.
- Up to 254 RCOM slaves can be configured in one network (max. 8 slaves in connection with MasterPiece 200, max. 20 slaves in dialling mode).
- The RCOM protocol is compatible with MP200/1 with DSCA 180A. All RCOM services are available (cold start, warm start, clock synchronization, normalize user part, read dataset, write dataset, event poll).
- The RCOM interface for connecting the modem has the specifications of EIA RS-232.
- The EIA RS-232 specified CONSOLE interface is employed as an additional operator interface (for assistance during commissioning, displaying the communication flow, entering of telephone numbers etc.).
- The time data of the built-in software clock can be used for the PLC program.

Module Description

The communication processor has a metal housing with a front panel including the display elements, the two 9-pole D-plugs (female) for the RCOM interface and the CONSOLE interface, and the reset pushbutton (RES).

6 LEDs on the front panel display operating and error conditions (see Fig. 12.5.2).

Planning

The 07 KP 64 communication processor RCOM can only be placed in basic subracks of the ABB Procontic T200. Dependent on the configuration, up to 4 communication processors can be mounted in one basic subrack (sum of modules 07 KP 6x).

In the configuration menu of the 907 PC 332 programming software, "KP6X" has to be entered into the "Config.-PLC" menu point "System Configuration".

The configuration of the communication flow is carried out with connection elements. These are contained in the 907 KP 64 documentation and software package (see also Ordering data). Furthermore, the package includes the operating manual for the 07 KP 64 and several examples for configurations.

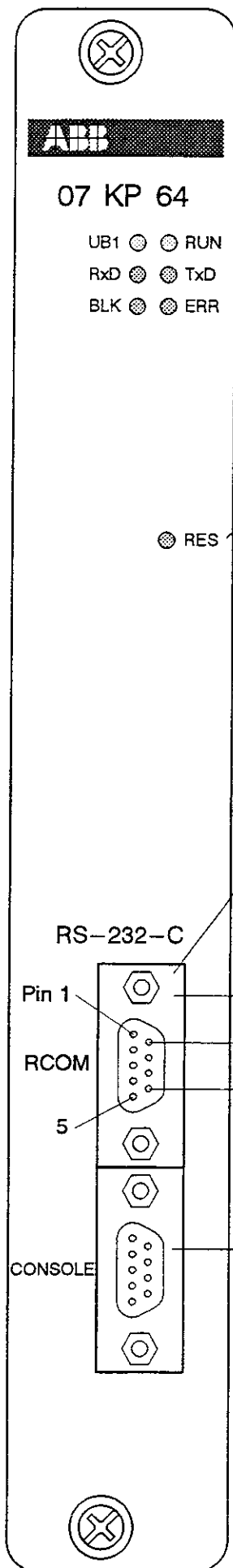

UB1 Power-ON display

The green LED lights up, when the internal voltage (5V) is ON.

RUN Operation display

The green LED lights up, when the communication processor is ready for communication.

RxD Communication processor receives a telegram, red LED

TxD Communication processor sends a telegram, red LED

BLK Blocked, red LED, a normalization is required

ERR Error

The red LED lights up, when an error has occurred.

RESET pushbutton, manual reset of the 07 KP 64.

RCOM interface, EIA RS-232, 9-pole D-plug, female

Pin	Signal name	Meaning	Remarks
G	PGND	Shield (Protective Ground)	Plug case
1	PGND	Shield (Protective Ground)	
2	TxD	Transmit Data	Output
3	RxD	Receive Data	Input
4	RTS	Request To Send	Output
5	CTS	Clear To Send	Input
7	SGND	Signal Ground	
6	PROG	Not connected	0 V for UB1 UB1
8	0 V	0 V for UB1	
9	+5 V	Internal voltage UB1	

Note: The pins 6, 8 and 9 may under **no** circumstances be used, since they are electrically **not isolated**.

CONSOLE interface, EIA RS-232, 9-pole D-plug, female

Pin	Signal name	Meaning	Remarks
G	PGND	Shield (Protective Ground)	Plug case
1	PGND	Shield (Protective Ground)	
2	TxD	Transmit Data	Output
3	RxD	Receive Data	Input
4	RTS	Request To Send	Output
5	CTS	Clear To Send	Input
7	SGND	Signal Ground	
6	PROG	Not connected	0 V for UB1 UB1
8	0 V	0 V for UB1	
9	+5 V	Internal voltage UB1	

Note: The pins 6, 8 and 9 may under **no** circumstances be used, since they are electrically **not isolated**.

Fig. 12.5.2: Communication processor RCOM 07 KP 64 R101 with description of the display and operating elements as well as the interfaces

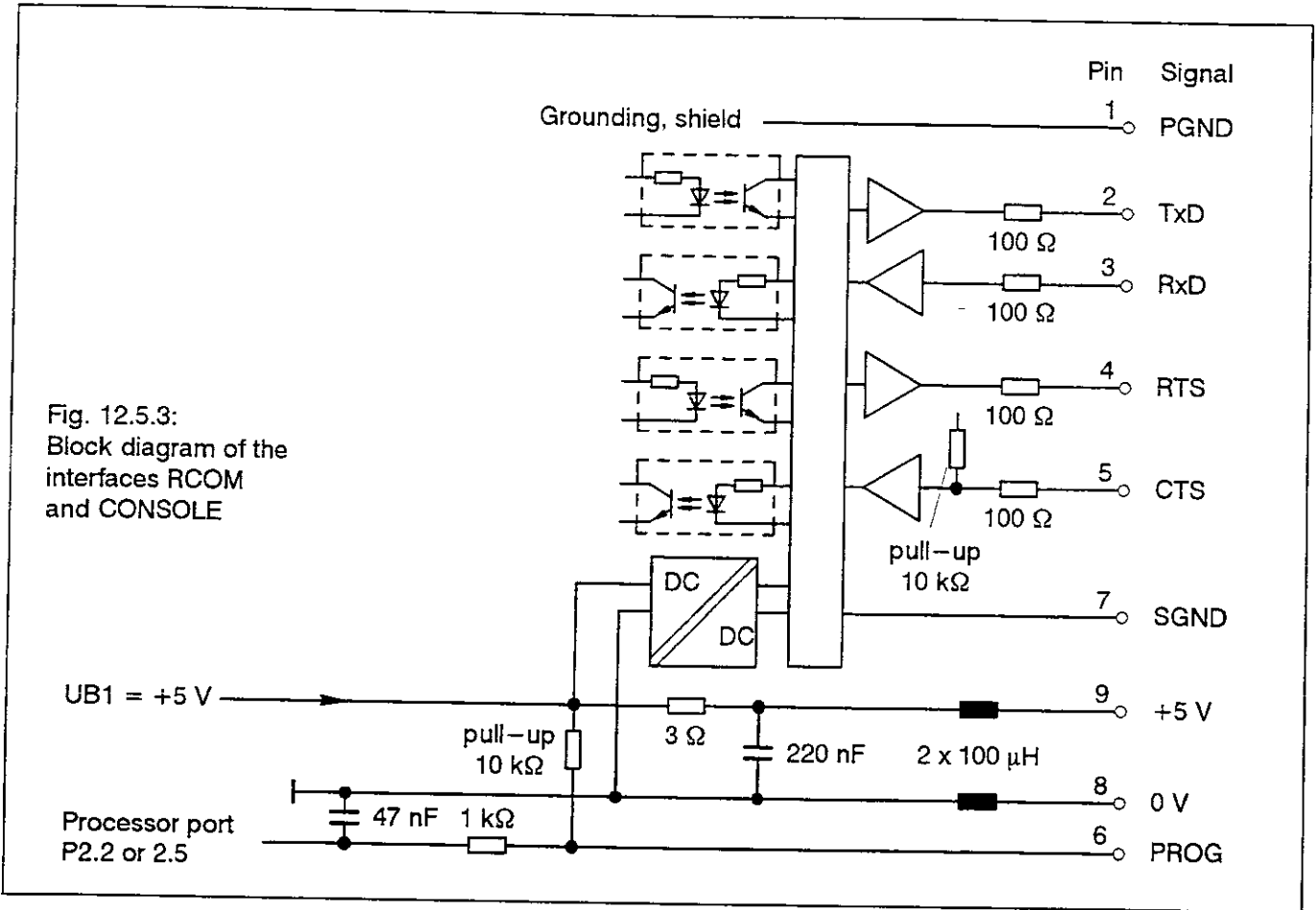

Fig. 12.5.3:
Block diagram of the
interfaces RCOM
and CONSOLE

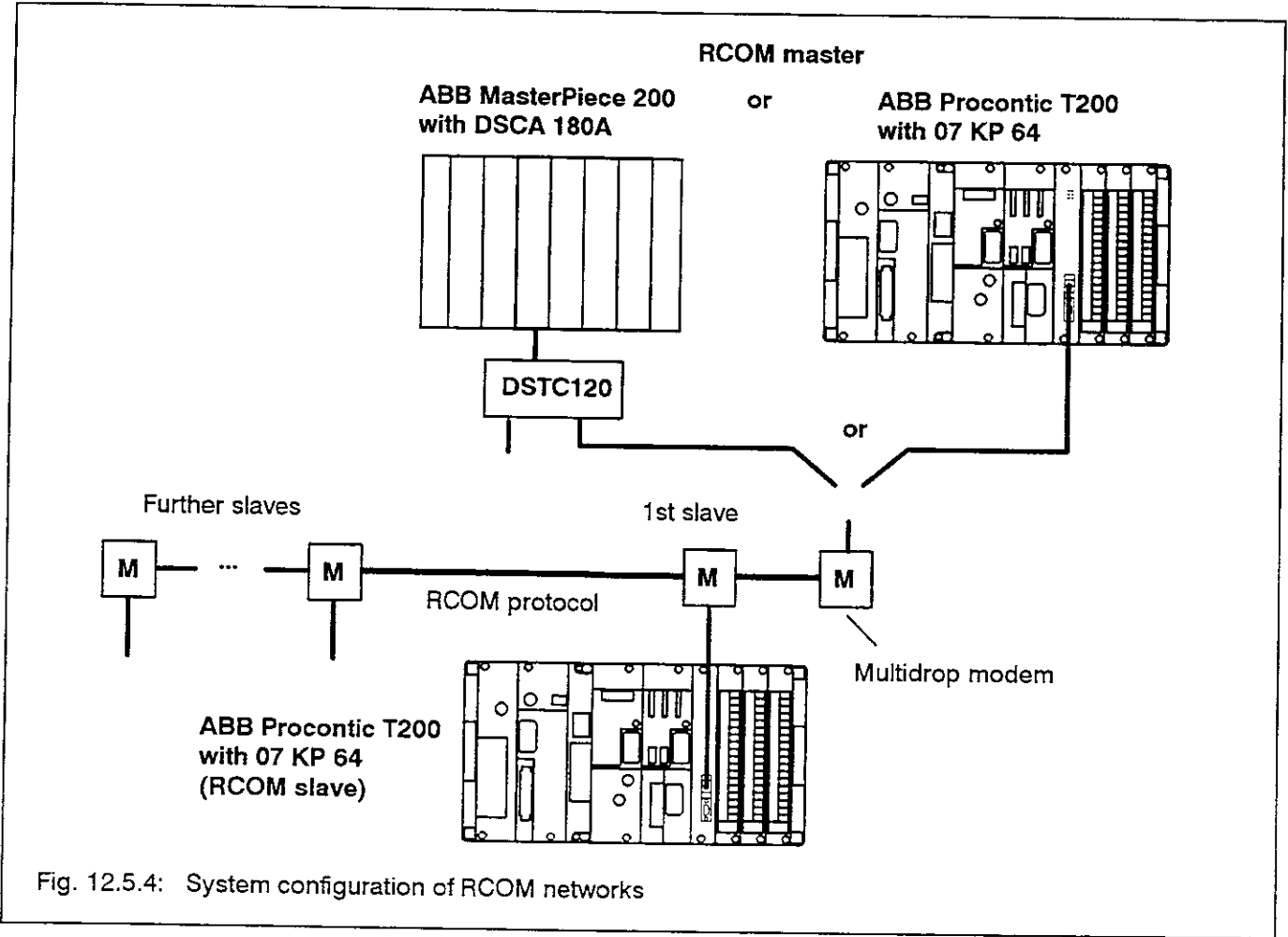
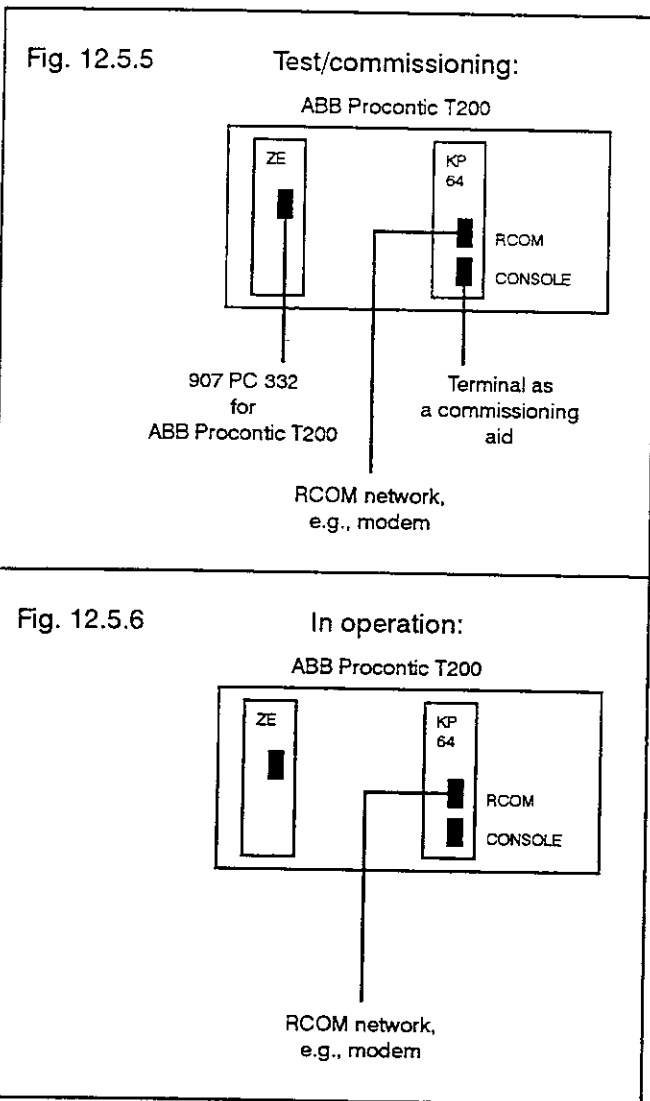

Fig. 12.5.4: System configuration of RCOM networks

Handling Examples



Serial Interfaces

RCOM and CONSOLE

Pin configuration of the interfaces RCOM and CONSOLE see Fig. 12.5.2.

Serial interface RCOM

The RCOM network is connected to this interface. The connection is lead over a modem (e.g. LGH 9600 H1).

Serial interface CONSOLE

For commissioning, an external terminal can be connected to this CONSOLE interface (e.g., 907 PC 332 in terminal mode). The interface is used in order to

- configure the telephone directory or other configuration data (only with dial-up modems),
- monitor the flow of communication (trouble shooting during the commissioning). After successful commissioning this function can be switched off.

The operating manual (see Ordering data, 907 KP 64) contains a detailed description of the interface mentioned above.

Meanings of the LEDs

The LEDs located on the front panel of the communication processor have the following meanings:

- UB1** The green power-ON LED lights up, when the internal voltage $UB1 = 5V$ is within its given tolerance band and no reset is active (reset pushbutton or T200 reset).
- RUN** The green LED lights up, when the 07 KP 64 communication processor is ready for communication with the RCOM protocol. It goes out on a new initialization.
- RxD** The red RxD LED lights up, when the 07 KP 64 is ready for communication and receiving a telegram.
- TxD** The red RxD LED lights up, when the 07 KP 64 sends data via the serial interface.
- BLK** The red BLK LED lights up, when the transmission of user data is not possible, because the communication flow does not work correctly. After normalization the LED turns off again.
- ERR** The red ERR LED lights up, when an error occurs during the communication. If the error is removable, the LED will turn off after a short time. In case of fatal errors the LED remains on.

Error table (T200 central unit and 07 KP 64)

Error No. of the T200 central unit	LED displays on the 07 KP 64						System flags	Causes
	UB1	RUN	RxD	TxD	BLK	ERR		
41	1	0	x	x	x	1	MW4096,02 (contains the slot No.)	– System configuration is faulty (07 KP 64 is inserted into the wrong slot or missing)
00	1	0	x	x	x	1		– Error detected during the self-test of the communication processor (checksum error, RAM error, initialization error)
51	1	0	x	x	x	x	MW4104,02 (bit 9) MW4096,06	– Error in the communication processor
53	1	0	x	x	x	x	MW4104,03	– System configuration is faulty (07 KP 64 is inserted into the wrong slot or missing)
54	1	0	x	x	x	x	MW4104,03 MW4104,04	– Hardware fault in the communication processor

0 = LED off, 1 = LED on, x = LED on or off

Fig. 12.5.7: Error table (T200 central unit and 07 KP 64)

Reaction on Switching-over to STOP or on Power OFF

If the central unit of the ABB Procontic T200 is switched over to STOP, the communication via RCOM is also stopped. In this case, the RUN LED turns off.

If the power supply of the T200 system is switched off, the data transmission over both serial interfaces (RCOM and CONSOLE) will break down.

Reset Pushbutton

After occurrence of fatal errors the communication processor has to be reset. This is carried out manual with the reset pushbutton.

Important:

After pressing the reset pushbutton the PLC program has to be stopped and started again. Thus, the PLC program and the communication processor are newly synchronized.

Technical Data

07 KP 64 R101

General data

Max. number of 07 KP 64 in one subrack or sum of modules of 07 KP 6x	4
Number of serial interfaces	2, see Fig. 12.5.2
Indication of errors and operating conditions	6 LEDs, see Fig. 12.5.2
Number of required slots	1 I/O slot
Number of occupied I/O points	4 input and 4 output words (= 128 I/O points)
Configuration identifier in 907 PC 32 (T200)	KP6X
Ability of fitting in subracks	
slot,	
● = plug-in is possible (occupies 1 slot)	
Current consumption from internal voltages	
UB1 = 5 V DC ± 5 %	max. 0.5 A
UB4 = 24 V DC	no current consumption
Total power dissipation	max. 2.5 W
Weight	ca. 900 g

BT			BE central			BE remote		
NG	ZE	I/O	NG	BV	I/O	NG	BV	I/O
		●						

Serial interface RCOM

Interface standard	EIA RS-232
Electrical isolation	yes, see also Fig. 12.5.3
Interface connector	9 pole D-plug, female, see Fig. 12.5.2
Transmission speed (Baud rate)	300...9600 Baud
Character length	8 bits
Parity	even, odd, no
Number of start bits	1
Number of stop bits	1
Handshake method	RTS/CTS (hardware handshake)

Serial interface CONSOLE

Interface standard	EIA RS-232
Electrical isolation	yes, see also Fig. 12.5.3
Interface connector	9 pole D-plug, female, see Fig. 12.5.2
Transmission speed (Baud rate)	9600 Baud
Character length	8 bits
Parity	no
Number of start bits	1
Number of stop bits	1
Handshake method	RTS/CTS (hardware handshake)

Ordering information

Communication processor 07 KP 64 R101	Order No. GJR5 2406 00 R101
System cable 07 SK 90 for connection of a terminal	Order No. GJR5 2502 00 R1
System cable 07 SK 92 for connection of modems (e.g., LGH 9600 H1)	Order No. GJR5 2504 00 R1
907 KP 64: documentation, CE library and example programs for 07 KP 64	Order No. GJP5 2050 00 R202

12.8 Text processor 07 KT 60 R101 intelligent serial interface for output of texts (interface for RS-422 or RS-423 (RS-232-C))

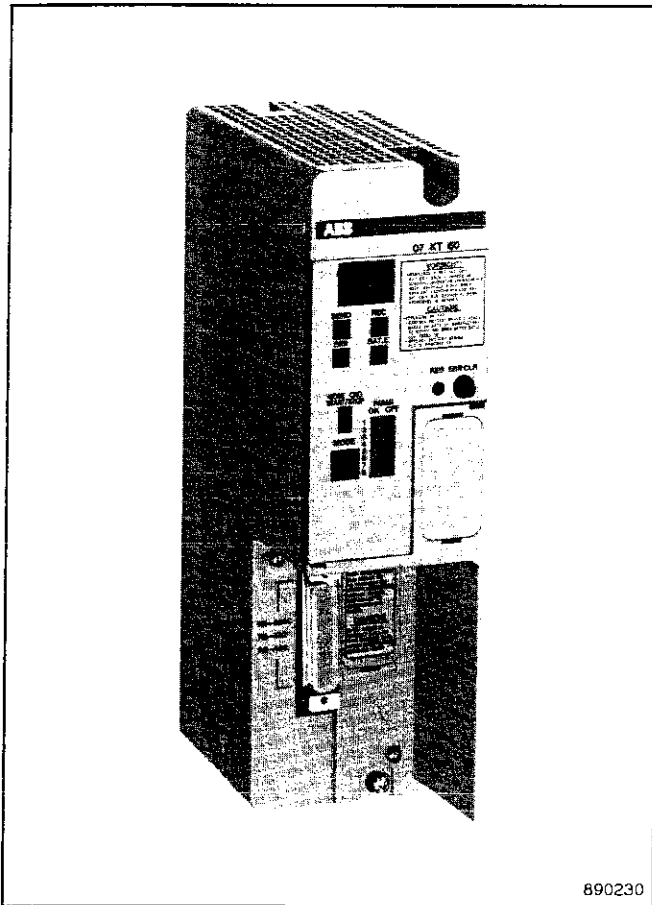

Fig. 12.8.1: Text processor 07 KT 60 R101

Characteristics

The text processor 07 KT 60 R101 enables the connection of ABB Procontic T200 controllers to external visual display units or printers.

Selectable RS-423 (RS-232-C) or RS-422 serial interfaces are available. The interface is electrically isolated from internal voltages.

The 07 KT 60 R101 module has a housing with a removable, transparent front cover for the display and operating elements and a screw-on connector block with the interface.

It occupies two I/O slots and can be used in basic subracks and in expansion subracks, however not in remote expansion configuration (remote I/O). It is possible to use several modules in one system.

Light-emitting diodes are provided for signalling operational conditions. Several pushbuttons and switches are provided for operating the module, for setting operating mode and interface parameters (see Fig. 12.8.3).

Example of a configuration with 07 KT 60

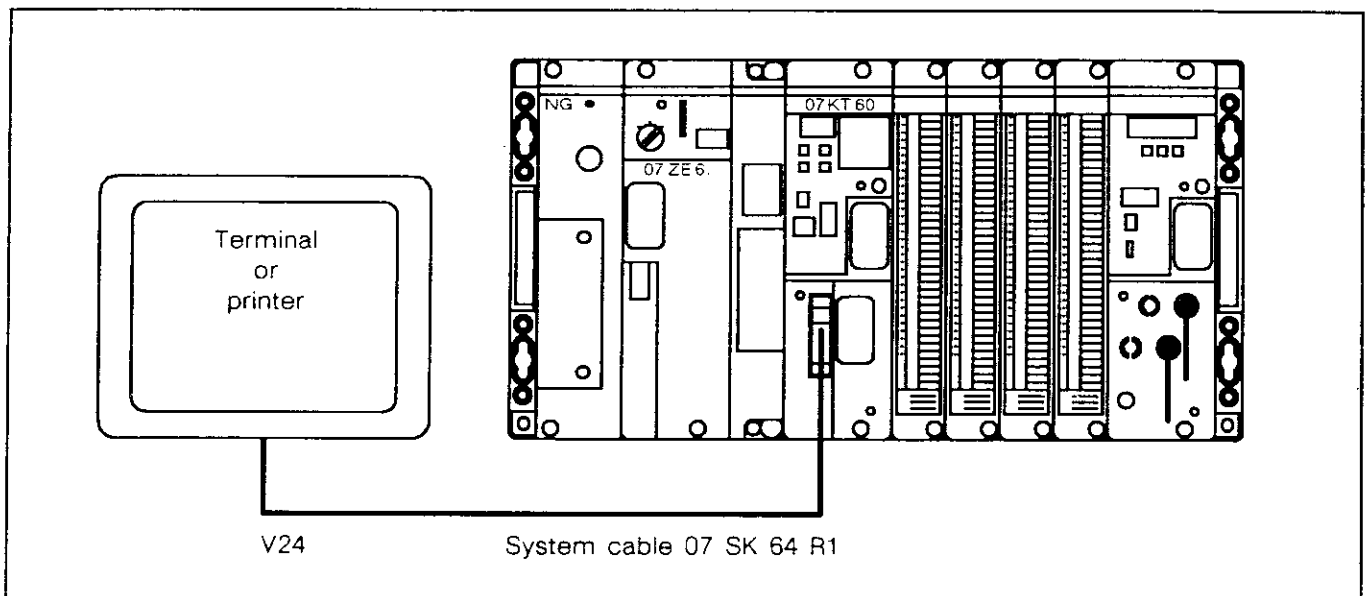
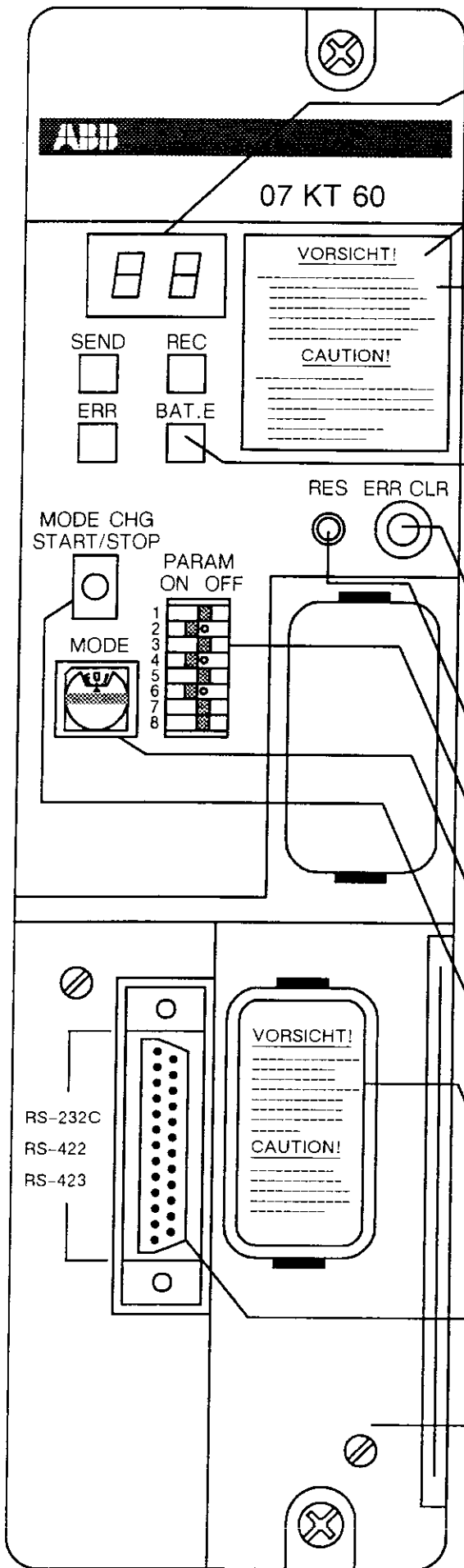

Fig. 12.8.2: Example of an application using text processor 07 KT 60 R101



Two-digit 7-segment display

- for displaying operational condition
 - for displaying errors
 For the codes displayed, see Table 12.8.1.

Lithium battery for RAM backup

The battery is located behind the front cover at this place. For battery change, see Fig. 12.8.4.

CAUTION!

- REPLACING BATTERY
 - REPLACE BATTERY AFTER 2 YEARS BASED ON DATE OF MANUFACTURE OR WITHIN ONE WEEK AFTER "BAT.E" LED TURNS ON.
 - REPLACE BATTERY DURING PLC IS POWERED ON.

LED displays

SEND Data are being sent
 REC Data are being received
 ERR Error, see error number on 7-segment display
 BAT.E Battery fault, battery voltage too low

ERR CLR, button to clear error display

On pressing this button the error display is erased, provided the cause of the error has been eliminated.

RES, reset button

Pressing this button results in a hardware reset.

Switch for setting serial interface parameters

8-bit DIL switch, for settings see Table 12.8.2.

MODE switch

Selection switch for setting the operating mode of the text processor, for settings see Table 12.8.3.

Initialize (momentary) button for operating mode setting

When this button is pressed, the operating mode setting becomes effective.

CAUTION!

DO NOT CONNECT OR DISCONNECT CABLE NOR TOUCH CONNECTOR FIXING SCREWS DURING POWER ON. ERRORS MAY OCCUR!

RS-422/RS-423 (RS-232-C) interface socket

Serial interface (25-pole, female)
 For connections, see Tables 12.8.4 and 12.8.5 and Fig. 12.8.5.

Connector block

Screw-on connector block with RS-422 and RS-423 (RS-232-C) interface

Fig. 12.8.3: 07 KT 60 R101 module with description of display and operating elements and interfaces

Table 12.8.1: Significance of the codes on the 7-segment display

Display	Operational condition
00	RUN mode
10	EDIT mode
20	Programming unit mode, transmission of texts to 07 KT 60
6	Initialization
Display	Error
01	Communication between central unit and 07 KT 60 faulty, e.g. faulty PLC program
02, 12, 22	Communication between 07 KT 60 and programming unit or terminal faulty; parity, framing, overrun or format error
03, 13, 23	Timeout error between 07 KT 60 and programming unit or terminal mode
24	Protocol error in communication (data backup) between 07 KT 60 and programming unit
05	Transfer of data from PLC to 07 KT 60 (command 0-299) without previous definition of variable number
06	Command buffer overflow
07	Unknown command in PLC program for 07 KT 60
88	Hardware fault; ROM or RAM error

Table 12.8.2: Significance of parameter switch settings for serial interface RS-422 and RS-423 (RS-232-C)

Switch No.	Switch OFF	Switch ON	Significance
1	RS-423 (RS-232-C)	RS-422	
5	7 bits	8 bits	Number of data bits
6	odd 2	even 1	parity (parity bit only with 7 data bits) number of stop bits (2 only with 8 data bits)
7	reserved		
8	-	test operation of the serial interface by means of the shorting plug supplied	

Replacement of the RAM backup battery

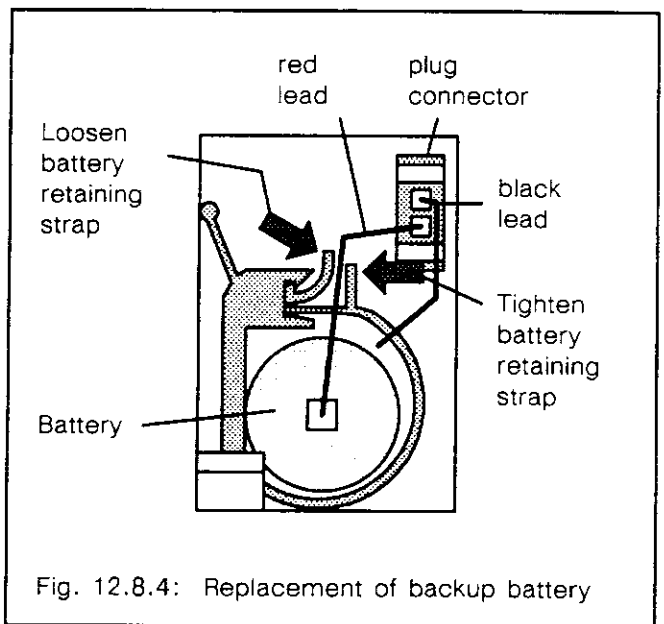

Fig. 12.8.4: Replacement of backup battery

The lithium battery for RAM backup should be replaced two years from the date of manufacture or within a week of the LED "BAT.E" lighting up. It is located behind the front cover on the righthand side at the top.

The following procedure should be observed when replacing the battery:

1. Ensure that controller is in operation
2. Remove front cover
3. Remove plug with pliers
4. Loosen battery retaining strap
5. Remove battery
6. Insert new battery, positive terminal with red lead visible
7. Tighten battery retaining strap
8. Connect plug, black lead (negative) upwards
9. Snap on front cover

The transmission speed is set using the switches 2, 3 and 4:

Switch No.	Baud rate					
	300	600	1200	2400	4800	9600
2	OFF	ON	OFF	ON	OFF	ON
3	OFF	OFF	ON	ON	OFF	OFF
4	OFF	OFF	OFF	OFF	ON	ON

The structure of a character in a telegram is as follows:



Table 12.8.3: Significance of MODE switch settings

Setting	Significance
0	RUN
1	EDIT
2	Communication between 07 KT 60 and programming unit
3...5	Do not use!
6	Initialization
7...F	Reserved

Table 12.8.4: Terminal assignment of RS-422 interface

Pin	Signal name	Significance
1	NC	Not Connected
9	RxDP	Receive Data +
10	RxDN	Receive Data -
11	SGND	Signal Ground
12	CTSP	Clear to Send +
13	CTSN	Clear to Send -
18	TxDP	Transmit Data +
19	TxDN	Transmit Data -
21	RTSP	Request to Send +
23	RTSN	Request to Send -

Interface RS-422, RS-423 (RS-232-C)

The interface is electrically isolated from the internal operating voltages.

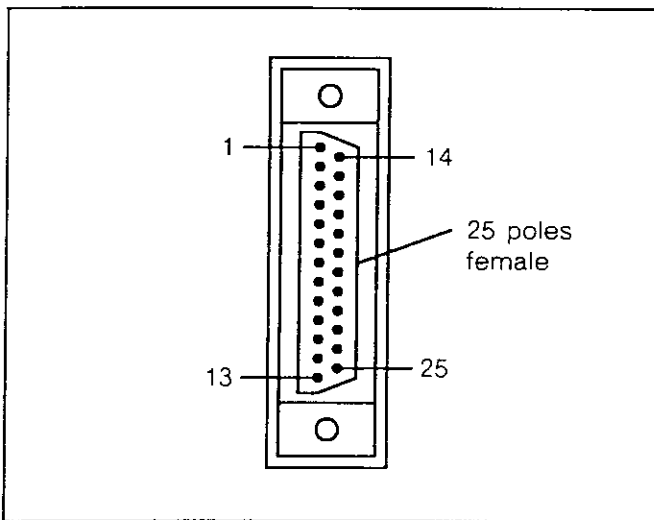

Fig. 12.8.5:
Serial interface RS-422, RS-423 (RS-232-C)

Table 12.8.5: Terminal assignment of RS-423 (RS-232-C) interface

Pin	Signal name	Significance
1	NC	Not Connected
2	TxD	Transmit Data
3	RxD	Receive Data
4	RTS	Request to Send
5	CTS	Clear to Send
7	SGND	Signal Ground

Escape-Sequences (ESC)

The 07 KT 60 transmits the following ESC sequences (VT52):

Backspacing: BS (08 H)

Form Feed: FF (0C H)

Cursor Positioning:

ESC (1B H) + Y (59 H) + l + c

l = line No. (+ 20 H)

c = column No. (+ 20 H)

Example for cursor positioning:

Cursor in line 5, column 11 ----> 1B 59 25 2B

The cursor positioning is done only in EDIT mode or in RUN mode with CRT setting.

Testing the serial interface

To test the serial interface, the subrack must be switched off and the test plug supplied inserted into the interface. Test operation is selected on DIL switch (see Table 12.8.2).

When the voltage supply is switched on, or, with voltage already switched on, when RESET key is pressed, the loop test is started. During the test phase the 7-segment display continually counts from 00 to FF, in accordance with the data transmitted. At the same time, the SEND and REC LEDs light up. If an error occurs, counting and transmission are stopped and the data byte at which the error occurred is displayed. After about 4 seconds the following display appears.

L 1 in case of error on RS-423 (RS-232-C) or
L 2 in case of error on RS-422

When initialize button (MODE CHG, START/STOP) is pressed display changes after about 4 seconds from L1 to L2 or vice versa if both operating modes are defective. This process can be repeated with each subsequent actuation.

Technical Data

07 KT 60 R101

Max. number of modules per subrack		limited only by number of I/O slots
Interfaces		RS-422, RS-423 (RS-232-C) (electrically isolated from internal logic voltage)
Interface connector		25-pole SUB-D plug, female
Selectable transmission speeds		300, 600, 1200, 2400, 4800 or 9600 bit/s
Transmission mode		halfduplex with serial transmission in ASCII, RTS/CTS operation
Number of data bits		selectable 7 or 8 bits
Parity		selectable even or odd
Stop bit		selectable 1 or 2 bits
Possible settings		1 start bit + 8 data bits + no parity + 1 stop bit 1 start bit + 8 data bits + no parity + 2 stop bits 1 start bit + 7 data bits + even parity + 1 stop bit 1 start bit + 7 data bits + odd parity + 1 stop bit
Self-diagnosis		vertical parity check (even/odd), overflow check, framing check
Interface cables	System cable 07 SK 64 R1	to connect the programming unit to the text processor
	System cable 07 SK 67 R1	to connect the printer to the text processor
	System cable 07 SK 68 R1	to connect the operator station 35 BS 40 to the text processor
Indication		4 LEDs, 7-segment display
Capacity of text memory		24 Kbyte
Current consumption from internal voltages		max. 1.0 A
UB1 = 5 V DC		no current consumption
UB4 = 24 V DC		max. 5 W
Total power dissipation		2 I/O slots
Number of required slots		4 input and 4 output words
Number of occupied I/O points		EAW4 (entered for right slot No.)
Configuration identifier in 907 PC 32		
Ability of fitting in subracks		
Slot,		
●-● = plug-in is possible (occupies 2 slots)		
Weight		800 g
Order number	07 KT 60 R101	GJV3074381R101
Accessories: supplied:	shorting plug for test of the serial interface	
Accessories: not supplied:	Interface cable 07 SK 64 R1	GJV3073909R1
	Order number	GJV3073912R1
	Interface cable 07 SK 67 R1	GJV3073913R1
	Order number	
	Interface cable 07 SK 68 R1	
	Order number	
	Software + documentation:	
	Additional library 907 PB 362	GJP5202000R0302
	Functional description 07 KT 60	GATS131406R2001

BT			BE-central			BE-remote		
NG	ZE	I/O	NG	BV	I/O	NG	BV	I/O
		●-●			●-●			

13 Preprocessors

07 IR 60 R101: Industrial computer Basic
07 PO 60 R201: One-axis positioning unit
07 UD 60 R1: Programmable real-time clock

13.1 Industrial Computer Basic 07 IR 60 R101

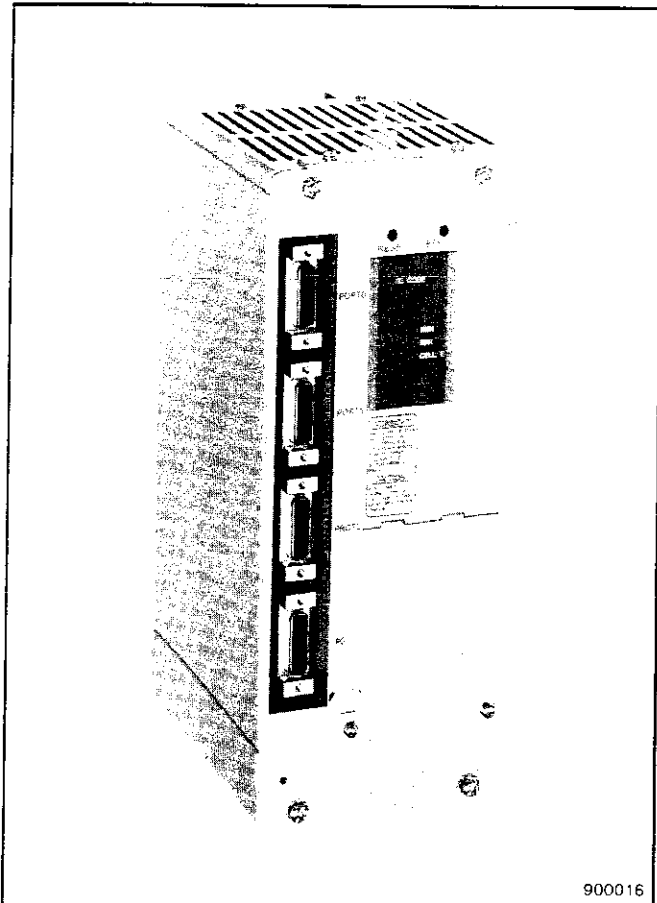

Fig. 13.1.1: Industrial Computer Basic
07 IR 60 R101

General information

The Industrial Computer Basic for the programmable control system ABB Procontic T200 is an independent unit programmed in BASIC which is capable of performing calculations and communication tasks independently of the central unit. For this purpose, a powerful real-time BASIC interpreter and three freely available serial interfaces are integrated.

The BASIC interpreter is capable of managing up to 17 user tasks (user programs) and up to 115 kbytes of user memory.

The Industrial Computer 07 IR 60 requires three slots in a subrack. It can be placed once in each basic subrack. It is not possible to use it in expansion subracks.

Light-emitting diodes and 7-segment displays are provided for signalling operational and error conditions. Resets for the unit and the error codes can be entered by pushbuttons.

Features:

- Easy to program due to a powerful command assortment
- Short reaction times due to multitasking
- Direct access to all flags of the central unit
- Powerful and simple PLC connection elements for starting BASIC tasks and for synchronizing data exchange
- Easy-to-handle programming software for the IBM PC

Programming

The unit is programmed on a PC using the BASIC programming software 907 IR 60 R102. (For order number of complete software folder see 'Technical Data, Accessories'.) This software can be used to create, transfer and test programs. Programs can be stored on hard disk or floppy disk for archiving purposes.

There are three connection elements in the PLC for communication with the Industrial Computer:

- IR_START for starting a BASIC task
- IR_BEL and IR_FREI for synchronizing the data transfer in the PLC flag areas.

Battery backup for RAM contents

Data backup for internal RAMs is carried out by a lithium battery. The battery is accessible after removing the cover of the battery compartment (see Fig. 13.1.2). In order to avoid data losses during battery replacement the latter can only be replaced when the unit is powered on. The replacement should be finished after 5 minutes.

The LED 'CELL.E' lights when battery voltage has become too low or battery failed otherwise (see Fig. 13.1.2). The battery must be regularly replaced every 2 years even if an indication of the LED has not yet appeared.

For order number of spare battery see 'Technical Data, Accessories'.

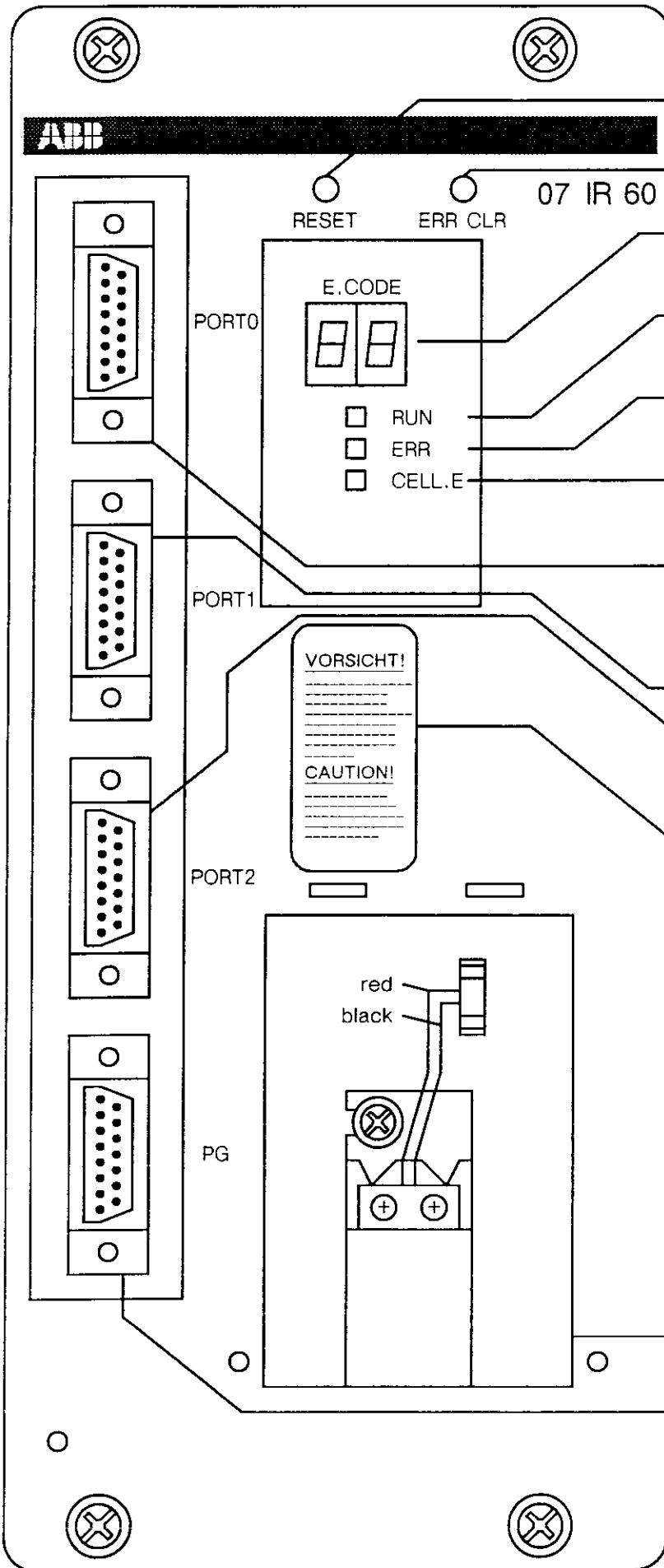

- RESET button**
Resets the industrial computer
- ERR CLR (Error Clear button)**
Erases the error number
- 7-segment display**
Displays the error code
- RUN display**
illuminates during operation of the T200 central unit (07 ZE 60...63)
- ERR (Error display)**
illuminates when there is an error in the CPU of the industrial computer
- CELL.E (Battery display)**
illuminates when battery fails or voltage is too low
- Serial Interface No. 0**
is allocated to task 2,
Sub-D plug, 15 pole female
- Serial Interface No. 1**
is allocated to task 4,
Sub-D plug, 15 pole female
- Serial Interface No. 2**
is allocated to task 5,
Sub-D plug, 15 pole female

Notes to the serial interfaces:

VORSICHT!
KABEL WEDER EINSTECKEN NOCH ABZIEHEN UND HALTESCHRAUBEN DES STECKERS NICHT BERÜHREN, WENN DIE SPANNUNG EINGESCHALTET IST. BETRIEBSSTÖRUNGEN MÖGLICH.

CAUTION!
DO NOT CONNECT OR DISCONNECT CABLE NOR TOUCH CONNECTOR FIXING SCREWS DURING POWER ON. ERRORS MAY OCCUR!

- Battery Compartment**
shown when opened
- Interface for Programming Unit**
Sub-D plug, 15 pole female

Fig. 13.1.2: Industrial Computer 07 IR 60 R101 with description of display and operating elements as well as the interfaces

Technical Data

Max. number of 07 IR 60 units per basic subrack
 Interfaces for programming units
 Indication
 Current consumption from internal voltages
 UB1 = 5 V DC
 UB4 = 24 V DC
 Total power dissipation
 Number of required slots
 Serial interfaces
 Quantity
 freely available
 for connection of programming unit
 Transmission speeds

 Character length
 Data security means
 data transfer format

 error check
 Electrical isolation
 Control commands

 BASIC commands

 Functions

 Data types

 String of characters
 Integers
 Real (decimal number)
 Internal memories
 User program memory
 Symbol memory
 Access to PLC variables (read/write) 1)
 Bit flags
 Bit flags of the bit/word area
 Word flags
 Word flags of the bit/word area
 Special word flag area
 Coupler, bit area
 Coupler, word area
 Error detection
 Hardware
 Software
 Replacement of the lithium backup battery
 Configuration identifier in 907 PC 32
 Ability of fitting in subracks

 Slot,
 ●-●-● = plug-in is possible (occupies 3 slots)
 Weight
 Order number 07 IR 60 R101

07 IR 60 R101

1
 1 for PC with software 907 IR 60
 LEDs, 7-segment display (see Fig. 13.1.2)

 max. 1.5 A
 no current consumption
 max. 7.5 W
 3 slots in the basic subrack
 RS-232-C
 4 in total
 3 (PORT0...PORT2)
 1 (fixed to 4800 baud)
 300, 600, 1200 or 4800 bit/s (9600 baud only
 for sending)
 7 or 8 bits

 7 bits + even parity or
 8 bits without parity
 overrun error, framing error, timeout error
 no
 PRINT, INPUT, START, STOP, TASK,
 37 different in total
 AUTO, RUN, LIST, CHECK, RENUM,
 11 different in total
 SIN, COS, BCD, BIN, SQR, EXP, LEN,
 36 different in total
 constants, variables and
 arrays (up to 2 dimensions)
 0 to 255 characters
 decimal and hexadecimal
 fixed point and floating point

 64 kbyte
 51 kbyte

M	000,00	to	M	127,15
M'	000,00	to	M'	383,31
MW	000,00	to	MW	3135,15
MW'	000,00	to	MW'	383,01
MW	4096,00	to	MW	4197,15
E'/A'	000,00	to	E'/A'	2047,15
EW'/AW'	000,00	to	EW'/AW'	2047,00

 watchdog, parity for RAM memory, battery monit.
 program summation check, RAM check
 every 2 years or when LED "CELL.E" lights up
 IR60 (to be entered on the right slot number)

BT			BE-central			BE-remote		
NG	ZE	I/O	NG	BV	I/O	NG	BV	I/O
		●-●-●						

 approx. 2 kg
 GJV3074385R101

1) 1 word occupies 16 bits

Accessories:

BASIC programming software
(IR BASIC) 907 IR 60 R102 and
Connection Element Library Expansion for the pro-
gramming software 907 PC 32 with the Connection
Elements IR_START, IR_FREI, IR_BEL

Order number (German) GJP5202800R102 D
Order number (English) GJP5202500R102 E

Interface cable 07 SK 63 R1 for connection be-
tween PC with BASIC programming software 907 IR 60
and the Industrial Computer 07 IR 60

Order number GJV3073908R1

Spare battery

Order number GJV3074399R1

Serial Interface Cable 07 SK 63 R1

Intended Purpose

The cable is used for serial data transmission
(RS-232-C/V24) between the programming unit and

the Industrial Computer Basic 07 IR 60.

By means of screws, the plugs are mounted to both
interfaces.

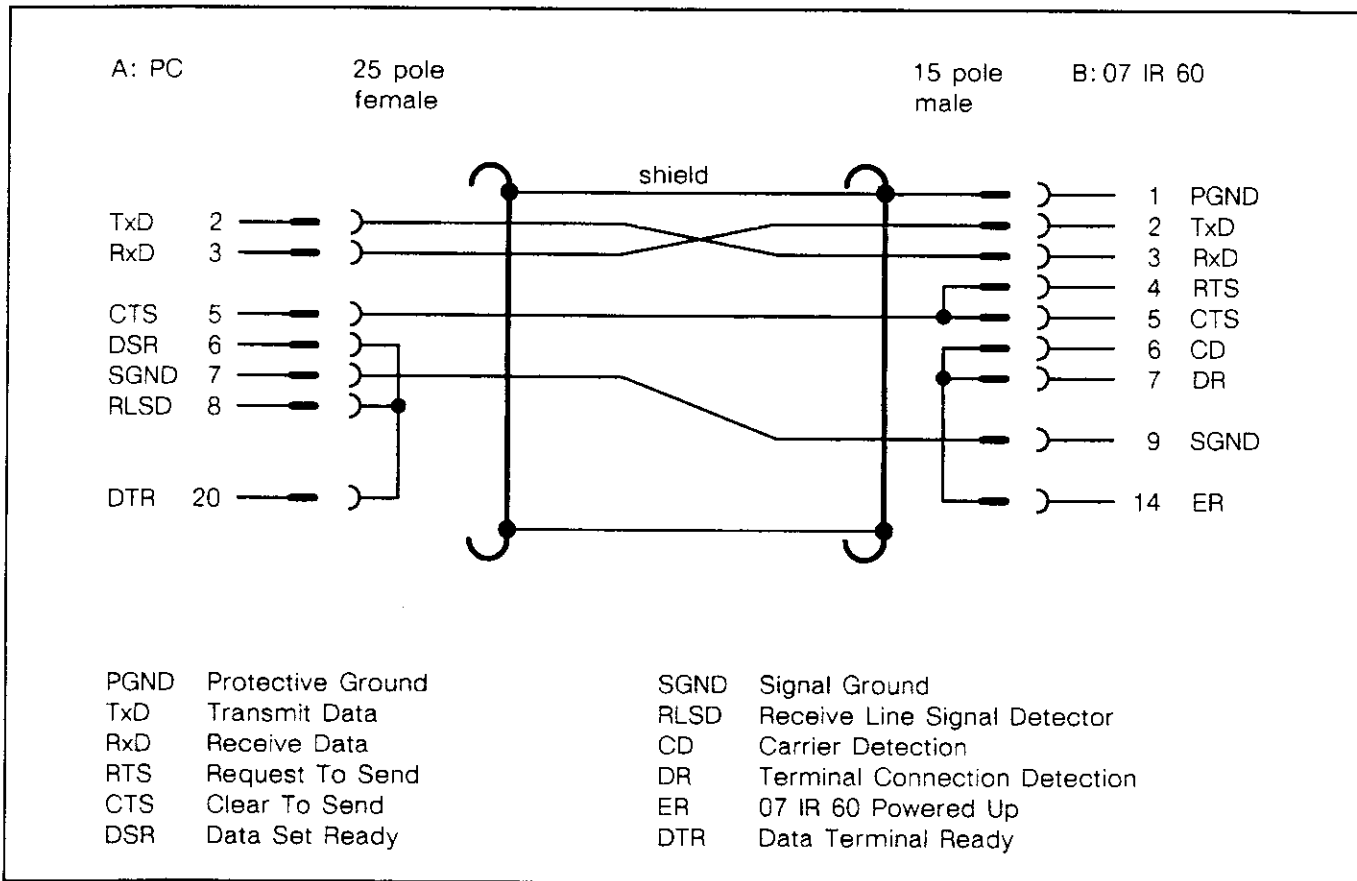

Fig. 13.1.3: Terminal assignment 07 SK 63 R1

Technical Data

Connections from A: 07 PC 32 / 07 PH 32 SW-Basic-Tool to B: 07 IR 60

Cable length 3 m

Weight approx. 550 g

Order number GJV3073908R1

Freely configurable user interfaces (PORT0, PORT1, PORT2)

The 3 interfaces with their data and connections to the peripheral units are described in the following.

Features:

- serial interface in accordance with RS-232-C
- no electrical isolation
- start/stop system
- transmission method half-duplex

- transmission speed settable from the PC to: 300, 600, 1200, 2400, 4800 and 9600 bits/s (9600 bits/s in send mode only)
- data format settable from the PC:
 - JIS7 7 data bits, even parity
 - JIS8 8 data bits, no parity

Connection between the 07 IR 60 and peripheral units

To connect host computers or terminals the interface cable 07 SK 63 can be used (see previous page).

To connect a printer to the interfaces PORT0...PORT2 a cable with the following circuit diagram is suitable.

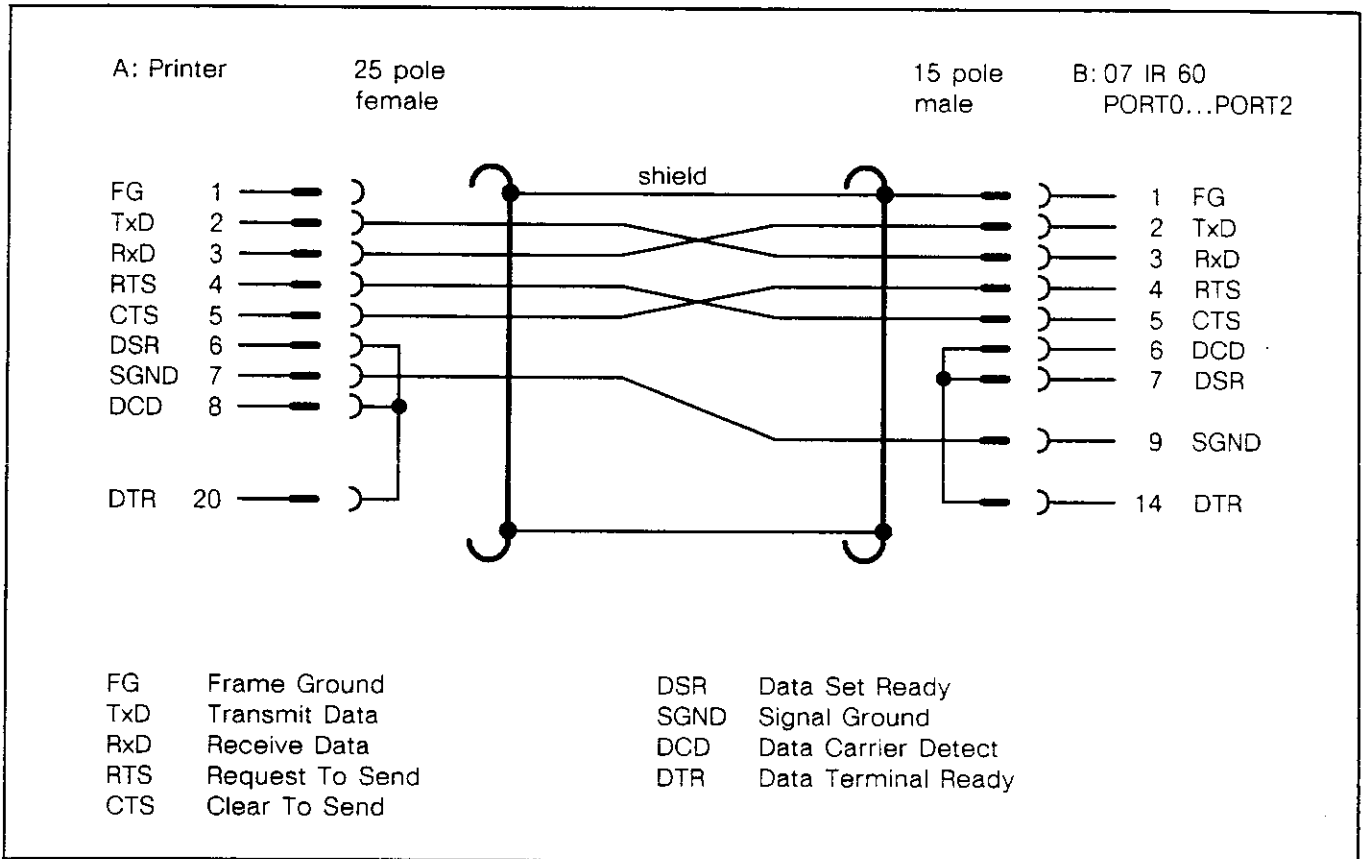

Fig. 13.1.4: Interface cable for printer connection

Table of Contents 07 PO 60

13.2	One-axis positioning unit 07 PO 60	13.2- 1	13.2.5.5	ABB Procontic T200 bus interface	13.2-20
13.2.1	Characteristics	13.2- 1	13.2.5.5.1	ABB Procontic T200 bus inputs	13.2-20
13.2.2	Example of system con- figuration using 07 PO 60	13.2- 2	13.2.5.5.2	ABB Procontic T200 bus outputs	13.2-23
13.2.3	Block diagram	13.2- 2	13.2.5.5.3	Display of ABB Procontic T200 bus in/outputs and of the initiators	13.2-25
13.2.4	Hardware description	13.2- 4	13.2.5.6	Function of Online-change of ramps	13.2-25
13.2.4.1	Summary of plugs	13.2- 4	13.2.5.7	Function of initiator signals	13.2-26
13.2.4.2	Terminal assignment of interfaces	13.2- 4	13.2.5.8	Software versions	13.2-27
13.2.4.3	Settings	13.2- 5	13.2.5.9	Interface protocols	13.2-27
13.2.4.4	Technical Data	13.2- 6	13.2.5.10	Error messages	13.2-32
	Accessories to 07 PO 60	13.2- 7	13.2.6	Application information	13.2-33
13.2.5	Firmware Description	13.2- 8	13.2.6.1	System cables	13.2-33
13.2.5.1	Overview of functions	13.2- 8	13.2.6.2	Earthing ,wiring and shielding concept	13.2-36
13.2.5.2	Operating and programming unit 35 AB 50	13.2- 9	13.2.6.3	Commissioning information	13.2-38
13.2.5.3	Operating modes	13.2-10	13.2.6.4	PC software 935 AM 50	13.2-38
13.2.5.3.1	Operating modes of operating units	13.2-10	13.2.6.5	LED diagnosis	13.2-40
13.2.5.3.2	External operating modes	13.2-10	13.2.6.6	Extension of the user program segments in RAM by replace- ment of components on the processor board	13.2-40
13.2.5.3.3	DNC operation	13.2-11	13.2.6.7	Incremental measuring system Incremental sensors/cable lengths	13.2-41 13.2-42
13.2.5.4	Programming	13.2-11	13.2.6.8	Operating the 07 PO 60 and 35 US 50	13.2-42
13.2.5.4.1	Function keys of the operating unit	13.2-12			
13.2.5.4.2	Set types and set construction	13.2-15			

13.2 One-axis positioning unit 07 PO 60

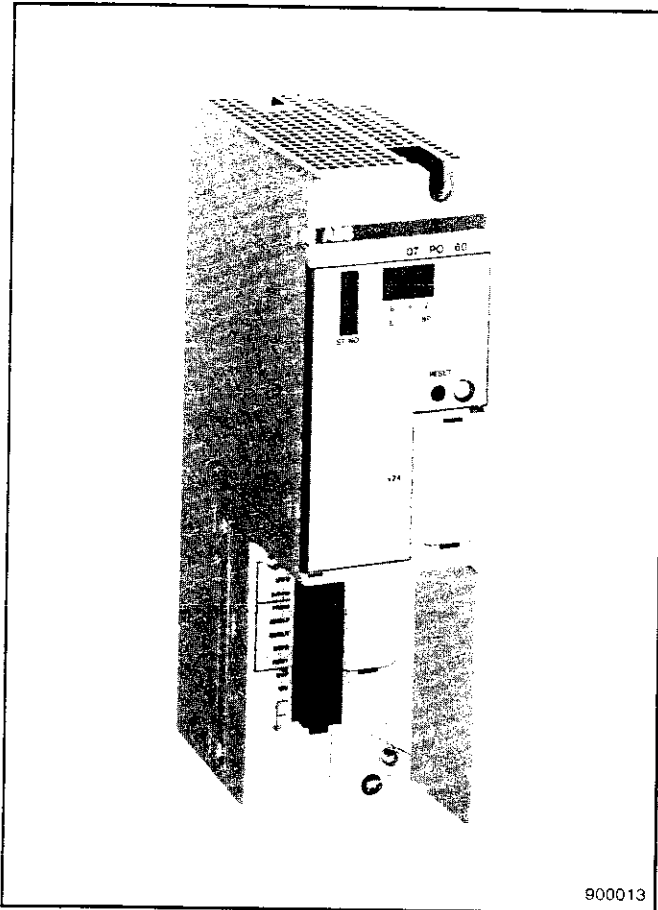

Fig. 13.2.1: One-axis positioning unit 07 PO 60

13.2.1 Characteristics

The one-axis positioning unit 07 PO 60 is intended for automatic positioning of a servo drive in the ABB Procontic T200 control system. Functionally it is almost exactly the same as the 35 PO 90 unit from the ABB Procontic T300 control system and 35 AM 50 from the AXUMERIK® m system.

Based on a micro controller the 07 PO 60 positioning unit processes user programs consisting of NC sets which it stores and manages itself. For programming the NC sets and for display, operating unit 35 AB 50 is used.

The 935 AM 50 PC software allows user program archiving on a personal computer and also the transfer of user programs from the PC to the 07 PO 60.

Several 07 PO 60 positioning units can operate simultaneously in an ABB Procontic T200 control system. Each unit occupies two I/O slots and can be inserted into the basic subrack or into the expansion subrack of a central expansion configuration. Operation in a remote expansion configuration is not possible.

The user program execution is controlled by the PLC by means of special PLC block instructions (PO_WR and PO_RD) for writing to and reading from the ABB Procontic T200 bus inputs and outputs.

The 35 AB 50 operating unit (or personal computer) and all process signals are connected via interfaces and plug connectors on the front panel. LEDs are provided for indicating operating modes.

As of version 07 PO 60 R201, the module provides an additional Online-change of ramps. 07 PO 60 R101 is no longer available and is fully replaced by R201.

13.2.2 Example of system configuration using 07 PO 60 (Fig. 13.2.2)

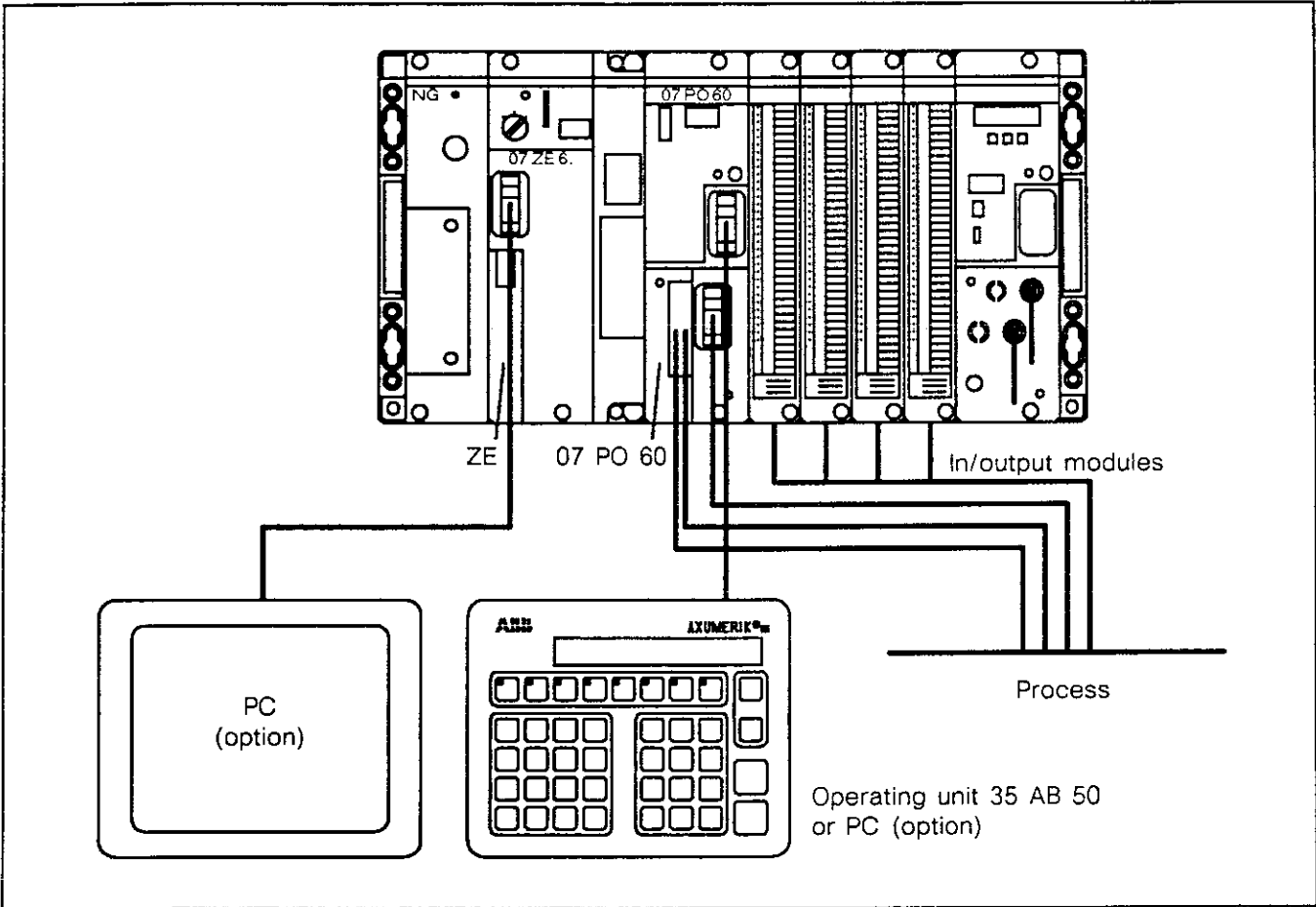

13.2.3 Block diagram (Fig. 13.2.3)

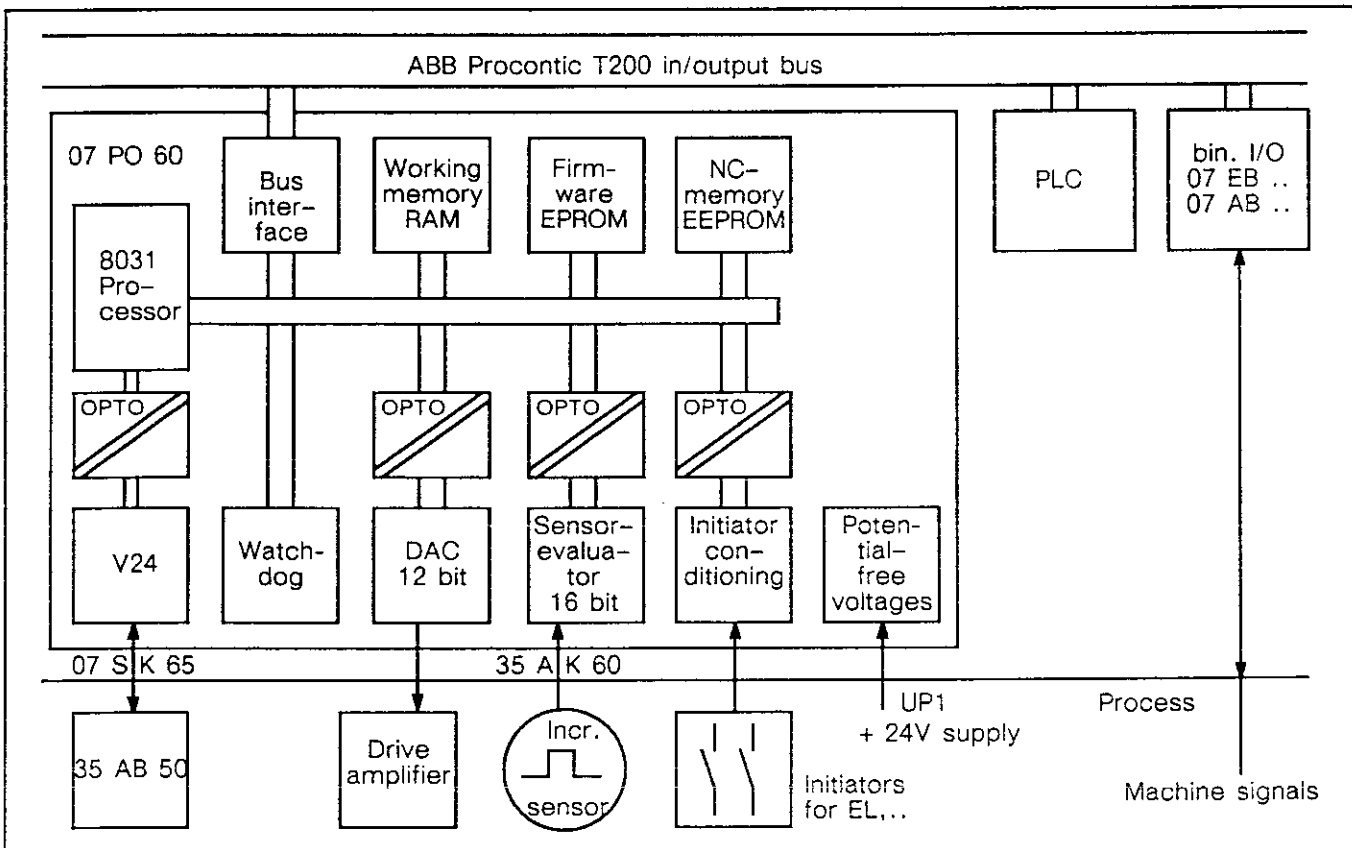

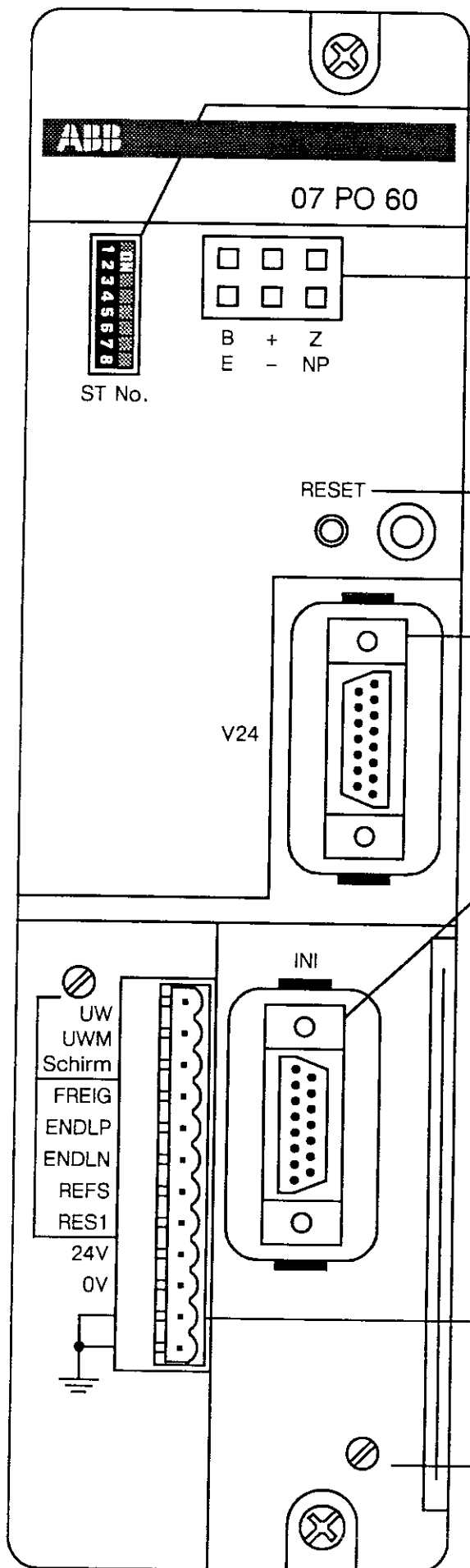

ST No. (Station Number DIL switch)

Reserved for future applications. At present the switch setting is not evaluated.

Display LEDs

- B : 07 PO 60 is ready for operation (PLC positioning operation) (signal: Axis ready)
- E : limit position reached
- + : traversing direction positive
- : traversing direction negative
- Z : axis in target window
- NP : machine zero point (reference point) reached

RESET pushbutton

Individual unit reset

V24 interface

Sub D plug, 15 poles, female
Serial interface for the operating unit 35 AB 50 or personal computer; assignment see next page

Interface for the incremental actual value (incremental position sensor)

Sub D plug, 15 poles, male
assignment see next page

Plug-in connections for rotary speed setpoint, initiators and supply of process voltage

- UW : output rotary speed setpoint ± 10 V
- UWM : reference potential (0V) to UW
- Schirm : protective earth (PE), internally connected to the lower two terminals
- FREIG : enable initiator
- ENLDP : initiator limit position positive (+)
- ENDLN : initiator limit position negative (-)
- REFS : reference point initiator
- RES1 : reserved, do not connect
- 24V : + 24 V supply, process voltage UP1
- 0V : 0 V supply, process voltage ZP1
- PE : protective earth
- PE : protective earth

Screw-on terminal block

Fig. 13.2.4: 07 PO 60 unit with description of display and operating elements as well as the interfaces

13.2.4 Hardware description

13.2.4.1 Summary of plugs

Signal name	Interface, plug	Type	Numb.of poles
V24	Operating unit or personal computer	SUB-D plug (female)	15
INI	Incremental sensor input	SUB-D plug (male)	15
Uw	Set value output	Screw-type terminal block	3
Initiators	Initiator inputs	Screw-type terminal block	5
UP1	Process voltage	Screw-type terminal block	2
PE	Protective earth	Screw-type terminal block	2
	ABB Procontic T200 in/output bus	Special plug	50

13.2.4.2 Terminal assignment of interfaces

Serial interface (V24)

PIN	Signal name	Significance	Remarks	I/O
V24.1	PGND	Protective ground	Shield	I
V24.2	/TxD	Transmit data	RS422/232C	O
V24.3	/RxD	Receive data	RS422/232C	I
V24.7	SGND	Signal ground		
V24.14	0 V	Supply operating unit	only when plugged in X11 on cross board	O
V24.12	+24 V	Supply operating unit	only when plugged in X12 on cross board	O
V24.9	TxD	Transmit data	RS422	O
V24.10	RxD	Receive data	RS422	I

Position sensor interface (INI)

PIN	Signal name	I/O
INI.1	Shield	I
INI.2	Sensor supply ext./+5 V/+15 V (X7)	O
INI.3	Sensor supply 0 V	O
INI.4	Sensor supply 0 V	O
INI.5	Sensor supply 0 V	O
INI.6	Sensor supply 0 V	O
INI.7	Sensor supply ext./+5 V/+15 V (X7)	O
INI.8	Trace A	I
INI.9	Trace /A	I
INI.10	Trace B	I
INI.11	Trace /B	I
INI.12	Trace /C	I
INI.13	Trace C	I
INI.14	NC	
INI.15	NC	

Screw-type terminal block (PE)

PIN	Signal name	I/O
PIN2	PE busbar	I
PIN1	PE busbar	I

Screw-type terminal block (UP1)

PIN	Signal name	I/O
PIN4	+24V (UP1)	I
PIN3	0V (for UP1)	I

Screw-type terminal block (initiators)

PIN	Signal name	I/O
PIN9	Enable initiator (FREIG)	I
PIN8	Limit position + initiator (ENDLP)	I
PIN7	Limit position - initiator (ENDLN)	I
PIN6	Reference point initiator (REFS)	I
PIN5	Reserved (RES1)	I

Screw-type terminal block (UW)

PIN	Signal name	I/O
PIN12	UW = ± 10 V	O
PIN11	UWM = 0 V	O
PIN10	Shield	I

ABB Procontic T200 in/output bus interface

In accordance with ABB Procontic T200 in/output bus interface specification

13.2.4.3 Settings

Jumper terminal block

accessible after unscrewing the terminal block through the upper cutout

Jumper	Position	Significance
X5	1-3 *	Internal sensor supply + 5V
X5	1-2	Internal sensor supply + 15V
X5	open	External sensor supply

* Factory setting

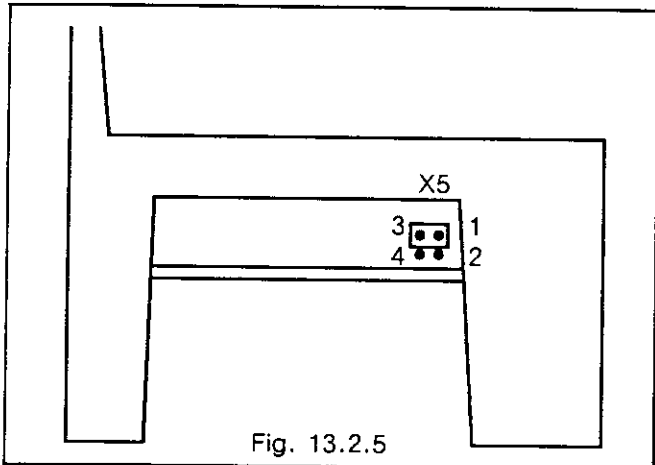

Cross board jumpers

accessible after removing the front cover of the unit

Solder bridge	Position	Significance
X12	1-2 *	operating unit + 24V: on
X12	offen	operating unit + 24V: off
X11	1-2 *	operating unit 0 V: on
X11	offen	operating unit 0 V: off
X5	2-3 *	serial interface on RS-422
X5	1-2	serial interface on RS-232-C

* Factory setting

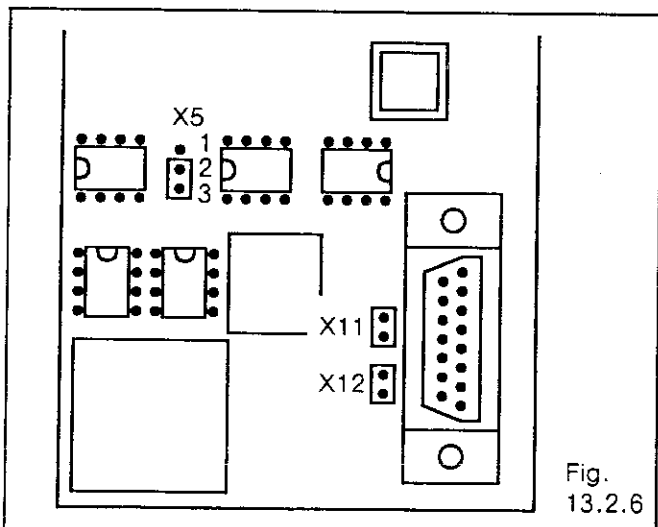

Processor board jumpers

The jumper settings on the processor board are not normally altered by the user.

Jumper	Position	Significance
X3	1-2 *	processor clock on
X4	2-3 *	A5 = 8 k · 8 EEPROM
X5	open *	A5 = 8 k · 8 EEPROM
X6	1-2 *	watchdog on

* Factory setting

Incremental sensor evaluation board jumper

The jumper settings of the incremental-sensor evaluation board are not normally altered by the user.

Jumper	Position	Significance
X3	1-2 *	position evaluation clock on

* Factory setting

Setting the station number

On the ABB Procontic T200 the address ranges of the units are determined by the slot in the subrack. With the 07 PO 60 unit it is therefore not necessary to set a unit address (with the ABB Procontic T300 unit 35 PO 90, the unit number/address is set by means of S1).

With the 07 PO 60 the function of switch S1 is reserved. For example:

Setting of switch S1:

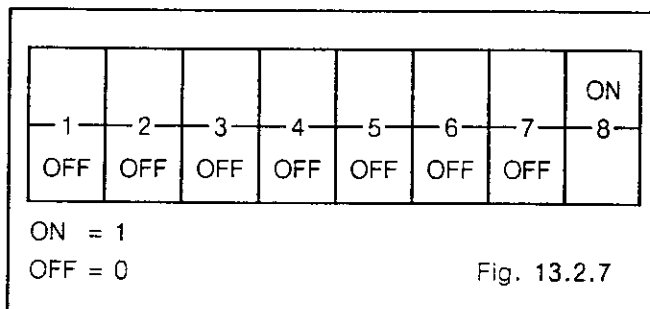

In this example, the station number is set to 1 (00000001 binary).

13.2.4.4 Technical Data

07 PO 60

Supply voltages

UB1 = logic voltage	+ 5 V DC
UP1 = process voltage	+ 24 V DC (19 V...30 V)

Supply currents

Current consumption from logic voltage

UB1 = 5 V DC	typ. 0.45 A, max. 0.6 A
UB4 = 24 V DC	no current consumption

Current consumption from process voltage

UP1 = 24 V DC	
without supply for operating unit and incremental sensor	typ. 0.15 A
operating unit supply 24 V DC	typ. 0.30 A, inrush current max. 1.3 A
incremental sensor supply 5 V ($\pm 0,25$ V)	max. 0.4 A permissible, even short-duration currents of higher magnitude will lead to malfunction

incremental sensor supply 15 V DC (13...16 V)	max. 0.4 A permissible
---	------------------------

Total power dissipation	typ. 5.9 W, max. 9 W
-------------------------	----------------------

Environmental values

Ambient temperature	0 °C... + 55 °C
Storage temperature	- 25 °C... + 55 °C
Transport temperature	- 25 °C... + 75 °C
Humidity class	F
Mechanical shock	test criteria according to Germanischer Lloyd
	Vibration: 5...13.2 Hz at 1 mm
	frequency range: 13.2...100 Hz at 0.7 g

EMC class

see system data

Interfaces (all electrically isolated)

Serial interface (V24)	RS-422 / RS-232-C
can be selected	by jumper
baud rate	2400 baud
transfer format	8 data bits, 1 stop bit, even parity
Position sensor interface (INI)	input circuitry with 26 LS 32
common-mode input voltage	max. ± 25 V
differential input voltage	max. ± 25 V
switching threshold	± 0.2 V
impedance on cable ends	Ua1, Ua2 RC element 120 Ω / 1 nF
	Ua0 RC element 120 Ω / 680 pF
min. pulse width of the sensor signals	Ua1/Ua2: 2 μ s
max. sensor frequency	100 kHz
Set value interface (UW)	
output voltage at full scale	± 10 V
mathematical resolution	4.88 mV/bit
max. output load capability	± 3 mA
output inductance, bifilar choke	typ. 140 μ H
effective inductance	typ. 1.5 μ H
Initiator interface	
input voltage	+ 24 V (19...30 V)
input voltage, signal 0	≤ 4 V
input voltage, signal 1	≥ 14 V
input current	< 5 mA

General data

Max. number of units per subrack	only limited by number of in/output slots
Length of cable leading to the position sensor	max. 20 m
Signalling	6 LEDs
Number of required slots	2 I/O slots
Number of occupied I/O points	64 input and 64 output points
Configuration identifier in 907 PC 32	EAW4 (entered for right slot number)
Ability of fitting in subracks	
slot,	
●-● = plug-in is possible (2 slots)	
Weight	800 g
Order number 07 PO 60 R 101	GJR5240000R101 (no longer available)
Order number 07 PO 60 R 201	GJR5240000R201

BT			BE-central			BE-remote		
NG	ZE	I/O	NG	BV	I/O	NG	BV	I/O
		●-●			●-●			

Accessories to the positioning unit 07 PO 60

Operating and programming unit 35 AB 50 order number	GJR5139200R102
Electronic switch and control logic 35 US 50 b order number	GJR5141800R101
Software for programming system 907 PC 32 V2.3 order number	GJP5201300R102
Additional library 907 PB 362 V1 for programming system 907 PC 32 order number	GJP5201900R102
Software for personal computers 935 AM 50 order number	GJR5512000R202

System cables

Dialog cable 07 SK 65 (Connection between 07 PO 60 and 35 AB 50/PC) R1 (3m); order number	GJV3073910R1
Dialog cable 07 SK 66 (Connection between 07 PO 60 and 35 US 50) R1 (1 m) order number	GJV3073911R1
Position sensor cable 35 AK 60 R5 (5 m); order number	GJR5142200R5
R6 (10 m); order number	GJR5142200R6
R7 (20 m); order number	GJR5142200R7
Position sensor cable 35 AK 70 for AXODYN® power inverter type DRH R1 (2,5 m), order number	GJR5142300R1

Incremental position sensors (for intermediate flanges with 50-mm insertion bore)

500 pulses/revolution, order number	GJV3075101R1
1000 pulses/revolution, order number	GJV3075101R2

Initiators

NJ 5-18 GK50-E3 (closed-circuit current), order No.	GJV3200001R2
NJ 5-18 GK50-E2 (working current), order No.	GJV3200003R2

13.2.5 Firmware Description

13.2.5.1 Overview of Functions

Access to 07 PO 60:

- Programming with the operating unit 35 AB 50 or in DNC mode or by means of the programming software 935 AM 50 (which is supported by a PC with MS-DOS)
- Operating the programmed 07 PO 60 is possible without the operating unit (control by PLC)

Programming and operation:

- Programming with NC-sets:
 - Positioning sets
 - Positioning range ± 7 digits
 - Linear start-up and braking or according to a \sin^2 characteristic
 - Traversing speed settable by software
 - Teach-in of position set values
 - Subprogram sets (loop sets)
 - Special sets
- Machine data set for 20 machine specific parameters
 - Maximum traversing speed 12 m/min with 1 μm resolution
 - Programmable start-up and brake ramp 10 ms to 10 sec
 - Single, double or 4-fold evaluation of the position sensor
 - Programming the position-set values in any desired unit of measurement
 - Software limit switch
 - Soft or hard traversing mode selectable

- Move to reference point
- Shift of the zero mark
- Manual control
- Tool compensation
- Speed override
- Programmable flag positions
- 4 user program segments in memory (EEPROM), which is non-resetting on power supply interruptions
 - The above listed NC-types are available in each program segment
- The run of the user program can be controlled in different operating modes either by the operating unit, the PLC or a PC.

Differences between 07 PO 60 and AXUMERIK® m:

The basic difference between the 07 PO 60 and the AXUMERIK® m is that 07 PO 60 does not contain the binary in/outputs of the AXUMERIK® m. The AXUMERIK® m uses these binary in/outputs for communication with a PLC in the external operating modes. The PLC communicates with the 07 PO 60 via its ABB Procontic T200 in/output bus interface, i.e. there is no wiring needed between the 07 PO 60 and the PLC.

Data interchange between 07 PO 60 and PLC:

- In the external operating modes the 07 PO 60 is controlled by the PLC.
- Special PLC blocks support the operation of the 07 PO 60 (block PO_RD and PO_WR). These blocks are available as CE library 907 PB 362. They run within the test and programming software 907 PC 32.

13.2.5.2 Operating and programming unit 35 AB 50 (Fig. 13.2.11)

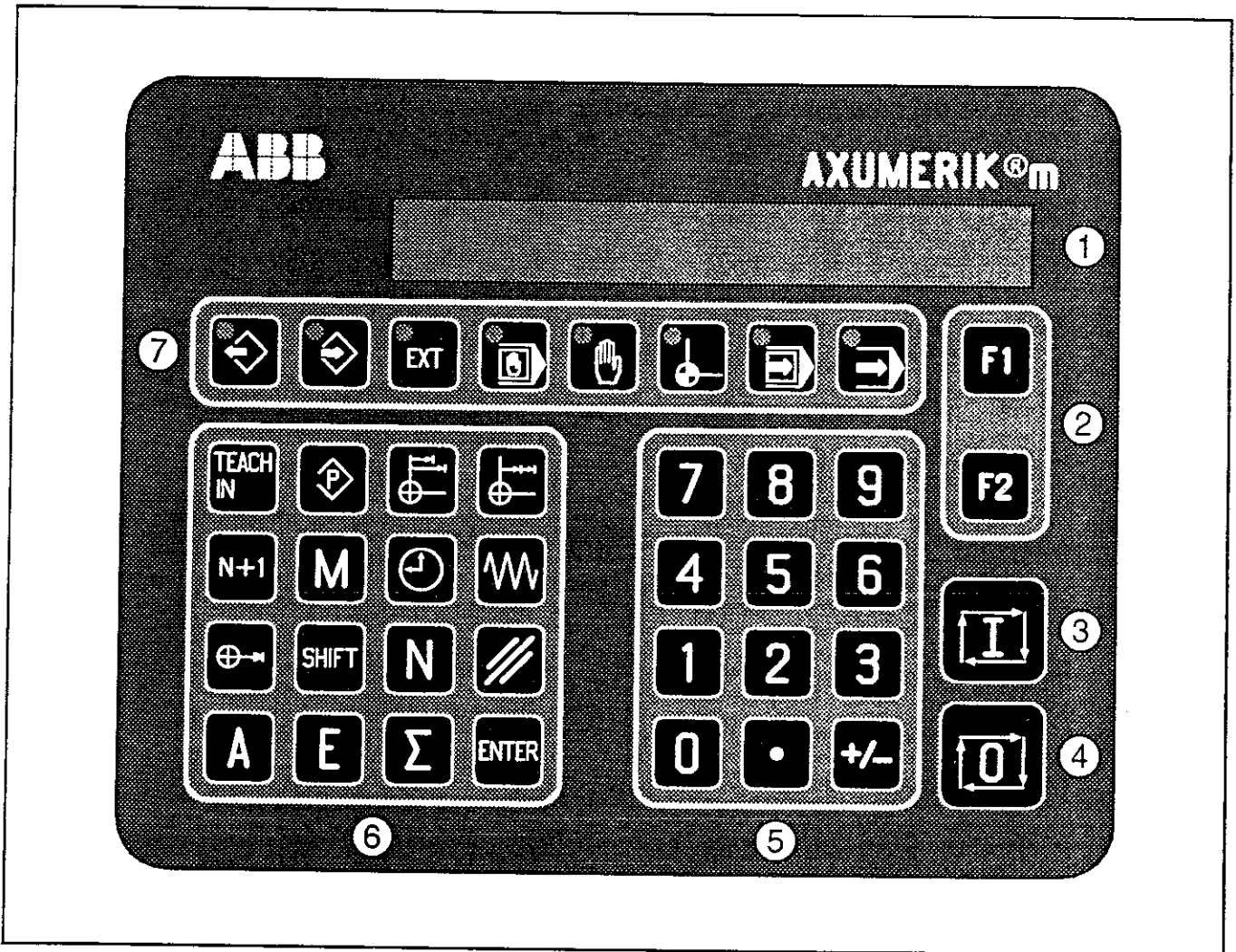

1 – 16–digit alphanumeric display

Key assignments:

2 – Special function keys:

- F1 : run-up and brake characteristic
- F2 : selection of axis (for 35 US 50)

3 – START key

4 – STOP key

5 – Entering of numbers with sign and decimal point

6 – Function keys for programming of set parameters (from top left to bottom right):

- Teach In
- Selection of parameters
- Absolute measuring system (ABS)
- Incremental measuring system (INK)
- Subset (N+1)
- Machine function (M-Fkt)
- Dwelling time (DWELL)
- Feed (FEED)
- Shift of zero mark
- Shift key
- Set number (N)
- Delete key
- Starting set number (ANFS)

Ending set number (ENDS)

Loop number (sum)

Enter key

7 – Operating mode keys (from left to right):

- EPROM write (out of service!)
- EPROM read (out of service!)
- EXTERN
- Manual entering of data
- Manual control
- Move to reference point
- Operating unit: automatic single set
- Operating unit: automatic subset

Note:

Detailed description of key function is given on the following pages.

13.2.5.3 Operating modes

When 35 AB 50 is powered up, an operating mode is not yet selected. The selection of an operating mode can be carried out via the operating unit (operating mode keys), the PLC (operating mode selection) or a PC (in DNC mode).

13.2.5.3.1 Operating modes of the operating unit

Extern:



Activation of an external operating mode according to the status of the external "operating mode selection" (only if an operating mode of the operating unit was previously active).

Manual entering of data:



In this operating mode, the set data can be programmed and altered via the operating unit keys. Position values can be taken over into positioning sets by "Teach In".

Manual control:



In this operating mode, the axis by means of the "Sign" key and the "Start" key can be traversed at the speed programmed in the corresponding manual control set. As long as the "Start" key is pressed, the axis drives in the direction indicated by the "Sign" key. The drive direction is stored until the "Start" key is released.

Move to reference point:

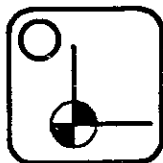

In this operating mode, the axis, after a selection of the direction with the "Sign" key and pressing of the start key, moves to its reference point. This operation is carried out at the programmed speed in the corresponding reference point set. The programmed machine function is an output.

Operating unit: automatic single set (Bed/AE):

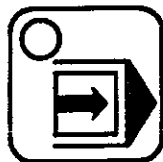

When this operating mode is selected and a set (e.g. N030) is addressed, this will be executed after pressing the "Start" key. If the set contains a subset ($N+1 \neq 255$), this will be executed after pressing the "Start" key again, unless a new set

has been selected via the keyboard. If no subset exists ($N+1 = 255$), the processing of the program will be aborted after the execution of N255. A new set has to be selected.

By pressing the "Stop" key, the positioning process is interrupted referring to the "brake mode in case of failure", which is programmed in the machine data set. When the "Start" key is pressed again, the execution of the interrupted program is continued at the position where the program has been interrupted, unless another set has been selected.

When the set position has been reached, the subset number appears on the display with a comment and the actual position value. The programmed machine function is an output.

Operating unit: automatic subset (Bed/AF):

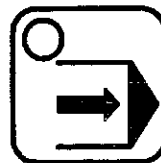

As automatic single set (Bed/AE), except that the subsets will be automatically processed after pressing the "Start" key once, until there are no more subsets contained in a set ($N+1 = 255$). The downtime between two positionings equals the programmed "Dwell time".

13.2.5.3.2 External operating modes

An external operating mode is requested via the PLC (ABB Procontic T200 bus inputs "operating mode selection"). It becomes active only if the ABB Procontic T200 bus outputs "operating modes quit" agree with the selection. Even after an alteration of the "operating mode selection", an external operating mode remains valid as long as the "operating modes quit" have been adapted correspondingly.

The operating unit is not absolutely necessary for all external operating modes. It displays the set numbers and actual position values and offers the possibility to abort the program in all external operating modes with the "Stop" key using the "brake mode in case of failure" programmed in the MDS. It also can display the ABB Procontic T200 bus interface.

External automatic single set (Ext/AE):

In the operating mode (Ext/AE), a set is selected by the PLC and started with a "Start". The further run is determined by the subsets. After a set has been processed, the PLC only gives the "Start" signals (0 → 1 – edge required) for the start of the corresponding "subset". If no subset is contained in a set ($N+1 = 255$) or the "set number" is set to N255, the program run will be aborted after "Start" and processing of the set N255 ("set executed" = 0 for 200 ms). A new selection of a set is necessary.

If a set is already executed in the same program, but also found in a set as a "subset", this subset will be executed repeatedly until it is aborted by pressing the "Stop" key on the operating unit or by the PLC (set number N255, no further "Start" signals, change of the "operating mode selection").

After an interruption of the program run by the "Stop" key, it can be continued at the interruption position by pressing the "Start" key again and after a new "Start" signal given by the PLC. The programmed machine function is an output.

External automatic subset (Ext/AF):

In the operating mode (Ext/AF), a set is preset with the "set number" for 07 PO 60 and is started with a "Start" signal. The further program run is determined by the programmed subsets. The PLC gives only a single "Start" signal (continuous signal). All subsequent start signals are given internally at the end of the programmed dwell time, as long as the "Start" signal = 1. If there is no subset (N+1 = 255) contained in the set, the program run will be interrupted after the processing of the set N255 ("set executed" = 0 for 200 ms).

If a set is already executed in the same program, but also found in a set as a "subset", this subset will be executed repeatedly until it is aborted by pressing the "Stop" key on the operating unit or by the PLC ("Start" signal = 0 or change of the "operating mode selection"). If the "Set number" is changed to N + 1 = 255 after an interrupted positioning process and before a renewed start, the set processing will be aborted after the execution of the set N255 ("set executed" = 0 for 200 ms). A new set is then to be selected.

After an interruption of the program run with the "Stop" key, it can be continued at the interruption position by pressing the "Start" key again and after a new "Start" signal given by the PLC. The programmed machine function is an output.

External (Ext):

In this operating mode, the 07 PO 60 receives all control signals from the higher-level control (PLC), which also determines the program run.

After an interruption of the program run with the "Stop" key, it can be continued at the interruption position by pressing the "Start" key again and after a new "Start" signal given by the PLC. The programmed machine function is an output.

The special sets "Move to reference point" and "Manual control" as well as the function "Teach in" can be activated in the operating mode "Ext".

13.2.5.3.3 DNC operation

The DNC operation offers the possibility of a central archiving of the 07 PO 60 NC programs on a PC as well as editing and printing of 07 PO 60 NC programs via a PC. In DNC operation, all NC sets can be read out, changed and transferred to EEPROM (user program memory) via a PC (according to the selected user program segment).

The DNC operation is supported by the PC software 935 AM 50 (see chapter 13.2.6, application information).

A DNC operation between the 07 PO 60 and a PC is only possible, if neither an operating mode of the operating unit nor an external operating mode is active (ABB Procontic T200 bus input "operating mode selection" and ABB Procontic T200 bus output "operating modes Quit" = 0, or with operating mode of the operating unit reset by pressing "Extern" key). If the DNC operation should be realized without the PC software 935 AM 50, the telegram frame described in the chapter Interface protocols must be met. The interface protocols for the DNC operation are also recorded in this chapter.

RAM operation:

The RAM operation is a special mode of DNC interchange. It serves as a fast DNC interchange for positioning sets and the machine data set.

The sets which are transferred via the serial interface are stored in the working memory (RAM) and not in the program memory (EEPROM) of the 07 PO 60, which is non-resetting on power supply interruptions. The program memory remains unchanged by this.

Direct DNC interchange:

By means of a DNC telegram, a positioning set can be transferred (also partly) and started immediately (without PLC "Start" signal).

Reading out of an actual position value with DNC:

By means of a DNC telegram, the actual position value of the 07 PO 60 referring to the machine reference point can be read out.

13.2.5.4 Programming

All sets listed in the chapter "Set types" are included in an "user program segment" (user program segment). 4 user program segments are available in the EEPROM, which is non-resetting on power supply interruptions. The user thus has the possibility of saving all set numbers 4 times.

The user selects the currently active user program segment via the PLC for changing the machine data set and the flag sets (information in chapter "Description of the ABB Procontic T200 bus interface", note paragraph "User program segment"). The programming of the 07 PO 60 is carried out set-wise with the operating unit 35 AB 50 or by transferring the NC program from a PC to the 07 PO 60 in the DNC operation.

13.2.5.4.1 Function keys of the operating unit

Teach In:



This key is only functional in the operating modes "Ext" or "Manual entering of data". Teach In definition: Drive axis into desired position during setting-up (manual or tip operation) and store this actual position value as position set value of a positioning set.

Procedure for operating mode "Manual entering of data":

- Position the axis in desired position.
- Select operating mode "Manual entering of data".
- Call-up of the set to be programmed, e.g. N70 via the keys: N, 0, 7, 0
- Press the "Teach In" key -> the actual positioning value appears on the display of the operating unit.
- Taking-over of the actual position value as position set value of the selected set via the "Enter" key.
- Entering of the other set parameters (FEED, DWELL, N+1 etc.) as previously.

Parameter selection:



Selection of the parameters P01 to P20 of the machine data set. This key is only functional in the operating mode "Manual entering of data".

Absolute measuring system (ABS):

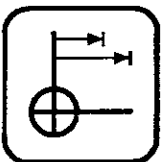

The entered position set value refers to a firm reference point.

Example: (Fig. 13.2.12)

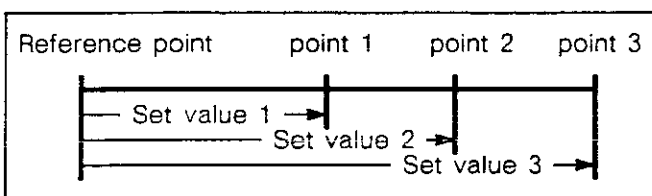

Set value 1 = 350 increments
Set value 2 = 600 increments
Set value 3 = 1100 increments

The position set value 1 has to be reactivated to return from point 3 to point 1.

This key is only functional in the operating mode "Manual entering of data".

Incremental measuring system (INK):

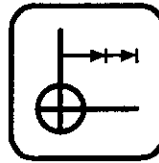

The entered position set value refers to the actual position value before the "Start" of the set.

Example: (Fig. 13.2.13)

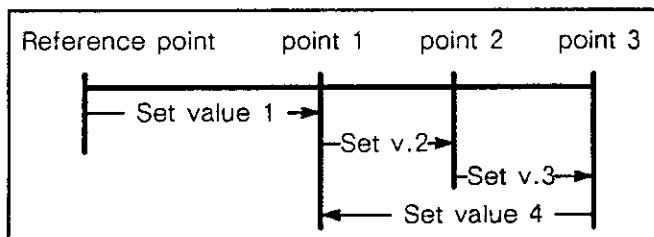

Set value 1 = 350 increments
Set value 2 = 250 increments
Set value 3 = 500 increments
Set value 4 = -750 increments

The position set value 4 has to be activated to return from point 3 to point 1.

This key is only functional in the operating mode "Manual entering of data".

Subset (N+1):



Entering of the subset (0 - 255).

The "subset" determines with which set the program is to be continued corresponding to the operating mode. It must always be programmed when the program is created (subset operating modes). If a program is to finish, "N+1" = 255 must be programmed.

If the same set number is defined as a subset in a set, this set will be repeated according to the operating mode (e.g. Bed/AF), until the program run is interrupted (e.g. via "Stop" key) (only meaningful with the mode "entering of incremental measurement").

This key is only functional in the operating mode "Manual entering of data".

M-FKT (Machine function):



The "Machine function" of a set (-999 to +1000) is output with the set process.

When programming the "Machine function" of a set + (positive value), the outputs are active after set processing is finished.

When programming the "Machine function" of a set - (negative value), the outputs are active at set start-up.

A selected "Machine function" is available at the ABB Procontic T200 bus outputs until a new "Machine function" has been given out.

When programming M 1000, no "Machine function" is programmed in this set. The previously programmed "Machine function" remains available. This feature is used to jump e.g. from either of two sets with differing "Machine functions" into the same subset. After the execution of the subset, the PLC can detect via the "Machine function" from which set jumping into the subset has been carried out and can continue processing correspondingly.

Example:

N020, machine function 02, N + 1 = 120

N050, machine function 05, N + 1 = 120

N120, machine function 1000

This key is only functional in the operating mode "Manual entering of data".

Dwell time (DWELL):

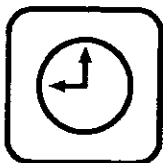

Key to call up the parameter dwell time. Programming possible from - 0.1 s to 327 s.

When programming "DWELL" = 0 s to 327 s:

In the automatic-subset operating modes, the subset is automatically started after the programmed dwell time has passed.

When programming "DWELL" = - 0.1 s:

The position set value programmed in the set will be "overflowed" (without precise stop). The "subset" will be executed without a further start signal.

It is not allowed to program "DWELL" = - 0.1 in each of two subsequent sets.

The machine function of a set with DWELL = - 0.1 is output only if it has been programmed negatively.

This key is only functional in the operating mode "Manual entering of data".

Advance feed (FEED):



Function in the operating mode "Manual entering of data":

Key to call up the parameter traversing speed. Programming possible from 0 to 32752.

If the programmed FEED value exceeds the parameter Vmax. (P04 MDS), the set processing will be carried out at the speed Vmax.

By means of P11 MDS, the advance feed can also be entered and displayed in the desired unit of measurement.

For P11 MDS = 0, the following applies: incremental entering of FEED in increments/(1/12.5) s

See chapter: Set types (Enter P11 MDS)

During the positioning mode the display can be changed from actual position value to actual speed value by the FEED key.

The following is valid:

- Display of the speed for P11 MDS = 0:
Display = actual FEED value / 16
- Display of the speed for P11 MDS ≠ 0:
Display of actual FEED value in the corresponding unit of measurement

Shift of the zero mark:

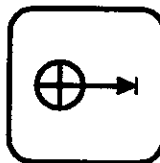

Key to call up the actual position value parameter in case of the shift-of-the-zero-mark sets.

This key is only functional in the operating mode "Manual entering of data".

Shift key:



By means of the "Shift" key, the individual set parameters will be shifted further sequentially during the entering of a set.

This key is only functional in the operating mode "Manual entering of data".

Set number (N):



Key for selection of the set numbers in the operating modes "Manual entering of data", Bed/AE and Bed/AF.

Delete key:

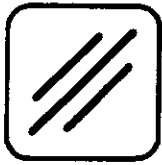

Function in the operating mode "Manual entering of data":
By means of the delete key, incorrect inputs can be deleted (only before finishing the entering by the "Enter" key).

In all operating-unit and external operating modes except "Manual entering of data": the error messages displayed on the operating unit are to be acknowledged with the "Delete" key.

Start-up set (A):



Function in the operating mode "Manual entering of data":
Selection of the set parameter "Start-up set" for the input of a loop set.

In all operating modes except "Manual entering of data": display of the ABB Procontic T200 bus outputs on the operating unit (see chapter 13.2.5.5.3 Display of ABB Procontic T200 bus in/outputs and the initiators).

End set (E):



Function in the operating mode "Manual entering of data":
Selection of the set parameter "End set" for the input of a loop set.
In all operating modes except "Manual entering of data":

display of ABB Procontic T200 bus inputs on the operating unit (see chapter 13.2.5.5.3 Display of ABB Procontic T200 bus in/outputs and the initiators).

Number of loops:

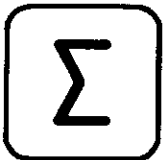

Selection of the set parameter "Number of loops" for the input of a loop set. This key is only functional in the operating mode "Manual entering of data".

Enter key:



Storing a programmed or altered set in the 07 PO 60 memory, which is non-resetting on power supply interruptions (into the user program segment presently selected).

This key is only functional in the operating mode "Manual entering of data".

Run-up and brake characteristic (F1):

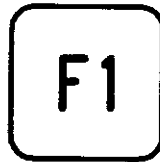

For the input of a positioning set, it can be selected by the "F1" key, whether the entered run-up and brake ramp (MDS) is to be traversed linearly or according to a sin² curve.

Example:

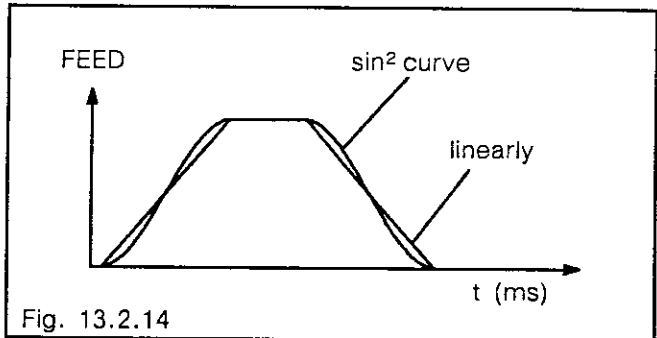

Fig. 13.2.14

Axis switch over (F2):



Only when working with the 35 US 50 (electronic switch and control logic for the operation of up to six 07 PO 60 units via one operating unit 35 AB 50 or a PC): selection of the 07 PO 60 via the operating unit.

See AXUMERIK® m system description, chapter 18: Electronic switch and control logic 35 US 50.

Start key:

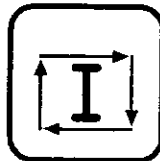

Starting of a previously selected set in the operating modes "Bed/AE" and "Bed/AF".

Starting of the axis in the operating mode "Move to reference point".
Traversing of the axis in the operating mode "Manual control" (as long as the "Start" key remains pressed).

Renewed starting of the axis movement after abortion of the set processing (with "Enable" initiator = 0 and "Stop" key pressed) in the operating modes of the operating unit (except "Manual entering of data").

Releasing of the 07 PO 60 for a renewed start of the axis movement after abortion of the set processing by the "Stop" key in all external operating modes.

Stop key:

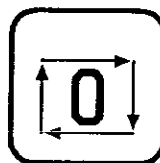

Abortion of the positioning process according to the "brake mode in case of failure" programmed in P08 (MDS).

This key is functional in all operating modes except "Manual entering of data".

13.2.5.4.2 Set types and set construction

The sets listed in this chapter are available to the user in each of the 4 user program segments. Switching over the user program segment see Chapter ABB Procontic T200 bus inputs user program segment.

Set types:

- Loop sets
- Positioning sets
- Special sets:
 - Machine data set (MDS)
 - Move to reference point
 - Manual control
 - Shift of the zero mark
 - Flag positions
 - Tip sets
 - Speed override
 - Length correction sets
 - Scale factor
 - Software code

Loop sets:

Number of sets: 16

Set numbers: 00 to 15

Set contents:

Set No.	Start set	End set	Number of loops
N	16-165	16-165	0-255

Subset
0-255

Positioning sets:

The input of the position set value is dependent on P11 MDS ($P11 \neq 0 \rightarrow$ Input in the measuring unit selected with P11, e.g. in mm).

Number of sets: 112

Set numbers: 16 - 127

Set contents:

Set No.	Measuring system	Run-up/brake char.	Sign	Position set value
N	ABS/INK	lin/sin ²	+/-	0-9999999

Advance feed	Dwell time	Machine function	Subset
0-32752	-0.1-327	-999 - +1000	0-255

Move to reference point (in positive direction):

Number of sets: 4

Set numbers: 132, 160, 161, 162

Set contents:

Set No.	Advance feed	Dwell time	Machine function	Subset
N	0-32752	0-327	-999 - +1000	0-255

Move to reference point (in negative direction)

Number of sets: 4

Set numbers: 133, 163, 164, 165

Set contents:

Set No.	Advance feed	Dwell time	Machine function	Subset
N	0-32752	0-327	-999 - +1000	0-255

Manual control (positive traversing direction):

Number of sets: 1

Set number: 134

Set contents:

Set No.	Advance speed
N	0-32752

Manual control (negative traversing direction):

Number of sets: 1

Set number: 135

Set contents:

Set No.	Advance speed
N	0-32752

Shift of the zero mark:

After call-up of a zero shift set, the previous position set value is replaced by the position set value given in the zero shift set. The input of the position set value is dependent on P11 MDS ($P11 \neq 0 \rightarrow$ Input in the measuring unit selected with P11, e.g. in mm).

Number of sets: 4

Set numbers: 148, 149, 150, 151

Set contents:

Set No.	Dwell time	Machine function	new position set value
N	0-327	-999-+1000	+/-9999999

Subset
0-255

Flag positions:

Positive flag position value:

If the axis drives over a flag position in positive direction, the corresponding ABB Procontic T200 bus output will be set. If the axis drives over a flag position in negative direction, the corresponding ABB Procontic T200 bus output will be reset.

Negative flag position value:

If the axis drives over a flag position in negative direction, the corresponding ABB Procontic T200 bus output will be set. If the axis drives over a flag position in positive direction, the corresponding ABB Procontic T200 bus output will be reset.

Number of sets: 3
 Set numbers: 144, 145, 146
 Set contents:
 Set No. Flag position
 N +/-9999999

Tip sets (positive traversing direction):

After the "Start" of a tip set, the axis is traversed according to the set value given in the remark.

Number of sets: 4
 Set numbers: 152, 153, 154, 155

Set contents:

Set No.	Advance feed	Subset	Remark
152	0-32752	0-255	+1 Incr.
153	0-32752	0-255	+10 Incr.
154	0-32752	0-255	+100 Incr.
155	0-32752	0-255	+1000 Incr.

Tip sets (negative traversing direction):

After the "Start" of a tip set, the axis is traversed according to the set value given in the remark.

Number of sets: 4
 Set numbers: 156, 157, 158, 159

Set contents:

Set No.	Advance feed	Subset	Remark
156	0-32752	0-255	-1 Incr.
157	0-32752	0-255	-10 Incr.
158	0-32752	0-255	-100 Incr.
159	0-32752	0-255	-1000 Incr.

Override sets:

The activation of a speed override (0 to 120 %) is executed via the PLC. If an internal override is active, the axis will be traversed with 0 to 120 % (according to the override value programmed in the override set) of the parameter "FEED".

Number of sets: 2
 Set numbers: 136, 137

Set contents:

Set No.	Override value
N	0-120

Length correction sets (tool compensation):

The activation of a length correction value is initiated by the PLC. If an internal length correction is active, the length correction value is added to the position set value of a positioning set. The input of a length correction value depends on P11 MDS (P11 ≠ 0; input in the unit of measurement selected with P11, e.g. in mm).

Number of sets: 2
 Set numbers: 138, 139

Set contents:

Set No.	Length correction value
N	-9999999 - +9999999

Scale factor:

The activation of the scale factor is initiated by the PLC. If the scale factor is active, the following number of increments will be traversed for the execution of "Incr." programmed positioning sets: position set value x scale factor (0 to 200 %).

If the scale factor is active, a movement to the absolute position value (position set value x scale factor (0 to 200 %)) will be carried out for the execution of "ABS" programmed positioning sets.

Number of sets: 1
 Set numbers: 140

Set contents:

Set No.	Scale factor
140	0-200

Software code:

Display of the 07 PO 60 firmware-version number on the operating unit in the operating mode "Manual entering of data". The MDS is also changed, when the user program segment is changed over (according to chapter ABB Procontic T200 inputs, user program segment).

Number of sets: 1
 Set numbers: 999

Set contents:

Set No.	Version number
999	07 PO 60 FW Vx.x

Machine data set:

All machine-specific parameters are stored in the machine data set. Switching over the MDS see Chapter ABB Procontic T200 bus inputs, user program segment

Number of sets: 1
 Set numbers: 190

Set contents:

Set No.	Parameters P01-P20
190	see following table: parameters of the machine data set

Parameters of the machine data set:

Parameter No.	Function	Minim. value	Maximum value	Grading	Unit
P01	Kp-Factor	0.01	19.50	0.01	
P02	Software limit switch plus	0	+9 999 999	1	Incr. *
P03	Software limit switch minus	0	-9 999 999	1	Incr. *
P04	Maximum advance feed (Vmax)	0	32 752	1	$\frac{\text{Incr.}}{(1/12.5)\text{s}}$ *
P05	Run-up time (run-up ramp)	10	10 000**	1	ms
P06	Brake time (brake ramp)	10	10 000**	1	ms
P07	Reserved (standard input = 0)				
P08	Brake mode in case of failure: 1 = set value, drag distance error set to 0 2 = process drag distance error 3 = along the brake ramp	1	3	1	
P09	Drift constant	0	9	1	5 mV
P10	Maximum permissible drag distance error	0	32 752	1	Incr. *
P11	Transfer factor	0	3200.0	0.1	
P12	Sensor evaluation single, double or 4-fold		1, 2, 4		
P13	Decimal points	0	4	1	
P14	Run-up and brake characteristic for manual and reference-point operation 0 = linear 1 = sin ²		0 or 1		
P15	Move to reference point 0 = soft reference-point drive 1 = hard reference-point drive		0 or 1		
P16	Reserved (standard input = 0)				
P17	Upper set limit Uw max +	0	+2 047	1	
P18	Lower set limit Uw min -	0	-2 047	1	
P19	Target window	0	32 752	1	Incr. *
P20	Reserved (standard input = 0)				

* for P11 = 0, all other inputs in desired scale

** for P04 > 10 000 (when P11 = 0), otherwise see P04 description

Note: While programming with PC software 935 AM 50 see Chapter PC software 935 AM 50 special features when working with XEDIT

P01 Kp factor:

The Kp factor is a proportional amplification factor, which is formed as the ratio between set speed (Uw) and the difference between the actual position value and the position set value (drag distance error).

At a Kp factor of 1.00, each increment drag distance error equals one step at the D/A converter (Uw) of approximately 5 mV.

Input of values < 0.1 as Kp factor in most cases does not make sense. Between input and display, a rounding error of max. ± 0.01 can occur.

P02/P03 Software limit switches:

By means of the software limit switches, the user can limit the maximum traversing range of the machine.

This applies for positioning sets, tip sets and the operating mode "Manual control".

If the axis reaches a position value of one of the limit switches, the axis stops according to the "brake mode in case of failure" defined in P08 (MDS) and gives the corresponding error message to the operating unit.

When programming zero values for both software limit switches (delivery state), these will not be consulted.

The software limit switches are only consulted after a reference point drive.

A shift of the zero mark by means of the sets N148 to N151 will not influence the software limit switches.

The input value of the software limit switches is dependent on P11.

P04 Maximum advance feed (max. traversing speed):

Due to the 07 PO 60 internal standardization, the maximum traversing speed must always be programmed. The input value for P04 is dependent on P11. The value of Vmax is calculated as follows:

a) For measuring input in increments (P11 = 0):

- nmax → max. motor speed
- Gk → sensor constant
- Aw → sensor evaluation (P12 MDS)
- Ü1 → transfer ratio motor/sensor

$$V_{\max} = \frac{\text{increments detected by 07 PO 60}}{(1/12.5) \text{ seconds}}$$

The factor 1/12.5 results from the 07 PO 60 internal number representation. When projecting it should be taken care that a value > 10 000 is calculated for Vmax (see P05/P06).

Maximum value of Vmax = 32752 incr/(1/12.5) s for P11 = 0.

$$V_{\max} = \frac{n_{\max} \cdot G_k \cdot A_w}{12.5 \cdot \ddot{U}_1} \cdot \frac{\text{incr}}{(1/12.5) \text{ s}}$$

Example:

- nmax = 3000 rev/min = 50 rev/s
- Gk = 1000 incr/rev
- Aw = 4
- Ü1 = 1/1 (e.g. sensor is mounted directly at the drive)

$$V_{\max} = \frac{50 \cdot 1000 \cdot 4}{12.5 \cdot 1} \cdot \frac{\text{incr}}{(1/12.5) \text{ s}}$$

$$V_{\max} = 16000 \frac{\text{incr}}{(1/12.5) \text{ s}}$$

Input Vmax: 16000

b) For measuring input in desired measuring system (P11 ≠ 0):

$$V_{\max} = \frac{\text{distance covered by axis}}{\text{second}}$$

When planning the project it should be taken care that a value > (10000 · 12.5) / P11 is calculated for Vmax (see P05/P06).

$$\text{Max. value: } V_{\max} = 32752 \cdot 12.5 / P11 \text{ mm/s} \\ (\text{for } P11 \neq 0)$$

- nmax → max. motor speed
- Ü2 → transfer ratio motor/axis
- H → leadscrew pitch

$$V_{\max} = \frac{n_{\max} \cdot H}{\ddot{U}_2} \text{ mm/s}$$

Example:

- nmax = 3000 rev/min = 50 rev/s
- Ü2 = 2/1 (motor runs with double speed compared with the axis)
- H = 5 mm/rev

$$V_{\max} = \frac{50 \cdot 5}{2} \text{ mm/s} = 125 \text{ mm/s}$$

Input Vmax: 125

P05/P06 Acceleration and brake ramp:

The acceleration and brake times can be set in a range of 10 ms to 10 sec, provided Vmax has a sufficiently large value (see diagram).

The values entered are valid according to P04 for all positionings, i.e. if the traversing speed of a set is smaller than Vmax, this set speed will be reached faster correspondingly.

Example: P05 = 150 ms, P06 = 200 ms

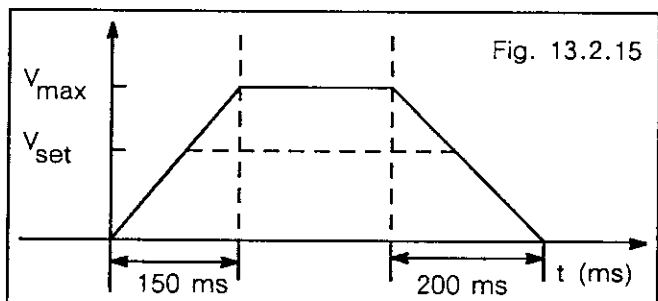

The maximum value of P05 and P06 is dependent on P04 MDS (Vmax) and P11 MDS (transfer factor). If the value of P04 > 10000 (for P11 = 0), values of 10 ms to 10 s can be programmed for P05/P06. If the value of P04 < 10 000 (for P11 = 0), only a correspondingly smaller value can be entered for P05 or P06 (example: P04 = 3999, P11 = 0 => P05/P06max = 3999).

For P11 = 0 (Vmax in incr/(1/12.5)s):

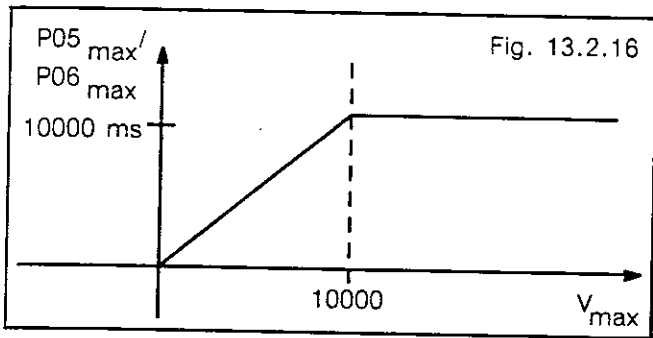

The ramp values can be changed by the PLC (see description of the function Online-change of ramps).

P08 Brake mode in case of failure,

i.e. after "Enable" = 0, pressing of the "Stop" key, releasing of the "Start" key during manual control or after moving to the limit positions.

- 1: Set set value and following error to 0 (immediate, jerky stop of the axis)
- 2: Process following error (the set processing will be aborted and the collected following error will still be traversed (without ramp)).
- 3: Along the brake ramp (the set processing will be aborted, 07 PO 60 will output a brake ramp, the brake ramp and the collected following errors will still be traversed).

If the positioning is aborted in brake mode 1 (e.g. if the "Enable" initiator is set from 1 → 0) as the ABB Procontic T200 bus output "Position reached" is already set, the present actual position is taken over as the new set position of 07 PO 60 (see also Function of the initiator signals).

P09 Drift constant:

By means of the drift constant, the Kp factor can be enlarged for smaller following errors. This guarantees a precise positioning.

P10 Max. permissible following error:

When exceeding the programmed value, the ABB Procontic T200 bus output "Following error" will be set. The value of P10 depends on P11.

P11 Transfer factor:

The transfer factor allows to process position and speed values in any required unit of measurement as well as displaying them (the examples show inputs in mm). If P11 ≠ 0 is programmed, P11 must be placed before Vmax (P04) and all position values.

The transfer factor is defined as follows:

$$P11 = \frac{\text{increments detected by 07 PO 60}}{\text{distance covered by axis}}$$

Gk → sensor constant
 Aw → sensor evaluation (P12 MDS)
 Ü3 → transfer ratio sensor/axis
 H → leadscrew pitch

$$P11 = \frac{Gk \cdot Aw \cdot \ddot{U}3}{H}$$

Example:

Gk = 1000 incr/rev
 Aw = 4
 Ü3 = 2/1 (sensor runs with double speed compared with the axis)
 H = 5 mm/rev

$$P11 = \frac{1000 \cdot 4 \cdot 2}{5} \cdot \frac{\text{incr/rev}}{\text{rev/mm}} = 1600 \text{ incr/mm}$$

P12 Sensor evaluation:

The pulse rate of the incremental position sensor can be evaluated singly, doubly or 4-fold. A change of the resolution will be achieved.

P13 Decimal points:

The number of required decimal points is set via P13.

P13 is only functional, if P11 ≠ 0 and applies for position values only.

P14 Run-up and brake characteristic during manual or reference-point drive:

The acceleration and brake characteristic for "Manual control" and "Move to reference point" is selected by P14.

0 → linearly
 1 → sin² curve

P15 Move to reference point:

When reaching the limit positions or the machine zero mark during the operation "Move to reference point", P15 determines the brake mode (P08) for the 07 PO 60.

0 → soft drive to reference p. (brake mode 3)
 1 → hard drive to reference p. (brake mode 1)

P17/P18 Limits of Uw:

The positive or negative maximum output voltage of the 07 PO 60 can be limited at the set value output (Uw) with P17 resp. P18.

Uw max + = P17 · 4.88 mV
 Uw max - = P18 · 4.88 mV

Example:

P17 = 1000, P18 = -2047 ⇒ -10V < Uw < + 4.88 V

P19 Target window:

If the actual position value of the axis corresponds to the position value \pm target-window parameter, the ABB Procontic T200 bus output target window is set. The input value for P19 depends on P11.

13.2.5.5 ABB Procontic T200 bus interface

The ABB Procontic T200 bus interface of the 07 PO 60 consists of two parts: the ABB Procontic T200 in/output bus gate array and a memory block (FIFO).

The gate array controls the data interchange between the PLC and the 07 PO 60 which is carried out independent of the PLC program (background programs when initializing, configuration test,...).

The FIFO is used by the PLC blocks PO_RD and PO_WR for communication with the 07 PO 60 within the PLC program (transfer of the T200 in/outputs of the 07 PO 60 into the PLC-block in/outputs).

For the PLC, the 07 PO 60 represents a combined EAW4-type in/output. For the user it is only permissible to write into or read these in/output Words (FIFO) by means of the PLC blocks PO_RD and PO_WR, otherwise the communication of the PLC blocks PO_RD and PO_WR will be interfered. This also applies for the test operation!

Note: The floppy disk 907 PB 362 contains a program example for controlling a 07 PO 60 by means of the blocks PO_RD and PO_WR. The program offers the user an example of the synchronization of the set processing with "Set processed", "Start Quit" and "Start State".

13.2.5.5.1 ABB Procontic T200 bus inputs

	Bit No.	Function
First		
E01 *	0 ... 7	Set No. 0H to 0FFH
E02	0 ... 1 2 3 4 ... 5 6 7	Selection of op. modes 0H to 3H Start Teach-in Enable mode 0H to 3H Delete error No. unused
E03	0 ... 7	User program segment 0H to 0FFH
E04	0 ... 7	Override selection 0H to 0FFH
E05	0 ... 7	Override value 0H to 0FFH
E06	0 ... 7	Length compens. select. 0H...0FFH
E07	0 ... 7	Length compensation lowest byte
E08	0 ... 7	Length compensation low-mid-byte
E09	0 ... 7	Length compens. high-mid-byte
E10	0 ... 7	Length compensation highest byte 32 bit dual in B complement
E11	0 ... 7	Reserve word 1 (LB)
E12	0 ... 7	Reserve word 1 (HB)
E13	0 ... 7	Reserve word 2 (LB)
E14	0 ... 7	Reserve word 2 (HB)
E15	0	Reserve bit 1
	1	Reserve bit 2
	2 ... 7	unused
Last		

* Input at the display of the ABB Procontic T200 inputs via the operating unit 35 AB 50

Set number:

- For the selection of the NC set in all external operating modes
- Value range:
0B to 011111111B (0 to 255)

Selection of operating modes:

- Selection of external operating modes.
After powering up or after selection of the operating mode "Ext" of the operating unit, the PLC can select an external operating mode. After the selection of an operating mode, it must be waited until the operating mode is active (see operating modes "Quit"). Only then, e.g. a positioning set can be executed.

Value	Operating mode
0	No external operating mode selected
1	Ext/AE selected
2	Ext/AF selected
3	Ext selected

Start:

- Starting a positioning in all external operating modes and for "Teach In" via PLC.
- Operating modes Ext and Ext/AE:
The NC set selected at the moment is started with a 0 -> 1 change of the start bit. The "Start" bit must represent the value 1 at least until it has been acknowledged by the output "Set executed" or "Start Quit".
The "Start" bit must represent the value 0 at least until it has been acknowledged by the output "Start State".
- Operating mode Ext/AF:
The selected NC set is started with a 0 -> 1 change of the start bit. The programmed subsets are executed as long as start bit = 1 remains set.

Teach In:

- If in the operating mode Extern the Teach-In bit is set from 0 -> 1, then via a 0 -> 1 change of the "Start" bit the present actual value of the axis is taken over as the position set value for the positioning set determined with the set number.
The "Start" bit must have the value 1 for at least 50 ms.

Enable mode:

- The input determines how the 07 PO 60 reacts to a change in the release initiator input.
For description of the enable modes, see chapter "Function of the initiator signals".
- Value range:
0B to 11B (0 - 3)

Value	Mode
0	Enable mode 1 active
1	Enable mode 2 active
2	Enable mode 3 active
3	Enable mode 1 active

Delete error number:

- = 1 -> the error number (see T200 output error number) is deleted (is set to 0).
- = 0 -> the error number is not deleted.
- If the input is set permanently, no error numbers are displayed at the output error number.

User program segment:

- Selection of the user program segment. 4 program segments for NC programs are available to the user

in a memory (EEROM), which is non-resetting on power supply interruptions.

- Within each user program segment, all set numbers listed in the chapter "Set types" are available.
- The user decides with the selection whether the MDS or the flag sets of the newly selected user program segment are to be activated (user program segment selection > 128) or not (user program segment selection < 128).
- By means of the activation of the MDS, a time delay is produced between the user program segment switch-over and the reaction to the first "Start" signal of a set.
- Value range:
0B to 011111111B (0 to 255)

Value	User program segment	
0 to 3	User program segment 1 to 4 active	MDS and flag sets are not activated
4 to 14	07 PO 60 stand. type User program segment 1 active	
	Only when fitted with 32 K x 8 RAM ! Corresponding: User program segment 5 to 15 active	
15 to 127	User program segment 1 active	
128 to 131	User program segment 1 to 4 active	MDS and flag sets are activated
132 to 142	07 PO 60 stand. type User program segment 1 active	MDS and flag sets are not activated
	Only when fitted with 32 K x 8 RAM ! Correspondingly: User program segment 5 to 15 active	MDS and flag sets are activated
143 to 255	User program segment 1 active	MDS and flag sets are not activated

Override selection:

- For the activation of the internal/external speed correction values (override).
- Value range:
0B to 111111111B (0 to 255)

Value	Operating mode
0	No override active
1	External override active
2	Internal override N136 active
3	Internal override N137 active
4 to 255	No override active

Override value:

- Value of the external override
- Value range:
0B to 11111111B (0 to 255)
Internal upper limit is 120

Length correction selection:

- For the activation of the internal/external length correction values and of the scale factor.
The selection of the length correction as well as, if necessary, the external length correction value must be active already on the "Start" of a set.
- Value range:
0B to 11111111B (0 to 255)

Value	Operating mode
0	No length correction value active
1	External length correction value active
2	Internal length correction value N138 active
3	Internal length correction value N139 active
4	Scale factor N140 active
5 to 255	No length correction value active

Length correction value:

- Value of the external length correction
- Value range:
80 00 00 01H to 7F FF FF FFH (B compl.)
Internal limit: -9999999 to +9999999

Reserve E word 1: Value of the start-up ramp for the Online-change of ramps

- Value range:
0...65535 [ms]
0 = Default value
for "Online-change of ramps = OFF"
10...Vmax (not greater than 10000)

Other values will cause an error message (see also the description of the function Online-change of ramps).

Reserve E word 2: Value of the deceleration ramp for the Online-change of ramps

- Value range:
see start-up ramp

Reserve E bit 1:

Reserved

Reserve E bit 2:

Reserved

13.2.5.5.2 ABB Procontic T200 bus outputs

First	Bit No.	Function
A01 *	0	Axis ready for operation
	1	Limit position +
	2	Limit position -
	3	Following error
	4	Position reached
	5	Set executed
	6	Start Quit
	7	Loop executed
A02	0	Dwell time
	1 to 2	Operating modes Quit (0 to 3)
	3	Start state
A03	4 to 7	unused
	0 to 7	Reserved (display = 0, is not transferred to T200)
A04	0 to 7	Machine function bit 0 to 7
A05	0 to 3	Machine function bit 8 to 11 (0H to 3E7H)
	4	unused
	5	Flag 1
	6	Flag 2
	7	Flag 3
A06	0 to 7	8 section flags Bit 0 to 7 -> section flag 1 to 8
A07	0 to 7	Actual pos. value lowest byte
A08	0 to 7	Actual pos. value low-mid byte
A09	0 to 7	Actual pos. value high-mid byte
A10	0 to 7	Actual pos. value highest byte 32 bit dual in B complement
A11	0 to 7	Reserve word 1 (LB)
A12	0 to 7	Reserve word 1 (HB)
A13	0 to 7	Reserve word 2 (LB)
A14	0 to 7	Reserve word 2 (HB)
A15	0 to 7	Error number (LB)
A16	0 to 7	Error number (HB)
A17	0	Reserve bit 1
	1	Reserve bit 2
	2 to 7	unused
Last		

* Input at the display of the ABB Procontic T200 outputs via the operating unit 35 AB 50

Axis ready:

- Will be set to 1 after powering up, provided a 07 PO 60 internal examination run was executed positively.
- Is set to 0, while the enable initiator is 0.

- Shows that the axis is ready for external positioning operation. Will be set to 0 in the operating modes Ext, Ext/AE und Ext/AF, if a positioning has been aborted e.g. by pressing the "Stop" key on the operating unit or by a 1 -> 0 change of the "Enable" initiator and also if an operating mode has been selected via the operating unit.

Limit position +:

- Will be set to 1 as the limit position sensor has been reached (positive drive direction).
- Will be otherwise set to 0.

Limit position -:

- Will be set to 1 as the limit position sensor (negative drive direction) has been reached.
- Will be otherwise set to 0.

Following error:

- Will be set to 0 after powering up.
- Will be set to 1 if the maximum following error defined in MDS (MDS P10) (difference between actual position value and position set value) has been exceeded. Will be set to 0 if the maximum following error has been fallen short of again.

Position reached:

- Is set to 1 as the axis is situated in the target window (MDS P19).
- Will be otherwise set to 0.

Set executed:

- Will be set to 1 after powering up.
- Will be set to 0 if the set has been started and again set to 1 if a set has been executed (internal setpoint selection finished with axis within target window) or after abortion of a positioning with enable initiator = 0 if the enable mode 2 or 3 is selected.

Start Quit:

- Will be set to 0 after powering up.
- Will be set to 1 if a set has been started ("Set executed": 1 -> 0 change).
- Will not be set again to 0 by the 07 PO 60 if the set has been executed.
- Will be again set = 0 (acknowledged) by the PLC (PLC block PO_RD).
- At the output "Start Quit", the user can recognise the execution of short sets (set execution time < PLC cycle time), even if the output "Set executed" after the "Start" of the short set again takes up the state 1 before the PLC has recognised "State" executed" = 0.
- Thus the output "Start Quit" should always be evaluated in addition to "Set executed".

Loop executed:

- Will be set to 1 after powering up.
- Will be set to 0 if a loop set has been started. Will be again set to 1 if the loop has been processed or after the abortion of a positioning via a enable initiator change 1 → 0 if the enable mode 2 or 3 is selected.

Dwell time:

- Will be set to 1 after powering up.
- Will be set to 0 after the start of a set. Will be set to 1 again after the execution of a set and after the programmed dwell time has passed or after the abortion of a positioning via a enable initiator change 1 → 0 if the enable mode 2 or 3 is selected.

Operating modes quit:

- Acknowledging the presently active operating mode:
Will be set to 0 after powering up.

Value	Operating mode
0	No external operating mode active
1	Ext/AE active
2	Ext/AF active
3	Ext active

Start state:

- Reflects the 07 PO 60 internal state of the T200 input signal Start to the T200 outputs as an external operating mode of 07 PO 60 is active.
 - Will be set to 0 after powering up.
 - Will be set = 0 again after a leaving of the external operating mode.
 - The output allows the user to ensure that in case of PLC programs with a cycle time < 10 ms, 07 PO 60 can evaluate the 1 → 0 edge of a Start signal.
 - Therefore, the output should always be evaluated in addition to "Set executed".

Machine function:

- After powering up, all machine function bits will be set to 0.
- The programmed machine function is output in a binary value.

- Sign of the machine function positive:
 - The machine function is output after a set processing with "Set executed".
- Sign of the machine function negative:
 - The machine function is output at the start of a set.
- If the machine function value has been entered as 1000, in this set no machine function is output.
- The output of a machine function overwrites the previous one.
- Value range:
0_H to 03E7_H (0 to 999)

FLAG 1:

- The flag output will be output in dependence on the position set value (set N144) stored in the program and the position value of the axis. After switching-over of the user program segment, note information within user program segment description.
- Positive flag position value:
 - If the axis drives over a flag position in the positive direction, the corresponding flag will be set. If the axis drives over a flag position in the negative direction, the corresponding flag will be reset.
- Negative flag position value:
 - If the axis drives over a flag position in the negative direction, the corresponding flag will be set. If the axis drives over a flag position in the positive direction, the corresponding flag will be reset.

FLAG 2:

- Flag position 2 (N145): for description, see FLAG 1.

FLAG 3:

- Flag position 3 (N146): for description, see FLAG 1.

8 section flags:

- Will be set to 1 after powering up.
- After the start of the positioning set, all section flags will be set to 0.
- After covering of each 1/8 of the traversing distance of the set, one section flag will be set to 1 again.

- 1/8 → section flag 1 = 1
- 2/8 → section flag 1 and 2 = 1
- 3/8 → section flag 1 to 3 = 1
- 4/8 → section flag 1 to 4 = 1
- 5/8 → section flag 1 to 5 = 1
- 6/8 → section flag 1 to 6 = 1
- 7/8 → section flag 1 to 7 = 1
- 8/8 → section flag 1 to 8 = 1

After the abortion of a positioning, all section flags are again set = 1 via a enable initiator change = 0 in enable mode 2 or 3.

Actual position value:

- The actual position value of the axis in absolute measurement referring to the reference point
- Value range:
80 00 00 01H – 7F FF FF FFH (B compl.)

Reserve A word 1:

- Reserved

Reserve A word 2:

- Reserved

Error number:

- Display of the 07 PO 60 error numbers:
 - Will be set to 0 after powering up.
 - The output of an error number overwrites the previous one.
 - Deleting the output (= setting to 0), see T200 input delete error number.
 - Error number 0FFFFH means: 07 PO 60 could not identify an error message.

Reserve A bit 1:

- Reserved

Reserve A bit 2:

- Reserved

13.2.5.5.3 Display of ABB Procontic T200 bus in/outputs and of the initiators

By means of the operating unit, the present state of the ABB Procontic T200 bus in/outputs and the initiators can be displayed (e.g. during the commissioning).

For this purpose, an operating mode (except "Manual entering of data") must be selected.

E00:

7	6	5	4	3	2	1	0
			Reserve input	Ref.-point init.	limit posit. neg. init.	limit posit. pos. init.	En-able init.

E01 ... E15:

Display of ABB Procontic T200 bus inputs byte 1 to byte 15 (see overview ABB Procontic T200 bus inputs).

A01 ... A17:

Display of ABB Procontic T200 bus outputs byte 1 to byte 17 (see overview ABB Procontic T200 bus outputs).

13.2.5.6 Function of the Online-change of ramps

The user is enabled to preset both the start-up ramp and the deceleration ramp for positioning functions by means of the T200 user program.

Presetting the ramp values

Presetting the ramp values is carried out with the PO_WR PLC function block:

- Reserve input word 1: Start-up ramp
- Reserve input word 2: Deceleration ramp

Evaluation/adoption of the ramps

After the ABB Procontic T200 has been switched on, the 07 PO 60 works with the ramps which are programmed in the machine data set (MDS P05/P06). The first adoption of the PLC ramps is performed when one of the reserve input words at PO_WR ≠ 0.

The evaluation of the ramp values is only performed if the numerical value of at least one of the ramps (reserve input word 1 or 2) has changed since the last NC set 'Start'.

The ramp values preset by the PLC will not be programmed in the EEPROM. They will not be stored after switching off the supply voltage of the ABB Procontic T200.

The ramp values are adopted and processed by the 07 PO 60 with the next NC set 'Start' (0->1 edge of the start signal at PO_WR or START key on the 35 AB 50 operating device).

Using subsequent block operating modes, the ramps are always adopted with the start of a sequence.

If loop sets are executed, the ramps are adopted with the start of the loop set.

The 07 PO 60 internal processing of the ramps causes a start delay of the positioning procedure of ca. 30 ms per change of ramp values.

Value ranges of the ramps

All values contained in the 07 PO 60 module description can be preset as ramp values (MDS parameter P05/P06 = start-up and deceleration ramps, 10 ms ... 10000ms, if Vmax > 10000 and MDS P11 = 0).

If a ramp value is beyond the admissible numerical range, an error message (50...53) is generated at the error number output of the PO_RD function block and also sent via the 35 AB 50 operating device.

The error display at PO_RD can be acknowledged by means of the PO_WR input 'delete error number'.

Both ramp values have always to be within the valid numerical range. Otherwise an error message is output and the 07 PO 60 continues processing using the the formerly valid values.

A NC set is not carried out, if it has output an error message. In order to start a NC set again, a new 0->1 edge is necessary at the 'Start' input.

If at least one ramp has been changed to an invalid numerical value, the error display is output only once.

Note:

In an existing installation, an 07 PO 60 R101 module can be replaced by an 07 PO 60 R201 module without any PLC program modification/NC program modification, provided that the reserve input words 1 and 2 of the PLC CE PO_WR are set to 0 (as defined in the description of the 07 PO 60 module).

If the reserve input words 1 and 2 of the PLC CE PO_WR are not 0, the current values of these words are interpreted by the 07 PO 60 R201 as ramp set values, i.e. that the axis accelerates or decelerates faster or slower than it did when the 07 PO 60 R101 was used.

13.2.5.7 Function of initiator signals

Limit position initiators (closed circuit system):

- If a 1 -> 0 signal change occurs at one of the limit-position initiator inputs, the 07 PO 60 brakes according to the "brake mode in case of failure" (MDS P08).
- The LED "Limit position reached" lights up.
- On the display of the operating unit and on the ABB Procontic T200 bus outputs, the corresponding error message appears.
- If the limit positions are not needed, the limit-position initiator inputs are to be tied to +24V (UP1). The +24V (UP1) needed for this should be tapped from PIN4 on the screw-type terminal block.
- Leaving the HW limit positions is only possible in the operating modes "Move to reference point" and "Manual control", as well as in the operating mode "Ext".

Reference point initiator (operating current system):

- If during a movement to a reference point a +24V level is applied to the reference point initiator input, the 07 PO 60 sets its internal actual-position-value counters to 0.
- The LED "Move to referece point" lights up.

- By a software routine it is ensured that the reference point is always approached from the same direction (corresponding to the reference point set number), independently of the position of the axis at the "Start" of "Move to reference point". The precondition for this function is that the limit position initiators are active. The reaction to the limit position initiator is dependent on P15 (MDS). In correspondence to the state of P15, after the detection of the reference initiator either a braking and a positioning back (P15 = 0, soft reference point drive) will be carried out or a jerky braking (P15 = 1, hard reference point drive).
- Care has to be taken that the reference cam for the damping of the reference point initiator should at least have the length of the distance covered by the axis during a position sensor rotation (because of the sensor zero trace pulse).

Mounting the initiators:

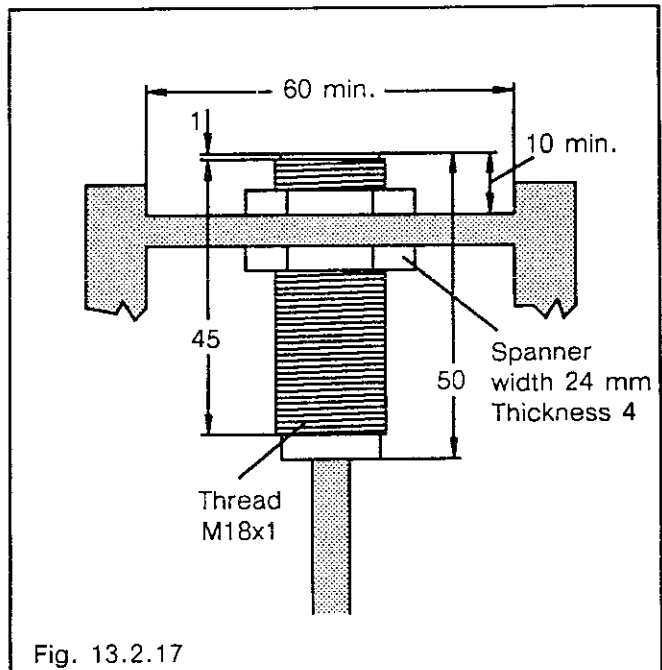

Fig. 13.2.17

Enable initiator:

If the enable initiator input is switched off, starting a positioning is not possible. The corresponding error message (ERROR 20) is shown on the display of the operating unit.

Three enable modes can be selected via the ABB Procontic T200 bus input "Enable mode".

Enable mode 1:

- If the enable initiator is set to 0 (1 -> 0 change) as the axis is being traversed, the axis afterwards will stop according to the "Brake mode in case of failure" programmed in "MDS" P08. After the enable initiator is switched on again, the interrupted set can be continued with a renewed "Start".

- If the enable initiator is set to 0 (1 → 0 change), as the output "Set executed" is = 1 (positioning finished) and the "brake mode in case of failure" has been selected, the present actual position value is taken over as the new position set value.

Enable mode 2:

- As enable mode 1, but after the interruption of the positioning via a 1 → 0 change of the enable initiator, the partly processed set will be aborted.
- The following ABB Procontic T200 bus outputs are reset to their original positions (after powering up) via a 1 → 0 change of the enable initiator:

```

"Position reached" = 1
"Target window"   = 1
"Set executed"     = 1
"Loop executed"    = 1
"Dwell time"       = 1
"8 section flags" = 0FFH
"Following error"  = 0

```

The present actual position value is taken over as the new position set value. After a new switching on of the enable initiator and an renewed "Start", a new selected set will be started.

Enable mode 3:

- As enable mode 2, but, as long as the enable initiator indicates the value 0, the position control of the 07 PO 60 is inactive. The 07 PO 60 internal actual-position-value counters remain active.

13.2.5.8 Software versions

Presently available software versions:

```

Module version: R0101
SW version:     V1.0
Modifications: Note: V 1.0 is the first version

```

```

Module version: R0201
SW version:     V1.3
Modifications: Online-change of ramps was
                added

```

The number of the software version can be checked in the operating mode "Manual entering of data" by calling up the set N999.

13.2.5.9 Interface protocols

General:

The data interchange between the 07 PO 60 and the operating unit 35 AB 50 or a PC is executed half duplex.

The 07 PO 60 supports five kinds of telegrams:

- Reset telegram
- Display telegrams
- LED telegrams
- Key telegrams
- DNC telegrams

After powering up, the operating unit 35 AB 50 informs the 07 PO 60 that it is ready for operation using the reset telegram.

Display telegrams are sent from the 07 PO 60 and are alphanumerically displayed on the operating unit 35 AB 50.

The 07 PO 60 uses LED telegrams to turn on or off the LED of the operating-mode keys on the operating unit 35 AB 50.

Key telegrams are sent by the operating unit 35 AB 50. They inform 07 PO 60 when a key on the operating unit is pressed. Using the key telegrams, the user can simulate the operating unit via a PC.

Using DNC telegrams, the user or the PC software 935 AM 50 can transfer NC sets.

Setting the serial interface:

```

RS422/RS232: can be set according to
               requirements
               (see chapter settings)
Data format:  8 data bit + parity even
Character set: ASCII
Baud rate:    2400 baud

```

Information:

Die 24V power must always be supplied, even if only the DNC operation is running.

Control characters:

ASCII Value	Char.	Meaning
02H	STX	Telegram start
03H	ETX	Telegram end
05H	ENQ	Request to receive
06H	ACK	Ready to receive and positive acceptance of reception
0AH	LF	Deletes display, cursor remains in position
0DH	CR	Cursor is positioned on the first display sign
11H	XON	Continuation of transfer after interruption with XOFF
13H	XOFF	Interruption of the transfer
15H	NAK	Not ready to receive and negative acceptance of receipt
18H	CAN	Deletes a not yet complete display control function
1AH	SUB	Interpreted as per CAN
18H	ESC	Introduces display contr. function
7FH	DEL	Rub out

General telegram frame:

In order to communicate with the 07 PO 60, the following telegram frame must be met:

- The sending station asks through cyclic sending of ENQ (in control time rhythm) the other station to receive and starts a sending time watchdog simultaneously.
- If this is ready to receive, it acknowledges the request with ACK. If it is not ready to receive, it acknowledges the request with NAK. In the case of a negative acknowledgement, the sender must begin the telegram interchange from the start.
- After the positive acknowledgement of the request, the sending station transfers a telegram which begins with STX, contains a maximum of 512 text characters and ends with ETX.
- During the text transfer, the receiving station can interrupt it with XOFF. The receiving station must be able to receive at least eight additional characters after the receipt of XOFF. It enables the transfer with XON again.
- The sending station expects a positive acknowledgement from the receiving station with ACK after sending the ETX.
- If the sending station receives this acknowledgement during the control time period, the transfer of the telegram is finished.
- If the sending station does not receive this acknowledgement during the control time period or receives a negative acknowledgement with NAK, the telegram is not transferred and the sending station must begin the transfer from the start.

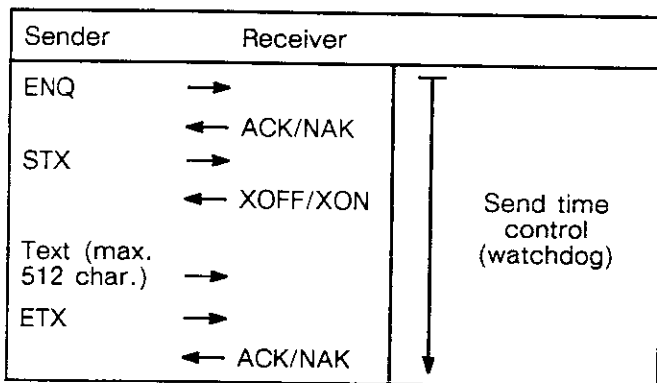

General telegram format:

The telegram has the following structure:

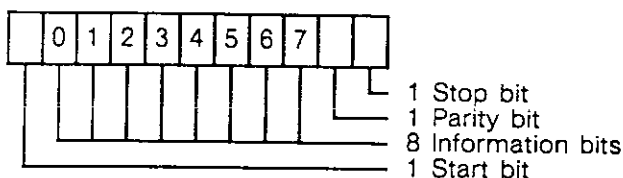

Reset telegram

After powering up the operating unit 35 AB 50, it informs the 07 PO 60 of its readiness to operate using the reset telegram. In the DNC mode, the transfer of a reset telegram is not necessary. The 07 PO 60 starts automatically and sends a text telegram with the message "07PO60 READY".

Telegram format:



Display telegrams:

The following telegram is used for the display on the operating unit 35 AB 50:

Telegram format:

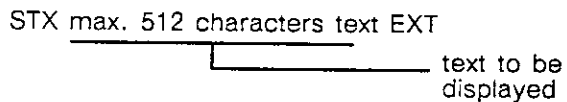

The range of characters which can be displayed includes the ASCII characters 20H to 5FH.

The first character of a display telegram must not be a telegram code (T, I, C, D).

The following ASCII characters can form part of a text display telegram. They influence the display but are not displayed.

- LF Deletes the display, the cursor remains at the same position.
- CR Moves the cursor to the first display character.
- DEL (Rub out) Moves the cursor to the left by one character and deletes this character.

Using Escape sequences, further display influences can be caused:

- ESC [Pn C Moves the cursor by n characters to the right (default = 1).
- ESC [Pn D Moves the cursor by n characters to the left (default = 1).
- ESC c Initiates power-up reset of the display controller.
- ESC # 8 Shows all display segments brightly, the cursor position is not changed. An ESC sequence which has not been transferred completely can be cancelled with the ASCII sign CAN or SUB.

LED telegrams:

A LED telegram informs the operating unit 35 AB 50 that a LED (in an operating mode key) is to be turned on or off.

Telegram format:

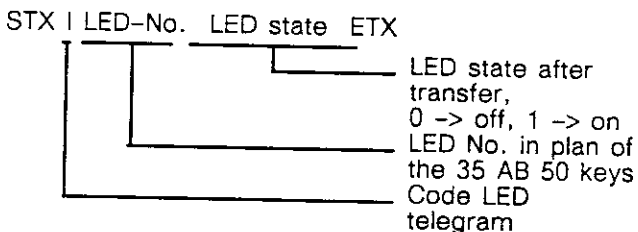

If a LED number is unknown to the operating unit, the telegram will be ignored without any reaction.

Key telegrams:

Key telegrams inform the 07 PO 60 when keys of the operating unit 35 AB 50 are pressed.

Telegram format:

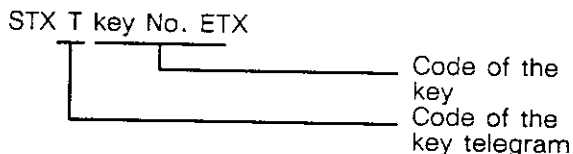

Plan of the keys with key numbers:

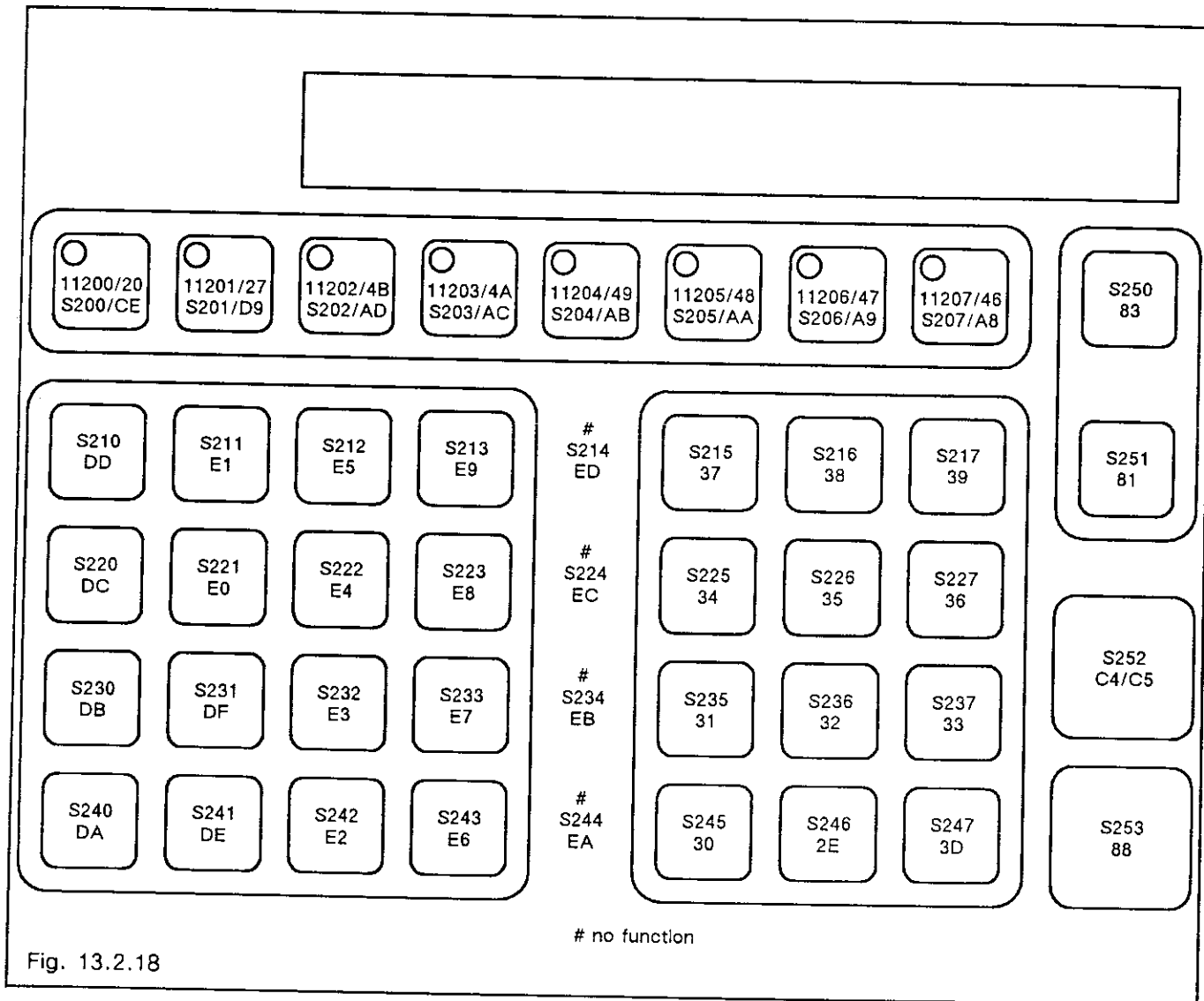

Fig. 13.2.18

DNC telegrams:

With a DNC telegram, the PC causes the 07 PO 60 to execute a DNC function. The 07 PO 60 executes the DNC function and answers, if necessary, with a DNC response message.

The transfer of a DNC telegram is permissible only when the axis stands still (exception: reading actual

position value). During process of the DNC telegram, the 07 PO 60 allows no further telegrams.

If an error is detected in the interpretation or the process of a DNC telegram, the 07 PO 60 releases an ERROR message.

Only after the acceptance of this ERROR message by the PC does the 07 PO 60 allow further telegrams (from the PC).

Telegram format for DNC telegrams between PC and 07 PO 60:

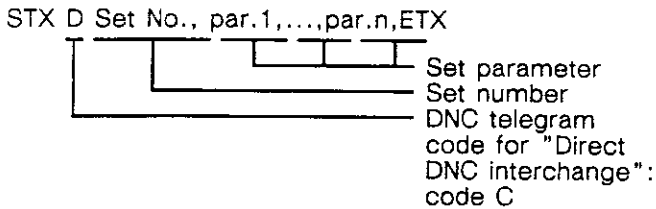

The set number determines which DNC function is executed.

After the set number and after each parameter, a comma must be transferred.

If a programmed parameter is not to be altered, its transfer can be left out. In this case, 2 commas one after another are transferred.

After the last parameter to be altered, only a comma must exist. Further commas are not necessary.

Programming the NC set:

Using a DNC telegram, all 07 PO 60 NC sets can be programmed (altered).

For this purpose, a DNC telegram with the corresponding set number and the parameters to be altered is transferred to the 07 PO 60.

Set number: 0...190

Example, positioning set:

Set number: 20
 Incr./ABS: Incr. (see code byte)
 Position: + 1234567 Incr./(1/12.5) s
 FEED: should remain unaltered
 DWELL: 2.0 s
 MFKT: 123
 N+1: should remain unaltered

STX, 1, +1234567.,20,123, ETX
 └──────────────────┬────────── see code byte

Coded telegram:

02 44 30 32 30 2C 31 2C ... 2C 03

Code byte:

Each positioning set contains a code byte.

The code byte contains the information whether the position set value of a set is to be approached incrementally or absolutely and whether it is to be traversed with linear or \sin^2 shaped ramps.

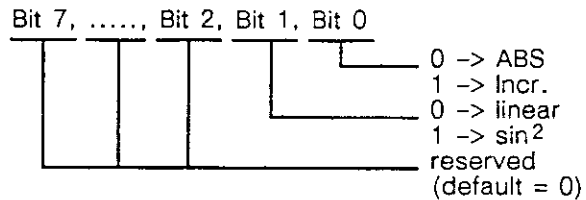

RAM operation:

If the user program is to be altered very quickly or very often in the DNC operation, the user can select the RAM operation by means of a NC set list.

The RAM operation is possible for positioning sets and for the machine data set.

If the RAM operation is selected for a NC set, it will after the transfer in DNC mode be stored in the working memory (RAM) of the 07 PO 60 and not programmed into the EEPROM, which is non-resetting on power supply interruptions. The NC set with the same set number in EEPROM will be ignored and, after the RAM operation has been selected for this set, no longer altered. The user selects the RAM operation by transferring a NC set list to the 07 PO 60. All NC sets not listed in the NC set list are processed as before (from the EEPROM).

The 07 PO 60 NC program can be mixed from sets for which the RAM operation was selected and from sets for which the RAM operation was not selected. The RAM operation does not depend on operating modes like automatic single set and automatic subset.

After powering down the 07 PO 60, the NC set list as well as all NC sets connected to RAM are deleted. The NC set list can contain a maximum of 80 NC set numbers. A maximum of 20 NC set numbers can be transferred per DNC telegram. If the NC set list is longer than 80 set numbers, the set numbers which were first transferred will be deleted from the list.

The transfer of the set number 255 into the NC set list shows the 07 PO 60 the end of the NC set list.

Example, RAM operation:

- Transferring the NC set list (here in two parts).

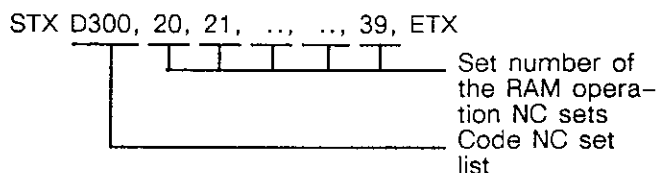

STX D300, 40, 41, ..., 58, 190, ETX

- Transferring a complete positioning set (see also NC set programming).

STX D20,1, +1234567, 5000, 20, 123, 21, ETX

- Altering a set parameter (here: position set value) of the positioning set which is stored in the RAM.

STX D20., +2345678, ETX

Reading out the NC set:

With the following telegram, the 07 PO 60 is forced to give out all NC sets from N0 to N190 of the selected user program segment.

The 07 PO 60 characterizes the end of the output of the NC sets through a telegram with the contents "D222".

The telegram to be transferred:

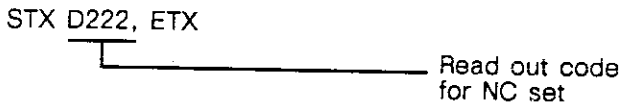

With the following telegram, the 07 PO 60 is forced to give out an individual NC set of the selected user program segment.

The 07 PO 60 characterizes the end of the output of the NC set through a telegram with the contents "D222".

The telegram to be transferred:

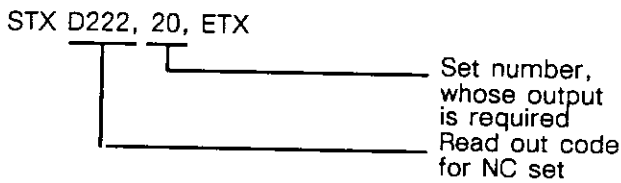

Direct DNC interchange:

By means of the following DNC telegram, a positioning set can be transferred (also in parts) and started immediately (without PLC "Start" signal). Even reference point drive sets can be transferred and started in "Direct DNC interchange".

The telegram to be transferred:

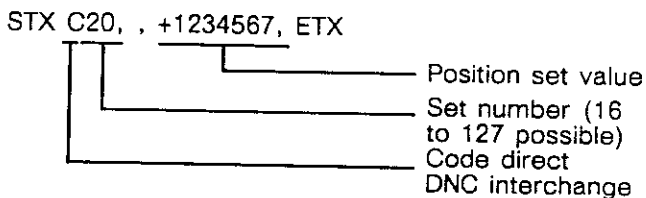

Function:

- The position set value and further parameters are stored in EEPROM (RAM).
- The NC set is executed.
- After the receipt of the DNC response message (see below) through the PC, a new DNC telegram is possible. I.e. during the positioning, no transfer of telegrams to the 07 PO 60 is possible.
- Mistakes which occur in the positioning are passed on as ERROR messages to the PC.
- A positioning set which was interrupted e.g. with the enable initiator can not be continued at the interrupted stage (new selection by "Direct DNC" operation means renewed execution of the set).

Acknowledgement of the 07 PO 60 after execution of the positioning set at the reference point drive set:

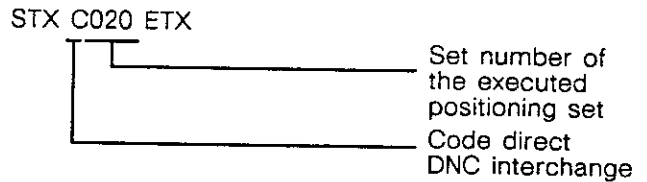

Reading out the actual position value by DNC:

By means of the following DNC telegram, the actual position value of the 07 PO 60 referring to the machine reference point can be read out:



Examples for the response message of the 07 PO 60:

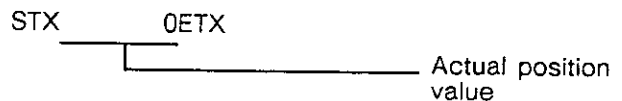

13.2.5.10 Error messages

No.	Error
4	No subset
5	No set type
6	Loop depth exceeded
7	Positioning set necessary
8	Positioning set depth greater than 2 (with set "Flying overdrive")
9	Dummy initialization is active, axis cannot be traversed, new start possible only after voltage interruption or reset
10	Loop interrupt - no subset
11	Selection of manual traversing set not permitted in this operating mode
15	Check sum in 07 PO 60 program memory does not match (system error)
20	Enabling missing (enable initiator)
21	Positive limit position reached
22	Negative limit position reached
23	Both limit positions reached simultaneously
24	Reference counter overflow
25	Different directions selected (with set "Flying overdrive")
30	Selected traversing direction not possible
31	SW limit switches positive and negative are reached simultaneously
32	SW limit switch "positive" reached
33	SW limit switch "negative" reached
40	Check sum in EEPROM does not match
41	EEPROM cannot be programmed
42	
43	
44	
50	Brake ramp limit reached (brake ramp too high or Vmax too low)
51	Brake ramp not within range (time range 10 ms to 10000 ms)
52	Start-up ramp not within range (time range 10 ms to 10000 ms)
53	Start-up ramp limit reached (Umax too low or acceleration time chosen too high)
63	KV factor negative
64	Start-up ramp negative
65	Brake ramp negative
66	Target window negative
67	Brake mode negative
68	Drift constant negative
69	Sensor evaluation not 2 or 4
70	Upper limit value negative
71	Lower limit value negative
72	Position control difference negative
73	Divisor negative
74	Maximum speed sign negative
75	Maximum following error sign negative
76	Brake mode not 1, 2, 3
77	Run-up and brake ramp generation not clear
78	Transfer factor sign not positive
79	Decimal place choice does not fall within 0 to n comma - 3 parameters
102	On checking parameter range limits, it was found that they were exceeded
103	At this moment no operating mode change possible
104	Operating mode selection is missing

No.	Error
105	No set has been selected yet
106	Selected set not implemented
107	Teach-in not possible, selected set does not contain set value
108	Selected function meaningless at this stage
109	Parameter key only meaningful in connection with machine data
110	Selected set contains no set value
111	Selected set contains no machine function
112	Selected set contains no dwell time
113	Selected set contains no feed
114	Selected set contains no zero position
115	Set contains no parameters
116	Set contains no loop set
117	At the moment, no change in traversing direction possible
118	Decimal keys without function at this time
120	Machine parameter with this number does not exist
125	Selected set contains no possible subset
126	Selected function key is meaningless
127	Start key in this operating mode ineffective
128	Decimal keys meaningless at this moment
129	Selection of a set not to be enabled in automatic operation
130	Selection of a set not available to PLC
131	Selection of a set during set processing not possible
202	Start signal not allowed at this moment
203	PLC selected set not permitted in this operating mode
204	Teach-in requirement despite ongoing set processing
205	Teach-in requirement despite ready for operation signal = 0
206	Teach-in requirement although ready for operation signal meanwhile removed
207	Selected set is not suitable for Teach-in
DNC error messages	
300-380	See error description, errors 00 to 80
393	Invalid set number for direct DNC interchange
394	Display buffer is not empty (system error)
395	Set not enabled
396	Limits exceeded (e.g. forbidden parameters)
397	Comma missing after set number
398	Positioning set still not completely processed (no start possible)
399	Wrong operating mode selection

13.2.6 Application information

Dialog cable 07 SK 65: (Fig. 13.2.22)

13.2.6.1 System cables

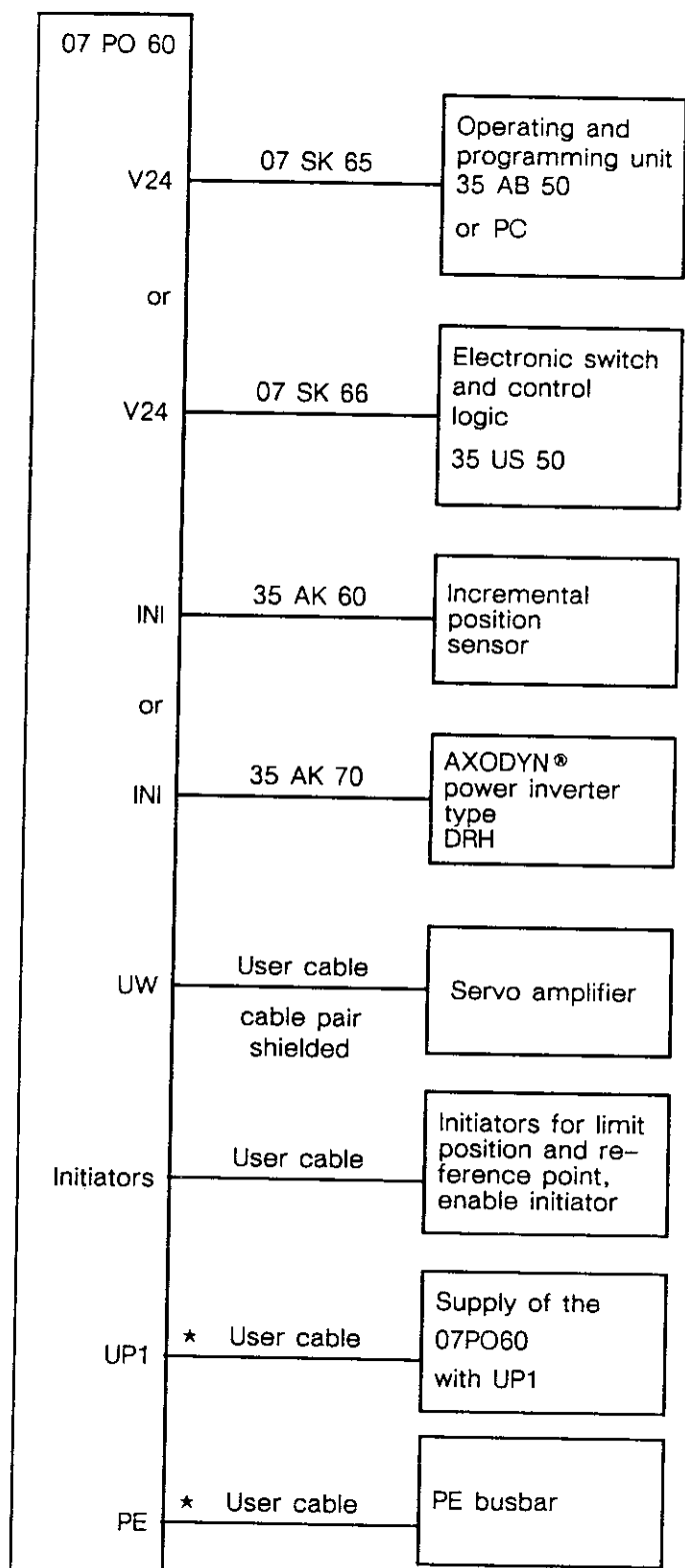

* Earthing and wiring concept
note chapter 13.2.6.2

Fig. 13.2.21 Application of the different system cables

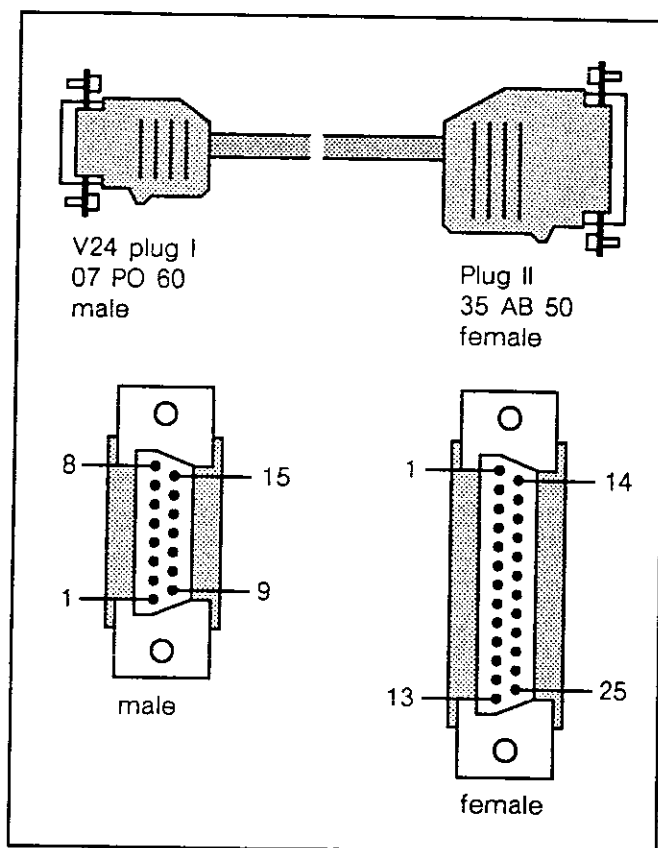

Plug I 07 PO 60		Plug II 35 AB 50 or PC		Meaning
Pin	Signal	Pin	Signal	
1	PGND	1	PGND	protective ground (cable shield)
2	/TxD	3	/RxD	inverted RxD
3	/RxD	2	/TxD	inverted TxD
		4	}	wire bridge
		5		
		6	}	wire bridge
		20		
7	SGND	7	SGND	signal ground
9	TxD	21	RxD	receive data
10	RxD	18	TxD	transmit data
12	+24V	10	+24V	UP1
14	0V	9	0V	ZP1

Do not plug in or unplug while power supply is switched on. If the operating and programming unit 35 AB 50 is not fixed, the system cable 07 SK 65 is to be connected firmly to the operating unit.

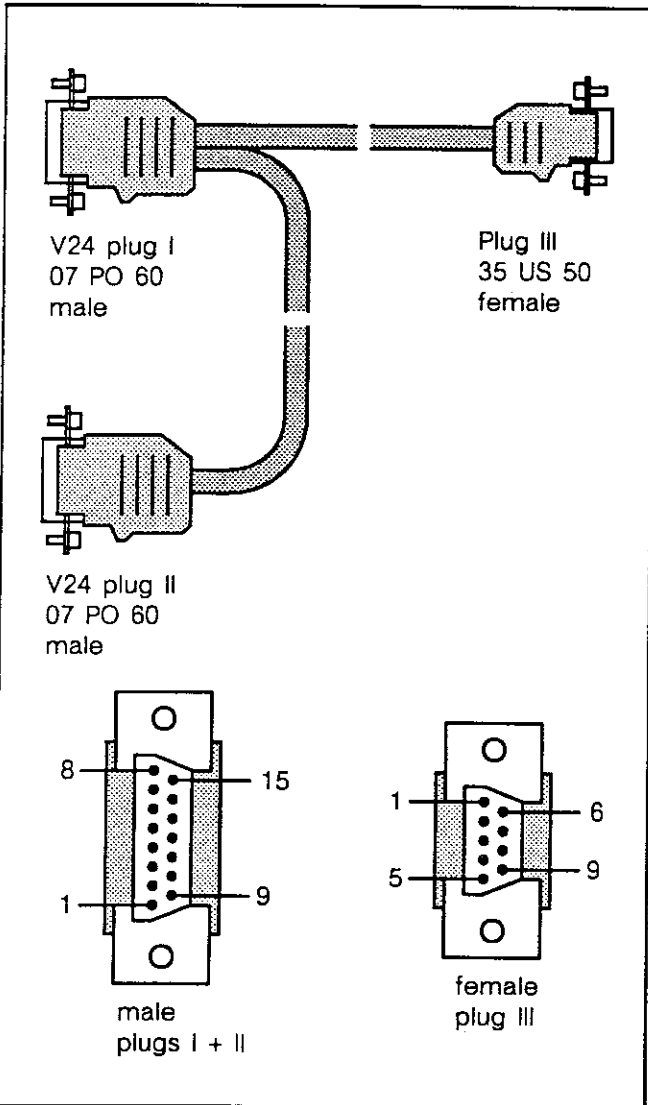

The cable 07 SK 66 connects two 07 PO 60 units to the electronic switch and control logic 35 US 50.

The unit 35 US 50 offers the possibility of operating and programming up to six 07 PO 60 units using one operating unit 35 AB 50 or one PC.

The description for the unit 35 US 50 is included in the AXUMERIK®m system description.

The plugs must not be plugged in or unplugged while power supply is switched on.

Plug II 07 PO 60 2. unit Pin Signal	Plug I 07 PO 60 1. unit Pin Signal	Plug III 35 US 50 Pin Signal
		1 PGND (shield)
	10 RxD	2 1 TxD
	3 /RxD	3 1 /TxD
	9 TxD	4 1 RxD
	2 /TxD	5 1 /RxD
10 RxD	15 *	6 2 TxD
3 /RxD	11 *	7 2 /TxD
9 TxD	13 *	8 2 RxD
2 /TxD	8 *	9 2 /RxD

* These plug terminals are used only as soldering terminals connecting signals between plug III and plug II.
At V24 interface of 07 PO 60 these terminals have no connection (NC).

Position sensor cable 35 AK 60 for incremental sensor:
(Fig. 13.2.25)

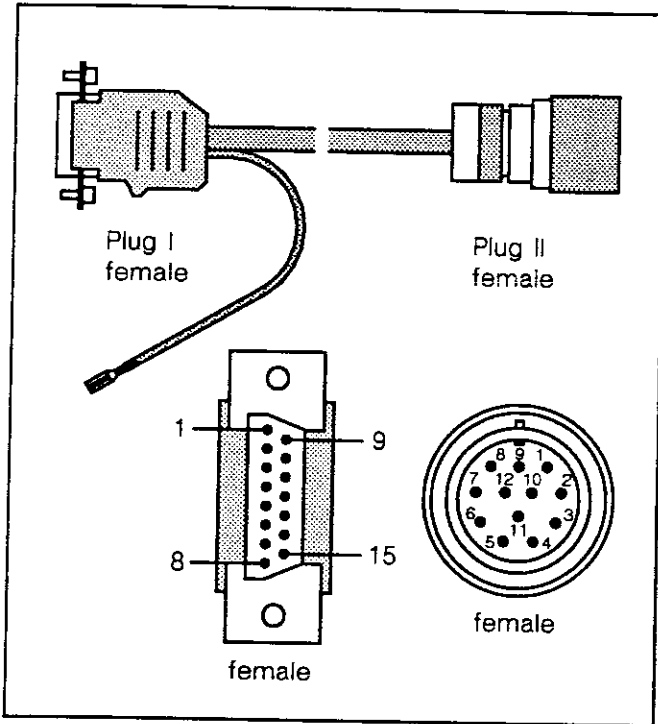

Position sensor cable 35 AK 70 for AXODYN® DRH power inverter: (Fig. 13.2.26)

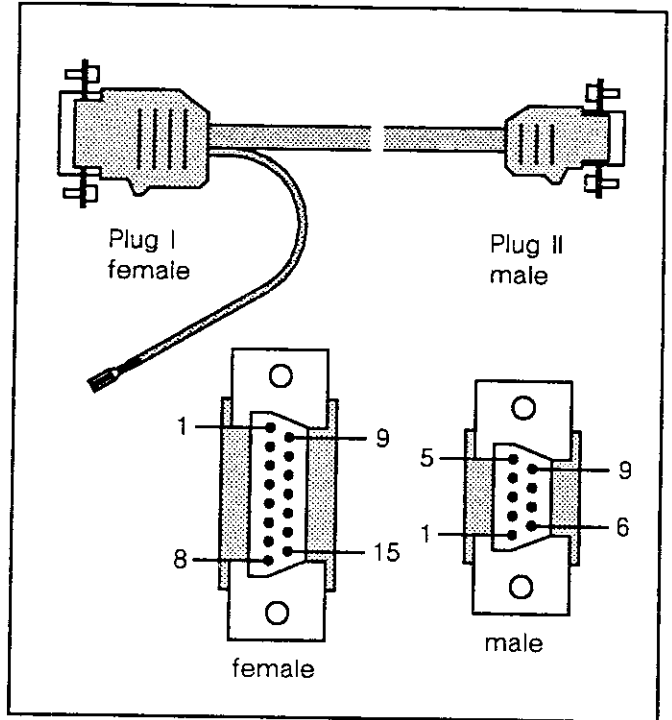

Plug I for 07 PO 60	Plug II for sensor	Core colour	Signal
conducted outward			Shield
8	5	pink	Trace A
9	6	redblue	Trace /A
10	8	violet	Trace B
11	1	greypink	Trace /B
13	3	black	Zero trace C
12	4	red	Zero trace /C
14		blue	Reserve
2	12	white	+5V/+15V/ext.*
7	2	grey	+5V/+15V/ext.*
3	10	brown	0 V
4	11	green	0 V
5		yellow	0 V

* For sensor supply, see settings chapter 13.2.4.3

Trace /A = trace \bar{A}

Do not plug in or unplug while power supply is switched on.

Plug I for 07 PO 60	Plug II for AXODYN®	Core colour	Signal
conducted outward	4		Shield
8	6	pink	Trace A
9	1	redblue	Trace /A
10	7	violet	Trace B
11	2	greypink	Trace /B
13	8	black	Zero trace C
12	3	red	Zero trace/C

Do not plug in or unplug while power supply is switched on.

Sensor interface DV3001:

The position sensor interface can be used optionally with the isolating module DV3001 (ABB drive technique).

The connection is installed according to the following table:

Plug on 07 PO 60 side	Plug PG DV 3001	Signal
conducted outward	4	Shield
8	6	Trace A
9	1	Trace /A
10	7	Trace B
11	2	Trace /B
13	8	Zero trace C
12	3	Zero trace /C
2	5	+ 5 V
4	9	0 V

Not in stock.

13.2.6.2 Earthing, wiring and shielding concept

Refer to ABB Procontic T200 project planning

Construction and wiring arrangement:

- During the installation in the control cabinet, a division into the power section and the control section is to be carried out.
- In order to limit interference, the 24V supply cables for the electronic modules and the interface cables (cables for position sensors, operating units, set values and initiators) must not be laid into the same cable ducts as switched cables to inductive loads (relays, brakes, valves, motors etc.).
- All relays, brakes and valves have to be equipped with interference suppressors (RC elements, free-wheeling diodes etc.)
- In order to achieve a good equipotential bonding between the individual components, a PE busbar is to be installed as close as possible to the units. The PE busbar should be arranged so that the earth wires are as short as possible everywhere (from all units to PE) (< 0.5 m – 1 m).
- The earthing conductors of the individual units must have a cross section of 6 mm² (the 07 PO 60 PE terminal on the screw-type terminal block is to be connected by a 2 · 2.5 mm² wire to the PE busbar).

+24V electronic power supply unit and 0V busbar:

- A separate electronic power supply unit is to be provided for the 24V power supply (UP1) of the 07 PO 60 and of the 35 AB 50 as well as of the PLC in/output

modules. No loads as relays, brakes, valves etc. must be supplied from this unit.

- The 0V terminal of the separate electronic power supply unit is connected to a 0V busbar. The 0V terminals of the 07 PO 60, of the PLC in/output modules and of other loads, but not of relays, brakes or valves for the 24V network, are also connected to the 0V busbar. The latter is connected to the PE busbar by a short 6 mm² wire.
- All 0V wires to the individual units should be as short as possible and, if possible, have a cross section of 4 mm².
- The 0V terminal (to UP1) of the 07 PO 60 units (screw-type terminal 3) is connected to the 0V busbar by a 2.5 mm² wire. The 24V terminal UP1 (screw-type terminal 4) is connected to the electronic power supply unit by a 2.5 mm² wire.
- The initiators (limit positions) are supplied directly by the UP1 power supply unit (0V terminal on 0V busbar), and only the signal terminals are connected to the 07 PO 60 (initiator terminals).

07 PO 60 with AXODYN® three-phase-current drive amplifiers of the DRH/DPH types:

The following earthing and wiring concept correspondingly applies for other drive amplifiers, too.

An isolating module with optocoupler can be received as an option for the DRH/DPH drive amplifiers. The code "Sensor interface DV 3001" is its reference at the sales responsible for the drive amplifiers.

Serial interface (V24):

The shield connection is installed on the 07 PO 60 side and on the side of the operating unit at PIN 1 of the respective plug. With 35 AB 50, the shield is grounded via a capacitor to the Protective Ground internally.

Set value interface (Uw):

The shield connection is installed on one side, on the 07 PO 60 side at PIN 10 of the screw-type terminal (signal name: shield).

Position sensor interface (INI):

The shield connection is installed on the 07 PO 60 side to PIN 10 of the screw-type terminal (signal name: shield) by the shield cable leading out of the plug terminal of the 35 AK 70b.

The shield is connected to the DRH/DPH side with the use of a capacitor (C1 = 0.1 µF/MKT/250 V ABB type: MKT XN 400005 P7) according to the following figure.

If the user does not work with a drive amplifier of the DRH type, the PG shield is to be connected on the 07 PO 60 side and to be isolated at the sensor side.

Shielding of the PG interface: (Fig. 13.2.27)

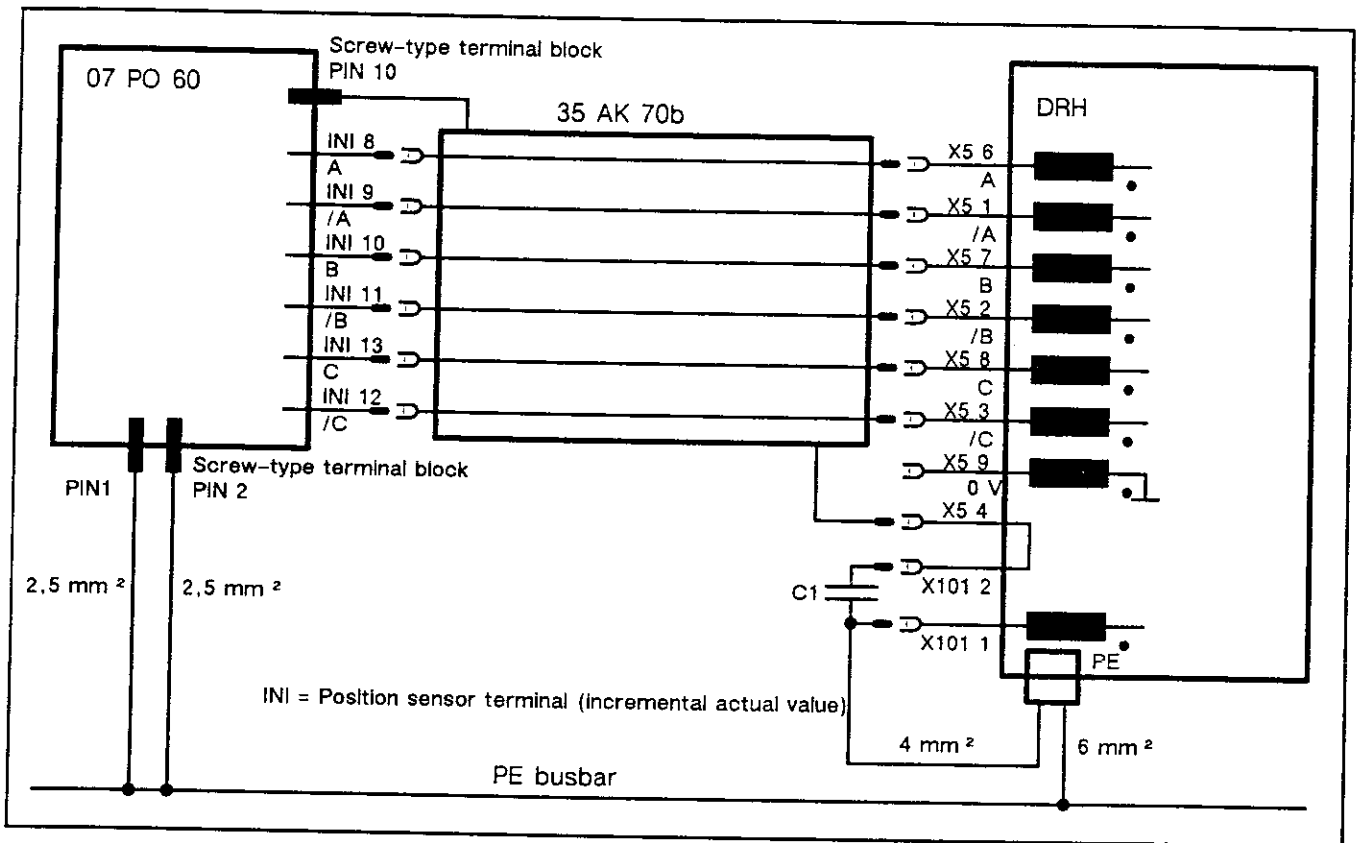

Earthing and wiring concept for the 07 PO 60 with AXODYN® three-phase-current drive amplifiers of the DRH/DPH types: (Fig. 13.2.28)

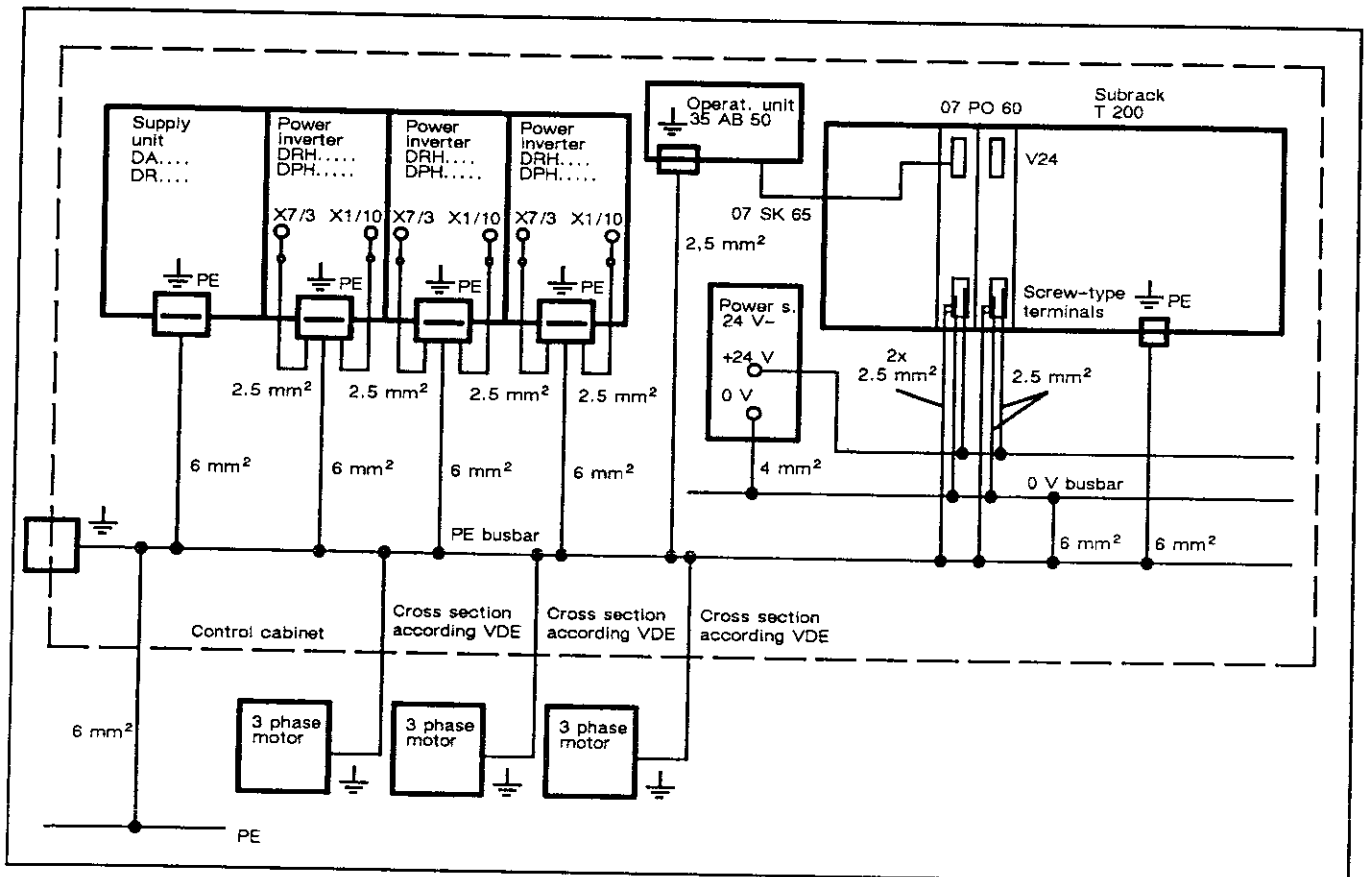

13.2.6.3 Commissioning information

- Before turning on for the first time, the user in any case must have studied the system components.
- Does the wiring of the system correspond to the recommended earthing and wiring concept?
- Commissioning and optimization of the drive (see description of the drive amplifier).
- Setting of the 07 PO 60 (see chapter 13.2.4.3, Settings)
- The 07 PO 60 units are to be screwed into subracks before the commissioning.
- Before touching the 07 PO 60 units (even during the commissioning), discharge at the control cabinet.
- **Note:**
The front plugs of the 07 PO 60 must not be plugged in or unplugged while the power supply is switched on.
- The 07 PO 60 is programmed with a standard program in the factory. An initial traversing of the drive is possible by this program.
- Check whether the system cables are connected (pay attention to chapters 13.2.6.1 System cables and 13.2.6.2 Earthing and wiring concept).
- Turn the PLC off and set drive amplifier enable = 0.
- Turn on process voltage UP1.
- When the ABB Procontic T200 power supply is switched on, the LEDs "B", "+" and "Z" light up. The text "07 PO 60 READY" appears on the operating unit. For error diagnosis, if necessary, see chapters Error messages or Application information, LED diagnosis.
- Check the initiator inputs for function via the operating unit (see chapter: Display of ABB Procontic T200 bus in/outputs and initiators) (manual damping of the initiators).
- Set drive amplifier enable = 1: drive is in closed-loop position control (**attention:** drive runs up when set value has a reversal polarity).
- Move to the limit positions in the operating mode "Manual control". The drive must stop while the limit position is reached and the LED "E" must light up. Leave the limit positions by "Manual control" in the opposite direction (selection via "+/- key").
- If the positive and the negative drive direction is reversed, the following modifications are necessary:
- Position sensor terminal on the side of 07 PO 60:
 - Exchange terminal trace A for trace B
 - Exchange terminal trace /A for trace /B

- Set value output on the side of 07 PO 60:
 - Reverse polarity
- If only one of the two measures is carried out, the axis will run up. (**Attention:** Only permissible in case of drive amplifiers with differential inputs).
- Move to the reference point in the operating mode "Move to reference point". The detection of the reference point is acknowledged by the LED "NP". If the 07 PO 60 does not find the reference point although the reference point initiator is working, the reference cam may be too short.

Remedy:

Rotate the pulse sensor until the 07 PO 60 finds the position-sensor zero-trace pulse as the reference cam is reached.

- Finding out and entering the machine parameters (see chapter Machine parameters):
Set types and set construction, machine data set
 - P11 "transfer factor"
 - P01 "amplification factor" (Kp)
 - P04 "maximum traversing speed" and, if any possible measuring system is desired:
 - P17, P18 "limit positions" (Uw is limited to +/- 0.1 V in the factory)
- Entering the other machine parameters
- Entering the user program via the operating unit or in DNC interchange.
- Processing the user program in the operating mode "Bed/AE".
- Control of the run of the program by the PLC.

13.2.6.4 PC software 935 AM 50

The PC software 935 AM 50 allows to communicate via the serial interface of the 07 PO 60 with a PC (an IBM compatible Personal Computer of the Compaq plus and Compaq Portable II types).

Possible software functions:

The software consists of 4 programs, which can be run on the MS/DOS system.

- XCOPY Copying from and to the 07 PO 60
- XEDIT NC program editor
- XPRINT Printing out of 07 PO 60 programs
- XHELP Short description of the listed programs

Precondition for the DNC operation is the setting of the 07 PO 60 according to chapter 13.2.4.3 Settings.

Serial interface for 07 PO 60:

COM1 is used as the serial interface for the 07 PO 60.

The following settings are carried out permanently when the XCOPY commands are called up:

Baud rate: 2400 baud
Word length: 8 bits
Stop bit: 1 bits
Parity: even

Printer interface:

The logical system interface LPT1 is addressed for controlling a printer (standard parallel interface for MS-DOS).

If a printer is to be controlled via a serial interface, a change-over to a serial output port by means of a mode command is necessary.

Example: MODE LPT1: = COM1

This interface can be adapted by a mode command:
MODE COM1: (baud rate, parity, data bits, stop bits)

Example: MODE COM1: 9600, N, 8, 1

Description of the software functions:

The following functions are implemented in XHELP:

1. XCOPY Duplication/transfer of files
2. XPRINT Printing of files
3. XEDIT Editing or modifying files

XCOPY:

Call-up:

XCOPY AXU(n) (drive)target file
(Transfer 07 PO 60 -> PC)
e.g. XCOPY AXU1 A:ABB1.AXU

XCOPY (drive)source file AXU(n)
(Transfer PC -> 07 PO 60)
e.g. XCOPY A:ABB2.AXU AXU1

Explanations:

Drive e.g. C:, A:

Target file file name to which transfer is to be carried out, e.g. ABB1.AXU

Source file file name from which transfer is to be carried out, e.g. ABB2.AXU

AXU 07 PO 60

n Number of 07 PO 60 (1 to 6), however only for use with the electronic switch and interface logic, otherwise the transfer of the parameter n is not executed.

The maximum length of a file name is 8, point, 3 characters resp. numerals.

XPRINT:

Call-up:

XPRINT (drive)source file
(Transfer file printer)
e.g. XPRINT A:ABB1.AXU

Explanations:
see XCOPY

XEDIT:

Call-up:

XEDIT (drive)source file
e.g. XEDIT A:ABB1.AXU

Two files are necessary for the operation of the XEDIT mode: XEDIT.COM and XEDIT.OVR.

Both must be loaded in the drive specified.

Operation:

The input is permanently checked whether it is correct or not. Type and limit values are displayed on the status line. The parameter to be edited is displayed shaded on the screen.

Entering of values:

+/- sign, 0 to 9 and Delete key

Entering of comments:

All reproducible characters, Delete key, DEL and INS

Cursor:

Keys left, right, up, down, home and end

Leaving through:

Page up, page down

The edit mode can be influenced by the following keys:

SHIFT F1: Leave XEDIT, save file on disk

SHIFT F2: Leave XEDIT, file will not be saved

SHIFT F3: Save file

SHIFT F4: Rename file

When addressing EDIT mode and entering a file not stored, a standard file is displayed on the screen.

Special features when working with XEDIT:

- Entering "MDS":
 - P01:
 - Input value with XEDIT: $K_v = K_p\text{-factor} \cdot 256$
 - Example: $K_p = 2.00 \Rightarrow K_v = 2.00 \cdot 256 = 512$ (value to be entered).
- Inputs in any measuring system:
 - When programming 'MDS' $P_{11} \neq 0$ (input in any measuring system), the input of the position and speed set values with XEDIT must be carried out incrementally though. The conversion into the desired unit of measurement is carried out only in the 07 PO 60.

- Input of position values

$$POS_{Metric} = \frac{1}{P_{11}} \cdot POS_{INC}$$

- Input of speed values

$$FEED_{Metric} = \frac{12.5}{P_{11}} \cdot FEED_{INC}$$

$$V_{max_{Metric}} = \frac{12.5}{P_{11}} \cdot V_{max_{INC}}$$

- * The factor 12.5 is due to the internal standardization of the 07 PO 60.

13.2.6.5 LED diagnosis

The following errors are indicated by flashing of LEDs on the front panel. The errors can only be acknowledged by switching off the T200 power supply voltage or by a 07 PO 60 single-card reset:

- LED "B" flashes in 1s period:
 - Binary input "Reserve" is connected to +24V or the 24V power supply voltage is still switched off when the T200 power supply voltage is turned on -> remove screw terminal at input "RES1" or switch on the 24V power supply voltage UP1 before switching on the T200 power supply.
- LEDs "B" and "E" flash in 0,1s period:
 - The monitoring of the 24V power supply voltage has detected an error, i.e. the power supply voltage is or has broken down (07 PO 60 actual value counter,... out of function).
The 24 V power supply has always to be switched on while working with 07 PO 60, because of all interfaces are electrically isolated.
- LEDs "B", "E" and "+" flash in 0,1s period:
 - The 07 PO 60 internal software watchdog (checking program) has been activated.
- LED "B", "E", "+", "-" und "Z" flash in 0,1s period:
 - The 07 PO 60 internal stack-checking routine has been activated.

13.2.6.6 Extension of the user program segments in RAM by replacement of components on the processor card

If the RAM IC 6264 (8k · 8) (standard fitting) is replaced by a RAM IC 43256 (32k · 8) and if the resistors R10 and R11 are fitted according to the table below, 11 additional user program segments in the RAM of the 07 PO 60 are available to the user. A replacement of the 07 PO 60 firmware is not necessary.

Resistor	State	Meaning
R10	not existing *	RAM 8 k · 8 RAM
R10	fitted	RAM 32 k · 8 RAM
R11	fitted *	RAM 8 k · 8 RAM
R11	not existing	RAM 32 k · 8 RAM

* Standard fitting

13.2.6.7 Incremental measuring system

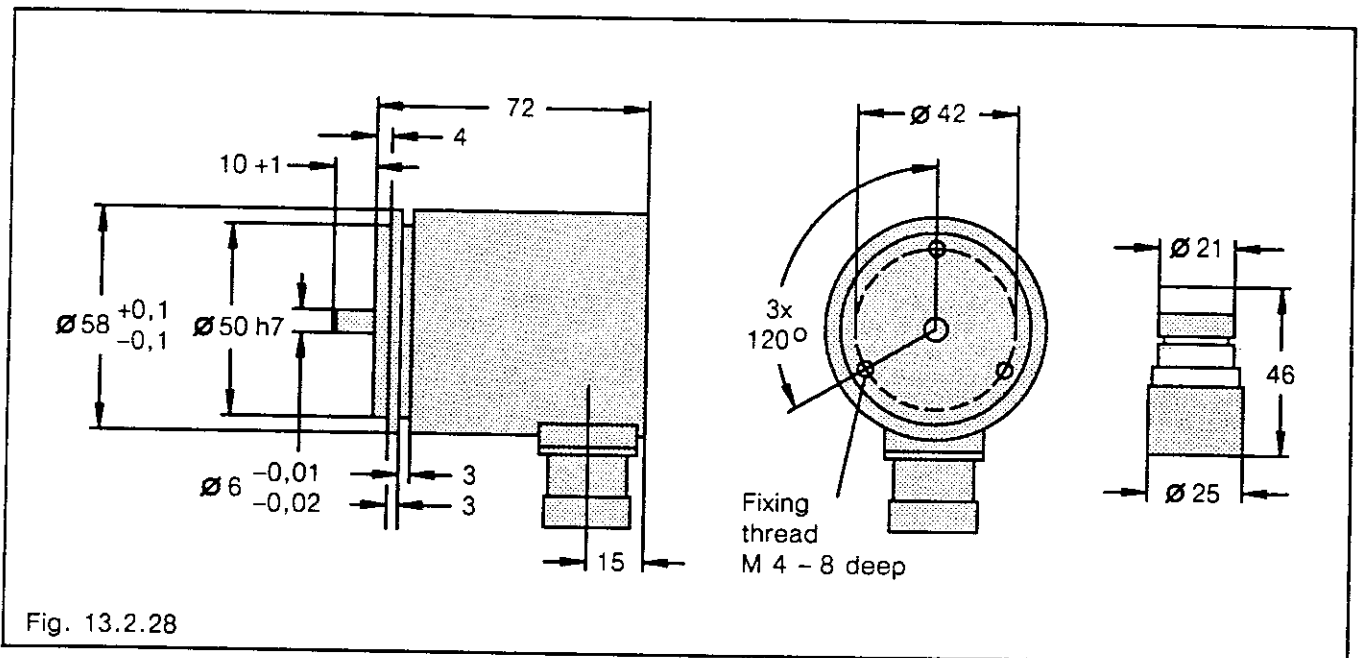

Technical data

Power supply voltage	+ 5 V ± 5 %
Current consumption	max. 220 mA (without load)
Total power dissipation	max. 1.1 W
Order numbers	
- Position sensor 500 incr./revolution	GJV3075101R1
- Position sensor 1000 incr./revolution	GJV3075101R2

Mechanical data

Dimensions	see figure above
Weight	approx. 390 g (according to type)
Motor starting torque (at 25 °C)	
- without shaft seal	max. 0.007 Nm
- with shaft seal	max. 0.035 Nm
max. permissible speed	6000 rev/min (without shaft seal) 3000 rev/min (with shaft seal)
Bearing lifetime	10 ⁹ revolutions
Shaft load capability	118 N (radial), 98 N (axial)

Environmental conditions

Temperature	
- operation	0 °C to + 70 °C
- storage	- 25 °C to + 80 °C
Humidity	max. 98 % relative humidity
Degree of protection (according to DIN 40050, page 1)	IP 64
Shock (standard value)	20 g, 11 ms
Vibration (standard value)	10 g, 5...2000 Hz

Materials

Base	aluminium, passivated in chromic acid
Housing	aluminium, black anodized
Shaft	non-magnetic stainless steel
Bearing	ABEC 5
Light source	GaAs infra-red LED

Handling instructions for incremental encoders

Connection of the encoder shaft can be carried out via a custom specified metal bellow coupling.

If the encoder is to be driven by means of a gear-wheel or roller, care must be taken that the gear-wheel is mounted onto the shaft stub with $\varnothing 6 \text{ mm} -0,01 / -0,02 \text{ mm}$. No backlash should be present (e.g. faulty gripping of gear-wheels) when changing the direction of rotation.

Under no circumstances should the permissible axial or radial shaft loads be exceeded (see Technical Data).

Caution! Do not engage or disengage any connectors while equipment is under power!

Incremental sensors/cable lengths

Beside the incremental sensors (+ 5 V power supply voltage) available from ABB, + 15 V sensors can also be connected. The supply voltage of the incremental sensor is set via X5 (see chapter 13.2.4.3, Settings).

Cable length of the position sensor cable:

	Sensor supply via 07 PO 60	Sensor supply externally
Sensor with + 5 V supply	max 20 m	max 20 m
Sensor with +15 V supply	max 20 m	max 20 m

13.2.6.8 Operating the 07 PO 60 and 35 US 50

It is necessary to switch on the 35 US 50 approx. 30 seconds after the ABB Procontic T200, as the latter takes approx. 10...20 seconds (power-on reset), before it becomes accessible (including the 07 PO 60) after the power is switched on.

When it is switched on, the 35 US 50 automatically detects the number of the 07 PO 60 units connected.

However, if the connection of the 35 US 50 is effected via the PLC program, the 35 US 50 can only work while the PLC program is in operation (it cannot work when the program is stopped or in the remote mode).

First of all do not do the following!

All this involves the loss of warranty.

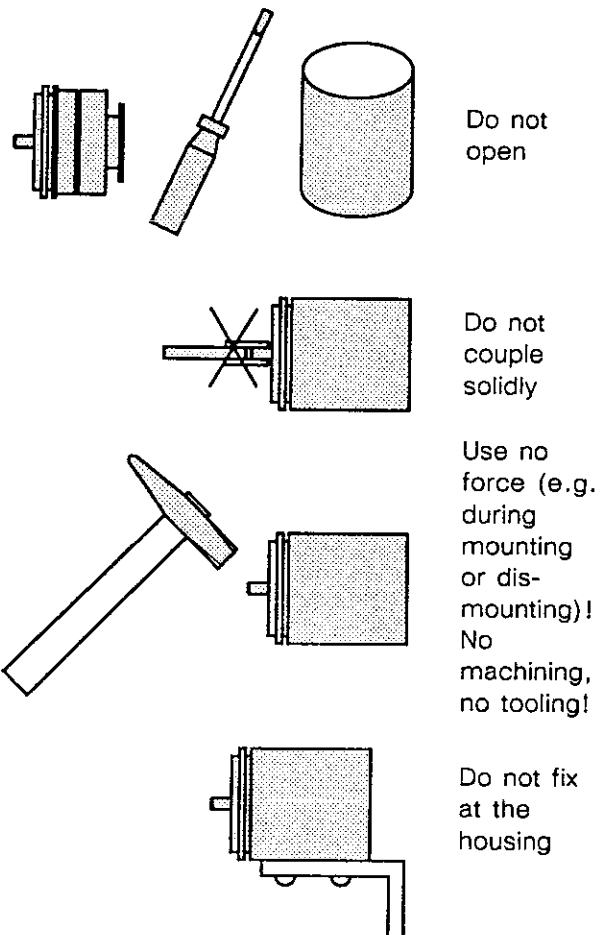

13.3 Programmable Real-Time Clock 07 UD 60 R1

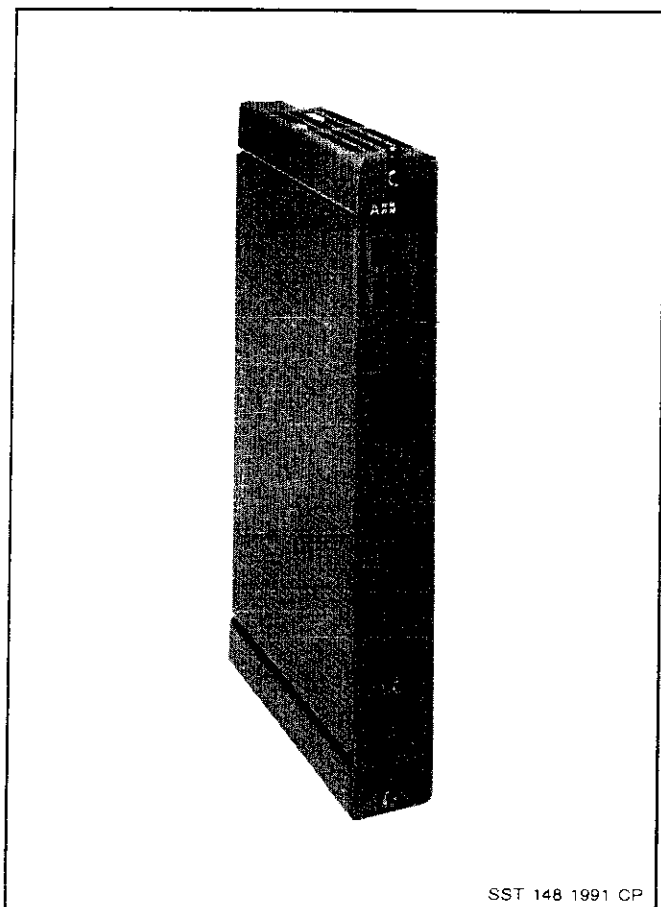

Fig. 13.3.1: Programmable real-time clock 07 UD 60

Characteristics

The 07 UD 60 R1 programmable real-time clock includes a battery-backed clock module which provides date and time (year, month, day, weekday, hour, minute, second) and 7 timers which can be used fully independent from each other. Using this real-time clock system or production data can be interrogated and archived together with the current time and date. Since the current information about time and date is allocated to word inputs of the T200 system, it is permanently available. The time display mode can be selected between cycles of 24 hours and 12 hours (am./pm.). Time and date can be set and interrogated by the user program. Furthermore it is feasible to stop the clock, however, it also affects the timer functions.

Each of the 7 timers included in the 07 UD 60 R1 real-time clock can be operated in 4 different modes: as an integrating timer, a subtracting timer, an identity timer and an interval timer. Employing these timer modes it is feasible

- to monitor durations of process sequences
- to call attention to maintenance intervals (e.g. maintenance every 1000 operating hours)

- to realize hours-run meters (faultless operating hours, total number of operating hours)
- to take down daily logs (e.g. manufacturing outputs per shift)
- to determine, at what time the control changed to STOP when an error occurred.

All functions for alert, alarm and monitoring can be carried out as well as time-controlled logs of processing and manufacturing data.

Independent from each other, all timers can be set, interrogated, enabled or disabled. When a timer has elapsed, an alarm bit is set. In the same way as with time and date, the alarm bits together with other information can be read permanently from a word input. In addition to the alarm bits, for the timers 1...4 an alarm LED is set on the front panel of the 07 UD 60.

Module Description

The module has a housing which is as wide as one slot. On the front panel there are some LEDs for the display of operating states, such as

- Error in the clock module (WDTE)
- Battery error (BATE)
- Timer alarm (ALM0...ALM3).

The battery compartment is accessible on the front panel to replace the lithium battery, if necessary (see Fig.13.3.2).

Deleting of errors (E.CLR) and resetting of the hardware (RESET) of the clock module are performed by two undercut pushbuttons. If these buttons are pressed, the data of the clock and the timers are not deleted.

Operating Manual

A separate operating manual, which is available under the order number GATS 1314 07 R1001 (**only in German**), contains a detailed description (hardware and software) with the following contents:

- Allgemeine Gerätebeschreibung
- Technische Daten
- Befehlsübersicht
- Funktionsbeschreibung
- Fehleranzeige-Funktionen
- Timerfunktionen
- Geräteeinbau und Inbetriebnahme
- Funktionsbausteine (FUP/AWL)
- Interface zur Zentraleinheit der ABB Procontic T200, Datenverkehr zwischen 07 UD 60 und ZE
- Liste der Befehlscodes mit Befehlsausführungszeiten und detaillierte Befehlsbeschreibung
- Wartung und Inspektion
- Fehlerbeseitigung

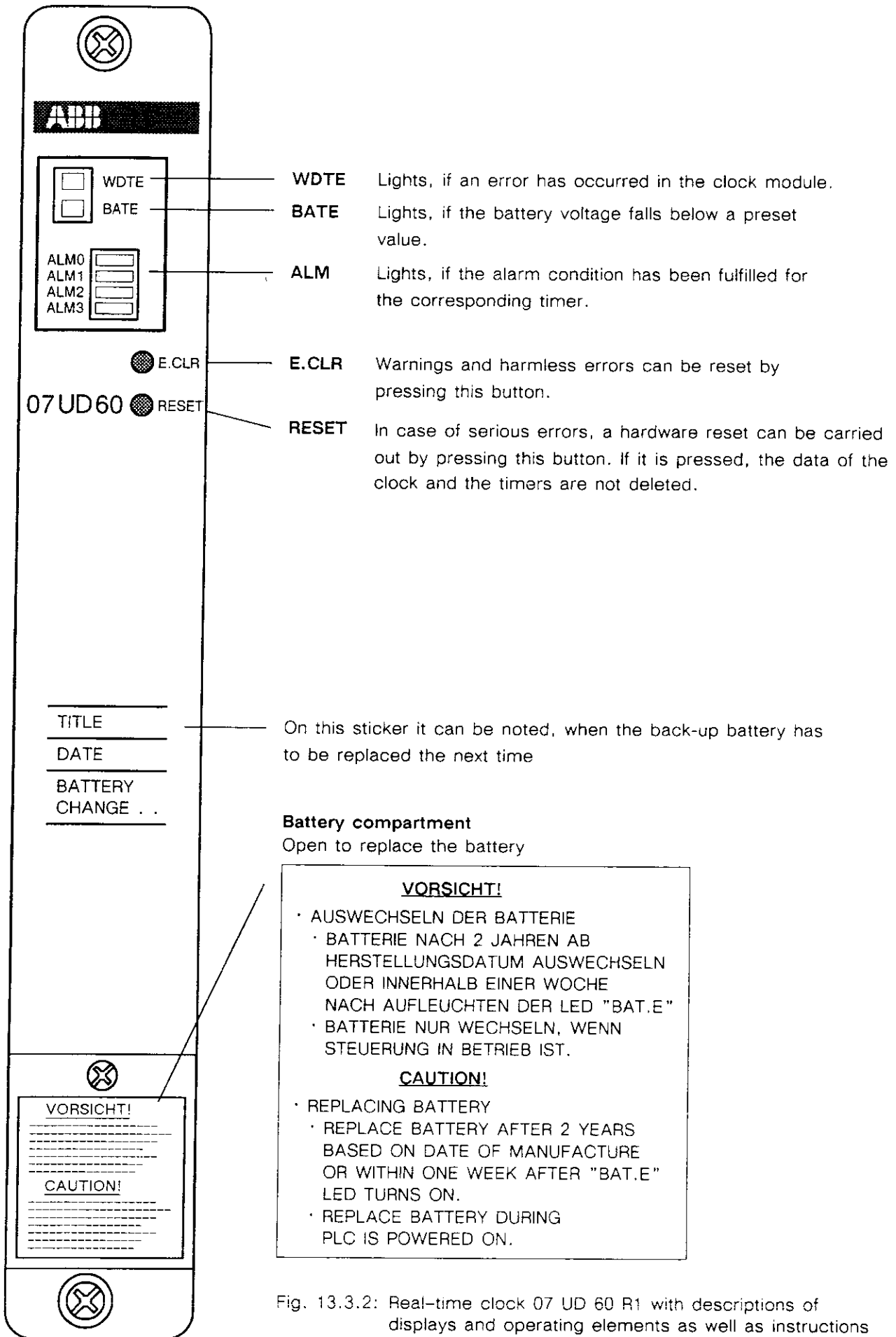

Fig. 13.3.2: Real-time clock 07 UD 60 R1 with descriptions of displays and operating elements as well as instructions for replacement of battery

Technical Data

max. number of modules per subrack

Signalling

Current consumption from internal voltages

UB1 = 5 V DC

UB4 = 24 V DC

Total power dissipation

Battery back-up

Accuracy of the real-time clock

(at an operating temperature of 0...55 °C)

Time resolution

Number of required slots

Number of occupied I/O points

Configuration identifier in 907 PC 32

Ability of fitting in subracks

Slot,

● = plug-in is possible (occupies 1 slot)

Weight

Order number 07 UD 60 R1

Accessories: (supplied):

Accessories: (not supplied):

Software 907 PB 362

Documentation,

Operating Manual 07 UD 60 *

07 UD 60 R1

only limited by the number of I/O slots

with LEDs, see Fig. 13.3.2

max. 0.1 A

no current consumption

max. 0.5 W

backed is:

- time

- date

- timers' setpoints and actual values

- timer status (alarm, enable, disable)

The back-up is made by a lithium battery.

The battery ought to be replaced every two years or within one week, if LED "BAT.E" lights up.

max. deviation: -120 s to +30 s per month

1 second

1 I/O slot

4 input and 4 output words

EAW4

BT			BE-central			BE-remote		
NG	ZE	I/O	NG	BV	I/O	NG	BV	I/O
		●			●			●

approx. 500 g

GJV3074384R1

1 lithium battery

GJP5201900R302

GATS131407R1001 (only in German)

* The operating manual which is available under the above mentioned order number contains a detailed description (hardware and software) with the following contents:

Allgemeine Gerätebeschreibung

Technische Daten

Befehlsübersicht

Funktionsbeschreibung

Fehleranzeige-Funktionen

Timerfunktionen

Geräteeinbau und Inbetriebnahme

Funktionsbausteine (FUP/AWL)

Interface zur Zentraleinheit der ABB Procontic T200,

Datenverkehr zwischen 07 UD 60 und Zentraleinheit ZE

Liste der Befehlscodes mit Befehlsausführungszeiten

und detaillierte Befehlsbeschreibung

Wartung und Inspektion

Fehlerbeseitigung

14 System Cables

-
- 07 SV 60 R1: System-expansion cable for central I/O expansion connecting central unit and expansion subrack (cable length 0.5 m)
 - 07 SV 60 R2: System-expansion cable for central I/O expansion connecting central unit and expansion subrack (cable length 1.0 m)
 - 07 SV 61 R1: System-expansion cable for central I/O expansion connecting two subracks (cable length 0.5 m)
 - 07 SV 61 R2: System-expansion cable for central I/O expansion connecting two subracks (cable length 1.0 m)
 - 07 SZ 60 R1: System cable set connecting an input/output module and its remote mounted front panel
 - 07 SK 60 R2: Interface cable connecting the serial interface of a central unit and the hand-held monitoring tool 07 BG 60 (cable length 2 m)
 - 07 SK 60 R5: Interface cable connecting the serial interface of a central unit and the hand-held monitoring tool 07 BG 60 (cable length 5 m)
 - 07 SK 61 R1: Serial interface cable; SUB-D plugs: Side A: 25 pole female; side B: 15 pole male
 - 07 SK 62 R1: Serial interface cable; SUB-D plugs: Side A: 9 pole female; side B: 15 pole male
 - 07 SK 63 R1: Serial interface cable for connection of the industrial computer basic 07 IR 60
 - 07 SK 64 R1: Serial interface cable for connection of the text processor 07 KT 60
 - 07 SK 65 R1: Serial interface cable for connection between the positioning unit 07 PO 60 and the operating and programming unit 35 AB 50
 - 07 SK 66 R1: Serial interface cable for connection between 2 positioning units 07 PO 60 and the electronic switch and control logic 35 US 50
 - 07 SK 67 R1: Serial interface cable for connection between the text processor 07 KT 60 and the printer 07 DR 12
 - 07 SK 68 R1: Serial interface cable for connection between the text processor 07 KT 60 and the operator station 35 BS 40
 - 07 SK 90 R1: } Interface cables for connection of peripheral units to the 9-pole serial interfaces of the
 - 07 SK 91 R1: } compact PLCs 07 KR 91, 07 KT 92 (ABB Procontic CS31) and the communication
 - 07 SK 92 R1: } processors 07 KP 62, 07 KP 63 and 07 KP 64 (ABB Procontic T200)
 - 07 LK 60 R1: Fibre-optic cable (Patchcord) for direct connection between couplers (07 BR 60/61 R2, 07 ZB 69 R2)
 - 07 LK 61 R1: Fibre-optic cable (Pigtail) for connection of couplers (07 BR 60/61 R2, 07 ZB 69 R2) to an external optical fibre
 - 07 LV 60 R1: Fibre-optic coupling device for cable-to-cable connection and test and measurement purposes

14.1 System-Expansion Cables 07 SV 60 R1 and R2

for central I/O expansion connecting central unit and expansion subrack

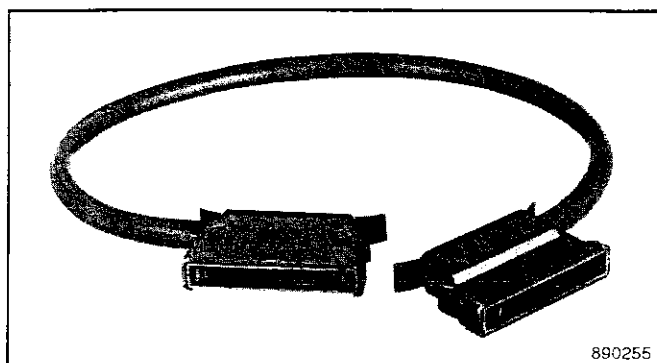

The system cable 07 SV 60 is used for central expansion. It connects the central unit with the bus connector 07 BV 60 R1 on the first expansion subrack.

An example of a configuration is shown in chapter 4.1 (bus connector 07 BV 60 R1).

Fig.14.1.1: System-expansion cable 07 SV 60 R1

Technical Data

Cable length	07 SV 60 R1	0.5 m
	07 SV 60 R2	1.0 m
Weight	07 SV 60 R1	285 g
	07 SV 60 R2	350 g
Order number	07 SV 60 R1	GJV3074371R1
	07 SV 60 R2	GJV3074371R2

14.2 System-Expansion Cables 07 SV 61 R1 and R2

for central I/O expansion connecting two subracks

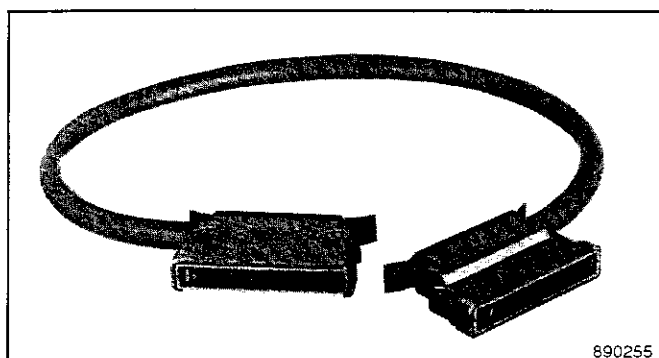

The system cable 07 SV 61 is used for central expansion. It connects two bus connectors 07 BV 60 R1 (on the first and second respectively the second and third expansion subrack and so on).

An example of a configuration is shown in chapter 4.1 (bus connector 07 BV 60 R1).

Fig.14.2.1: System-expansion cable 07 SV 61 R1

Technical Data

Cable length	07 SV 61 R1	0.5 m
	07 SV 61 R2	1.0 m
Weight	07 SV 61 R1	285 g
	07 SV 61 R2	350 g
Order number	07 SV 61 R1	GJV3074372R1
	07 SV 61 R2	GJV3074372R2

14.3 System Cable Set 07 SZ 60 R1

connecting an input/output module and its remote mounted front panel

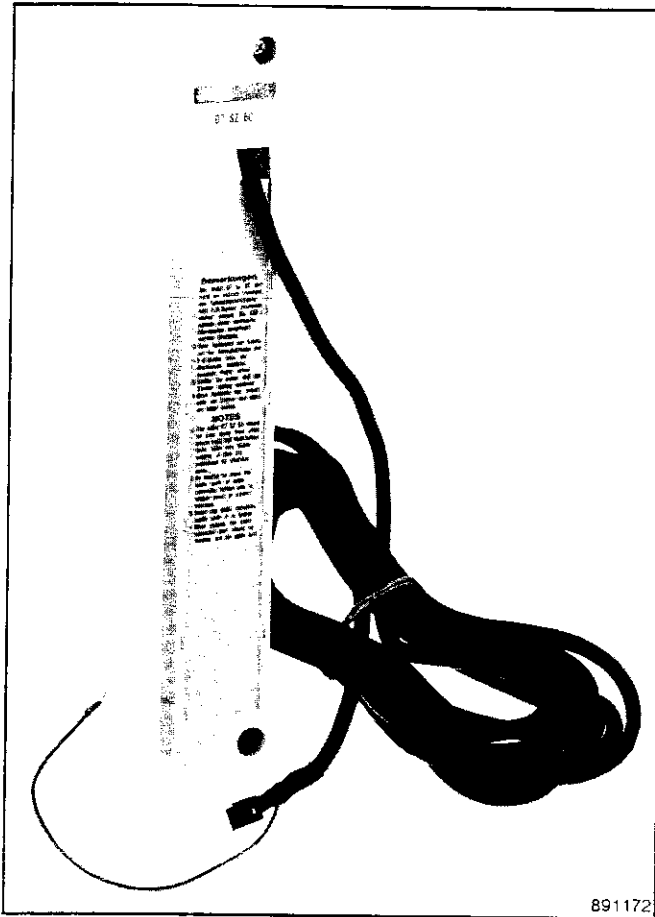

The system cable set for remote signalling consists of a replacement front panel for the I/O unit and an attached extension cable.

It enables remote signalling of input/output module front panels up to a distance of 3.9 m.

Fixing accessories are delivered with the system cable set 07 SZ 60 R1.

Fig. 14.3.1: System cable set 07 SZ 60 R1

Technical Data

Cable length	3.9 m
Weight	230 g
Order number	GJV3074398R1

14.4 Interface Cables 07 SK 60 R2 and 07 SK 60 R5

connecting the serial interface of a central unit and the hand-held monitoring tool 07 BG 60 (cable lengths: R2: 2 m; R5: 5 m)

Intended Purpose

Through the cable the 07 BG 60 hand-held monitoring tool is powered and the data transmission is established. The cable is used between

07 BG 60 and 07 ZE 60/61/62/63 central units
 07 BR 61 coupler
 07 KP 60 communication processor

Mechanical Design

For connection to the 07 BG 60 hand-held monitoring tool: SUB-D plug, 15 pole female.

For connection to the central unit, coupler, processor: SUB-D plug, 15 pole male.

By means of screws, the plugs are mounted to both interfaces.

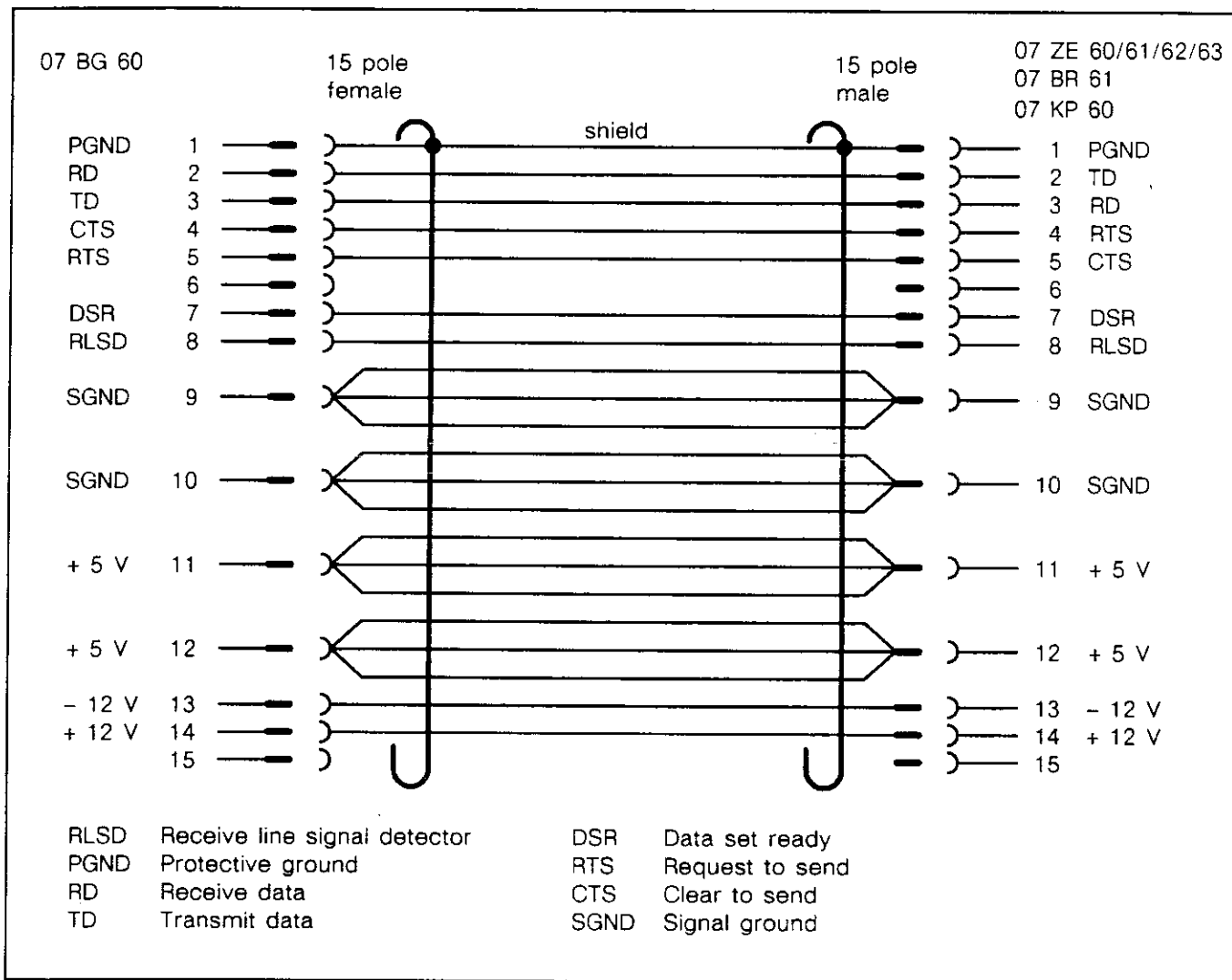

Fig. 14.4.1: Terminal assignment 07 SK 60 R2/R5

Technical Data

Cable lengths	07 SK 60 R2	2 m
	07 SK 60 R5	5 m
Weights	07 SK 60 R2	approx. 400 g
	07 SK 60 R5	approx. 900 g
Order numbers	07 SK 60 R2	GJV3074329R2
	07 SK 60 R5	GJV3074329R5

14.5 Serial Interface cable 07 SK 61 R1

SUB-D plugs: Side A: 25 pole female; side B: 15 pole male

Intended Purpose

The cable is used for serial data transmission (RS-232-C/V24) between the programming unit and ABB Procontic T200. By means of screws, the plugs are mounted to both interfaces.

Mechanical Design

For connection to the programming unit (side A): SUB-D plug, 25 pole female.
For connection to ABB Procontic T200 (side B): SUB-D plug, 15 pole male.

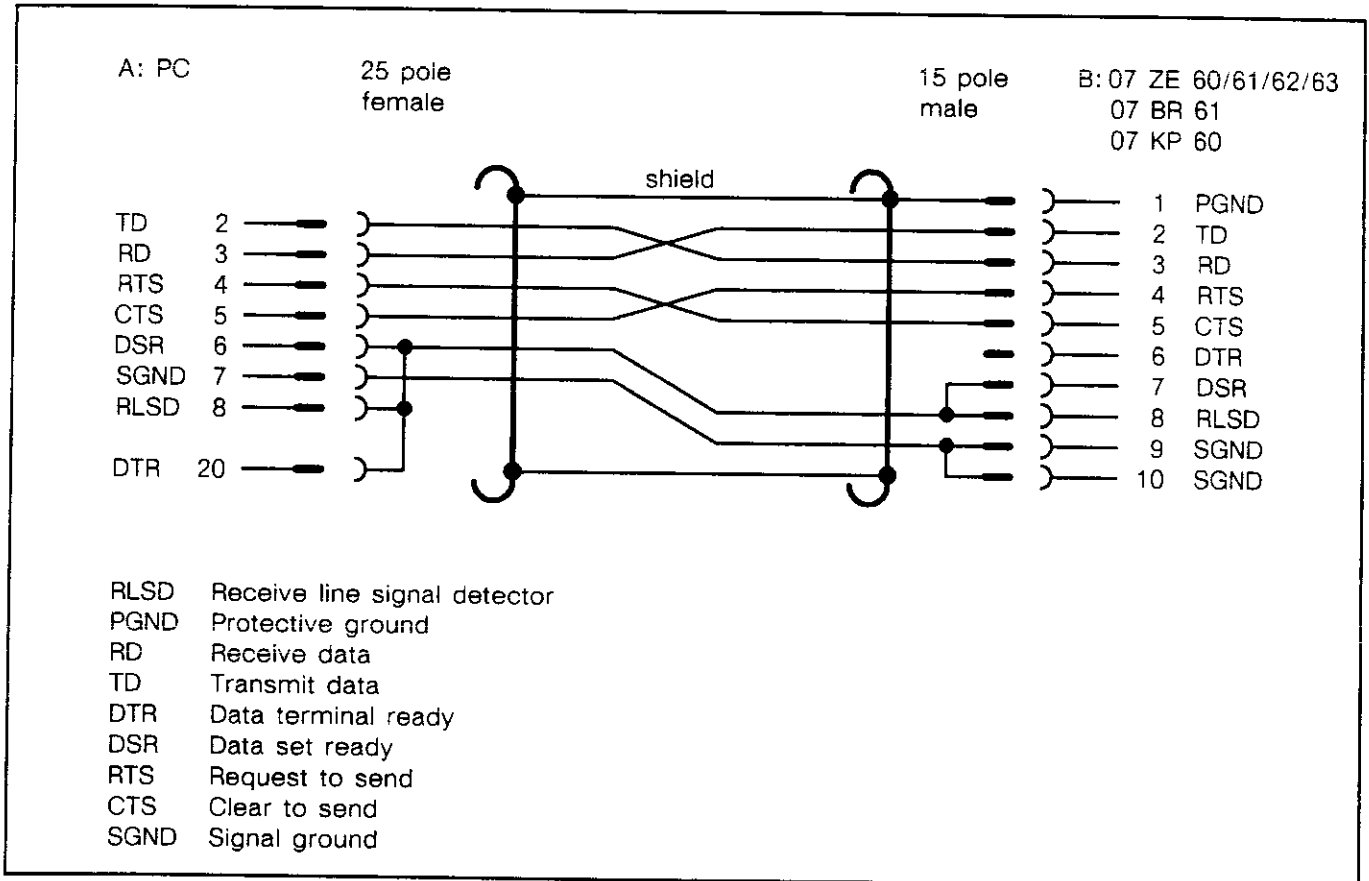

Fig. 14.5.1: Terminal assignment 07 SK 61 R1

Technical Data

Connections	from A:	07 PC 31 07 PC 32 35 BS 93 R3 07 PM 11 R2 35 BS 95 with SECOM-Card for 935 PM 73	to B:	07 ZE 60/61/62/63 07 BR 61 07 KP 60
Cable length				3 m
Weight				approx. 550 g
Order number				GJV3073906R1

14.6 Serial Interface Cable 07 SK 62 R1

SUB-D plugs: Side A: 9 pole female; side B: 15 pole male

Intended Purpose

The cable is used for serial data transmission (RS-232-C/V24) between the programming unit and ABB Procontic T200.

By means of screws, the plugs are mounted to both interfaces.

Mechanical Design

For connection to the programming unit (side A):
SUB-D plug, 9 pole female.

For connection to ABB Procontic T200 (side B):
SUB-D plug, 15 pole male.

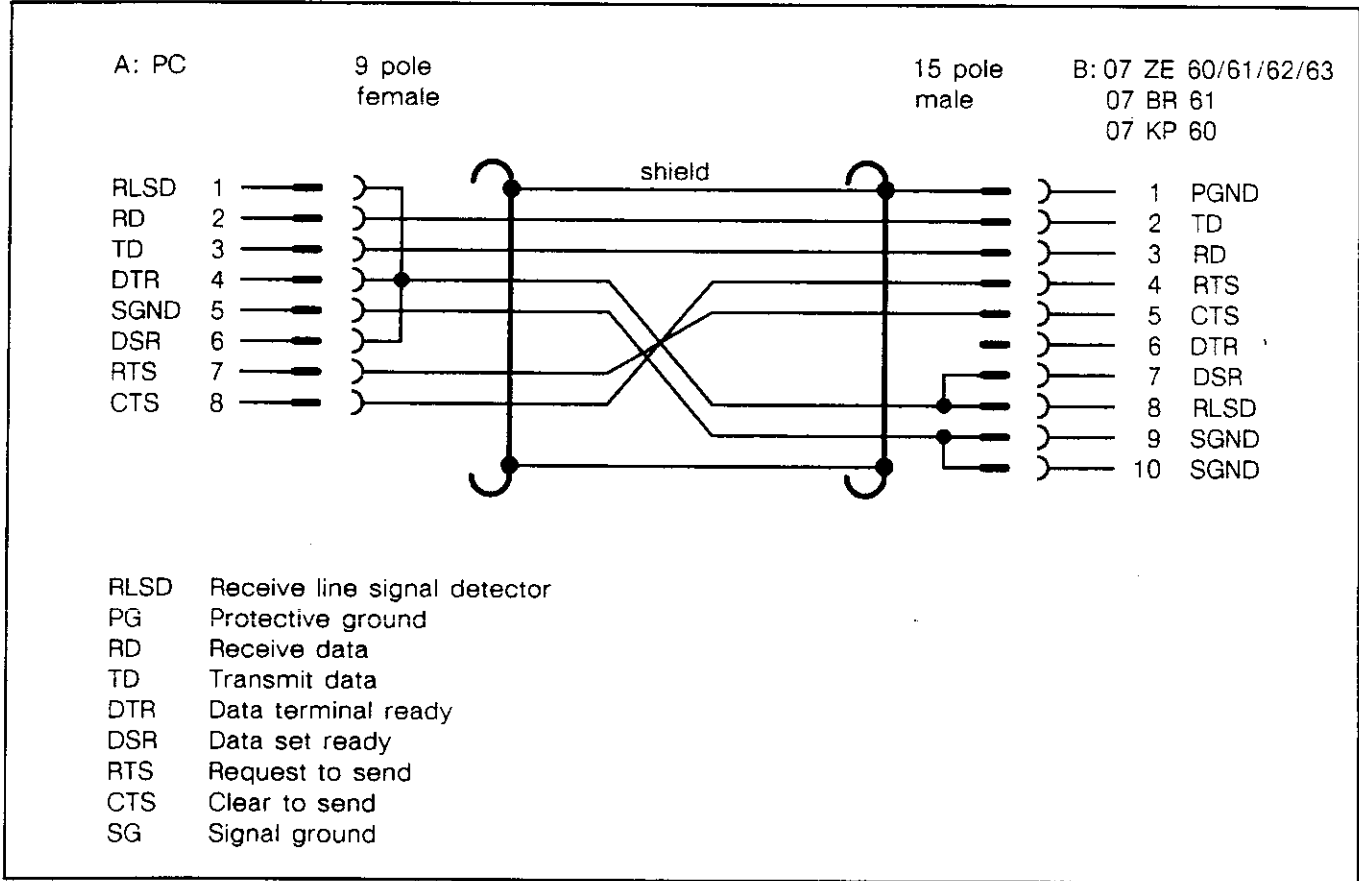

Fig. 14.6.1: Terminal assignment 07 SK 62 R1

Technical Data

Connections	from A:	07 PC 31 07 PC 32 07 PH 32	to B:	07 ZE 60/61/62/63 07 BR 61 07 KP 60
Cable length				3 m
Weight				approx. 550 g
Order number				GJV3073907R1

14.7 Serial Interface Cable 07 SK 63 R1

for connection of the Industrial Computer Basic 07 IR 60,
SUB-D plugs: Side A: 25 pole female, Side B: 15 pole male

Intended Purpose

The cable is used for serial data transmission (RS-232-C/V24) between the programming unit and the Industrial Computer Basic 07 IR 60.

By means of screws, the plugs are mounted to both interfaces.

Mechanical Design

For connection to the programming unit (side A):
SUB-D plug, 25 pole female.

For connection to the Industrial Computer Basic 07 IR 60 (side B):
SUB-D plug, 15 pole male.

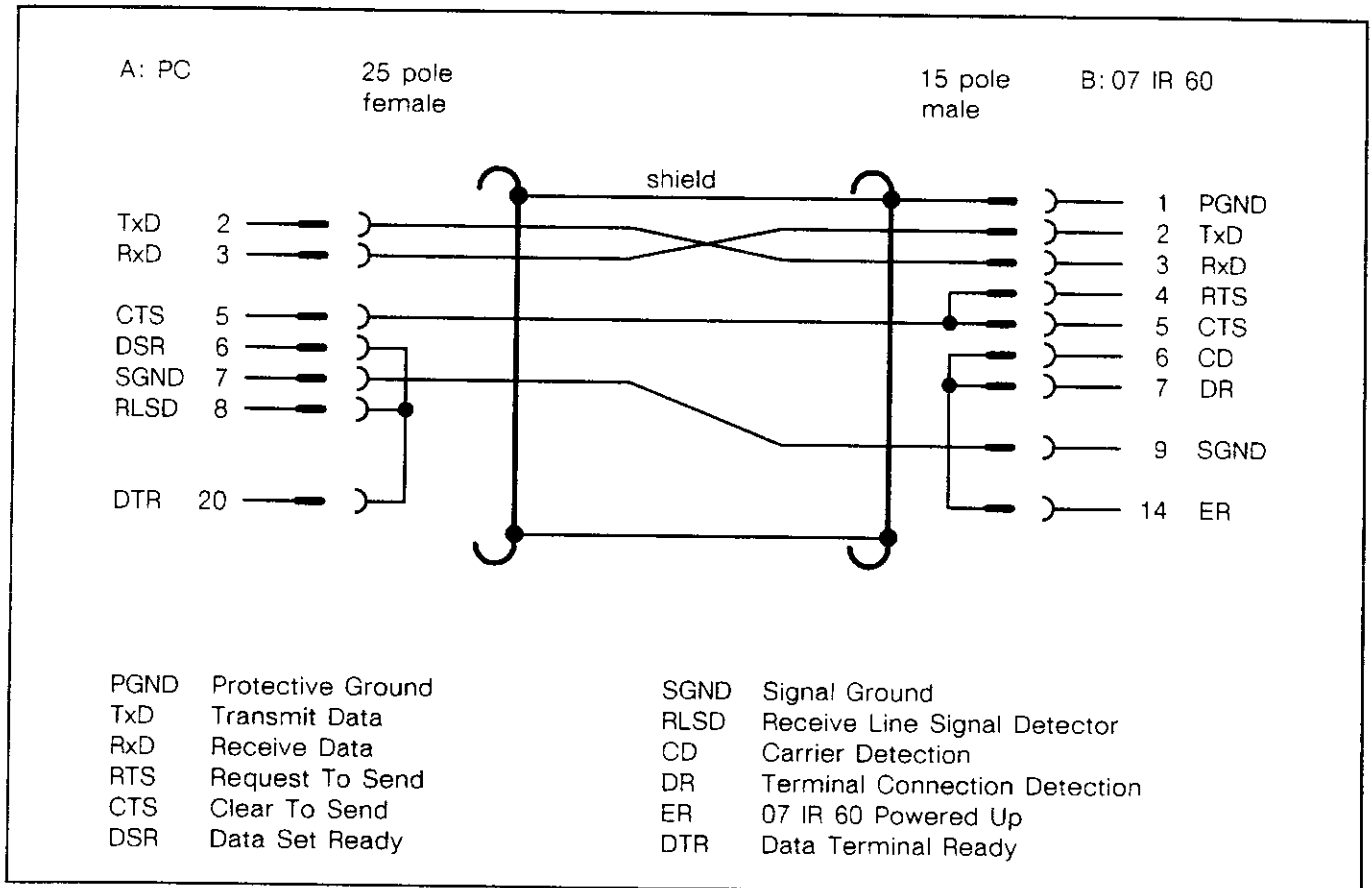

Fig. 14.7.1: Terminal assignment 07 SK 63 R1

Technical Data

Connections	from A: 07 PC 32 / 07 PH 32 SW-Basic-Tool	to B: 07 IR 60
Cable length	3 m	
Weight	approx. 550 g	
Order number	GJV3073908R1	

14.8 Serial Interface Cable 07 SK 64 R1

for connection of the text processor 07 KT 60,
SUB-D plugs: Side A: 25 pole female, Side B: 25 pole male

Intended Purpose

The cable is used for serial data transmission (RS-232-C/V24) between the programming unit and the text processor 07 KT 60.

By means of screws, the plugs are mounted to both interfaces.

Mechanical Design

For connection to the programming unit (side A):
SUB-D plug, 25 pole female.

For connection to the text processor 07 KT 60
(side B): SUB-D plug, 25 pole male.

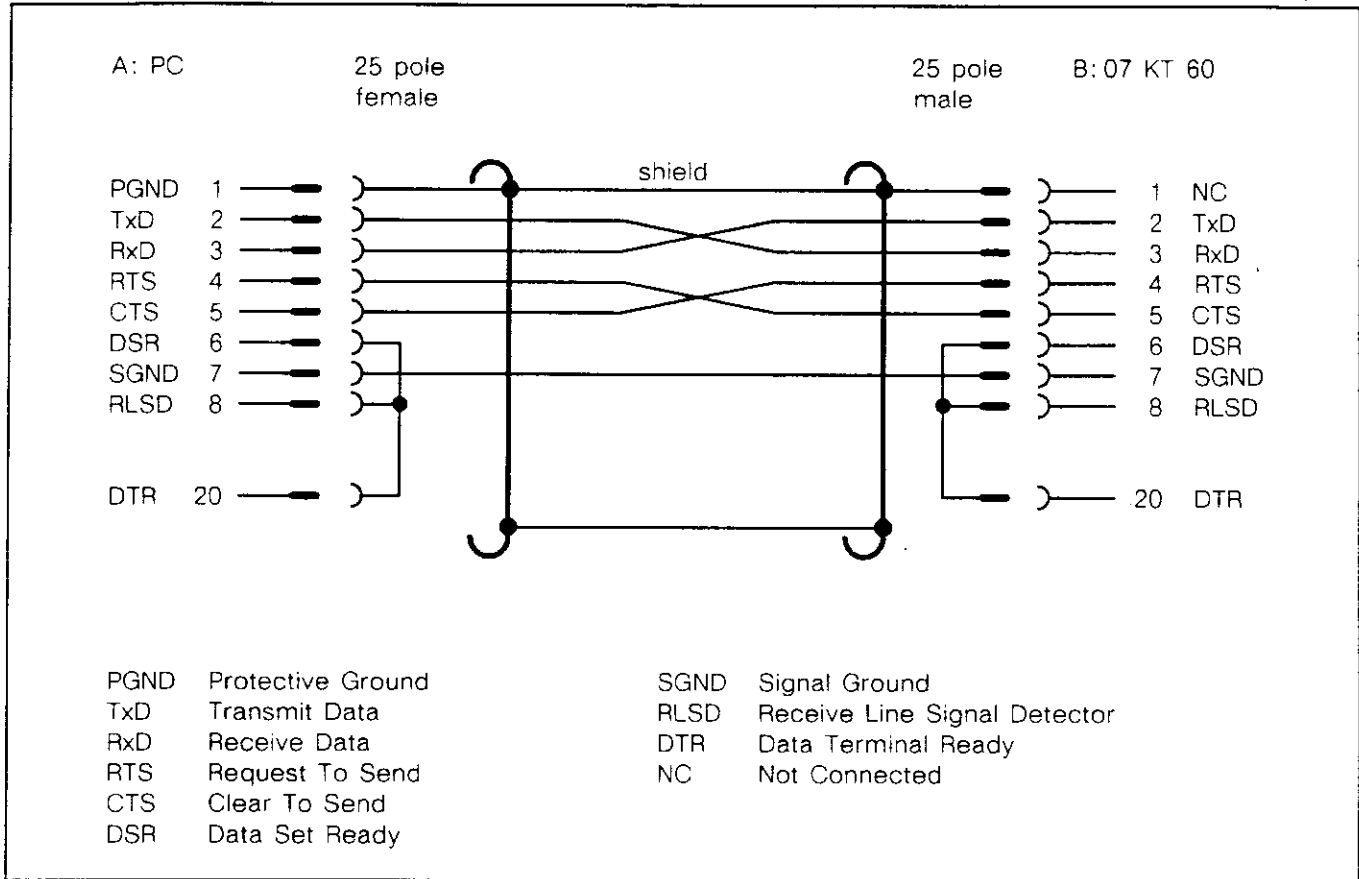

Fig. 14.8.1: Terminal assignment 07 SK 64 R1

Technical Data

Connections	from A: 07 PC 32 / 07 PH 32 SW 907 PC 32 VT100--Terminal	to B: 07 KT 60
Cable length	3 m	
Weight	approx. 550 g	
Order number	GJV3073909R1	

14.9 Serial Interface Cable 07 SK 65 R1

for connection between the positioning unit 07 PO 60 and the operating and programming unit 35 AB 50

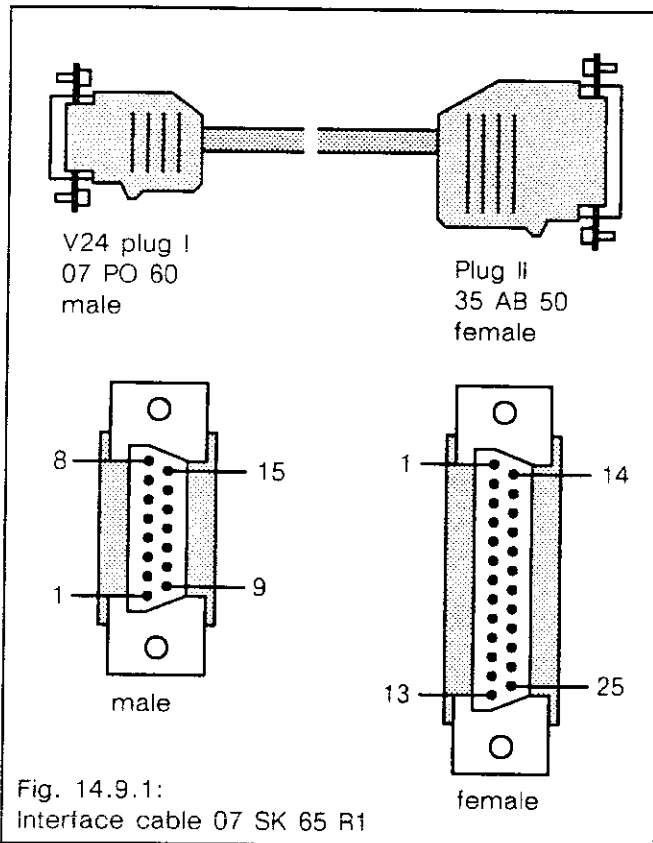

Intended Purpose

The cable is used for serial data transmission between the positioning unit 07 PO 60 and the operating and programming unit 35 AB 50. The unit 35 AB 50 is powered by 07 PO 60 through the cable.

Mechanical Design

For connection to the positioning unit 07 PO 60:
SUB-D plug, 15 pole male.

For connection to the operating and programming unit 35 AB 50:
SUB-D plug, 25 pole female.

By means of screws, the plugs are mounted to both interfaces.

Technical Data

Cable length	3 m
Weight	approx. 550 g
Order number	GJV3073910R1

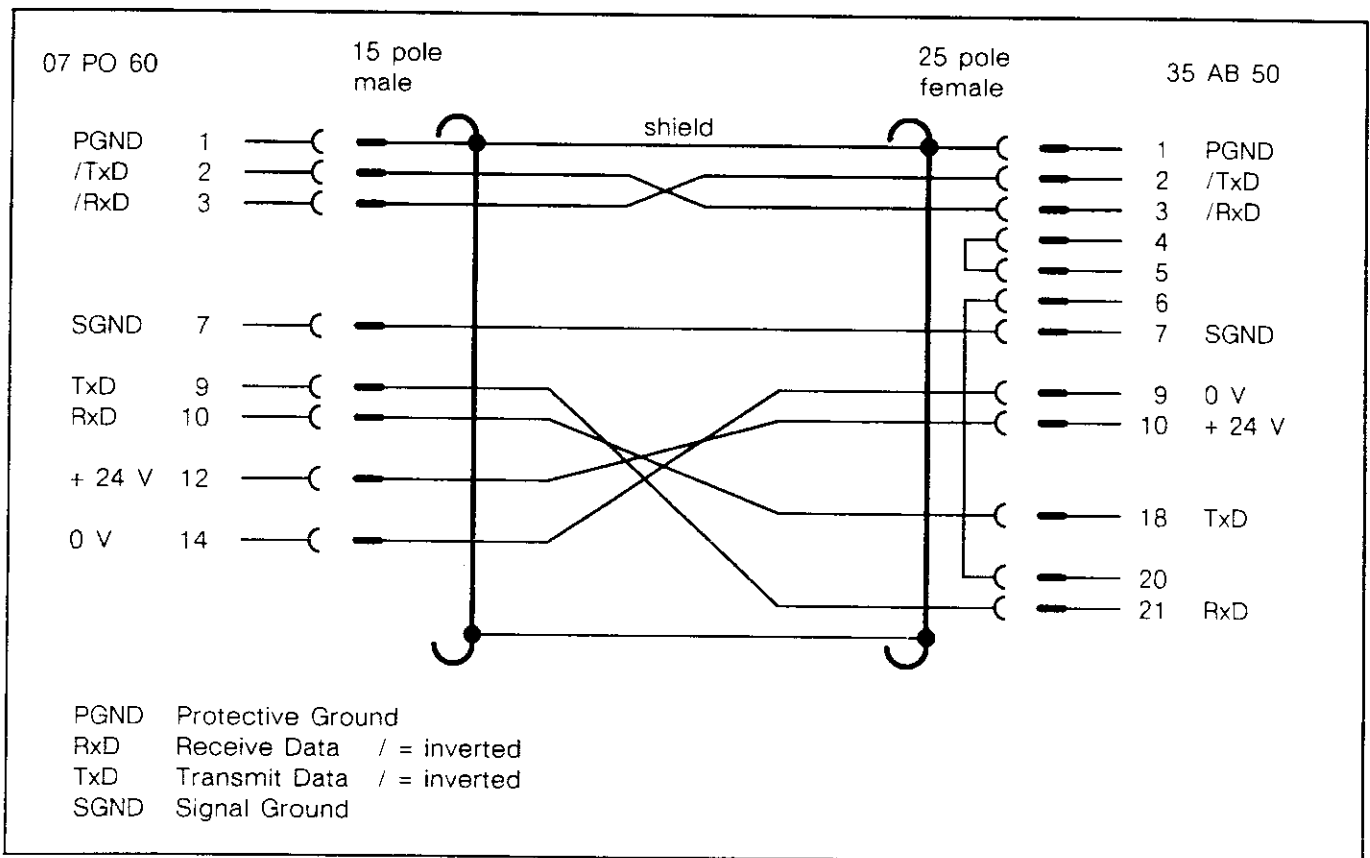
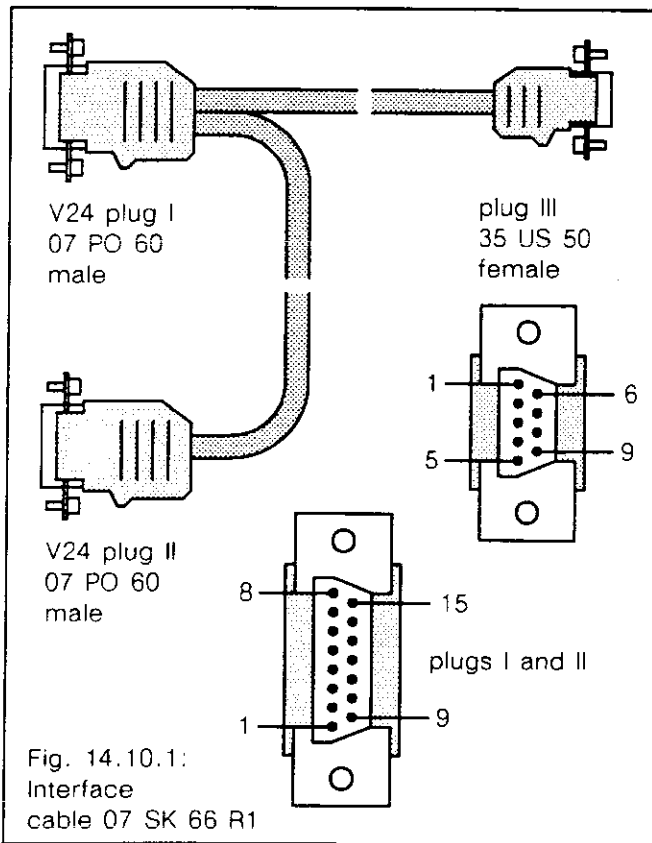

Fig. 14.9.2: Terminal assignment 07 SK 65 R1

14.10 Serial Interface Cable 07 SK 66 R1

for connection between 2 positioning units 07 PO 60 and the electronic switch and control logic 35 US 50



Intended Purpose

The cable is used for serial data transmission between 2 positioning units 07 PO 60 and the electronic switch and control logic 35 US 50.

The unit 35 US 50 allows the operation and programming of up to 6 positioning units 07 PO 60 by means of one 35 AB 50 or one PC. The description of 35 AB 50 is part of the system description of AXUMERIK[®]m.

Mechanical Design

For connecting the two positioning units 07 PO 60: SUB-D plugs, 15 pole male.

For connection to the electronic switch and control logic 35 US 50: SUB-D plug, 9 pole female.

By means of screws, the plugs are mounted to all interfaces.

Technical Data

Cable length	plugs I-II	0.8 m
	plugs I-III	1.0 m
Weight		approx. 600 g
Order number		GJV3073911R1

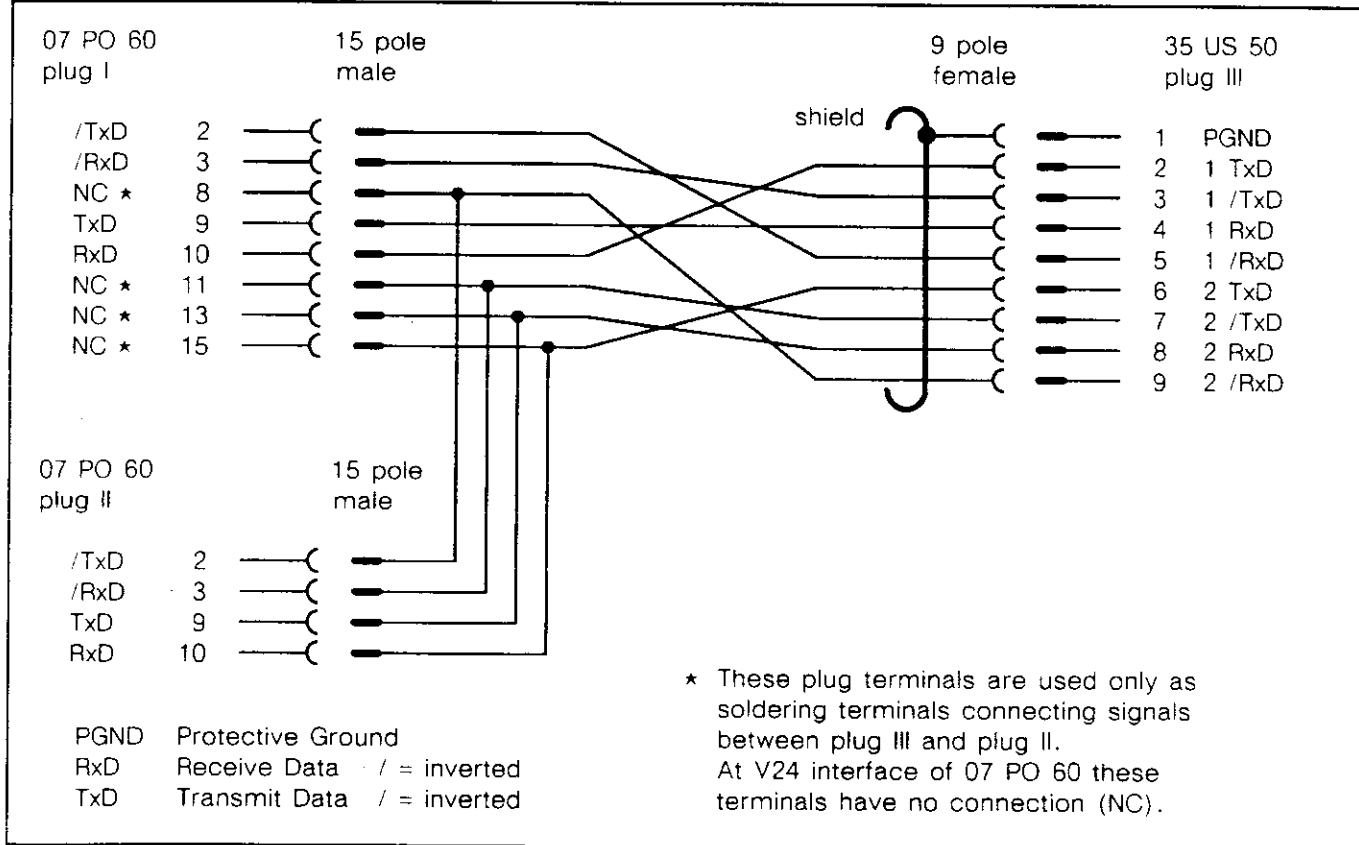

Fig. 14.10.2: Terminal assignment 07 SK 66 R1

14.11 Serial Interface Cable 07 SK 67 R1

for connection between the text processor 07 KT 60 and the printer 07 DR 12, SUB-D plugs: Side A and B: 25 pole male

Intended Purpose

The cable is used for serial data transmission (RS-232-C/V24) between the text processor 07 KT 60 and the printer 07 DR 12.

By means of screws, the plugs are mounted to both interfaces.

Mechanical Design

For connection to the printer 07 DR 12:

(Side A): SUB-D plug, 25 pole male.

For connection to the text processor 07 KT 60:

(Side B): SUB-D plug, 25 pole male.

The terminal assignment of both plugs is the same.

So each plug can be used for each interface.

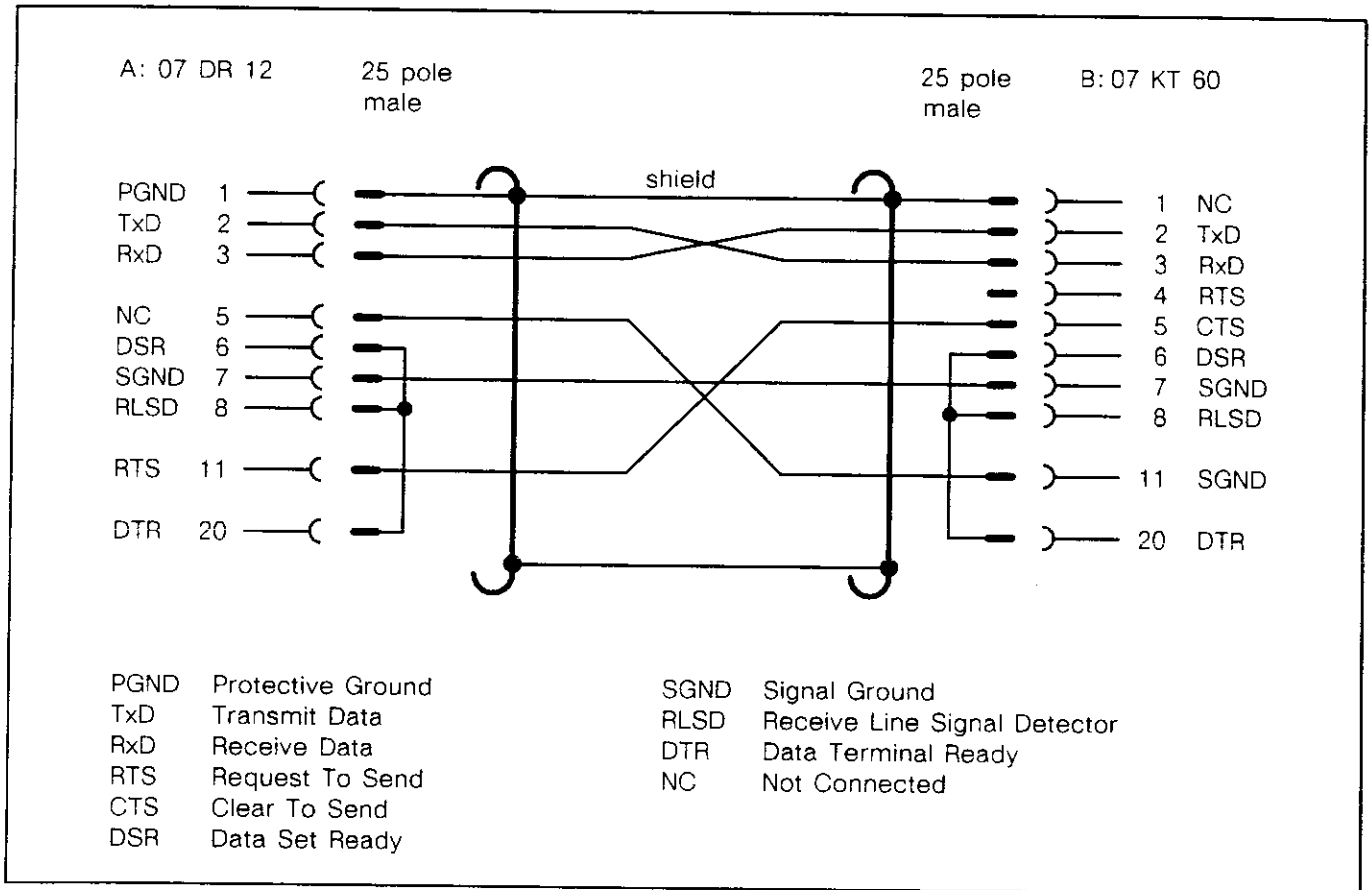

Fig. 14.11.1: Terminal assignment 07 SK 67 R1

Technical Data

Connection	from A: 07 DR 12	to B: 07 KT 60
Cable length		3 m
Weight		approx. 550 g
Order number		GJV3073912R1

14.12 Serial Interface Cable 07 SK 68 R1

for connection between the text processor 07 KT 60 and the operator station 35 BS 40, SUB-D plugs: Side A and B: 25 pole male

Intended Purpose

The cable is used for serial data transmission (RS-232-C/V24) between the text processor 07 KT 60 and the operator station 35 BS 40.

By means of screws, the plugs are mounted to both interfaces.

Mechanical Design

For connection to the operator station 35 BS 40:
(Side A): SUB-D plug, 25 pole male.

For connection to the text processor 07 KT 60:
(Side B): SUB-D plug, 25 pole male.

The terminal assignment of both plugs is the same.
So each plug can be used for each interface.

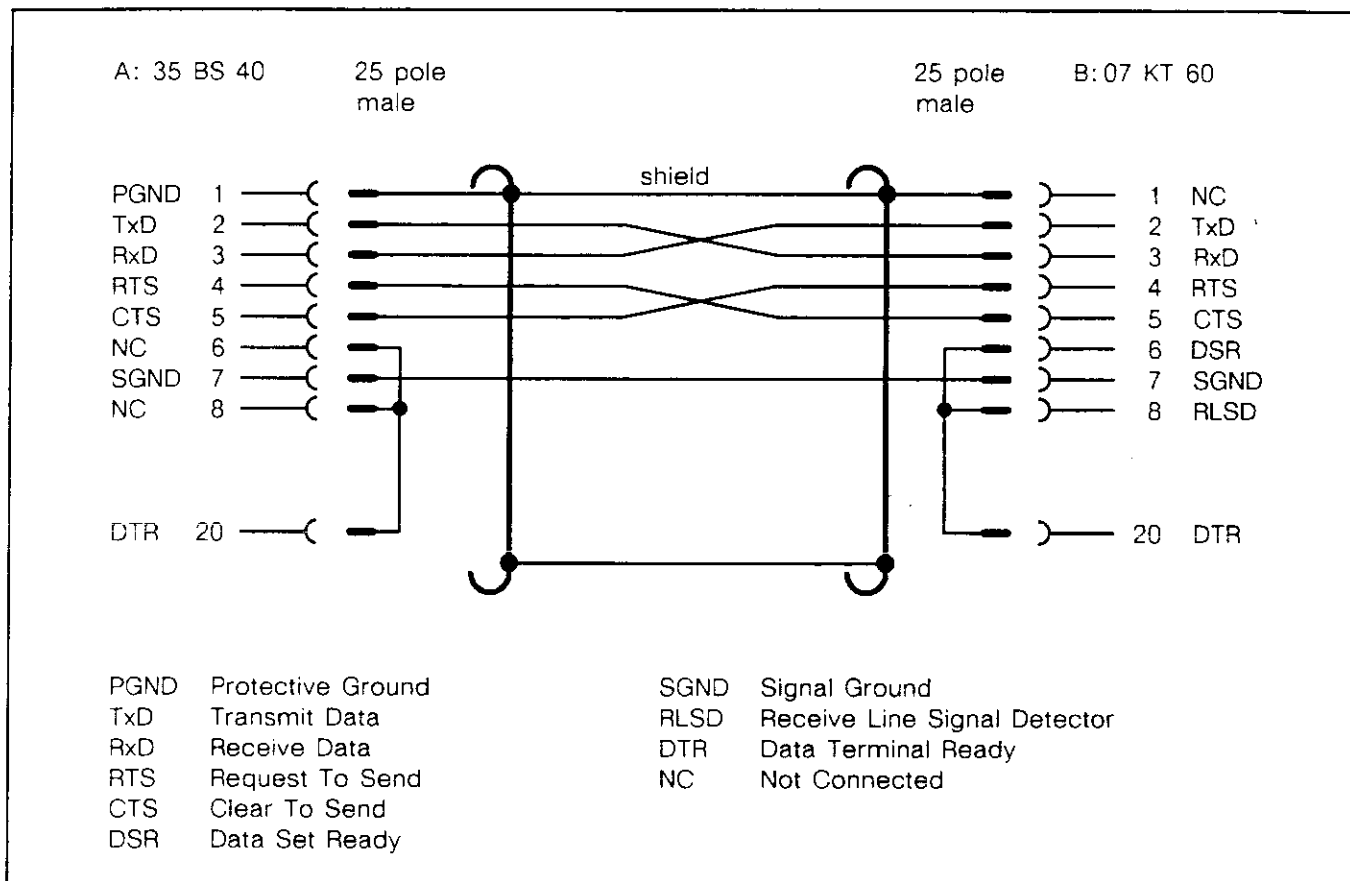

Fig. 14.12.1: Terminal assignment 07 SK 68 R1

Technical Data

Connection	from A: 35 BS 40	to B: 07 KT 60
Cable length	3 m	
Weight	approx. 550 g	
Order number:	GJV3073913R1	

14.15 Interface Cables 07 SK 90 R1, 07 SK 91 R1 and 07 SK 92 R1
for connection of peripheral units to the 9-pole serial interfaces
of the compact PLCs 07 KR 91, 07 KT 92 (ABB Procontic CS31)
and the communication processors 07 KP 62, 07 KP 63 and 07 KP 64
(ABB Procontic T200) and 07 KP 90 (ABB Procontic CS31)

14.15.1 Survey table

The following table shows, which interface cables can be used for connections between the peripheral units and the 9-pole interfaces of the CS31 compact PLCs and the T200 communication processors. In order to

connect printers no definite cables can be proposed, because printers of different make have different interface pin assignments. However, under 14.15.5 a schematic diagram of a possible interface cable is proposed to connect the 07 DR 12 printer.

Connection from the processor unit, interface,	through the system cable (interface cable)	to the peripheral unit.
07 KR 91 COM1 07 KT 92 COM1 07 KP 62 COM1	07 SK 90	Programming unit 07 PH 32 with 907 PC 331
07 KR 91 COM1 07 KT 92 COM1 07 KP 62 COM1	07 SK 90	Operating station 35 BS 93 in active mode
07 KR 91 COM1 07 KT 92 COM1 07 KP 62 COM1 07 KP 63 COM1 07 KP 64 CONSOLE 07 KP 90 CONSOLE	07 SK 90	Terminal
07 KR 91 COM1 07 KT 92 COM1 07 KT 92 COM2 07 KP 62 COM1 07 KP 62 COM2	07 SK 91	Operating station 35 BS 40
07 KR 91 COM1 07 KT 92 COM1 07 KT 92 COM2 07 KP 62 COM1 07 KP 62 COM2	07 SK 91	Operating station 35 BS 93 in passive mode
07 KR 91 COM1 07 KT 92 COM1 07 KT 92 COM2 07 KP 62 COM1 07 KP 62 COM2 07 KP 64 RCOM 07 KP 90 RCOM	07 SK 92	Modem with a standard interface, for signal names and pin assignment see 14.15.4
07 KR 91 COM1 07 KT 92 COM1 07 KT 92 COM2 07 KP 62 COM1 07 KP 62 COM2	special printer cable, suitable for the used printer	Printer, under 14.15.5 a schematic diagram of an interface cable is proposed to connect the 07 DR 12 printer

14.15.2 Interface Cable 07 SK 90 R1 with adaptor

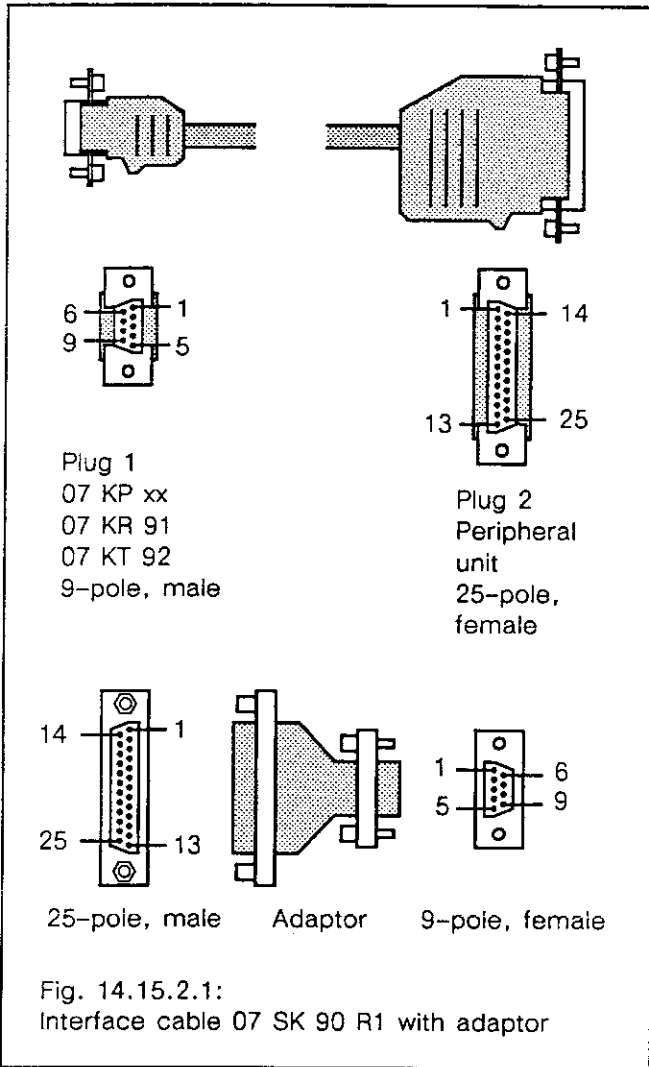

Intended Purpose

The cable 07 SK 90 is used to connect a 9-pole serial interface connector of CS31 compact PLCs or T200 communication processors with a peripheral unit in order to operate in programming or active mode (see 14.15.1 Survey table). If the peripheral unit has a 9-pole connector, the adaptor provided with (25-pole to 9-pole) can be employed for adaption.

Mechanical Design

Plug 1

SUB-D plug, 9-pole male, on the side of 07 KP 6x, 07 KR 91, 07 KT 92.

The housing is metal-plated, the shield is connected to the metal plate.

Plug 2

SUB-D plug, 25-pole female, on the side of the peripheral unit.

The plugs are mounted to both interfaces by means of screws.

Cable type

LICYCY 5 x 0.14/15

Adaptor provided

25-pole male/9-pole female for connection of peripheral units with 9-pole interfaces (male)

Technical Data

Length	5 m
Weight	220 g
Order number	GJR5 2502 00 R1

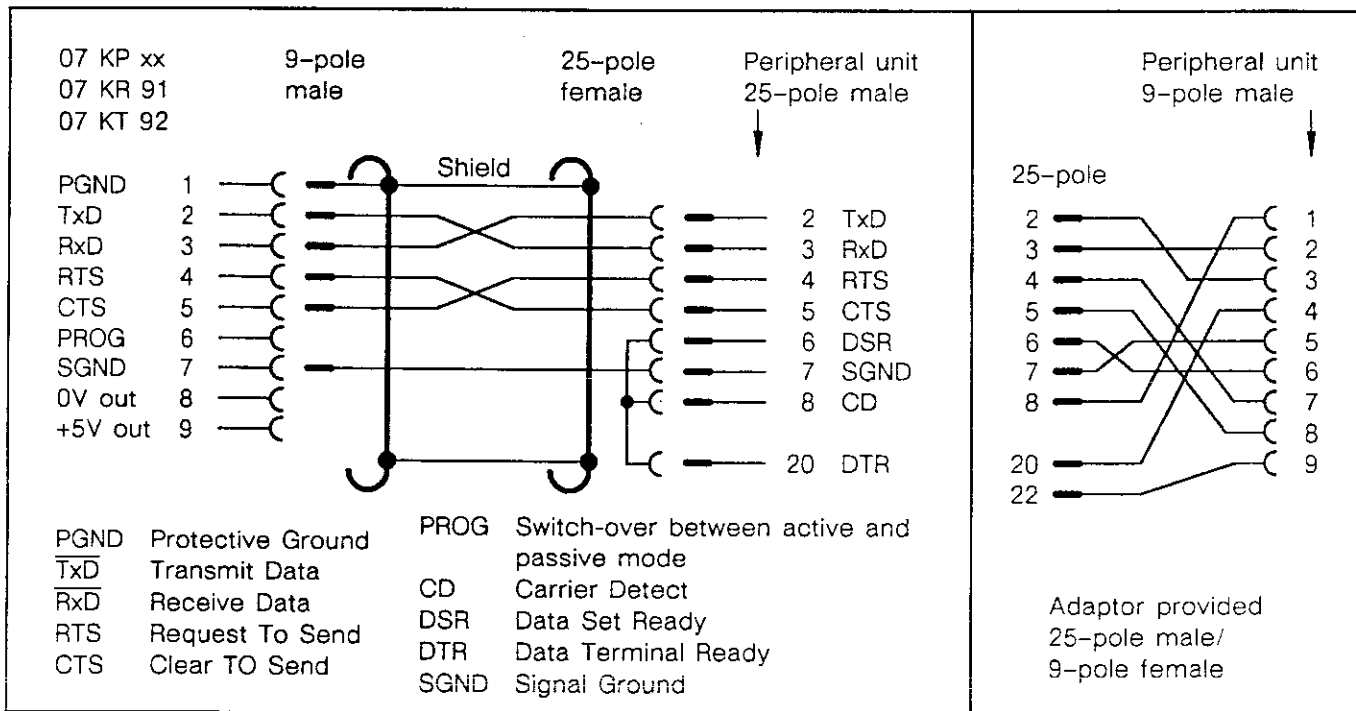
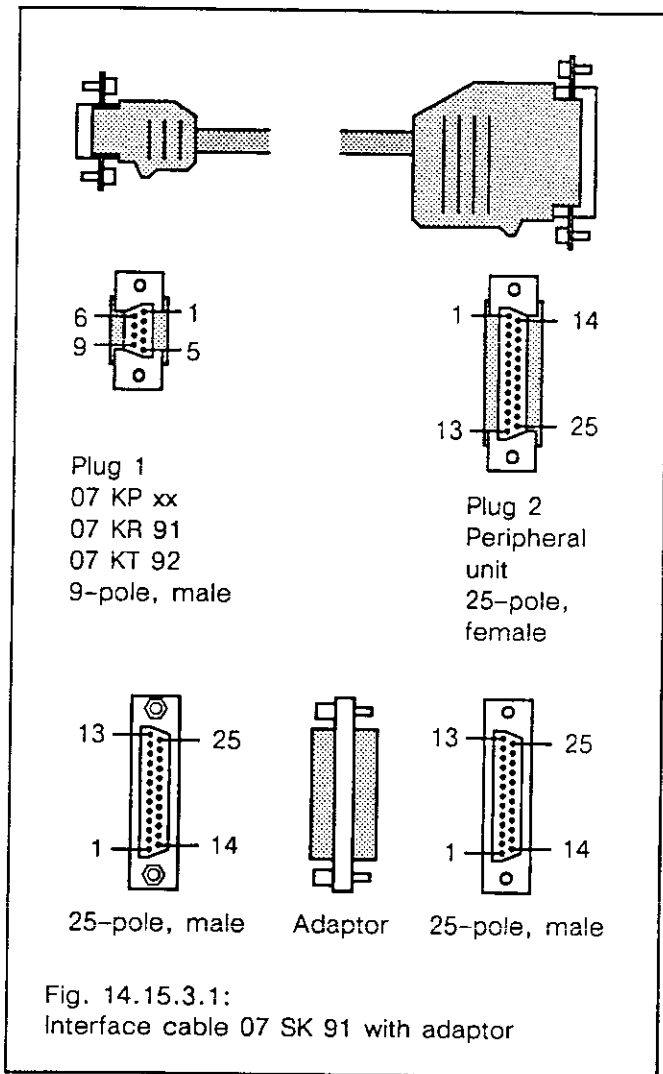

Fig. 14.15.2.2: Terminal assignment of the 07 SK 90 interface cable and the adaptor provided with

14.15.3 Interface Cable 07 SK 91 R1 with adaptor



Intended Purpose

The cable 07 SK 91 is used to connect a 9-pole serial interface connector of CS31 compact PLCs or T200 communication processors with a peripheral unit in order to operate in MMC mode or passive mode (see 14.15.1 Survey table). If the peripheral unit has a 9-pole connector, a commercially available adaptor (25-pole to 9-pole) has to be employed for adaption.

Mechanical Design

Plug 1

SUB-D plug, 9-pole male, on the side of 07 KP 6x, 07 KR 91, 07 KT 92.

The housing is metal-plated, the shield is connected to the metal plate.

Plug 2

SUB-D plug, 25-pole female, on the side of the peripheral unit.

The plugs are mounted to both interfaces by means of screws.

Cable type

LICYCY 5 x 0.14/15

Adaptor provided

25-pole male/25-pole male for connection of peripheral units with 25-pole interfaces (female)

Technical Data

Length	5 m
Weight	220 g
Order number	GJR5 2503 00 R1

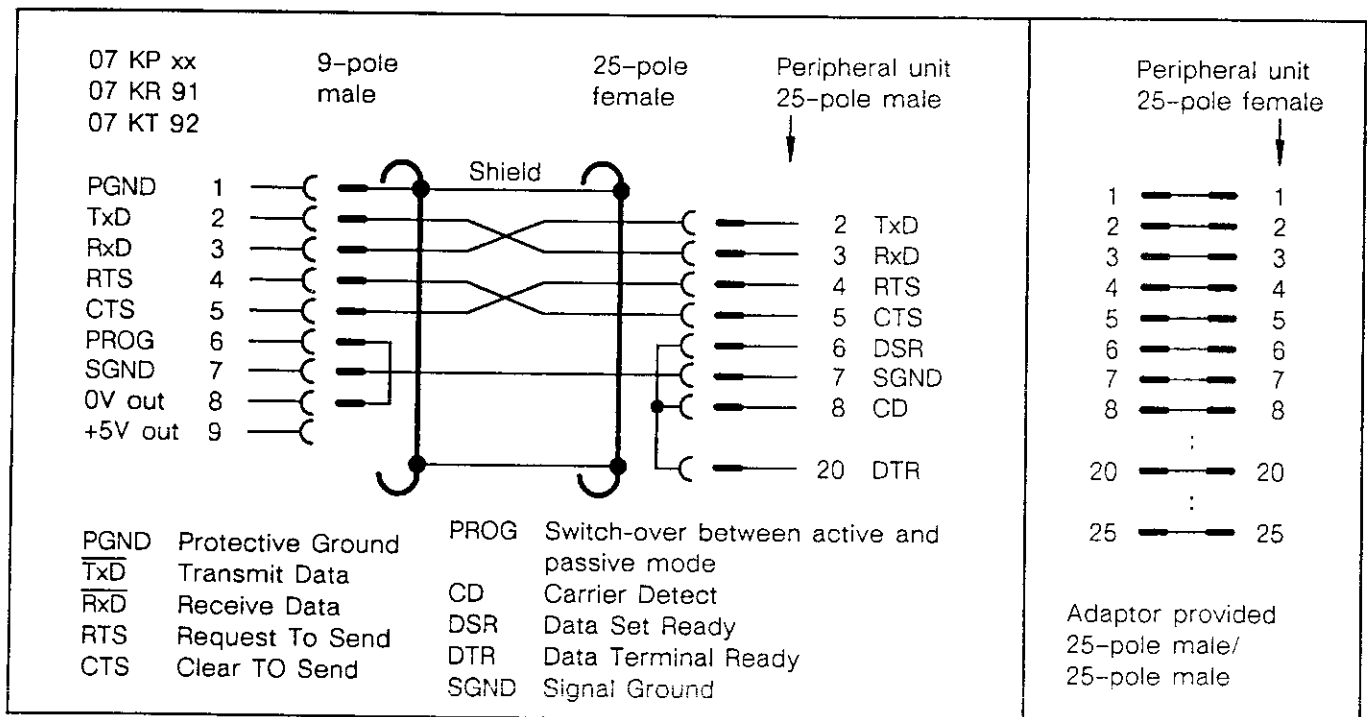
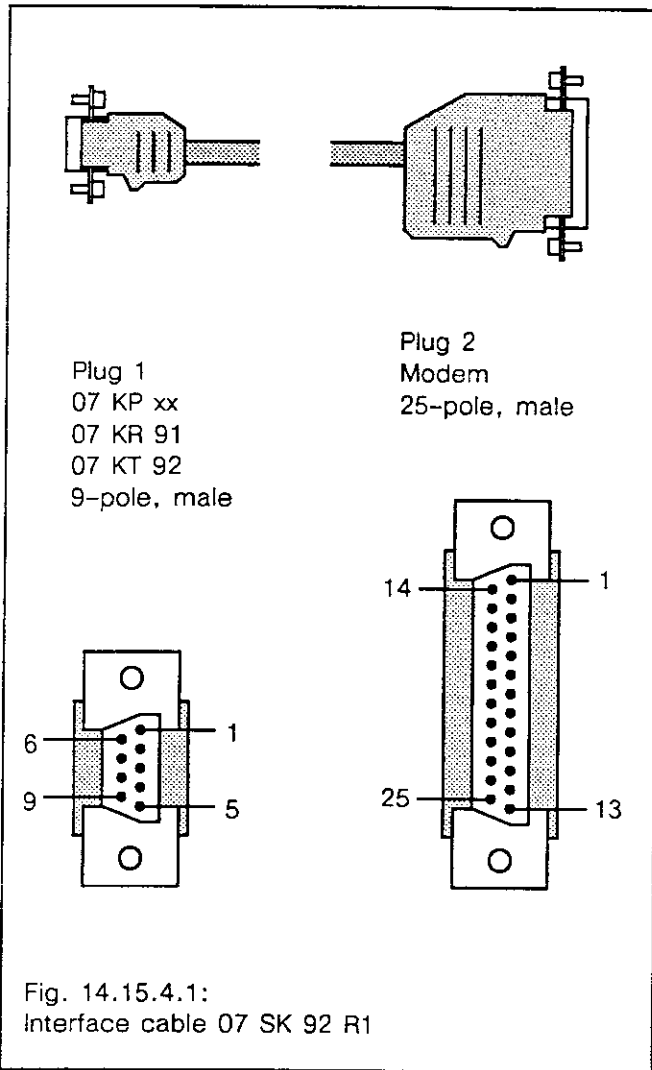

Fig. 14.15.3.2: Terminal assignment of the 07 SK 91 interface cable and the adaptor provided with it

14.15.4 Interface Cable 07 SK 92 R1



Intended Purpose

The cable 07 SK 92 is used to connect a 9-pole serial interface connector of CS31 compact PLCs or T200 communication processors with a modem with a standard interface (see 14.15.1 Survey table). If another modem has to be connected, the cable must be modified possibly.

Mechanical Design

Plug 1

SUB-D plug, 9-pole male, on the side of 07 KP 6x, 07 KR 91, 07 KT 92.

The housing is metal-plated, the shield is connected to the metal plate.

Plug 2

SUB-D plug, 25-pole male, on the side of the modem. The plugs are mounted to both interfaces by means of screws.

Cable type

LICYCY 5 x 0.14/15

Technical Data

Length	5 m
Weight	220 g
Order number	GJR5 2504 00 R1

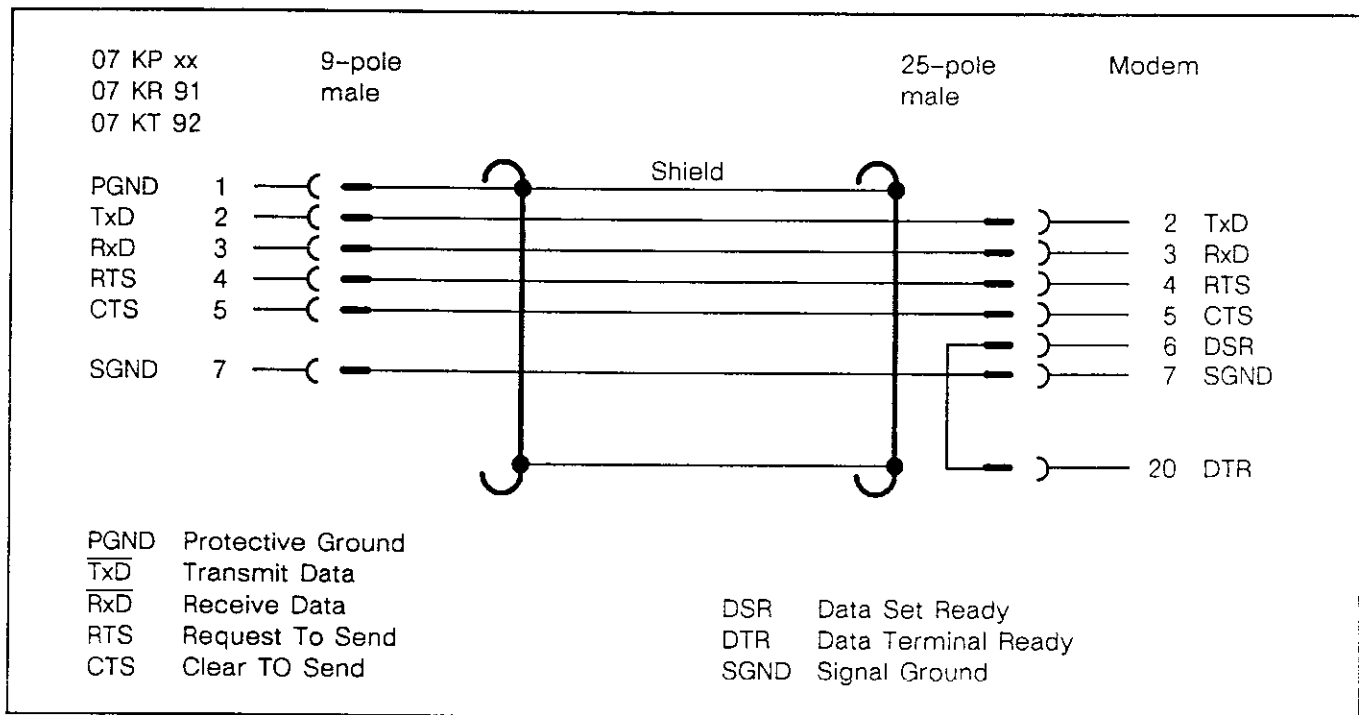
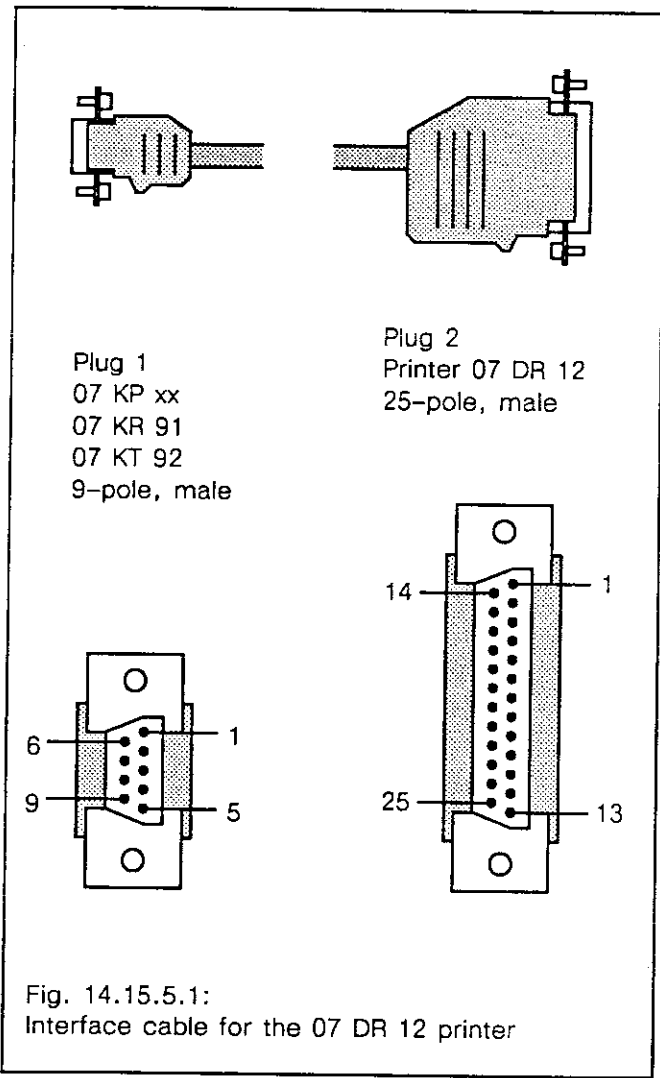

Fig. 14.15.4.2: Terminal assignment of 07 SK 92

14.15.5 Interface Cable for the 07 DR 12 printer (schematic diagram)



Intended Purpose

The shown cable can be used to connect a 9-pole serial interface connector of CS31 compact PLCs or T200 communication processors with the 07 DR 12 printer (EPSON FX 870, serial interface C823061) (see 14.15.1 Survey table). If another printer has to be connected, the cable must be modified possibly.

Mechanical Design

Plug 1

SUB-D plug, 9-pole male, on the side of 07 KP 6x, 07 KR 91, 07 KT 92. The housing is metal-plated, the shield is connected to the metal plate.

Plug 2

SUB-D plug, 25-pole male, on the side of the printer. The plugs are mounted to both interfaces by means of screws.

Usable cable type

LICYCY 5 x 0.14/15

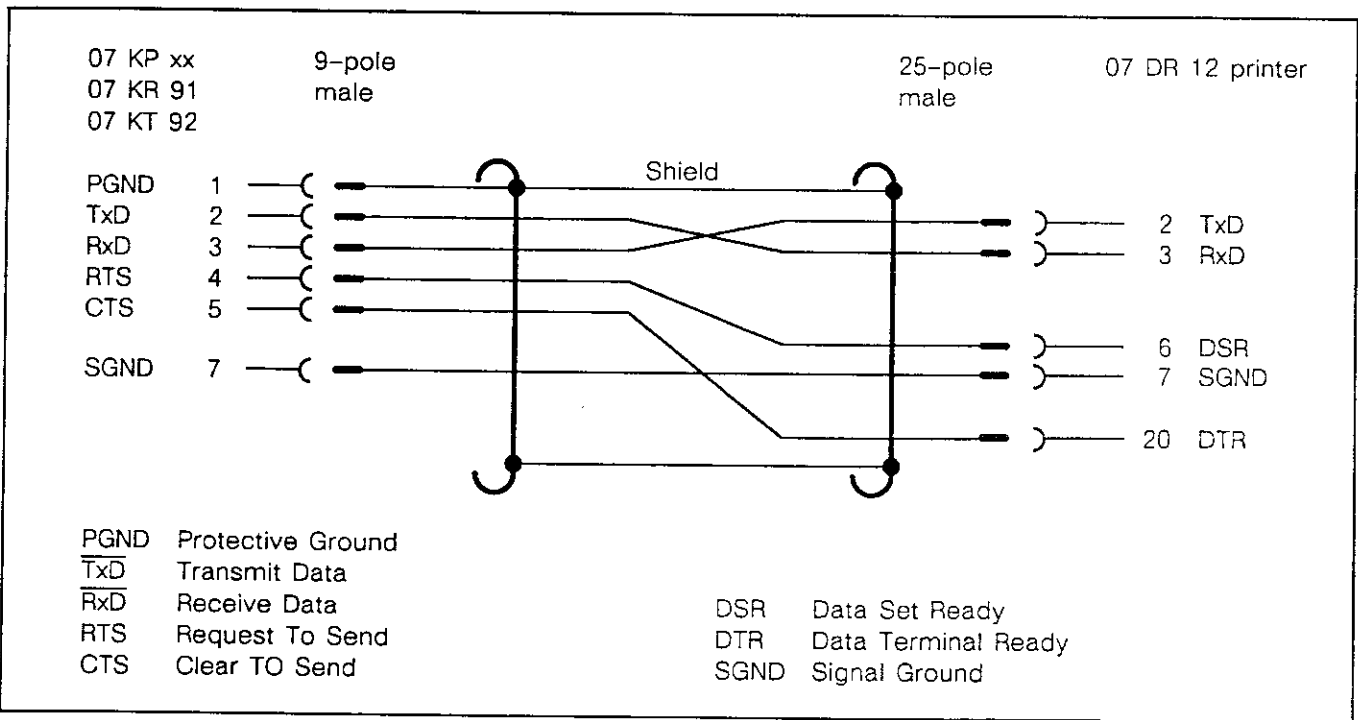

Fig. 14.15.5.2: Schematic diagram of an interface cable for the 07 DR 12 printer

14.20 Fibre-Optic Cable (Patchcord) 07 LK 60 R1 for direct connection between couplers (07 BR 60/61 R2, 07 ZB 69 R2)

Intended Purpose

The fibre-optic cable 07 LK 60 R1 is intended for direct data transmission between couplers with fibre-optic connectors (07 BR 60/61 R2 and 07 ZB 69 R2).

By means of the coupling device 07 LV 60 R1 it is possible to connect two fibre-optic cables (see 14.25, Coupling Device).

Mechanical Design

Metal-free indoor cable with an optical fibre. The Simplex cable is equipped with fibre-optic plugs at both ends. With unused cables, protecting caps protect the plug ends against damage and pollution. To assure a sufficient tensile rating, the cable contains Aramid strands. The cable sheath (cable jacket) is made of PVC.

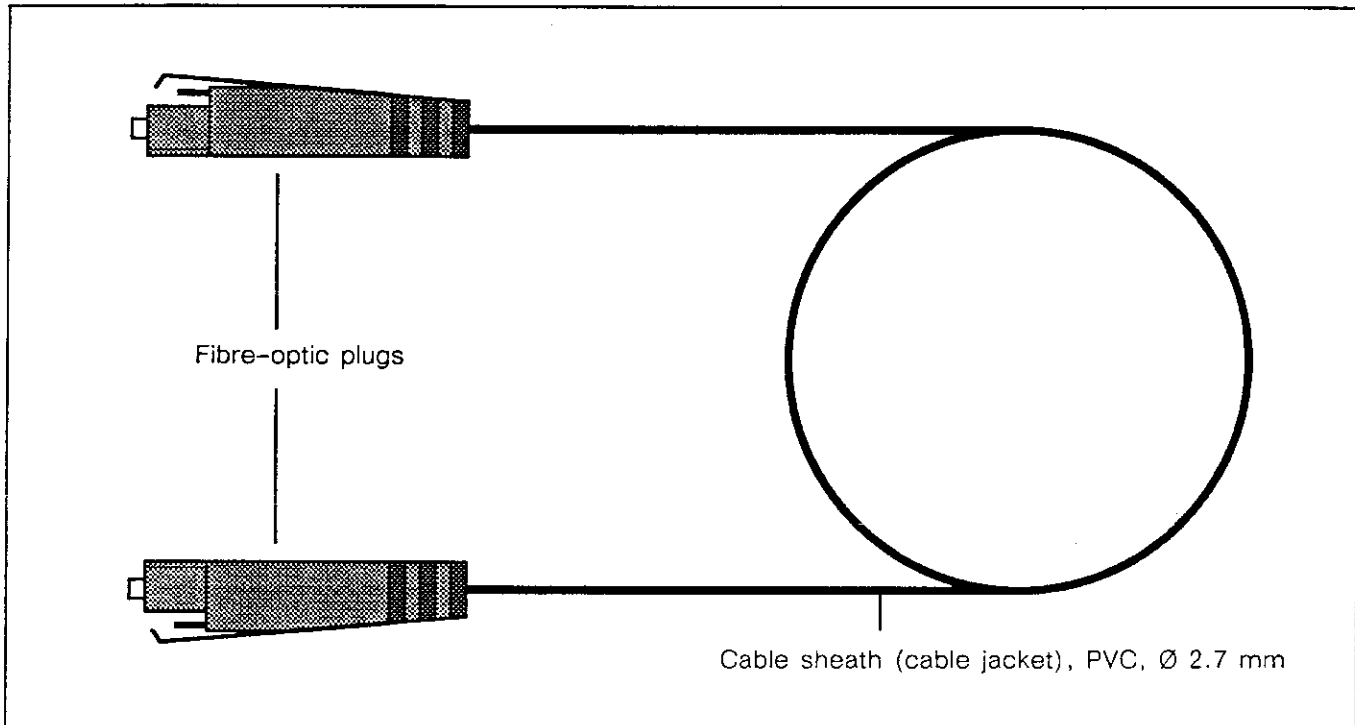

Fig. 14.20.1: Fibre-optic cable 07 LK 60 R1

Technical Data

Length	10 m
Weight	120 g
Max. tensile rating	
during installation	200 N
after installation	130 N
Min. bend radius	
during installation	80 mm
after installation	50 mm
Temperature range	
during installation	-10 ... +50 °C
after installation	-20 ... +50 °C
Diameter of optical fibre	50/125 µm
Total attenuation of the cable, both plugs inclusive ¹⁾	< 3.0 dB
Order number	GJV3075501R1

¹⁾ other optical data on demand

14.21 Fibre-Optic Cable (Pigtail) 07 LK 61 R1

for connection of couplers (07 BR 60/61 R2, 07 ZB 69 R2)
to an external optical fibre

Intended Purpose

The fibre-optic cable 07 LK 61 R1 is intended for data transmission between couplers with fibre-optic connectors (07 BR 60/61 R2 and 07 ZB 69 R2) and an external optical fibre.

Mechanical Design

Metal-free indoor cable with an optical fibre. The Simplex cable is equipped with an fibre-optic plug at one end. With unused cables, a protecting cap protects the plug end against damage and pollution. To assure a sufficient tensile rating, the cable contains Aramid strands. The cable sheath (cable jacket) is made of PVC.

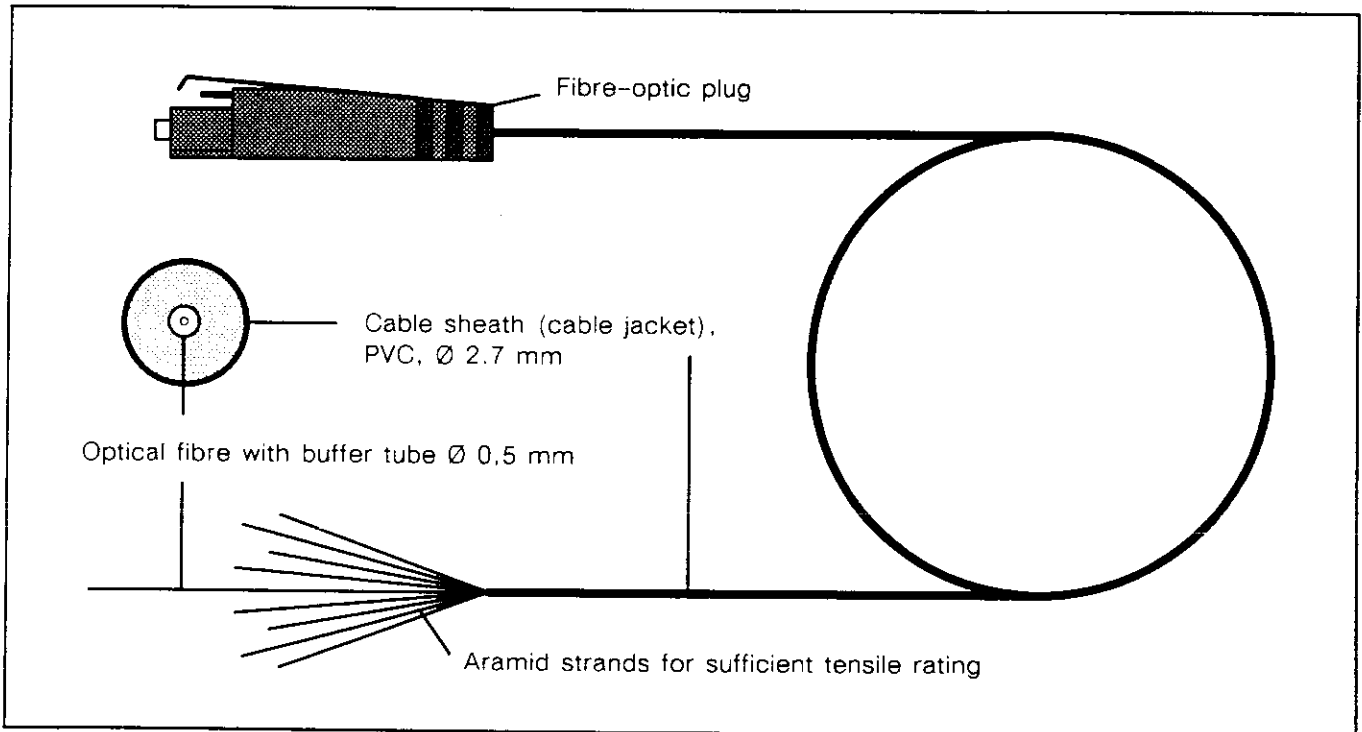

Fig. 14.21.1: Fibre-optic cable 07 LK 61 R1

Technical Data

Length	10 m
Weight	100 g
Max. tensile rating	
during installation	200 N
after installation	130 N
Min. bend radius	
during installation	80 mm
after installation	50 mm
Temperature range	
during installation	-10 ... +50 °C
after installation	-20 ... +50 °C
Diameter of optical fibre	50/125 µm
Total attenuation of the cable, plug inclusive ¹⁾	< 2.0 dB
Order number	GJV3075502R1

¹⁾ other optical data on demand

14.25 Fibre-Optic Coupling Device 07 LV 60 R1

for cable-to-cable connection and test and measurement purposes

Intended Purpose

By means of the coupling device 07 LV 60 R1 it is possible to connect two fibre-optic cables. Furthermore it serves for test and measurement purposes.

Mechanical Design

Plastic-encased device with metallic guide tubes to insert the fibre-optic plugs. With unused coupling devices, protecting caps protect the guide tubes against damage and pollution.

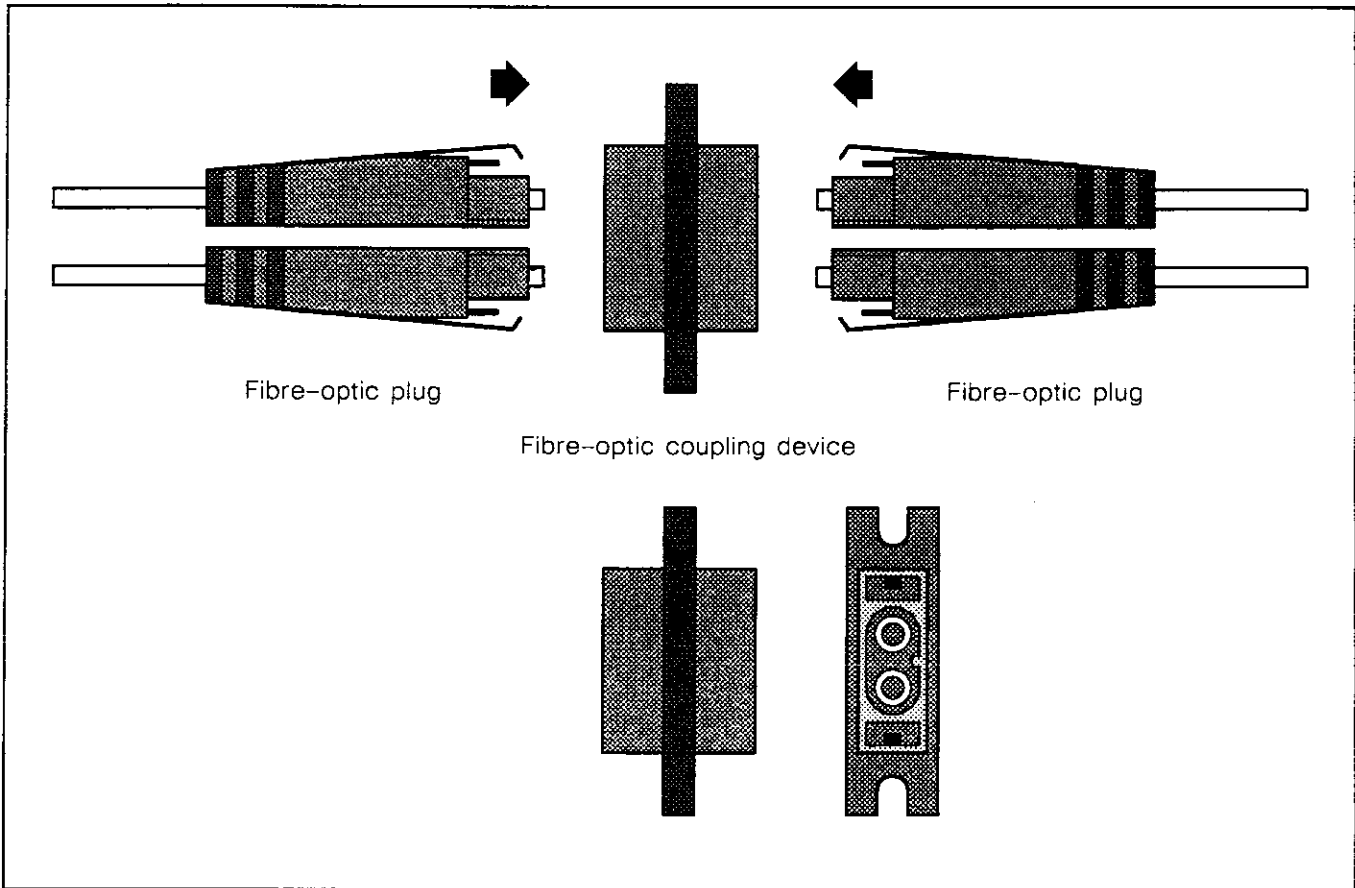

Fig. 14.25.1: Fibre-optic coupling device 07 LV 60 R1

Technical Data

Weight (incl. protecting caps)	8 g
Temperature range	-20 ... +50 °C
Attenuation of one connection	≤ 2.0 dB
Order number	GJV3075503R1

15 Accessories

- 07 PR 67: EPROM-Set for program memory 07 PR 62
- 07 PR 68: EPROM-Set for program memory 07 PR 63
- 07 LB 60 R1: Replacement lithium battery
- 07 LE 90 R1: Lithium battery module
- 07 BA 60 R1: Dummy module for empty I/O slots
- 07 NG 32 R1: Power supply unit, primary voltage 115/230 V AC, secondary voltage 24 V DC, 2.5 A
- 07 NG 34 R1: Power supply unit, primary voltage 115/230 V AC, secondary voltage 24 V DC, 5.0 A
- 07 NG 35 R1: Power supply unit, primary voltage 230/400 V 3-phase AC, secondary voltage 24 V DC, 10 A
- 07 NG 36 R1: Power supply unit, primary voltage 230/400 V 3-phase AC, secondary voltage 24 V DC, 20 A

15.1 EPROM Set 07 PR 67 for program memory 07 PR 62

The EPROM set 07 PR 67 is used in the program memory 07 PR 62 to store programs up to a size of 15.7 k instructions.

It consists of two EPROMs, which have to be plugged in the two IC sockets (low-byte and high-byte) of the program memory (see description 07 PR 62).

The EPROM set 07 PR 67 **R1** (access time 150 ns) is only suitable for use with the program memory 07 PR 62 **R1**.

The EPROM set 07 PR 67 **R2** (access time 120 ns) is suitable for use with the program memories 07 PR 62 **R1 and R2**, i.e. 07 PR 67 **R2** (with the order No.

GJR5240800R2) can replace 07 PR 67 **R1** (with the order No. GJV3074338R1).

Check following items in order after insertion of EPROMs:

1. Are the EPROMs oriented correctly in sockets (check pin 1)?
2. Are the EPROMs in the right order, i.e. low-byte in SKT0 and high-byte in SKT1.
3. Are the EPROMs settled in sockets without bent pins?

EPROMs can be damaged by an electrostatic discharge. Pay attention to the ESD precautions. Do not touch the pins.

Technical Data

Capacity

15.7 k instructions

Order numbers for EPROM sets 07 PR 67

for use with 07 PR 62 **R1**: 07 PR 67 **R1**

GJV3074338R1 (R1 will not be available in the future)

for use with 07 PR 62 **R2 and R1**: 07 PR 67 **R2**

GJR5240800R2

15.2 EPROM Set 07 PR 68 for program memory 07 PR 63

The EPROM set 07 PR 68 is used in the program memory 07 PR 63 to store programs up to a size of 48.5 k instructions.

It consists of two EPROMs, which have to be plugged in the two IC sockets (low-byte and high-byte) of the program memory (see description 07 PR 63).

The EPROM set 07 PR 68 **R1** (access time 150 ns) is only suitable for use with the program memory 07 PR 63 **R1**.

The EPROM set 07 PR 68 **R2** (access time 120 ns) is suitable for use with the program memories 07 PR 63 **R1 and R2**, i.e. 07 PR 68 **R2** (with the order No.

GJR5240900R2) can replace 07 PR 68 **R1** (with the order No. GJV30743389R1).

Check following items in order after insertion of EPROMs:

1. Are the EPROMs oriented correctly in sockets (check pin 1)?
2. Are the EPROMs in the right order, i.e. low-byte in SKT0 and high-byte in SKT1.
3. Are the EPROMs settled in sockets without bent pins?

EPROMs can be damaged by an electrostatic discharge. Pay attention to the ESD precautions. Do not touch the pins.

Technical Data

Capacity

48.5 k instructions

Order numbers for EPROM sets 07 PR 68

for use with 07 PR 63 **R1**: 07 PR 68 **R1**

GJV3074339R1 (R1 will not be available in the future)

for use with 07 PR 63 **R2 and R1**: 07 PR 68 **R2**

GJR5240900R2

15.3 Replacement Lithium Battery 07 LB 60 R1 usable in all program memories and several processor units

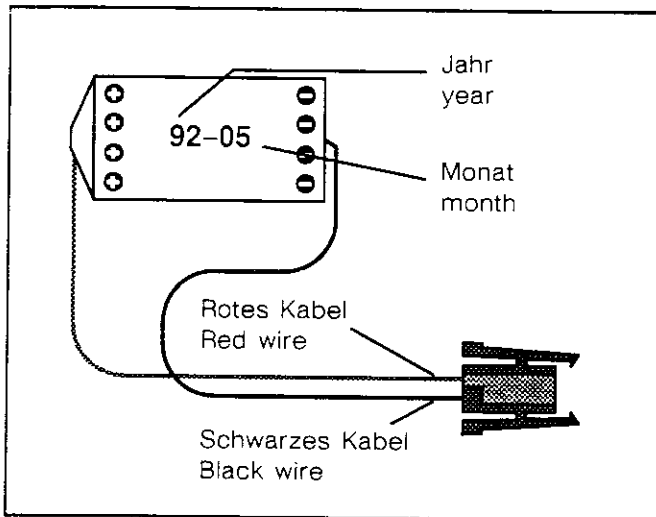

Fig. 15.3-1: Replacement lithium battery 07 LB 60

The 07 LB 60 R1 replacement lithium battery is used for data back-up in program memories and several processor units of the ABB Procontic T200 programmable control system. In order to change the battery quickly, it is equipped with a 2-pole plug and two soldered wires (see Fig. 15.3-1).

The following handling advice has to be taken into due consideration:

- Use only genuine ABB replacement lithium batteries.
- Replace battery before it is fully exhausted.
- **Do not short-circuit battery!** It may cause overheating or explosion. Prevent accidental short-circuit. Therefore, do not put battery into metallic boxes or on metallic surfaces.
- **Do not try to charge battery!** It may cause overheating or explosion.
- **Replace battery only during the power is on.** Otherwise you can lose data.
- **Dispose of the battery ecologically!**
- **Pay attention to the battery monitoring facilities on the devices, e.g.,**

LED indications, whether the battery is exhausted or missing. The battery lifetime depends on the unit where it is installed.

Battery Lifetime

The value of the battery lifetime says how long the battery is able to back-up the stored data while the unit is not supplied by the internal voltages. If the internal volt-

ages are switched on, the battery is only discharged by its own leakage current.

Type of unit, where the battery is installed

Battery lifetime t (guaranteed values)

07 PS 60 R1	min. 12 500 h
07 PS 60 R2	min. 6 300 h
07 PS 61 R1	min. 12 500 h
07 PS 61 R2	min. 6 300 h
07 PS 61 R3	min. 4 200 h
07 PS 62 R1	min. 6 300 h
07 PS 62 R2	min. 4 200 h
07 PS 62 R3	min. 3 200 h
07 PS 63 R1	min. 2 400 h
07 PS 63 R2	min. 4 200 h
07 PS 63 R3	min. 3 200 h
07 PR 62 R1	min. 12 500 h
07 PR 62 R2	min. 4 200 h
07 PR 63 R1	min. 6 300 h
07 PR 63 R2	min. 4 200 h
07 KT 60, 07 IR 60, 07 UD 60	2 years

Technical Data

see next page

Technical Data

Capacity	1500 mAh
Storage temperature	- 10 °C...+ 75 °C
Operating temperature	0 °C...+ 55 °C
No-load voltage	3.7 V
Rated voltage	3.6 V
Temperature coefficient of rated voltage	ca. -1 mV/K
Temperature coefficient of capacity	≤ -1.5 % @ 0...70 °C
Self discharge	≤ 1.6 % per year @ 60 °C ≤ 0.8 % per year @ 20 °C
Weight	15 g
Dimensions	18 mm x 35 mm
Order number	GJV3074399R1

15.4 Lithium Battery Module 07 LE 90 R1 for data back-up in processor units of ABB Procontic systems

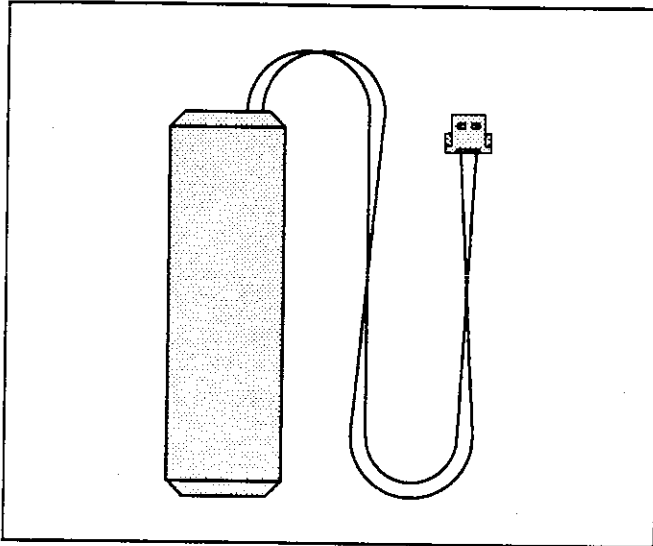

Fig. 15.4-1: Lithium battery module 07 LE 90 R1

The 07 LE 90 R1 lithium battery module is used for RAM data back-up in several processor units of ABB Procontic programmable control systems. In order to change

the battery quickly, it is equipped with a 2-pole plug and two soldered wires (see Fig. 15.4-1).

The following handling advice has to be taken into due consideration:

- Use only genuine ABB lithium battery modules.
- Replace battery before it is fully exhausted.
- **Do not short-circuit battery!** It may cause overheating or explosion. Prevent accidental short-circuit. Therefore, do not put battery into metallic boxes or on metallic surfaces.
- **Do not try to charge battery!** It may cause overheating or explosion.
- **Replace battery only during the power is on.** Otherwise you can lose data.
- **Dispose of the battery ecologically!**
- **Pay attention to the battery monitoring facilities on the devices, e.g.,**

LED indications, whether the battery is exhausted or missing. The battery lifetime depends on the unit where it is installed.

Battery Lifetime

The value of the battery lifetime says how long the battery is able to back-up the stored data while the unit is not supplied by the internal voltages. If the internal volt-

ages are switched on, the battery is only discharged by its own leakage current.

Type of unit, where the battery is installed

Battery lifetime t (guaranteed values @ 25 °C)

07 KP 62 R101 (ABB Procontic T200)	min. 5 000 h
07 KP 63 R101 (ABB Procontic T200)	min. 5 000 h
07 KR 91 (ABB Procontic CS31)	min. 4 200 h
07 KT 92 (ABB Procontic CS31)	min. 4 200 h

Technical Data

Capacity	1000 mAh
Storage temperature	- 10 °C...+ 75 °C
Operating temperature	0 °C...+ 55 °C
No-load voltage	3.6 V
Rated voltage	3.5 V
Temperature coefficient of rated voltage	ca. -1 mV/K
Temperature coefficient of capacity	≤ -1,5 % @ 0...70 °C
Self discharge	≤ 3.0 % per year @ 25 °C ≤ 6.0 % per year @ 40 °C ≤ 25.0 % per year @ 70 °C
Weight	20 g
Dimensions	18 mm x 53 mm
Order number	GJR5250700R1

15.5 Dummy Module 07 BA 60 R1 for empty I/O slots

Not occupied slots of ABB Procontic T200 basic and expansion subracks can be filled with dummy modules. 1 dummy module 07 BA 60 R1 occupies 1 I/O slot.

Technical Data

Number of occupied slots	1 I/O slot
Weight	245 g
Order number	GJV3074397R1

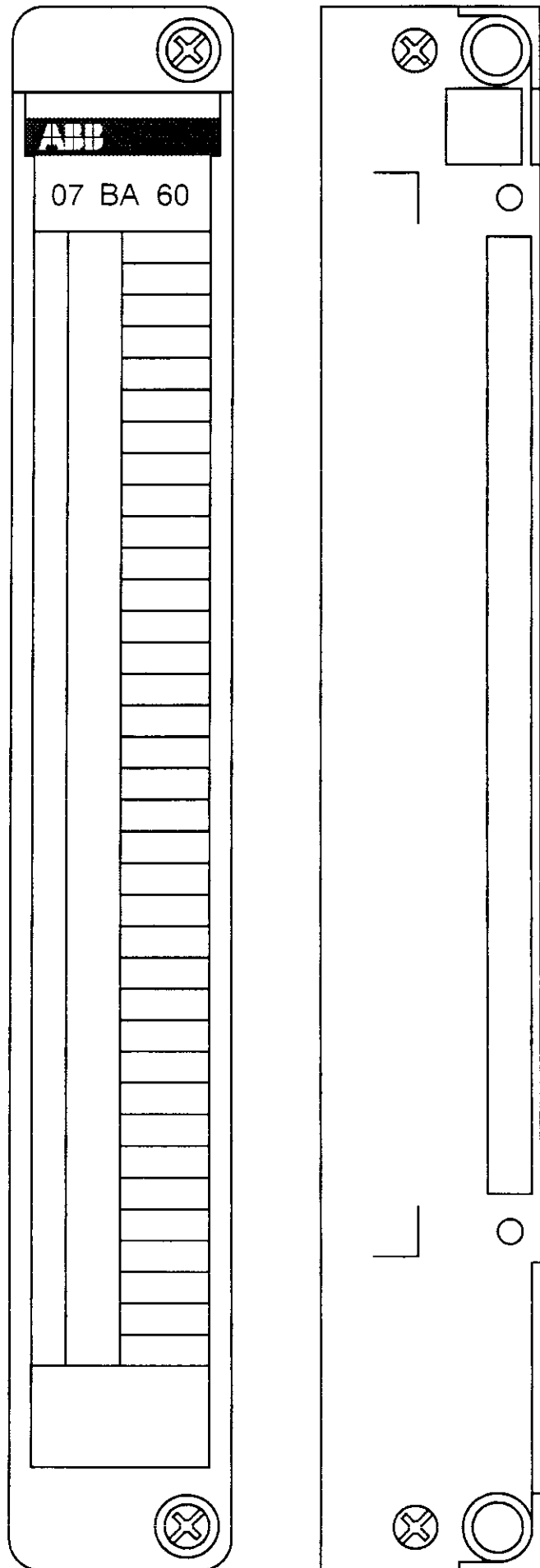

Fig. 15.5.1 (left): Dummy module 07 BA 60 R1, top view

Fig. 15.5.1 (right): Dummy module 07 BA 60 R1, front panel removed

15.11 Power Supply Unit 07 NG 32 R1

primary voltage: 115/230 V AC, secondary voltage: 24 V DC, 2.5 A

The 07 NG 32 power supply unit generates a 24 V DC voltage from a single-phase mains voltage of 115 V AC or 230 V AC. For applications in electronic control systems, the output voltage is smoothed by electrolytic capacitors. The power supply unit has a load capability of 2.5 A. A green LED indicates that the 24 V DC is present.

The primary and the secondary voltage are protected by built-in miniature fuses (5 x 20 mm). The electrical connections are made over screw-type terminals (see Fig. 15.11-1, Top view with circuit diagram imprint and

terminal assignment). Cable grips fasten the cables. There is an electrical isolation between the primary and the secondary voltage according to VDE 0551 (safety electrical isolation).

The power supply unit has a mounting base which allows the user to snap the unit onto a DIN rail (EN 50022). If this mounting base is removed, the unit can be fastened by 4 screws M4 (see Fig. 15.11-2, drilling pattern).

The power supply unit must be mounted so that the convection air current is not disturbed.

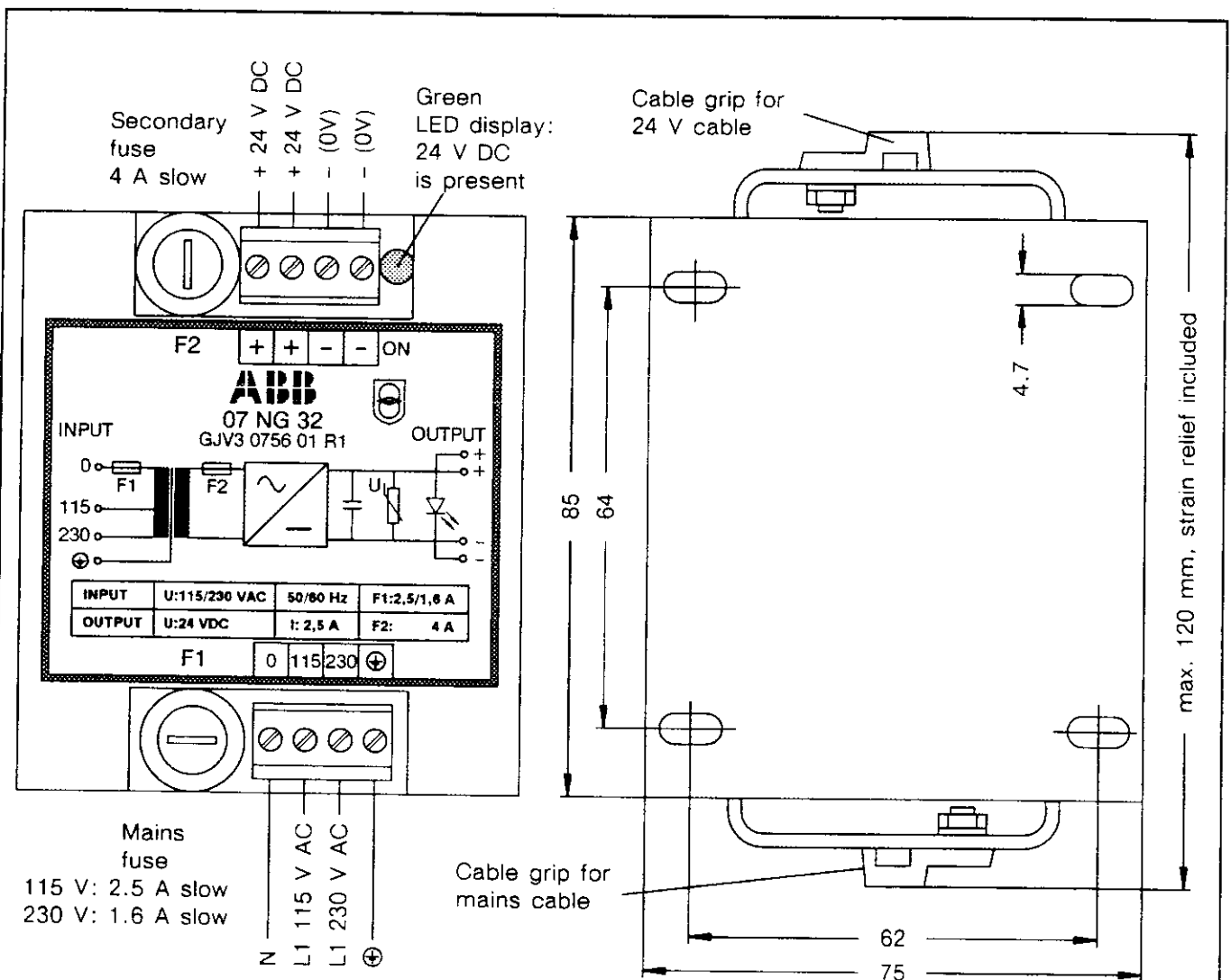

The power supply unit has a height (depth if mounted on rear panel) of ca. 145 mm.

Fig. 15.11-1: Top view with circuit diagram imprint and terminal assignment

Fig. 15.11-2: Drilling pattern and outline dimensions of the power supply unit

Technical data

Electrical data, input specifications

Primary voltage 115 V AC

Rated voltage		115 V AC
Limiting values		103.5...126.5 V AC
Mains frequency		50 or 60 Hz
Current consumption	with no load	ca. 180 mA
	with rated load	ca. 900 mA
Miniature fuse	primary	2.5 A slow, sand-filled, 5 x 20 mm

Primary voltage 230 V AC

Rated voltage		230 V AC
Limiting values		207...253 V AC
Mains frequency		50 or 60 Hz
Current consumption	with no load	ca. 90 mA
	with rated load	ca. 450 mA
Miniature fuse	primary	1.6 A slow, sand-filled, 5 x 20 mm, (this fuse is inserted by the factory)

Max. conductor cross section of the terminals 2.5 mm²

Electrical data, output specifications

Secondary voltage (output voltage)

Rated voltage	24 V DC
Limiting values	19.2...30 V DC
Max. ripple content	≤ 5 %
Display of the present voltage	with green LED

Output load capability

Rated current (permitted continuous load) 2.5 A

Miniature fuse, secondary 4.0 A medium time-lag, sand-filled

Max. conductor cross section of the terminals 2.5 mm², plus and minus poles are assigned to two terminals each

Mechanical data

Mounting onto a DIN rail or with 4 screws M4

Mechanical dimensions

Mounting base 85 x 75 mm (120 mm),
see Fig. 15.11-2, Drilling pattern

Height (depth if mounted on rear panel) 145 mm

Weight 2.2 kg

Cooling The power supply unit must be mounted so that the convection air current is not disturbed.

Ambient temperature max. 55 °C (with 100 % load)

Standards, regulations VDE 0160, transformer according to VDE 0551

Ordering data

Order number 07 NG 32 R1 GJV3 0756 01 R1

15.12 Power Supply Unit 07 NG 34 R1

primary voltage: 115/230 V AC, secondary voltage: 24 V DC, 5 A

The 07 NG 34 power supply unit generates a 24 V DC voltage from a single-phase mains voltage of 115 V AC or 230 V AC. For applications in electronic control systems, the output voltage is smoothed by electrolytic capacitors. The power supply unit has a load capability of 5 A. A green LED indicates that the 24 V DC is present.

The primary and the secondary voltage are protected by built-in miniature fuses (5 x 20 mm). The electrical connections are made over screw-type terminals (see

Fig. 15.12-1, Top view with circuit diagram imprint and terminal assignment). Cable grips fasten the cables. There is an electrical isolation between the primary and the secondary voltage according to VDE 0551 (safety electrical isolation).

The power supply is fastened by 4 screws M5 (see Fig. 15.12-2, drilling pattern).

The power supply unit must be mounted so that the convection air current is not disturbed.

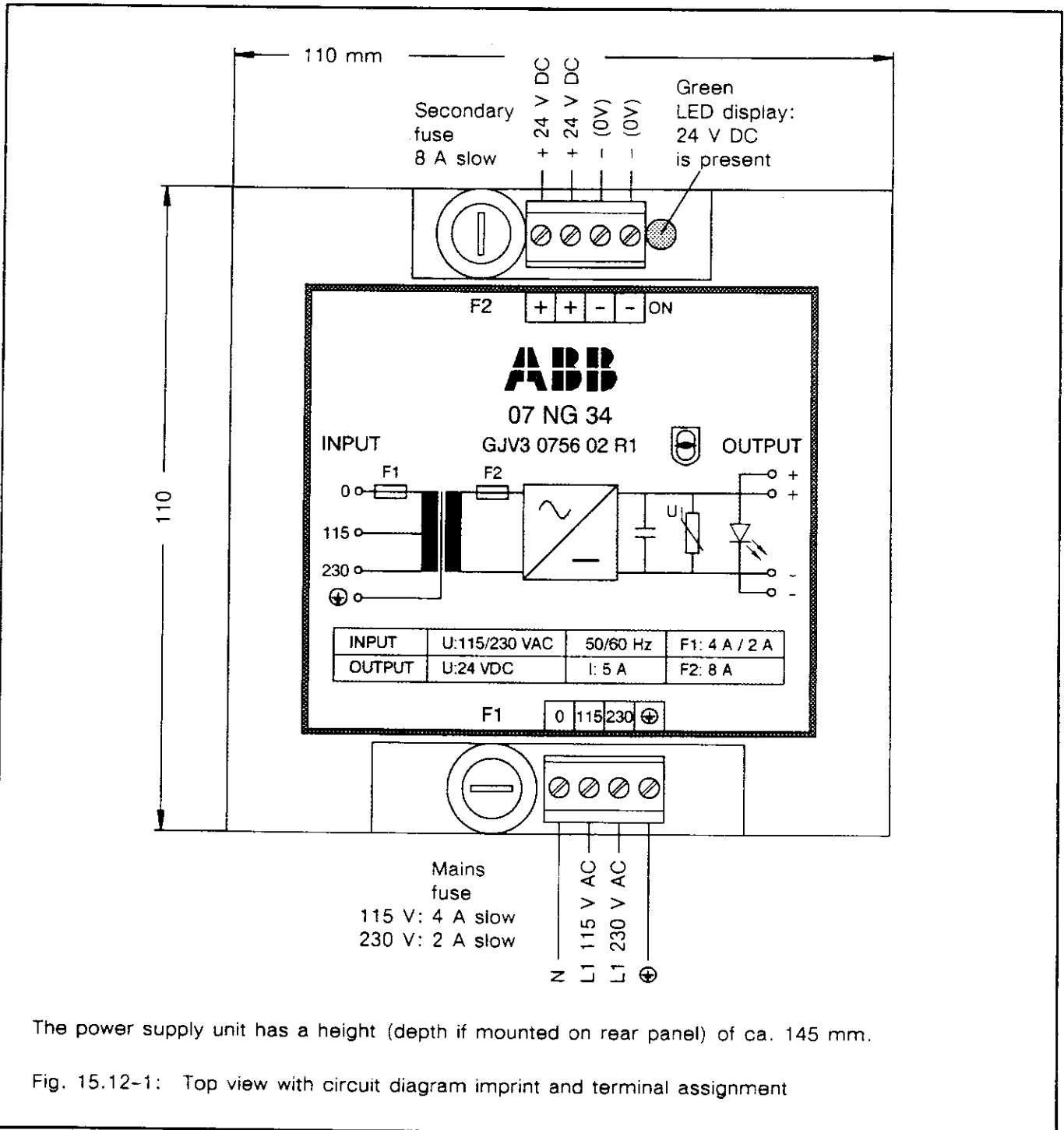

The power supply unit has a height (depth if mounted on rear panel) of ca. 145 mm.

Fig. 15.12-1: Top view with circuit diagram imprint and terminal assignment

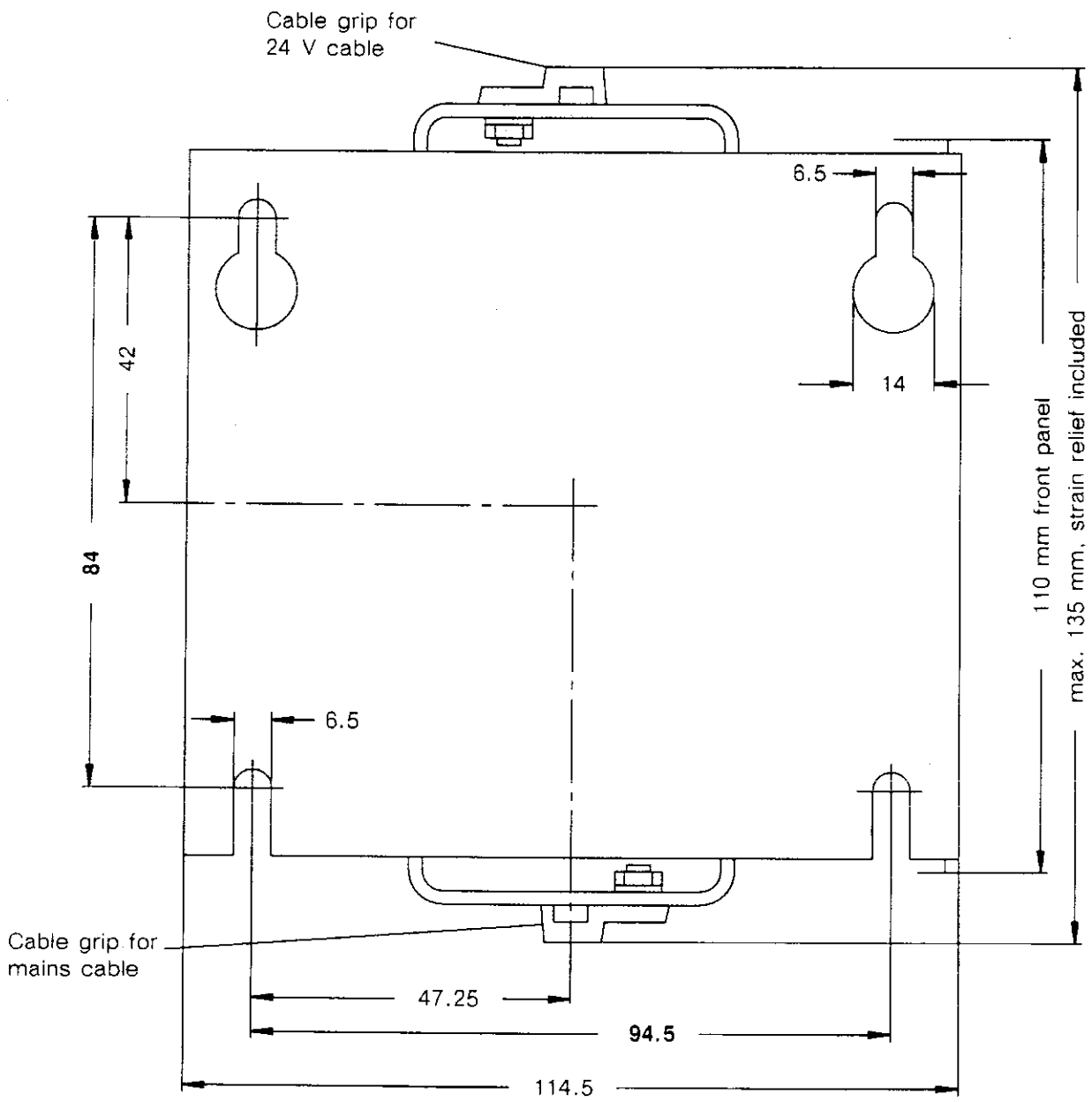

The power supply unit has a height (depth if mounted on rear panel) of ca. 145 mm.

Fig. 15.12-2: Drilling pattern and outline dimensions of the power supply unit

Technical data

Electrical data, input specifications

Primary voltage 115 V AC

Rated voltage		115 V AC
Limiting values		103.5...126.5 V AC
Mains frequency		50 or 60 Hz
Current consumption	with no load	ca. 0.35 A
	with rated load	ca. 1.60 A
Miniature fuse	primary	4 A slow, sand-filled, 5 x 20 mm

Primary voltage 230 V AC

Rated voltage		230 V AC
Limiting values		207...253 V AC
Mains frequency		50 or 60 Hz
Current consumption	with no load	ca. 0.17 A
	with rated load	ca. 0.85 A
Miniature fuse	primary	2 A slow, sand-filled, 5 x 20 mm, (this fuse is inserted by the factory)

Max. conductor cross section of the terminals 2.5 mm²

Electrical data, output specifications

Secondary voltage (output voltage)

Rated voltage	24 V DC
Limiting values	19.2...30 V DC
Max. ripple content	≤ 5 %
Display of the present voltage	with green LED

Output load capability

Rated current (permitted continuous load) 5 A

Miniature fuse, secondary

8.0 A medium time-lag, sand-filled

Max. conductor cross section of the terminals

2.5 mm², plus and minus poles are assigned to two terminals each

Mechanical data

Mounting

with 4 screws M5

Mechanical dimensions

Mounting base

110 x 110 mm (135 mm),
see Fig. 15.12-2, Drilling pattern
145 mm

Height (depth if mounted on rear panel)

Weight

4 kg

Cooling

The power supply unit must be mounted so that the convection air current is not disturbed.

Ambient temperature

max. 55 °C (with 100 % load)

Standards, regulations

VDE 0160, transformer according to VDE 0551

Ordering data

Order number 07 NG 34 R1 GJV3 0756 02 R1

15.13 Power Supply Unit 07 NG 35 R1

primary voltage: 230/400 V 3-phase AC, secondary voltage: 24 V DC, 10 A

The 07 NG 35 power supply unit generates a 24 V DC voltage from a three-phase mains voltage of 230 V AC or 400 V AC. The output voltage is gained by using a 3-phase bridge-connected rectifier. Together with a filter capacitor, this guarantees a small ripple content of the voltage. The power supply unit has a load capability of 10 A. It is suitable for applications in electronic control systems. A green LED indicates that the 24 V DC is present.

The secondary voltage is protected by a built-in B-type automatic circuit-breaker. The primary voltage (mains) has to be protected by external fuses.

The electrical connections are made over screw-type terminals. With 3-phase mains voltage of 230 V, the primary windings of the transformer are delta-connected, with 3-phase mains voltage of 400 V, the windings are star-connected (see Fig. 15.13-1). The cables are strain-relieved by cable ties. There is an electrical isolation between the primary and the secondary voltage according to VDE 0551 (safety electrical isolation).

The power supply is fastened by 4 screws M5 (see Fig. 15.13-2, drilling pattern).

The power supply unit must be mounted so that the convection air current is not disturbed.

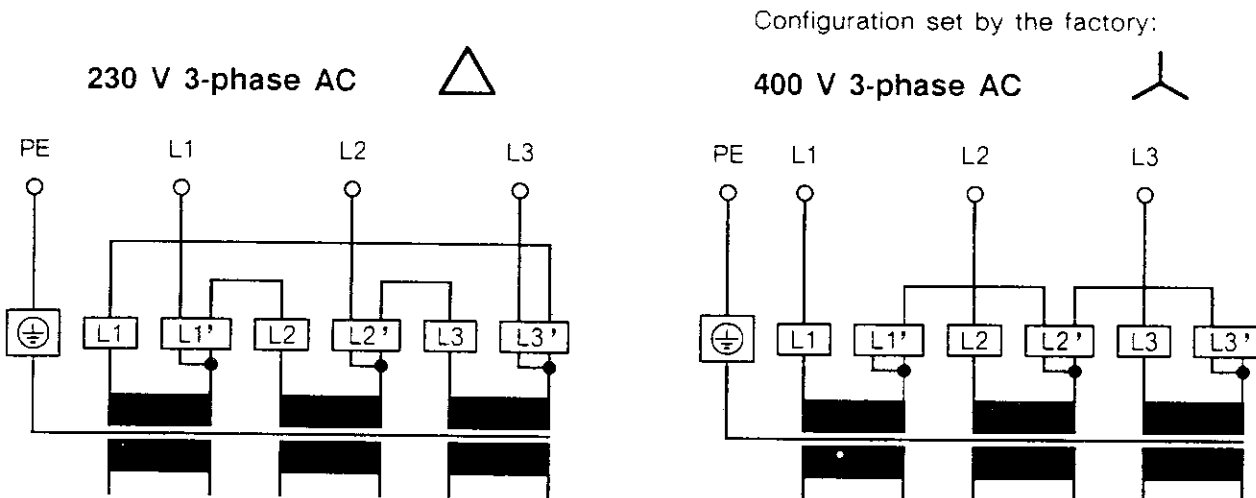
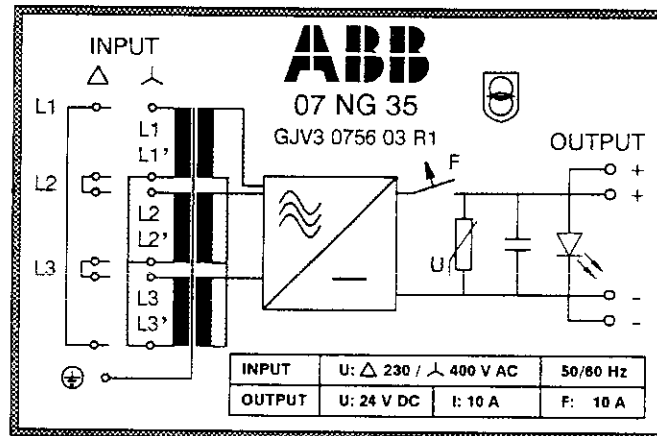
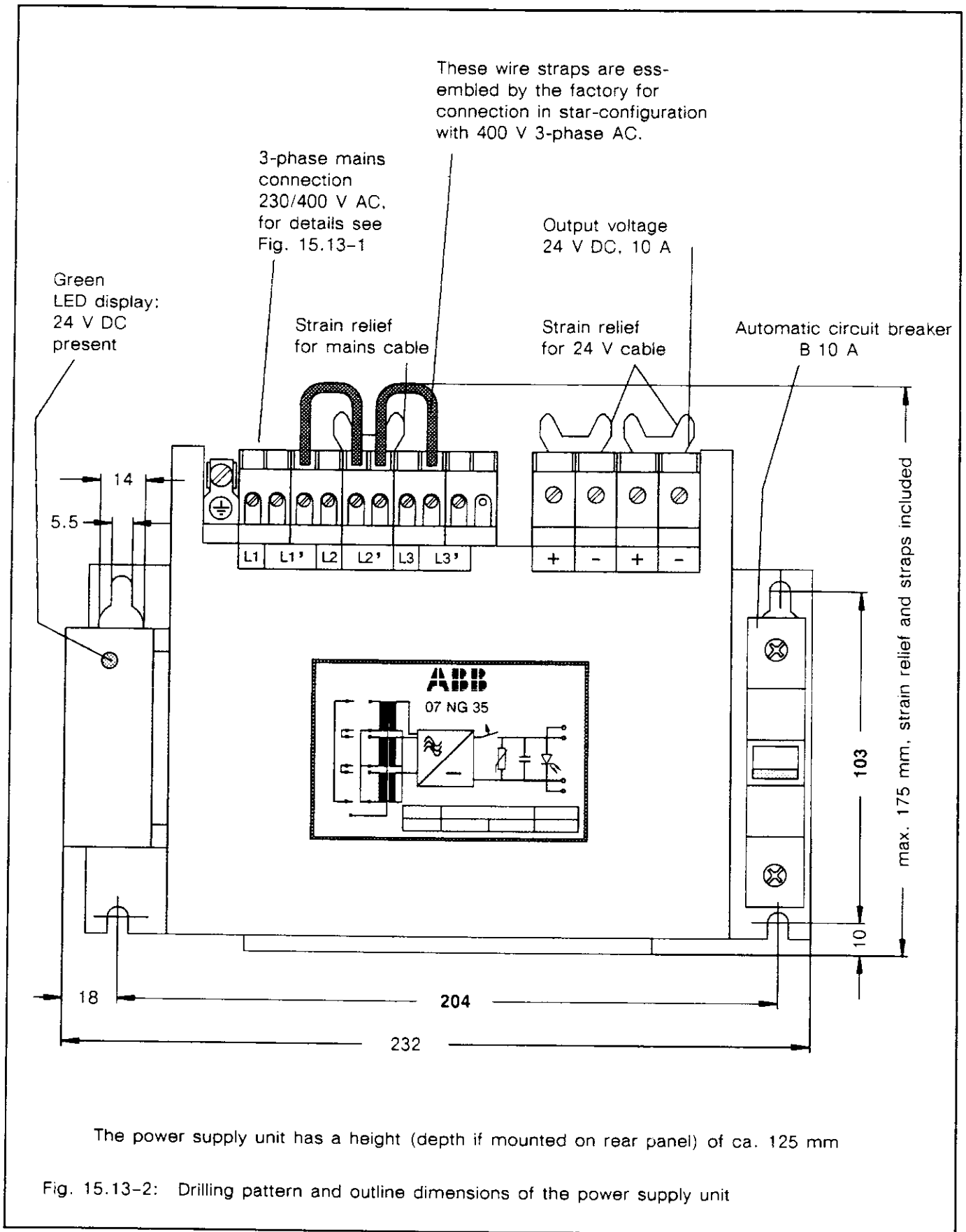

Fig. 15.13-1: Imprinted circuit diagram and terminal diagrams for 230 V and 400 V 3-phase AC



Technical data

Electrical data, input specifications

Primary voltage 230 V 3-phase AC

Rated voltage		230 V 3-phase AC
Limiting values		207...253 V AC
Mains frequency		50 or 60 Hz
Current consumption	with no load	ca. 0.22 A
	with rated load	ca. 0.85 A
Fusing	primary	external

Primary voltage 400 V 3-phase AC

Rated voltage		400 V 3-phase AC
Limiting values		360...440 V AC
Mains frequency		50 or 60 Hz
Current consumption	with no load	ca. 0.15 A
	with rated load	ca. 0.50 A
Fusing	primary	external

Max. conductor cross section of the terminals 2 x 1.5 mm²

Electrical data, output specifications

Secondary voltage (output voltage)

Rated voltage	24 V DC
Limiting values	19.2...30 V DC
Max. ripple content	≤ 2 %
Display of the present voltage	with green LED

Output load capability

Rated current (permitted continuous load) 10 A

Fusing, secondary

automatic circuit-breaker B 10 A

Max. conductor cross section of the terminals

2 x 4 mm², plus and minus poles are assigned to two terminals each

Mechanical data

Mounting with 4 screws M5

Mechanical dimensions

Mounting base 232 x 175 mm, see Fig. 15.13-2, Drilling pattern
Height (depth if mounted on rear panel) 125 mm

Weight 6 kg

Cooling The power supply unit must be mounted so that the convection air current is not disturbed.

Ambient temperature max. 55 °C (with 100 % load)

Standards, regulations VDE 0160, transformer according to VDE 0551

Ordering data

Order number 07 NG 35 R1 GJV3 0756 03 R1

15.14 Power Supply Unit 07 NG 36 R1

primary voltage: 230/400 V 3-phase AC, secondary voltage: 24 V DC, 20 A

The 07 NG 36 power supply unit generates a 24 V DC voltage from a three-phase mains voltage of 230 V AC or 400 V AC. The output voltage is gained by using a 3-phase bridge-connected rectifier. Together with a filter capacitor, this guarantees a small ripple content of the voltage. The power supply unit has a load capability of 20 A. It is suitable for applications in electronic control systems. A green LED indicates that the 24 V DC is present.

The secondary voltage is protected by a built-in B-type automatic circuit-breaker. The primary voltage (mains) has to be protected by external fuses.

The electrical connections are made over screw-type terminals. With 3-phase mains voltage of 230 V, the primary windings of the transformer are delta-connected, with 3-phase mains voltage of 400 V, the windings are star-connected (see Fig. 15.14-1). The cables are strain-relieved by cable ties. There is an electrical isolation between the primary and the secondary voltage according to VDE 0551 (safety electrical isolation).

The power supply is fastened by 4 screws M6 (see Fig. 15.14-2, drilling pattern).

The power supply unit must be mounted so that the convection air current is not disturbed.

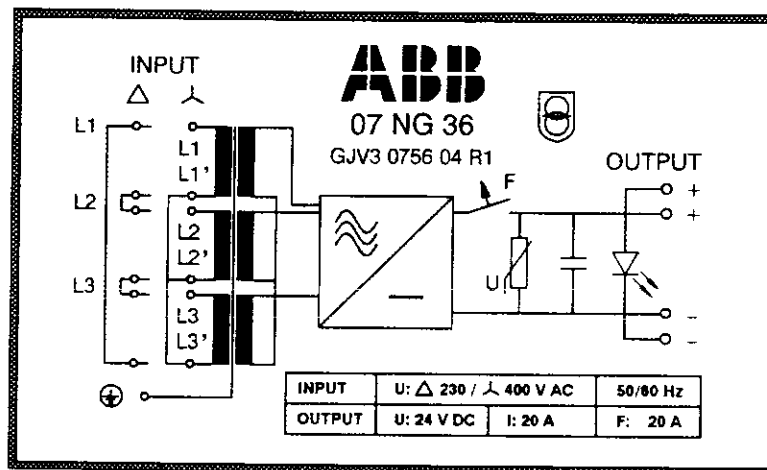

230 V 3-phase AC

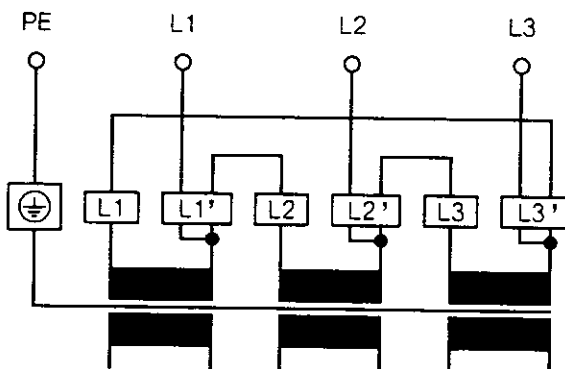

Configuration set by the factory:

400 V 3-phase AC

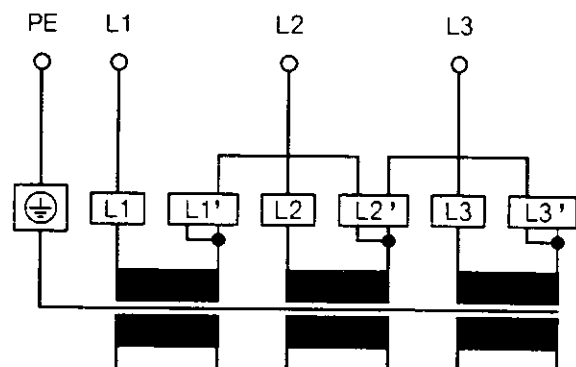

Fig. 15.14-1: Imprinted circuit diagram and terminal diagrams for 230 V and 400 V 3-phase AC

These wire straps are assembled by the factory for connection in star-configuration with 400 V 3-phase AC.

3-phase mains connection
230/400 V AC,
for details see
Fig. 15.14-1

Output voltage
24 V DC, 20 A

Strain relief
for 24 V cable

Automatic circuit breaker
B 20 A

Green
LED display:
24 V DC
present

Strain relief
for mains cable

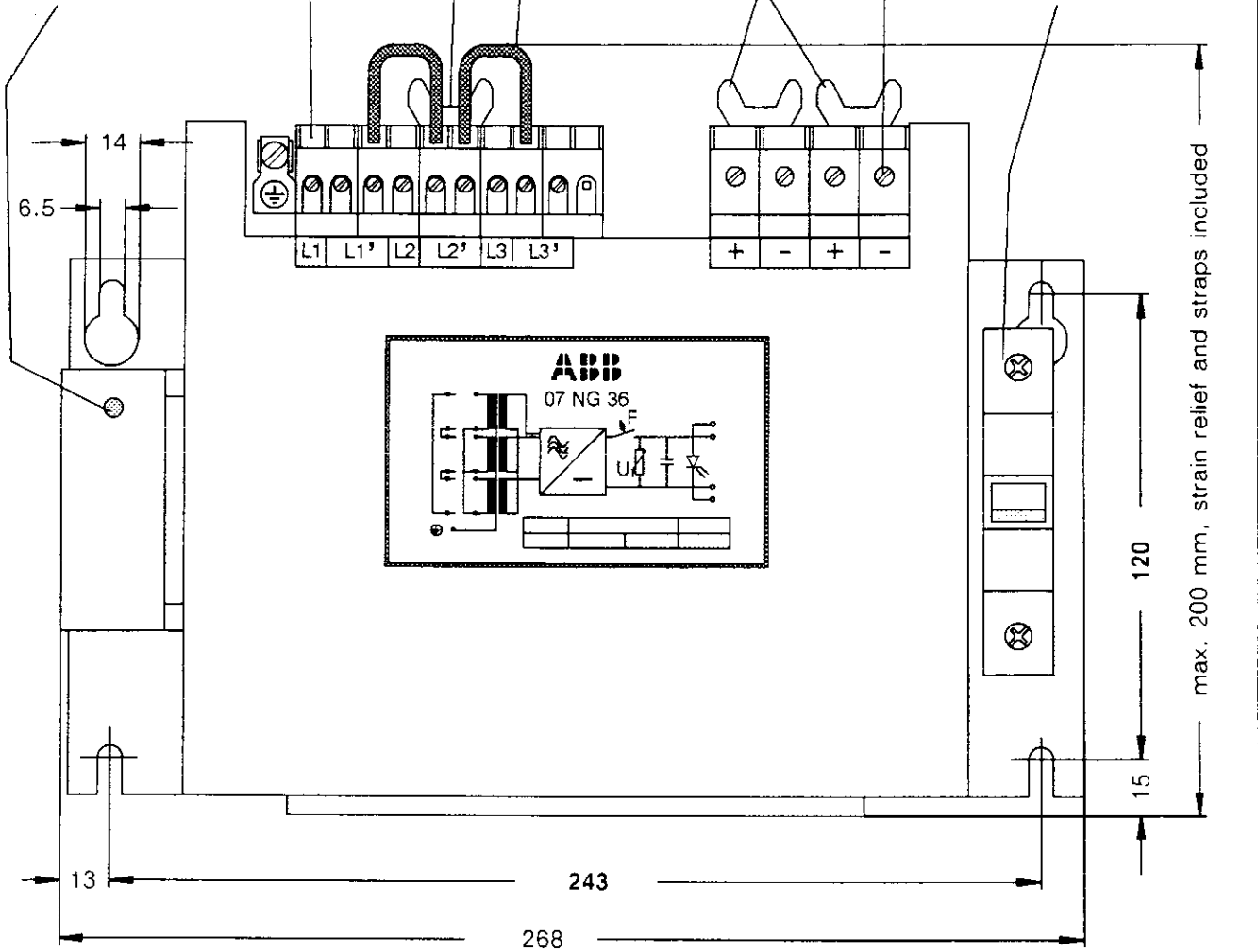

The power supply unit has a height (depth if mounted on rear panel) of ca. 136 mm

Fig. 15.14-2: Drilling pattern and outline dimensions of the power supply unit

Technical data

Electrical data, input specifications

Primary voltage 230 V 3-phase AC

Rated voltage		230 V 3-phase AC
Limiting values		207...253 V AC
Mains frequency		50 or 60 Hz
Current consumption	with no load	ca. 0.35 A
	with rated load	ca. 1.70 A
Fusing	primary	external

Primary voltage 400 V 3-phase AC

Rated voltage		400 V 3-phase AC
Limiting values		360...440 V AC
Mains frequency		50 or 60 Hz
Current consumption	with no load	ca. 0.25 A
	with rated load	ca. 1.00 A
Fusing	primary	external

Max. conductor cross section of the terminals 2 x 1.5 mm²

Electrical data, output specifications

Secondary voltage (output voltage)

Rated voltage	24 V DC
Limiting values	19.2...30 V DC
Max. ripple content	≤ 2 %
Display of the present voltage	with green LED

Output load capability

Rated current (permitted continuous load) 20 A

Fusing, secondary

automatic circuit-breaker B 20 A

Max. conductor cross section of the terminals

2 x 4 mm², plus and minus poles are assigned to two terminals each

Mechanical data

Mounting

with 4 screws M6

Mechanical dimensions

Mounting base 268 x 200 mm, see Fig. 15.14-2, Drilling pattern
Height (depth if mounted on rear panel) 136 mm

Weight

15 kg

Cooling

The power supply unit must be mounted so that the convection air current is not disturbed.

Ambient temperature

max. 55 °C (with 100 % load)

Standards, regulations

VDE 0160, transformer according to VDE 0551

Ordering data

Order number 07 NG 36 R1 GJV3 0756 04 R1

