

SIEMENS

SIMATIC



Industrial PC SIMATIC Microbox PC 427B

Operating Instructions

<u>Introduction</u>	1
<u>Safety information/instructions</u>	2
<u>Description</u>	3
<u>Application planning</u>	4
<u>Mounting</u>	5
<u>Connecting</u>	6
<u>Commissioning</u>	7
<u>Integration into an Automation System</u>	8
<u>Functions</u>	9
<u>Expansions and configurations</u>	10
<u>Maintenance and service</u>	11
<u>Alarm, error, and system messages</u>	12
<u>Troubleshooting</u>	13
<u>Technical specifications</u>	14
<u>Dimension drawings</u>	15
<u>Detailed descriptions</u>	16
<u>Appendix</u>	A
<u>ESD directives</u>	B
<u>List of abbreviations/acronyms</u>	C

Safety Guidelines

This manual contains notices you have to observe in order to ensure your personal safety, as well as to prevent damage to property. The notices referring to your personal safety are highlighted in the manual by a safety alert symbol, notices referring only to property damage have no safety alert symbol. These notices shown below are graded according to the degree of danger.

 DANGER
indicates that death or severe personal injury will result if proper precautions are not taken.
 WARNING
indicates that death or severe personal injury may result if proper precautions are not taken.
 CAUTION
with a safety alert symbol, indicates that minor personal injury can result if proper precautions are not taken.
CAUTION
without a safety alert symbol, indicates that property damage can result if proper precautions are not taken.
NOTICE
indicates that an unintended result or situation can occur if the corresponding information is not taken into account.

If more than one degree of danger is present, the warning notice representing the highest degree of danger will be used. A notice warning of injury to persons with a safety alert symbol may also include a warning relating to property damage.

Qualified Personnel

The device/system may only be set up and used in conjunction with this documentation. Commissioning and operation of a device/system may only be performed by **qualified personnel**. Within the context of the safety notes in this documentation qualified persons are defined as persons who are authorized to commission, ground and label devices, systems and circuits in accordance with established safety practices and standards.

Prescribed Usage

Note the following:

 WARNING
This device may only be used for the applications described in the catalog or the technical description and only in connection with devices or components from other manufacturers which have been approved or recommended by Siemens. Correct, reliable operation of the product requires proper transport, storage, positioning and assembly as well as careful operation and maintenance.

Trademarks

All names identified by ® are registered trademarks of the Siemens AG. The remaining trademarks in this publication may be trademarks whose use by third parties for their own purposes could violate the rights of the owner.

Disclaimer of Liability

We have reviewed the contents of this publication to ensure consistency with the hardware and software described. Since variance cannot be precluded entirely, we cannot guarantee full consistency. However, the information in this publication is reviewed regularly and any necessary corrections are included in subsequent editions.

(A)

가

Table of contents

1	Introduction	7
1.1	Guideline to the Operating Instructions	8
2	Safety information/instructions	9
2.1	General safety instructions	9
3	Description	11
3.1	Overview	11
3.2	Applications.....	12
3.3	Features	13
3.4	Windows XP Embedded	15
3.5	Design	17
3.5.1	External Design.....	17
3.5.2	Connection components	18
3.5.3	Status displays	19
4	Application planning	21
4.1	Transport.....	21
4.2	Unpacking and checking the delivery unit	22
4.3	Ambient and Environmental Conditions.....	24
5	Mounting	25
5.1	Permitted mounting positions.....	25
5.2	Mounting information	26
5.3	Mounting the device.....	26
5.4	Mounting on DIN rails	27
5.5	Mounting with mounting brackets	28
5.6	Upright mounting.....	30
6	Connecting	33
6.1	Connecting peripheral equipment.....	33
6.2	Connecting the 24 V DC power supply.....	34
6.3	Protective ground connection	35
6.4	USB strain-relief.....	36
6.5	Connecting PROFINET strain relief.....	37

7	Commissioning	39
7.1	Note before commissioning.....	39
7.2	Commissioning - Windows XP Embedded	40
7.2.1	Basic commissioning - initial startup.....	40
7.3	Startup - Windows XP Professional / Vista Ultimate.....	41
7.3.1	Basic commissioning - initial startup.....	41
7.3.2	Setting up the language selection for Windows XP Professional / XP Embedded.....	42
7.4	Commissioning - other operating systems.....	43
7.4.1	Commissioning - guide.....	43
8	Integration into an Automation System	45
8.1	PROFINET	47
9	Functions	49
9.1	Monitoring functions	49
9.1.1	Overview	49
9.1.2	Temperature monitoring/display	49
9.1.3	Watchdog (WD).....	50
9.1.4	Safecard on Motherboard (SOM).....	51
9.2	Enhanced Write Filter (EWF)	52
9.3	SRAM buffer memory.....	54
9.4	Battery monitoring	54
9.5	Operation without monitor and keyboard.....	54
10	Expansions and configurations	55
10.1	Open the device (front panel)	55
10.2	Memory expansion.....	57
10.2.1	Installing the memory module	57
10.3	Mounting PCI-104 / PC/104 Plus modules	59
10.3.1	Notes on the modules	59
10.3.2	Mounting PCI-104 or PC/104 Plus modules	59
10.4	Installing/removing Compact Flash cards.....	62
10.4.1	Installation options for Compact Flash cards.....	62
10.4.2	Installing/removing an accessible Compact Flash card.....	63
10.4.3	Installing/removing a built-in Compact Flash card	66
11	Maintenance and service	67
11.1	Removing and installing hardware components	67
11.1.1	Repairs.....	67
11.1.2	Preventive maintenance.....	68
11.1.3	Replacing a hard disk.....	69
11.1.4	Replace the backup battery	71
11.2	Reinstalling the operating system	73
11.2.1	Windows XP Embedded	73
11.2.1.1	General installation procedure	73
11.2.1.2	Restoring the software to factory state using the Restore DVD	73
11.2.2	Windows XP Professional.....	75
11.2.2.1	General installation procedure	75
11.2.2.2	Restoring the Software to Factory State Using the Restore DVD	75

11.2.2.3	Setting up the operating system via the Recovery CD/DVD	77
11.2.3	Recovery of Windows Vista	80
11.3	Partitioning data media	83
11.3.1	Setting up the partitions under Windows XP Embedded	83
11.3.2	Setting up the partitions under Windows XP Professional / Vista Ultimate	84
11.4	Install drivers and software	85
11.4.1	Driver installation under Windows XP Embedded	85
11.4.2	Installing drivers and software	85
11.5	Installing updates	86
11.5.1	Updating the operating system	86
11.5.2	Installing or updating application programs and drivers	86
11.6	Data backup	87
11.6.1	Creating an image	87
11.7	CP 1616 onboard	88
12	Alarm, error, and system messages	89
12.1	Boot error messages	89
13	Troubleshooting	91
13.1	General problems	91
13.2	Problems when using modules of third-party manufacturers	92
14	Technical specifications	93
14.1	General specifications	93
14.2	Power requirements of the components	97
14.3	Integrated DC power supply	98
15	Dimension drawings	99
15.1	Overview of the dimensional drawings	99
15.2	Dimension drawings of the device	100
15.3	Dimension drawings of the device with mounting brackets	101
15.4	Dimensional drawings of the device with vertical mounting angles	102
15.5	Dimensional drawings of the device with expansion frames	103
15.6	Dimension drawing of the blanking plate	104
16	Detailed descriptions	105
16.1	Internal components	105
16.1.1	Overview of internal components	105
16.1.2	Technical features of the motherboard	106
16.1.3	External ports	107
16.1.3.1	COM1	107
16.1.3.2	DVI-I	108
16.1.3.3	Ethernet	109
16.1.3.4	USB	109
16.1.3.5	PROFIBUS	110
16.1.3.6	PROFINET	110
16.1.3.7	CAN bus	111
16.1.4	Internal interfaces	112

16.1.4.1	Compact Flash card interface	112
16.1.4.2	PCI-104 or PC/104-Plus interface (PCI part)	113
16.2	BIOS Setup	114
16.2.1	Overview	114
16.2.2	Starting BIOS Setup	115
16.2.3	BIOS Setup menus	116
16.2.4	Main menu	118
16.2.5	Advanced Menu	128
16.2.6	Security menu	134
16.2.7	Boot menu	135
16.2.8	Version menu	136
16.2.9	Exit Menu	137
16.2.10	Default BIOS Setup entries	138
16.3	System resources	141
16.3.1	Currently allocated system resources	141
16.3.2	System resources used by the BIOS/DOS	142
16.3.2.1	PCI Interrupt Lines	142
16.4	I/O address areas	145
16.4.1	Overview of the internal module registers	145
16.4.2	Watchdog enable register / 066h select register (read/write, address 062h)	146
16.4.3	Watchdog trigger register (read only, address 066h)	147
16.4.4	CAN base address register (write only, address 066h)	147
16.4.5	Output register LED 1 / 2 (read/write, address 404Eh)	148
16.4.6	Battery status register (read-only, address 118Fh)	148
16.4.7	SRAM address register	149
16.5	CP 1616 onboard communications processor	150
16.5.1	Introduction	150
16.5.1.1	Network connections	150
16.5.1.2	Typical Communication Partners	151
16.5.2	Firmware loader	153
16.5.2.1	Loading firmware	154
16.5.3	Further actions in STEP 7/NCM PC	156
A	Appendix	157
A.1	Guidelines and declarations	157
A.2	Certificates and approvals	158
A.3	Service and support	160
B	ESD directives	161
B.1	ESD directives	161
C	List of abbreviations/acronyms	163
C.1	Abbreviations	163
	Glossary	169
	Index	179

Introduction

Objective of this documentation

These operating instructions contain all the information you need to commission and use the SIMATIC Microbox PC 427B.

It is intended both for programming and testing/debugging personnel who commission the device itself and connect it with other units (automation systems, further programming devices), as well as for service and maintenance personnel who install expansions or carry out fault/error analyses.

Scope of validity of this document

These operating instructions are valid for all delivery variants of the SIMATIC Microbox PC 427B and describe the delivery status as of July 2008.

Position in the information landscape

These operating instructions are available on the "Documentation and Drivers" DVD included with your product.

For further instructions on how to handle the software, please refer to the corresponding documentation.

Conventions

The abbreviations "Microbox PC" and "device" are also used within this manual for the product name, SIMATIC Microbox PC 427B. The abbreviations CP will be used for CP 1616 onboard and Vista for Windows Vista Ultimate.

History

Currently released versions of this operating manual:

Edition	Comment
04/2007	First edition
07/2008	<ul style="list-style-type: none"> • Remedy • New operating system: Windows Vista Ultimate • Functionality: additionally CP 1616 onboard

1.1 Guideline to the Operating Instructions

Contents format	Table of Contents
Contents	Organization of the documentation, including the index of pages and chapters
Introduction	Purpose, layout and description of the important topics.
Safety instructions	Refers to all the valid technical safety aspects which have to be adhered to while installing, commissioning and operating the product/system in and in reference to statutory regulations.
Description	Fields of application, the features and the structure of the product/system
Application planning	Aspects of storage, transport, environmental and EMC conditions to be considered in the preparatory stage
Mounting	Product installation options and installation instructions
Connecting	Options of connecting the product and connection instructions
Commissioning	Commissioning the product/system.
Integration	Options of integrating the product into existing or planned system environments/networks
Functions	Monitoring and display functions
Expansions / configurations	Procedure for installing expansion devices (memory, modules).
Maintenance and service	Replacement of hardware components, restoring and setup of the operating system, installation of drivers and software
Alarm, error and system messages	Error messages from booting
Troubleshooting	Problems, cause, remedy
Technical specifications	General specifications in compliance with relevant standards and current/voltage values
Dimension drawings	Dimensions of the device and of modules
Detailed descriptions	Structure, function and features of vital components, distribution of system resources and use of the BIOS Setup routine
Appendix	Guidelines and certifications, service and support, notes on retrofitting.
ESD guidelines	General ESD guidelines.

Safety information/instructions

2.1 General safety instructions

 CAUTION
--

Please observe the safety instructions on the back of the cover sheet of this documentation. You should not expand your device unless you have read the relevant safety instructions.

This device is compliant with the relevant safety measures to IEC, EN, VDE, UL, and CSA. If you have questions about the validity of the installation in the planned environment, please contact your service representative.

Repairs

Only authorized personnel are permitted to repair the device.

 WARNING
--

Unauthorized opening of and improper repairs to the device may result in substantial damage to equipment or endanger the user.
--

System expansions

Only install system expansion devices designed for this device. The installation of other expansions can damage the system and violate the radio-interference suppression regulations. Contact your technical support team or where you purchased your PC to find out which system expansion devices may safely be installed.

CAUTION

If you install or exchange system expansions and damage your device, the warranty becomes void.

Battery

This device is equipped with a Lithium battery. Batteries may only be replaced by qualified personnel.

 CAUTION
--

There is the risk of an explosion if the battery is not replaced as directed. Replace the battery only with the same type or with an equivalent type recommended by the manufacturer. Dispose of used batteries in accordance with local regulations.

 WARNING
--

Risk of explosion and release of harmful substances!
--

For this reason, do not burn lithium batteries, do not solder on the cell body, do not open, do not short circuit, do not reverse polarity, do not heat above 100°C, dispose of correctly, and protect against direct sunlight, dampness and dew.

ESD directives

Modules containing electrostatic sensitive devices (ESDs) can be identified by the following label:



Strictly follow the guidelines mentioned below when handling modules which are sensitive to ESD:

- Always discharge your body's static electricity before handling modules that are sensitive to ESD (for example, by touching a grounded object).
- All devices and tools must be free of static charge.
- Always pull the mains connector and disconnect the battery before installing or removing modules which are sensitive to ESD.
- Handle modules fitted with ESDs only by their edges.
- Do not touch any connector pins or conductors on modules containing ESDs.

Description

3.1 Overview

The SIMATIC Microbox PC provides high-level industrial performance.

- Compact design
- Maintenance-free operation
- High degree of ruggedness



Figure 3-1 SIMATIC Microbox PC 427B



Figure 3-2 SIMATIC Microbox PC 427B (PROFINET version)

3.2 Applications

The device provides industrial PC systems for high-performance and space-saving applications in particular in the field of machine, systems and switchgear cabinet engineering:

- Measuring and controlling of process and machine data (for example, automated washing systems, assembling machines, packaging machines)
- Operating and visualization tasks with separate display / monitor solutions (information terminals, large-scale displays in automotive production)
- Data logging and processing (for example, system data logging, distributed process control)

3.3 Features

Basic data	
Installation / mounting	<ul style="list-style-type: none"> • Installation on a DIN rail • Wall mounting • Hanging assembly • Upright mounting
Processor	<ul style="list-style-type: none"> • Intel Celeron M 900 MHz, 400 MHz FSB or • Intel Celeron M 1GHz, 400 MHz FSB, SLC 512 KB or • Intel Pentium M 1.4 GHz, 400 MHz FSB, SLC 2 MB
Main memory	<ul style="list-style-type: none"> • 256 MB DDR2 SDRAM SODIMM • 512 MB DDR2 SDRAM SODIMM • 1 GB DDR2 SDRAM SODIMM • 2 GB DDR2 SDRAM SODIMM
Free slots for expansion	Up to 3 x PCI/104 modules or 3x PC/104- <i>Plus</i> module (PCI bus only); installed with expansion frame
Graphic controller	<ul style="list-style-type: none"> • Integrated Intel GMA900 graphics • CRT resolution of 640x480 pixels up to 1600x1200 pixels • DVI resolution of 640x480 pixels up to 1600x1200 pixels • 8-128 MB graphics memory taken from RAM (dynamic UMA)
Power supply	24 V DC (20.4 – 28.8 V) max. 4 A
Conditions of use	<ul style="list-style-type: none"> • Operation without fan
Drives and storage media	
Compact Flash card	<ul style="list-style-type: none"> • 256 MByte optional or • 512 MByte optional or • 1 GB optional or • 2 GB optional or • 4 GB optional
Hard disk	≥ 80 GB SATA hard disk
Floppy/CDROM drive	Connected via external USB port
USB stick	Connected via external USB port
Ports	
Serial	COM1 (RS232)
Graphics	DVI-I: combined DVI and VGA
USB	4 x USB 2.0 high current
Ethernet	2 x RJ 45 (10/100/1000 Mbit/s) or 1x RJ 45 for PROFINET versions
PROFIBUS DP	12 Mbps (isolated potential, compatible to CP 5611), optional
PROFINET	10/100 Mbps (CP 1616 onboard), three RJ45s; optional
CAN interface	on request
Keyboard, mouse	Connected via external USB port

Monitoring and safety functions	
Temperature	<ul style="list-style-type: none"> When permitted temperature range is exceeded Warnings can be analyzed by application program (local, via LAN)
Watchdog	<ul style="list-style-type: none"> Monitoring function for program execution Restart can be parameterized in the event of a fault Warnings can be analyzed by application program (local, via LAN)
LED display	4 LEDs (or 5 for PROFINET versions) for displaying system status 2 of these can be programmed by the user ¹
Transient voltage interruption	Up to 15 ms buffer time at full load
Buffer memory	2 MB battery-buffered SRAM ¹

Software	
Operating systems	
Available	<ul style="list-style-type: none"> Without Windows XP Embedded status UPR1 (Update Rollup 1) including SP 2 with Feature Pack 2007 pre-installed Windows XP Professional MUI SP2 pre-installed ² Windows Vista Ultimate MUI ²
Project-specific	<ul style="list-style-type: none"> LINUX QNX VxWorks Others on request RMOS3 V3.40 (ordered separately)

¹You can find additional information about addressing the LEDs or the SRAM under a Windows operating system in the section "Output register LED L1/L2". You can find example programs for addressing the LEDs under Windows XP and under RMOS3 under the FAQ at the Customer Support site of the Microbox.

² MUI: Multi Language User Interface; 5 languages (English, German, French, Spanish, Italian)

3.4 Windows XP Embedded

The Windows XP Embedded package is on Update Rollup 1 status (UPR 1), based on Service Pack 2 (SP 2) and Feature Pack 2007. The overview shows the most important device functions under Windows XP Embedded:

Function	Hard disk version	Compact Flash card version
Enhanced Write Filter (EWF)	In RAM RAM(REG)	In RAM RAM(REG)
Safecard on Motherboard (SOM)	Available V 3.02	Available V 3.02
Pagefile	Deactivated in favor of the EWF	Deactivated in favor of the EWF
System Restore Core	Available	Available
File based Writefilter (FBWF)	Available	Available
Registryfilter	Available	Available
Device Update Agent (DUA)	Available	Available
HORM	Available	Available
Telnet Server	Available	Available
Windows Backup	Available	Available
User Mode Driver Framework (UMDF)	Available	Available
MUI	GER/FRA/ITA/SPA Default language: English	GER default language: English
Administrator Account	Available	Available
User Account	Available	Available
Explorer Shell	Available	Available
Internet Explorer (IE)	Available, IE7	Available, IE7
Internet Information Server (IIS)	Available V 5.1	Available V 5.1
Terminal Services	Available	Available
Bluetooth	Available	Available
Wireless Network Support	Available	Available
Windows Firewall	Available	Available
Windows Security Center	Available	Available
MSN Explorer	Available	Not available
Outlook Express	Available	Available
Administrative Tools	Available	Available
SMS Advanced Client	Available	Not available
Remote Desktop	Available	Available
Remote Assistance	Available	Available
.NET Framework	Available, V3.0	Not available
ASP.NET	Available, V3.0	Not available
Windows .NET Messenger	Available	Not available
Code pages/User Location/Keyboard	Available	Selection available
Disk Management Services	Available	Available
Windows Installer Service	Available	Available

Description

3.4 Windows XP Embedded

Function	Hard disk version	Compact Flash card version
Class Installer	Available	Available
CoDevice Installer	Available	Available
Windows Movie Maker	Available	Not available
Media Player	Available, V11.0	Available, V11.0
Windows Media Player Tour	Available	Not available
DirectX	V9.0c	V9.0c
Accessories	Available	Available
Help files for all components	Available	Not available
Games	Available	Not available
Fonts	310	116
Windows XP Tour	Available	Not available

3.5 Design

3.5.1 External Design

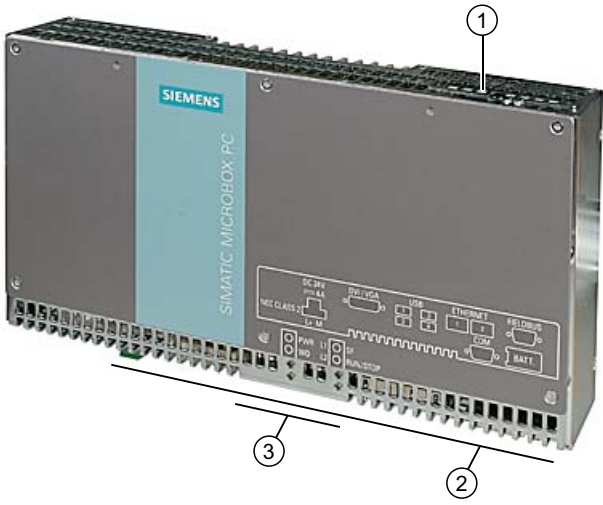
Device components	Pos	Description
	(1)	Cover plate for Compact Flash module
	(2)	Connection elements
	(3)	Status displays

3.5.2 Connection components

Ports and power supply

Location of connection elements (version with PROFIBUS or CAN)		
Location of connection elements (version with PROFINET)		
Pos	Name	Description
(1)	24 VDC	Connection for a 24 V DC power supply
(2)	DVI/VGA	DVI/VGA connection for CRT or LCD monitor with DVI interface
(3)	Reset button	Use a pointed, insulated object to operate the reset button. The button signal triggers a hardware reset. The PC performs a restart (cold start).
(4)	USB	4 USB 2.0 connections, high-speed / low current
(5)	ETHERNET	RJ45 Ethernet connection 1 (exclusive PCI interrupt) for 10/100/1000 Mbps
(6)	ETHERNET	RJ45 Ethernet connection 2 (shared PCI interrupt) for 10/100/1000 Mbps (not for PROFINET versions)
(7)	PROFIBUS DP/MPI	PROFIBUS DP/MPI interface (RS 485 isolated), 9-pin Cannon socket or CAN fieldbus (on request)
	CAN fieldbus	
(7)	PROFINET	CP 1616 onboard interface, three RJ45 sockets (optional product version)
(8)	COM	Serial port (RS232) 9-pin Cannon connector
(9)	USB strain-relief fastener	The USB strain relief must be fastened to the device enclosure with an oval-head screw (M4 thread). The USB cables can be fastened to the strain-relief assembly with a cable tie.
(10)	Protective earth terminal	The PE terminal (M4 thread) must be connected to the protective ground conductor of the plant, in which the device is to be installed. The minimum conductor cross-section may not be less than 2,5 mm ² .

CAUTION
Data may be lost when the PC performs a hardware reset.

3.5.3 Status displays

Status displays	LED	Meaning	LED	Description
	PWR	Power supply	OFF GREE N	Isolated from supply voltage Supply voltage available
	WD	Watchdog status display	OFF GREE N RED	Watchdog disabled Watchdog enabled, monitoring time not expired Watchdog enabled, monitoring time expired
	L1	User LED L1	YELLO W	Can be controlled by user programs ¹
	SF	Group errors	RED	Can be controlled by controller program (e.g. WinAC) ¹
	L2	User LED L2	YELLO W	Can be controlled by user programs ¹
	RUN/STOP	RUN STOP	GREE N YELLO W	Can be controlled by controller program (e.g. WinAC) ¹

¹You can find additional information about addressing the LEDs or the SRAM under a Windows operating system in the section "Output register LED L1/L2". You can find example programs for addressing the LEDs under Windows XP and under RMOS under the FAQ at the Customer Support site of the Microbox.

See also

Output register LED 1 / 2 (read/write, address 404Eh) (Page 148)

PROFINET status display

PROFINET status display			
			
LED	Meaning	LED	Description
SF PROFINET (optional)	Status display for CP 1616 onboard	OFF	<ul style="list-style-type: none"> CP not available CP disabled No error, communication established Charging in progress
		Flashes slowly	<ul style="list-style-type: none"> Link status error IO controller: IO device cannot be addressed IO controller: Duplicate IP address
		Flashes rapidly	Exception error: diagnostics via web or SNMP is no longer possible
		AN	<ul style="list-style-type: none"> Diagnostics information available No communication established.

Virtual status displays			
The two "virtual" CP 1616 LEDs are only visible in the SIMATIC software and can be read via SNMP.			
PROFINET	Virtual LEDs	RUN	CP is active
		STOP	CP is in the stop state
		Flashes	The states "flashes slowly" or "flashes rapidly" do not exist.

Application planning

4.1 Transport

Despite the device's rugged design, its internal components are sensitive to severe vibrations or shock. You must therefore protect the device from severe mechanical stress when transporting it.

You should always use the **original packaging** for shipping and transporting the device.

CAUTION
Risk of damage to the device! If you are transporting the device in extreme weather conditions with large fluctuations in temperature, care must be taken to ensure that no moisture forms on or in the device (condensation). If condensation has developed on the device, wait at least 12 hours before you switch it on.

4.2 Unpacking and checking the delivery unit

Unpacking the device

Note the following when unpacking the unit:

- It is advisable not to dispose of the original packing material. Keep it in case you have to transport the unit again.
- Please keep the documentation in a safe place. It is required for initial commissioning and is part of the device.
- Check the delivery unit for any visible transport damage.
- Verify that the shipment contains the complete unit and your separately ordered accessories. Please inform your local dealer of any disagreements or transport damages.

Noting the device identification data

The device can be identified uniquely with the help of these numbers in case of repairs or theft.

Enter the data in the following table:

Serial number	S VP ...
Order Number of the device	6ES 7647-7A ...
Microsoft Windows Product Key	
Ethernet address 1	
Ethernet address 2 (not for PROFINET versions)	
CP 1616 onboard MAC address layer 2	
CP 1616 onboard MAC address PROFINET	

You can find the corresponding data here:

- Serial number: You can find the serial number on the rating plate on the back of the device.

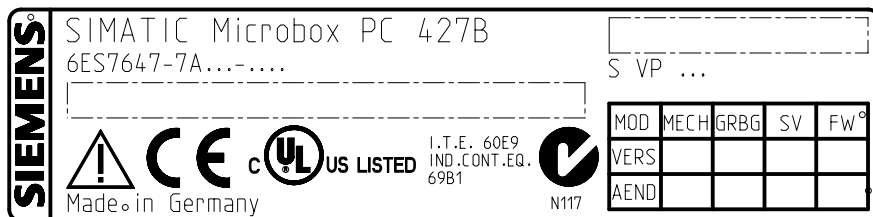

Figure 4-1 Rating plate

- Order number of the device
- Ethernet address: You can find the Ethernet address of the device in your BIOS Setup (**F2 function key**) under **Hardware Options > ETH 1 Address** or **ETH 2 Address** (not for PROFINET versions).

- Microsoft Windows "Product Key" from the "Certificate of Authenticity" (COA): The COA label is only present in pre-installed Windows XP Embedded or XP Professional and is affixed to the back of the device.



Figure 4-2 COA Label XP Embedded



Figure 4-3 COA Label XP Professional

4.3 Ambient and Environmental Conditions



When you plan your project, you should make allowances for:

- The climatic and mechanical environmental conditions specified in the specifications given in your operating instructions.
- The device is approved for operation in closed rooms only.
- Avoid extreme ambient conditions. Protect the device against dust, moisture and heat.
- Do not place the device in direct sunlight.
- Ensure at least 100 mm of space above and below the device and between other components or the sides of cabinets.
- Do not cover the ventilation slots of the device.
- Always observe the mounting positions permitted for this device.
- The connected or built-in peripherals should not introduce a counter emf in excess of 0.5 V into the device.

Mounting

5.1 Permitted mounting positions

NOTICE
The device is approved for operation in closed rooms only. Ensure at least 100 mm of space above and below the device and between other components or the sides of an enclosure.

Horizontal (preferred position)	Permitted temperatures
	Operation with hard disk: +5 to +40°C Used with CompactFlash card: <ul style="list-style-type: none"> • without expansion modules: 0 to +50°C • without expansion modules in RAL: 0 to +55°C • with up to 3 expansion modules (max. load 9 W): 0 to +45°C • with up to 3 expansion modules (max. load 9 W) in RAL: 0 to +50°C
Vertical / portrait installation (power supply on top)	
	Operation with hard disk: +5 to +40°C Used with CompactFlash card: <ul style="list-style-type: none"> • without or with up to 3 expansion modules (max. load 9 W): 0 to +40°C • without or with up to 3 expansion modules (max. load 9 W) in RAL: 0 to +45°C Notes: <ul style="list-style-type: none"> • When mounted on a DIN rail, the device should be secured to prevent shifting (e.g. with a DIN rail ground terminal). • Portrait installation permitted in control cabinet only.

Suspended	
	Used with CompactFlash card and without expansion modules: 0 to +40°C Note: Mounting brackets are required if the device is suspended.
RAL = Restricted Access Location (e.g. installation of the unit in a lockable cabinet)	

NOTICE
The safety and installation instructions for the expansion modules should be followed if the device is expanded with PCI-104 / PC/104-plus modules. If necessary, the device should be installed in an enclosure that meets the requirements of paragraphs 4.6 and 4.7.3 of IEC/UL/EN/DINEN60950-1.

5.2 Mounting information

Before you install the device, read the following mounting instructions.

NOTICE
Adhere to the SIMATIC assembly guidelines and the relevant DIN/VDE requirements or the country-specific regulations when mounting in switching cabinets.

NOTICE
Ensure that the device is classified as "Open Type" when using the device in the area of Industrial Control Equipment (UL508). A UL508 conform enclosure is therefore a mandatory requirement for approval or operation according to UL508.

5.3 Mounting the device

Mounting methods

SIMATIC Microbox PC can be mounted on DIN rails, with mounting brackets and in an upright position.

5.4 Mounting on DIN rails

Mounting the device on DIN rails

Note

Use of Siemens 35 mm standard mounting rail is recommended.

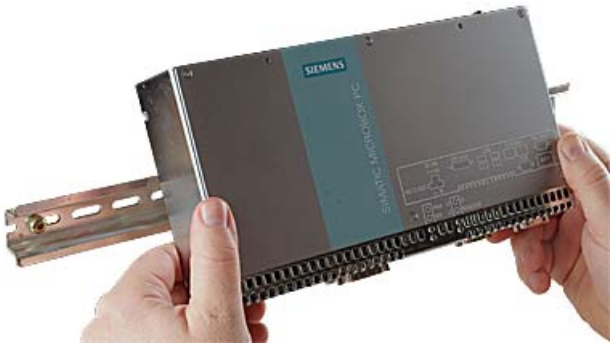
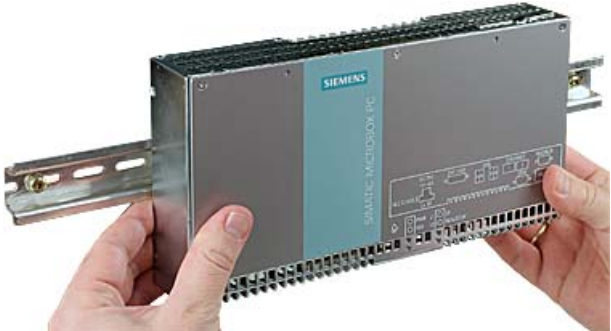
Steps for mounting on DIN rails		
1.	Set the device inclined on the upper DIN rail.	
2.	Swing the device fully onto the rails until both clamps completely latch.	

Note

To ensure secure mounting on vertical mounting rails, a DIN rail ground terminal should be mounted beneath the device.

NOTICE

The rails are secured to a wall or cabinet similar to mounting with mounting brackets. Ensure that the wall or ceiling can hold four times the total weight of the device (including the rails and additional expansion modules). See also section *Mounting with Mounting Brackets*.

Removing the device from the DIN rail

- Push down the device until the clamps release it.
- Swing the device out of the rails.

5.5 Mounting with mounting brackets

Removing mounting clamps from the device

Two mounting clamps are factory installed on the device for DIN rail mounting. These need to be removed before mounting the mounting brackets.

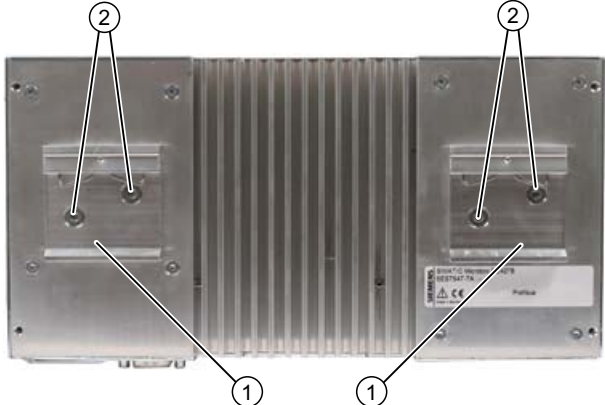
Steps for removing the mounting clamps	
Remove the four screws (2) and the two mounting clamps (1) from the back of the device.	

Installing brackets on the device

Two mounting brackets are included in the device package. They can be installed on the device with four screws supplied.

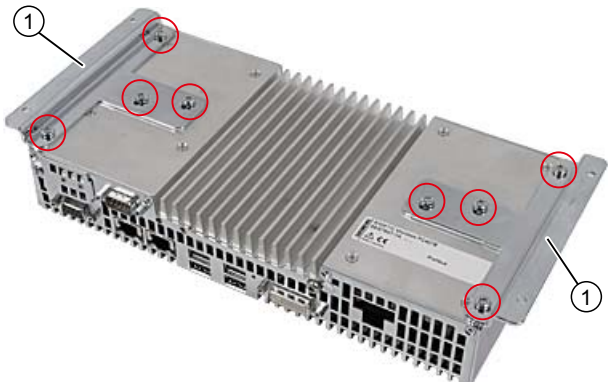
Steps for installing the mounting brackets	
Install the mounting brackets on the device.	

Note

Required tools

You need a TORX T15 screwdriver to remove the mounting clamps and mount the mounting brackets.

Mounting/demounting the device

The dimensions of the device with mounting brackets are available in the dimensional drawings.

Mounting examples		
Material	Bore diameter	Mounting
Concrete	8 mm diameter 60 mm depth	Dowel: 8 mm diameter 50 mm length Screws: 4 mm diameter 50 mm length
Plasterboard (min. 13 mm thick)	14 mm diameter	Gravity toggle: 4 mm diameter 50 mm length
Metal (min. 2 mm thick)	5 mm diameter	Metal screws M 4: 4 mm diameter 15 mm length

 WARNING
Ensure that the wall or ceiling can hold four times the total weight of the device (including the cabinet brackets and additional expansion modules).

5.6 Upright mounting

With the available optional vertical mounting kit you have the possibility to implement a place saving installation.

Mounting the vertical mounting angle onto the device

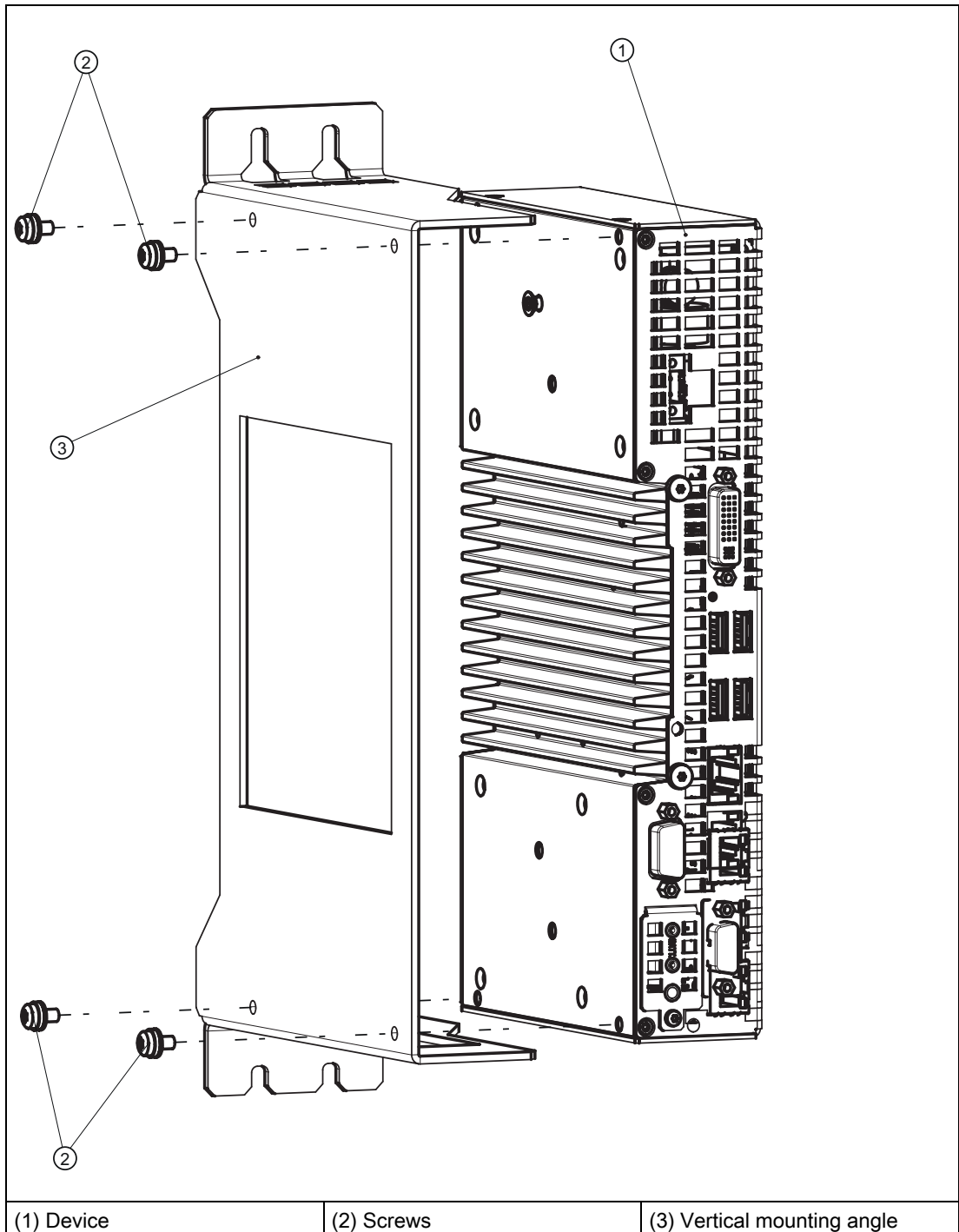

Note

- Information on installation and operation is available in the supplement of the accessories.
 - Portait installation in control cabinet only with maximum ambient temperatures with a distance of 100 m lateral and top/bottom to next component:
 - for versions with CompactFlash: 45°C
 - for versions with hard disk: 40°C
-

Connecting

6.1 Connecting peripheral equipment

NOTICE

Connect only I/O modules approved for industrial applications according to EN 61000-6-2.

Note

Hot-plug I/O modules (USB) may be connected while the PC is in operation.

CAUTION

Peripheral devices that are incapable of hot-plugging may only be connected after the device has been disconnected from the power supply.

CAUTION

Strictly adhere to the specifications for peripheral equipment.

Note

A DVI or CRT monitor should be connected and switched on when the device boots in order for it to be correctly detected by the BIOS and the operating system. The screen may otherwise remain dark.

NOTICE

The connected or built-in peripherals, such as USB drives, should not introduce a counter emf into the device.

A counter emf greater than 0.5 V to ground on the + 3.3 VDC / + 5 VDC / + 12 VDC power rail due to a connected or integrated component can prevent normal operation or even destroy components of the device.

6.2 Connecting the 24 V DC power supply

To be noted before you connect the device

Note the following in order to operate the device safely and according to regulation:

 WARNING
<p>The device should only be connected to a 24V DC power supply which satisfies the requirements of safe extra low voltage (SELV).</p> <p>If the device is used on a wall, in an open rack or other similar locations, an NEC Class 2 current source is required in order to meet the UL requirements (UL 60950-1). In all other cases (IEC / EN / DIN EN 609501) either a current source of limited output (LPS = Low Power Source), or a line-side fuse or a line-side circuit breaker is necessary. The power needs to be limited to a value below 4.16 A. The fuse value required: Max. 4 A.</p> <p>If the device is used in fire-proof enclosures to IEC/UL/EN/DIN/EN 60950-1, there are no requirements to limit the current of the supply voltage.</p> <p>Use the special plug supplied to connect the supply voltage. Connect the PE conductors as described in the next section.</p>

NOTICE
The permitted cable cross-section for the 24 VDC connection is 0.75 mm ² to 2.5 mm ² .

NOTICE
If a CompactFlash card is used in the device, make sure that the card is seated correctly before you connect it.

Connecting

Steps for connecting the device to the 24 V DC power supply	
1.	Switch off the 24 V DC power source.
2.	Connect the power supply using the plug (included in the package).
3.	Connect the PE conductor.

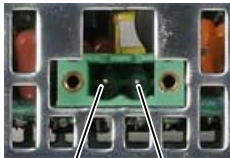

(P24 in) (M in)

See also

Protective ground connection (Page 35)

6.3 Protective ground connection

The PE terminal (M4 thread) on the device (large surface, large-area contact) must be connected to the PE conductor on the cabinet or system in which the PC is to be installed. The conductor cross-section must not be less than 2.5 mm².

The PE terminal is needed to protect the device and ensures that interference signals generated by external power cables, signal cables or cables to the I/O modules are safely discharged to earth.

Required tool for protective earth terminal: TORX T20 screwdriver

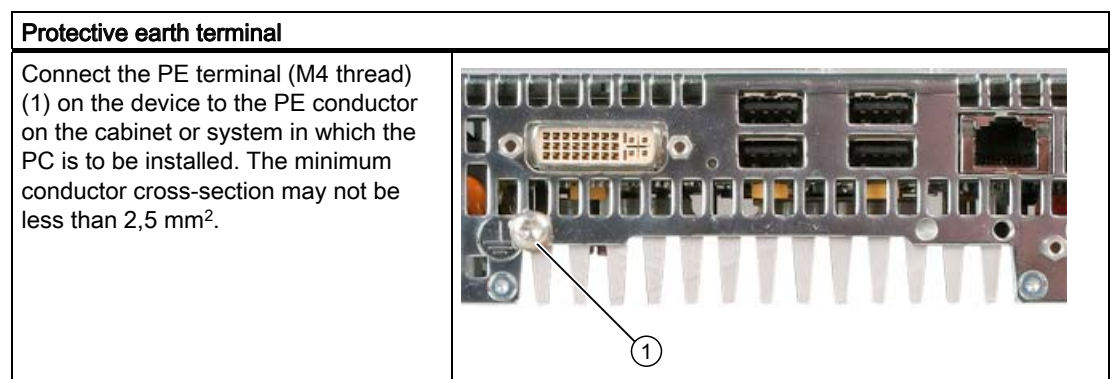

6.4 USB strain-relief

The USB strain-relief provided as an accessory is used to prevent accidental loosening of the USB cable from the device. A cable binder (not included in the package) is needed to use this accessory.

To fix the USB strain relief, you will need a TORX T20 screwdriver.

Steps for connecting the USB strain-relief	
1.	Fasten the USB strain-relief (1) to the device enclosure with an oval-head screw (M4 thread).
2.	Thread the cable binder (2) through the comb of the USB strain-relief to clamp the USB cable.

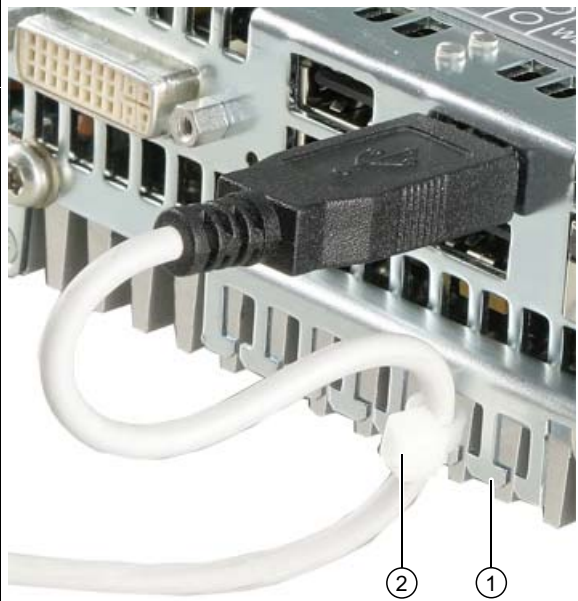

6.5 Connecting PROFINET strain relief

The PROFINET strain relief provided in the package is used to prevent accidental loosening of the cable from the device. A cable tie (not included in the package) is needed for each interface.

To fix the PROFINET strain relief, you will need a TORX T10 screwdriver.

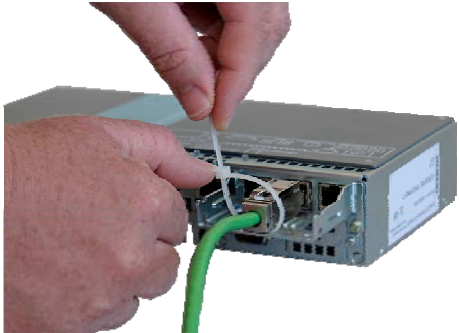
Steps for connecting the PROFINET strain relief	
1	Remove the PROFINET interface plate. 
2	Attach the PROFINET strain relief.
3	Attach the cable using the cable tie. 

Commissioning

7.1 Note before commissioning

Factory state

The SIMATIC Microbox PC s available in the following versions:

- With the Windows XP Embedded operating system (pre-installed on Compact Flash card or the hard disk)
- With the Windows XP Professional operating system (pre-installed on the hard disk)
- Without operating system

Connections before commissioning

Before connecting the device to the power supply, a DVI or CRT monitor should be connected in order for it to be correctly detected by the BIOS and the operating system during startup.

 CAUTION
Risk of damage to the device If condensation has developed, wait at least 12 hours before commissioning the device.
NOTICE
Windows XP Embedded: Read the EWF information A configurable write filter is available (Enhanced Write Filter) with Windows XP Embedded. Please be aware of this when activating and using the EWF information, otherwise you may experience data loss.

7.2 Commissioning - Windows XP Embedded

7.2.1 Basic commissioning - initial startup

Configuring the operating system

When the computer starts up for the **first** time, the Windows XP operating system on the Compact Flash card or hard disk is configured automatically. Proceed as follows:

1. Connect the device to the 24 V DC power supply. The PC performs a self-test (POST). During the self-test, this message appears:
`Press <F2> to enter SETUP or <ESC> to show the Boot menu`
2. Wait until this message is cleared, then follow the instructions on the screen.

NOTICE
The device may not be switched off at any time during the installation process. Do not change the default BIOS settings, otherwise the operating system setup may become corrupted.

3. Restart
After you have entered all the necessary information and the operating system is configured, you are prompted to restart the system. Respond to this prompt with **Yes**.

Note

System startup can take considerably longer than usual for the initial commissioning. Only a blue screen is displayed for several minutes.

When you switch on the PC now, the logon window or the user interface of the Windows XP Embedded operating system is automatically opened when the startup routine is completed.

Note

To prevent data loss, it is advisable to create an image of your system partition after initial commissioning.

Switch off the device

When you work with Windows XP Embedded, always shut down the PC with the command **Start > Shut Down**.

Note

The Enhanced Write Filter should be enabled following the installation of Windows XP Embedded on a CompactFlash card. When this is enabled, the device can be switched off by disconnecting the power supply.

7.3 Startup - Windows XP Professional / Vista Ultimate

7.3.1 Basic commissioning - initial startup

Configuring the operating system

When the computer starts up for the **first** time, the Windows XP Professional / Vista Ultimate operating system on the hard disk is configured automatically. Proceed as follows:

1. Connect the device to the 24 V DC power supply. The PC performs a self-test (POST). During the self-test, this message appears:
Press <F2> to enter SETUP or <ESC> to show the Boot menu
2. Wait until this message is cleared, then follow the instructions on the screen.

NOTICE
The device may not be switched off at any time during the installation process. Do not change the default BIOS settings, otherwise the operating system setup may become corrupted.

3. Automatic restart
After you have entered all necessary information and the operating system is configured, the PC is automatically restarted and displays the user interface of the operating system.

Note

System startup can take considerably longer than usual for the initial commissioning.

When you switch on the PC now, the user interface of the Windows XP Professional / Vista Ultimate operating system is automatically opened when the startup routine is completed.

Note

To prevent data loss, it is advisable to create an image of your system partition after initial commissioning.

Switch off the device

When you work with Windows XP Professional, always shut down the PC with the command **Start > Shut Down**.

7.3.2 Setting up the language selection for Windows XP Professional / XP Embedded

The Multilanguage User Interface (MUI) allows you to set up the Windows XP Professional / XP Embedded menus and dialogs for additional languages.

Default language of your Windows XP MUI installation is English and a US keyboard layout. You can change the language in the Control Panel. Select:

**Start > Control Panel > Regional and Language Options
Languages, tab Language used in menus and dialogs**
field.

For the **Regional and Language Options** set the default as **non-Unicode programs** under **Advanced** in addition to the language for menus and dialogs.

7.4 Commissioning - other operating systems

7.4.1 Commissioning - guide

The desired operating system can be installed on the hard disk or a Compact Flash card. A variety of USB devices (hard disk, external floppy or CD-ROM drive, USB stick) or Compact Flash cards can be used as boot media.

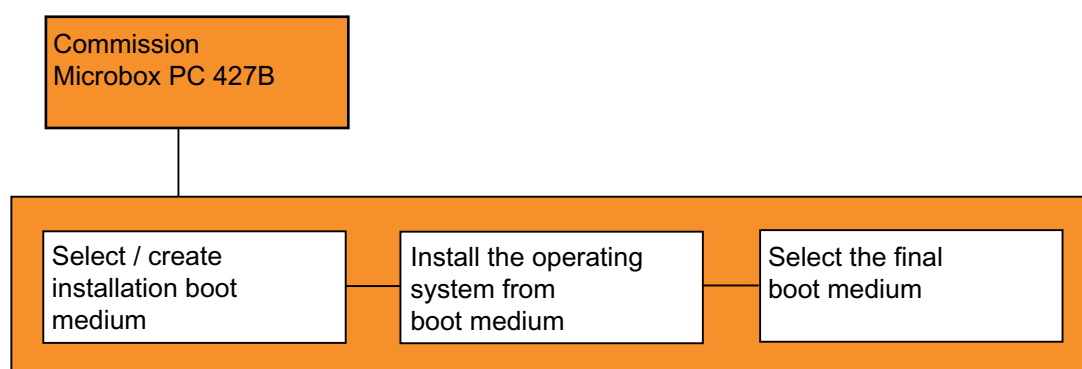

The following provides an overview of the steps involved in commissioning:

Steps	Description
1 Select and create a boot medium for installation.	Select a suitable boot medium for the operating system to be used in the BIOS Setup (CD-ROM drive, Compact Flash card, hard disk or USB device). See section <i>Boot Menu</i> in the <i>Detailed Descriptions</i> chapter. If no boot medium is available, one must be created based on the instructions provided by the respective operating system documentation. For example, you can use the SIMATIC PC/PG Image Creator tool to make a USB stick a bootable medium.
2 Install the operating system on the boot medium.	Install the operating system based on the instructions provided by the respective documentation.
3 Select final boot medium	In the BIOS Setup, select the medium on which the operating system has been installed.

Additional information

Further information about installation and commissioning is available in the documentation of the respective operating system.

Integration into an Automation System

Options of integration in existing or planned system environments/networks:

Ethernet

The integrated Ethernet port (10/100/1000 Mbps) can also be used for communication and for data exchange with automation devices such as SIMATIC S7. For this purpose you require the "SIMATIC NET" software package.

PROFIBUS/MPI

The optional electrically isolated PROFIBUS interface (12 Mbps) can be used to interconnect distributed field devices or for coupling to SIMATIC S7.

The "SOFTNET for PROFIBUS" software package is required for coupling to S7 automation systems.

PROFINET

The CP 1616 onboard enables industrial PCs to be connected to Industrial Ethernet. Only one CP 1616 can be installed in a PG/PC. Detailed information can be found in the next section or in the chapter "Detailed descriptions > CP 1616 onboard.

Device driver CP 16xx.sys

The device driver enables the Windows network protocols to be connected to the Ethernet PROFINET controller "CP 1616 onboard" which is optional on the SIMATIC PCs. The PROFINET interface will act like a 100 Mbit Ethernet interface with a MAC address when you use this driver. The three RJ45 sockets are connected with each other via a switch.

The driver and the documentation can be found in the supplied Documentation and Drivers CD.

PROFINET IO application

You can create, run or configure PROFINET IO applications with the "Development Kit DK-16xx PN IO". It must be installed in addition to the device driver CP 16xx.sys. This kit and the documentation is available free of charge at the following Internet address:
http://www.automation.siemens.com/net/html_00/produkte/040_cp_1616_devlopkit.htm

SIMATIC NET PC software

You can create, run and configure the SIMATIC installation with this software package. Information on this can be found on the SIMATIC NET Manual Collection CD. The software package and the documentation are not included in the package.

CAN

CAN interface for connection to CAN field systems (on request).

RS232

The serial port can be used for data communication (via terminal applications, for example).

Additional information

For additional information, refer to the catalog and to the online ordering system of Siemens A&D.

<http://mall.ad.siemens.com>

8.1 PROFINET

CP 1616 onboard

The basic characteristics of the PCS 1616 onboard are:

- Optimized for PROFINET IO
- With Ethernet realtime ASIC ERTEC 400
- Three RJ45 sockets for connecting terminal devices or addition network components
- Integrated 3-port real-time switch
- Automatic hardware detection

CAUTION

A maximum of one CP 1616/1604 module can be installed in one PG/PC. If you want to use an additional CP 1616/1604 module, the CP 1616 onboard option must be disabled via the entry "Onboard Profinet" in the BIOS Setup under Main > Hardware Options.

Additional documentation on PROFINET

Get an overview of the information available on the topic of PROFINET.

Document name	What is contained in this document?
This documentation is not included in the product package:	
Getting Started PROFINET IO Getting Started: Manual Collection	The documents use concrete examples to provide step-by-step instructions on how to commission a fully functional application.
Manual PROFINET System Description	This gives you the basic knowledge about the PROFINET IO topics: Network components, data exchange and communication, PROFINET IO, component-based automation, application example of PROFINET IO and component-based automation.
Manual From PROFIBUS DP to PROFINET IO	Read this document if you want to convert an installed PROFIBUS system to a PROFINET system.
Readme file for CP 1616/CP 1604 and DK-16xx PN IO	This provides the latest information about the SIMATIC NET products CP 1616/CP 1604, CP 1616 onboard, the developer kit.
Configuration Manual Commissioning PC Stations	This provides you will all the information necessary for commissioning and configuring a PC as a PROFINET IO controller or IO device.
Manual SIMATIC NET Industrial Communication with PG/PC: Volume 1 - Basics SIMATIC NET Industrial Communication with PG/PC: Volume 2 - Interfaces	This manual introduces you to industrial communication and explains the available communication protocols. It also describes the OPC interface as an alternative to the IO-based user programming interface.

Document name	What is contained in this document?
S7 CPs for Industrial Ethernet Configuring and Commissioning	This provides the following support: - For commissioning S7 stations - For establishing effective communication
Manual SIMATIC NET - Twisted Pair and Fiber- Optic Networks	Configure and build your Industrial Ethernet networks based on this document.
This documentation is part of the supplied Documentation and Drivers CD:	
Operating instructions CP 1616/CP 1604/CP 1616 onboard	This provides you with all information required for operation.
Installation guide Device Driver CP16xx.sys	Read this guide if you want to install the NDIS device driver, CP16xx.sys.

Further information

You can find the information on specific products in the Internet at the address:
<http://www.siemens.de/simatic-net>

Functions

9.1 Monitoring functions

9.1.1 Overview

The following individual functions are implemented:

- Temperature monitoring
- Watchdog

Messages can be output from the monitoring modules to the applications.

The SOM software (Safecard On Motherboard) and DiagMonitor software on CD (optional) are available for Windows XP Embedded, Windows XP Professional and Windows Vista Ultimate.

The DiagMonitor software contains the monitoring software, the software for the stations to be monitored and a library for creating user-specific applications with Windows XP or XP Embedded.

9.1.2 Temperature monitoring/display

Temperature monitoring

The temperature is recorded by two temperature sensors. One sensor monitors the processor temperature and the other monitors the temperature near the RAM module.

If one of the two temperature values exceeds the configure temperature threshold (CPU: 100°C, Motherboard: 95°C), the following fault reactions are triggered:

Reaction	Option
The SOM or DiagMonitor software is enabled	None

The temperature error is retained in memory until temperatures have fallen below the thresholds and it is reset by one of the following measures:

- Acknowledgement of the error message by the SOM program
- Restart of the device

9.1.3 Watchdog (WD)

Function

If the user program does not respond to the watchdog within the predetermined monitoring time, the watchdog monitors the program process and informs the user about various reactions.

After POWER ON of the device or after a HW RESET (cold restart), the watchdog is in idle state, i.e. a reaction of the WD will not be triggered and the Watchdog LED is switched off.

Watchdog reactions

If the WD is not triggered again within the set time (by application with the help of the SOM drive), the following reactions are triggered:

Reaction	Option
Switch watchdog LED to red	None
Trigger a PC reset	Configurable
Enable the SOM or DiagMonitor software	None

Note

If the desired device reset is not performed, go the Advanced menu of the BIOS Setup and set the SafeCard functions to Enabled. Contact Customer Support for a detailed description of the Watchdog functions.

WD monitoring times

The monitoring times are defined as follows:

Normal mode: 94 ms, 210 ms, 340 ms, 460 ms, 590 ms, 710 ms, 840 ms and 960 ms.

Macro mode: 2s, 4s, 6s, 8s, 16s, 32s, 48s and 64s.

Note

Default mode

The macro mode is selected as the default during SOM operation.

Note

The watchdog is retriggered if the monitoring time is changed at the active watchdog (that is while the watchdog is running)!

See also

Watchdog enable register / 066h select register (read/write, address 062h) (Page 146)

9.1.4 Safecard on Motherboard (SOM)

This application is used to monitor PC hardware (temperature and watchdog) and to display the current measured values. A GUI is used to configure the application and also to activate the temperature monitoring and watchdog function.

Your device is equipped with three temperature sensors which are automatically detected by the application.

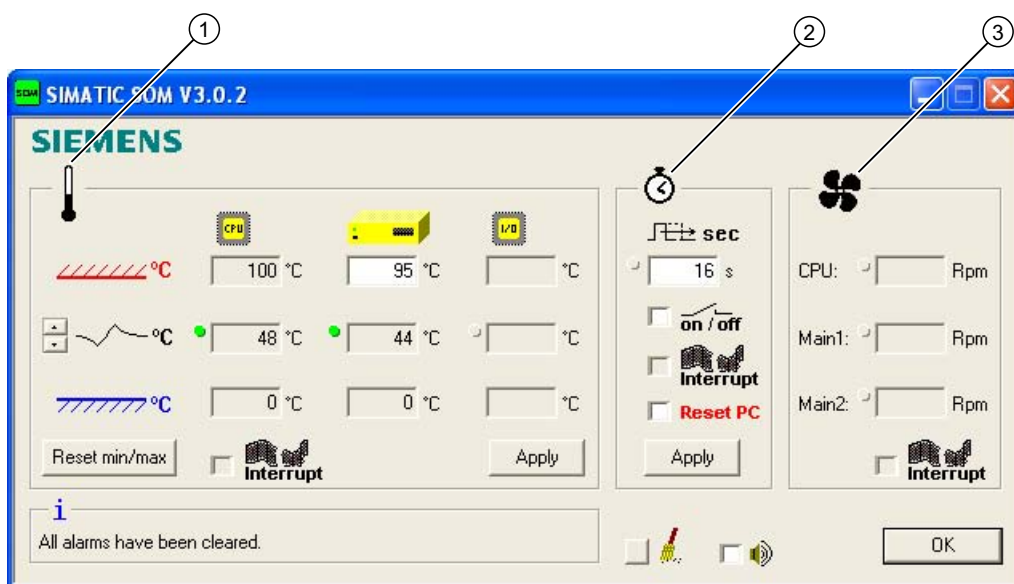

Figure 9-1 Safecard On Motherboard

1	Temperature range:	Here the current temperature and limit values are shown. You can toggle the temperature display mode to indicate either the current temperature, or the min./max. values measured since the start of the application.
2	Watchdog area:	Here, you can configure the watchdog function in your monitoring application. You can specify the watchdog time, activate a PC reset and activate / deactivate the watchdog.
3	Fan area:	This option is not enabled because the device does not have a fan.

9.2 Enhanced Write Filter (EWF)

Purpose and function

The EWF (Enhanced Write Filter) is a function that is only available with Windows XP Embedded operating systems. It provides write protection that can be configured by the user.

The Enhanced Write Filter allows you to boot Windows XP Embedded from write-protected media (such as CD-ROM), to write protect individual partitions and adapt the performance of the file system to your needs (when using Compact Flash cards, for example).

EWF can be used to minimize write access to Compact Flash cards. This is important because the write cycles on Compact Flash cards are limited due to technical reasons. We therefore recommend using EWF if you work with Compact Flash cards.

Note

The Enhanced Write Filter is disabled by default for Windows XP embedded with SP2. After the operating system has been set up, you should back up your data and then enable the EWF.

Set EWF

The EWF.MGR.EXE program can be used to install, enable or disable the EWF. Use the command prompt to call up the program. The following functions are available:

Function	Command
Write-protect drive C: Switching on	<code>ewfmgr c: -enable</code>
Write-protect drive C: disable (modified files are accepted)	<code>ewfmgr c: -commitanddisable</code>
Modified files on drive C: Accept	<code>ewfmgr c: -commit</code>
Display information about the EWF drive	<code>ewfmgr c:</code>
Display help	<code>ewfmgr c: /h</code>

Note

The EWF commands affecting the write protection do not become active until after the next booting process.

Special features for the use of Enhanced Write Filters (EWF)

- In the event of a power failure, if the EWF is enabled changes made after the boot sequence on drive C: are lost.
To prevent data loss in the event of a power failure, the use of a USV is recommended.
- You can save the files in the EWF RAM overlay to the Compact Flash card or the hard disk before you shut down the device. To do so, enter the following command in the command prompt:

```
ewfmgr c: -commitanddisable
```

Then restart the system.

```
ewfmgr c: -enable
```

Then restart the system.

Note

When the system is set to automatically adjust the clock for daylight saving time adjustment, systems without central time management and with activated EWF set the clock forward or backward by one hour in the daylight saving time or standard time period each time the system boots.

The reason for this reaction is that Windows XPe has a registry entry that detects if the clock has been adjusted for daylight saving time. Since this file is also protected against modification by the EWF, the marker is lost during the boot sequence and the adjustment is made again.

We therefore recommend that you deactivate the automatic adjustment and change the clock manually.

Procedure:

1. Switch off the EWF filter (ewfmgr c: -commitanddisable) and reboot the system.
 2. Deactivate automatic adjustment in the Control Panel. In the Time Zone tab opened with the menu command Start > Control Panel > Date and Time, remove the check mark from the "Automatically adjust clock for daylight saving changes" check box.
 3. Enable EWF again (ewfmgr c: -enable) and reboot the system.
-

9.3 SRAM buffer memory

For applications to be able to store data following a power failure, the motherboard features a battery-buffered CMOS-RAM. If the supply voltage fails longer than 5 ms, this is indicated by the DC FAIL signal.

At least 10 ms are available for copying the data to the buffered RAM. During this time, 128 Kb can be saved with a full load and even more with a smaller configuration, in other words, a lesser load.

A maximum 2048 Kb memory window is displayed via a PCI address register. The base address is initialized by the BIOS.

A corresponding function is implemented there for using the CMOS-RAM under WinAC RTX.

NOTICE

If replacement of the battery takes longer than 30 seconds, the data saved in the CMOS RAM and in the buffered SRAM is lost.
--

9.4 Battery monitoring

The installed buffer battery has a service life of at least 5 years. The status can be checked with two-tier battery monitoring. The information can be read from an I/O register and evaluated.

When the first warning level is reached, the remaining service life of the battery for buffering CMOS data and buffered SRAM is at least 1 month.

9.5 Operation without monitor and keyboard

The device can be operated without a monitor and keyboard. The device startup is guaranteed without these peripherals. A USB keyboard and mouse and an analog CRT monitor can be later connected for diagnostics.

A digital DVI monitor can only be subsequently activated when the Windows XP embedded or Windows XP Professional operating system has fully booted.

Expansions and configurations

10.1 Open the device (front panel)

CAUTION

Work on the open device may only be carried out by authorized and qualified personnel. Within the warranty time, you are only allowed to install expansions for memory and expansion card modules.

**CAUTION**

The device contains electronic components which may be destroyed by electrostatic charge.

You therefore need to take precautionary measures before you open the device. Refer to the ESD directives on handling components which are sensitive to electrostatic charge.

Tools

- Cover and top cover plate: Torx T8
- Hard disk mounting: Torx T10
- Protective earth terminal: Torx T20
- Spacing bolts PC/104: Hexagon head 5mm

Preparation

Isolate the device from power supply.

Open the device

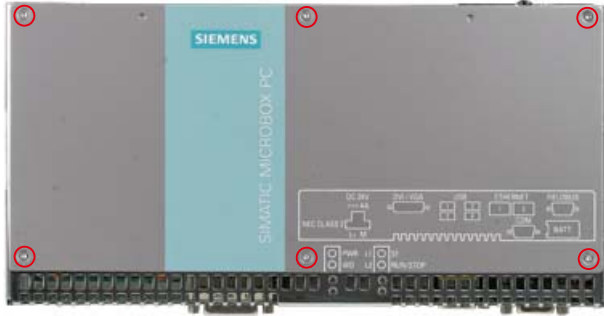
Steps in opening the device (front panel)	
1	Remove the six screws.
	
2	Remove the front panel.

10.2 Memory expansion

10.2.1 Installing the memory module

Memory expansion options

The motherboard is equipped with one slot for a memory module. An SO-DIMM DDR2 memory module can be used. This allows you to expand the memory capacity of your device to a maximum of 2 GB.

Note

We recommend using the original spare parts for memory configuration.

Preparation

Disconnect the device from the power supply.

CAUTION

The electronic components on the PCBs are highly sensitive to electrostatic discharge. Always take appropriate precautionary measures when handling these components. Refer to the ESD directives on handling electrostatic sensitive components.

Removing a memory module

How to remove a memory module	
1	Open the device.
2	Open the clamps (1). Tilt the memory module forward.
3	Carefully remove the memory module.

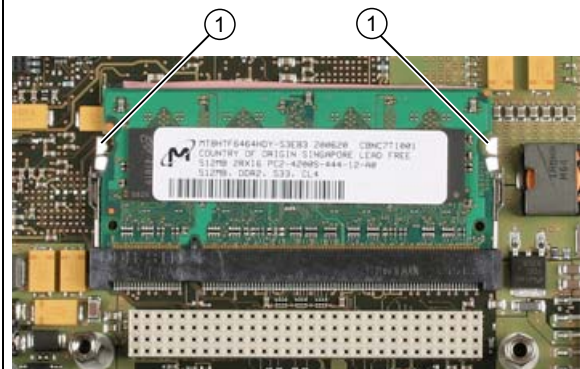

Installing a memory module

How to install a memory module	
1	Set the memory module in the mount tilting forward.
2	Push the memory module back until it locks into place.
3	Close the device.



Display of the current memory configuration

The new memory configuration is detected automatically. System RAM, Extended RAM and Cache SRAM are displayed during device startup.

10.3 Mounting PCI-104 / PC/104 Plus modules

10.3.1 Notes on the modules

Notes on module specifications

The device is designed for use with modules conforming to specifications of the PC/104 Consortium.

- PCI-104 modules: PCI compatible (120-pin plug)
- PC/104 *Plus* modules that use only the 120-pin plug (PCI bus)

Note

The necessary expansion frames for mounting these modules can be ordered as a 6-pack with the order number 6AG4070-0BA00-0XA0 via the A&D online ordering system.

NOTICE

When expanding the device with PCI-104 / PC/104 Plus modules, adhere to the safety and mounting regulations for the expansion modules.
--

The device may be mounted in an enclosure that meets the requirements of Sections 4.6 and 4.7.3 of IEC/UL/EN/DINEN60950-1.
--

10.3.2 Mounting PCI-104 or PC/104 Plus modules

Tools

Use hexagon head screws (5 mm) to mount the spacing bolts of the PCI-104- or PC/104-*Plus* module. If this is the only PCI-104 or PC/104-*Plus* module you wish to mount, you can also use screws (M3) instead of the spacing bolts.

Preparation

- Isolate the device from power supply.
- Two blanking plates are mounted on the expansion frame. If the PCI-104 or PC/104-*Plus* module features external ports, you can use these blinding plates to mount the connectors. You can also use a slot plate with existing connector perforations. The dimensional drawings provide the required measurements.

CAUTION

The electronic components on the PCBs are highly sensitive to electrostatic discharge. Always take appropriate precautionary measures when handling these components. Refer to the ESD directives on handling electrostatic sensitive components.

Mounting PCI-104 or PC/104-Plus modules

Steps for mounting an expansion module	
1	Open the device (remove front panel).
2	Insert module in slot (1)
3	Secure the module with four screws or spacing bolts.

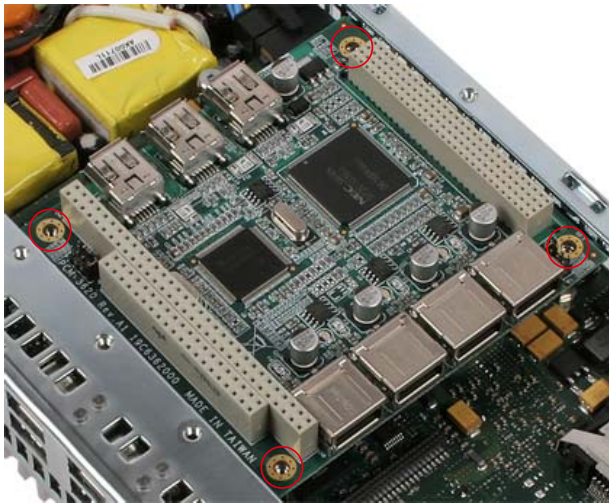
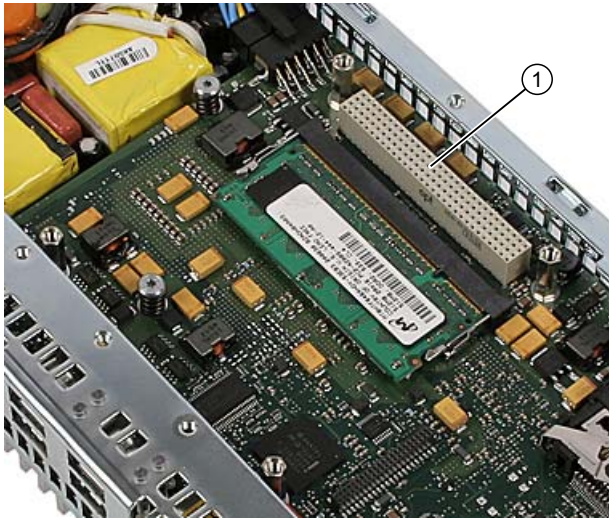

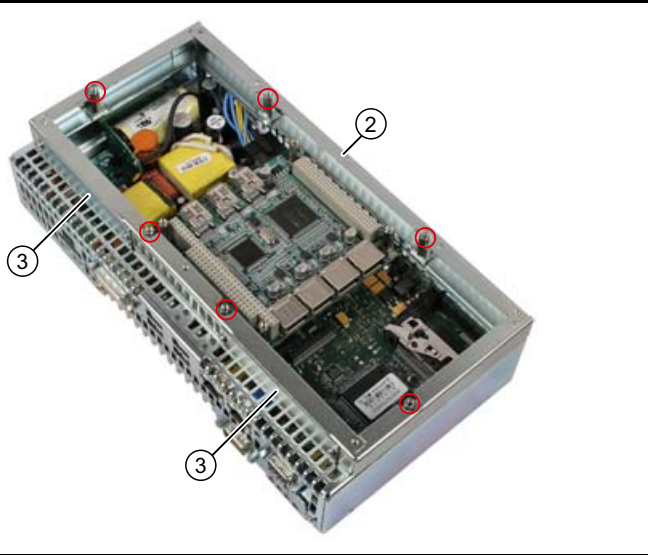
Steps for mounting an expansion module	
4 Mount the expansion frame (2) and secure it with six spacing bolts. Mount the slot plate (3) if there any external connectors.	 A photograph of the SIMATIC Microbox PC 427B showing the internal expansion frame (2) and slot plates (3) being mounted. The frame is a metal enclosure that houses the main board and expansion modules. The slot plates are used to secure the modules into the frame. The diagram shows the frame being secured with six spacing bolts (indicated by red circles) and the slot plates being mounted onto the front panel (indicated by white circles with the number 3).
5	Mount the front panel on the expansion frame.

Mounting additional PCI-104 or PC/104-Plus modules

The device can be equipped with a maximum of PCI-104 or PC/104-Plus modules. An additional expansion frame is required for each module.

Follow the mounting procedure described in the previous section (steps 2 to 4).

Configuring/installing a PCI-104 or PC/104-Plus module

You may need to make settings in the BIOS Setup. For detailed information about installation, refer to the manufacturer documentation for the respective module.

10.4 Installing/removing Compact Flash cards

10.4.1 Installation options for Compact Flash cards

Memory expansion options

The device features an accessible slot for Compact Flash cards (types I / II). As an alternative to a hard disk, you can optionally order a fixed-mounted, inaccessible Compact Flash card drive.

Only use SIMATIC PC Compact Flash cards for industrial application.



Figure 10-1 SIMATIC PC Compact Flash

10.4.2 Installing/removing an accessible Compact Flash card

Preparation

Disconnect the device from the power supply.

 **CAUTION**

The electronic components on the PCBs are highly sensitive to electrostatic discharge. Always take appropriate precautionary measures when handling these components. Refer to the ESD directives on handling electrostatic sensitive components.

Opening the module receptacle

Steps for opening the module receptacle

Turn the cover plate (1) of the module receptacle 180 degrees counter-clockwise.

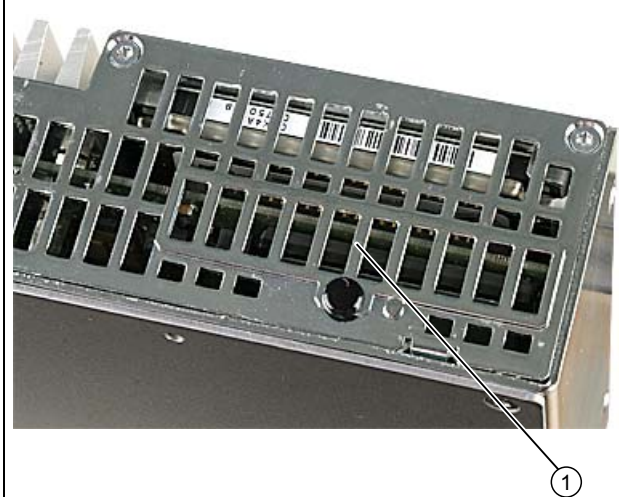

Installing the Compact Flash card

Steps for installing a Compact Flash card	
1	Open the module receptacle.
2	Insert the Compact Flash card in the slot (2) with the connector facing in until it locks into place.
3	Close the module receptacle again.

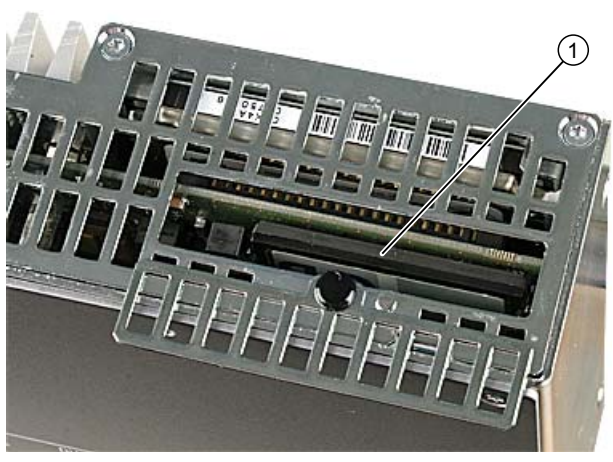

Note

The Compact Flash slot is coded against reversed insertion. Insert it so that its upper side (label side) is facing the front panel of the Microbox PC.

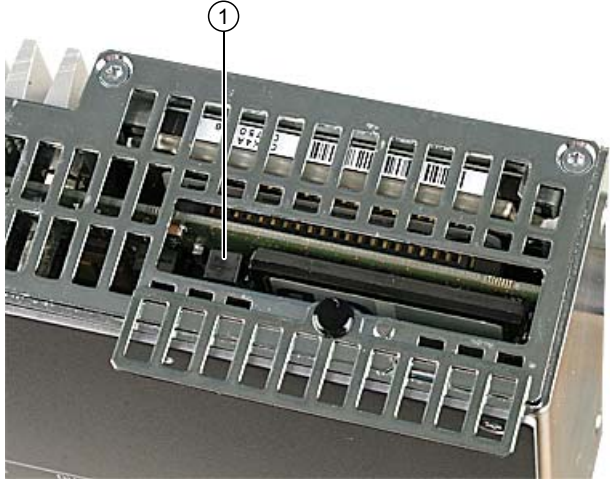

 CAUTION
If the Compact Flash card meets resistance, flip it over. Never insert the Compact Flash card with force.

Removing the Compact Flash card

Steps for removing a Compact Flash card	
1	Open the module receptacle.
2	Press the eject button (2) and pull out the Compact Flash card. 
3	Close the module receptacle again.

10.4.3 Installing/removing a built-in Compact Flash card

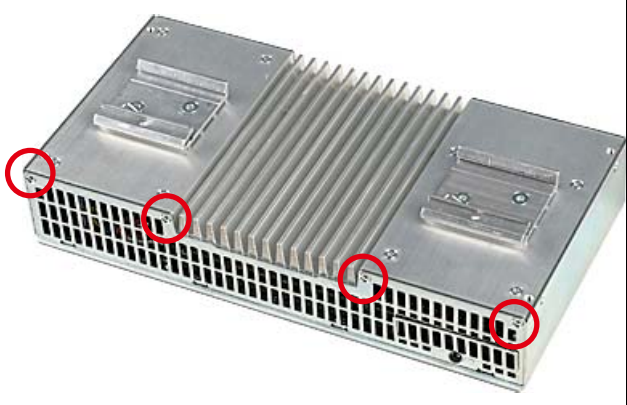
Removing/installing a built-in Compact Flash card

Steps for removing a built-in Compact Flash card		
1	Remove the four screws of the cover plate and remove it	
2	Carefully remove the Compact Flash card from the mount.	
3	Fasten the cover plate again.	

To install, carry out the above steps in reverse order.

Maintenance and service

11.1 Removing and installing hardware components

11.1.1 Repairs

Carrying out repairs

Only authorized personnel are permitted to repair the device.

 WARNING

Unauthorized opening and improper repairs on the device may result in substantial damage to equipment or endanger the user.
--

- Always separate the device from the mains before opening it.
- Only install system expansion devices designed for this device. If you install other expansion devices, you may damage the device or violate the safety requirements and regulations on RF suppression. Contact your technical support team or where you purchased your PC to find out which system expansion devices may safely be installed.

If you install or exchange system expansions and damage your device, the warranty becomes void.

NOTICE

Note the ESB instructions.

Limitation of Liability

All specifications and approvals are only valid when the expansion component feature the CE symbol. Observe the installation instructions for the expansion components.

UL approval of the device only applies when the UL-approved components their "Conditions of Acceptability" have been followed.

No liability can be accepted for impairment of functions caused by the use of third-party devices or components.

11.1 Removing and installing hardware components

Tools

- Torx T8 (cover and upper sheet metal cover)
- Torx T10 (hard disk mounting)
- Torx T20 (Protective earth terminal)
- Hexagon head 5mm (spacing bolts PC/104)

11.1.2 Preventive maintenance

To maintain high system availability, we recommend the preventative exchange of those PC components that are subject to wear. The table below indicates the intervals for this exchange.

Component	Exchange interval:
Hard disk	3 years
CMOS backup battery	5 years

11.1.3 Replacing a hard disk

 **CAUTION**

Replacement of the hard disk may only be carried out by authorized qualified personnel.

Tools

You will need size TORX T8 and T10 screwdrivers to mount the hard disk and a 5mm Allen wrench for installing/removing PC/104 modules.

You will need a TORX T20 screwdriver to loosen the protective earth terminal.

Preparation

1. Disconnect the device from the power supply.
2. Unplug all peripherals (mouse, keyboard, monitor, for example) from the device.

Removing the hard disk



NOTICE

Note the ESD instructions.

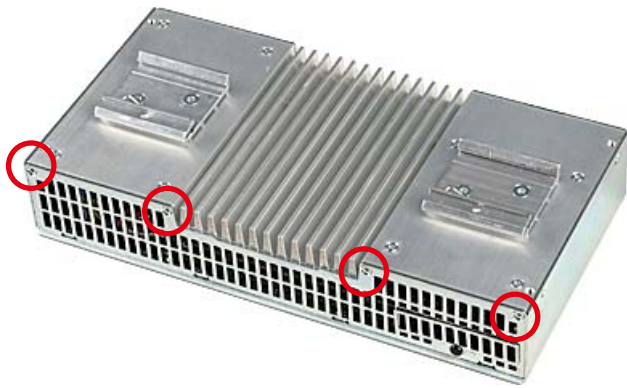
Steps for removing the hard disk

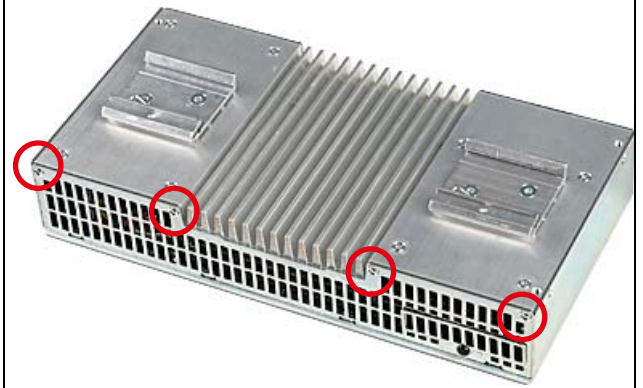
- | | | |
|---|---|--|
| 1 | Remove the four screws of the cover plate and remove it |  |
|---|---|--|

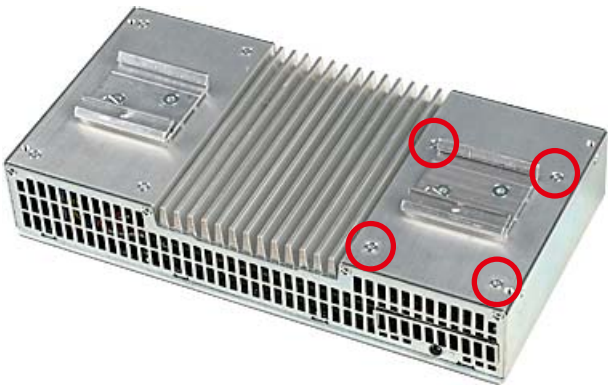

Steps for removing the hard disk		
2	Remove the 4 screws holding the hard disk to the back of the enclosure.	
3	Carefully pull out the hard disk from the enclosure.	
4	Take the hard disk from the mount	

Installing hard disk

Carry out the described tasks in the reverse order.

11.1.4 Replace the backup battery

To be noted before you replace the battery

Note

The service life of a backup battery is approximately 5 - 8 years, depending on the operating conditions.

CAUTION

Risk of damage!

The lithium battery may only be replaced with an identical battery or with a type recommended by the manufacturer (Order No.: A5E00331143).

Disposal

CAUTION

Depleted batteries must be disposed of in accordance with local regulations.

Preparation

Note

The configuration data and contents of the SRAM in the device are buffered for at least 30 seconds.

1. Note down the current settings of the BIOS setup or save the settings as a user profile in the Exit menu of the BIOS setup.
A list in which you can note this information is available in the BIOS description.
2. Disconnect the device from the power supply.

Tool

You will need a TORX T8 screwdriver to open the battery compartment.

Replacing the battery

Proceed as follows:

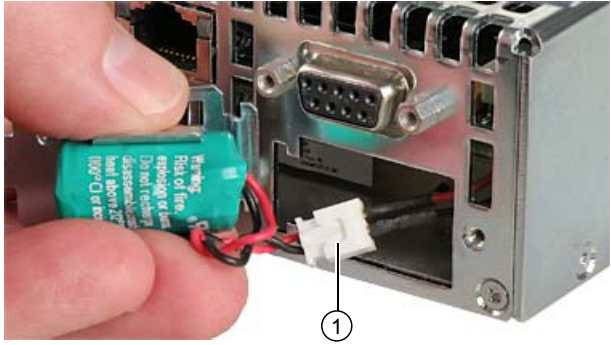
Steps for replacing the battery		
1	Open the battery compartment.	
2	Remove the battery holder.	
3	Pull out the battery plug (1).	
4	Take the old battery out of the holder.	
5	Place a new battery in the holder and reconnect the battery plug.	
6	Close the battery compartment.	

Reconfiguring the BIOS Setup

If the battery replacement takes longer than 30 seconds, the configuration data of the device will be lost. You will have to reconfigure the BIOS setup in this case.

11.2 Reinstalling the operating system

11.2.1 Windows XP Embedded

11.2.1.1 General installation procedure

If your software becomes corrupt for any reason, you can reinstall it from the Restore CD. The Restore CD contains an image file for the hard disk or CF card with the original software (operating system with installed hardware drivers).

Note

You require a USB keyboard and a USB CD-ROM drive to reinstall the operating system.

11.2.1.2 Restoring the software to factory state using the Restore DVD

You can restore the original factory software using the Restore CD/DVD. The CD/DVD contains the necessary images and tools for transferring the factory software to the hard disk or CF card of your PC. The following options are available for restoring software:

- You can restore the entire hard disk with drive C: (system) and drive D:
- You can restore drive C: only. This allows you to retain any user data on drive D.
- Restoring the entire CF card.

CAUTION
If "Restore system partition only" is set all data on drive C: (system) will be deleted. All data, user settings and all authorizations or license keys on drive C: will be lost in the process! All data on drive C: of your hard disk drive will be deleted. Setup formats the hard disk partition and reinstalls the original factory software. When you select the "Restore entire hard disk" option, ALL the data, user settings and authorizations or license keys will be lost on the hard disk.

Restoring the factory state

To restore the factory state, proceed as follows:

1. Connect a USB CD-ROM drive to the device.
2. Insert the Restore CD/DVD in the drive and reboot the device. When the BIOS message appears, press
Press <F2> to enter Setup or <ESC> to show the Boot menu
the F2 key.
3. Select the Boot menu and move the entry "CD-ROM Drive" to the first position.
4. Close the BIOS setup with the "Exit Saving Changes" entry.
5. Follow the on-screen instructions.

CAUTION
All existing data, programs, user settings and authorizations or license keys will be deleted from the hard disk and are therefore lost.

For information on the functions, refer to the README.TXT file on the Restore CD/DVD.

Note

The "Legacy USB Support" option has to be set to "Enabled" in the Advanced menu of the BIOS so that the device can address a USB CD-ROM drive.

11.2.2 Windows XP Professional

11.2.2.1 General installation procedure

If your software becomes corrupt for any reason, you have two possibilities:

- **Restoring the factory state of the software by means of the Restore DVD**
The Restore DVD contains an image of the original supplied software (operating system with installed drivers) and is included in the Windows XP Professional variant.
- **Setting up the operating system with the Recovery CD**
The recovery CD contains the tools required to set up the hard drive as well as the Windows XP Professional operating system. After the required data have been copied to the hard disk, you can run Windows XP professional Setup to install the operating system.
The Recovery CD can be obtained from the Customer Support.

Note

You will need a USB keyboard in order to reinstall the operating system.

11.2.2.2 Restoring the Software to Factory State Using the Restore DVD

You can reinstall the original factory software (included in the Windows XP Professional supply variant) using the Restore DVD. The DVD contains the necessary images and tools for transferring the factory software to the hard disk of your PC. The following options are available for restoring software:

- You can restore the entire hard disk with drive C: (system) and drive D:
- You can restore drive C: only. This allows you to retain any user data on drive D.

CAUTION
With the option "Restore system partition only", all data on drive C: (system) will be deleted. All data, user settings and all authorizations or license keys on drive C: will be lost in the process! All data on drive C: of your hard disk drive will be deleted. Setup formats the hard disk partition and reinstalls the original factory software. When you select the "Restore entire hard disk" option, ALL the data, user settings and authorizations or license keys will be lost on the hard disk.

Restoring the delivery state

To restore the factory state, proceed as follows:

1. Connect a USB DVD-ROM drive to the device.
2. Insert the Restore DVD in the drive and reboot the device. When the BIOS message Press <F2> to enter Setup or <ESC> to show the Boot menu appears, press the F2 key.
3. Select the Boot menu and move the entry "CD-ROM Drive" to the first position.
4. Close the BIOS setup with the "Exit Saving Changes" entry.
5. Follow the on-screen instructions.

CAUTION

All existing data, programs, user settings and authorizations or license keys will be deleted from the hard disk and are therefore lost.
--

For information on the functions, refer to the README.TXT file on the Restore DVD.

Note

The "Legacy USB Support" option has to be set to "Enabled" in the Advanced menu of the BIOS so that the device can address a USB DVD-ROM drive.

Setting up the language selection for Windows XP Professional / XP Embedded

The Multilanguage User Interface (MUI) allows you to set up the Windows XP Professional / XP Embedded menus and dialogs for additional languages.

Default language of your Windows XP Professional / XP Embedded MUI installation is English and a US keyboard layout. You can change the language in the Control Panel. Select:

Start > Control Panel > Regional and Language Options Languages, tab Language used in menus and dialogs field.

For the Regional and Language Options set the default as non-Unicode programs under Advanced in addition to the language for menus and dialogs.
--

11.2.2.3 Setting up the operating system via the Recovery CD/DVD

Use the supplied Recovery CD/DVD to install Windows to suit your particular requirements. The operating system used is Windows Preinstall Environment (WinPE). You also need the included Documentation and Drivers CD.

Note

Prerequisite is that you connect a USB CD-ROM drive to the device and have set the "Legacy USB Support" option to "Enabled" in the BIOS setup.

Booting with the Recovery CD/DVD

1. Insert the Restore CD/DVD in your drive and reboot the device. When the BIOS message `Press <F2> to enter Setup or <ESC> to show Bootmenu` appears, press the ESC key. The "Boot Menu" is displayed when initialization is completed.
2. Follow the on-screen instructions until the "Siemens SIMATIC Recovery" window opens.

Partition setup

After you have installed a new hard disk, or if partitions are faulty, or when you wish to change the partitioning on your hard disk, you need to create or reconfigure partitions on the hard disk.

CAUTION

When you delete or create partitions or logical DOS partitions, you lose all data on the hard disk. All partitions on the hard disk will be deleted.
--

With Windows XP operating systems, the factory state features two partitions with an NTFS file system on the hard disk. To restore the partitions to factory state, proceed as follows:

1. Boot from the Recovery CD/DVD and then follow the on-screen instructions until the Recovery functions window is displayed.
2. Start the DiskPart tool in the "Siemens SIMATIC Recovery" window. Enter the following commands in the displayed command interface:

list disk	Displays all available hard disks.
select disk 0	Selects the disk where you wish to change the configuration. 0 selects the first hard disk.
list partition	Displays all partitions on the selected hard disk.
clean	Completely wipes the selected hard disk. All information stored there is lost.
create partition primary size=n	Creates a primary partition with the n MB on the selected hard disk. Factory state values: n = 10000 for Windows 2000 or XP
select partition 1	Select the primary partition
active	Activates the selected partition
exit	Closes DiskPart.

Additional DiskPart functions:

Help	Shows all available DiskPart commands. When a command is supplemented with other parameters, the command is described with additional information. Example: create partition help
------	--

Note

Once you have change the configuration of your hard disk with DiskPart, you will need to reboot the PC for the changes to go into effect.

Boot again from the Recovery CD/DVD to format the partitions.

Format primary partition

1. Boot from the Recovery CD/DVD to format the partitions. Follow the screen instructions until the Recovery functions window is displayed.
2. Select "Start command prompt" in the Recovery functions window. In the command interface that opens, enter the following command:
`format DL:/FS:File System`
DL = Drive letter of the partition to be formatted. Valid values: C, D, E, F etc.
File system = Specifies the type of file system. Valid values: FAT, FAT32, NTFS.

NTFS is the factory setting for all Windows operating systems.

Example for a master hard disk on the IDE bus

```
format C:/FS:NTFS
```

format /? Shows all parameters of the command.

Installation of the operating system.

The recovery CD/DVD contains encrypted data that can only be transferred to this system.

1. Boot from the Recovery CD/DVD and then follow the on-screen instructions until the Recovery functions window is displayed.
2. Select "Recovery Windows ..." in the "Siemens SIMATIC Recovery" window.
3. Follow the instructions on the screen.

Note

Note that there must still be free space on the drive after the selected recovery data has been transferred:
1500 MB for Windows XP

4. Select "Start command prompt" in the Recovery functions window.
5. Enter the following command in the displayed command prompt interface:
Drive:
`cd \I386`
`Winnt32.bat`
Drive: Drive letter of the folder containing the I386 directory.
6. The preparation of the Windows installation is displayed.

7. When this is completed, close the command prompt with the `exit` command.
8. Close the Siemens SIMATIC Recovery window with the "Finish" button.
9. The Windows installation is completed following an automatic restart of the system.
10. Follow the instructions on the screen.

Note

If you want to use Windows XP as a professional you should have the following manual (not included in the scope of delivery) available:
Microsoft Windows XP Professional, the technical reference" (MSPress Nr 934).

This manual contains information specifically for administrators involved in installing, managing and integrating Windows in networks or multi-user environments.

Setting up the language selection for Windows XP Professional

The **Multilanguage User Interface (MUI)** allows you to set up the Windows XP Professional menus and dialogs for additional languages.

To install the MUI, start

"MUI-german"

or "MUI Windows XP" in root folder of your Recovery CD/DVD to run MUISETUP.EXE.
Follow the instructions on the screen to install the required languages.

Default language of your Windows XP MUI installation is English and a US keyboard layout.
You can change the language in the Control Panel. Select:

Start > Control Panel > Regional and Language Options Languages, tab Language used in menus and dialogs field.

For the **Regional and Language Options** set the default as **non-Unicode programs** under **Advanced** in addition to the language for menus and dialogs.

11.2.3 Recovery of Windows Vista

To recover Windows Vista, there is a full graphical user interface available. It may take several minutes before the first input window appears. In this window, you can set the time and currency formats and select the keyboard language.

English is the basic language and other languages can be installed later with the MUI. The MUI is on the recovery DVD.

Now follow the on-screen instructions. It may take several minutes before the next prompt for the product key is displayed.

Note

Due to the previous activation, you do not need to enter the product key (COA number). This is entered automatically during the installation.

Setting up and formatting partitions

After you have installed a new hard disk, or if partitions are faulty, or when you wish to change the partitioning on your hard disk, you need to create or reconfigure partitions on the hard disk.

In the next dialog box, you can set up the hard disk according to your requirements and add controllers that are not yet known to the system.

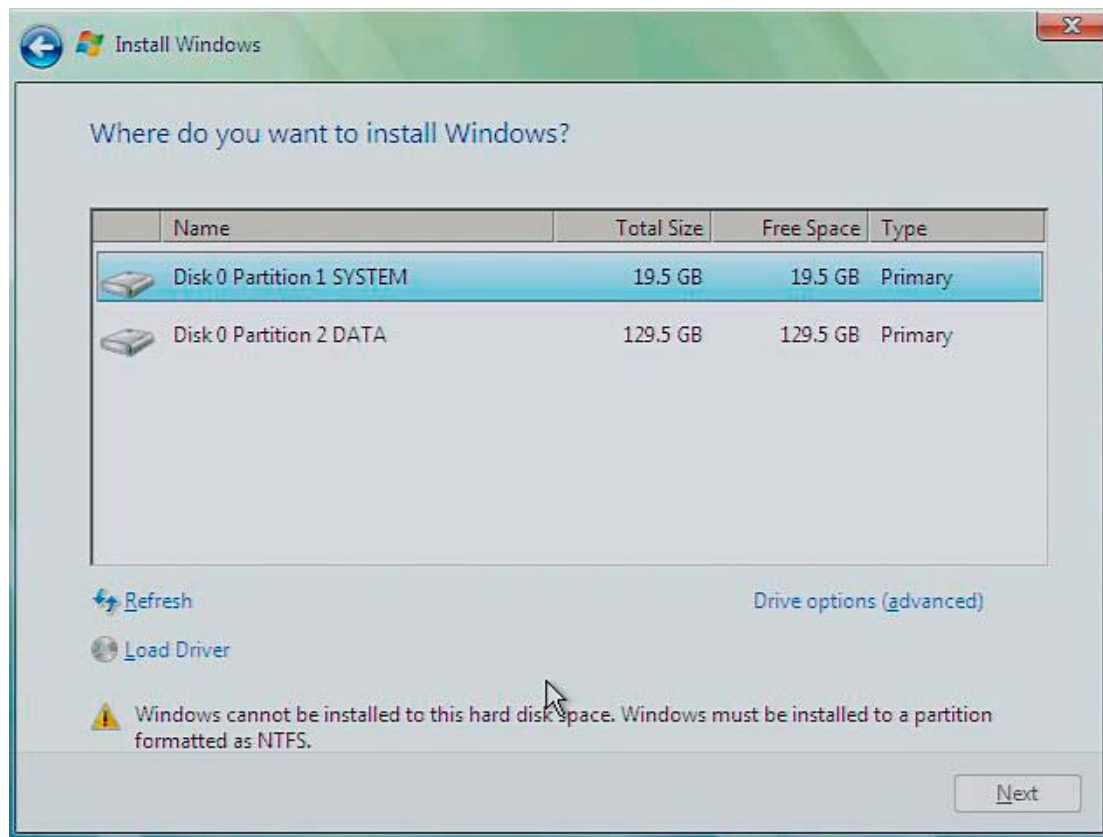

Options	Meaning
Drive options (advanced)	Further functions are displayed with which you can set up the hard disk.
Load Driver	To add new drivers, for example the driver for RAID.

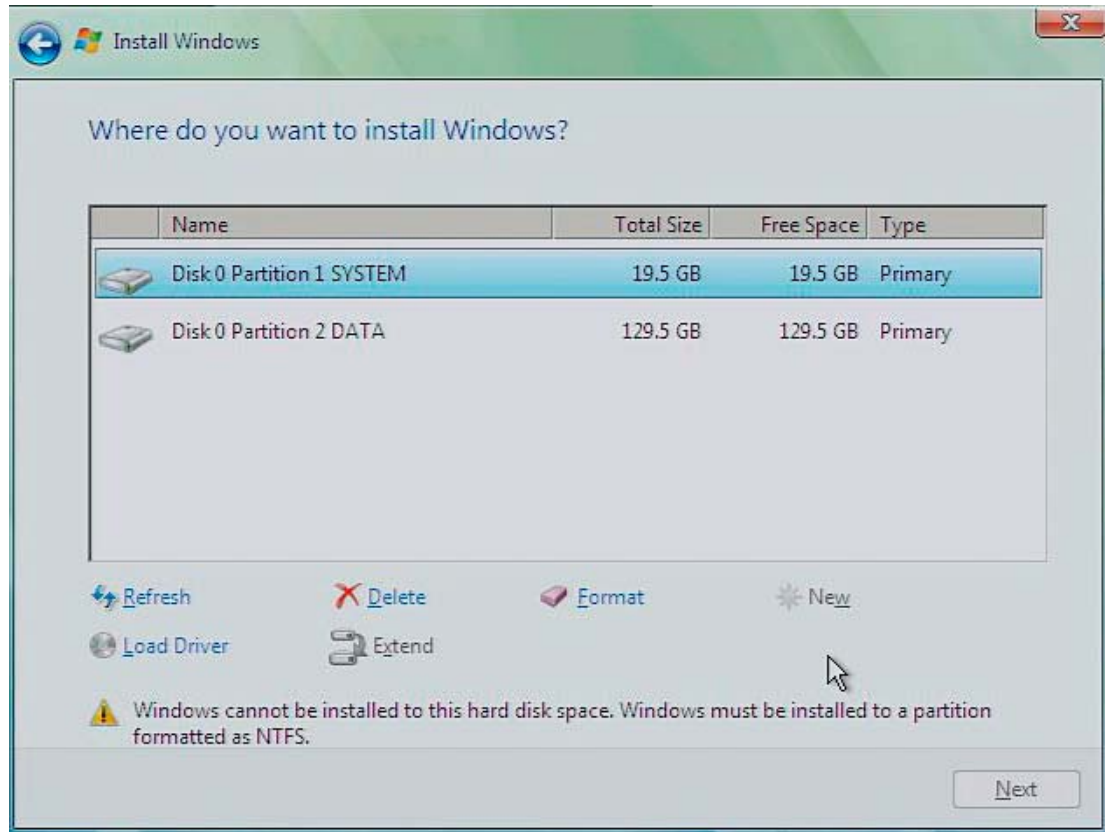

Options	Meaning
Refresh	Updating
Delete	Deleting a partition
Format	Formatting a partition
New	Creating new partitions
Load Driver	To add new drivers, for example the driver for RAID
Extend	Changing the partition size
	Any error messages that occur are displayed behind this icon, for example if the hard disk was not formatted in the required "NTFS" format.

The first partition should be at least 25 GB. The operating system must be installed on this partition. You can use the rest of the hard disk as a data partition. Both partitions must be installed as the NTFS file system.

When shipped, the partitions are set up as follows:

Partition	Operating system	Name	Size	File system
First	Windows Vista	SYSTEM	25 GB	NTFS not compressed
Second	Windows Vista	DATA	Remainder	NTFS not compressed

Following a reboot, Windows Vista is installed on the hard disk. This process takes at least 20 minutes.

Now follow the instructions on the screen.

Note

If you want to use Microsoft Windows as a professional user, you will need the following manual (not supplied):
Windows Vista Inside Out

This manual contains information specifically for administrators involved in installing, managing and integrating Windows in networks or multi-user environments.

Setting up language options in Windows Vista

With the Multilanguage User Interface (MUI), you can set up the Windows menus and dialogs for additional languages. When shipped, Windows Vista is installed with English menus and dialogs. You can change this in the Control Panel with the "Regional and Language options" or "Time and Date" dialogs.

Here, you can change all system formats:

Start > Control Panel > Clock, Language, and Region > Change display language > Regional and Language options

Here, you can only change the date and time formats:

Start > Control Panel > Clock, Language, and Region > Change display language > Time and Date

If you want to install additional languages, you can install these later in the Control Panel, as follows. You will find the necessary files on the recovery DVD in the "Languagepacks" folder.

Start > Control Panel > Clock, Language, and Region > Change display language > Regional and Language options > Keyboards and Languages

Further languages can be integrated via Windows Update.

11.3 Partitioning data media

11.3.1 Setting up the partitions under Windows XP Embedded

After you have installed a new hard disk, or if partitions are faulty, or when you wish to change the partitioning on your hard disk, you need to create or reconfigure partitions on the hard disk.

Partitioning the Compact Flash card

The factory state of the Compact Flash card includes the following partitions:

Partition	Name	Size of the card				File system
		512 MB	1 GB	2 GB	4 GB	
1. Partition	SYSTEM	455 MB	900 MB	1536 MB	2560 MB	NTFS (compressed)
2. Partition	DATA	Remainder *	Remainder *	Remainder *	Remainder *	NTFS (compressed)

* Due to partitioning/formatting, the actual Compact Flash capacity does not correspond to the memory size specified on the Compact Flash.

Partitioning the hard disk

The factory state of the hard disk with Windows XP Embedded includes the following partitions:

Partition	Name	Size	File system
1. Partition	SYSTEM	20 GB	NTFS (not compressed)
2. Partition	DATA	Remainder	NTFS (not compressed)

To restore the original partition to its factory state, we recommend the software tool **SIMATIC PC/PG Image Creator**. Detailed information about using this tool is available in the manufacturer documentation.

11.3.2 Setting up the partitions under Windows XP Professional / Vista Ultimate

After you have installed a new hard disk, or if partitions are faulty, or when you wish to change the partitioning on your hard disk, you need to create or reconfigure partitions on the hard disk.

Partitioning the hard disk

The factory state of the hard disk with Windows XP Professional / Vista Ultimate includes the following partitions:

Partition	Name	Size	File system
1. Partition	SYSTEM	15 or 20 GB	NTFS (not compressed)
2. Partition	DATA	Remainder	NTFS (not compressed)

To restore the original partition to its factory state, we recommend the software tool **SIMATIC PC/PG Image Creator**. Detailed information about using this tool is available in the manufacturer documentation.

11.4 Install drivers and software

11.4.1 Driver installation under Windows XP Embedded

The driver installation under Windows XP Embedded is conducted in the same way as under XP Professional. Pay attention to the installation instructions of the driver manufacturer.

When drivers are being installed under Windows XP Embedded, you may see a message that the Windows XP Installation CD or SP2 CD is required.

In this case, insert the Restore DVD. The required files are in the \Drivers_XPE folder.

Disable the Enhanced Write Filter before installing drivers and enable it again when you are finished.

11.4.2 Installing drivers and software

NOTICE

Before you install new drivers or updates for multilingual operating systems, (MUI versions), reset the regional settings for menus and dialogs and the default language to US English.

Install the drivers and software from the included "Documentation and Drivers" CD.
Procedure:

1. Place the CD into the drive.
2. Start the program with "START".
3. Select "Drivers & Updates" from the index.
4. Select the operating system in "Drivers & Updates".
5. Install the required driver.

NOTICE

For new Windows XP Professional / Vista Ultimate installations, the chipset driver must be installed before you install any other drivers.
--

11.5 Installing updates

11.5.1 Updating the operating system

Windows

The latest updates for Windows operating systems are available on the Internet at <http://www.microsoft.com>

NOTICE

Before you install new drivers or operating system updates for Windows MUI versions, set the default language to US English in the regional settings for menus and dialogs.

Other operating systems

Please contact the corresponding manufacturer.

11.5.2 Installing or updating application programs and drivers

A USB drive has to be connected to install the software from a CD and/or disk under Windows XP Embedded / Windows XP Professional / Windows Vista Ultimate.

Drivers for USB floppy disk and CD-ROM drives are included in Windows XP Embedded/Windows XP Professional and do not have to be installed from other sources.

For information about installation of SIMATIC software packages, refer to the corresponding manufacturer documentation.

For updates of drivers and application programs from third-party manufacturers, contact the respective manufacturer.

NOTICE

Before you install new drivers or operating system updates at Windows XP Professional MUI versions, the regional settings for menus and dialogs and the default language have to be reset to US English.
--

11.6 Data backup

11.6.1 Creating an image

Data backup under Windows XP Embedded / Windows XP Professional / Vista Ultimate

To back up data under Windows XP Embedded / Windows XP Professional / Vista Ultimate, we recommend the software tool **SIMATIC PC/PG Image Creator**. This tool provides comfortable and efficient functions for backup and restoring the full content of Compact Flash cards, of HDDs and of individual partitions (images.)

The Image Creator only supports the burning of DVD media.

The software can be ordered from the Siemens A&D online ordering system. For detailed information about SIMATIC PC/PG Image Creator, refer to the corresponding product documentation.

11.7 CP 1616 onboard

NDIS device driver

Read the information in the description Installation_CP16xx.pdf document on the supplied Documentation and Drivers CD.

PROFINET IO

Please observe the information on the SIMATIC devices and SIMATIC NET documentation listed in the chapter "Integration".

Alarm, error, and system messages

12.1 Boot error messages

During startup (the boot process), the BIOS first performs a **Power On Self Test (POST)** and checks whether certain functional units of the PC are operating error-free. The boot sequence is immediately interrupted if critical errors occur.

BIOS initializes and tests further functional units if the POST does not return any errors. In this startup phase, the graphics controller is initialized and any error messages are output to the screen.

The error messages output by system BIOS are listed below. For information on error messages output by the operating system or application programs, refer to the corresponding manuals.

On-screen error messages

On-screen error message	Meaning / tip
Address conflict	Plug and Play problem. Contact your technical support team.
Combination not supported	Plug and Play problem. Contact your technical support team.
IO device IRQ conflict	Plug and Play problem. Contact your technical support team.
Invalid System Configuration Data	Plug and Play problem. <ul style="list-style-type: none"> Set the RESET CONFIGURATION DATA option in the "Advanced" menu of Setup. Contact your Technical Support.
Allocation Error for ...	Plug and Play problem <ul style="list-style-type: none"> Undo the last hardware change. Contact your Technical Support.
System battery is dead. Replace and run SETUP	The battery on the CPU module is defective or dead. Contact your technical support team.
System CMOS checksum bad Run SETUP	Call SETUP, adjust and then save the settings. Contact Technical Support if this message persists in further retries to startup the system.
Failure Fixed Disk	HDD access error. Check the configuration in SETUP. Contact Technical Support.
Keyboard error	Check whether the keyboard is properly connected.
Key seizure	Check whether a key on the keyboard has seized.

12.1 Boot error messages

On-screen error message	Meaning / tip
System RAM Failed at offset:	Memory error. Contact Technical Support.
Shadow RAM Failed at offset:	Memory error. Contact Technical Support.
Extended RAM Failed at offset:	Memory error. Contact Technical Support.
Failing Bits:	Memory error. Contact Technical Support.
Operating system not found	Possible causes: <ul style="list-style-type: none"> • No operating system installed • Incorrect active boot partition • Wrong boot drive settings in SETUP
Previous boot incomplete Default configuration used	Abort of the previous BOOT procedure, for example, due to a power failure. Correct the entries in SETUP.
System timer error	Hardware error. Contact Technical Support
Real-time clock error	Clock chip error. Contact Technical Support.
Keyboard controller error	Controller error. Contact your technical support team.

Troubleshooting

13.1 General problems

This chapter provides you with tips on how to locate and troubleshoot common problems.

Problem	Possible cause	To correct or avoid error
The device is not operational.	There is no power supply to the device.	Check your computer configuration:
The monitor remains dark.	The monitor is switched off.	Switch on the monitor.
	The monitor is in "powersave" mode.	Press any key on the keyboard.
	The brightness button has been set to dark.	Set the monitor brightness button to obtain more light. For detailed information, refer to the monitor operating instructions.
	The power cord or the monitor cable is not connected.	<ul style="list-style-type: none"> • Check whether the power cord has been properly connected to the monitor and to the system unit or to the grounded shockproof outlet. • Check whether the monitor cable has been properly connected to the system unit and to the monitor.
		If the monitor screen still remains dark after you have performed these checks, please contact your technical support team.
The mouse pointer does not appear on the screen.	The mouse driver is not loaded.	Check whether the mouse driver is properly installed and present when you start the application program. For more detailed information, refer to the manuals for the mouse or application programs.
	The mouse is not connected.	Check whether the mouse cord is properly connected to the system unit. If you use an adapter or extension on the mouse cable, also check the connectors. If the mouse pointer still does not appear on the screen after you have performed these checks and measures, please contact your technical support team.
Wrong time and/or date on the PC.		<ul style="list-style-type: none"> • Press <F2> within the boot sequence to open BIOS Setup. • Set the time and date in the setup menu.
Although the BIOS setting is OK, the time and data are still wrong.	The backup battery is dead.	In this case, please contact your technical support team.

13.2 Problems when using modules of third-party manufacturers

Problem	Possible cause	To correct or avoid error
USB device not responding	Operating system does not support the USB port.	No remedy.
	The operating system does not have a suitable driver for the USB device.	Install a suitable driver; the correct driver can often be downloaded from the homepage of the device's manufacturer. The EWF for Windows XP Embedded must be first disabled for this.

13.2 Problems when using modules of third-party manufacturers

Problem	Possible cause	To correct or avoid error
The PC crashes during startup.	<ul style="list-style-type: none"> • I/O addresses are assigned twice. • Hardware interrupts and/or DMA channels are assigned twice • Signal frequencies or signal levels are not adhered to • Different connector pin assignments • No "Reset Configuration" in BIOS SETUP 	Check your computer configuration: <ul style="list-style-type: none"> • If the computer configuration corresponds with factory state, please contact your technical support team. • If the computer configuration has changed, restore the original factory settings. Remove all third-party modules, then restart the PC. If the error no longer occurs, the third-party module was the cause of the fault. Replace this module with a Siemens module or contact the module supplier. • Force a "Reset Configuration" using the BIOS Setup.
		If the PC still crashes, contact your technical support team.

Technical specifications

14.1 General specifications

General specifications	
Order numbers	see the order documents
Dimensions	262x133x47 (WxHxD in mm)
Weight	Approximately 2 kg
Supply voltage (DC)	24 V DC ¹ (20.4 to 28.8 V DC)
Brief power failure according to Namur	min. 15 ms (at 20.4 V) Max. 10 events per hour; min. 1 s recovery time
Maximum power consumption	2.5 A (at 24 V)
Noise emission	<40dB (A) to DIN 45635-1
Degree of protection	IP 20 to IEC 60529
Safety	
Protection class	Protection class I to IEC 61140
Safety specifications	EN 60950-1; UL 60950; CAN/CSA-C22.2 No. 60950-1; UL 508; CAN/CSA-C22.2 No. 142 or CAN/CSA-C22.2 No.14-05
Electromagnetic compatibility (EMC)	
Emitted interference	EN 55022 Class B, FCC class A
Noise immunity: Mains borne disturbance variables on supply lines	+/- 2 kV to IEC 61000-4-4; Burst +/-1 kV to IEC 61000-4-5; surge symmetric +/- 2 kV to IEC 61000-4-5; Surge asymmetric
Noise immunity on signal lines	± -1 kV to IEC 61000-4-4; Burst; Length < 3 m ± /-2 kV to IEC 61000-4-4; Burst; length > 3 m ± /-2 kV to IEC 61000-4-5; Surge; length > 30 m
Immunity to discharges of static electricity	+/-6 kV contact discharge according to IEC 61000-4-2 -8 kV air discharge according to IEC 61000-4-2
Immunity to RF interference	10 V/m 80 – 1000 MHz and 1.4 - 2 GHz, 80% AM to IEC 61000-4-3 1 V/m 2 - 2.7 GHz, 80% AM to IEC 61000-4-3 10 V 9 KHz – 80 MHz, 80% AM to IEC 61000-4-6
Magnetic field	100 A/m 50/60 Hz according to IEC 61000-4-8

General specifications

Climatic Conditions

Temperature - in operation	Tested according to IEC 60068-2-1, IEC 60068-2-2, IEC 60068-2-14 Horizontal mounting position: Operation with hard disk: +5 to +40°C Operating with CompactFlash card: <ul style="list-style-type: none"> • Without expansion modules: 0 to +50°C • Without expansion modules in RAL: 0 to +55°C • With expansion modules: 0 to +45°C • With expansion modules in RAL: 0 to +50°C Vertical / portrait mounting position: Operation with hard disk: +5 to +40°C Operating with CompactFlash card: <ul style="list-style-type: none"> • Without/with expansion modules: 0 to +40°C • Without/with expansion modules in RAL: 0 to +45°C Horizontal mounting position: Operation with CompactFlash card and without expansion modules: 0 to +40°C
- Storage/transport - Gradient	-20°C to +60°C Operating mode: Max. 10°C/h; Storage: 20°C/h; no condensation RAL = Restricted Access Location (installation of device in operating facilities with restricted access - for example, a locked control cabinet)

Relative humidity - in operation -Storage/transport	tested to IEC 60068-2-78, IEC 60068-2-30 5% to 80% at 25° C (no condensation) 5% to 95% at 25° C (no condensation)
---	--

Mech. Ambient conditions

Vibration -in operation ^{2 3} -Storage/Transport	Tested to DIN IEC 60068-2-6 5 to 9 Hz: 3.5 mm, 9 to 500 Hz: 9.8 m/s ² 5 to 9 Hz: 3.5 mm, 9 to 500 Hz: 9.8 m/s ²
Resistance to shock - Operation	tested to IEC 60068-2-27, IEC 60068-2-29 without hard disk drive: 150 m/s ² , 11 ms; with hard disk drive: 50 m/s ² , 30 ms
- Storage/transport	250 m/s ² , 6 ms

Special Features

Quality assurance	acc. to ISO 9001
-------------------	------------------

General specifications	
Motherboard	
Processor	Intel Celeron M ULV 900 MHz Intel Celeron M ULV 373, 1 GHz, 512 KB Second Level Cache Intel Pentium M LV 738, 1.4 GHz, 2 MB Second Level Cache
Front Side Bus	400 MHz
Main memory	SO-DIMM Module; 256/512/1024/2048 MB DDR2-SDRAM
Buffer memory	2 MB SRAM (128 KB of this can be backed up in the buffer time of the power supply)
Free expansion slots	Up to 3 PCI-104 or PC/104- <i>Plus</i> modules can be used (max. permitted power loss: 3 W per module, 9 W total)
Drives / storage media	
Hard disk	1x 2,5" SATA-HD optional
Compact Flash card	256/512/1024/2048/4096 MB
Graphic controller	
Graphic connector	Combined DVI and VGA
Graphics controller	Intel GMA900
Graphics memory	8 - 128 MB Shared Memory
Resolutions/frequencies/colors	CRT: 640 x 480 to 1600 x 1200 / 60 - 120Hz DVI-LCD: 640 x 480 to 1600 x 1200 / 60Hz
Ports	
COM1; COM2 (optional)	RS232, max. 115 Kbps., 9-pin Cannon, male
DVI	VGA integrated in the DVI-I
Keyboard	USB support
Mouse	USB support
USB	4x USB 2.0 high-speed / high current
PROFIBUS / MPI interface, isolated	9-pin Cannon socket, 2-row
-Transmission speed	9.6 Kbps to 12 Mbps
-Operating modes	DP master: DP-V0, DP-V1 with SOFTNET-DP DP slave: DP-V0, DP-V1 with SOFTNET DP slave
PROFINET ⁴	3x RJ45 connector, CP 1616 compatible onboard interface based on ERTEC 400, 10/100 Mbps electrically isolated *
Ethernet	2x Ethernet ports (RJ45) Intel 82573L 10/100/1000 Mbps, isolated Teaming-capable
CAN (on request)	Philips SJA1000

Technical specifications

14.1 General specifications

General specifications		
Status displays on the device		
PWR	GREEN	Indicates correct supply voltage of 3.3 V, 5 V and 12 V from the integrated power unit
WD	OFF	Watchdog disabled
	GREEN	Watchdog enabled, monitoring time not expire
	RED	Watchdog enabled, monitoring time expired
L1 (LED 1)	YELLOW	Can be controlled by user programs
SF (Group fault)	RED	Can be controlled by controller program (e.g. WinAC)
L2 (LED 2)	YELLOW	Can be controlled by user programs
RUN	GREEN	Can be controlled by controller program (e.g. WinAC)
STOP	YELLOW	
SF PROFINET (optional)	OFF	<ul style="list-style-type: none"> • CP not available • CP disabled • No error, communication established • Charging in progress
	Flashes slowly	<ul style="list-style-type: none"> • Link status error • IO controller: IO device cannot be addressed • IO controller: Duplicate IP address
	Flashes rapidly	<ul style="list-style-type: none"> • Exception error: diagnostics via web or SNMP is no longer possible
	AN	<ul style="list-style-type: none"> • Diagnostics information available • No communication established.
1	The generation of the 24 DC V supply voltage by the line-side SV must be made as functional extra-low voltage with safe electrical isolation according to IEC 60364-4-41 or as SELV in conformity to IEC/UL/EN/DIN-EN 60950-1 and LPS / NEC Class 2.	
2	with hard disk and DIN rail mounting or portrait installation: none permitted	
3	With hard disk and wall installation: 10 to 58 Hz: 0.0375 mm; 58 to 200 Hz: 4.9 m/s ²	
4	For unique labeling, the LAN interfaces are numbered on the enclosure. The operating system numbering may be different.	

14.2 Power requirements of the components

Maximum power consumption of the auxiliary components

Auxiliary components		Maximum permitted power consumption				Max. total power
		+5 V	+3.3 V	+12 V	-12 V	
USB device	High current	500 mA	--	--	--	6 W (for all USB devices)
PCI/104 modules	Per slot	1.5 A	1.5 A	0.3 A	0.2 A	9 W (for the whole device)
	Total	2 A	2 A	0.5 A	0.5 A	

NOTICE

Device can overheat!

For thermal reasons, a 3 watt power loss per PCI/104 slot should not be exceeded.

14.3 Integrated DC power supply

Technical specifications

Input voltage	24 V DC (20.4 to 28.8 V DC)
Power consumption	max. 60 W
Power failure buffering	Hold-up time > 15 ms (after > 5 ms DC_FAIL becomes active)
Maximum continuous output power	50 W
Degree of protection	IP 20
Protection class	Safety class I (A protective conductor must be connected to the device)

Note

Inrush current

The maximum inrush current is 10 A for 30ms (for source impedance 0.5 Ω)

Dimension drawings

15.1 Overview of the dimensional drawings

This section contains the following dimension drawings:

- Dimension drawings of the device
- Dimension drawings of the device with mounting brackets
- Dimensional drawings of the device with expansion frames
- Dimension drawing of the blanking plate

Note

The dimensions are always given in in mm and inch (above: Millimeter, below: Inch)

15.2 Dimension drawings of the device

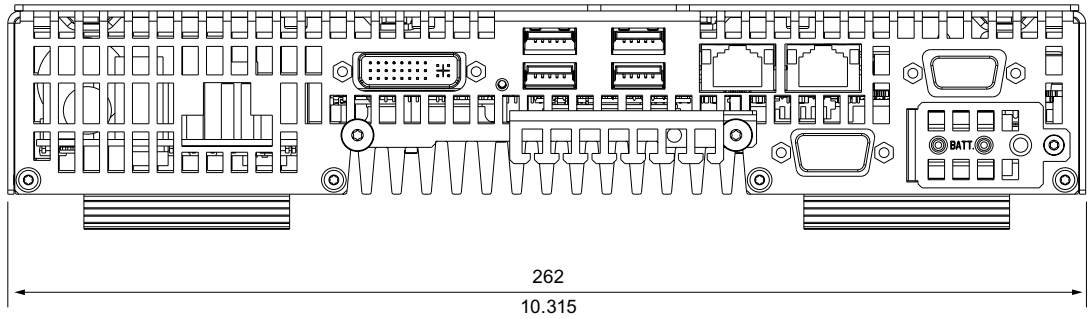

Figure 15-1 Dimensional drawing of the device: Front view

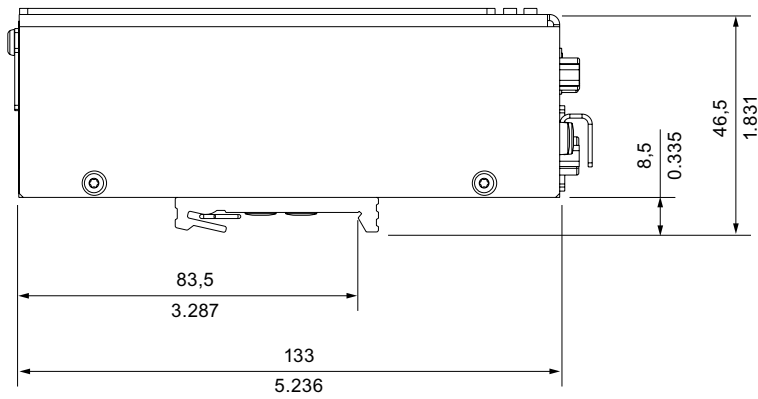

Figure 15-2 Dimensional drawing of the device: Side view

15.3 Dimension drawings of the device with mounting brackets

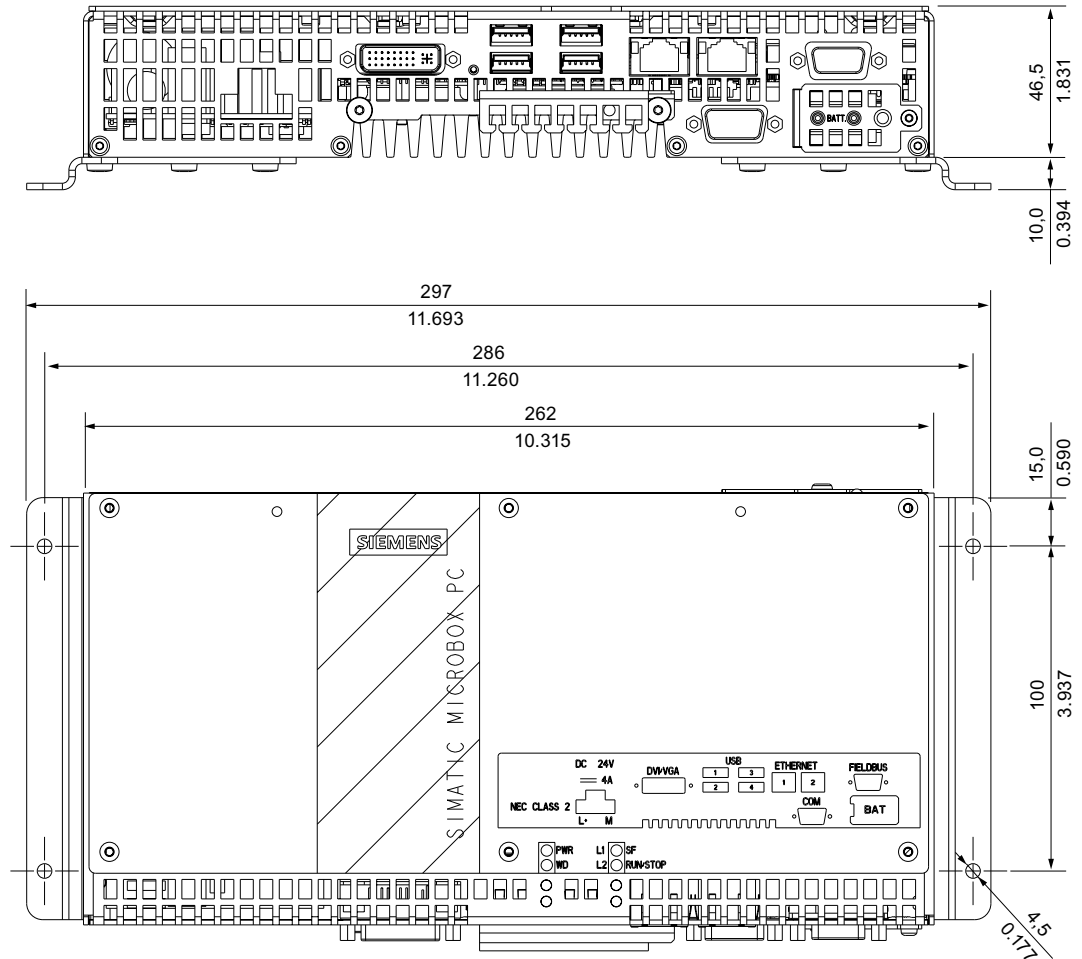

Figure 15-3 Dimensional drawing of the device with mounting brackets Front view and top view

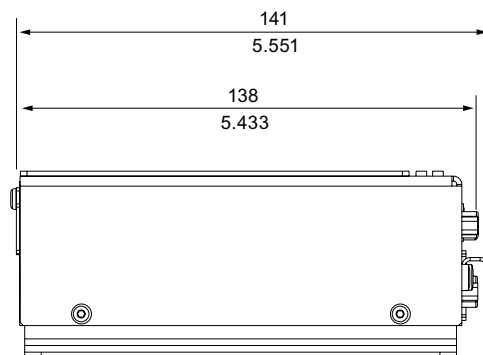

Figure 15-4 Dimensional drawing of the device with mounting brackets Side view

15.4 Dimensional drawings of the device with vertical mounting angles

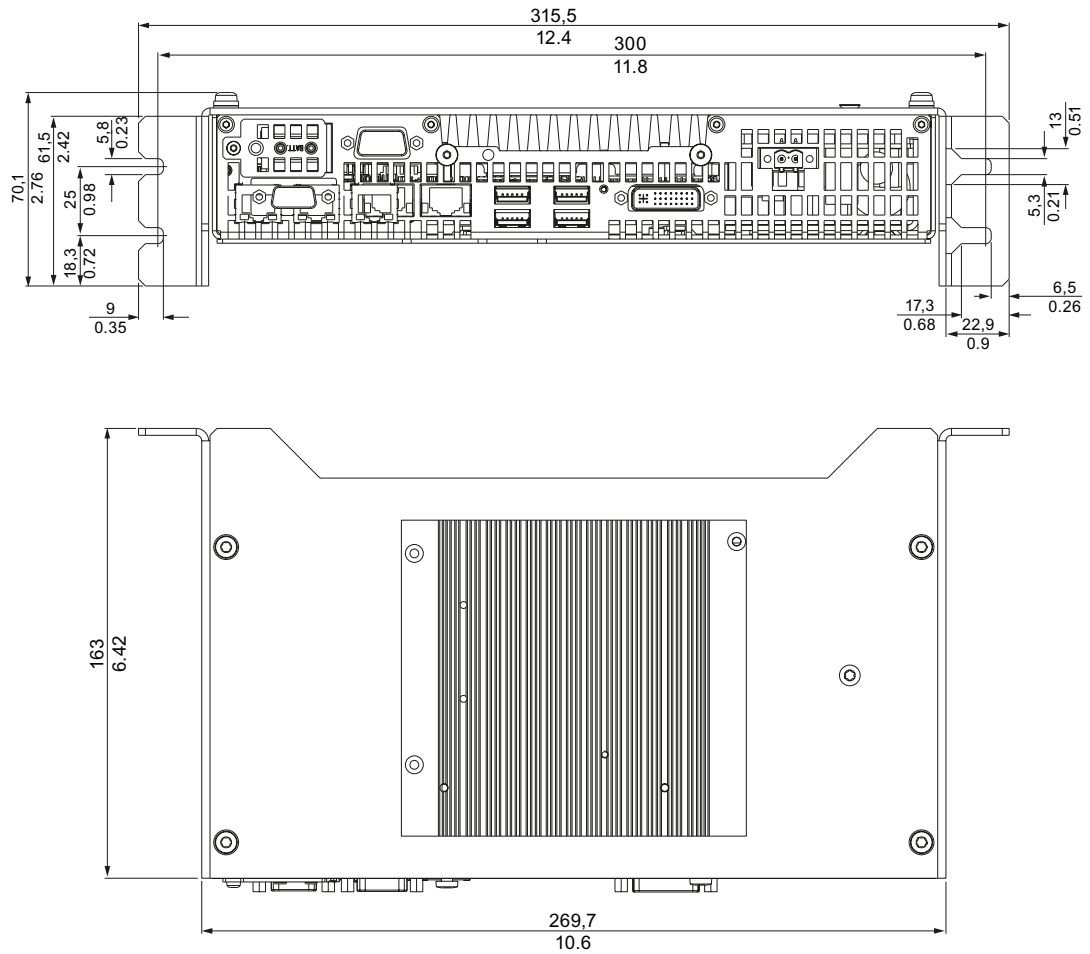

Figure 15-5 Dimensional drawings of the device with vertical mounting angles

15.5 Dimensional drawings of the device with expansion frames

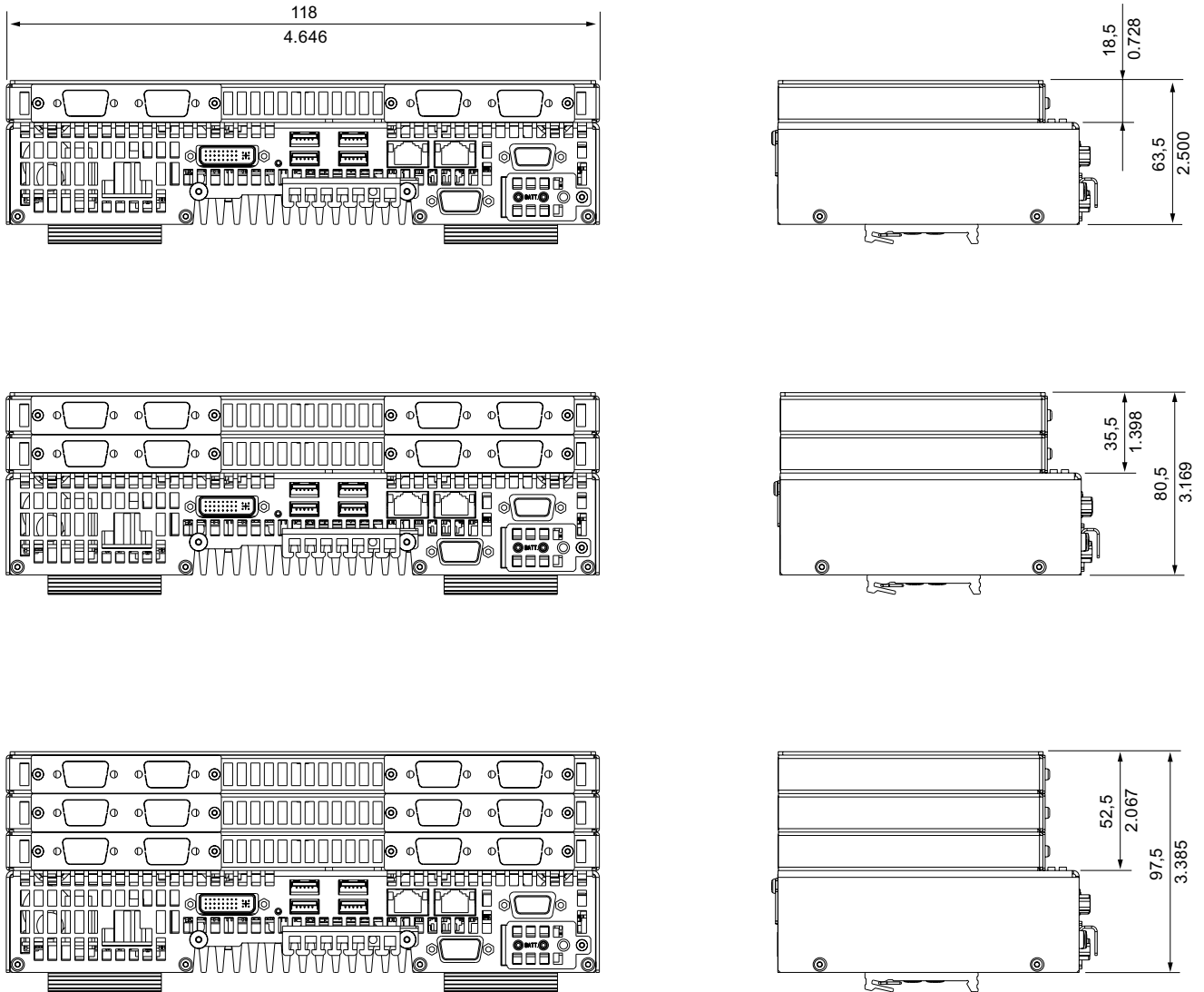

Figure 15-6 Dimensional drawings of the device with expansion frames

15.6 Dimension drawing of the blanking plate

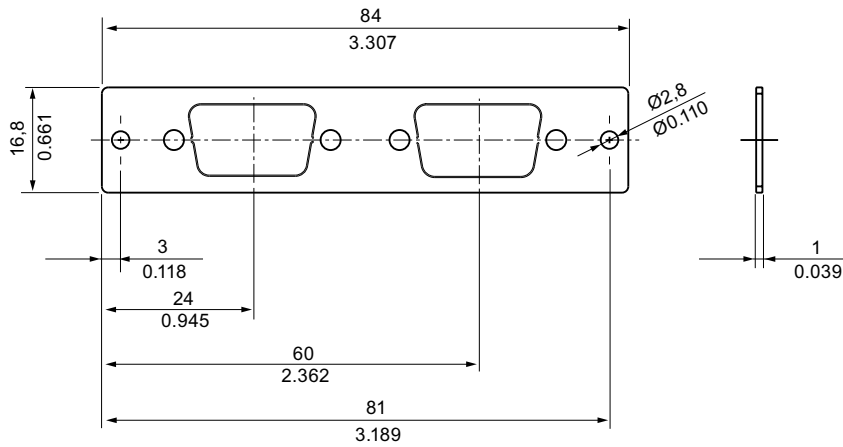

Figure 15-7 Dimensional drawing of the blinding plate

Detailed descriptions

16.1 Internal components

16.1.1 Overview of internal components

The basic components of the device are

- the motherboard with processor, the chipset, one slot for a RAM module, internal and external ports, the Flash BIOS and
- a DC/DC converter for the power supply of the device

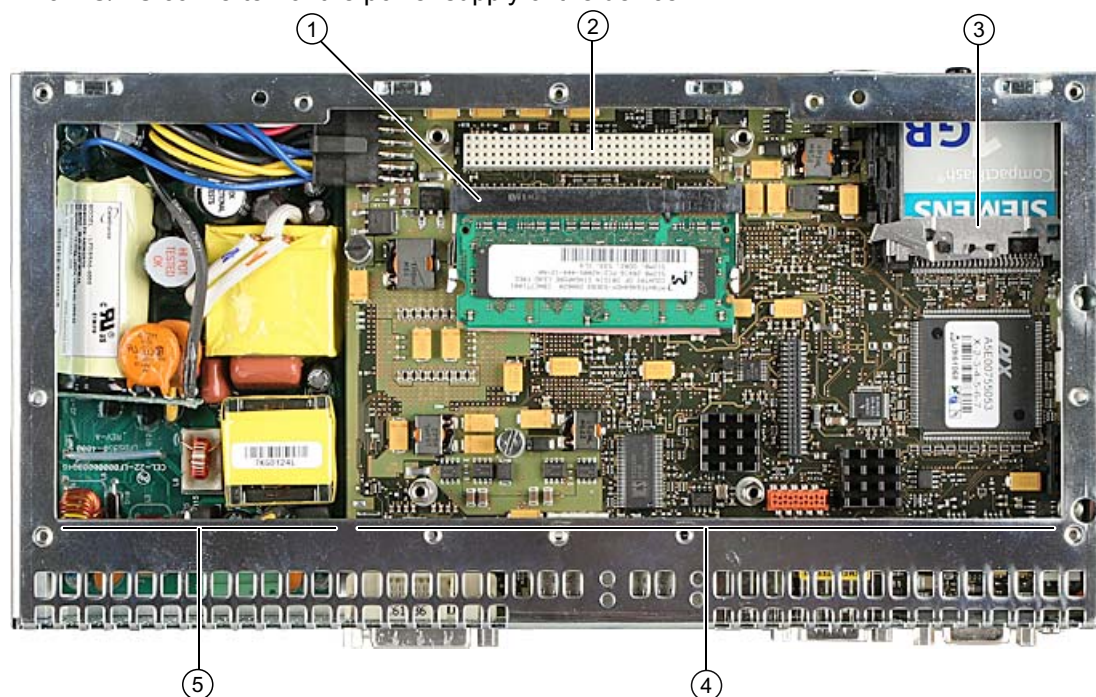

Figure 16-1 Internal layout of the device

(1)	Slot for a memory module	(4)	Motherboard
(2)	Slot for up to three PCI-104 or PC/104-Plus modules	(5)	DC/DC converter
(3)	Slot for Compact Flash card		

16.1.2 Technical features of the motherboard

Component / port	Description	Parameters
Chipset	Intel 910GML + Intel ICH6 m	
BIOS	Phoenix BIOS 4.0 Release 6.0	
CPU	Intel Celeron M Intel Celeron M Intel Pentium M	900 MHz 1 GHz 1.4 GHz
Memory	SO-DIMM module	256 MB to 2 GB DDR2-SDRAM
Graphics	Intel GMA900	8 - 128 MB graphics memory taken dynamic from RAM

16.1.3 External ports

Port	Position	Description	
COM1	external	9-pin male	V24
USB	external	Four USB channels 4 x high current	USB 1.1 USB 2.0
PROFIBUS /MPI /DP12(optional)	external	9-pin female	
PROFINET (optional)	external	3 x RJ45	CP 1616 compatible
CAN (optional)	external	9-pin female	CAN
Ethernet	external	2 x RJ45 1x RJ45 (for PROFINET versions)	10/100/1000 Mbps
DVI-I	external	DVI-I standard socket	

16.1.3.1 COM1

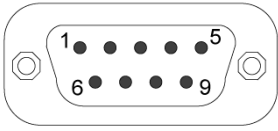
Serial port COM1, 9-pin (plug)		
		
Pin no.	Short description	Description
1	DCD	Data carrier detect (I)
2	RxD	Received data (I)
3	TxD	Transmitted data (O)
4	DTR	Data terminal ready (O)
5	GND	Ground
6	DSR	Data set ready (I)
7	RTS	Request to send (O)
8	CTS	Clear to send (I)
9	RI	Incoming call (I)

16.1.3.2 DVI-I

DV-I port, standard socket		
Pin no.	Short description	Description
1	TMDS Data2-	DVI data channel (O)
2	TMDS Data2+	DVI data channel (O)
3	TMDS Data2/4 shield	Cable shield
4	NC*	
5	NC	
6	DDC clock (SCL)	Display data channel – clock (I/O)
7	DDC data (SDA)	Display data channel – data (I/O)
8	Analog vertical sync (VSYNC)	Analog vertical sync signal (O)
9	TMDS Data1-	DVI data channel (O)
10	TMDS Data1+	DVI data channel (O)
11	TMDS Data1/3 shield	Cable shield
12	NC	
13	NC	
14	+5V power (VCC)	+5V power for DCC (O)
15	Ground (return for +5V, Hsync and Vsync) (GND)	Analog ground
16	Hot Plug Detect	
17	TMDS data 0-	DVI data channel (O)
18	TMDS data 0+	DVI data channel (O)
19	TMDS Data0/5 shield	Cable shield
20	NC	
21	NC	
22	TMDS clock shield	Cable shield
23	TMDS clock+	DVI clock channel (O)
24	TMDS clock-	DVI clock channel (O)
C1	Analog red (R)	Analog red signal (O)
C2	Analog green (G)	Analog green signal (O)
C3	Analog blue (B)	Analog blue signal (O)
C4	Analog horizontal sync (HSYNC)	Analog horizontal sync signal (O)
C5	Analog ground (analog R, G, & return) (GND)	Analog ground

16.1.3.3 Ethernet

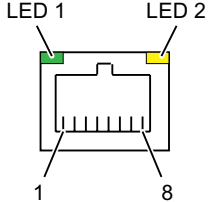
Ethernet RJ45 connection			
			
Pinno.	Short description	Description	Input / output
1	BI_DA+	Bi-directional data A+	Input/output
2	BI_DA-	Bi-directional data A-	Input/output
3	BI_DB+	Bi-directional data B+	Input/output
4	BI_DC+	Bi-directional data C+	Input/output
5	BI_DC-	Bi-directional data C-	Input/output
6	BI_DB-	Bi-directional data B-	Input/output
7	BI_DD+	Bi-directional data D+	Input/output
8	BI_DD-	Bi-directional data D-	Input/output
S		Shield	-
	LED 1	Off: 10 Mbps Lit in green: 100 Mbps Lit in orange: 1000 Mbps	-
	LED 2	Lit: Active connection (to a hub, for example) Flashing: Activity	-

16.1.3.4 USB

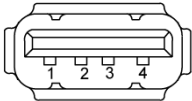
USB port, 4 channel high current		
		
Pin no.	Short description	Description
1	USB_P5V_fused (O)	+ 5 V (fused) for external USB interface
2	USB_D0M (I/O)	Data+, USB channel 0
3	USB_D0P (I/O)	Data-, USB channel 0
4	USB_GND	Ground for external USB interface

16.1.3.5 PROFIBUS

PROFIBUS interface, 9-pin (socket)		
Pin no.	Short description	Description
1-2	NC	Not connected
3	LTG_B	Data line (I/O)
4	RTS_AS	Turn on PLC transmitter (O)
5	GND	Ground isolated
6	P5V_dp_fused	+5 V (fused) isolated
7	NC	Not connected
8	LTG_A	Data line (I/O)
9	RTS_PG	PG Request to send (O)

16.1.3.6 PROFINET

PROFINET LAN X1 Port P1, P2, P3

PROFINET interface			
Pinno.	Short name	Meaning	Input / output
1	RD+	Receive data *	Input
2	RD-	Receive data *	Input
3	TD+	Transmit data *	Output
4, 5 ¹⁾	SYMR	Internal 75 Ohm terminating resistor	–
6	TD-	Receive data *	Output
7, 8 ¹⁾	SYMT-	Internal 75 Ohm terminating resistor	–
S		Shield	
	LED 1	Lights up green: link	
	LED 2	Lights up yellow: Activity	
* Auto Negotiation and auto cross over is supported			

16.1.3.7 CAN bus

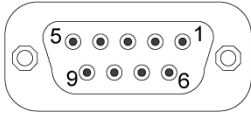
CAN bus port, 9-pin (socket)		
		
Pin no.	Short description	Description
1	-	Reserved
2	CAN_L	CAN bus signal (L active)
3	CAN_GND	CAN station ground
4	-	Reserved
5	-	Reserved
6	-	Reserved
7	CAN_H	CAN bus signal (H active)
8	-	Reserved
9	-	Reserved

NOTICE

The permitted maximum length of the CAN bus cable is 30 meters.

16.1.4 Internal interfaces

Port	Position	Connector	Description
Compact Flash card (True IDE mode)	Internal	X3	50-pin CF socket, types I / II
PCI -104	Internal		PCI interface

16.1.4.1 Compact Flash card interface

Compact Flash card interface, X3		
Pin no.	Short description	Description
41	RESET#	Reset (output)
7	CS0#	Chip select 0(output)
32	CS1#	Chip select 1(output)
34	IORD#	I/O read (output)
35	IOWR#	I/O write (output)
20, 19, 18,	A0-A2	Address bit 0-2 (output)
17, 16, 15, 14, 12, 11, 10, 8	A3-A10	Address bit 3-10 (output) to ground
21, 22, 23, 2, 3, 4, 5, 6, 47, 48, 49, 27, 28, 29, 30, 31	D0-D15	Data bits 0-15 (in/out)
37	INTRQ	Interrupt request (input)
9	OE# /ATA SEL#	Enables True IDE mode
24	IOCS16#	I/O-chip select 16 (input)
39	CSEL#	Cable select (output)
42	IORDY	I/O ready (input)
46	PDIAG#	Passed diagnostic
45	DASP#	Drive active/slave present (not connected)
26, 25	CD1#, CD2#	Card detect (not connected)
33, 40	VS1#, VS2#	Voltage sense (not connected)
43	DMARQ	DMA request (input)
44	DMACK#	DMA acknowledge (output)
36	WE#	Write enable
1, 50	GND	Ground
13, 38	VCC	+ 5V power

16.1.4.2 PCI-104 or PC/104-Plus interface (PCI part)

PCI-104 or PCI part of the PC/104-Plus interface, X7				
Pin no.	O	B	C	D
1	GND	Reserved	+5	AD00
2	VI/O 5V	AD02	AD01	+5V
3	AD05	GND	AD04	AD03
4	C/BE0#	AD07	GND	AD06
5	GND	AD09	AD08	GND
6	AD11	VI/O	AD10	M66EN
7	AD14	AD13	GND	AD12
8	+3.3V	C/BE1#	AD15	+3.3V
9	SERR#	GND	--	PAR
10	GND	PERR#	+3.3V	--
11	STOP#	+3.3V	LOCK#	GND
12	+3.3V	TRDY#	GND	DEVSEL#
13	FRAME#	GND	IRDY#	+3.3V
14	GND	AD16	+3.3V	C/BE2#
15	AD18	+3.3V	AD17	GND
16	AD21	AD20	GND	AD19
17	+3.3V	AD23	AD22	+3.3V
18	IDSEL0 = AD28	GND	IDSEL1 = AD29	IDSEL2 = AD30
19	AD24	C/BE3#	VI/O	IDSEL3 = AD31
20	GND	AD26	AD25	GND
21	AD29	+5V	AD28	AD27
22	+5V	AD30	GND	AD31
23	REQ0#	GND	REQ1#	VI/O
24	GND	REQ2#	+5V	GNT0#
25	GNT1#	VI/O	GNT2#	GND
26	+5V	CLK0	GND	CLK1
27	CLK2	+5V	CLK3	GND
28	GND	INTD#	+5V	RST#
29	+12V	INTA#	INTB#	INTC#
30	-12V	Reserved	Reserved	GND

16.2 BIOS Setup

16.2.1 Overview

BIOS Setup program

BIOS Setup program is stored in ROM BIOS. System configuration data are stored in battery-backed RAM of the device.

SETUP can be used to define the hardware configuration (for example, the hard disk type) and system properties. SETUP is also used to set the time and date of the realtime clock.

Changing the device configuration

Your device configuration is preset for operating with the included software. You should only change the default values if you have modified the technical configuration your device, or if a fault occurs when the unit is powered up.

16.2.2 Starting BIOS Setup

Starting BIOS Setup

Start the setup program as follows:

1. Reset the device (warm or cold restart).

In the figures shown, the default settings differ based on the device versions. With the default setting of your device, the display shown below appears following power-on, **for example:**

```
PhoenixBIOS 4.0 Release 6.0 cME FirstBIOS Desktop Pro -A5E00906400-ES006

Copyright 1985-2003 Phoenix Technologies Ltd.
All Rights Reserved

SIMATIC Microbox PC 427B Version U07.01.06

CPU = Intel(R) Celeron(R) M processor          1.00GHz
503M System RAM Passed
512K Cache SRAM Passed
System BIOS shadowed
Video BIOS shadowed
Fixed Disk 0: FUJITSU MHW2080BH
Mouse initialized

Press <F2> to enter SETUP or <ESC> to show Bootmenu
```

On completion of the POST, the BIOS gives you the opportunity of starting the SETUP program. The following message appears on the screen:

Press <F2> to enter SETUP or <ESC> to show the Boot menu

1. Press F2 key as long as BIOS prompt appears on screen.

16.2.3 BIOS Setup menus

The various menus and submenus are listed on the next pages. You can obtain information on the selected SETUP item from the "Item-specific help" part of the respective menu.

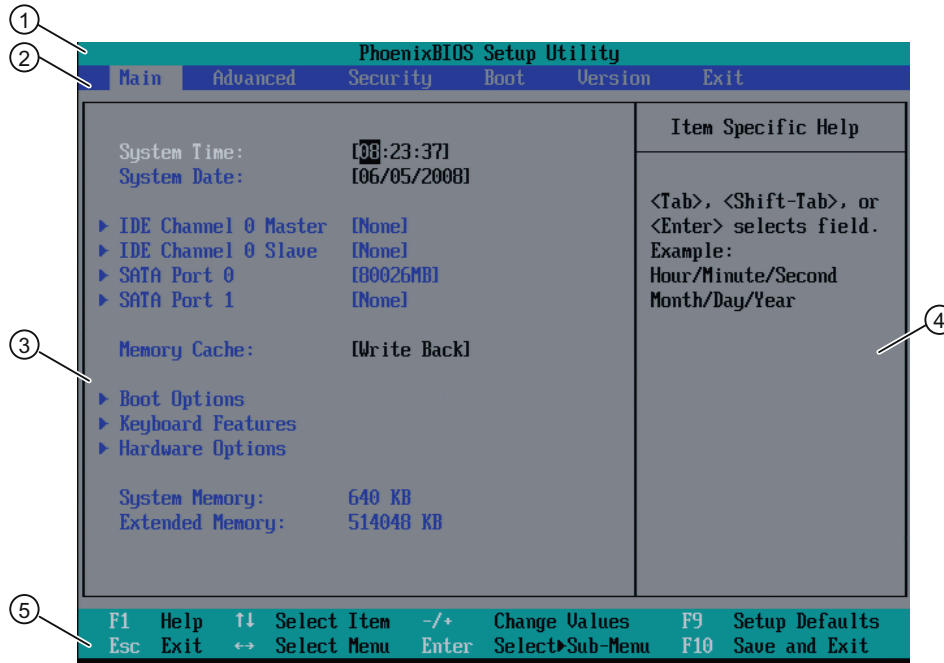

Figure 16-2 BIOS SETUP menu (example)

(1) Header	(4) Help view
(2) Menu line	(5) Input line
(3) Selectable submenu	

Menu layout

The screen is divided into four sections. In the top part (2), you can select the menu forms [Main], [Advanced], [Security], [Boot], [Version], [Exit]. In the left of the center section (3) you can select various settings or submenus. Brief help texts appear on the right (4) for the currently selected menu entry. The bottom section contains information for operator input.

The following figures represent examples of specific device configurations. The screen content may deviate slightly depending on the equipment actually supplied.

Yellow stars to the left of the interface designation (for example, Internal COM 1) indicate a resource conflict between the interfaces managed by the BIOS. In this case you should select the default settings (F9) or eliminate the conflict.

You can move between the menu forms using the cursor keys [←] left and [→] right.

Menu	Description
Main	System functions are set here
Advanced	An extended system configuration can be set here
Security	Security functions are set here, for example, a password.
Boot	This is where the boot priority is specified.
Version	Information about the programming device (for example, release status) can be found here.
Exit	Used for terminating and saving.

16.2.4 Main menu

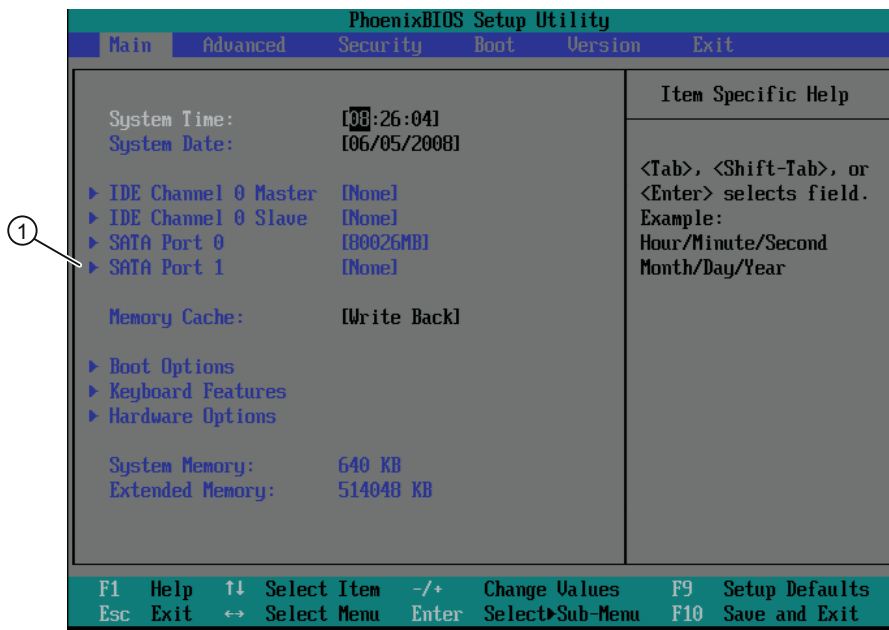

Figure 16-3 Main menu (example)

(1) Selectable submenu

Settings in the main menu

In the main menu, you can move up and down to select the following system configuration boxes by means of the [↑] up and [↓] down cursor keys:

Field	Meaning
System Time	For viewing and setting the current time
System Date	For viewing and setting the current date
Memory Cache	Used for setting the cache options
by submenus	
IDE Channel 0 Master	Type of installed disk drives
IDE Channel 0 Slave	Type of installed disk drives
SATA Port 0	Type of installed disk drives
SATA Port 1	Type of installed disk drives
Boot options	Used for setting the boot options
Keyboard Features	Used to setup the keyboard interface (for example, NUM lock, Typematic rate)
Hardware Options	Used for setting the hardware options

System time and date

System Time and System Date indicate the current values. Once you have selected the appropriate option, you can use the [+] and [-] keys to modify the time setting

Hour: Minute: Second

and for the date

Month/Day/Year

You can move between the entries in the date and time fields (for example, from hour to minute) using the tab key.

IDE Channel 0 Master, IDE Channel 0 Slave

The system jumps to the following submenu when you select this type of menu field:

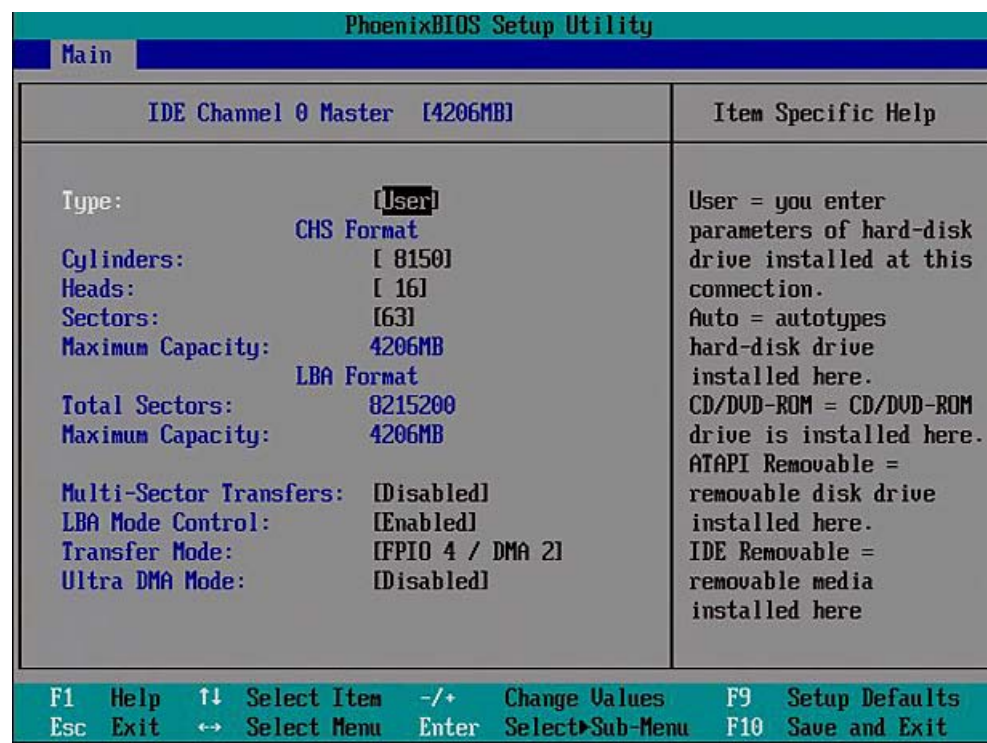

Figure 16-4 IDE Channel 0 Master (example)

Type	[User]	Select "User" to enter a user-specific definition of the hard disk type. Configure all the other options, for example, Cylinder, Heads, Sectors/Track, or other properties of the hard disk drive.
	[Auto]	The parameters which you can select here are usually saved on the respective IDE drive. The "Auto" setting in the "Type" field means that these values are automatically read from the drive and written to memory. If Type is selected for a drive that does not exist, a timeout is triggered within approximately 1 minute and the entries remain unchanged. It makes sense only to set "Auto" for interfaces to which a drive is connected.
	[CD/DVD-ROM]	CD/DVD-ROM is connected
	ATAPI Removable	A removable data volume is connected
	None	Select "None" if you have not connected a disk drive. This setting reduces system waiting time.
Multi-Sector Transfer	The number of blocks (sectors) transferred per interrupt are defined at the "Multi-Sector Transfer" option. The value depends on the drive and should only be set by way of "Auto" setting at the "Type" field.	
	Disabled	2, 4, 8, 16 sectors
LBA Mode Control	The "Enabled" setting at the "LBA Mode Control" (enabled, disabled) option means that hard disk capacities greater than 528 MB are supported. The value depends on the drive and should only be set by way of "Auto" setting at the "Type" field.	
Transfer Mode or Ultra DMA Mode	Define the data transmission rate of the interface in these fields. The value depends on the drive and should only be set by way of "Auto" setting at the "Type" field. Exit the submenu by pressing ESC.	

SATA Port 0, SATA Port 1

The system jumps to the following submenu when you select this type of menu field:

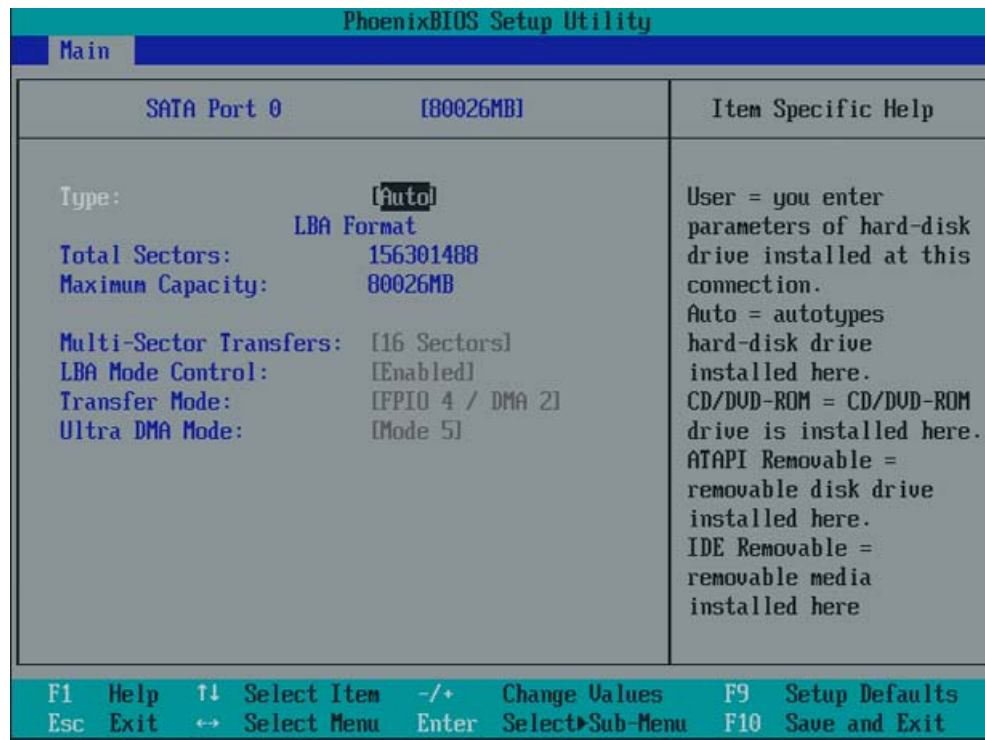

Figure 16-5 SATA Port 0 (example)

Type	[User]	Select "User" to enter a user-specific definition of the hard disk type. Configure all the other options, for example, Cylinder, Heads, Sectors/Track, or other properties of the hard disk drive.
	[Auto]	The parameters which you can select here are usually saved on the respective IDE drive. The "Auto" setting in the "Type" field means that these values are automatically read from the drive and written to memory. If Type is selected for a drive that does not exist, a timeout is triggered within approximately 1 minute and the entries remain unchanged. It makes sense only to set "Auto" for interfaces to which a drive is connected.
	[CD/DVD-ROM]	CD/DVD-ROM is connected
	[ATAPI Removable]	A removable data volume is connected
	[None]	Select "None" if you have not connected a disk drive. This setting reduces system waiting time.
Multi-Sector Transfer		The number of blocks (sectors) transferred per interrupt are defined at the "Multi-Sector Transfer" option. The value depends on the drive and should only be set by way of "Auto" setting at the "Type" field.
	Disabled	2, 4, 8, 16 sectors

LBA Mode Control	The "Enabled" setting at the "LBA Mode Control" (enabled, disabled) option means that hard disk capacities greater than 528 MB are supported. The value depends on the drive and should only be set by way of "Auto" setting at the "Type" field.
Transfer Mode or Ultra DMA Mode	Define the data transmission rate of the interface in these fields. The value depends on the drive and should only be set by way of "Auto" setting at the "Type" field. Exit the submenu by pressing ESC.

"Memory Cache" field

The following shortcut menu appears when you select the option "Memory cache" in the main menu:

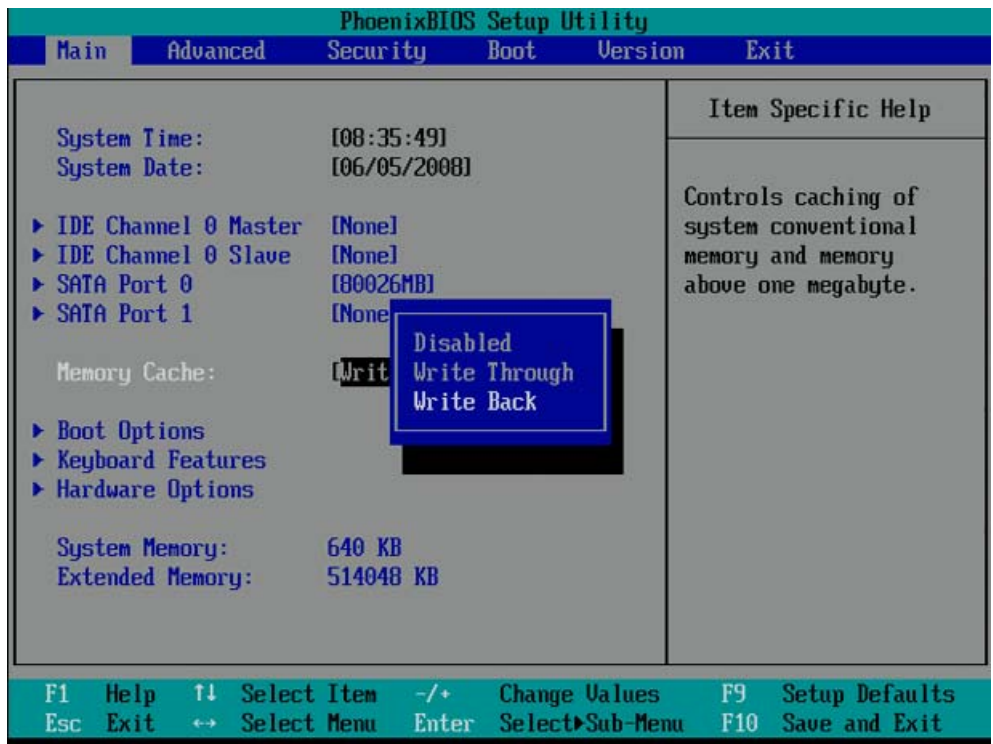

Figure 16-6 "Memory Cache" field (example)

The cache is a high-speed memory buffer between the CPU and memory (DRAM). Repeated memory access operations are executed in the faster cache, and not in the main memory, provided the feature is enabled. In some cases it may be necessary to disable the cache for certain types of hardware and software because intentional program runtimes or delay times may be prevented by the fast cache.

[Disabled]	Cache is disabled
[Write Through]	Write access is not concluded until the entry has been made in main memory
[Write Back]	Write access is concluded immediately, the entry in main memory takes place in the background (default)

"Boot Options" field

The following shortcut menu appears when you select the option "Boot Options" in the main menu:

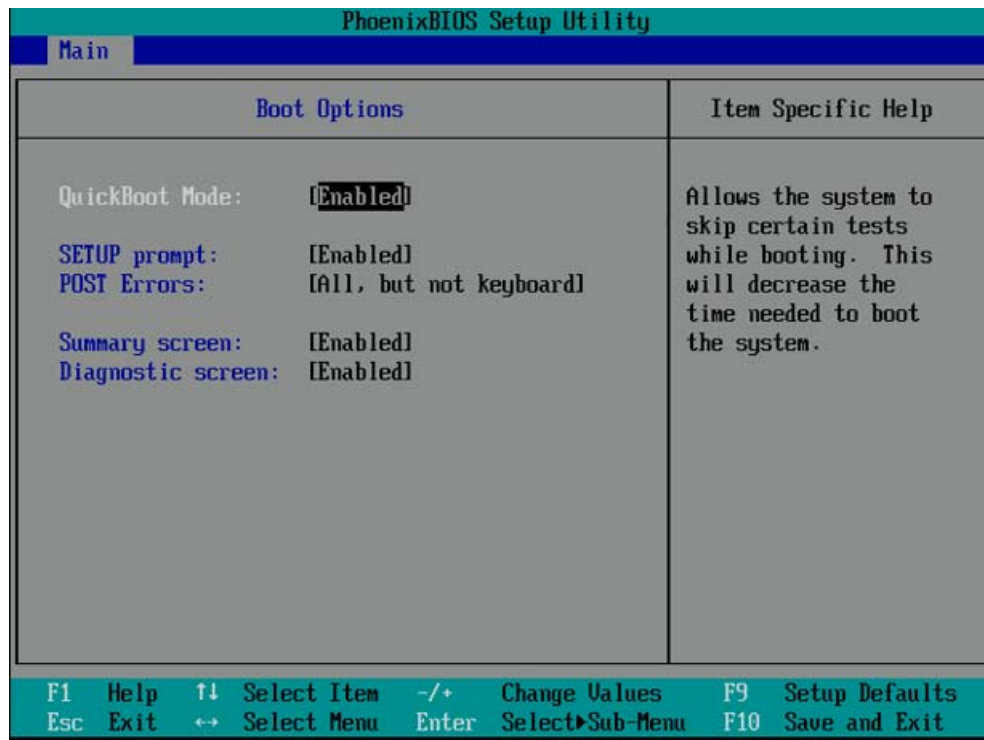

Figure 16-7 "Boot Options" field

Quick Boot Mode	Some hardware tests are skipped to speed up the boot sequence.	
SETUP prompt	During the system load phase, the message "Press <F2> to enter Setup or <Esc> to show boot menu" is output on the bottom of the screen.	
POST errors	The boot sequence is stopped if an error is detected; you must press F1 to acknowledge.	
	[Disabled]	No error confirmation is required, for example, when no keyboard is connected.
	[All, but not keyboard]	Show all errors except for keyboard errors.
Summary screen	The most important system parameters are displayed when the system run-up phase completes.	
Diagnostic screen	Shows the diagnostics messages on the monitor during booting.	

'Enabled' means that the feature is active. 'Disabled' means that the feature is inactive.

Example of a summary screen:



Figure 16-8 Summary screen (example)

The Summary screen appears when the system run-up phase completes.

"Keyboard Features" field

The following shortcut menu appears when you select the option "Keyboard Features" in the main menu:

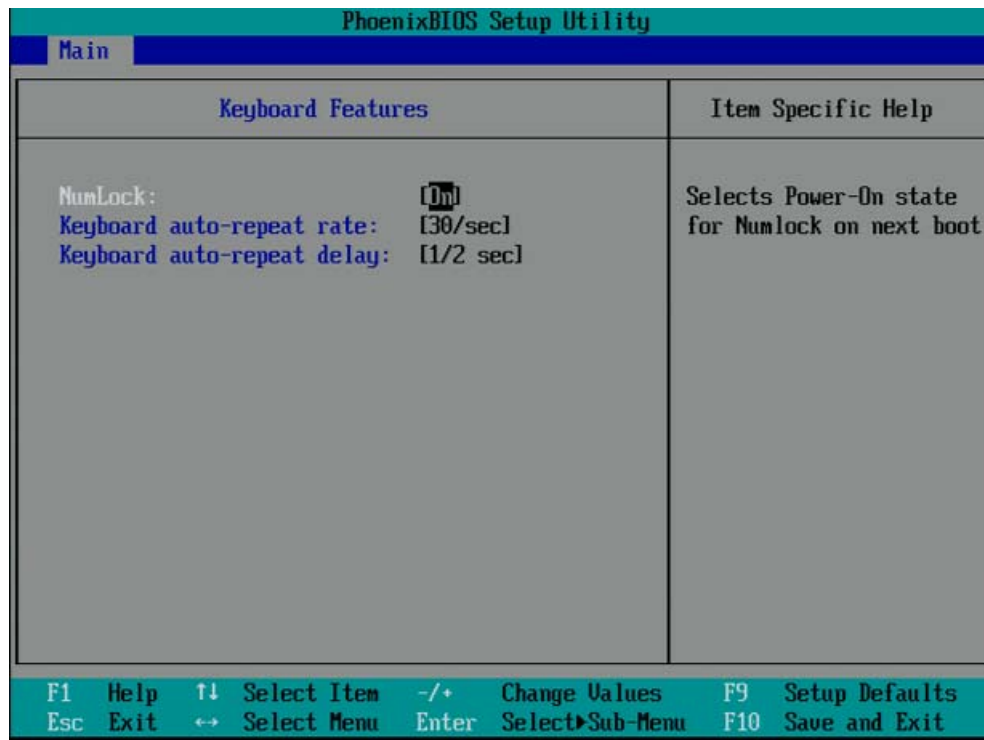

Figure 16-9 "Keyboard Features" submenu (example)

Numlock	Switches Numlock on or off following power on. This status is saved to non-volatile memory if "Auto" is set.
Keyboard auto-repeat rate	Increase in automatic key repeat rate
Keyboard auto-repeat delay	On-delay of automatic keyboard repeat

"Hardware Options" field

If you select the "Hardware Options" field in the Main menu, the following submenu will be displayed (depending on the product model):

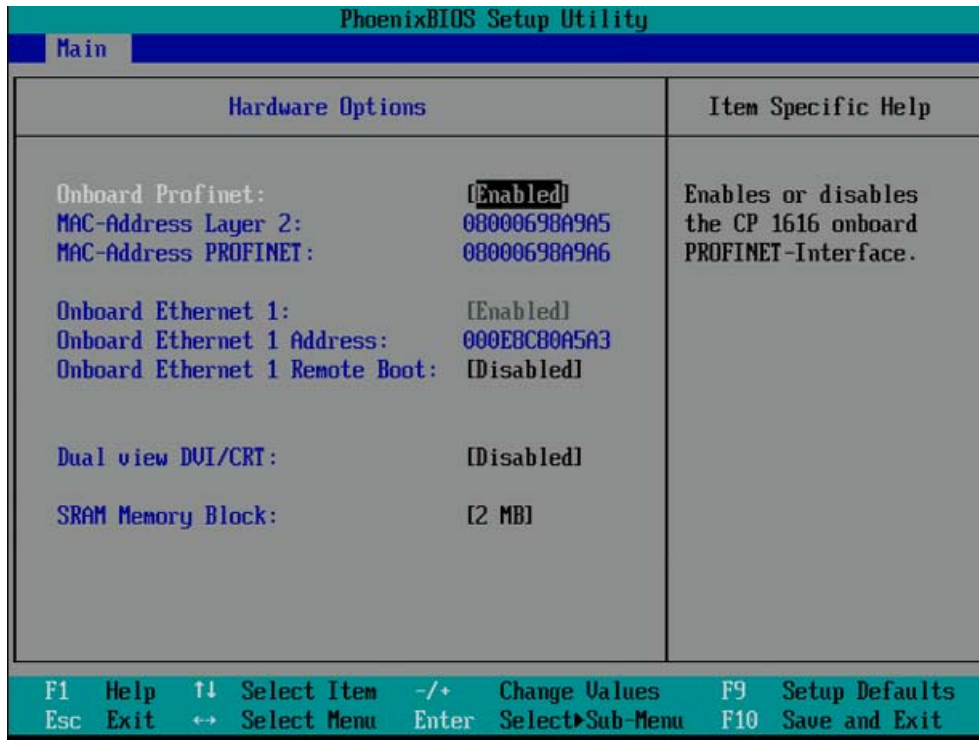

Figure 16-10 "Hardware Options" field (example for PROFINET)

The parameters of the interfaces present on the motherboard are set here.

Entry	Meaning	
PCI-MPI/DP *	[Enabled]	Sharing the MPI/DP interface. The resources are managed by the BIOS PCI Plug and Play mechanism.
	[Disabled]	The MPI/DP interface is disabled.
Onboard Profinet *	[Enabled]	CP 1616 onboard is enabled
	[Disabled]	CP 1616 onboard is disabled
MAC Address Layer 2 *		This address is for NDIS applications. Example: 000E8C8E8C0A
MAC Address Profinet *		This is the main address for PROFINET applications Example: 000E8C8E8C0B. The MAC addresses of the individual ports are derived from the "MAC Address Profinet". They are not shown in the BIOS setup. Example: P1=000E8C8E8C0B+1, P2=000E8C8E8C0B+2, P3=000E8C8E8C0B+3
Onboard Ethernet 1/2 *	[Enabled]	The Ethernet port on the motherboard is enabled.
	[Disabled]	The Ethernet port on the motherboard is disabled.
Onboard Ethernet 1/2 * Address		Shows the individual Ethernet address.

Entry	Meaning	
Onboard Ethernet 1/2 Remote Boot *	[Enabled]	Booting via a connected LAN is possible.
	[Disabled]	Booting via LAN is not possible.
Dual view DVI/CRT	[Enabled]	Dual view DVI/CRT is available via the DVI-I socket.
	[Disabled]	Only one monitor can be enabled via the DVI/VGA socket.
SRAM Memory Block	[2 MB]	SRAM is memory-mapped in the PCI address space (standard setting)
	[64 kB]	SRAM is memory-mapped in the D segment (addresses 0Dxxxxh)
* This menu command depends on the device configuration		

Note

The second Ethernet interface support is OS dependent. For DOS based applications (e.g. Image Creator) please use the first Ethernet interface.

16.2.5 Advanced Menu

Menu layout

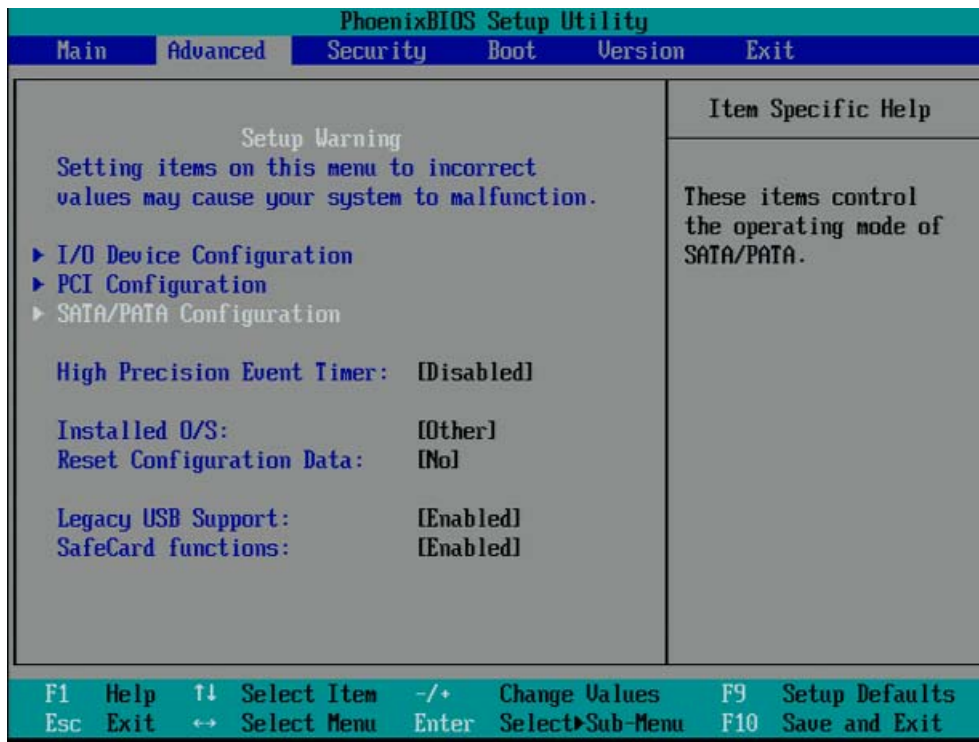

Figure 16-11 "Advanced" menu (example)

Settings in the Advanced Menu

High Precision Event Timer	[Disabled]	High-resolution timer for multimedia disabled.
	[Enabled]	High-resolution timer for multimedia enabled.
Installed O/S	Plug-and-Play means that all modules are automatically detected and installed, provided the modules support this functionality.	
	[Other]	BIOS handles the entire Plug&Play capability, default setting.
	[WinXP/2000]	The operating system handles the Plug-and-Play functions.
Reset Configuration Data	[Yes]	All Plug-and-Play data are deleted and the configuration is initialized at the next system restart. The entry is then reset to [No]. System components that do not support Plug&Play have to be entered manually.
	[No]	The Plug&Play system components are initialized after the next system start.
Legacy USB support	[Disabled]	Disables Legacy Universal Serial Bus support
	[Enabled]	Enables Legacy Universal Serial Bus support The USB Boot function must be enabled to allow booting from a USB device, or if the system is to be operated without USB support with a USB keyboard or mouse.

SafeCard functions	[Enabled]	On-board monitoring functions are enabled.
	[Disabled]	No monitoring functions.
	The relevant driver and the application must be started for operation of the monitoring functions.	

"I/O Device Configuration" submenu

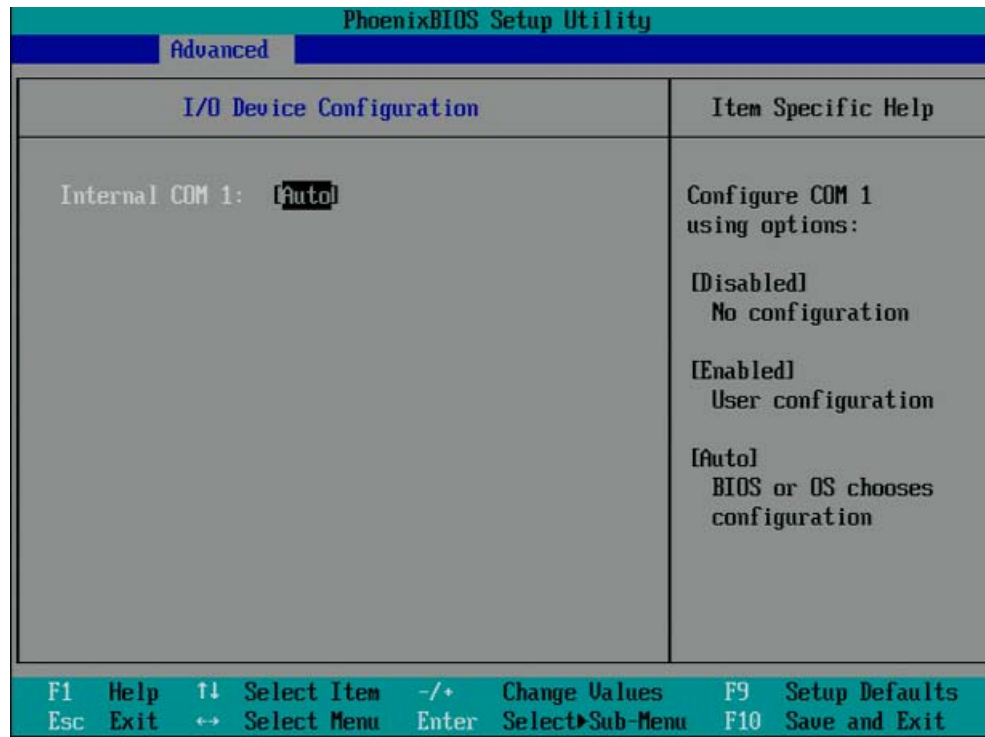

Figure 16-12 "I/O device configuration" submenu

The resources used by an interface are released when you disable the interface in question. The I/O addresses and interrupts are pre-assigned; it is advisable not to change these default assignments.

"PCI Configuration" submenu

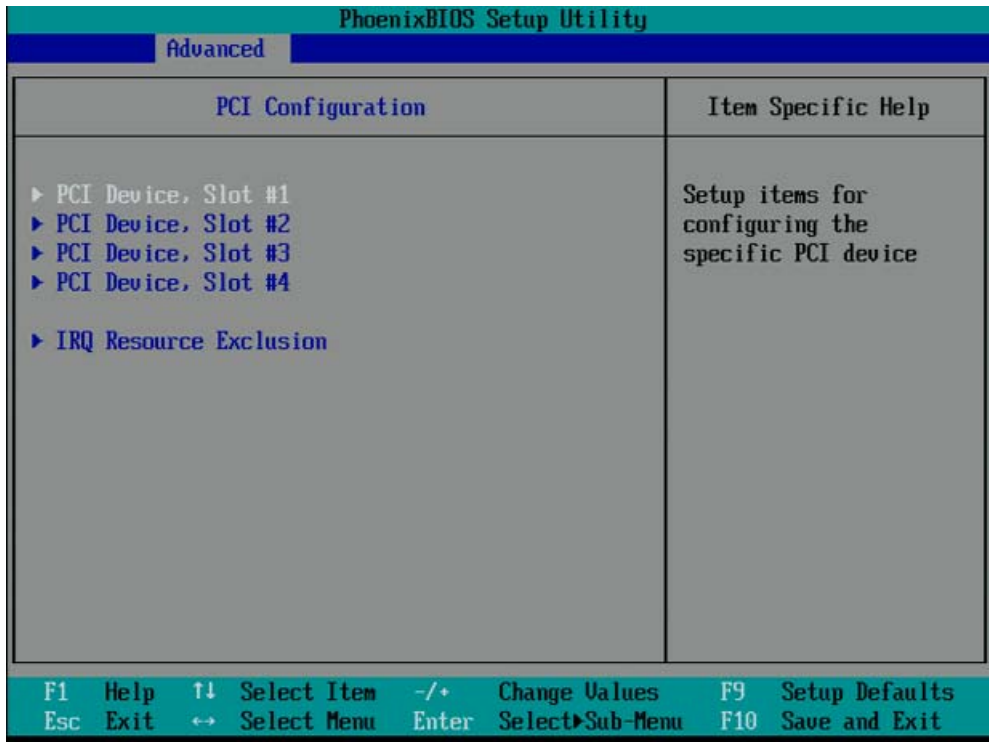

Figure 16-13 PCI Configuration submenu (example)

"PCI Devices" field

If the PCI devices field is selected, the following submenu appears:

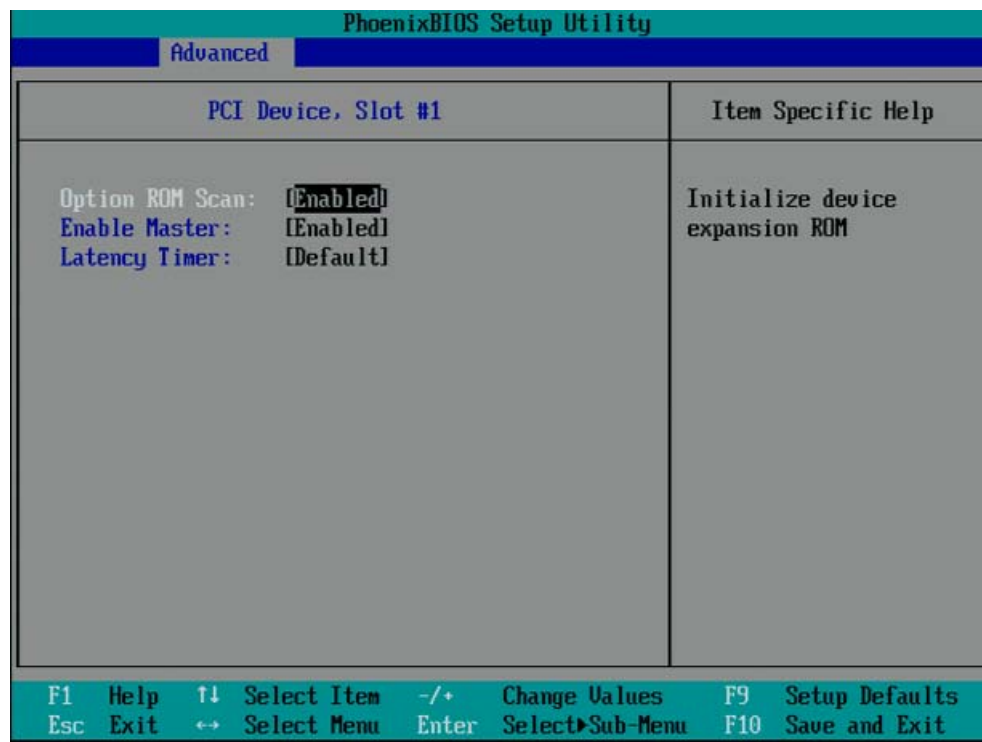

Figure 16-14 Field PCI Devices, Slot #1

ROM scan option:	[Enabled]	The ROM option of the PCI module (if present) is enabled
	[Disabled]	The ROM option of a PCI module is disabled.
Enable Master	[Enabled]	This slot can be assigned PCI master functions
	[Disabled]	This slot can only operate as PCI slave.
Latency Timer	[Default]	The number of active PCI clock cycles of the master modules is determined by this module
	[0020H to 00E0H]	These settings are used to set the maximum number of active PCI clock cycles to the selected value.
	You should only use a value different from the default if the module or its application requires it.	

"IRQ Resource Exclusion" submenu

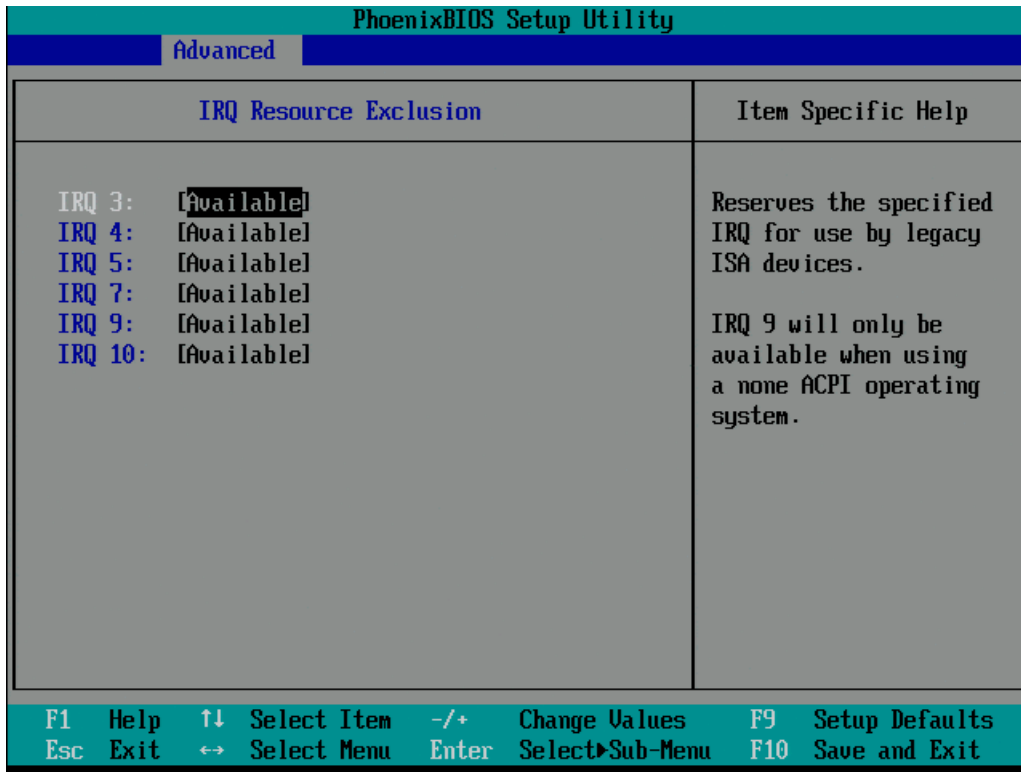

Figure 16-15 IRQ Resource Exclusion submenu

Available means that the Plug and Play mechanism in BIOS can allocate the IRQ to Plug and Play submodules or motherboard functions.

Note

Use the 'Reserved' setting only if the interrupt has to be assigned specifically to submodules with no Plug-and-Play capability.

"SATA/PATA Configuration" submenu

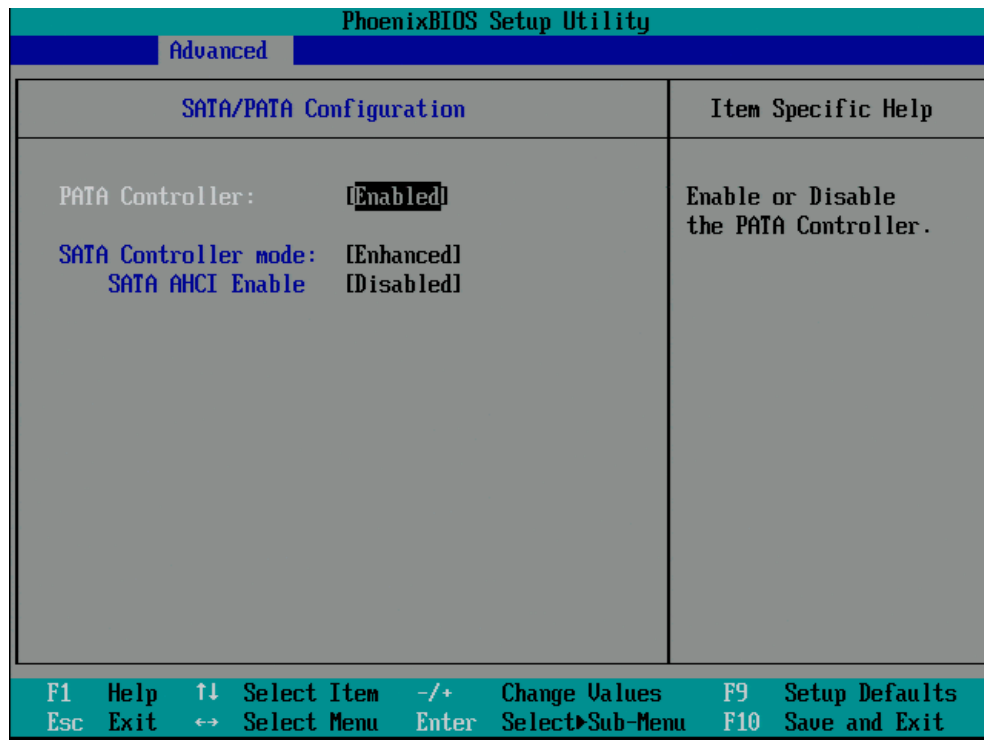

Figure 16-16 SATA/PATA Configuration

PATA Controller:	[Enabled] [Disabled]	Disables or enables the PATA controller
SATA Controller mode	[Enhanced]	Extended operating mode of the IDE controller for Windows or newer operating systems (default setting)
	[Compatible]	Compatible operating mode of the IDE controllers for older operating systems
AHCI Support	[Disabled] [Enabled]	Another operating mode of the IDE controller Important: Do not change this setting after installing the operating system.

16.2.6 Security menu

You can only edit the fields enclosed in square brackets. Two passwords can be assigned to protect your PC from unauthorized use. The Supervisor password can be used to restrict access to the hard disks.

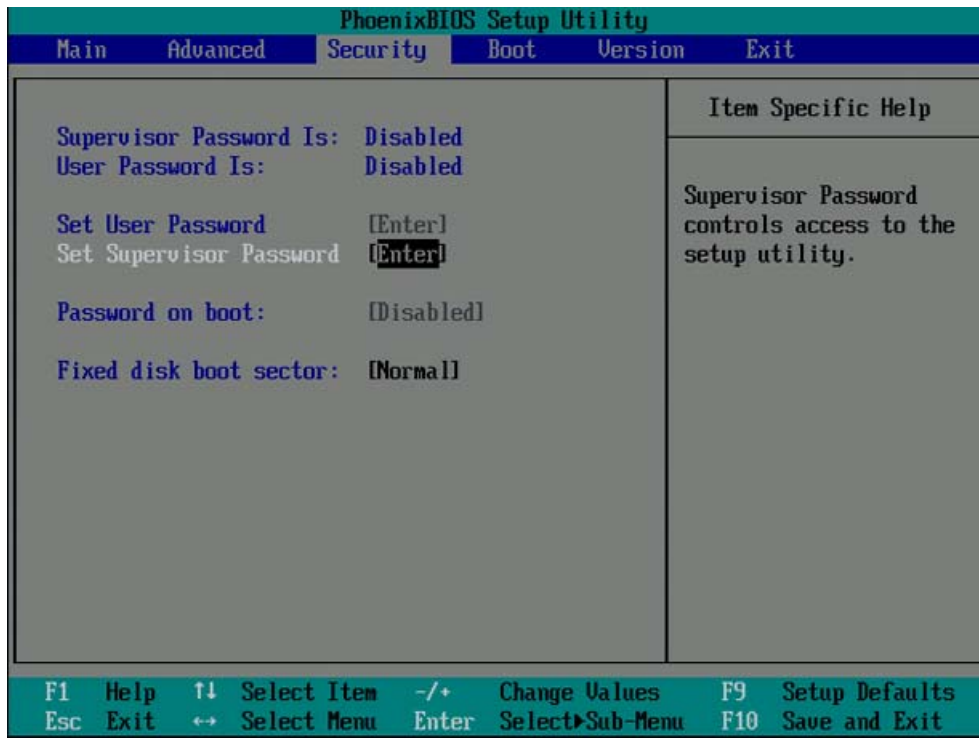

Figure 16-17 Security menu (example)

User password is	Disabled	The password is disabled.
	Enabled	Certain Setup fields are configurable by the user, including the user password.
	The field resets automatically from [Disabled] to [Enabled] when the password is entered.	
Set Supervisor Password	This field opens the password input dialog. Authorized logged on users can change the supervisor password, or delete and deactivate it by pressing "Return."	
Set User Password	This field opens the password input dialog. Logged on users can change the password, or clear and deactivate it by pressing "Return."	
Password on boot	[Disabled]	No password prompt for booting.
	[Enabled]	Supervisor or user password must be entered for system boot.
Fixed disk boot sector	[Normal]	All types of hard-disk access are permitted.
	[Write protect]	the user cannot install an operating system. This is a way of protecting against boot viruses.

16.2.7 Boot menu

This menu allows you to assign a priority for the boot devices.

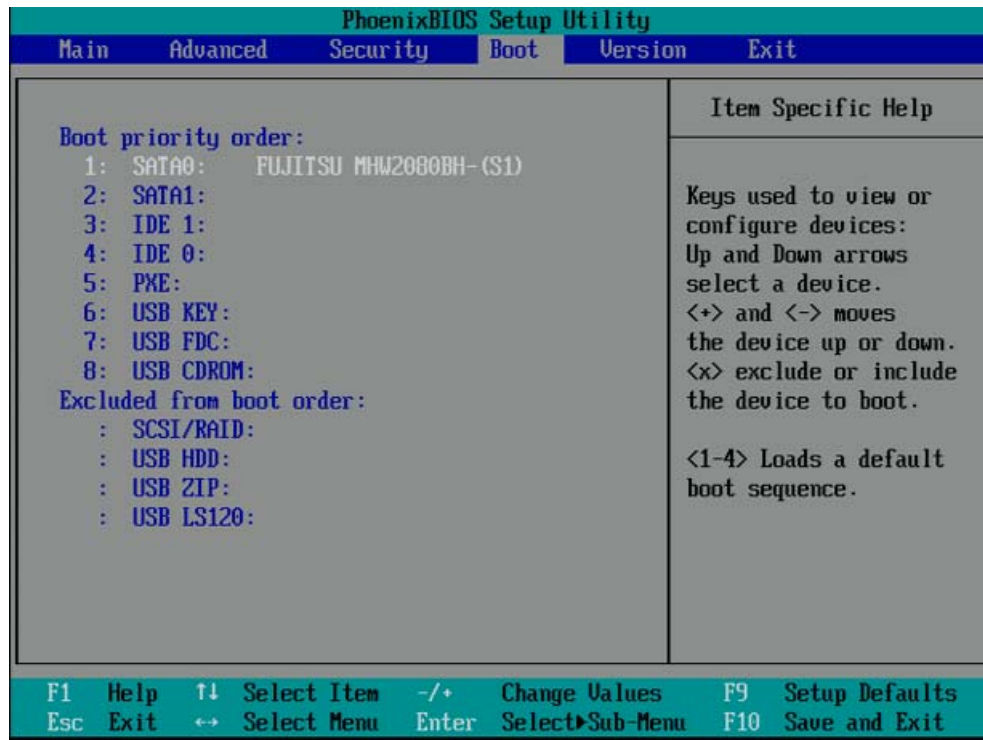

Figure 16-18 Boot menu (example)

This screen shows all possible boot devices. The boot source with highest boot priority is shown at the top. To change the sequence:

Select the boot source with the ↑↓ keys, move to the desired position with + or -.

With the x key, a selected boot source is moved in the "Boot priority order" or "Excluded from boot order" list.

Note

You can open the Boot menu and select the boot volume by pressing the ESC key during system startup.

If a boot device is not available, the next device in the sequence is automatically checked to ascertain whether or not it is bootable.

Using the 1, 2, 3, 4 keys, you can select from 4 pre-defined boot sequences.

16.2.8 Version menu

This menu contains system information which should be made available to Technical Support.

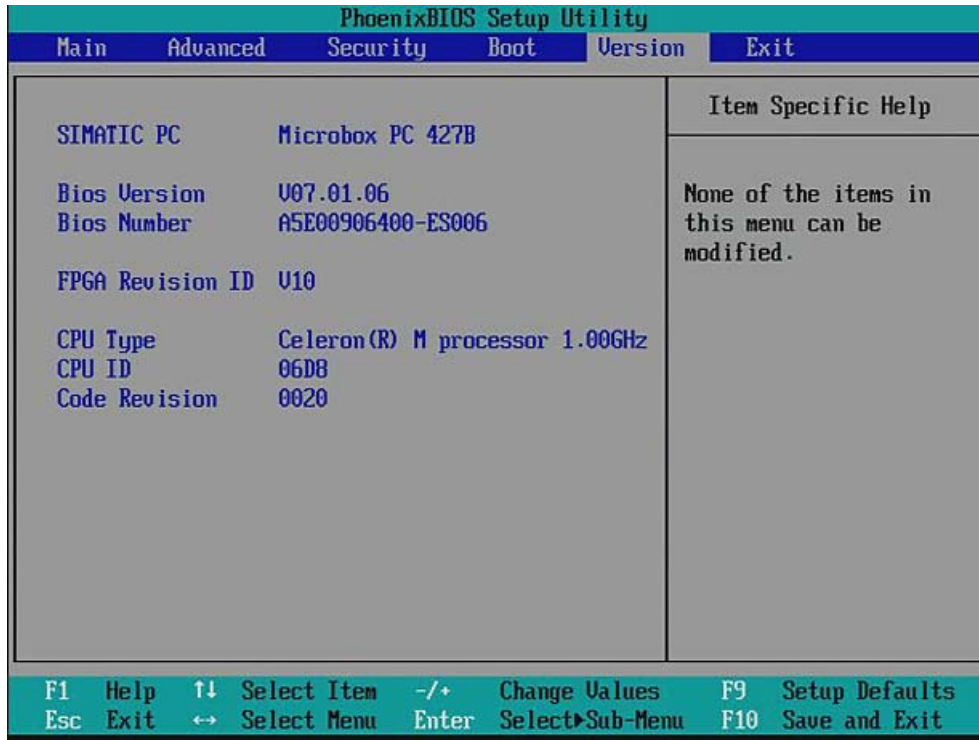

Figure 16-19 Version menu (example)

16.2.9 Exit Menu

You always exit BIOS Setup in this menu.

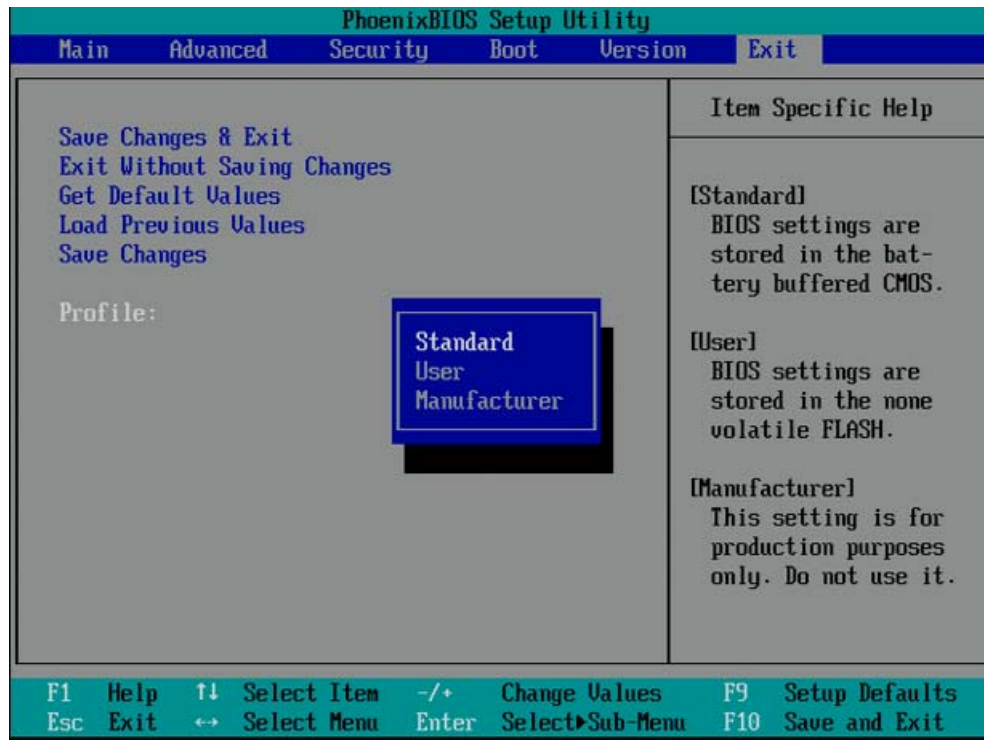

Figure 16-20 Exit menu

Save Changes & Exit	All changes are saved and the system is restarted with the new parameters.	
Exit Without Saving Changes	All changes are discarded and the system is restarted with the old parameters.	
Get Default Values	All parameters are set to safe values.	
Load Previous Values	The last saved values are reloaded.	
Save Changes	Save all Setup settings.	
Profiles	Standard	The BIOS settings are backed up to buffered CMOS
	User	The BIOS settings are saved in the non-volatile FLASH memory.
	Manufacturer	This setting is only used for production purposes. Do not use.

16.2.10 Default BIOS Setup entries

Documenting your device configuration

If you have changed any default settings in Setup, you can enter them in the following table. You can then refer to these entries for any future hardware modifications.

Note

Print out the table below and keep the pages in a safe place once you made your entries.

BIOS Setup default settings

System parameters	Defaults	Custom entries
Main		
System Time	hh:mm:ss	
System Date	MM/DD/YYYY	
IDE Channel 0 Master		
IDE Channel 0 Slave		
SATA Port 0		
SATA Port 1		
Memory Cache	Write Back	
Diagnostic screen	Enabled	

Boot options		
Quick Boot Mode	Enabled	
SETUP prompt	Enabled	
POST errors	All, but not keyboard	
Summary screen	Enabled	

Keyboard Features		
Numlock	On	
Keyboard auto-repeat rate	30/sec	
Keyboard auto-repeat delay	½ sec	

Hardware Options		
PCI - MPI / DP ¹⁾	Enabled	
Internal CAN ²⁾	Enabled	
CAN bus I/O address ²⁾	5400	
On-board Ethernet 1	Enabled	
Onboard Ethernet 1 Address	000E8Cxxxxxx	
On-board Ethernet 1 Remote Boot	Disabled	
Onboard Ethernet 2 ³⁾	Enabled	
Onboard Ethernet 2 Address ³⁾	000E8Cxxxxxx	

Hardware Options		
Onboard Ethernet 2 Remote Boot ³⁾	Disabled	
Onboard Profinet ⁴⁾	Enabled	
MAC address Layer 2 ⁴⁾	000E8Cxxxxxx	
MAC address Profinet ⁴⁾	000E8Cxxxxxx	
Dual view DVI/CRT	Disabled	
SRAM Memory Block	2 MB	

¹⁾ for versions with PROFIBUS only

²⁾ for versions with CAN bus only

³⁾ not with PROFINET versions

⁴⁾ for versions with PROFINET only

Advanced		
High Precision Event Timer	Disabled	
Installed O/S	Other	
Reset Configuration Data	No	
Legacy USB support	Enabled	
SafeCard functions	Enabled	

I/O Device Configuration		
Internal COM 1	Enabled	
Base I/O address	3F8	
Interrupt	IRQ 4	

PCI Configuration		
PCI Device Slot 1		
ROM scan option:	Enabled	
Enable Master	Enabled	
Latency timer	Default	
PCI Device Slot 2		
ROM scan option:	Enabled	
Enable Master	Enabled	
Latency timer	Default	
PCI Device Slot 3		
ROM scan option:	Enabled	
Enable Master	Enabled	
Latency timer	Default	
PCI Device Slot 4		
ROM scan option:	Enabled	
Enable Master	Enabled	
Latency timer	Default	

IRQ Resource Exclusion		
IRQ 3	Available	
IRQ 4	Available	
IRQ 5	Available	
IRQ 7	Available	
IRQ 9	Available	
IRQ 10	Available	

SATA/PATA Configuration		
PATA Controller:	Enabled	
SATA Controller mode	Enhanced	
AHCI Support	Disabled	

Security		
Supervisor Password Is	Disabled	
User password is	Disabled	
Set User Password	Enter	
Set Supervisor Password	Enter	
Password on boot	Disabled	
Fixed disk boot sector	Standard	

Boot		
Boot priority order:		
Excluded from boot order:		

Version		
SIMATIC PC	Microbox PC 427B	
BIOS Version	V07.01.xx	
BIOS Number	A5E00906400-ES0xx	
CPU Type	Celeron® M processor 1GHz	
CPU ID	06D8 or 06D6	
Code Revision	0020	

16.3 System resources

16.3.1 Currently allocated system resources

All system resources (hardware addresses, memory configuration, allocation of interrupts, DMA channels) are assigned dynamically by the Windows OS, depending on the hardware configuration, drivers and connected external devices. You can view the current configuration of system resources or possible conflicts with the following operating systems:

Windows XP Embedded	Start > Run : In the Open dialog, enter <i>msinfo32</i> and confirm with OK
Windows Vista	Start > Enter "cmd" in the search function, then enter "msinfo32" in the input box

16.3.2 System resources used by the BIOS/DOS

The following tables and pictures describe the system resources for the factory state of the device.

16.3.2.1 PCI Interrupt Lines

The interrupts are assigned to devices by BIOS. Exclusive non-shared interrupts are available for the first two PCI-104 or PC/104-*Plus* slots as well as for DP12 and the first Ethernet interface.

This means that applications or realtime operating system extensions can operate these devices exclusively and with high-performance without having to share the interrupt with other devices.

Table 16-1 Interrupt sharing in APIC mode

Interrupt		Interrupt type
IRQ0	System timer	ISA-exclusive
IRQ1	PS/2 keyboard controller emulation	ISA-exclusive
IRQ2	Interrupt controller 2	ISA-exclusive
IRQ3	Reserved for Com Port 2 (COM2)	Free or ISA-exclusive (COM2)
IRQ4	Com Port 1 (COM1)	ISA-exclusive
IRQ5	Free	Free
IRQ6	Reserved	Reserved
IRQ7	Free	Free
IRQ8	Realtime clock	ISA-exclusive
IRQ9	ACPI-SCI (system control interrupt)	ISA/PCI-shareable
IRQ10	CAN (optional) or free	ISA-exclusive (CAN) or free
IRQ11	Free	Free
IRQ12	PS/2 mouse controller emulation	ISA-exclusive
IRQ13	Coprocessor	ISA-exclusive
IRQ14	IDE controller 2 (enhanced mode) or IDE controller 1 (compatible mode)	ISA-exclusive
IRQ15	IDE controller 1 (compatible mode) or free (enhanced mode)	ISA-exclusive
IRQ16	Graphics, PCI Express Bridge	PCI-shared
IRQ17	LAN1-exclusive	PCI-exclusive
IRQ18	LAN2, IDE controller 1 (enhanced mode)	PCI-shared
IRQ19	DP12/MPI exclusive	PCI-exclusive
IRQ20	PCI104 slot 1 exclusive	PCI-exclusive
IRQ21	PCI104 slot 2 exclusive	PCI-exclusive
IRQ22	PCI104 slot 3, USB-UHCI controller (USB1.1)	PCI-shared
IRQ23	PCI104 slot 4, USB-EHCI controller (USB2.0)	PCI-shared

Table 16-2 Interrupt sharing in PIC mode

Interrupt		Interrupt type
IRQ0	System timer	ISA-exclusive
IRQ1	PS/2 keyboard controller emulation	ISA-exclusive
IRQ2	Interrupt controller 2 (cascade)	ISA-exclusive
IRQ3	Reserved for Com Port 2 (COM2)	Free or ISA exclusive (COM2)
IRQ4	Com Port 1 (COM1)	ISA-exclusive
IRQ5	LAN1-exclusive	PCI-exclusive
IRQ6	Reserved	Reserved
IRQ7	PCI104 slot 1/2	PCI / PCI-exclusive
IRQ8	Realtime clock	ISA-exclusive
IRQ9	ACPI-SCI (system control interrupt) or free (no ACPI Besy)	ISA/PCI-shareable or free
IRQ10	CAN (optional) or DP12/MPI (optional) or free	ISA-exclusive (CAN) / PCI-exclusive (DP12) or free
IRQ11	Graphics, PCI-Express Bridge, LAN2, IDE controller 1, USB-UHCI controller (USB1.1), USB-EHCI controller (USB2.0), PCI104 slot 3/4	PCI-shared
IRQ12	PS/2 mouse controller emulation	ISA-exclusive
IRQ13	Coprocessor	ISA-exclusive
IRQ14	IDE controller 2 (enhanced mode) or IDE controller 1 (compatible mode)	ISA-exclusive (compatible mode)
IRQ15	IDE controller 1 (compatible mode) or free (enhanced mode)	ISA-exclusive (compatible mode or PCI (enhanced mode)

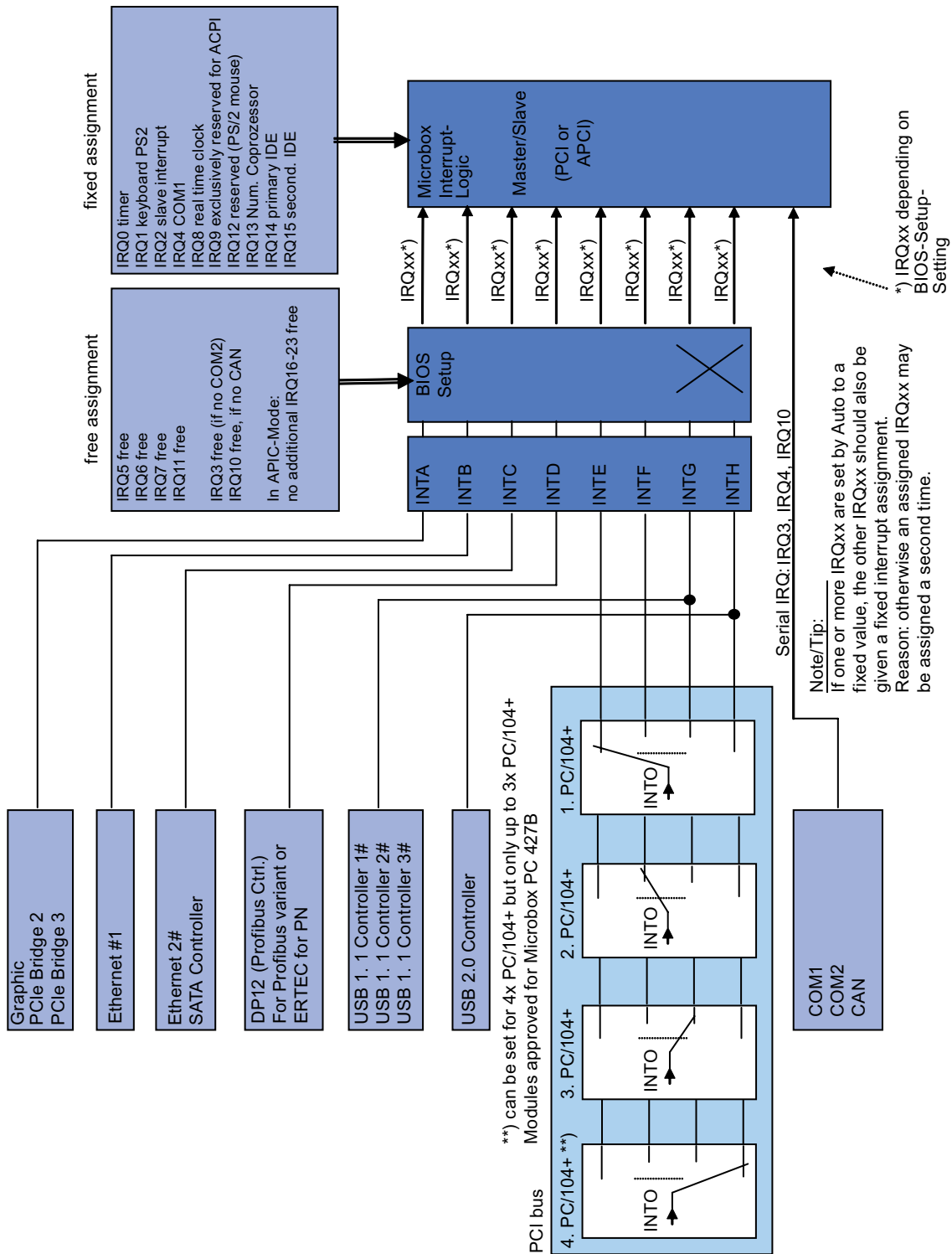

16.4 I/O address areas

16.4.1 Overview of the internal module registers

Overview of the internal module registers

The following addresses are used for the internal registers:

Addresses	Input/output unit
I/O 062h	Watchdog enable register / 066h select register
I/O 066h	Watchdog trigger register (Watchdog enable register bit 2=0)
	CAN base address register (Watchdog enable register bit 2=1)
I/O 404Eh - 404Fh	Output register LED 1/2 and SF LED / RUN/STOP LED
I/O 118Fh	Battery status register (read-only)

16.4.2 Watchdog enable register / 066h select register (read/write, address 062h)

Meaning of the bits

Watchdog enable register / 066h select register (r/w address 062h)								
Bit							Meaning of the bits	
7	6	5	4	3	2	1	0	
							Watchdog enable bit (WDE)	
							0	Watchdog circuit disabled
							1	Watchdog circuit enabled
							Watchdog Mode	
							0	Standard
							1	Macro
							066h select register selection	
							0	066h is Watchdog trigger register
							1	066h is CAN base address register
							Scaler watchdog time (Normal/Macro)	
		0	0	0				94 ms / 2 s (default)
		0	0	1				210 ms / 4 s
		0	1	0				340 ms / 6 s
		0	1	1				460 ms / 8 s
		1	0	0				590 ms / 16 s
		1	0	1				710 ms / 32 s
		1	1	0				840 ms / 48 s
		1	1	1				960 ms / 64 s
							Trigger red Watchdog LED	
	0							Red LED (WD) off
	1							Red LED (WD) on
							Watchdog error / Display and reset	
0								WD inactive
1								WD triggered Reset LED after watchdog alarm (Bit 7 = write 1)

See also

Watchdog (WD) (Page 50)

16.4.3 Watchdog trigger register (read only, address 066h)

Watchdog trigger register

The watchdog is triggered by a read action (address 066h) by this register. The result of the read access can be disregarded (i.e., dummy read).

16.4.4 CAN base address register (write only, address 066h)

A 512 byte window is created in the I/O area for the CAN controller (Philips SJA1000). The block itself only needs 32 or 128 bytes of this depending on the operating mode. The address window can be selected in 1024 byte steps between 4000h and 7C00h through the CAN base address register (write only, address 066h).

A limited selection can be preset in the BIOS Setup.

Note

The CAN base address register shares its I/O address with other registers. The watchdog enable register / 066h select register therefore must be selected before access.

Meaning of the bits

CAN base address register (write only, address 066h, Address register selection 1)								
Bit								Description
7	6	5	4	3	2	1	0	
						0	0	Reserved (Write: 00)
0	1							Reserved (Write:01)
		0	0	0	0			40h
	
	
		1	1	1	1			7Ch

16.4.5 Output register LED 1 / 2 (read/write, address 404Eh)

Meaning of the bits

Output register LED 1 / 2 (read/write address 404Eh)						
Bits						
15	14	13 - 8	7	6	5 - 0	
	1			1		LED L1 / SF dark (default)
	1			0		LED L1 / SF lights yellow
	0			1		LED L1 / SF lights red (= group fault)
1			1			LED L2 / R/S dark (default)
1			0			LED L2 / R/S lights yellow (= STOP)
0			1			LED L2 / R/S lights green (= RUN)
		xxxxxx			xxxxxx	Reserved (read/write)

Note

The L1 and L2 LEDs indicate by flashing alternatively yellow the progress of the BIOS self-test during the device startup. When the BIOS self-test is completed, the L1 and L2 LEDs go dark.

16.4.6 Battery status register (read-only, address 118Fh)

The status of the CMOS battery is monitored; the status (two-tier) can be read from the battery status register.

Meaning of the bits

Battery status register (read-only, address 118Fh)									
Bit									Description
7	6	5	4	3	2	1	0		
0	0								CMOS battery capacity is still sufficient.
1	0								CMOS battery capacity is exhausted (remaining capacity is sufficient for approx. one month)
1	1								CMOS battery is empty

16.4.7 SRAM address register

The battery-buffered SRAM uses a 2 MB memory address area, which can be read via the PCI register.

Meaning of the bits

SRAM address register		
PCI register address: SRAM base address register	PCI register content: SRAM memory address (default)	Length of the memory area
8006 2010h	DC20 0000h Address is assigned dynamically (depending on device)	20 0000h

16.5 CP 1616 onboard communications processor

16.5.1 Introduction

The CP 1616 onboard allows the connection of industrial PCs to Industrial Ethernet.

The basic characteristics of the PCS 1616 onboard are:

- Optimized for PROFINET IO
- With Ethernet realtime ASIC ERTEC 400
- Three RJ45 sockets for connecting terminal devices or addition network components
- Integrated 3-port real-time switch
- Automatic hardware detection

16.5.1.1 Network connections

Ethernet

The CP 1616 is designed for operation in Ethernet networks. Additional features are:

- The connectors are designed for 10BaseT and 100BaseTX.
- Data transfer rates of 10 and 100 Mbps in full/half duplex mode are supported.
- The handshake is performed automatically (auto negotiation).
- A 3-port realtime switch is located in the module.
- Autocrossing

Three RJ45 connectors

The CP 1616 is connected to the LAN (Local Area Network) via one of the three RJ45 sockets of the PC.

These three sockets lead to the integrated realtime switch.

16.5.1.2 Typical Communication Partners

CP 1616 onboard as an IO controller

The following diagram shows a typical application: CP 1616 onboard as PROFINET IO controller on the IO controller layer.

The IO base controller user program runs on the PC. This program accesses the functions of the IO base user program interface.

Data traffic is routed via the communication processor to several SIMATIC S7 PROFINET IO devices, ET 200S over Industrial Ethernet.

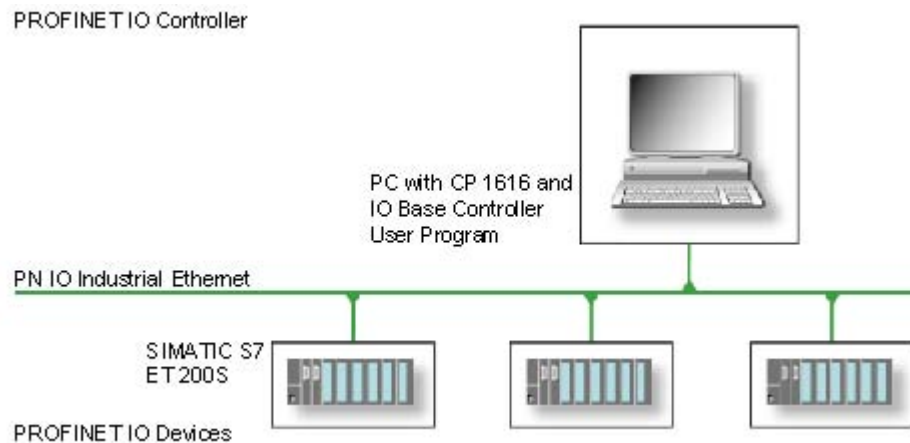

CP 1616 onboard as IO device

The following diagram shows a typical application: Two PCs each with a CP as a PROFINET IO device on the IO device layer.

A PC with a CP as PROFINET IO controller, a SIMATIC S7-400 with a CP 443-1 as PROFINET IO controller and two SIMATIC S7 ET 200S PROFINET IO devices are also connected in the network.

The IO base device user program runs on the IO device PC. This program accesses the functions of the IO base user program interface. Data traffic is routed via the CP 1616 onboard communication processor to a PC as PROFINET IO controller or an S7-400 automation system with CP 443-1 over Industrial Ethernet.

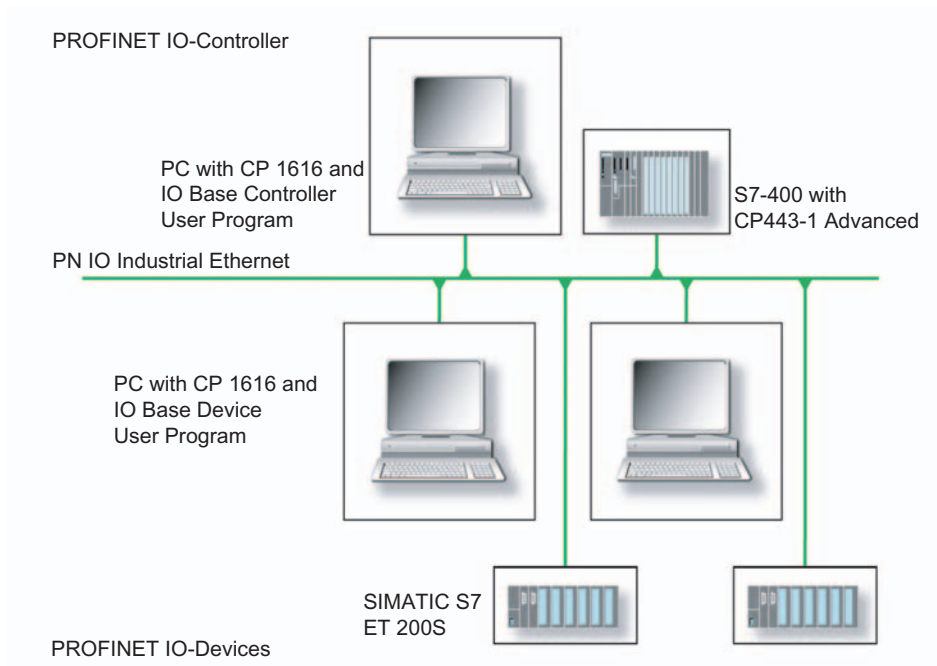

16.5.2 Firmware loader

Scenario for using the firmware loader

The CP 1616 onboard is supplied with the latest version of the firmware. If new functions become available due to product development, you can make them available by performing a firmware download.

Description

This section will familiarize you with the application area and use of the firmware loader. You can find additional, detailed information about the individual loader variants in the integrated help of the program.

Firmware

This refers to the system program in the SIMATIC NET modules.

Application area for the firmware loader

The firmware loader enables you to reload new firmware releases to SIMATIC NET modules. It is used for:

- PROFIBUS modules
- Industrial Ethernet modules
- Modules for gateways, for example IE/PB link

Installation

The firmware loader is available on your PG/PC under Windows following the installation of STEP 7/NCM PC.

Loader files

The firmware loader supports the following file types:

- <File>.FWL
A file format that contains information in addition to the LAD file format, which is displayed by the firmware loader. The firmware loader can use this information to check if the firmware is compatible to the device.
- <File>.LAD
A file format that only contains the system program to be loaded into the module.

Read the information provided along with the loader file, for example, in the readme file. This information is also displayed in the firmware loader when the FWL file is loaded.

16.5.2.1 Loading firmware

Start downloading procedure

1. In the Windows Start menu, select the menu command SIMATIC > STEP 7 > NCM S7 > Firmware Loader.

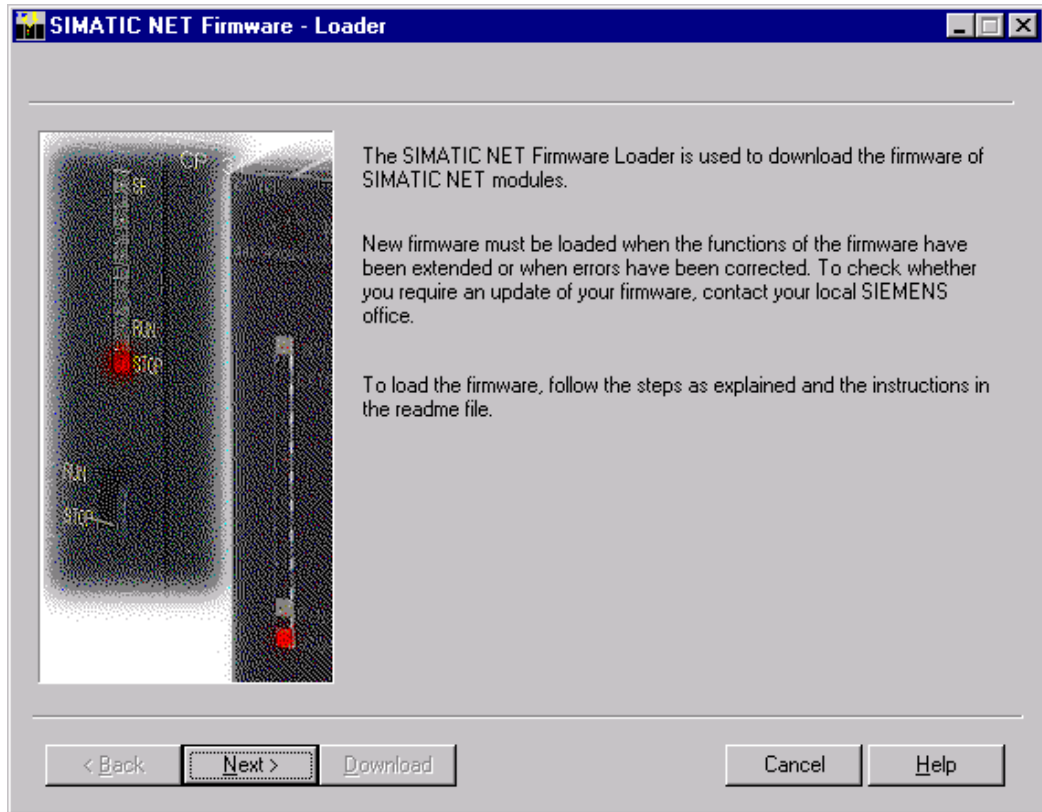

2. Click "Next" and follow the instructions in the dialog fields that follow. A help function is integrated in the software as support.

CAUTION

Ensure that the loader file you are using for the update is suitable for the version of firmware on your module. If you have any doubts, contact your local Siemens consultant.

CAUTION

Be aware that aborting the loading process may result in an inconsistent state in your module.

You can find additional, detailed information about the individual loader variants in the integrated help.

NOTICE

When loading the firmware or commissioning the module, be aware that the CP 1616 onboard takes five MAC addresses (always in direct sequence). The first two are shown in the BIOS.

PhoenixBIOS Setup Utility		
Main		
Hardware Options		Item Specific Help
Onboard Profinet:	[Enabled]	Enables or disables the CP 1616 onboard PROFINET-Interface.
MAC-Address Layer 2:	08000698A9A5	
MAC-Address PROFINET:	08000698A9A6	
Onboard Ethernet 1:	[Enabled]	
Onboard Ethernet 1 Address:	000E8C80A5A3	
Onboard Ethernet 1 Remote Boot:	[Disabled]	
Dual view DVI/CRT:	[Disabled]	
SRAM Memory Block:	[2 MB]	
F1 Help ↑↓ Select Item -/+ Change Values F9 Setup Defaults Esc Exit ↔ Select Menu Enter Select Sub-Menu F10 Save and Exit		

Example

The lowest address is for the layer 2 communication. The second is for Ethernet/PROFINET communication.

16.5.3 Further actions in STEP 7/NCM PC

Configuring

Your PC is now ready, although you still have to configure the SIMATIC NET communication software. The rest of the procedure is described in the "Commissioning PC Stations" manual (on the Windows PC that also contains STEP 7/NCM PC: Start > Simatic > Documentation > English > Commissioning PC Stations).

Appendix

A.1 Guidelines and declarations

Notes on the CE Label

CE The following applies to the SIMATIC product described in this documentation:

EMC Directive

The devices meet the requirements for the EC directive "2004/108/EEC Electromagnetic Compatibility," and the following fields of application applies according to this CE label:

Area of application	Requirement for	
	Emitted interference	Immunity to interferences
Residential area, business and trade areas and small businesses.	EN 61000-6-3: 2007	EN 61000-6-1: 2007
Industry	EN 61000-6-4: 2007	EN 61000-6-2: 2005

Declaration of conformity

The EC declaration of conformity and the corresponding documentation are made available to authorities in accordance with the EC directives stated above. Your sales representative can provide these on request.

Note the installation guidelines

The installation guidelines and safety instructions given in this documentation have to be noted during commissioning and operation.

Connecting peripherals

Noise immunity requirements to EN 61000-6-2 are met if connected peripherals are suitable for industrial applications. Peripheral devices are only be connected via shielded cables.

A.2 Certificates and approvals

DIN ISO 9001 certificate

The Siemens quality management system for all production processes (development, production and sales) meets DIN ISO 9001:2000 requirements.

This has been certified by DQS (the German society for the certification of quality management systems).

Q-Net certificate no.: DE-001108 QM

Software License Agreement

The device is shipped with preinstalled software. Please observe the respective license agreements.

Approvals for the USA, Canada and Australia

Product safety

The following approvals are available for the device:	
	Underwriters Laboratories (UL) according to Standard UL 60950-1, Report E11 5352 and Canadian National Standard CAN/CSA-C22.2 No. 60950-1 (I.T.E) or according to UL508 and Canadian National Standard CAN/CSA-C22.2 No. 142 (IND.CONT.EQ) or according to Canadian National Standard CAN/CSA-C22.2 No. 14-05

EMC

USA	
Federal Communications Commission Radio Frequency Interference Statement	This equipment has been tested and found to comply with the limits for a Class A digital device, pursuant to Part 15 of the FCC Rules. These limits are designed to provide reasonable protection against harmful interference when the equipment is operated in a commercial environment. This equipment generates, uses, and can radiate radio frequency energy and, if not installed and used in accordance with the instruction manual, may cause harmful interference to radio communications. Operation of this equipment in a residential area is likely to cause harmful interference in which case the user will be required to correct the interference at his own expense.
Shielded Cables	Shielded cables must be used with this equipment to maintain compliance with FCC regulations.
Modifications	Changes or modifications not expressly approved by the manufacturer could void the user's authority to operate the equipment.
Conditions of Operations	This device complies with Part 15 of the FCC Rules. Operation is subject to the following two conditions: (1) this device may not cause harmful interference, and (2) this device must accept any interference received, including interference that may cause undesired operation.

CANADA	
Canadian Notice	This Class A digital apparatus complies with Canadian ICES-003.
Avis Canadian	Cet appareil numérique de la classe B est conforme à la norme NMB-003 du Canada.

AUSTRALIA	
	This product meets the requirements of the AS/NZS CISPR 22.

A.3 Service and support

Local information

If you have questions about the products described in this document, you can find help at:
<http://www.siemens.com/automation/partner>

Technical documentation for SIMATIC products

Further documentation for SIMATIC products and systems can be found at:
<http://www.siemens.com/simatic-tech-doku-portal>

Easy Shopping at the Mall

Catalog & online ordering system <http://www.siemens.com/automation/mall>

Training

All the training options are listed at: <http://www.siemens.com/sitrain>
Find a contact at: Phone: +49(911) 895-3200

Technical support

Tel +49 180 5050 222
Fax +49 180 5050 223
<http://www.siemens.com/automation/csi/service>

A Web form for Support Request can be found at:
<http://www.siemens.com/automation/support-request>

When you contact the customer support, please have the following information for the technician on hand:

- BIOS version
- Order No. (MLFB) of the device
- Installed additional software
- Installed additional hardware

Online support

Information about the product, Support and Service, right through to the Technical Forum, can be found at: <http://www.siemens.com/automation/service&support>

After-sales information system for SIMATIC PC / PG

Information about contacts, drivers, and BIOS updates, FAQs and Customer Support can be found at: <http://www.siemens.com/asis>

ESD directives

B.1 ESD directives

Definition of ESD

All electronic modules are equipped with large-scale integrated ICs or components. Due to their design, these electronic elements are highly sensitive to overvoltage, and thus to any electrostatic discharge.

The electrostatic sensitive components/modules are commonly referred to as ESD devices. This is also the international abbreviation for such devices.

ESD modules are identified by the following symbol:



CAUTION

ESD devices can be destroyed by voltages well below the threshold of human perception. These static voltages develop when you touch a component or electrical connection of a device without having drained the static charges present on your body. The electrostatic discharge current may lead to latent failure of a module, that is, this damage may not be significant immediately, but in operation may cause malfunction.

Electrostatic charging

Anyone who is not connected to the electrical potential of their surroundings can be electrostatically charged.

The figure below shows the maximum electrostatic voltage which may build up on a person coming into contact with the materials indicated. These values correspond to IEC 801-2 specifications.

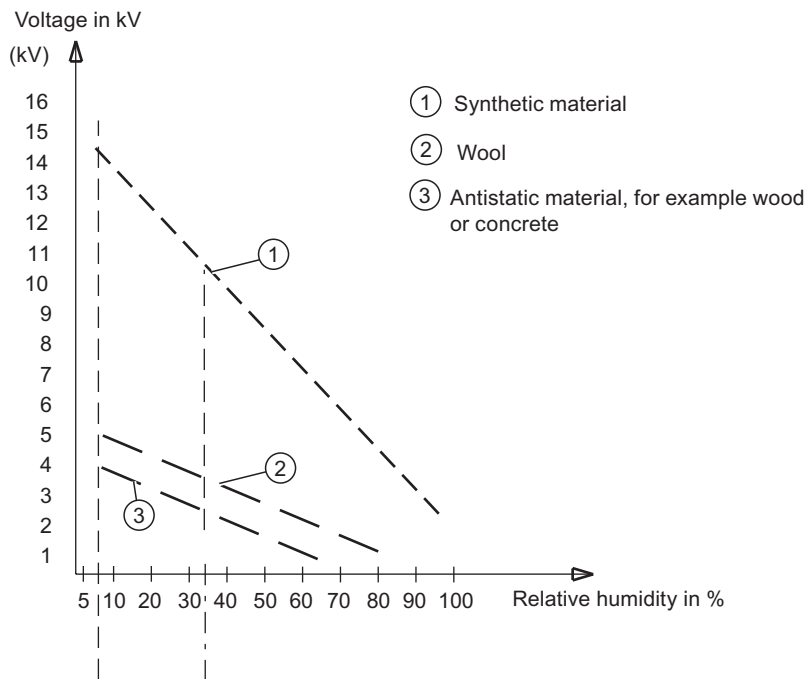

Figure B-1 Electrostatic voltages on an operator

Basic protective measures against electrostatic discharge

- Ensure good equipotential bonding:
When handling electrostatic sensitive devices, ensure that your body, the workplace and packaging are grounded. This prevents electrostatic charge.
- Avoid direct contact:
As a general rule, only touch electrostatic sensitive devices when this is unavoidable (e.g. during maintenance work). Handle the modules without touching any chip pins or PCB traces. In this way, the discharged energy can not affect the sensitive devices.

Discharge your body before you start taking any measurements on a module. Do so by touching grounded metallic parts. Always use grounded measuring instruments.

List of abbreviations/acronyms

C.1 Abbreviations

Abbreviation	Term	Meaning
AC	Alternating current	Alternating current
ACPI	Advanced Configuration and Power Interface	
PLC	Programmable controller	
AGP	Accelerated Graphics Port	High speed bus system
AHCI	Advanced Host Controller Interface	Standardized controller interface for SATA devices. This is supported in Microsoft Windows XP as of SP1 and IAA driver.
APIC	Advanced Programmable Interrupt Controller	Extended programmable interrupt controller
APM	Advanced Power Management	Tool for monitoring and reducing power consumption of the PC
AS	Automation system	
ASIS	After Sales Information System	
AT	Advanced Technology	
ATA	Advanced Technology Attachment	
ATX	AT-Bus-Extended	
AWG	American Wire Gauge	US standard for the cable diameter
BIOS	Basic Input Output System	Basic Input Output System
CAN	Controller Area Network	
CD-ROM	Compact Disc – Read Only Memory	Removable storage medium for large data volumes
CD-RW	Compact Disc – Rewritable	Rewritable CD
CE	Communauté Européenne (CE symbol)	The product is in conformance with all applicable EC directives
CF	Compact Flash	
CGA	Color Graphics Adapter	Standard monitor interface
CLK	Clock pulse	Clock signal for controllers
CMOS	Complementary Metal Oxide Semiconductors	Complementary metal oxide semiconductors
COA	Certificate of authentication	Microsoft Windows Product Key

List of abbreviations/acronyms

C.1 Abbreviations

Abbreviation	Term	Meaning
CoL	Certificate of License	License authorization
COM	Communications Port	Term for the serial interface
CP	Communication Processor	Communication computer
CPU	Central Processing Unit	CPU
CRT	Cathode Ray Tube	
CSA	Canadian Standards Association	Canadian organization for tests and certifications according to own or binational standards (with UL / USA) standards
CTS	Clear To Send	Clear to send
DRAM	Dynamic Random Access Memory	
DC	Direct Current	DC current
DCD	Data Carrier Detect	Data carrier signal detection
DMA	Direct Memory Access	Direct memory access
DOS	Disk Operating System	Operating system without GUI
DP	Distributed I/Os	
DQS	Deutsche Gesellschaft zur Zertifizierung von Qualitätsmanagement mBH	
DDRAM	Double Data Random Access Memory	Memory chip with high-speed interface
DSR	Data Set Ready	Ready for operation
DTR	Data Terminal Ready	Data terminal is ready
DVD	Digital Versatile Disk	Digital versatile disk
DVI	Digital Visual Interface	Digital display interface
DVI-I	Digital Visual Interface	Digital display interface with digital and VGA signals
ECC	Error Correction Code	Error correction code
ECP	Extended capability port	Extended parallel port
EGA	Enhanced Graphics Adapter	PC to monitor interface
ESD	Components sensitive to electrostatic charge	
EM	Electronic Manual	
EIDE	Enhanced Integrated Drive Electronics	An enhancement of the IDE standard
EISA	Extended Industry Standard Architecture	Extended ISA standard
EMM	Expanded Memory Manager	Manages memory expansions
EM64T	Extended Memory 64 technology	
EN	European standard	
EPROM / EEPROM	Erasable Programmable Read-Only Memory / Electrically Erasable Programmable Read-Only Memory	Plug-in submodules with EPROM/EEPROM chips
EPP	Enhanced Parallel Port	Bi-directional Centronics interface
ESC	Escape character	Control character
EWf	Enhanced Write Filter	
FAQ	Frequently Asked Questions	FAQs
FAT 32	File Allocation Table 32-bit	32-bit file allocation table
FD	Floppy disk	Disk drive, 3.5"

Abbreviation	Term	Meaning
FSB	Front Side Bus	
GND	Ground	Chassis ground
HD	Hard disk	Hard disk
HDA	High Definition Audio	
HDD	Hard Disk Drive	HDD
HU	Height unit	
HMI	Human Machine Interface	User interface
HT	Hyper-Threading	
HTML	Hyper Text Markup Language	Script language for creating Internet pages.
HTTP	Hypertext Transfer Protocol	Protocol for data transfer on the Internet
Hardware	Hardware	
I/O	Input/Output	Data input/output on computers
IAA	Intel Application Accelerator	
IDE	Integrated Device Electronics	
IEC	International Electrotechnical Commission	
IGD	Integrated Graphics Device	
IP	Ingress Protection	Degree of protection
IR	Infrared	Infrared
IRDA	Infrared Data Association	Standard for data transfer via IR module
IRQ	Interrupt Request	Interrupt request
ISA	Industry Standard Architecture	Bus for expansion modules
ITE	Information Technology Equipment	
L2C	Level 2 cache	
LAN	Local Area Network	Computer network that is limited to a local area.
LCD	Liquid Crystal Display	Liquid crystal display
LEDs	Light Emitting Diode	Light emitting diode
LPT	Line Printer	Printer port
LVDS	Low Voltage Differential Signaling	
LW	Drive	
MAC	Media access control	Media access control
MC	Memory Card	Memory card in credit card format
MLFB	Machine-readable product designation	
MMC	Micro Memory Card	Memory card of the format 32 mm x 24.5 mm
MPI	Multipoint-capable interface for programming devices	
MS-DOS	Microsoft Disc Operating System	
MTBF	Mean Time Between Failures	
MUI	Multilanguage User Interface	Language localization in Windows
NA	Not Applicable	

List of abbreviations/acronyms

C.1 Abbreviations

Abbreviation	Term	Meaning
NAMUR	Normenarbeitsgemeinschaft for Mess- und Regelungstechnik in der chemischen Industrie (standardization body for instrumentation and control technology in the chemicals industry)	
NC	Not Connected	Not connected
NCQ	Native Command Queuing	Automatic re-sorting of the file and disk access, for increased performance
NEMA	National Electrical Manufacturers Association	Syndicate of manufacturers of electrical components in the USA
NMI	Non Maskable Interrupt	Interrupt the processor can not reject
NTFS	New Techniques File System	Secure file system for Windows versions (2000, XP, Vista)
ODD	Optical Disk Drive	
OPC	OLE for Process Control	Standardized interface for industrial processes
PATA	Parallel ATA	
PC	Personal computer	
PCI	Peripheral Component Interconnect	High-speed expansion bus
PCIe	Peripheral Component Interconnect express	High-speed serial, differential full-duplex PtP interface with high data rate.
PCMCIA	Personal Computer Memory Card International Association	
PE	Protective Earth	Protective conductor
PEG	PCI Express Graphics	
PG	Programming device	
PIC	Programmable Interrupt Controller	Programmable interrupt controller
POST	Power On Self Test	
PXE	Preboot Execution Environment	Software for running new PCs without hard disk data via the network
RAID	Redundant Array of Independent Disks	Redundant hard disk array
RAL	Restricted Access Location	Installation of device in operating facilities with restricted access - for example, a locked switchgear cabinet
RAM	Random Access Memory	
RI	Ring Input	Incoming call
ROM	Read-Only Memory	
RS 485	Reconciliation Sublayer 485	Bi-directional bus system designed for up to 32 nodes
RTC	Real Time Clock	Real-time clock
RTS	Reliable Transfer Service	Request to send
RxD	Receive Data	Data transfer signal
SATA	Serial Advanced Technology Attachment	
SCSI	Small Computer System Interface	
SDRAM	Synchronous DRAM	
SELV	Safety Extra Low Voltage	Safety extra low voltage

Abbreviation	Term	Meaning
SLC	Second Level Cache	
SMART	Self Monitoring Analysis and Reporting Technology	Hard disk error diagnostics program
SMS	Short Message Service	Short message via telecommunication network
SNMP	Simple Network Management Protocol	Network protocol
SO-DIMM	Small Outline Dual Inline Memory Module	
SOM	SafeCard on Motherboard (SOM)	
SPP	Standard Parallel Port	Synonym for parallel port
SVGA	Super Video Graphics Array	Enhanced VGA standard with at least 256 colors
SVP	Serial number of the device	
SW	Software	
TCO	Total Cost of Ownership	
TFT	Thin-Film-Transistor	Type of LCD flat-screen
TTY	Tele Type	Asynchronous data transfer
TxD	Transmit Data	Data transfer signal
TWD	Watchdog Time	Watchdog monitoring time
UL	Underwriters Laboratories Inc.	US organization for tests and certifications according to own or binational standards (with CSA / Canada) standards
UMA	Unified Memory Architecture	Video memory
URL	Uniform Resource Locator	Designation of the full address of an Internet page
USB	Universal Serial Bus	
UXGA	Ultra Extended Graphics Array	Graphic standard, maximum resolution 1600x1200 pixels.
V.24		ITU-T standardized recommendation for data transfer via serial ports
VDE	Verein deutscher Elektrotechniker (Union of German Electrical Engineers)	
VGA	Video Graphics Array	Video adapter which meets industrial standard
VRM	Voltage Regulator Module	
VT	Virtualization Technology	Intel technology with which a virtually closed environment can be made available.
W2k	Windows 2000	
WAV	Wave Length Encoding	Loss-free file format for audio data
WD	Watchdog	Program monitoring with error detection and alarming.
WLAN	Wireless LAN	Wireless local area network
WoL	Wake on Local Area Network	
WWW	World Wide Web	
XGA	Extended Graphics Array	Graphic standard, maximum resolution 1024x768 pixels.

Glossary

AHCI mode

AHCI is a standardized method to address the SATA controller. AHCI describes a structure in the RAM, which contains a general area for control and status, as well as a command list.

APIC mode

Advanced peripheral interrupt controller. 24 interrupt lines are available.

ATAPI CD-ROM Drive

AT Bus Attachment Packet Interface (connected to AT bus) CD-ROM drive

Automation system (AS)

A programmable controller (PLC) of the SIMATIC S7 system consist of a central controller, one or several CPUs, and various I/O modules.

Backup

Duplicate of a program, data medium or database, used either for archiving purposes or for the protection of vital and non-replaceable data against loss when the working copy is corrupted. Certain applications automatically generate backup copies of data files, and manage both the current and the previous versions on the hard disk.

Baud

Physical unit for the step speed in signal transmission. Defines the number of transferred signal states per second. With only two states, one baud is equivalent to a transmission rate of 1 bps.

BEEP code

If the BIOS detects a boot error, it outputs an audible warning based on the current test result

Boot disk

A boot disk is a bootstrap disk with "Boot" sector. This can be used to load the operating system from the disk.

Booting

Start or restart of the computer. During booting the operating system is transferred from the system data medium to the work memory.

Cache

High-speed access buffer for interim storage (buffering) of requested data.

CE label

Communauté Européene The CE mark confirms compliance of the product with corresponding EC Directives, for example, with the EMC Directive.

Chipset

Located on the motherboard, connects the processor with the RAM, the graphics controller, the PCI bus, and the external interfaces.

Cold restart

A start sequence, starting when the computer is switched on. The system usually performs some basic hardware checks within the cold start sequence, and then loads the operating system from the hard disk to work memory -> boot

COM interface

The COM interface is a serial V.24 interface. The interface is suitable for asynchronous data transfer.

Compact Flash cards (CF)

Compact Flash is a digital storage medium in card format and without moving parts. The CF card contains the non-volatile memory and the controller. The interface of the CF card corresponds with the IDE interface. CF cards can be operated without additional electronics on PCMCIA or IDE hard disk controllers using a plug and socket adapter. There are two design forms: CF-I (42.6 x 36.4 x 3.3 mm) and CF-II (42.8 x 36.4 x 5 mm).

Configuration files

These are files containing data which define the configuration after restart. Examples of such files are CONFIG.SYS, AUTOEXEC.BAT and the registry files .

Configuration software

The configuration software updates the device configuration when new modules are installed . This is done either by copying the configuration files supplied with the module or by manual configuration using the configuration utility.

Controller

Integrated hardware and software controllers that control the functions of certain internal or peripheral devices (for example, the keyboard controller).

Device configuration

The configuration of a PC or programming device contains information on hardware and device options, such as memory configuration, drive types, monitor, network address, etc. The data are stored in a configuration file and enable the operating system to load the correct device drivers and configure the correct device parameters. . If changes are made to the hardware configuration, the user can change entries in the configuration file using the SETUP program. .

Disc-at-once

With this burning technique, data are written to a CD in a single session, and the CD is then closed. Further write access is then no longer possible.

Drivers

Program parts of the operating system. They adapt user program data to the specific formats required by I/O devices such as hard disk, printers, and monitors.

Dual Core CPU

Dual-core processors significantly increase the speed of computing and program execution compared to the previous generation of single-core processors with hyperthreading technology.

EMC directive

Directive concerning **Electromagnetic Compatibility**. Compliance is confirmed by the CE symbol and the EC certificate of conformity.

Energy management

The energy management functions of a modern PC allow individual control over the current consumption of vital computer components (e.g. of the monitor, hard disk and CPU), by restricting their activity based on the current system or component load. Energy management is of particular importance for mobile PCs.

Energy options

The energy options can be used to reduce energy consumption of the computer, while keeping it ready for immediate use. This can be configured in Windows by selecting Settings > Control Panel > Energy options.

Enhanced Write Filter (EWF)

Configurable write filter that allows you, for example, to boot Windows XP Embedded from write-protected media (such as CD-ROM), to write protect individual partitions and adapt the performance of the file system to your needs (when using Compact Flash cards).

ESD directive

Directive for using electrostatic sensitive components.

Ethernet

Local network (bus structure) for text and data communication with a transfer rate of 10/100/1000 Mbps.

Formatting

Basic partitioning of memory space on a magnetic data medium into tracks and segments. Formatting deletes all data on a data medium. All data media must be formatted prior to their first use.

Gender changer

Using the gender changer (25-pin / 25-pin), the COM1/V24/AG interface of the SIMATIC PC family can be converted to the usual 25-pin male connector.

Hard disk drives

Hard disks represent a form of magnetic disk storage medium (Winchester drives, hard disks) with integrated magnetic disks.

Hot swapping

The SATA interface gives the device's hard drive system hot-swap capability. Prerequisite for this configuration is a RAID1 system with SATA RAID controller (onboard, or slot module), and at least two SATA removable cartridges. The advantage of hot swapping is that defective hard disks can be replaced without having to reboot the computer.

Hub

A term in network technology. In a network, a device joining communication lines at a central location, providing a common connection to all devices on the network.

Hyper Threading

HT technology (multi-threading) enables the parallel computing of processes. HT is only effective when all relevant system components, such as processors, operating systems and applications are supported.

IGD

Integrated Graphics Device. Graphics interface integrated in the chipset.

Image

This refers to the image, for example, of hard disk partitions saved to a file in order to restore them when necessary.

Intel VT

The Intel Virtualization Technology (IVT) is the implementation of a secure closed environment for applications. Special (visualization) software on a VT-capable processor is required for its use.

Interface

See Interface

- Physical interconnection (cable) of hardware elements such as PLCs, PCs, programming devices, printers or monitors.
- Interface for interactive software applications.

Interface

See Interface

- Physical interconnection (cable) of hardware elements such as PLCs, PCs, programming devices, printers or monitors.
- Interface for interactive software applications.

Interface, multi-point

MPI is the programming interface of SIMATIC S7/M7. Allows remote access to programmable modules, text-based displays and OPs from central locations. The MPI nodes can intercommunicate.

LAN

Local Area Network: LAN is a local network that consists of a group of computers and other devices that are distributed across a relatively restricted range and are linked with communication cables. The devices connected to a LAN are called nodes. The purpose of networks is the mutual use of files, printers or other resources.

Legacy USB support

Support of USB devices (e.g. mouse, keyboard) on the USB ports without driver.

License key

The license key represents the electronic license stamp of a license. Siemens provides the license keys for protected software.

License key disk

The license key disk contains the authorizations or license keys required to enable protected SIMATIC software.

Low-voltage directive

EC Product Safety Directive relating to the safety of products which are operated on low voltage (50 VAC to 1000 VAC, 70 VDC to 1500 VDC) and not specified in other directives. Compliance is confirmed by the CE symbol and the EC certificate of conformity.

LPT interface

The LPT interface (Centronics interface) is a parallel interface that can be used to connect a printer.

Memory card

Memory cards in credit card format. Memory for user programs and parameters, for example, for programmable modules and CPs.

Module

Modules are plug-in units for PLCs, programming devices or PCs. They are available as local modules, expansion modules, interfaces or mass storage (Mass storage module).

Module retainer

The module retainer is used to fasten modules and ensure safe contact and transport. Shocks and vibrations especially affect large, heavy modules. It is therefore recommended to use the module retainer for this type of module. There are also short, compact and light modules on the market. The module retainer was not designed for these modules because the standard fastening is sufficient for them.

Motherboard

The motherboard is the core of the computer. Here, data are processed and stored, and interfaces and device I/Os are controlled and managed.

NEC Class 2

The "NEC", National Electrical Code, is the USA collection of regulations that generally correspond to German VDE 0100 standards. All USA standards governing the safety of electrical equipment and corresponding "deviations" in IEC standards are based on NEC in terms of their country-specific requirements.

NEC Class 2 specifies higher safety requirements for protection against electric shock and National Fire Protection Association (NFPA) requirements for fire protection. Power supplies operating within the range from 20 VDC to 30 VDC must be equipped with an internal current limiting circuit which safely prevents output power higher than 100 VA.

Operating system

Generic term which describes all functions for controlling and monitoring user program execution, distribution of system resources to the user programs and the operating mode in cooperation with the hardware (for example Windows XP Professional).

Packet writing

The CD-RW is used as a disk medium. The CD can then be read only by packet-writing compatible software or has to be finalized. Finalization of a CD closes the CD within an ISO9660 shell. You can still write to the CD-RW several times in spite of finalization. Not all CD drives can read packet-written CDs. There are restrictions to using this method in general data transfer.

PATA

Interface for hard disk drives and optical drives, with parallel data transmission rate up to 100 Mbps.

PC card

Trademark of the Personal Computer Memory Card International Association (PCMCIA). Designation for auxiliary cards that conform with PCMCIA specifications. A PC card that has roughly the size of a credit card can be plugged into a PCMCIA slot. Version 1 specifies cards of Type I with a thickness of 3.3 millimeters, which are designed mainly for use as external memory. Version 2 of the PCMCIA specification also defines cards of Type II with a thickness of 5 mm and cards of Type III with a thickness of 10.5 mm. Type II cards can realize devices such as modems, fax cards and network interface cards. Type III cards are equipped with devices that require more space, for example wireless communication modules, or rotary storage media such as hard disk drives, for example.

PC/104 / PC/104-Plus

Two bus architectures are especially fashionable today in the industrial world. PC/104 and PC/104-Plus. Both are standard in single-board computers of the PC class. The electrical and logical layout of the two bus systems is identical with ISA (PC/104) and PCI (PC/104-Plus). Software cannot usually detect a difference between them and normal desktop bus systems. Their advantage is the compact design and the resulting space they save.

PCMCIA

Association consisting of approx. 450 member companies of the computer industry whose focus is set on providing worldwide standards for miniaturization and flexible use of PC expansion cards in order to provide basic technologies to the market.

PEG interface

PCI Express for Graphics. Graphics interface with 16 PCIe lanes for expansions with graphics modules.

PIC mode

Peripheral interrupt controller. 15 interrupt lines are available.

Pixel

PixElement (picture point). The pixel represents the smallest element that can be reproduced on-screen or on a printer.

Plug&Play

Generally, a reference to the ability of a computer to automatically configure the system for communication with peripheral devices (for example monitors, modems or printers). The user can plug in a peripheral and "play" it at once without manually configuring the system. A Plug&Play PC requires both a BIOS that supports Plug&Play and a Plug&Play expansion card.

POST

Self-test performed by the BIOS after the computer is switched on. Performs a RAM test and a graphics controller test, for example. The system outputs audible signals (beep codes) if the BIOS detects any errors; the relevant message indicating cause of error is output on the screen.

PROFIBUS/MPI

Process Field Bus (standard bus system for process applications)

PROFINET

PROFINET is the name of the standard for Industrial Ethernet developed and maintained by the PROFIBUS user organization. PROFINET unites protocols and specifications with which Industrial Ethernet meets the requirements of industrial automation technology.

Programmable controller (PLC)

The programmable controllers (PLC) of the SIMATIC S5 system consist of a central controller, one or more CPUs, and various other modules (e.g. I/O modules).

PXE server

A **P**reboot **E**xecution **E**nvironment server is part of a network environment and can provide software to connected computers even before they boot. This can involve operating system installations or servicing tools, for example.

RAID

Redundant **A**rray of **I**ndependent **D**isks: Data storage system which is used to save data and the corresponding error correction codes (parity bits, for example) to at least two hard disk volumes in order to enhance reliability and performance. The hard disk array is controlled by management programs and a hard disk controller for error correction. The RAID system is usually implemented in network servers.

Recovery CD

Contains the tools for configuring hard disks and the Windows operating system.

Reset

Hardware reset: Reset/restart of the PC using a button/switch.

Restart

Warm restart of a computer without switching the power off (Ctrl + Alt + Del)

Restore DVD

The Restore DVD is used to restore the system partition or the entire hard disk to factory state if the system has crashed. The bootable DVD contains all the necessary image files. You can also create a boot disk allowing restoration via the network.

ROM

Read-Only Memory ROM is a read-only memory in which every memory location can be addressed individually. The programs or data are permanently stored and are not lost in the event of a power failure.

SCSI interface

Small Computer System Interface Interface for connecting SCSI devices such as hard disk drives or optical drives.

Session at once

In session at once, the CD can be written to both with an audio session and a data session. The two sessions are written to at once (as in disc at once).

SETUP (BIOS Setup)

A program in which information about the device configuration (that is the configuration of the hardware on the PC/PG) is defined. The device configuration of the PC/PG is preset with defaults. Changes must therefore be entered in the SETUP if a memory expansion, new modules or a new drive are added to the hardware configuration.

STEP 7

Programming software for the creation of user programs for SIMATIC S7 controllers.

Track-at-once

In track-at-once recording, a CD can be written to in bits in several sessions if the CD was not closed.

Troubleshooting

Error cause, cause analysis, remedy

V.24 interface

V.24 is a standardized interface for data transfer. Printers, modems, and other hardware modules can be connected to a V.24 interface.

Wake on LAN (WoL)

Wake on Local area network. This function enables the PC to be started via the LAN interface.

Warm restart

The restart of a computer after a program was aborted. The operating system is loaded and restarted again. The CTRL+ ALT+ DEL hotkey can be used to initiate a warm restart.

Windows

Microsoft Windows is a multitasking graphical user interface. Windows provides a standard graphical interface based on drop-down menus, windowed regions on the screen, and allows operation with a pointer device such as a mouse.

WLAN

Wireless LAN is a local network that transmits data via radio waves, infrared light or another wireless technology. Wireless LAN is mainly used for mobile computer applications in office or factory environments.

Index

2

24 V DC power supply
Connecting, 34

A

Abbreviations, 163, 168
Ambient and environmental conditions, 24

B

Battery, 10, 72
Battery change, 71
Battery monitoring, 54
BIOS Setup, 114
 Advanced Menu, 128
 Boot menu, 135
 Defaults, 138
 Exit menu, 137
 Main menu, 118
 Menu layout, 116
 Security menu, 134
 Version menu, 136
Blanking plate, 104
Boot options, 123
Boot sequence, 89
Buffer memory, 54

C

CAN
 Base address register, 147, 148, 149
CAN bus interface, 111
CAN interface, 46
CE label, 157
Certificates
 Certifications and approvals, 158
COA label, 23
Cold restart, 41
COM1 port, 107
Commissioning

 Other operating systems, 43
 Windows XP Embedded, 40
 Windows XP Professional, 41
Compact Flash
 Installing/removing a card, 65
Compact Flash card, 62
Compact Flash card interface, 112
Connecting
 24 V DC power supply, 34
 I/Os, 33
 Peripherals, 157
 Power supply, 33
Connection elements, 18
Coupling with SIMATIC S7, 46
Creating an image, 87

D

Data backup, 87
Date
 BIOS Setup, 119
DC power supply, 98
Declaration of conformity, 157
Degree of protection, 93
Delivery state, 39, 76
Design, external, 17
Device
 Mounting, 26
 opening, 56
 unpacking, 22
Device configuration, 138
DiagMonitor
 Temperature monitoring, 49
Diagnosis
 DiagMonitor, 49
 Error Messages, 89
 Safecard On Motherboard, 49
Diagnostics
 Troubleshooting, 91
Dimension drawings
 Blanking plate, 104
 Device with expansion frames, 103
 Device with mounting brackets, 101
Dimensions, 93
Directives

- ESD directives, 161
- Disk drives, 95
- Driver installation, 85
- DVI-I port, 108

E

- Electrostatic sensitive devices, 10, 161
- EMC, 158
- EMC Directive, 157
- Enhanced Write Filter, 52
- Equipotential bonding, 18, 35, 55, 68
- Error Messages
 - Troubleshooting, 91
- ESD directives, 10, 161
- Ethernet, 45
 - Interfaces, 18
- Ethernet address, 22
- Ethernet RJ45 port, 109
- EWf (Enhanced Write Filter), 52
- Expansion frame, 61
- Expansion slots, 95
- Extension
 - Modules, 60
- External ports, 107

F

- Factory state, 74
- FAQs, 91
- Field devices, 46

G

- General technical data, 93

H

- Hard disk, 95
- Hardware Options, 126

I

- I/Os, 33
- IDE Channel 0 Master, 119
- Identification data, 22
- Initial commissioning
 - Windows XP Embedded, 40
 - Windows XP Professional, 41
- Installing a memory module, 58

Interfaces

- Ethernet, 18, 45
- ETHERNET, 18
- PROFIBUS, 18, 45
- PROFIBUS/MPI, 45, 46
- Internal interfaces, 112
- IRQ Resource Exclusion, 132
- IT communication, 45

K

- Keyboard
 - Ports, 18
- Keyboard Features, 125

L

- Language selection, 76
 - Windows Vista, 82
 - Windows XP, 79
- License key, 73, 75
- Limitation of Liability, 67
- Lithium battery, 71

M

- Main memory, 95
- Memory Cache, 122
- Memory expansion options, 57
- Messages
 - On the screen, 89
- Microsoft Windows Product Key, 22
- Modules, 59
- Monitoring
 - Safecard On Motherboard, 51
 - Status displays, 20
- Motherboard
 - External ports, 107
 - Layout and function, 105
 - Technical features, 106
- Mounting
 - Bracket, 28
 - Device, 26
 - Modules, 60
- Mounting angle
 - Screw-mounting, 30
- Mounting brackets, 28
- Mounting instructions, 26
- Mounting positions, 26

O

- On-board Ethernet, 127
- Online ordering system, 46
- On-screen error messages, 89
- Open
 - Device, 56
- Operating system
 - Updates, 86
 - Windows Vista, 80
 - Windows XP Embedded, 73
 - Windows XP Professional, 76
- Order number, 22

P

- Partitioning
 - Compact Flash card, 83
 - Hard disk, 83
 - Windows XP Embedded, 83
 - Windows XP Professional, 84
- PCI cards, 59
- PCI configuration, 130
- PCI Devices, 131
- PCI interrupt lines, 144
- PCI-104 interface, 113
- PE terminal, 35
- Peripherals
 - Connecting, 157
- Port
 - USB, 109
- Ports, 18, 95
 - COM, 18
 - COM1, 107
 - Compact Flash card, 112
 - DVI/VGA, 18
 - DVI-I, 108
 - PCI -104, 113
 - RJ45 Ethernet, 109
 - USB, 18
- Power supply, 18, 19
 - Power requirements of the components, 97
- Power Supply
 - DC power supply, 98
- Processor, 95
- PROFIBUS, 45
- PROFIBUS/MPI, 45, 46

R

- Rating plate, 22
- Recovery

- Windows Vista, 80
- Recovery functions, 78
- Repairs, 9, 67, 68
- Replacing the hard disk, 69
- Reset button, 18
- Restore CD, 73, 75
- RJ45 Ethernet, 110

S

- Safecard On Motherboard, 51
- Safety instructions, 9
- SATA Port 0, 121
- SATA/PATA Configuration, 133
- Scope of application, 12
- Serial number, 22
- Setting up partitions, 77
- SIMATIC S7, 45
- SOFTNET S7, 45
- Software, 73
- SRAM, 54
- Startup, 54, 89
- Status displays, 20, 96
- Strain relief
 - Ethernet cable, 37
- Supply voltage, 93
- System Date, 119
- System partition, 73, 75
- System resources, 141
- System Time, 119

T

- Technical specifications, 93
- Temperature monitoring, 49, 51
- Third-party modules, 92
- Time
 - BIOS Setup, 119
- Tools, 68
- Transport, 21
- Trigger register
 - Watchdog, 147
- Troubleshooting/FAQs, 91

U

- Unpacking
 - Device, 22
- Updates
 - Operating system, 86
 - User programs and drives, 86

USB strain-relief, 36
User password, 134

V

Vent slots, 24

W

Warranty, 9
Watchdog, 50
 Monitoring function, 50
 Monitoring times, 50
 Trigger register, 147
Weight, 93
Windows Vista
 Recovery, 80
Windows Vista Ultimate, 80
Windows XP
 Language selection, 79
Windows XP Embedded
 Data backup, 87
 Driver installation, 85
 Initial commissioning, 40
 Partitioning the hard disk, 83
Windows XP Professional
 Data backup, 87
 Initial commissioning, 41
 Partitioning the hard disk, 84
 Reinstalling the operating system, 75