

NQ3-TQ0_B
NQ3-MQ0_B
NQ5-TQ0_B
NQ5-SQ0_B
NQ5-MQ0_B

NQ-Series HMI

INTRODUCTION MANUAL

OMRON

Notice

OMRON products are manufactured for use by a trained operator and only for the purposes described in this manual.

The following conventions are used to classify and explain the precautions in this manual. Always heed the information provided with them.

 **WARNING** Indicates information that, if not heeded, could possibly result in serious injury or loss of life.

 **Caution** Indicates information that, if not heeded, could possibly result in minor or relatively serious injury, damage to the product or faulty operation.

OMRON product references

In this manual the first letter of the name of each OMRON product is capitalized.

Visual aids

The following heading appears in the left column of the manual to help you locate different types of information.

Note Indicates information of particular interest for efficient and convenient operation of the product.

1,2,3... Indicates various lists such as procedures, checklists etc.

Trademarks and copyrights

All product names, company names, logos or other designations mentioned herein are trademarks of their respective owners.

Copyright

Copyright © 2009 OMRON

All rights reserved. No part of this publication may be reproduced, stored in a retrieval system, or transmitted, in any form, or by any means, mechanical, electronic, photocopying, recording, or otherwise, without the prior written permission of OMRON.

No patent liability is assumed with respect to the use of the information contained herein. Moreover, because OMRON is constantly striving to improve its high-quality products, the information contained in this manual is subject to change without notice. Every precaution has been taken in the preparation of this manual. Nevertheless, OMRON assumes no responsibility for errors or omissions. Neither is any liability assumed for damages resulting from the use of the information contained in this publication.

TABLE OF CONTENT

SECTION 1

Precautions

v

1-1 Intended audience	vi
1-2 General precautions	vi
1-3 Safety precautions	vii
1-4 Operating environment precautions	viii
1-5 Application precautions	ix
1-6 Handling, storage and disposal	xi
1-7 Conformance to EC Directives	xi

SECTION 2

Introduction

1

2-1 About this manual	2
2-2 NQ-Series models	2
2-3 Specifications for all models	3
2-4 Specifications per model	5

SECTION 3

Installation and wiring

7

3-1 Installation notes	8
3-2 Mounting	9
3-3 Wiring	12
3-4 Multi-drop networks	16

SECTION 4

Creating applications

19

4-1 Preparing for programming	20
4-2 Using NQ-Designer	24
4-3 Example application	39
4-4 Printing from NQ-Series	53
4-5 Model conversion in NQ-Designer	54
4-6 Connecting NQ-Series to OMRON products	57

SECTION 5

Transferring programs

71

5-1 Downloading	72
5-2 Uploading	74
5-3 USB host functionality	76

SECTION 6

Simulation and debugging

81

6-1 Simulation	82
6-2 Debugging	82

TABLE OF CONTENT

SECTION 7**Maintenance 83**

7-1 Erasing keys	84
7-2 Touch screen calibration	85
7-3 Troubleshooting	86
7-4 NQ-Series diagnostics	87

Appendix A 93

A-1 OMRON communication cables.....	93
A-2 Non-Omron devices to NQ-Series configurations.....	99
A-3 Non-Omron devices communication cables	128

Revision history 138

SECTION 1

Precautions

This section provides general precautions for using the NQ-Series Operator Interfaces (OIs), Programmable Logic Controllers (PLCs) and related devices.

The information contained in this section is important for the safe and reliable operation of the NQ-Series terminal. You must read this section and understand the information contained before attempting to set up or operate an NQ-Series terminal.

1-1	Intended audience.....	vi
1-2	General precautions.....	vi
1-3	Safety precautions.....	vii
1-4	Operating environment precautions.....	viii
1-5	Application precautions.....	ix
1-6	Handling, storage and disposal.....	xi
1-7	Conformance to EC Directives.....	xi

1-1 Intended audience

This manual is intended for the following personnel, who must also have knowledge of electrical systems (an electrical engineer or the equivalent).

- Personnel in charge of installing FA systems.
- Personnel in charge of designing FA systems.
- Personnel in charge of managing FA systems and facilities.

1-2 General precautions

The user must operate the product according to the performance specifications described in the operation manual.











Before using the product under conditions which are not described in the manual or applying the product to nuclear control systems, railroad systems, aviation systems, vehicles, combustion systems, medical equipment, amusement machines, safety equipment, and other systems, machines, and equipment that may have a serious influence on lives and property if used improperly, consult your OMRON representative.

Make sure that the ratings and performance characteristics of the product are sufficient for the systems, machines, and equipment, and be sure to provide the systems, machines, and equipment with double safety mechanisms.

This manual provides information for installing and operating the OMRON NQ-Series HMI (referred to as "HMI"). Be sure to read this manual before attempting to use the HMI and keep this manual close at hand for reference during operation.

- The HMI is a general purpose product. It is a system component and is used in conjunction with other items of industrial equipment such as PLC's, Loop Controllers, Adjustable Speed Drives, etc.
- A detailed system analysis and job safety analysis should be performed by the system designer or system integrator before including the HMI unit in any new or existing system. Consult your OMRON representative for options availability and for application specific system integration information if required.
- The product may be used to control an adjustable speed drive connected to high voltage sources and rotating machinery that is inherently dangerous if not operated safely. Interlock all energy sources, hazardous locations, and guards in order to restrict the exposure of personnel to hazards. The adjustable speed drive may start the motor without warning. Signs on the equipment installation must be posted to this effect. A familiarity with auto-restart settings is a requirement when controlling adjustable speed drives. Failure of external or ancillary components may cause intermittent system operation, i.e., the system may start the motor without warning or may not stop on command. Improperly designed or improperly installed system interlocks and permissives may render a motor unable to start or stop on command.

1-3 Safety precautions

-  **WARNING** Do not attempt to take any HMI apart or touch any internal parts while the power is being supplied. Doing so may result in electric shock.
-  **WARNING** Do not attempt to disassemble, repair, or modify any HMI. Any attempt to do so may result in malfunction, fire, or electric shock.
-  **WARNING** Provide safety measures in external circuits, i.e., not in the HMI, in order to ensure safety in the system if an abnormality occurs due to malfunction of the HMI or another external factor affecting the HMI operation. Not doing so may result in serious accidents.
- Emergency stop circuits, interlock circuits, limit circuits, and similar safety measures must be provided in external control circuits.
-  **WARNING** Never short-circuit the positive and negative terminals of the batteries, charge the batteries, disassemble them, deform them by applying pressure, or throw them into a fire. The batteries may explode, combust or leak liquid.
-  **WARNING** Fail-safe measures must be taken by the customer to ensure safety in the event of incorrect, missing, or abnormal signals caused by broken signal lines, momentary power interruptions, or other causes. Not doing so may result in serious accidents.
-  **WARNING** The HMI will turn OFF when its self-diagnosis function detects any error. As a countermeasure for such errors, external safety measures must be provided to ensure safety in the system.
-  **WARNING** Do not touch any of the terminals or terminal blocks while the power is being supplied. Doing so may result in electric shock.
-  **Caution** Pay careful attention to the polarities (+/-) when wiring the DC power supply. A wrong connection may cause malfunction of the system.
-  **Caution** Confirm safety at the destination HMI before transferring a program or settings to another HMI. Doing this without confirming safety may result in injury.
-  **Caution** Tighten the screws on the terminal block of the Power Supply connector to the torque specified in the operation manual. The loose screws may result in burning or malfunction.

1-4 Operating environment precautions

 **Caution** Do not operate the control system in the following locations. Doing so may result in malfunction, electric shock or burning:

- Locations subject to direct sunlight.
- Locations subject to temperatures or humidities outside the range specified in the specifications.
- Locations subject to condensation as the result of severe changes in temperature.
- Locations subject to corrosive or flammable gases.
- Locations subject to dust (especially iron dust) or salts.
- Locations subject to exposure to water, oil, or chemicals.
- Locations subject to shock or vibration.

 **Caution** Take appropriate and sufficient countermeasures when installing systems in the following locations. Doing so may result in malfunction:

- Locations subject to static electricity or other forms of electric noise.
- Locations subject to strong electromagnetic fields.
- Locations subject to possible exposure to radioactivity.
- Locations close to power supplies.

 **Caution** The operating environment of the HMI System can have a large effect on the longevity and reliability of the system. Improper operating environments can lead to malfunction, failure and other unforeseeable problems with the system. Make sure that the operating environment is within the specified conditions at installation and remains within the specified conditions during the life of the system. Follow all installation instructions and precautions provided in this operation manual.

1-5 Application precautions

 **WARNING** Failure to abide by the following precautions could lead to serious or possibly fatal injury. Always read these precautions.

- Always connect to a ground of 100 Ohm or less when installing the HMI. Not doing so may result in electric shock. Always connect to a ground of 100 Ohm or less when short-circuiting the functional ground and line ground terminals of the Power Supply Unit, in particular.
- Always turn OFF the power supply to the HMI before attempting any of the following. Not turning OFF the power supply may result in malfunction or electric shock.
 - Mounting or dismounting Power Supply units and Control Units
 - Assembling option boards on HMI
 - Replace the battery
 - Setting switches
 - Connecting or wiring the cables
 - Connecting or disconnecting the connectors
- Check the user program for proper execution before actually running it on the HMI. Not checking the program may result in an unexpected operation.

 **Caution** Failure to abide by the following precautions could lead to faulty operation of the HMI or the system, or could damage the HMI. Always read these precautions.

- Install external breakers and take other safety measures against short-circuiting in external wiring. Not observing this may result in burning.
- Be sure that all the terminal screws and cable connector screws are tightened to the torque specified in the relevant manuals. Incorrect tightening torque may result in malfunction.
- Mount the HMI only after checking the connectors and terminal blocks completely.
- Before touching the HMI, be sure to first touch a grounded metallic object in order to discharge any static built-up. Not doing so may result in malfunction or damage.
- Be sure that the terminal blocks, connectors, and other items with locking devices are properly locked into place. Improper locking may result in malfunction.
- Wire correctly according to the specified procedures.
- Always use the power supply voltage specified in the operation manuals. An incorrect voltage may result in malfunction or burning.
- Do not connect an AC power supply to the NQ-series HMI power terminals, an incorrect power supply may result in burning.
- Take appropriate measures to ensure that the specified power with the rated voltage and frequency is supplied. Be particularly careful in places where the power supply is unstable. An incorrect power supply may result in malfunction.
- Use crimp terminals for wiring. Do not connect bare stranded wires directly to terminals. Connection of bare stranded wires may result in burning.
- Disconnect the functional ground terminal when performing withstand voltage tests. Not disconnecting the functional ground terminal may result in burning.
- Wire correctly and double-check all the wiring or the setting switches before turning ON the power supply. Incorrect wiring may result in burning.
- Check that the switches and settings are properly set before starting operation.

- Resume operation only after transferring to the new HMI the contents of the all settings, programs, parameters, and data required for resuming operation. Not doing so may result in an unexpected operation.
- Do not pull on the cables or bend the cables beyond their natural limit. Doing either of these may break the cables.
- Do not place objects on top of the cables. Doing so may break the cables.
- Use the dedicated connecting cables specified in operation manuals to connect the HMI. Using commercially available RS-232C computer cables may cause failures in external devices or the NQ-series HMI.
- When replacing parts, be sure to confirm that the rating of a new part is correct. Not doing so may result in malfunction or burning.
- When transporting or storing the product, cover the PCBs with electrically conductive materials to prevent LSIs and ICs from being damaged by static electricity, and also keep the product within the specified storage temperature range.
- Do not touch the mounted parts or the rear surface of PCBs because PCBs have sharp edges such as electrical leads.
- Make sure that parameters are set correctly. Incorrect parameter settings may result in unexpected operations. Make sure that equipment will not be adversely affected by the parameter settings before starting or stopping the HMI.
- Do not press the touch switch with a sharp pointer or pencil, doing so may result in malfunction or damage.
- Do not press the touch switch with a force greater than 30N, doing so may result in malfunction or damage.
- Always following the specified procedure when removing the USB-stick. Removing the USB-stick while it is being accessed may render the USB-stick unusable.
- Please make sure to have a backup of the data already present on the USB-stick before connecting it with NQ-series HMI. Not doing so may result in lost of data.
- Do not let metal particles enter the HMI when preparing the panel.
- Do not use benzene, paint thinner, or other volatile solvents and do not use chemically treated cloths.
- Carefully unpack the equipment and check for parts that were damaged from shipping, missing parts, or concealed damage. If any discrepancies are discovered, it should be noted with the carrier prior to accepting the shipment, if possible. File a claim with the carrier if necessary and immediately notify your OMRON representative.
- Do not install or energize equipment that has been damaged. Damaged equipment may fail during operation resulting in further equipment damage or personal injury.

1-6 Handling, storage and disposal

- Use proper lifting techniques when moving the HMI; including properly sizing up the load, and getting assistance if required.
- Store in a well-ventilated covered location and preferably in the original packaging if the HMI will not be used upon receipt.
- Store in a cool, clean, and dry location. Avoid storage locations with extreme temperatures, rapid temperature changes, high humidity, moisture, dust, corrosive gases, or metal particles.

- Do not store the HMI in places that are exposed to outside weather conditions (i.e., wind, rain, snow, etc.).
- Never dispose electrical components via incineration. Contact your state environmental agency for details on disposal of electrical components, batteries and packaging in your area.

1-7 Conformance to EC Directives

1-7-1 Applicable directives

- EMC (ElectroMagnetic Compatibility) Directives
- Low-voltage directive

1-7-2 Concepts

OMRON units complying with EC Directives also conform to related product standards making them easier to incorporate in other units or machines. The actual products have been checked for conformity to product standards. Whether the products conform to the standards in the system used by the customer, however, must be checked by the customer.

Product related performance of OMRON units complying with EC Directives will vary depending on the configuration, wiring, and other conditions of the equipment or control panel in which OMRON devices are installed. The customer must, therefore, perform final checks to confirm that units and the overall system conforms to product standards.

A Declaration of Conformity for the NQ-Series can be requested at your nearest OMRON representative.

1-7-3 Conformance to EC Directives

NQ-Series should be installed as follows, for the complete configuration to meet the EC directives:

- 1 The units are designed for installation in panels. All units must be installed in control panels.
- 2 Use reinforced insulation or double insulation for the DC power supplies used for the communication power supply, internal circuit power supply, and the I/O power supplies.
- 3 The NQ-Series meets the generic emission standard. However as EMC performance can vary in the final installation, additional measures may be required to meet the standards. It should therefore be verified that the overall machine or device also meets the relevant standards. You must therefore confirm that EC directives are met for the overall machine or device, particularly for the radiated emission requirement (10 m).
- 4 This is a class A product. It may cause radio interference in residential areas, in which case the user may be required to take adequate measures to reduce interference.

SECTION 2

Introduction

This section introduces the NQ-Series models and the specifications of the models.

2-1 About this manual.....	2
2-2 NQ-Series models.....	2
2-3 Specifications for all models.....	3
2-4 Specifications per model.....	5

2-1 About this manual

This manual describes the installation and operation of the NQ-Series. The NQ-Series products are versatile Human Machine Interfaces (HMI) .

Please read this manual carefully and be sure to understand the information provided before installing or operating the NQ-Series.

The program provided in this manual is given strictly as an example. When implementing an actual system, check the specifications, performance and safety instructions.

2-2 NQ-Series models

The NQ-Series are Human Machine Interfaces (HMIs) in three different display sizes and two orientation models. Models included in the NQ-Series are shown in Table 2.1: NQ-Series models. All models need +24 V_{DC} power from an external power supply.

Table 2.1: NQ-Series models

Model	Description	Orientation
NQ5-TQ010B	5.7 inch TFT Colour, Ethernet	Landscape
NQ5-SQ000B	5.7 inch STN Colour	Landscape
NQ5-SQ001B	5.7 inch STN Colour	Portrait
NQ5-MQ000B	5.7 inch Monochrome STN blue mode	Landscape
NQ5-MQ001B	5.7 inch Monochrome STN blue mode	Portrait
NQ3-TQ010B	3.5 inch TFT Colour, Ethernet	Landscape
NQ3-TQ000B	3.5 inch TFT Colour	Landscape
NQ3-MQ000B	3.8 inch Monochrome FSTN Black / white mode	Landscape

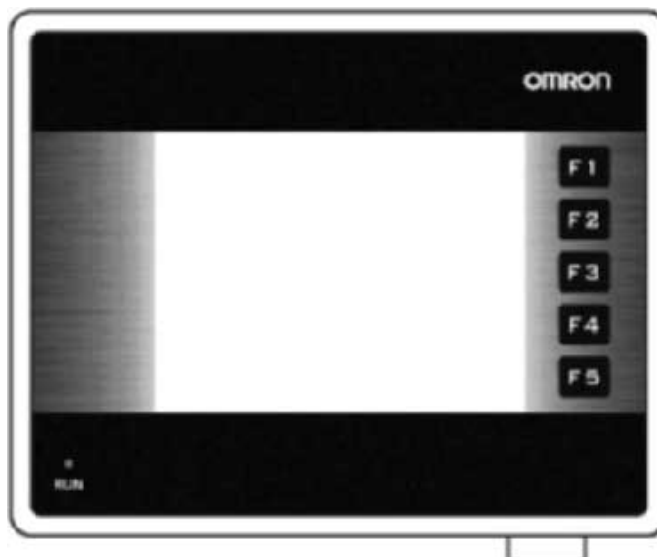

Figure 2.1: Front view of a NQ-Series with 5 function keys

2-3 Specifications for all models

Table 2.2: Common specifications for NQ-Series

Power supply		
	Input voltage	24 V _{DC}
	Tolerance on input voltage	+/- 15%
Display		
	Resolution (H * V) landscape models	320 * 240 pixels
	Resolution (H * V) portrait models	240 * 320 pixels
	Backlight life	Min. 50000 hours at 25°C
	Backlight saver	Yes
	Backlight dimming (NQ3)	Using touch screen / Function Keys
Touch screen		
	Type	4-wire analogue resistive
	Light transparency	Min. 80%
	Life	Min. 5 million touches
Number of LEDs		1
Communication interfaces		
	RS-232/422/485	Yes
	USB device	Yes
	USB host	Yes
Processor		32-bit RISC (ARM)
Real-Time Clock (RTC)		Yes (date and time)
Memory		
	Data register	1000
	Retentive register	1400
	Internal coil	5000
	Internal register	313
Battery		
	Type	3 V coin battery, with holder
	Battery back-up	Min. 5 years for RTC
Mounting		
	Method	Panel mounting
	Enclosure rating	Front panel: IP65

Environment		
	Ambient operating temperature	0 °C to 50 °C
	Operating environment	No corrosive gasses
	Storage temperature	-20 °C to 60 °C
	Humidity	10% to 90% ¹ relative humidity (Noncondensing) 10% to 85% ² relative humidity (Noncondensing)
	Noise immunity	Conforms to IEC61000-4-4, 2 KV (power lines)
	Vibration resistance (during operation)	5 to 8.4 Hz with 3.5 mm single amplitude and 8.4 to 150 HZ with 9.8 m/s ² acceleration 10 times in each of X, Y and Z directions
	Shock resistance (during operation)	147 m/s ² 3 times in each of X, Y and Z directions
International standards		
	Directives	CE, cULus, Lloyds

1. At 25 °C ambient temperature.
2. 85% at 40 °C ambient temperature. Above 40 °C the equivalent absolute humidity is less than 85%.

2-4 Specifications per model

Table 2.3: Specifications per NQ-Series model

Model	NQ5- MQ000B/ NQ5- MQ001B	NQ5- SQ000B/ NQ5- SQ001B	NQ5- TQ010B	NQ3- TQ000B	NQ3- TQ010B	NQ3- MQ000B
Display						
Display size	5.7 inch	5.7 inch	5.7 inch	3.5 inch	3.5 inch	3.8 inch
Display type	STN	STN	TFT	TFT	TFT	STN
Monochrome/colour	Mono	Colour	Colour	Colour	Colour	Mono
Colours supported	16 gradations	256 colours ¹	256 colours ²	256 colours ²	256 colours ²	4 gradations
Brightness (Cd/m ²)	Min. 200	Min. 200	Min. 200	Min. 200	Min. 200	Min. 160
Contrast ratio	4	55	350	300	300	3
Contrast adjustment using touch screen	Yes	Yes	No	No	No	Yes
Backlight types	CCFL	CCFL	LED	LED	LED	LED
Touch screen size	5.7 inch	5.7 inch	5.7 inch	3.5 inch	3.5 inch	3.8 inch
Function keys	6	6	6	5	5	5
Memory						
Total (MB)	8	8	8	8	8	4
Program (MB)	6.7	6.7	6.7	6.7	6.7	2.6
Communication interfaces						
RS-232/485/422 port (Com 1)	Yes	Yes	Yes	Yes	Yes	Yes
RS-232 port (Com 2)	Yes	Yes	Yes	No	No	No
Ethernet port	No	No	Yes	No	Yes	No
Power rating (W)	10	10	10	10	10	10
Weight	0.7 kg max.	0.7 kg max.	0.7 kg max.	0.3 kg max.	0.3 kg max.	0.3 kg max.
External dimensions						
Width * Height (mm)	195 * 142	195 * 142	195 * 142	128 * 102	128 * 102	128 * 102
Thickness (mm)	50	50	50	44.5	44.5	44.5

1. 4096 colours for bitmaps
2. 32000 colours for bitmaps

SECTION 3 Installation and wiring

This section describes how to install the NQ-Series and how to wire the HMI.

- 3-1 Installation notes 8
- 3-2 Mounting..... 9
- 3-3 Wiring 12
- 3-4 Multi-drop networks 16

3-1 Installation notes

For improved reliability and maximized functionality, take the following information into consideration when installing a NQ-Series HMI.

3-1-1 Location

Do not install the NQ-Series in the following locations:

- Areas subject to explosion hazards due to flammable gasses, vapours and dusts.
- Areas subject to dramatic temperature changes. Temperature changes can cause condensation of water in the device.
- Areas with an ambient temperature lower than 0 °C or higher than 50 °C.
- Areas subject to shock or vibration.

3-1-2 Temperature control

- Provide adequate space for air flow.
- Do not install the NQ-Series above equipment that generates significant heat.
- If the ambient temperature exceeds 50 °C, install a cooling fan or air conditioner.

3-1-3 Accessibility

- For safety during operation and maintenance, mount the NQ-Series as far as possible from high-voltage equipment and power machinery.

3-1-4 Panel cut-out

Before the NQ-Series can be mounted, a rectangular cut-out must be made in the panel in which the NQ-Series will be mounted. Table 3.1: Dimensions of NQ-Series and required panel cut-out shows the dimensions and tolerances of the NQ-Series, the panel and the required cut-out.

Table 3.1: Dimensions of NQ-Series and required panel cut-out

		NQ5-	NQ3-
Display size		5.7 inch	3.5 inch and 3.8 inch
External dimensions:	W _{ext}	195 mm	128 mm
	H _{ext}	142 mm	102 mm
Panel cut-out:	W _{cut-out}	184.00 mm	119.00 mm
	H _{cut-out}	131.00 mm	93.00 mm
Panel cut-out tolerance		+0.50 mm	+0.50 mm
Panel thickness		Max. 6.0 mm	Max. 6.0 mm

Above external dimensions and cut-outs are for landscape models. For portrait models exchange the W and H sizes. For portrait models the cables will be mounted to the left side of the NQ-Series (view from front).

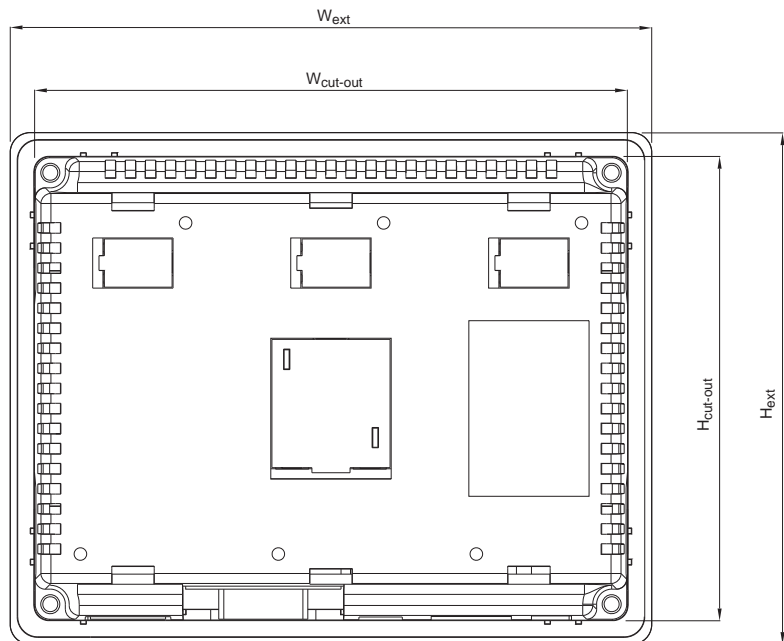

Figure 3.1: Dimensions of NQ-Series and required panel cut-out (landscape).

3-2 Mounting

The NQ-Series has been developed for panel mounting. Delivered mounting set with each NQ-Series contains:

- 4 mounting clamps
- A green power connector
- A sealing gasket (already mounted on the NQ)

Use the delivered mounting set for proper installation. After the preparation of the panel, the NQ-Series can be mounted using the supplied clamps. The NQ-Series comes with a gasket pre-installed behind the bezel, as shown in Figure 3.2: NQ-Series with gasket and mounting clamp slots.

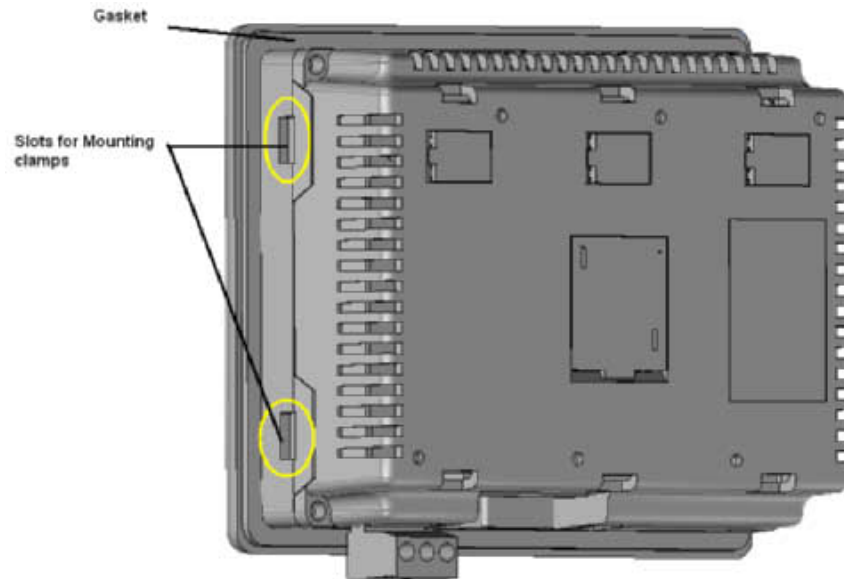

Figure 3.2: NQ-Series with gasket and mounting clamp slots

Mount the NQ-Series as follows.

- 1 Locate the four mounting clamp slots in the case of the NQ-Series. The NQ3 models have their slots located at the side surfaces of the case (as shown in Figure 3.2: NQ-Series with gasket and mounting clamp slots). The slots of the NQ5 models are located at the top and bottom surfaces of the case.
- 2 Keep the four mounting sets at hand. Each set consists of a screw (1), a clamp (2) and a cap (3) as shown in Figure 3.3: Mounting hardware set.

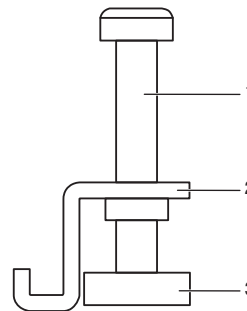

Figure 3.3: Mounting hardware set

- 3 Insert the case into the cut-out in the panel, from the front side of the panel.
- 4 Insert a clamp into a mounting clamp slot on the case and tighten the screw slightly as shown in Figure 3.4: Case being fixed in panel.

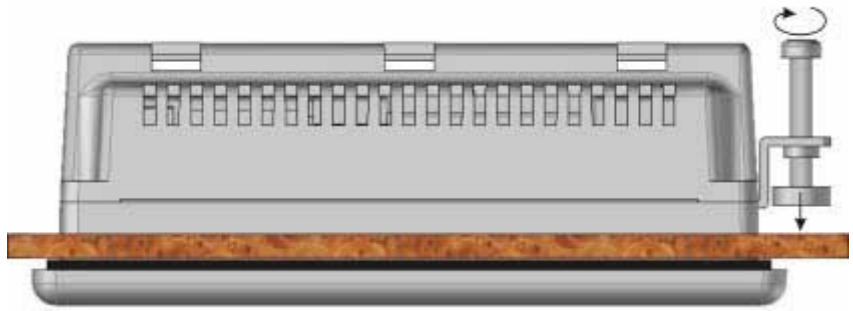

Figure 3.4: Case being fixed in panel

- 5 Repeat previous step for the other three clamps.
- 6 Hold the NQ-Series straight and tighten all four screws evenly to a torque between 0.5 Nm and 0.6 Nm.

3-3 Wiring

NQ-Series models have, besides one power connector, a number of communication ports. Please refer to Table 2.2: Common specifications for NQ-Series and Table 2.3: Specifications per NQ-Series model for the availability of these ports on each of the NQ-Series models.

⚠ WARNING Connecting high voltages or AC power mains to the DC input will make the NQ Series unusable and may create an electrical shock hazard to personnel. Such a failure or shock could result in serious personal injury, loss of life and/or equipment damage. DC voltage sources should provide proper isolation from main AC power and similar hazards.

⚠ Caution If wiring is to be exposed to lightning or surges, use appropriate surge suppression devices. Keep AC, high energy and rapidly switching DC wiring separate from signal wires.

3-3-1 Power connector

All NQ-Series models have a 3-pin, Green coloured, power connector with pin layout as shown in Figure 3.5: Power connector. Wire the inputs of the power connector according to the pin layout, from left to right: +24 V_{DC} (DC+), 0 V (DC-) and Earth.

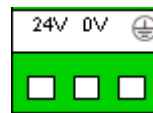

Figure 3.5: Power connector

3-3-2 Communication ports

The NQ-series supports different types of communication ports. Depending on model there are Ethernet and/or serial ports available.

These ports have two functions:

- 1 Connect to programming devices during configuration.
- 2 Communicate with a PLC and other devices in operating mode.

3-3-2-1 COM1 port

COM1 is an integrated RS-232 and RS-485/RS-422 communication port. It communicates with external peripheral devices at baud rates of 4800 kbps to 187.5 kbps with none, even or odd parity.

RS-485/RS-422 can be used in multi-drop (networks with more than one NQ-Series or PLC) communication networks.

The connector is a standard D-type 9-pin female connector (see Figure 3.6: 9-pin sub-D connector) with pin layout as shown in Table 3.2: Pin layout of port COM1.

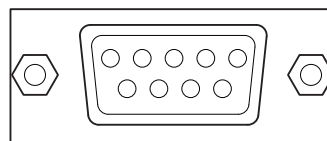

Figure 3.6: 9-pin sub-D connector

Table 3.2: Pin layout of port COM1

Pin number	Pin name	Description
1	TX+	RS-422 transmit +
2	TXD	RS-232 transmit
3	RXD	RS-232 receive
4	RX+	RS-422 receive +
5	GND	Signal Ground
6	NC	Not connected
7	NC	Not connected
8	TX-	RS-422 transmit -
9	RX-	RS-422 receive -
shell		shield

Note NQ3-TQ010B and NQ5-TQ010B have built-in termination resistor switch for correct termination of RS422/RS485 networks.

3-3-2-2 COM2 port

COM2 is a RS-232 communication port. It communicates with external peripherals at baud rates of 4800 kbps to 115.2 kbps with None, Even or Odd parity.

The connector is a standard D-type 9-pin female connector (see Figure 3.6: 9-pin sub-D connector) with pin layout as shown in Table 3.3: Pin layout of port COM2.

Table 3.3: Pin layout of port COM2

Pin number	Pin name	Description
1	NC	Not connected
2	TXD	RS-232 transmit
3	RXD	RS-232 receive
4	NC	Not connected
5	GND	Signal Ground
6	NC	Not connected
7	NC	Not connected
8	NC	Not connected
9	NC	Not connected
shell		shield

3-3-2-3 USB host port

The USB host port is compliant with the USB 2.0 specification. The USB host port supports USB memory stick devices. The USB sticks can be used for data logging and program upload/download, and carrying print files in CSV format.

The connector is a standard USB type A female connector as shown in Figure 3.7: USB host connector.



Figure 3.7: USB host connector

Pinning of the USB host port is described in the table below.

Table 3.4: Pin layout of USB host port

Pin number	Pin name	Description
1	VBUS	+5V
2	D-	Data -
3	D+	Data +
4	GND	Signal ground
shell		shield

3-3-2-4 USB device port

The USB device port is compliant with the USB 2.0 specification for self-powered devices.

The connector is a standard USB type B female connector as shown in Figure 3.8: USB device connector.

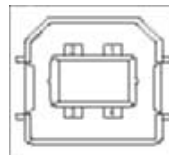

Figure 3.8: USB device connector

Table 3.5: Pin layout of USB device port

Pin number	Pin name	Description
1	VBUS	+5V
2	D-	Data -
3	D+	Data +
4	GND	Circuit ground
shell		shield

3-3-2-5 Ethernet Port

Several NQ-Series models have next to the serial ports also an Ethernet port. This port is a shielded RJ-45 female jack with built-in speed and link activity indication LED's.

The Ethernet port supports:

- 10/100 Mbps Ethernet networks
- Upload/download programs
- Auto-crossover function

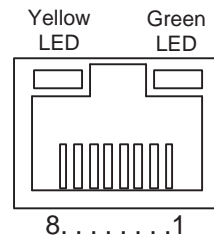

Figure 3.9: Ethernet Port

Table 3.6: Pin layout of Ethernet port

Pin number	Signal name	Description
1	TD+	Twisted-pair output (differential output)
2	TD-	Twisted-pair output (differential output)
3	RD+	Twisted-pair input (differential input)
4	BI_D+	Protection circuit
5	BI_D-	Protection circuit
6	RD-	Twisted-pair input (differential input)
7	BI_D+	Protection circuit
8	BI_D-	Protection circuit

Led definition:

- Green: link / activity indication
- Yellow:
 - On = 100 Mbps
 - Off = 10 Mbps

3-4 Multi-drop networks

Several NQ-Series can be set up in a network. The following wiring diagrams show the correct connections:

- RS-422 network
- RS-485 network

3-4-1 RS-422 network

The following wiring diagram is applicable for a RS-422 network (4-wire).

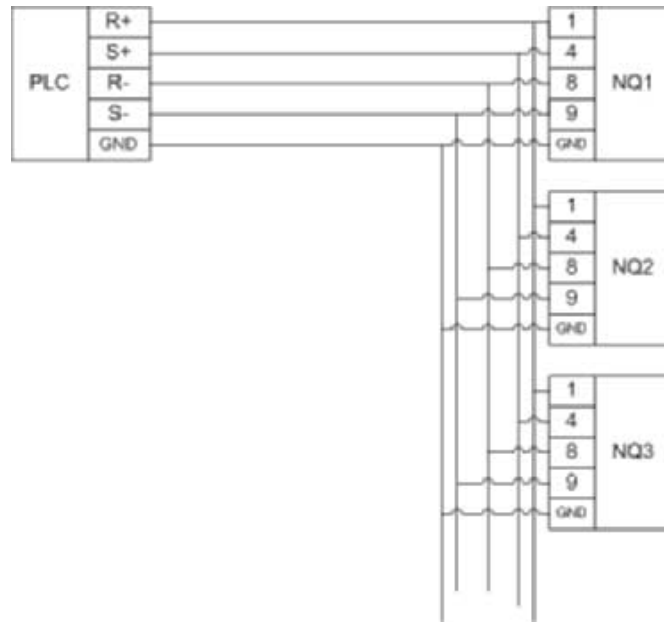

Figure 3.10: RS-422 network

3-4-2 RS-485 network

The following wiring diagram is applicable for a RS-485 network (2-wire).

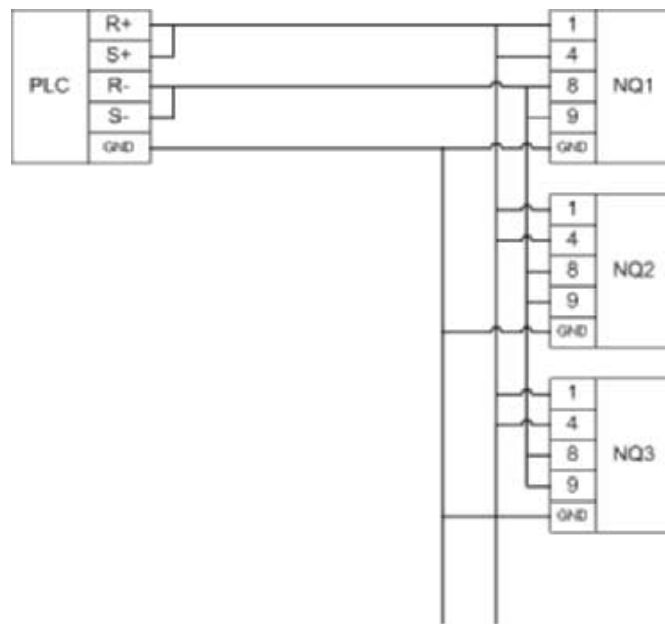

Figure 3.11: RS-485 network

3-4-3 Network termination

RS-422/RS-485 networks are balanced networks. This means that for stable connections both ends of a multi-drop network have to be terminated with the same resistor. Correct terminating a NQ, you must add a resistor on to the male D-SUB9 connector of the communication cable connected to COM1. This termination resistor must be applied between R+ (Pin 4) and R- (Pin 9).

For OMRON products commonly a termination resistor of 220 Ohm is used.

NQ3-TQ010B and NQ5-TQ010B provide a termination resistor switch for COM1 which is located under the central lid shown in below [figure 3.12]. When switched ON the RS-422/RS-485 network will be terminated with a resistor of 220 Ohm.

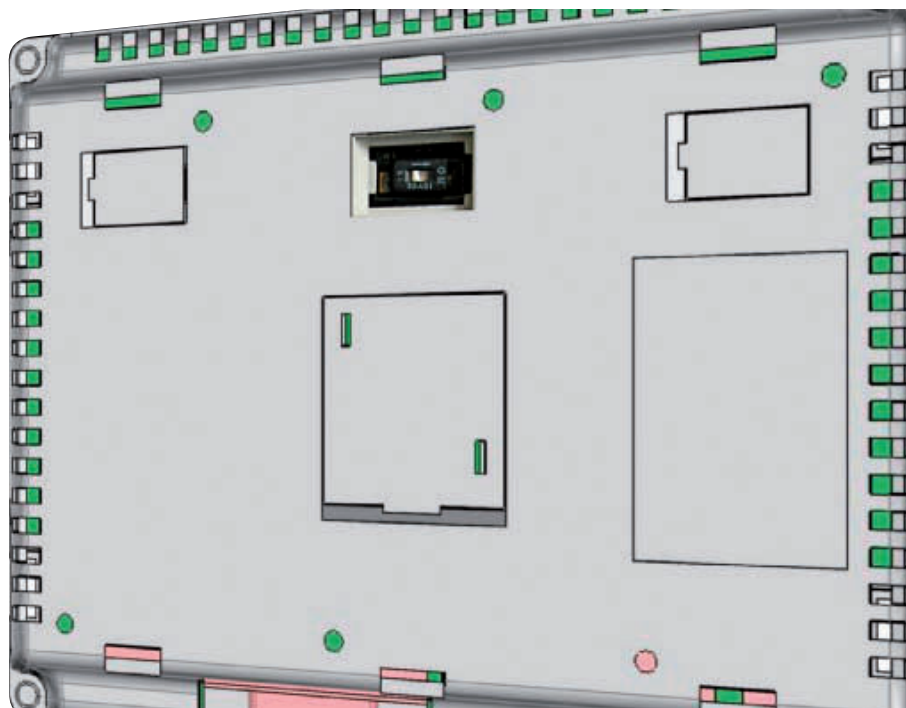

Figure 3.12: Position of termination resistor switch

Note When termination is switched ON for RS-422/RS-485 communication the RS-232 communication for COM 1 will not work anymore.

Always check your network that the termination resistors at both ends of the network are the same.

SECTION 4

Creating applications

This section describes how to create programs for the NQ-Series.

4-1	Preparing for programming	20
4-2	Using NQ-Designer	24
4-3	Example application	39
4-4	Printing from NQ-Series	53
4-5	Model conversion in NQ-Designer	54
4-6	Connecting NQ-Series to OMRON products.....	57

4-1 Preparing for programming

4-1-1 NQ-Designer

NQ-Designer is used to create and modify user interfaces for the NQ-Series. The user interface is created in the software and downloaded to the device. Existing user interfaces can be uploaded to the software and be modified as required. The software can also be used in a simulation mode to test the program without downloading the program to the NQ-Series.

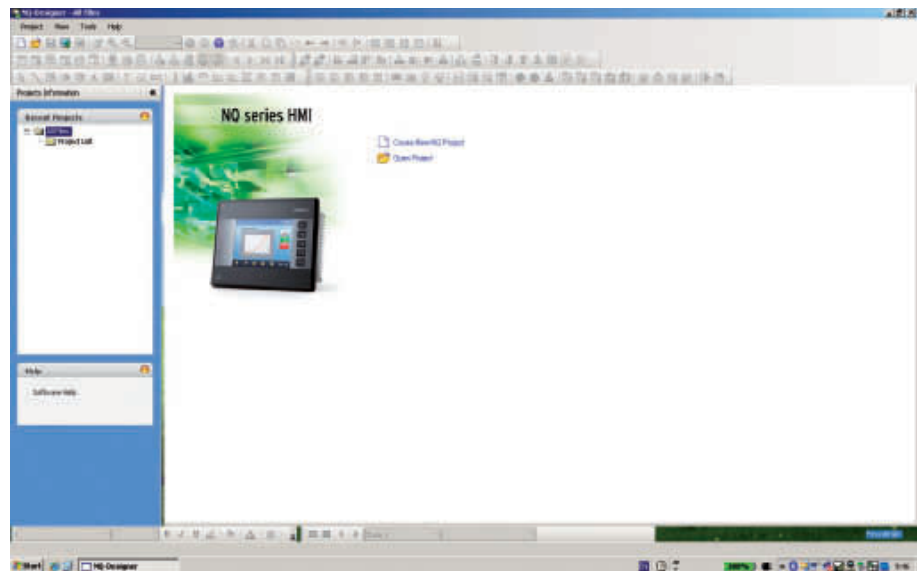

Figure 4.1: NQ-Designer

4-1-2 System requirements

The following basic PC hardware configuration is needed to install and use NQ-Designer.

4-1-2-1 Microsoft® Windows® XP configuration

Table 4.1: Windows® XP configuration

Device	Recommendations
Processor	Minimum: 600 MHz Pentium processor or equivalent processor
	Recommended: 800 MHz Pentium processor or equivalent processor
Operating System	Windows® 2000 with SP4, Microsoft® Windows® XP Professional Microsoft® Windows® XP Home Edition with SP2
System RAM	Minimum: 128 MB
	Recommended: 256 MB/512 MB
Hard Disk Space	800 MB (including 200 MB for the .NET Framework Redistributable)
Display	Minimum: 800 x 600 with 256 colours
	Recommended: 1024 x 768 with 16 bit colour quality
Serial Port	Serial port or USB port

Device	Recommendations
Mouse	Microsoft® Mouse or compatible pointing device
Keyboard	Required

4-1-2-2 Microsoft® Windows® Vista configuration

Table 4.2: Windows® Vista configuration

Device	Recommendations
Processor	Minimum: 800 MHz Pentium processor or equivalent processor
	Recommended: 1 GHz Pentium processor or equivalent processor
Operating System	Microsoft® Windows® Vista Home SP1 Microsoft® Windows® Vista Business Edition SP1
System RAM	Minimum: 512 MB
	Recommended: 1 GB
Hard Disk Space	800 MB (including 200 MB for the .NET Framework Redistributable)
Display	Minimum: 800 x 600 with 256 colours
	Recommended: 1024 x 768 with 16 bit colour quality
Serial Port	Serial port or USB port
Mouse	Microsoft® Mouse or compatible pointing device
Keyboard	Required

4-1-2-3 Microsoft® Windows® 7 configuration

Table 4.2: Windows® 7 configuration

Device	Recommendations
Processor	Minimum: 1 GHz Pentium processor or equivalent processor as long as it satisfies all other requirements
	Recommended: 1GHz Pentium processor or equivalent processor as long as it satisfies all other requirements
Operating System	Microsoft® Windows® 7 Professional Microsoft® Windows® 7 Ultimate editions
System RAM	Minimum: 1 GB (32-bit) and 2 GB (64-bit)
	Recommended: 1 GB (32-bit) and 2 GB (64-bit)
Hard Disk Space	800 MB (including 200 MB for the .NET Framework Redistributable)
Display	Minimum: 800 x 600 with 256 colours
	Recommended: 1024 x 768 High Colour 16-bit
Serial Port	Serial port or USB port
Mouse	Microsoft® Mouse or compatible pointing device

Device	Recommendations
Keyboard	Required

4-1-3 Installing the software

To install NQ-Designer run **setup.exe** from the installation disc and follow the installation instructions.

4-1-4 Connecting the NQ-Series power supply

Connect a 24 V_{DC} power supply to the NQ-Series.

4-1-5 Connecting the NQ-Series to a PC

The NQ-Series can be connected to a PC with the following programming cables:

- USB cable (CP1W-CN221)
- Ethernet cable
- Serial cable (NT2S-CN002)

Refer to Appendix A-1 OMRON communication cables and Appendix A-3 Non-Omron devices communication cables for more information on cables.

4-1-5-1 USB cable

In order to use a USB cable the USB driver needs to be installed on the PC operating system. Perform the following steps to install the USB driver.

- 1 Connect the USB cable to the PC and NQ-Series.
- 2 When the PC detects the NQ-Series the following message is displayed:
Found New Hardware: HMI USB Device.
On the dialog select **Found New Hardware Wizard, No, not this time** and click **Next** (It depends on the environment whether the message is displayed or not.).
- 3 Select **Install from a list of specific location** and click **Next**.
- 4 Ensure that **Include this location in the search** is checked and browse to the following location:
C:\Program Files\OMRON\NQ-Designer\USBDrivers
- 5 Click **Next** to install the USB driver.
- 6 If the **Hardware Installation** dialog is displayed, click **Continue Anyway**.
- 7 Click **Finish** to complete the installation.

A correct installed driver will show a message on the NQ-Series' screen: **USB device status: Connected** (This message is only shown when no firmware is downloaded in the NQ).

4-1-5-2 Ethernet cable

NQ3-TQ010B and NQ5-TQ010B models are equipped with an Ethernet port. This Ethernet port allows you to connect via Ethernet to PLC or other devices. Mentioned NQ-Series with build-in Ethernet can act as FINS client or as FINS server. They support 10MB and 100MB, Full duplex networks and Auto-crossover function.

Below figure 4.2 shows the default Ethernet settings defined for NQ HMI.

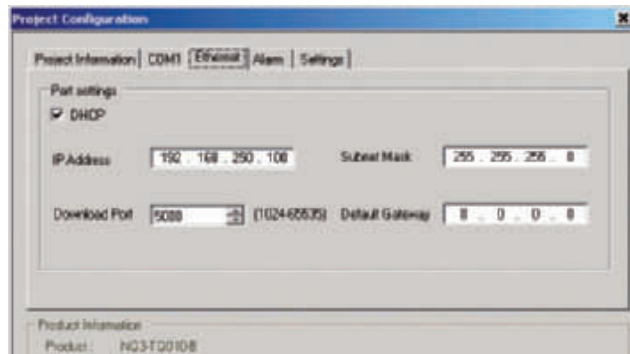

Figure 4.2: Port configuration

Next to the IP address, subnet mask, download port and gateway there is also an option/check box for DHCP.

DHCP option work as follows:

When checked, the NQ will on power-up wait for an IP address to be assigned. If there is no DHCP server on the network the NQ will use the IP address defined as in the above configuration window.

When powering on the NQ you will see a message if DHCP server is available and which IP address is assigned to NQ.

When unchecked the NQ will use the defined IP address and will not look for a DHCP server.

4-1-5-3 Serial cable

The serial cable can be used directly after connecting the cable.

4-2 Using NQ-Designer

4-2-1 Starting NQ-Designer

Select **Start, Programs** or **All Programs, Omron** and click on **NQ-Designer** to start the program.

4-2-2 NQ-Designer program window

Opening a project or creating a new project will show the below programming window on your Personal Computer.

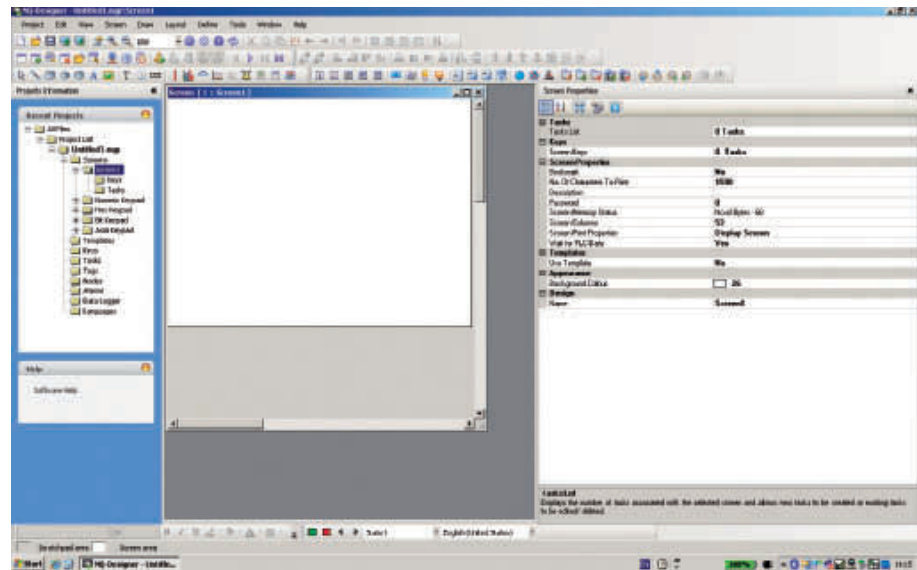

Figure 4.3: NQ-Designer program window

4-2-2-1 Title bar

The title bar displays the name of the program and the selected part of the project.

4-2-2-2 Menu bar

The menu bar contains the program commands.

4-2-2-3 Toolbars

The toolbars contain shortcuts to all program functions.

To display the tool tips hover over the icons in the toolbars.

On the **View** menu click **Toolbars** to hide or show a toolbar. The toolbars supporting drag and drop functionality.

4-2-2-4 Project panel

The project panel shows the structure of the program. From the project structure the project is managed and the project parts are set and configured.

On the **View** menu click **Projects Information** to hide or show the project panel.

Project list

The **Project list** contains all saved projects. The project file extension is **.nqp**.

Creating or opening a project will show the root folders described below.

Screens

The **Screens** folder contains one base screen and four predefined keypad screens that can be used in the project. For every screen the following parts can be configured:

- Layout: graphical representation of the screen
- Keys: function keys used in this screen
- Tasks: assigned tasks to the screen
- Password: a password can be assigned to pages that must be entered before the page can be accessed.

Keypad screens and screens numbered 65000 and higher are assigned as pop up screens. If a new popup screen is added to the project the screen will be located here.

Functions that can not be assigned to pop up screens are:

- Goto next screen
- Goto previous screen
- Open popup screen (it is not allowed to chain pop up screens)
- Data entry objects (triggers a keypad, which is a popup screen)
- Password protection

Templates

The **Templates** folder contains the created template screens. Template screens are screens that can be added to a base screen. Template screens are always placed behind the base screen. These screens usually contain keys, buttons or background images that are used frequently in the project.

Following objects can not be assigned or are conditional to template screens:

- Data Entry on PLC tags
- Keypads placed on template screens act on numerical input of the base screen
- Screen tasks (Before showing, while showing, after hiding tasks)
- Key specific tasks
- Passwords

Using templates will also positively influence the usage of the memory and reduce the programming time. (You re-use screens that you have programmed before and assign them to different base screens).

To add a template proceed as follows:

- Click on **ADD Templates** ().

Global Keys

The **Global Keys** folder can be used to assign tasks to global keys. Global keys are running cyclic for the whole project. The following tasks are available:

- **Press Task** (tasks executed while pressing the key)
- **Pressed Tasks**, (tasks executed while holding the key)
- **Released Tasks** (tasks executed while releasing the key)

Please note that when key tasks are assigned to screen keys the global keys will not be executed, e.g. global key F1 = add 1 to D000, and screen key F1 = subtract 1 from D000 then subtract 1 is active for this screen when pressing F1.

Tasks

On the **Tasks** dialog the **Power On** tasks and **Global** tasks can be configured. The **Power On** tasks are executed once the NQ-Series starts up. The **Global** tasks are executed every cycle of the program. The task list can contain more than one command.

Global tasks that most common used are:

- Copy RTC to PLC (this copies the NQ-Series' RTC data to assigned PLC tags (7 sequential tags)).

If the program contains many global tasks it can influence the performance of the NQ-Series.

Tags

The folder **Tags** shows all tags that can be used in the project. The folder contains the following tags: system tags (default set), internal tags (NQ tags) and PLC tags created by users.

Tags represent the addresses(bit, byte, word, double word registers) that will be used in a project.

To add a tag proceed as follows.

- Goto screen 1
- Click **Tag** () in the toolbar and click **Add...**

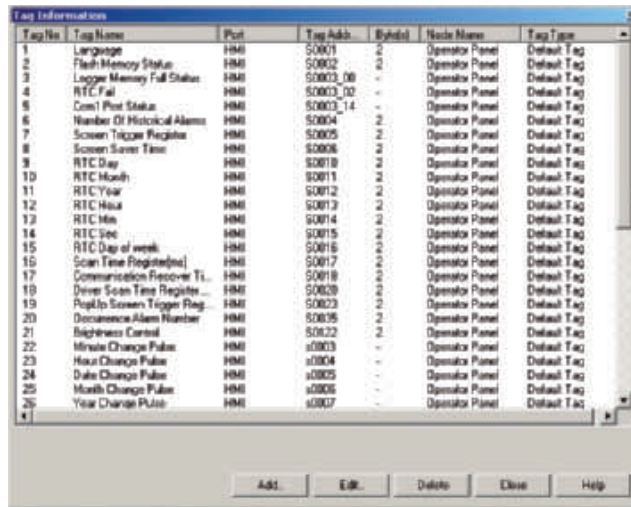

Figure 4.4: Tag information

- Enter **Tag Name**.
- Select **Register/Coil Type**.
- Select **Tag Type**.
- Select **Auto Add** to create a number of tags in sequence increasing by word or by bit depending on tag choice. (names can be edited afterwards)
- Select **2-Bytes (1-word)**.

Default system tags

The following tables contain the default system tags. Do not attempt to modify or delete the system tags. This could affect the functionality of the NQ-Series.

On the toolbar you find a button () that allows you to display all tags or user created tags shown in your tag list.

Table 4.3: Default system tags (words)

Register	Tag name	Read/Write	Description
S0001	Language	Read/Write	Writing a value will change languages in multi language supported objects (texts).
S0002	Flash memory status	Read	Shows percentage used of logger memory.
S0004	Number of historical alarms	Read	Shows number of alarms stored in history.
S0005	Screen trigger register	Read/Write	Shows active screen. Change screen by writing a valid screen number in the register.
S0006	Screen saver time	Read/Write	The screen saver time (Sec) can be changed during operation.

Register	Tag name	Read/Write	Description
S0008	IP Conflict Status Register	Read only	If there is an IP Conflict then 1 is written to this register. If there is no IP conflict then by default it is zero.
S0009	Driver Scan Time Register [ms]: Ethernet	Read only	Shows time required to execute Screen blocks in milliseconds. Use #####.# format for display for Ethernet drivers
S0010	RTC day	Read	RTC day in BCD format
S0011	RTC month	Read	RTC month in BCD format
S0012	RTC year	Read	RTC year in BCD format
S0013	RTC hour	Read	RTC hour in BCD format
S0014	RTC min	Read	RTC minute in BCD format
S0015	RTC sec	Read	RTC second in BCD format
S0016	RTC day of the week	Read	RTC day of week in BCD format 1 = Sunday 2 = Monday 3 = Tuesday 4 = Wednesday 5 = Thursday 6 = Friday 7 = Saturday
S0017	Scan time register	Read	Shows time required to execute screen, screen task and global task in millisecond. Use #####.## format for display.
S0018	Communication recover time[s] for port1	Read/Write	Shows time in seconds to recover the communication with failed nodes for port1. The default value is 60 sec.
S0019	Communication recover time[s] for port2	Read/Write	Shows time in seconds to recover the communication with failed nodes for port2. The default value is 60 sec.
S0020	Driver scan time register for port1	Read	Shows time required to execute screen blocks in milliseconds. Use #####.## format for display.
S0021	Driver scan time register [ms] for port2	Read	Shows time required to execute screen blocks in milliseconds. Use #####.## format for display.
S0023	Popup screen trigger register	Read/Write	Holds the screen number for the pop-screen that will be shown when bit s20 bit is set.

Register	Tag name	Read/Write	Description
S0028	HMI IP Address [LS Byte]	Read only	IP ADDRESS Lower word
	HMI IP Address [2nd Byte]	Read only	IP ADDRESS Lower word
S0029	HMI IP Address [3rd Byte]	Read only	IP ADDRESS Higher word
	HMI IP Address [MS Byte]	Read only	IP ADDRESS Higher word
S0030	HMI Subnet Mask [LS Byte]	Read only	HMI Subnet Mask Lower word
	HMI Subnet Mask [2nd Byte]	Read only	HMI Subnet Mask Lower word
S0031	HMI Subnet Mask [3rd Byte]	Read only	HMI Subnet Mask Higher word
	HMI Subnet Mask [MS Byte]	Read only	HMI Subnet Mask Higher word
S0032	HMI Default Gateway [LS Byte]	Read only	HMI Default Gateway Lower word
	HMI Default Gateway [2nd Byte]	Read only	HMI Default Gateway Lower word
S0033	HMI Default Gateway [3rd Byte]	Read only	HMI Default Gateway Higher word
	HMI Default Gateway [MS Byte]	Read only	HMI Default Gateway Higher word
S0034	HMI Download Port	Read only	NQ download Port
S0035	Occurrence alarm number	Read/Write	Occurrence Count of Alarm Number present in S0035 will reset to zero when coil s0044 is SET
S0121	Contrast control (Retentive register)	Read/Write	This retentive register used for setting the contrast of the NQ-Series.
S0122	Brightness control (Retentive register)	Read/Write	This retentive register used for setting the brightness of the NQ-Series.

Table 4.4: Default system tags (Bit)

Register	Tag name	Read/Write	Description
S0003_00	Logger memory full status	Read	1: full memory
S0003_02	RTC fail	Read	RTC fail (contents of registers not within defined ranges e.g. minutes>60)
S0003_13	Ethernet Port Status	Read only	0: Communication Error, 1: Communicating with PLC
S0003_14	Comm1 status	Read	0: communication error 1: communication OK
S0003_15	Comm2 status	Read	0: communication error 1: communication OK

Register	Tag name	Read/Write	Description
s0003	Minute change pulse	Read	1 for every change in minute for one scan cycle
s0004	Hour change pulse	Read	1 for every change in hour for one scan cycle
s0005	Date change pulse	Read	1 for every change in date for one scan cycle
s0006	Month change pulse	Read	1 for every change in month for one scan cycle
s0007	Year change pulse	Read	1 for every change in year for one scan cycle
s0008	Screen saver control	Read/Write	0: disable screen saver 1: enable screen saver This bit can be changed in during operation
s0009	Beeper on/off	Read/Write	0: disable beeper 1: enable beeper This bit can be changed during operation.
s0010	Battery status	Read	0: battery voltage is OK 1: low battery (below 2.2 V)
s0012	Update the historical trend	Read/Write	Update the historical trend window when set to 1
s0014	Acknowledge all alarms	Read	0: all alarms are acknowledged 1: all alarms are not acknowledged in the real and historical alarms
s0016	Valid key beeper	Read/Write	0: disable valid Function key beeper 1: enable valid Function key beeper This bit can be changed during operation
s0017	Invalid key beeper	Read/Write	0: disable valid screen beeper 1: enable valid screen beeper. When set to 0 the NQ-Series will only generate a beep when an input area is pressed. This bit can be changed during operation

Register	Tag name	Read/Write	Description
s0019	Invalid date entry	Read	0: valid date 1: invalid date (range not within defined ranges e.g. month > 12)
s0020	Popup screen control coil	Read/Write	Triggers the popup screen number stored in S0023
s0021	Communication recover enable bit: port1	Read/Write	If this bit is set communication with the failed nodes is detected after scan time S0018 for port1 (on by default)
s0022	Communication recover enable bit: port2	Read/Write	If this bit is set communication with the failed nodes is detected after scan time S0019 for port2 (on by default)
s0023	Communication recover enable bit: Ethernet port	Read/Write	If this bit is set communication with the failed nodes is detected after scan time S0020 for Ethernet port (on by default)
s0028	Bittask datalogger-logger group1 bit	Read/Write	User can start/stop logging in bit task mode for group1 by using this bit. 1: Start logging 0: Stop logging
s0029	Bittask datalogger-logger group2 bit	Read/Write	User can start/stop logging in bit task mode for group2 by using this bit. 1: Start logging 0: Stop logging
s0030	Bittask datalogger-logger group3 bit	Read/Write	User can start/stop logging in bit task mode for group3 by using this bit. 1: Start logging 0: Stop logging
s0031	Bittask datalogger-logger group4 bit	Read/Write	User can start/stop logging in bit task mode for group4 by using this bit. 1: Start logging 0: Stop logging

Register	Tag name	Read/Write	Description
s0032	Lock data entry	Read/Write	User can lock/unlock the data entry (keypad entry). 0: data entry unlock 1: data entry lock
s0033	Start data entry only through enter key	Read/Write	User can choose the mode of data entry using this bit. 0: allow data entry through enter key or numeric key 1: allow data entry only by pressing enter key first
s0035	Ignore real and historical alarms	Read/Write	0: Monitor all alarms 1: Ignore all real and historical alarms
s0036	Run LED on/off	Read/Write	0: Run Led is On 1: Run Led is Off
s0037	Allow USB host operation	Read/Write	0: USB host operation not allowed 1: USB host operation allowed.
s0042	HMI DHCP Enable/Disable	Read only	DHCP Enable/Disable
s0043	Logged Data Clear Bit	Read/Write	Clears the Data Logged if this bit is Set
s0044	Occurrence Reset bit	Read/Write	The control coil for resetting occurrence of alarms (ON = reset)

Nodes

The **Nodes** folder contains the information of your network: the name of the panel and PLCs, node addresses in the network (listed under COM1 or COM2), protocol used on the COM port. COM1 and COM2 can have different protocols.

In this folder you can also add a node to your network.

- Click **Nodes** ().
- Right-Click on screen.
- Select add **Node**.

4-2-2-5 Alarms

The alarm folder contains the configurator for adding changing and defining alarms.

The alarm functionality allows you to choose from three different methods.

- 16 Random words
For each TAG (word) 16 alarms can be configured / assigned in the alarm window. A total of 16 different words (= 256 alarms) can be configured / assigned.
- 16 consecutive words
This function will be accessible after 16 consecutive word tags have been created in tag database. This alarm method will create 256 alarm lines at once in the alarm window.
- 256 discrete alarms
This function combines the creation of independent discrete bit or conditional alarms.
 - Discrete bit alarms
Each bit defined in tag list can be selected as an alarm bit. For each "bit" alarm you can select whether it should act on "rising edge" or "falling edge".
 - Conditional alarms
With conditional alarms you can generate an alarm based on the values from two different registers or generate an alarm by comparing the value of a tag (registers) compared to a defined value. Based on the definition an alarm will be raised if the logic condition defined is "true".
Possible conditions are:
 - < smaller then
 - > larger then
 - <= smaller then and equal to
 - >= larger then and equal to
 - == equal to
 - != Not equal to

The bit and conditional alarms can both be used at the same time.

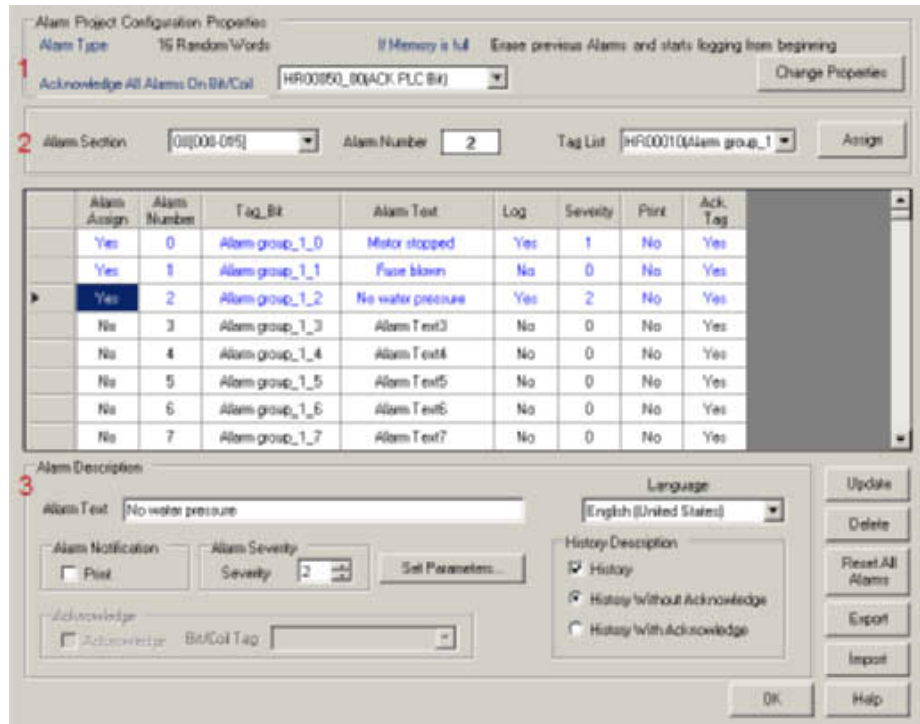

Figure 4.5: Alarm project configuration properties

Above screen will show when clicking the alarm folder in project tree.

From top to bottom this window can be divided in three areas.

1. Alarm type

This area is the main configuration part of the alarm configuration window. It shows you the selection made in the alarm tab, when you create a new project.

Alarm type: default selection is 16 random words.

Note: It is allowed to change format from 16 random words and 16 consecutive words to 256 discrete alarms. Other format conversions will reset the defined alarms.

Furthermore it shows the action performed when the alarm memory in NQ-Series is full Lower section of area 1 is how alarms can be Acknowledged.

Current view shows that all alarms will be acknowledged by setting the ACK PLC bit. Second possibility here will Acknowledge alarm by selection. If this is selected each alarm can be ACK by a tag defined in area 3 (ACK window).

Note: When pressing button "Change properties" all already assigned alarms will be erased and set to default.

2. Address assignment

This area allows you to assign the alarms. In alarm section you can define 16 groups. Each group will be assigned to a register (Word) and can contain 16 alarms. Depending on Alarm type selected in Area 1 the number of alarms will be reserved in the alarm window when pressing assign. For example 16 consecutive words will reserve 256 alarms at once, For 16 random words it will be 16 and for 256 discrete alarms it will be 1.

3. Definition of each alarm

This area allows you to define each alarm from text message (maximum 40 characters), severity, real/historical alarm, print and acknowledging (depending on acknowledge defined in area 1).

Set parameter button allows you to define the text of Acknowledged and active fields per language. Each language will contain it's own defined confirmation and can when programmed be different for each of the used languages.

After entering the correct definition for each alarm the button "accept" must be pressed to validate the alarm. Created alarms can be changed of name or format. After making the change "accept" must be pressed.

For assigning the alarm register that will be used to trigger alarms a tag has to be created in tag list.

Example:

HR000 is the alarm register used in the PLC program. Create a tag with HR000 in your tag list. Select this created tag and assign the alarm register. Upon assigning you will see that the first 16 lines are now identified as alarms. Bit HR000.00 as alarm 0 (Motor stopped), bit HR000.01 as alarm 1 (Fuse blown), etc.

Clicking on alarm 0 first line allows you to enter the alarm text, acknowledge (Y/N) and which bit should be used to perform ACK, severity, real time alarm or Historical alarm.

When all of these settings are made you click button ACCEPT. You see now all text turns blue and alarm sign has changed to YES.

With this method you can assign all alarms used in your project.

Important buttons are explained below for assigning alarms.



Figure 4.6: Alarm buttons

- Update will update the change you have applied to the alarms
- Delete will delete the alarm line you have selected.
- Reset all alarms will reset all settings in alarms. All will be cleared including the selected register for alarms
- Export will export all text used in alarms to CSV for creation of Multilanguage application.
- Import will import the modified CSV file for multilanguage in the project.

4-2-2-6 Data Logger

The data logger allows users to log data (tags) in the NQ-Series over time. The data logger folder contains the set-up/configuration for data logging and data logging printing.

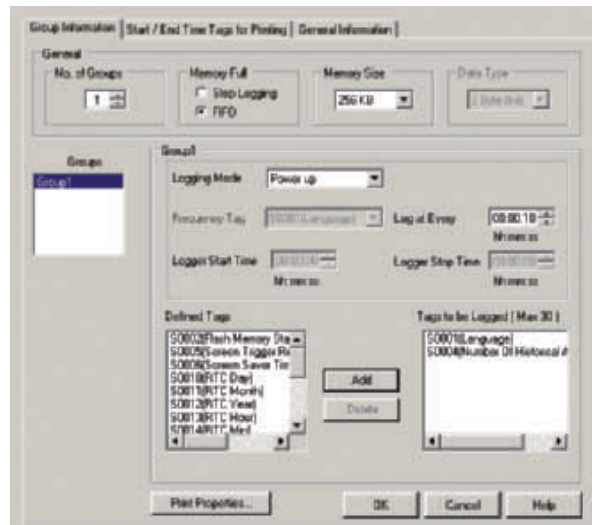

Figure 4.7: Data logger

The memory size reserved for logging data in the terminal can be selected. Several ranges can be selected from 256Kb to 2048Kb.

For memory full there are 2 possible selections how NQ-Series should behave:

- FIFO

This is the default setting. The FIFO function will, if set, erase the oldest 64kb of the datalogger file. This is a continuous process that allows you to have always the latest logger information.

Example: you have selected 256kb as logger data file. As soon as S0002 (flash status) reached 100% , the first entries occupying 64 KB will be removed and S0002 will be set to 75%.

For 512kb this will be 88%, 1024KB will be 94% and 2048KB will be 97%

- Stop logging

This setting will stop the log function when S0002 reaches 100%.

For logging the data type (word / double word) can be selected. Upon this selection the tags available for logging will then be filtered to what can be chosen for logging.

The data logger allows a user to define 4 different groups. Each group can contain of 30 tags that can be logged. For each group a logging mode can be defined.

The datalogger can handle 6 different logging modes.

- Power up

Each tag defined in this group will be logged when terminal is powered and application is running. The logging frequency for this group can be set.

- Start / Stop time

User can define on which part of the day the logging must occur. Also with this option the logging frequency can be programmed for the whole group when choosing this mode.

- Key task

User can assign keys / buttons to start and stop logging. The commands can be found under "Keys specific Task" selection.

- Logging with run time frequency

This mode can only be used for group 1 and is intended for datalog printing only. When selected this option each tag will be logged with a selectable interval of minimum 30 minutes.

- Bit task
User can use the system bits s28 (group1) to s31 (group4) to start or stop logging. If system bit is set to 1 logging starts.
- Event based
User can select an internal bit for logging. There are 3 options to select. : Positive edge, Negative edge, Both edges. When selecting each of these options the logging will start / stop on the selected conditions.

4-2-2-7 Languages

The **Languages** dialog shows the supported languages and manages the languages supported by the project. To support a language the language needs to be added to the program. NQ-Designer supports a total of 9 languages. The default language of the program is the default language of the operating system.

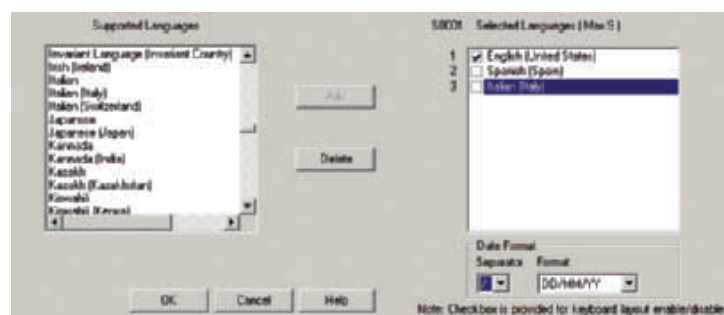

Figure 4.8: Languages

To add a language proceed as follows.

- Select the language from the **Supported Languages** list and click **Add**.
- Each language can be individually programmed so that the correct date format and separator can be displayed in the NQ-Series.
- Check the checkbox to enable keyboard layout for the selected language.

In the language folder you will see S0001 displayed. In front of each added language a value is shown. If the value in register S0001 is set to the value shown in front of the added language the project will then be displayed in the selected language.

First language shown in the language folder is the default language of your Windows operating system. Languages can be added or removed from this folder.

If you use the import/export tool for entering multiple languages you do not need to enable the keyboards in this folder. A keyboard can be enabled if you add the language to your Windows operating system. Languages can always be added to the program in a later stage.

Creating a multi language application import / export functionality for translation you will always have to export and import 2 different files.

Text objects (Import / export text objects in Toolbar) AND Alarm objects (in alarm folder).

4-2-2-8 Workspace

The workspace is used to create and edit the projects. The properties panel displays the properties of the settings. The properties can be changed by clicking the properties' value.

4-2-2-9 Status bar

The status bar contains additional information regarding scratch pad area and the screen area coordinates. The scratch pad area is the total screen area available for programming.

4-2-2-10 Properties window

The properties window shows the properties of the selected object. Properties that can be changed by user are displayed in **bold**.

4-2-3 Using the help function

The help function is displayed by clicking **Software help** or **Contents** on the **Help** menu.

4-3 Example application

4-3-1 Project settings

- 1 Start NQ-Designer.
- 2 Click **Create New Project** or click **Create New NQ Project** on the **Project** menu under **New**.

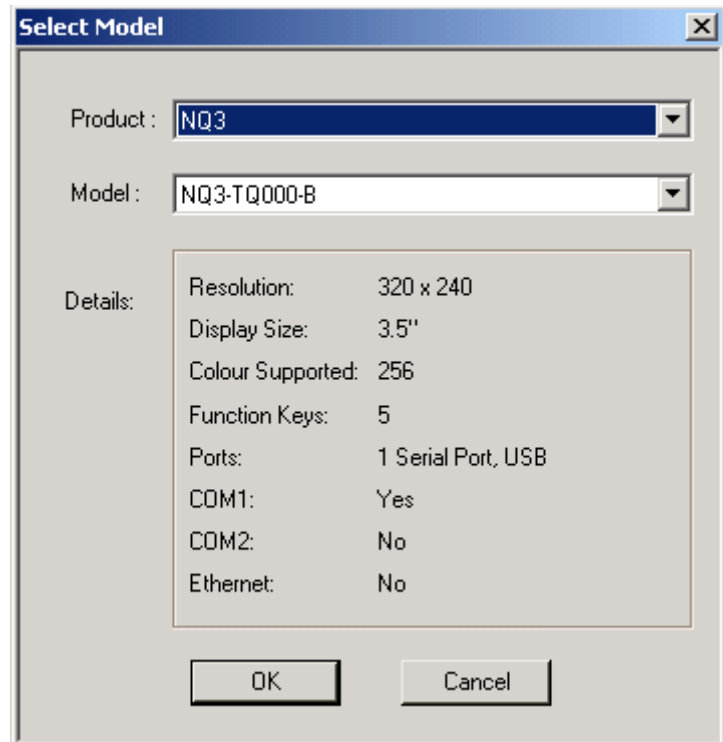

Figure 4.9: Select model

- 3 Select **NQ3** in product pulldown list. Select **NQ3-TQ010B** as model type. Click **OK**.

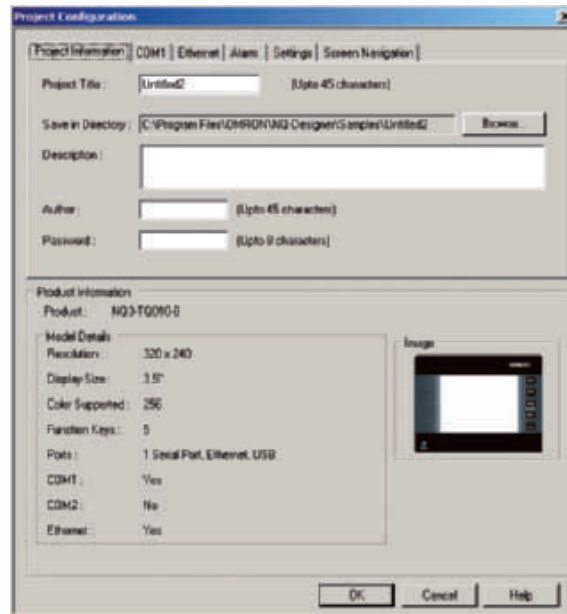

Figure 4.10: Project information

- 4 Enter the following project data:
 - Project title: Example
- 5 Click **COM1** tab.

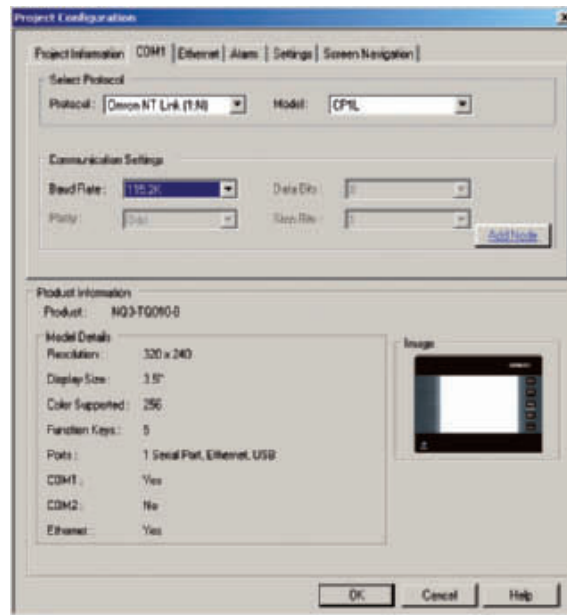

Figure 4.11: COM1

- 6 Enter the following communication settings:
 - Protocol: Omron NT Link
 - Model: CP1L
 - Baud Rate: 115.2K
 - Data Bits: 8
 - Parity: Odd
 - Stop Bits: 1
- 7 Click **Add Node**.

8 Click **Alarm** tab.



Figure 4.12: Alarm

9 Enter the following alarm settings:

- 16 random words: Each bit of each random assigned word is an alarm

10 Click **Settings** tab.

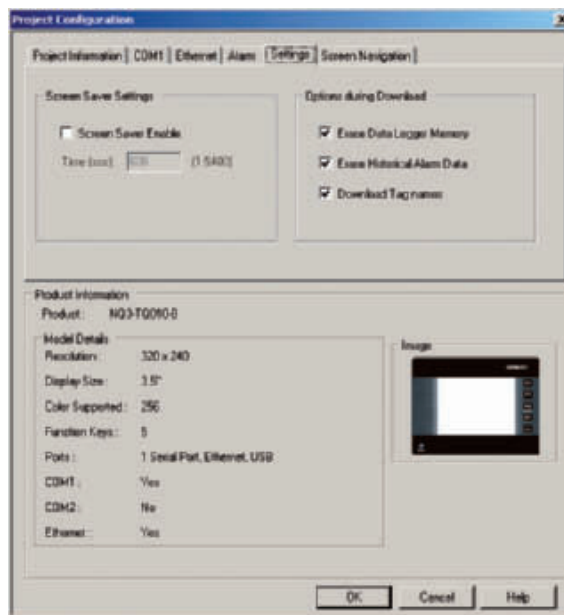

Figure 4.13: Settings

11 Enter the following settings:

- Screen Saver Enabled

12 Click Screen Navigation tab

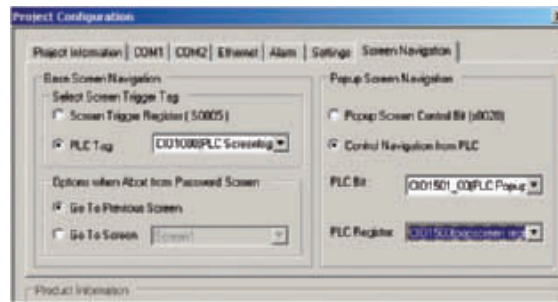

Figure 4.14: Screen Navigation

13 Select the control method for base screen and or popup screen navigation.
 14 Click **OK**.

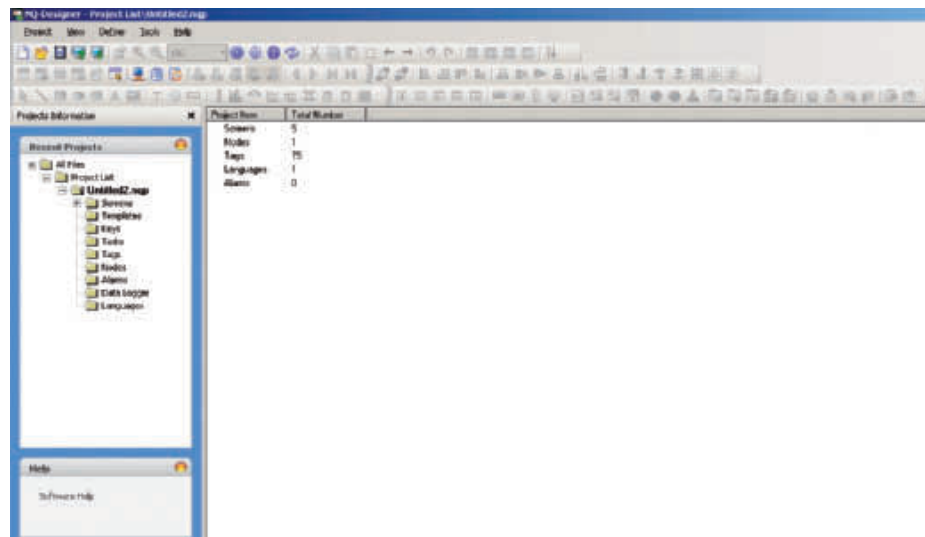

Figure 4.15: NQ-Designer screen

Refer to 4-2-2-4 Project panel for information on the project panel content.

4-3-2 Screen functionality

NQ-Designer automatically generates 5 screens:

- 1 base screen for programming
- 4 predefined keypad screens (pop-up screens)

The properties window can be used to change the properties. Properties displayed in bold can be changed. The most important properties are as follows:

- **Tasks List**
- **Use Template**

Proceed as follows:

- 1 Double-click **Screens**. Click **Screen1**.
- 2 Click ... from **Tasks List** in the property panel.
- 3 Select task from pulldown menu.

For each screen you can define if actions should be made before , during or after closing the screen

4-3-3 Multilingual text objects

Multilingual text objects are used to display texts. This object should be used when programming a multilingual application. The most important properties are as follows:

- Visibility Animation
- Font
- Flash
- Text Colour

Proceed as follows:

- 1 Click **Multilingual Text** ().
- 2 Draw the multilingual text object on **Screen1**.
- 3 Press the space bar. This will open a field in the Status Bar of NQ-Designer. This will allow you to enter text immediately.

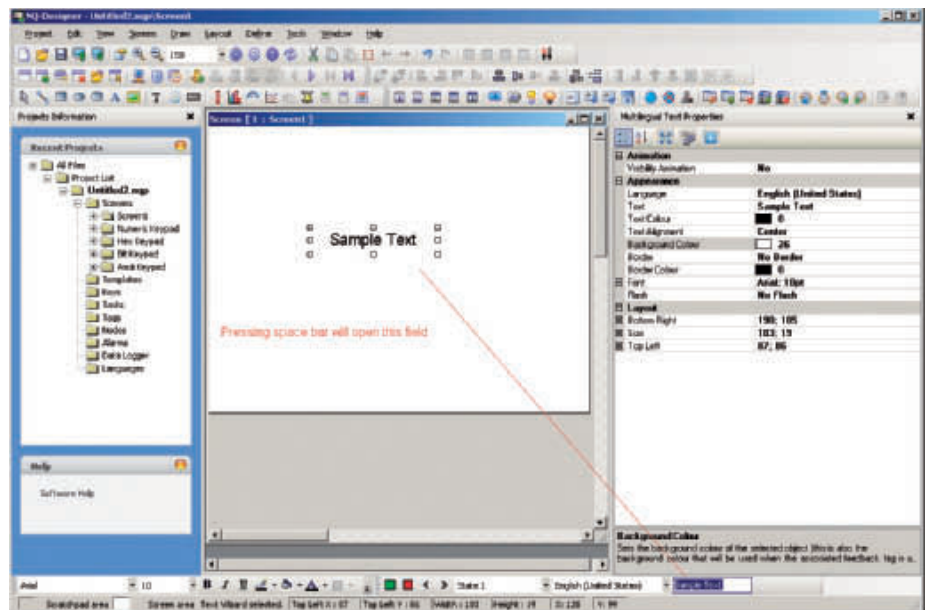

Figure 4.16: Multilingual text objects

4-3-4 Data entry objects

Data entry objects will use a keypad to change data. In the property box a popup screen (keypad screen is automatically assigned with respect to format used). If the user wants to add a keypad to base screen to change an input, the setting keypad should be set to NO in the numerical input configuration

Data entry objects are used to enter:

- numerical data
- bit data



The most important properties for numerical data are as follows:

- Tag Address (register)
- Tag Name
- Data Type (unsigned, hex, binary, etc.)
- Format (4,2) total 4 digit of which are 2 behind the delimiter (**,**)

The most important properties for bit data are as follows:

- Off Text
- On Text
- Keypad

Proceed as follows:

- 1 Right-click on **Screens** folder in project panel.
- 2 Click **New Base Screen** ().
- 3 Click on **Screen2**.
- 4 Click **Numerical Data Entry** ().

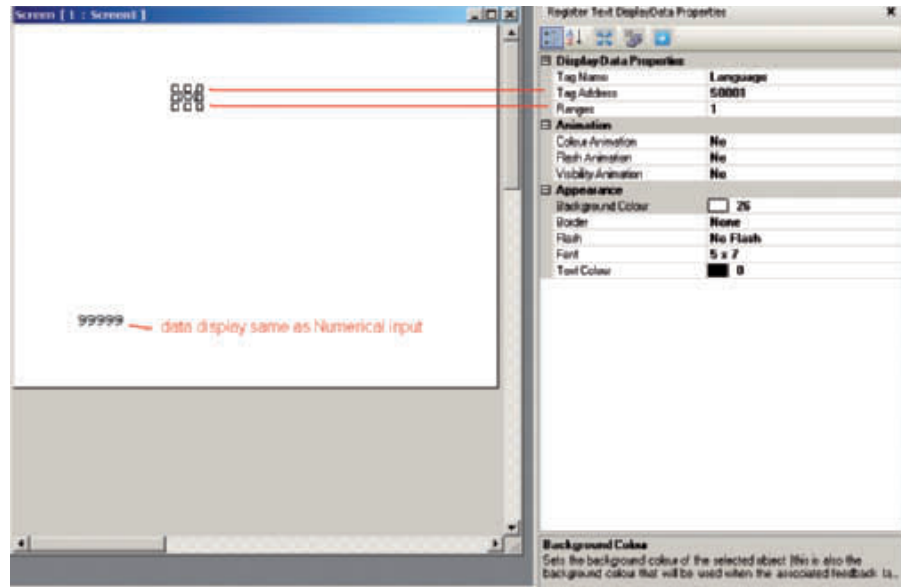

Figure 4.17: Data entry objects

Note Right lower field shows explanation of field selected in property box.

4-3-5 Display data objects

Display data objects are used to display:

- numerical data
- message data
- bit data

The most important properties for numerical data are as follows:

- Tag Address
- Tag Name
- Data Type



The most important properties for message data are as follows:

- Ranges
- On Text
- Tag Address
- Colour/Flash/Visibility Animation

The most important properties for bit data are as follows:

- Off Text
- On Text
- Tag Address
- Colour/Flash/Visibility Animation

Proceed as follows:

- 1 Right-click on **Screens** folder in project panel.
- 2 Select **New Base Screen** ()
- 3 Click on **Screen3**.
- 4 Click **Numerical Data Display** () .
- 5 Click on **Screen3**.
- 6 Click **Message Data Display** () .
- 7 Click **1** from **Ranges** in the property panel.

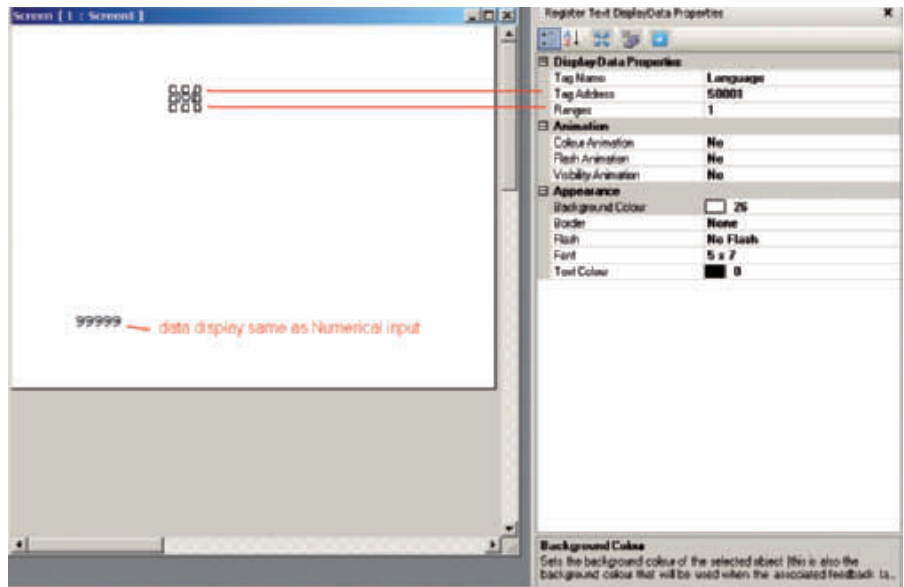

Figure 4.18: Display data objects

- 8 Click **Add**. (ranges can be modified to desired values)

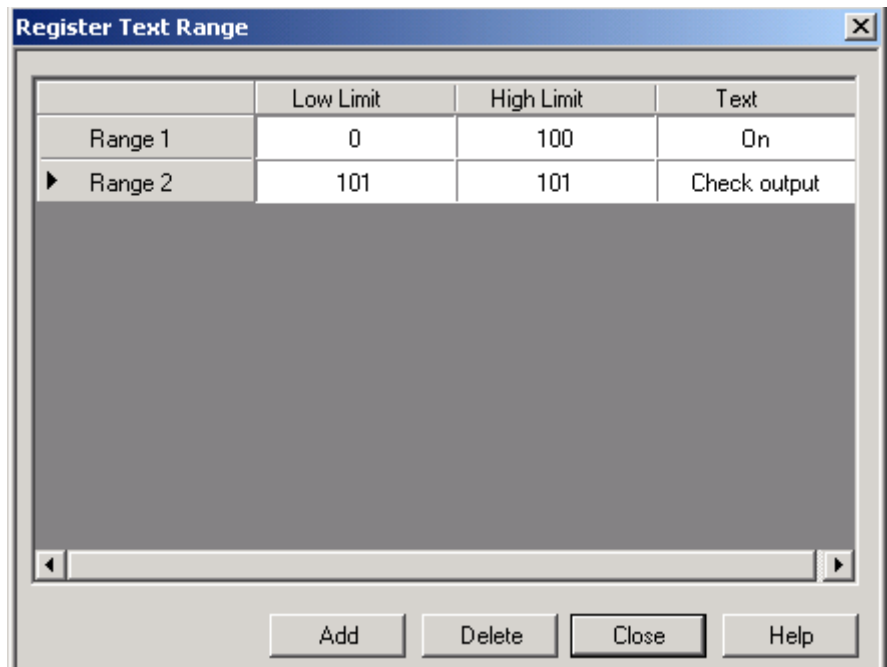





Figure 4.19: Register text range

4-3-6 Buttons

Buttons are used to assign tasks. The following buttons are available:

- Predefined buttons ()
Buttons to which predefined single tasks can be assigned..
- Advanced bit button ()
Free configurable bit buttons with feedback option. The following behaviour can be programmed: press (rising edge), pressed (high) and released (falling edge).
- Word button ()
Buttons that can be configured on 32 states referenced to the value of the used tag defined for each state. Different tasks and messages can be assigned to each state of a word button.

The most important properties for buttons, advanced bit buttons and word buttons are as follows:

- Button Style
- On Text
- On Text Colour

Proceed as follows:

- 1 Click on **Screen3**.
- 2 Click **Word Button** ().
(Pressing the space bar will allow you to enter text directly.)
- 3 Click **Collection** from **State Properties** in the property panel.
- 4 Click **Add State**.

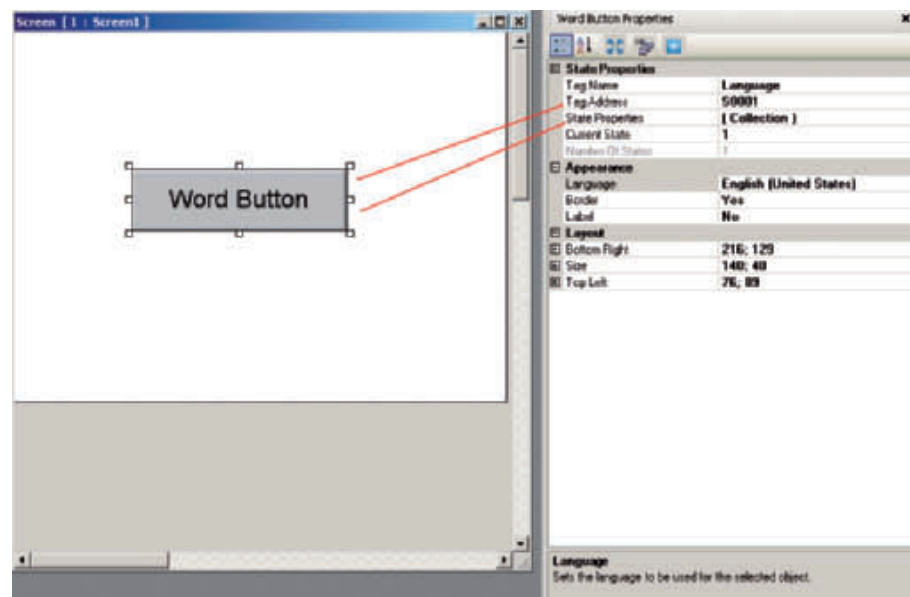

Figure 4.20: Word button

- 5 Click ... from **Tasks List** in the property panel.
- 6 Click **Add**.

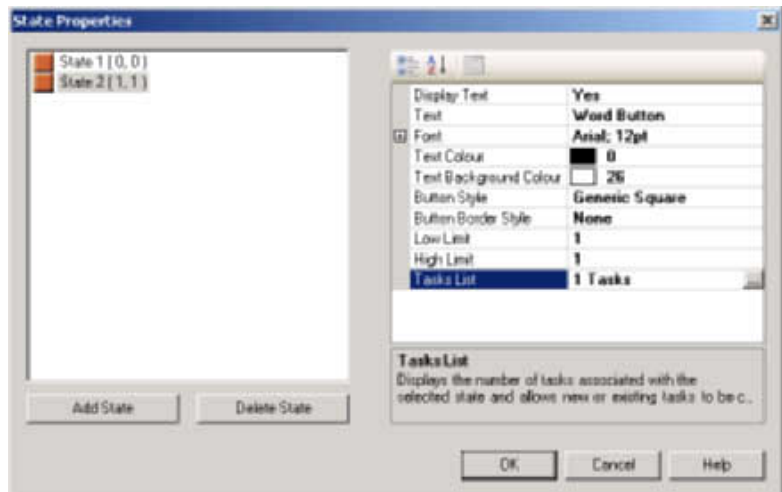

Figure 4.21: State properties

- 7 Click **OK**.
- 8 Click **OK**.

4-3-7 Lamp objects

The following lamp objects can be used:

- Bit lamp (💡)
Bit lamp objects are used to display the on and off state of a coil type tag.
- Word lamp (💡)
Word lamp objects are used to display multiple states (max. 32) depending of the value of the assigned address.

The most important properties for bit lamp objects are as follows:

- Tag Address
- Style (generic, images, etc.)
- On Text Colour

The most important properties for word lamp objects are as follows:

- Tag Address
- State Properties

Proceed as follows:

- 1 Click **Screen3**.
- 2 Click **Word Lamp** (💡).
- 3 Click on **Screen3**.
- 4 Click ... from **State Properties** in the property panel.
- 5 Click **Add State**.
- 6 Click **OK**.

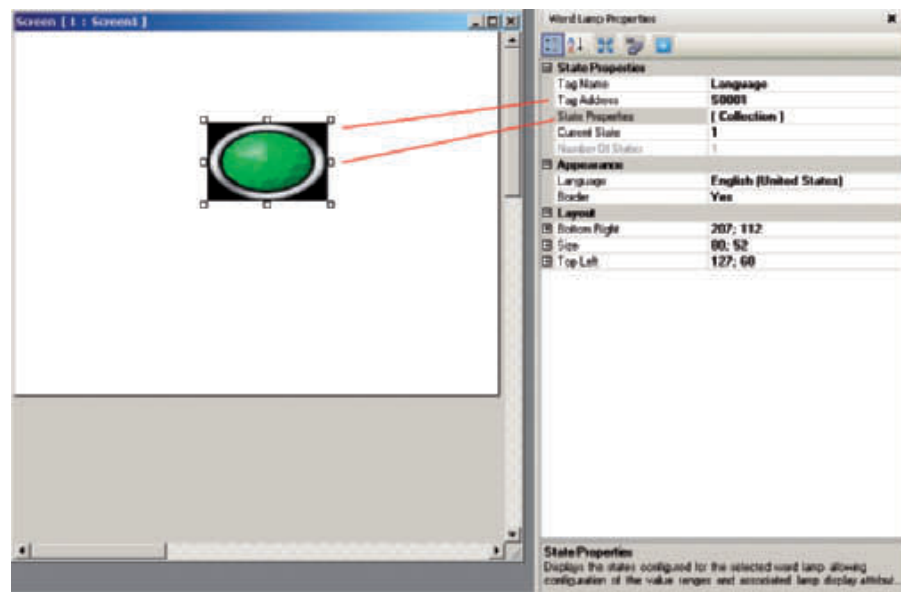







Figure 4.22: Lamp objects

4-3-8 Graphical objects

The following graphical objects can be used to draw objects and place pictures on the screen:

- Line ()
- Rectangle ()
- Ellipse ()
- Rounded rectangle ()
- Advanced picture ()

All imported pictures are converted to BMP before downloading the pictures to the NQ-Series. This means that GIF and JPEG pictures will be converted to BMP resulting in a bigger memory use.

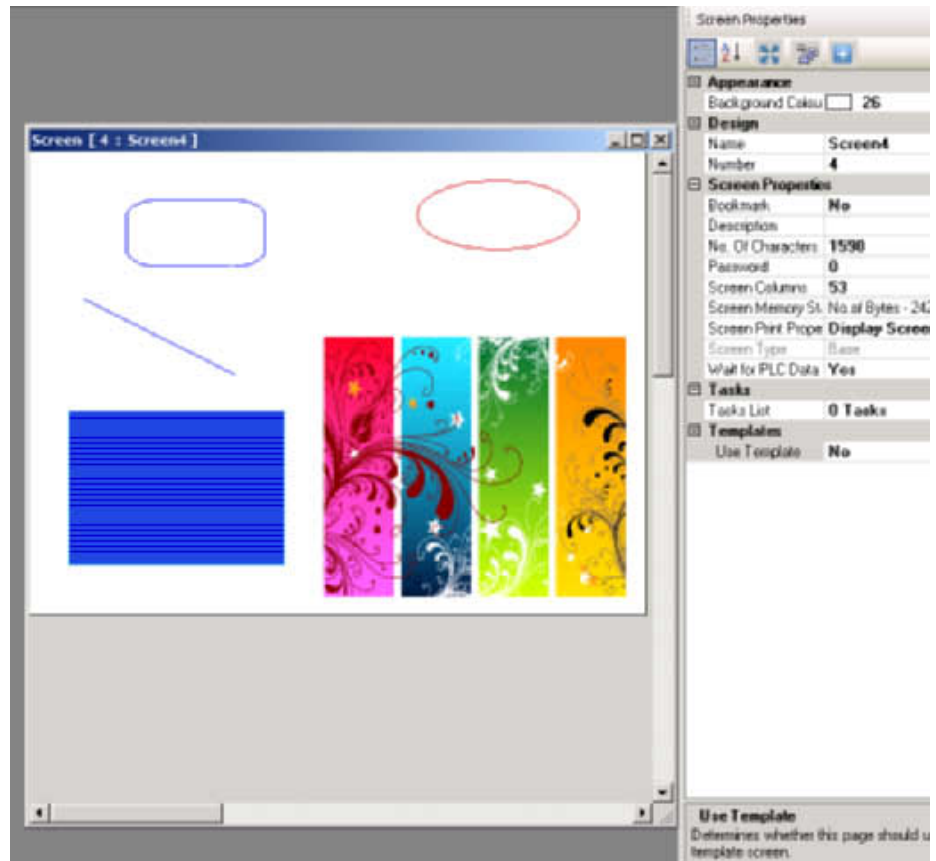







Figure 4.23: Graphical objects

4-3-9 Wizards

The following wizards can be used to add functionalities:

- Bar graph ()
To display a value by means of a bar.
- Multiple bar graph ()
To display values by means of max. 4 bars in one graphic. Each bar can be defined with different min. and max. values and assigned to different addresses. See image attached with multiple bar graph properties selected.
- Analogue meter ()
To display a value by means of a meter.
- Trend ()
To display a value over a period of time in a diagram.
- Historical Trend ()
To display the trend of logged data. This command can only be used if a tag is logged in data logging. A maximum of 4 logged tags can be shown in the historical trend.

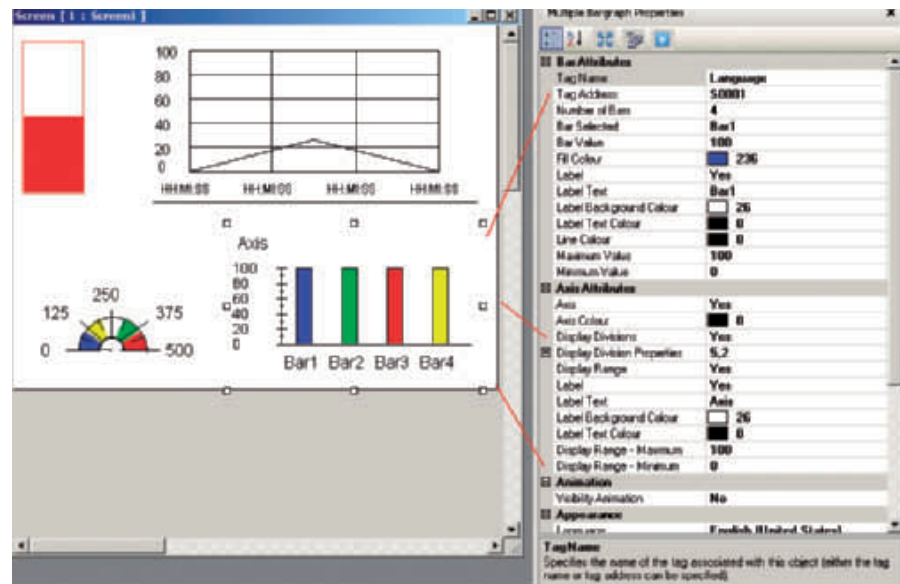



Figure 4.24: Wizards

4-3-10 Alarms

Alarm windows are created for displaying alarms on screen. The most important properties for alarms are as follows:

- Alarm Type (real time or historical)
- Select Display Fields (what is shown and order)

Proceed as follows:

- 1 Click **Screen**.
- 2 Click **Alarm** ().
To define the alarm see Alarms in 4-2-2-4 Project panel.
- 3 Click **Collection** from **Select Display Fields** in the property panel.
- 4 Select **On-Time and Off-time** and click **Add**. The order of data shown in the window can be configured here.

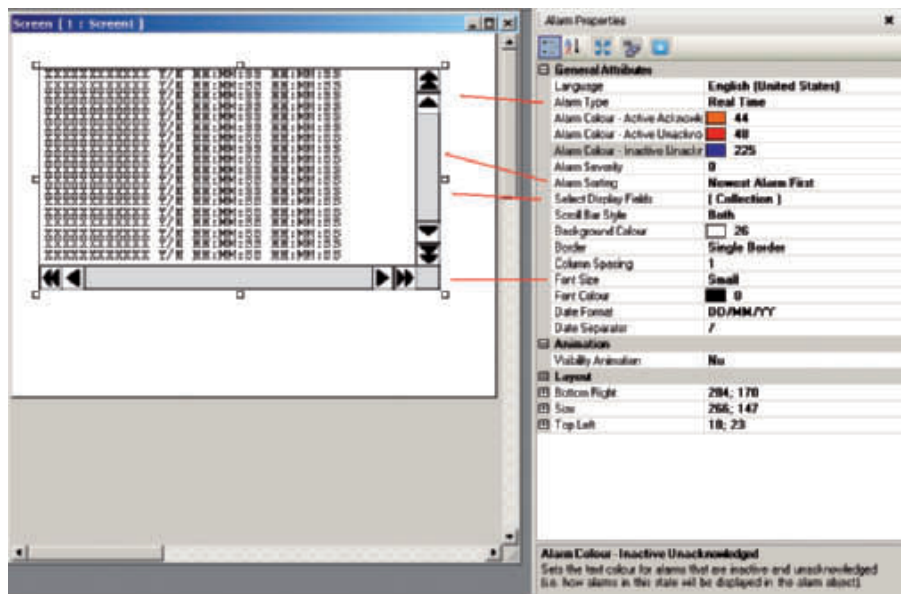



Figure 4.25: Alarms

- 5 Click **OK**.



The tool bar contains four predefined alarm buttons: two buttons for navigation and two buttons to acknowledge (). The acknowledge button acknowledges the first alarm shown in the alarm window. The navigation buttons are used to navigate through the alarm window.

4-3-11 Keypad

Keypads can be used on a popup screen or on the base screen. If used on a popup screen the keypad will behave exactly the same as the predefined keypads in NQ-Designer.

If the keypads are placed on a base screen where also an input is placed (select No keypad in the property box), the keypad will change the data of this input. If a keypad is placed on a base screen with more input fields it will change all input fields on that screen one by one. To enable the keypad on a base screen press **ENT** or one of the numeric keys. The first numerical input will start to flicker. Now you can start entering the data.

The following keypad can be used:

- Keypad ()
This keypad is a numeric keypad that provides different styles of displaying keypads.
- ASCII keypad ()
This keypad is an ASCII keypad. There are two keypad styles: ASCII (Style 1) and ASCII numeric (Style 2).
- Custom keypad ()
This keypad can be selected to create a custom numeric or ASCII keypad. The format can be freely chosen. This means merging keys, number of keys. Assignments for keys can be chosen in the property box.

4-4 Printing from NQ-Series

With the NQ-Series it is possible to print data on a serial printer. After adding the serial printer in the nodes folder (add node) it is possible to print, screen data, alarm messages and data logger information.

The printer will be visible in the nodes folder (added to network).

In the NQ-Series, application tasks can be assigned to perform the print actions.

Print screen data:

There are two ways to print screen data.

- Screen print properties from property list.
Selecting the option "print screen" or "print once and display screen" will print the screen information every time you navigate to this screen.
- A button or Function key with task "Print data". Every time the Function key or the button is pressed the screen data of the current screen will be send to the printer.

Print alarm messages:

While defining alarms you can select for each alarm, if this alarm should be printed (Alarm notification, check print box). Each time an alarm (bit) is changed and print box is checked the alarm data will be send to the printer.

The alarm data send to the printer is below fixed format:

Format = Time: Date: alarm number: alarm text: active /inactive:

Print data logger information:

In the Data Logger folder you can define four groups of tags to be logged. After adding tags in a group a button "Print Properties" is available to define the tags to be printed and the format.

Select in the Logged tags section the tags that you want to have printed. The tags selected will be visible in the Tags to be Printed window. You can change the header name, width, format for each the tag to be printed.

If required this can be repeated for each group.

To be able to print the correct information a time window must be defined. The definition of the window can be defined in tab "Start / end times for printing" in the Datalogger window

A data logger print action requires a button added to your screen and assign the "key specific task" Start Printing of Group. Define here the group to be printed.

Pressing this button will now print the data logger information within the timeframe you have defined in data logger section.

Text printed will be ASCII characters only.

4-5 Model conversion in NQ-Designer

In NQ-Designer it is possible to convert a created project for a "specific" model into a different model. This can be from NQ3 to NQ5 or from Serial to Ethernet. This tool allows you to convert a project created from 1 model to any other model of the NQ-Series products.

Example:

A NQ3-MQ000B application can automatically be converted to any other model from the NQ-Series (NQ3* or NQ5*). This includes serial to Ethernet, com1 to com 2, etc. The whole project will automatically be converted to the desired model / configuration.

How to use:

- Open the project to be converted
- Go to Project, Model conversion

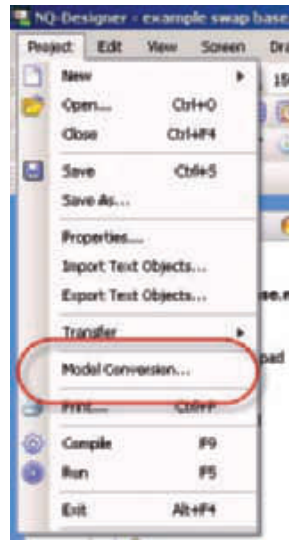

Figure 4.26: Model conversion

- A screen is displayed showing the model of your current application and drop down box to select the new model.

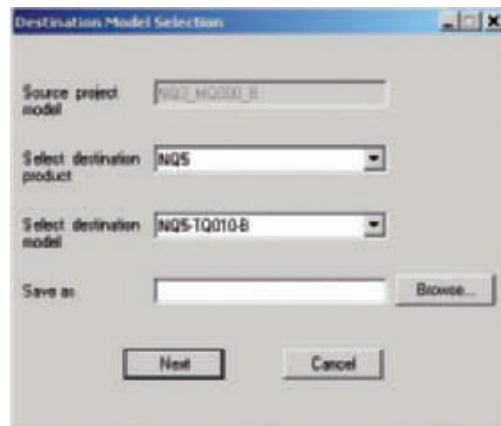

Figure 4.27: Destination Model Selection

- After selecting the new model you need to provide a name and destination for the saved project. ("save as" type should be nqp files (*.nqp))

Pressing "Next" button displays the selection made and a comparison of resolution of original model and new model.

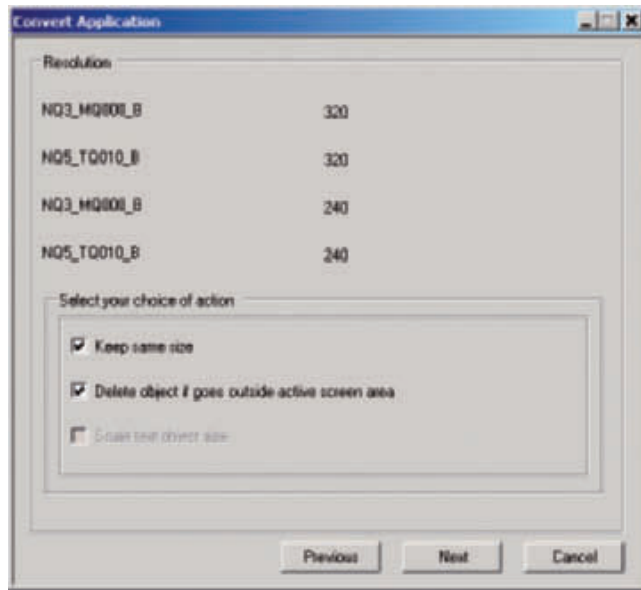

Figure 4.28: Convert Application

Important in this window are the option/check boxes with actions perform while converting. For horizontal model to horizontal model conversion these settings should not have any effect as all NQ-Series have the same resolution. When a conversion is made from horizontal to vertical with incorrect settings objects can be deleted, misplaced in the converted project.

- Pressing "Next" button displays the selection made and a comparison of colors supported.

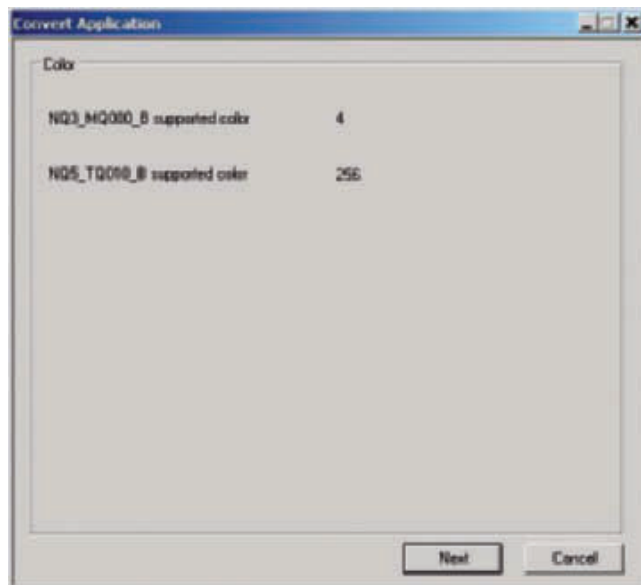

Figure 4.29: Convert Application

- Pressing "Next" will show you the communication port selection. Here you can select which communication port should be used in the new

application. Required here is to press "Add action" Selecting the communication port

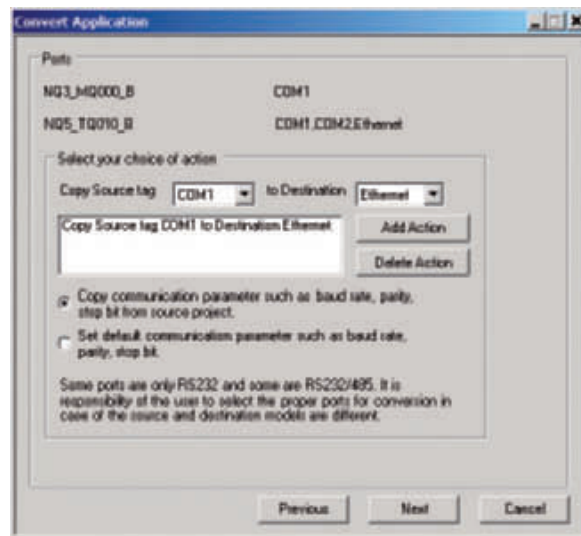

Figure 4.30: Convert Application

- Again pressing "Next" will show a screen where Fkeys (function keys) can be mapped. If original model and new model have the same number of Fkeys this area will be greyed out.

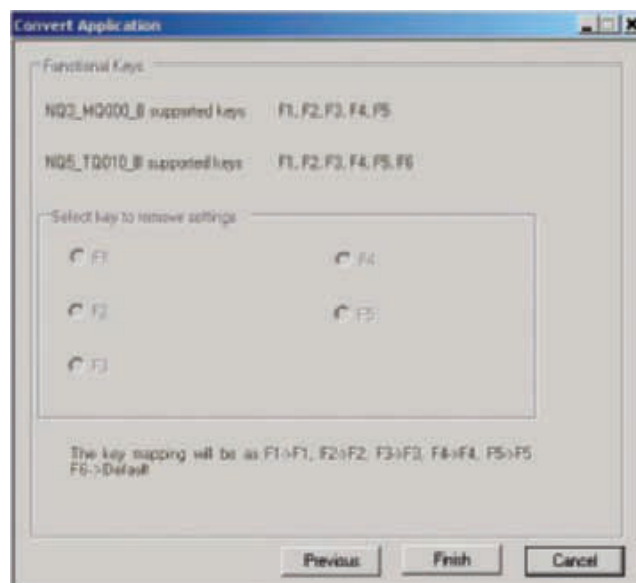

Figure 4.31: Convert Application

- Pressing "Finish" will start the conversion process. The project will be converted. After conversion the "new" application will be opened and ready for download. On the bottom you will see a message appear that firmware always needs to be downloaded to the terminal again.

4-6 Connecting NQ-Series to OMRON products

4-6-1 NQ-Series and FINS.

Supported protocol on the NQ*-TQ010B Ethernet terminals is the OMRON protocol FINS over UDP.

The NQ-Series can act both as client and server.

When operating the NQ-Series as server following commands are implemented:

- FINS Read memory 0101
- FINS Write memory 0102
- FINS Identification 0501

The internal Data memory (D) of NQ-Series is reserved for NQ-Series as server function. These addresses can be reached by requesting CIO FINS data.

Maximum 1000 addresses can be used to exchange data.

Sending FINS Identification (0501) command will return a string of 40 characters with Type name of terminal followed by V XX.YY . In which XX is..... and YY is.....

E.g. "NQ3-TQ010-B V01.00"

Relaying data to other networks using FINS:

FINS data can be relayed through different network. Details how to relay data can be found in OMRON manual W342-E* (reference manual, communication commands)

Below a screen shot of the screen which allows you to set these parameters.

4-6-1-1 NQ-Series with OMRON FINS over Ethernet to OMRON Ethernet modules.

To perform a successful communication to OMRON CJ2 or C*1W-ETN* modules proceed as follows:

1. Create a new project in NQ-Designer.
2. Select the correct model to be used.
3. Go to Ethernet tab and make there the proper settings for the Ethernet data for NQ-Series. Defaults displayed are factory settings of the NQ-Series.

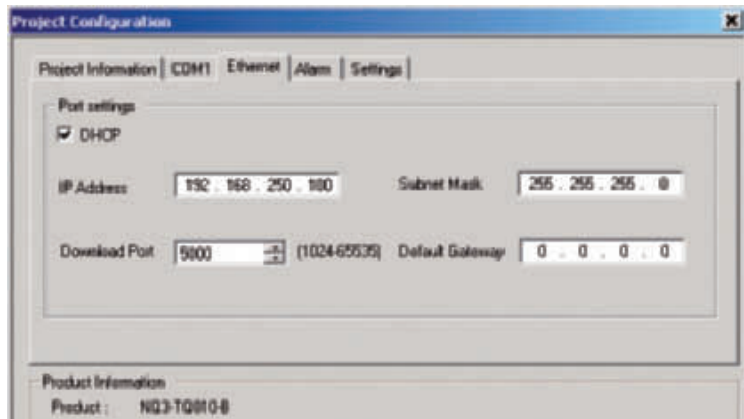

Figure 4.32: Project Configuration, Ethernet tab

4. Press OK.
5. A project is created.
6. Go to the nodes folder in the tree and ADD a node. Following screen will show.

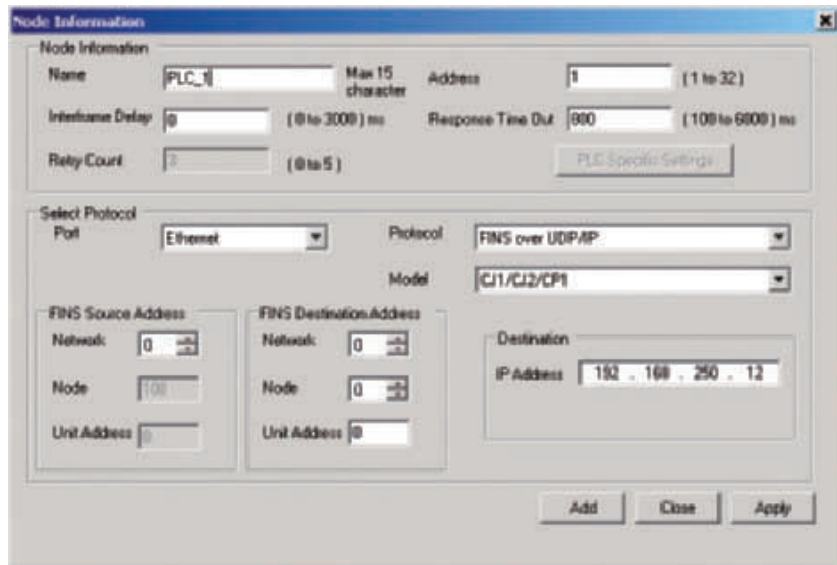

Figure 4.33: Node Information

7. Fill in the PLC name , if required
8. Port, select ETHERNET
9. Protocol , select FINS over UDP/IP
10. Model, select CJ1/CJ2/CP1
11. Destination, fill in here the IP address of your PLC you want to communicate with.
12. Click ADD
13. You have now made the settings for the NQ-Series (IP 192.168.250.100) to communicate with PLC (IP 192.168.250.12) using FINS.
14. Go to the taglist and create a PLC tag (HR000 as an example)
15. Goto screen 1, add a numerical input and assign it to HR 000

16. Download the application AND firmware to the NQ-Series using serial, USB or ethernet connection.

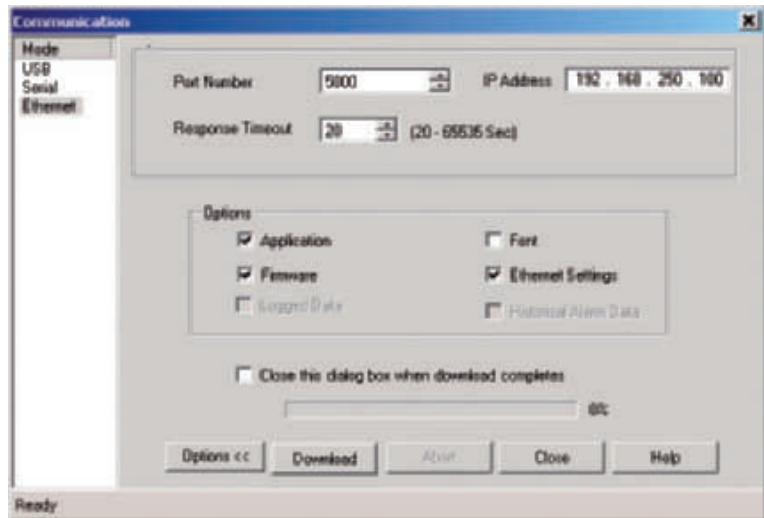

Figure 4.34: Communication, Ethernet

Note: If you have changed the Ethernet settings in Project configuration, you also need to download the Ethernet settings in the download windows. Downloading the data using the Ethernet connection be aware the IP and port number in the Download window are exactly the same as IP and port number of the NQ-Series. (Power on the NQ-Series and on startup the current IP address of the NQ-Series will be displayed)

- 17. Open CX-Programmer and connect to the CPU.
- 18. Click the IO table
- 19. Go to the Ethernet module and double click
- 20. Attached screen shot is for CJ2MCPU3* PLC

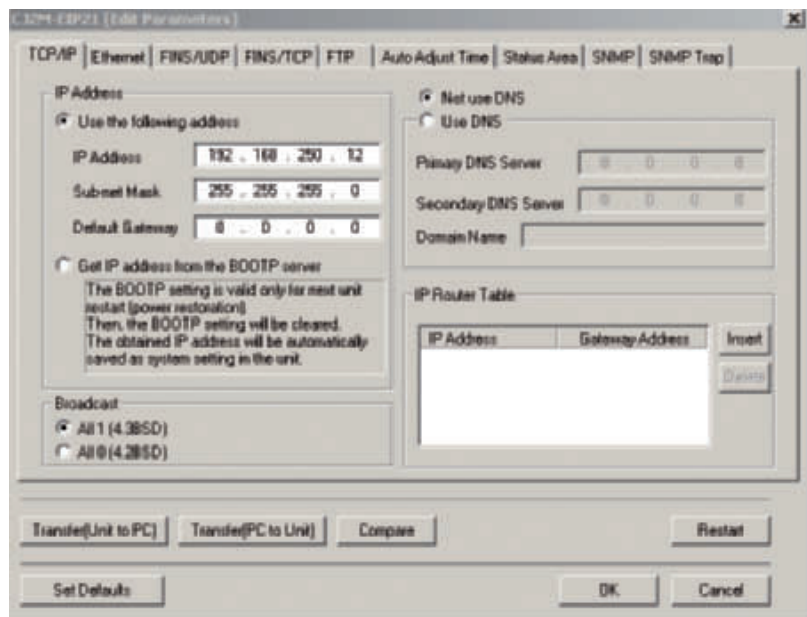

Figure 4.35: Ethernet module for CJ2MCPU3* PLC

21. Fill in the IP address and subnet mask as per screenshot. And transfer the data (PC to unit).
22. Connect the Ethernet cable to NQ-Series and PLC and connection is ready.
23. For verification of correct data you can Click Windows in View menu and select Watch
24. Enter here H0 and view if data is the same as on screen of NQ-Series, changing the Data on NQ-Series screen should affect the data of H0 in PLC.

Note The following messages are displayed on the NQ-Series screen if problems occur:

- !!!! no connection ,
- ??? connection established, address unknown

4-6-1-2 NQ-Series with OMRON FINS over Ethernet to Trajexia

To perform a successful communication to Trajexia TJ* modules proceed as follows:

1. Create a new project in NQ-Designer.
2. Select the correct model to be used.
3. Go to Ethernet tab and make there the proper settings for the Ethernet data for NQ-Series. Defaults displayed are factory settings of NQ-Series

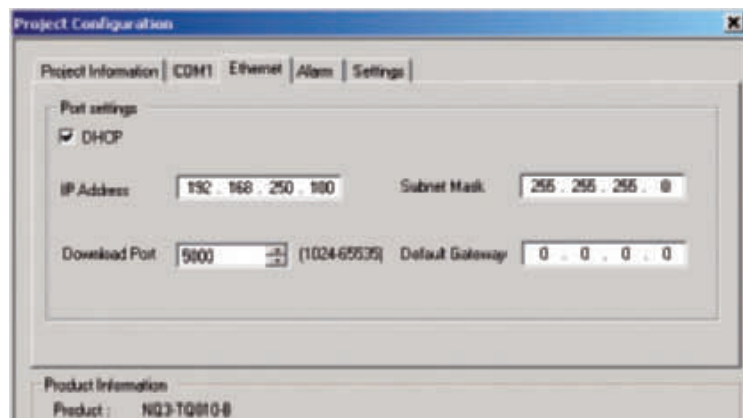

Figure 4.36: Project Configuration, Ethernet tab

4. Press OK.
5. A project is created.

- Go to the nodes folder in the tree and ADD a node. Following screen will show.

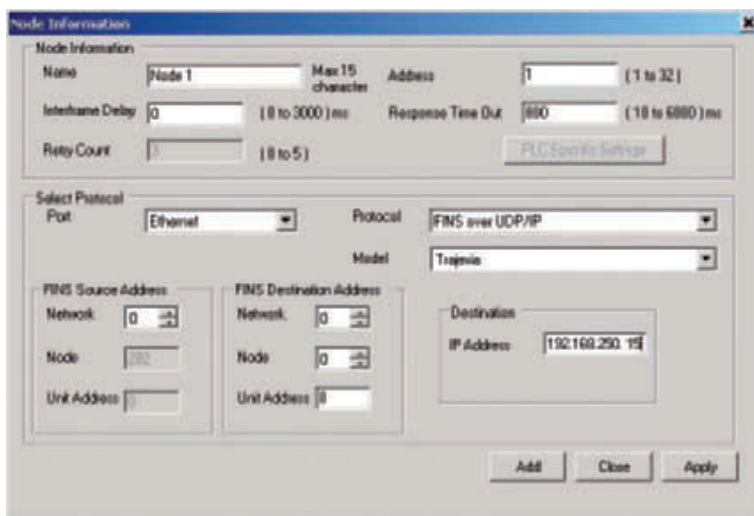

Figure 4.37: Node information

- Fill in the Trajexia name, if required
- Port, select ETHERNET
- Protocol , select FINS over UDP/IP
- Model, select Trajexia
- Destination, fill in here the IP address of your Trajexia you want to communicate with.
- Click ADD
- You have now made the settings for the NQ-Series (IP 192.168.250.100) to communicate with Trajexia (IP 192.168.250.15) using FINS.
- Go to the taglist and create a Trajexia tag (VR1000 as an example)
- Goto screen 1, add a numerical input and assign it to VR1000
- Download the application AND firmware to the NQ-Series using serial, USB or ethernet connection.

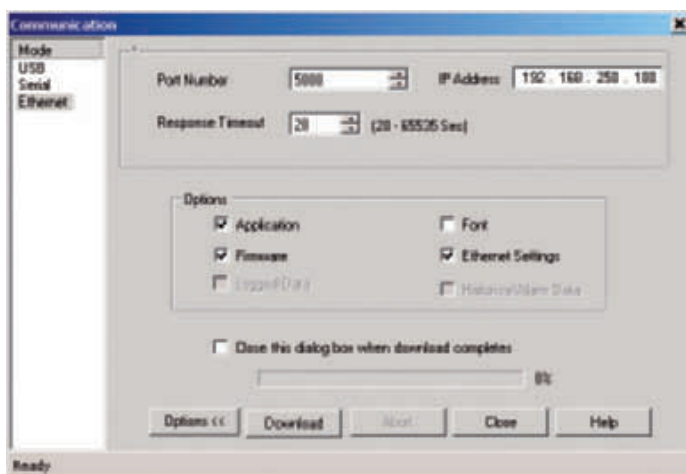

Figure 4.38: Communication, Ethernet

Note: If you have changed the Ethernet settings in Project configuration, you also need to download the Ethernet settings in the download windows.

Downloading the data using the Ethernet connection be aware the IP and port number in the Download window are exactly the same as IP and port number of the NQ-Series. (Power on the NQ-Series and on startup the current IP address of the NQ-Series will be displayed)

17. Open CX-Motion Pro and connect to the Trajexia.
18. Right click on device
19. Add the connected Trajexia
20. Doubleclick on the Trajexia icon

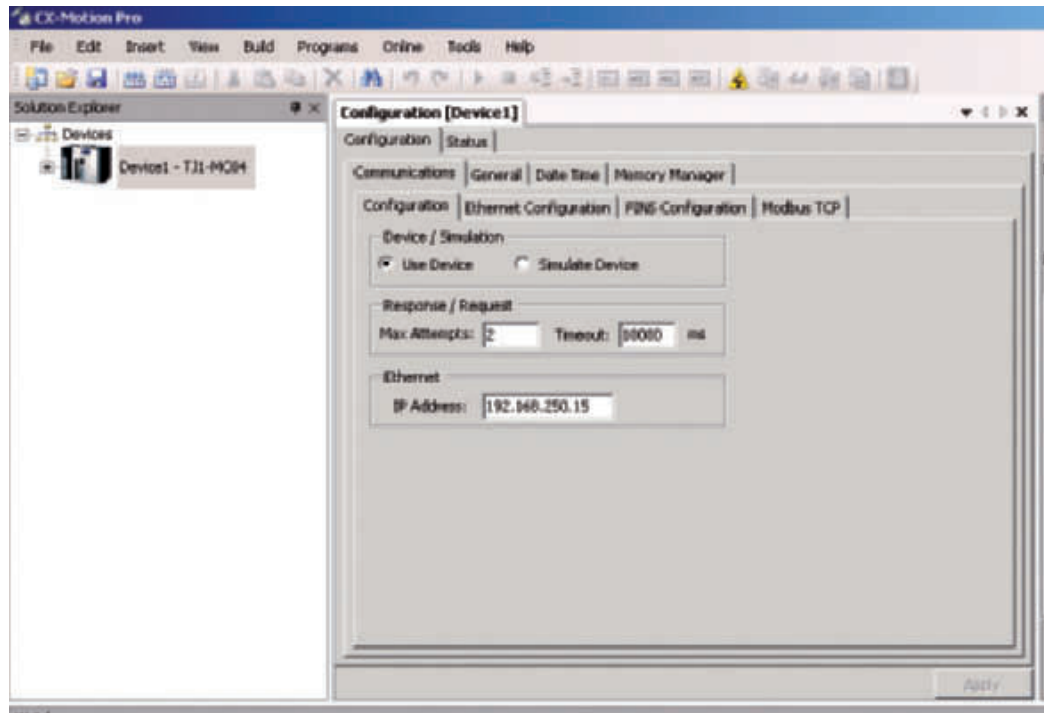



Figure 4.39: CX-Motion Pro, Configuration

21. Enter here the IP address for the Trajexia
22. Go online with Trajexia pressing 
23. Select monitor 

Note The following messages are displayed on the NQ-Series screen if problems occur:

- !!!! no connection,
- ??? connection established, address unknown

4-6-2 Using serial connection

For serial communication NQ-Series have serial ports (com1 and com2 (NQ5)). Using this port serial data can be exchanged via RS232 (com1 and com2) or RS422/RS485 (com1). Following examples describe how to set a working communication between NQ-Series and an Omron device.

4-6-2-1 NQ-Series with OMRON Host Link Driver to OMRON CP1L PLC

To perform a successful communication proceed as follows.

1. Create a new project in NQ-Designer.
2. Add a Hostlink **Node** and settings as below and click **Add...**



Figure 4.40: Project Configuration

3. Set all data as shown in the screenshot.
4. Create PLC tag with address **DM0000**.
5. Add a **Numerical Data Entry** object with tag address **DM0000** to **screen1**.
6. Download the application and firmware to the NQ-Series.
7. Open CX-Programmer.
8. Create a new project.
9. Select **CP1L** and click **OK**.
10. Double-click **Settings** in the project panel.
11. Click **Serial Port 1** tab.

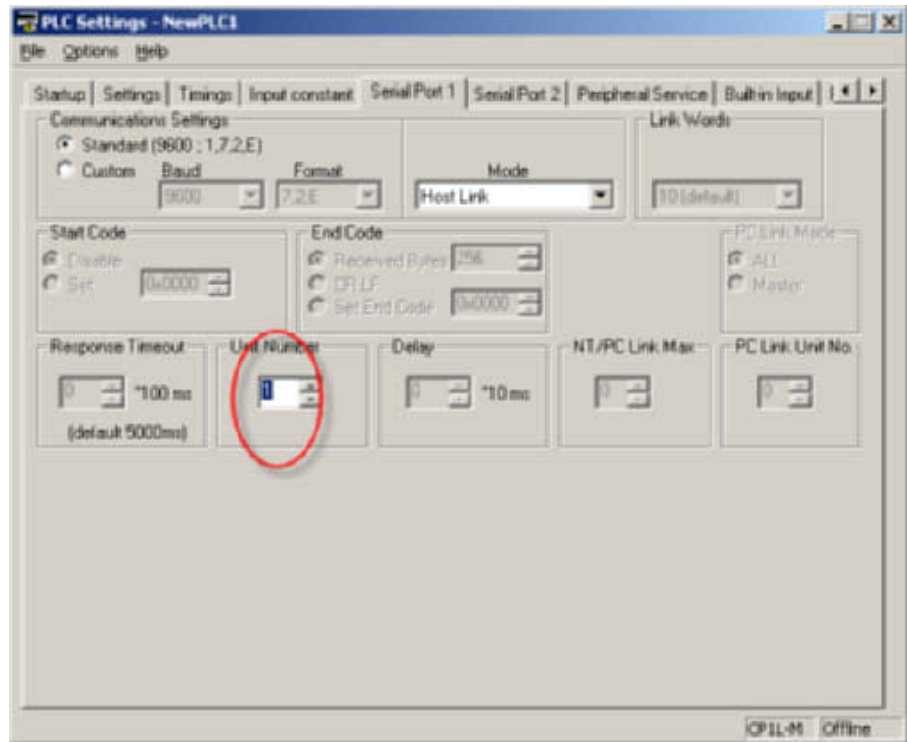

Figure 4.41: PLC Settings - New PLC

12. Set all data as shown in the screenshot.
13. Download the application into the PLC.
14. Click **Windows** in **View** menu and select **Watch**.
15. Enter **D0** in the first line in the **Watch** window.

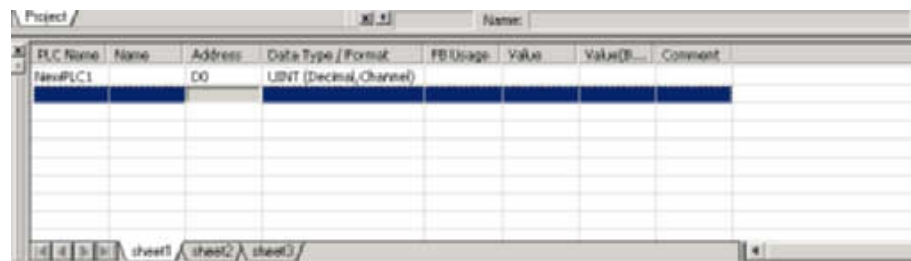

Figure 4.42: Watch window

16. Change Channel type to unit.
17. Connect the cable to the NQ-Series and PLC. Ensure the label on the cable corresponds with the NQ-Series and PLC (cable connectors are both male). Refer to A-1-2 NQ-Series to PLC (NQCN222 / NQCN521).
18. Check the blue LED. If the blue LED is steady on, a correct connection has been established.
19. Enter **345** on the NQ-Series screen. If the connection has been correctly established the same value is shown in the **Watch** window of CX-Programmer.

Note The following messages are displayed on the NQ-Series' screen if problems occur:

- !!! no connection
- ??? connection established, address unknown

4-6-2-2 NQ-Series with OMRON NT Link to OMRON CP1L PLC

To perform a successful communication proceed as follows.

1. Create a new project in NQ-Designer.
2. Add a NTlink **Node** and settings as below and click **Add...**

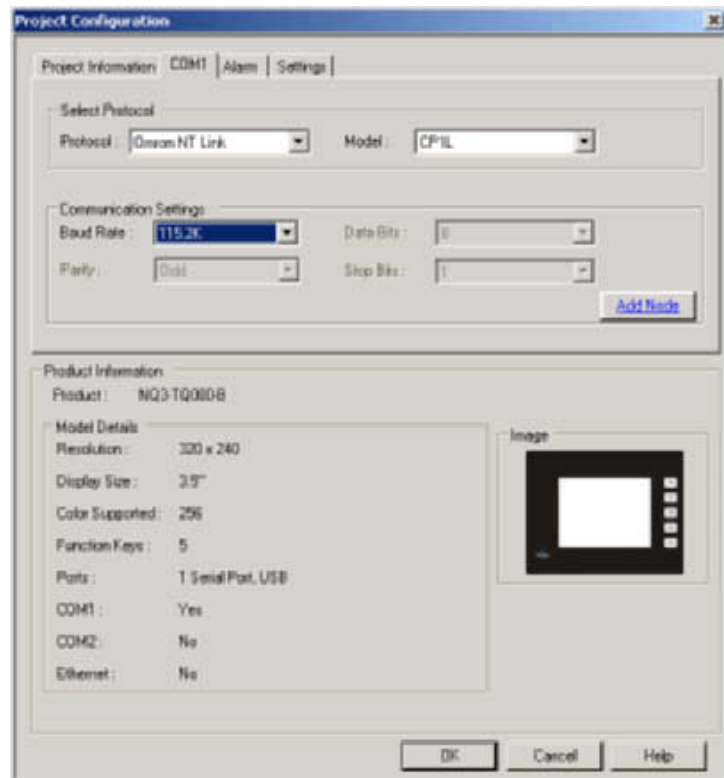

Figure 4.43: Project Configuration

3. Set all data as shown in the screenshot.
4. Create PLC tag with address **DM0000**.
5. Add a **Numerical Data Entry** object with tag address **DM0000** to **screen1**.
6. Download the application and firmware to the NQ-Series.
7. Open CX-Programmer.
8. Create a new project.
9. Select **CP1L** and click **OK**.
10. Double-click **Settings** in the project panel.

11. Click **Serial Port 1** tab.

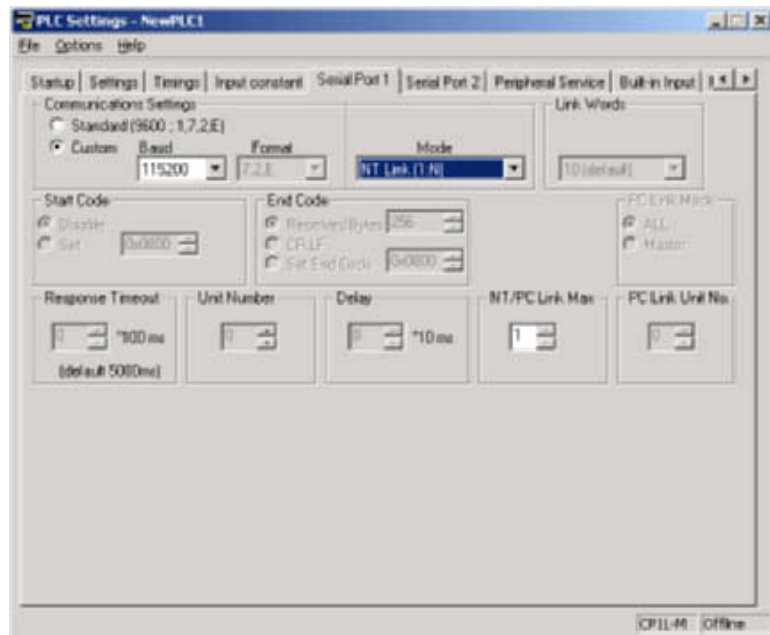

Figure 4.44: PLC Settings

12. Set all data as shown in the screenshot.

13. Download the application into the PLC.

14. Click **Windows** in **View** menu and select **Watch**.

15. Enter **D0** in the first line in the **Watch** window.

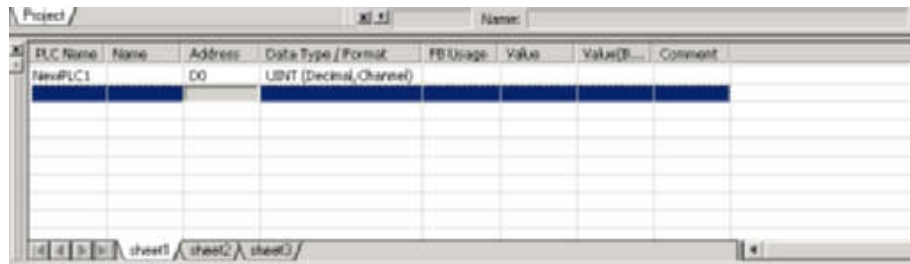

Figure 4.45: Watch window

16. Change Datatype to Uint

17. Connect the cable to the NQ-Series and PLC. Ensure the label on the cable corresponds with the NQ-Series and PLC (cable connectors are both male). Refer to A-1-2 NQ-Series to PLC (NQC222 / NQC521).

18. Check the blue LED. If the blue LED is steady on, a correct connection has been established.

19. Enter **89** in the NQ-Series' screen. If the connection has been correctly established the same value is shown in the **Watch** window of CX-Programmer.

Note The following messages are displayed on the NQ-Series' screen if problems occur:

- !!! no connection
- ??? connection established, address unknown

4-6-2-3 NQ-Series to OMRON Memobus inverter

To perform a successful communication between NQ-Series combined with OMRON Memobus inverter proceed as follows. The example shown is applicable for V1000. The addresses and parameter settings can vary depending on the choice of the Memobus inverter (not V1000).

1. Create a new project in NQ-Designer.
2. Right-click the **Nodes** folder and click **Add...**

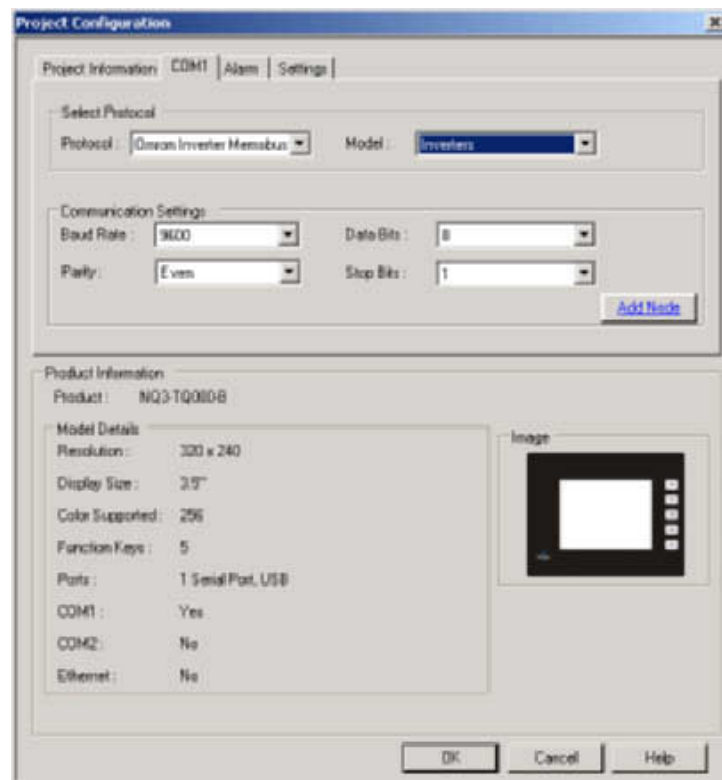

Figure 4.46: Project configuration

3. Set all data as shown in the screenshot.
4. Press OK
5. Go to nodes folder
6. Click on Modbus RTU node
7. Click on PLC specific settings
8. Make sure that the defined "default" communication register is an existing register in your Modbus slave or the communication will NOT be initiated (see note).
9. Create a tag with address **HR401061**
10. Add a display data numeric object with tag address **HR401061** on **screen1**
11. Download the application and firmware to the NQ-Series.
12. Press down button on the inverter until PAr is shown on the inverter's display.
13. Press enter.
14. Set the following parameters:
 - B1-01=2
 - H5-01 = 1 (node 1)

- H5-02 = 3 (9600 bps)
- H5-03 = 1 (even parity)
- Stop bit and Data Length are fixed as 1 and 8 respectively (refer to manual).
- H5-07 = 1 (RS-422 connection).

15. Switch off the inverter.

16. Create a cable. Refer to A-1-4 NQ-Series to inverter (V1000, RS-422 connection).

17. Connect the cable to the NQ-Series and inverter.

18. Switch on the inverter.

19. If the connection has been correctly established the node number shown on the NQ-Series.

- Note**
- H5-07 = 0 (RS-485 connection): Create the applicable cable. Refer to (V1000 RS-485 connection) A-1-5.
 - NQ-Series establishes a connection to the inverter by exchanging a default address **HR400001**. If this address is not available in the used inverter, the connection will not be established. To establish the connection proceed as follows.
 - 1 Click in the **Nodes** folder and right-click the Node1 inverter.
 - 2 Click **Edit**.
 - 3 Click **PLC Specific Setting**.

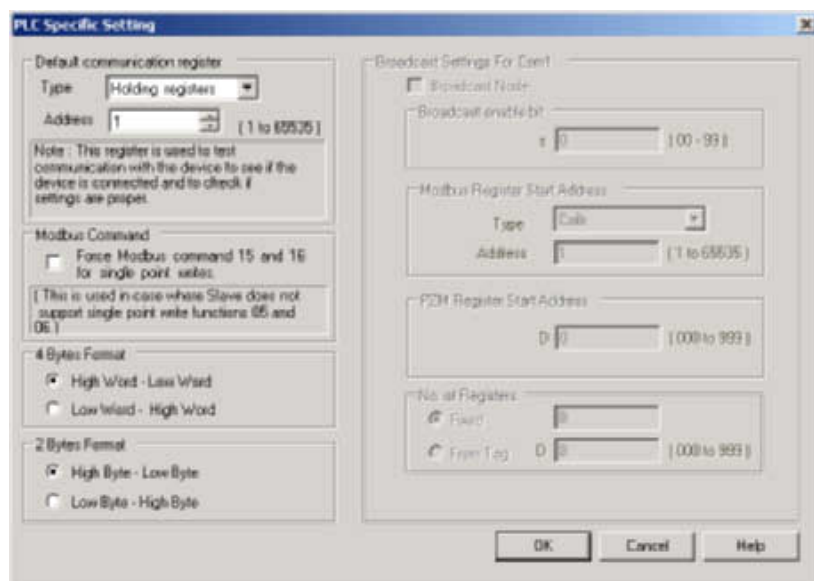

Figure 4.47: PLC Specific Setting

- 5 Change **Default communication register** address to an available address in the inverter.
 - 6 Click OK.
 - 7 Download the application to the NQ-Series.
- The following messages are displayed on the NQ-Series' screen if problems occur:
 - !!! no connection
 - ??? connection established, address unknown

4-6-2-4 NQ-Series to CelciuX° (EJ1N) Temperature Controller (ModBus RTU)

To perform a successful communication proceed as follows. The example shown is applicable for EJ1.

1. Create a new project in NQ-Designer.
2. Right-click the **Nodes** folder and click **Add...**



Figure 4.48: Project configuration

3. Set all data as shown in the screenshot.
4. Press OK
5. Go to nodes folder
6. Click on Modbus RTU node
7. Click on PLC specific settings
8. Make sure that the defined "default" communication register is an existing register in your Modbus slave or the communication will NOT be initiated.
9. Create a tag with address Holding register 513. (400513).
10. Add a **Numerical Data Entry** object with tag address 400513 on **screen1**
11. Download the application and firmware to the NQ-Series.
12. Set Unit number to 1 on EJ1(rotary switch).
13. Set the following dipswitches on TC module:
 - SW2 dipswitch 3 to ON
 - SW2 dipswitch 4 to OFF
 - SW2 dipswitch 5 to OFF
14. Switch on the EJ1 temperature controller.
15. Create a cable. Refer to A-1-6 NQ-Series to CelciuX° (EJ1N) temperature controllers (RS-485 connection).
16. Connect the cable to the NQ-Series and EJ1C-EDUA-NFLK

17. Displayed on your screen will be now the " Channel 1 Process Value)

18. Correct data can be monitored by connecting CX-Thermo to your EJ1.

Note The following messages are displayed on the NQ-Series' screen if problems occur:

- !!! no connection
- ??? connection established, address unknown

SECTION 5

Transferring programs

This section describes how to transfer NQ-Designer programs to NQ-Series models.

5-1 Downloading.....	72
5-2 Uploading	74
5-3 USB host functionality	76

5-1 Downloading

A project can be downloaded from NQ-Designer to the NQ-Series. A project always consists at least of an Application and Firmware.

5-1-1 Downloading options

The following options can be selected:

- Application
- Firmware
- Font
- Ethernet settings

5-1-1-1 Application option

If this option is selected, only the application will be downloaded to the NQ-Series.

5-1-1-2 Firmware option

If this option is selected the firmware will be downloaded to the NQ-Series.

This option is necessary if:

- The firmware is downloaded to the NQ-Series for the first time.
- A PLC is either added or deleted in the network configuration.
- The firmware is updated with a newer version.
- Applications that are created in an older NQ-Designer version are downloaded to the NQ-Series.
- Changes made in Datalogger configuration.

5-1-1-3 Font option

If this option is selected the fonts will be downloaded to the NQ-Series.

This option is necessary if the default fonts have been modified.

5-1-1-4 Ethernet settings option

If this option is selected the ethernet settings of the NQ-Series defined in Project configuration, Ethernet will be send to the NQ-Series. This should always be downloaded into the NQ-Series when any modification is made in this screen.

5-1-2 Downloading applications

To download an application proceed as follows.

- 1 Click **Download** ().

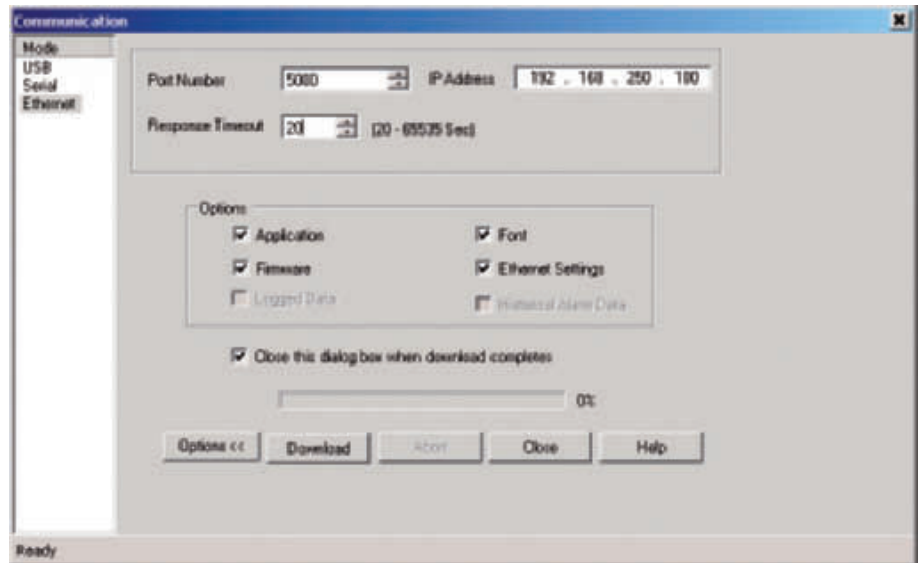

Figure 5.1: Download window

- 2 Select the required options and settings.(USB, application (project), FW, Font).
- 3 Click **Download**.

When selecting Ethernet make sure that the port number and IP address match the settings currently stored in the NQ-Series. Shown in the download window are the default settings stored in the NQ-Series.

The download screen shows a progression bar. When the download is finished a message “Download completed” will be shown on screen.

Note

Removing the communication cable during a download will result in a loss of data in the NQ-Series. All (firmware and application) needs to be downloaded again).

5-1-3 Download errors

The following errors can occur during downloading applications:

- Product mismatch
- NQ-Series is not responding
- Port is either busy or does not exist

A product mismatch error occurs if an application is not compatible with the NQ-Series attached.

If the NQ-Series is not responding this indicates that no communication has been established between the PC and the NQ-Series. Please check the following:

- The NQ-Series is connected to the PC.
- The NQ-Series is connected to the selected port (serial or USB).
- The port is working properly.
- The NQ-Series is not powered down.

5-2 Uploading

An existing application can be uploaded from the NQ-Series to NQ-Designer. During the upload process the communication to the PLC is disconnected. After the Upload has finished the NQ-Series will restart.

5-2-1 Uploading options

The following options can be selected:

- Application
- Logged Data
- Historical alarm data

5-2-1-1 Application option

If this option is selected, only the application will be uploaded from the NQ-Series to NQ-Designer.

Tag names and screen names are only uploaded if **Downloading Tag names** is selected on the **Settings** tab on the **Project Configuration** dialog. If this option is not selected the tag names and screen names are uploaded with default names.

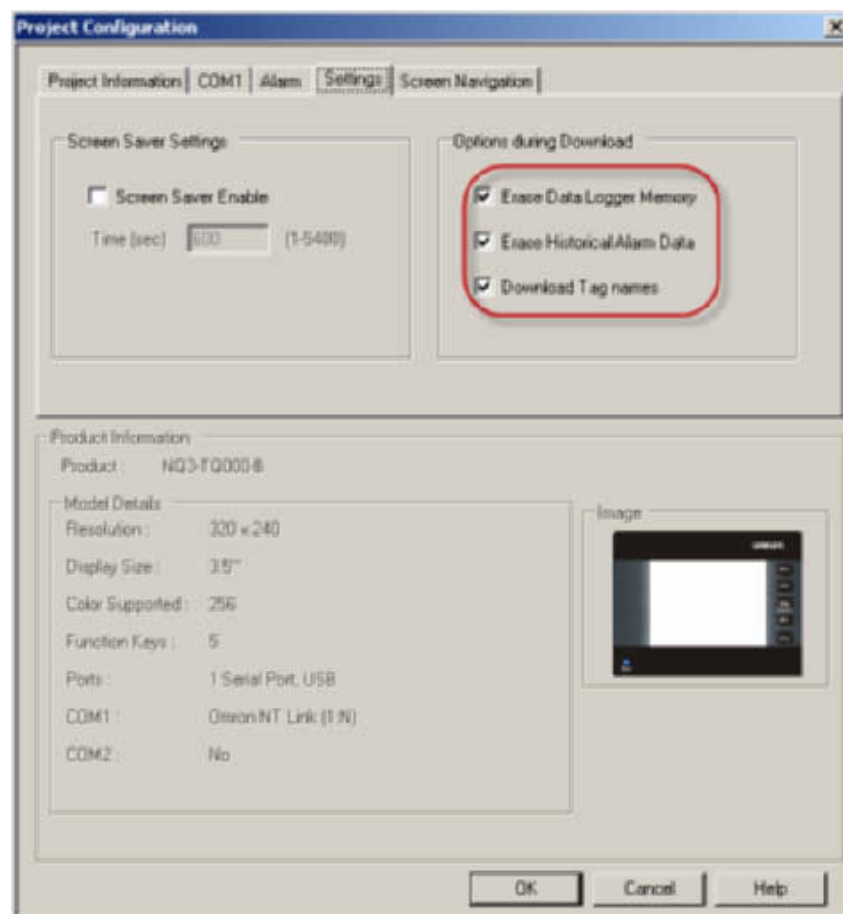

Figure 5.2: Project configuration

5-2-1-2 Logged Data option

If this option is selected, only the logged data will be uploaded from the NQ-Series. The logged data is displayed in CSV format.

To display the logged data click **Display Logged Data...** on the **Tools** menu.

5-2-1-3 Historical alarm data option

If this option is selected, only the Historical alarm data will be uploaded from the NQ-Series. The logged data is displayed in CSV format.

To display the historical alarm data click **Display Historical alarm Data...** on the **Tools** menu.

5-2-2 Uploading programs

To upload a program from the NQ-Series proceed as follows.

- 1 Click **Upload** ().

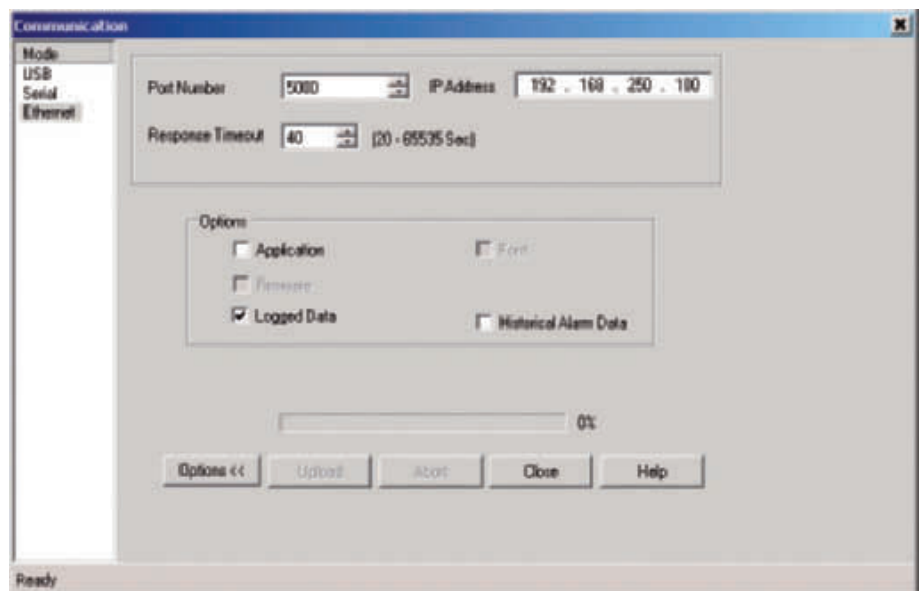

Figure 5.3: Upload communication

- 2 Select the required options and settings.
- 3 Click **Upload**.

When selecting Ethernet make sure that the port number and IP address match the settings currently stored in the NQ-Series. Shown in the download window are the default settings stored in the NQ-Series.

5-2-3 Uploading errors

The following errors can occur during uploading programs:

- NQ-Series is not responding
- Port is either busy or does not exist

If the NQ-Series is not responding this indicates that no communication has been established between the PC and the NQ-Series. Please check the following:

- The NQ-Series is connected to the PC.
- The NQ-Series is connected to the selected port (serial or USB).
- The port is working properly.
- The NQ-Series is not powered down.

5-3 USB host functionality

The USB host port can be used to perform a download or an upload of an application to or from an USB stick. This enables the user to update the NQ-Series or download logging data without the use of a Personal computer.

The NQ-Series only supports USB sticks that are formatted FAT or FAT32.

Note

Make sure to backup all data on the USB stick before connecting it with the NQ-Series.

To establish a connection between the USB stick and the NQ-Series proceed as follows:

- 1 Place the USB stick in the USB host port.
- 2 An **empty** NQ-Series (no application or no firmware) will automatically start the USB Host function when the NQ-Series detects an USB stick.
- 3 When running an application setting system bit s037 to 1 will start USB host function provided the USB stick is connected.

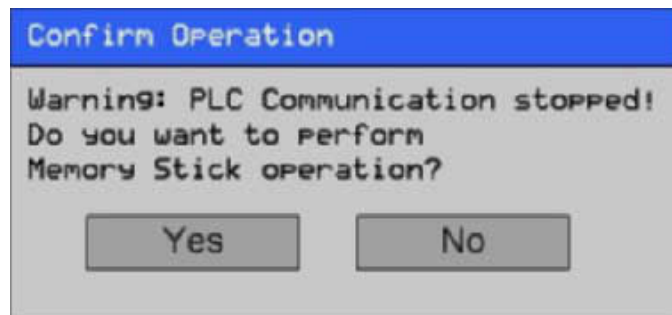

Figure 5.4: USB host functionality confirmation

- 5 Click **YES** to continue.

Please wait..
Enumerating Memory Stick

Figure 5.5: Enumerating memory stick

- 6 Click **Download** or **Upload**.

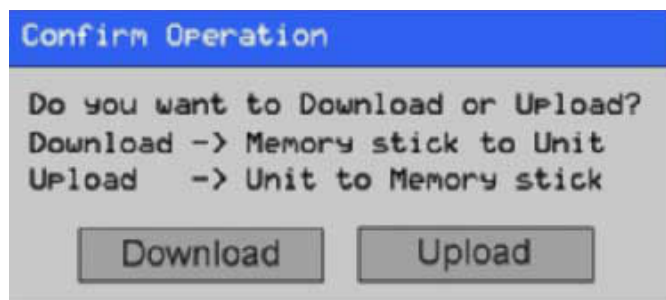

Figure 5.6: Confirm operation

5-3-1 Downloading from USB stick to NQ-Series

In order to correctly download an application from the USB stick to the NQ-Series the following files must be present in the project folder (NQxxQxxx, e.g. NQ3TQ000 for NQ3-TQ000B HMI.

- Application file (NQx-xQxxx-B_APP.NQP)
- Firmware file (NQx-xQxxx-B_FW.ABS)
- Font file (NQ_FONT_File.BIN)

This folder and contents can be found in the saved project location on your Personal Computer.

The following data can be downloaded to the NQ-Series.

- Application
- Firmware
- Fonts

- 1 Connect the USB stick to the NQ-Series.
- 2 Click **Download**.

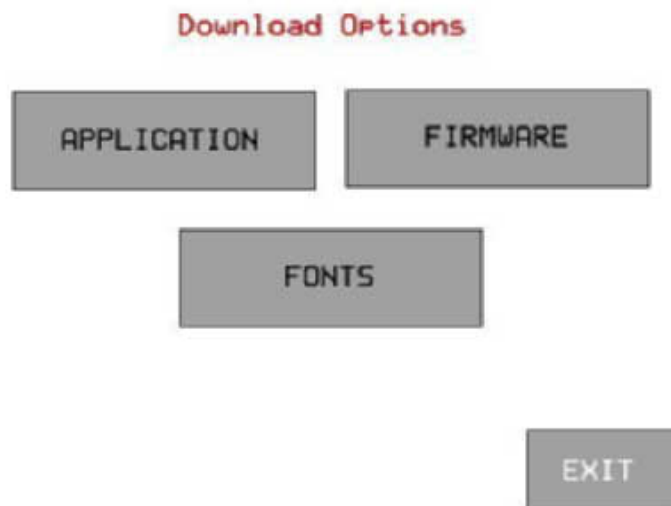

Figure 5.7: Download options

- 3 Click **APPLICATION** to erase the old application and download the new application from the USB stick to the NQ-Series.

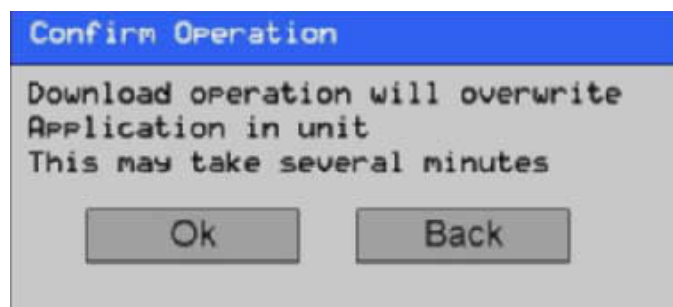

Figure 5.8: Confirm operation

- 4 The following message is displayed after downloading.

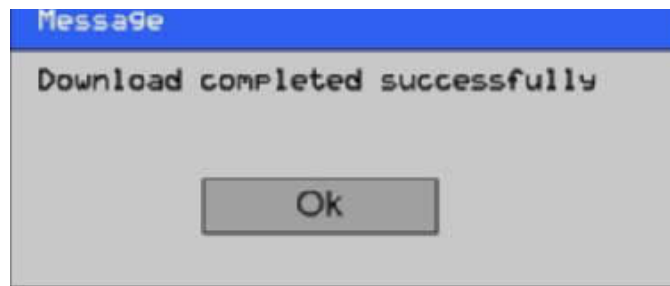

Figure 5.9: Download completed

Click **OK** to finish.

Now you can repeat step 3 and 4 for firmware and fonts.

5-3-2 Uploading from NQ-Series to USB stick

In NQ-Designer it is possible to upload the datalogger and Historical alarm data to an USB stick.

Two different methods can be used:

- Running on background of application (*.CSV output)
- Invoke application to upload the files (*.BIN output, NQ-Designer required)

Uploading your log files to USB stick on the background NQ-Designer provides you with 2 options in your program.

Option 1: Trigger and monitor the upload process from PLC / NQ-Series

In TASK, Global task section you find commands "Upload All logged data to USB stick" and "Upload Historical Alarm data to USB Stick". Defining here the control bit and status word you can set and monitor the actual upload of the log files. The status register will also contain the error code if a download is not working correctly.

Option 2: Button task function.

The advanced button contains tasks "USB Data Log Upload and USB Historical Alarm Upload" The control bit here is the button , the status register selected can only be a NQ-Series register.

For uploading application or firmware a running program must be invoked.

Additional method provided can also upload the datalogger and Historical Alarm data.

Access to below described function is only possible if system bit s0037 is set to high and USB stick is connected.

The following data can be uploaded from the NQ-Series to the USB Stick

- Application
- Firmware
- Application + logged data
- Application + Historical alarm data
- Fonts

- 1 Connect the USB stick to the NQ-Series.
- 2 Click **Upload**.

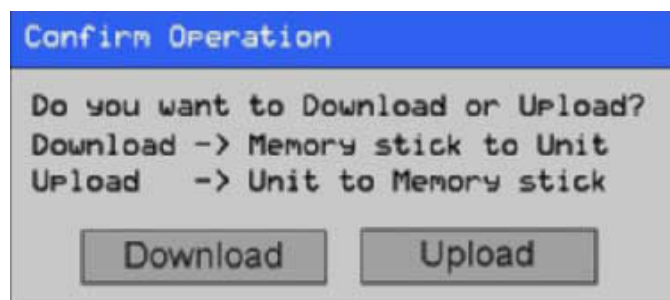

Figure 5.10: Confirm operation

- 3 Click **APPLICATION** to upload the new application from the NQ-Series to the USB stick.

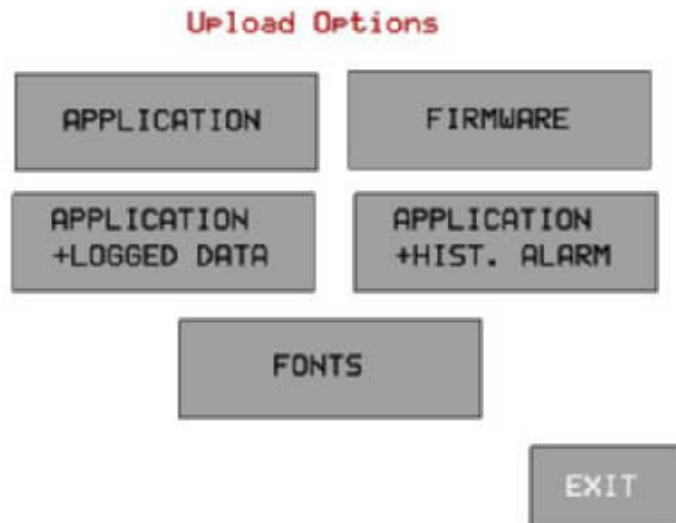

Figure 5.11: Upload option

- 4 The following message is displayed after uploading.

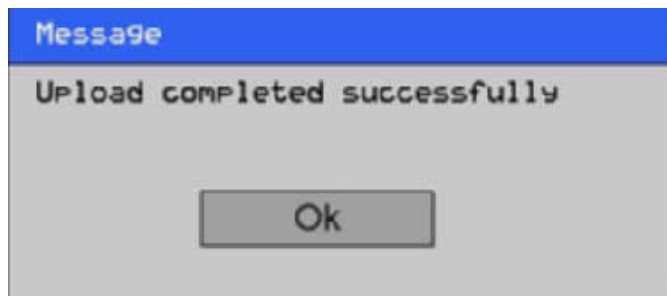

Figure 5.12: Upload completed

Click **OK** to finish.
Repeat step 3 and 4 if you need to upload any of the other options also need to be uploaded to the USB stick.

SECTION 6

Simulation and debugging

This section describes how to simulate NQ-Series programs and debug programs.

6-1 Simulation.....	82
6-2 Debugging.....	82

6-1 Simulation

Click () to start simulation.

With the simulation function you can simulate your project on your Personal Computer.

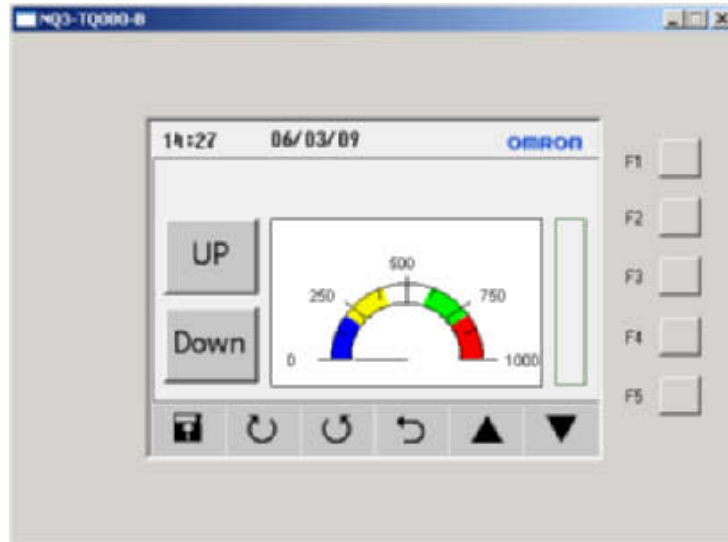

Figure 6.1: Simulation

Not supported in simulation is:

- PLC communication (PLC tags are not handled and remain 0)
- Set RTC (RTC viewing is supported, PC clock is displayed)
- Data logging
- Historical Trends
- Historical alarms

6-2 Debugging

For debugging your NQ-Series you can use an internal program inside the NQ-Series.

The debugging program (**FWHT**) allows you to test all HW sections within your NQ-Series.

To start **FWHT**, please look at 7-4-1 FHWT.

SECTION 7 Maintenance

This section describes the maintenance and factory application of the NQ-Series.

7-1 Erasing keys.....	84
7-2 Touch screen calibration	85
7-3 Troubleshooting.....	86
7-4 NQ-Series diagnostics.....	87

7-1 Erasing keys

If necessary, It is possible to erase an application or firmware in the NQ-Series. The corners of the touch screen are used for erasing.

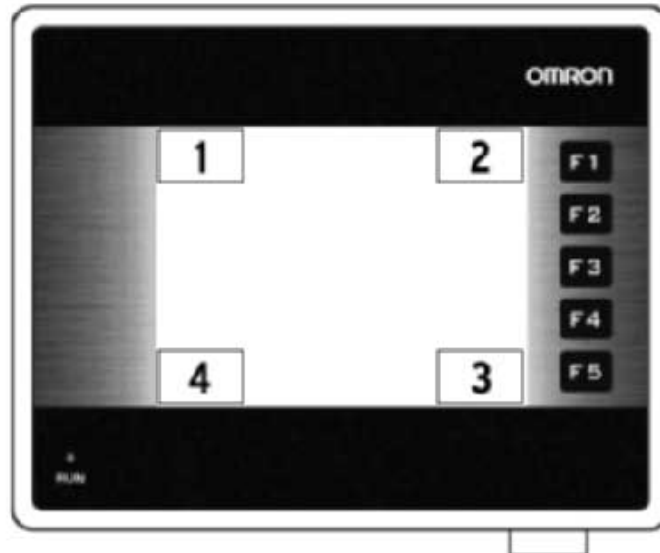

Figure 7.1: Erasing keys

- 1 Erase firmware
- 2 Erase application
- 3 Confirm
- 4 Starting FWHT and system set-up

To erase an application proceed as follows.

- Press the top right corner of the touch screen for 2 seconds during power-on.
- The following message is displayed: **Application Erase Mode... Press at Bottom Right corner to confirm.** Press the bottom right button to confirm.
- After erasing the program the following message is displayed: **No setup loaded. Download application.**

To erase the firmware proceed as follows.

- Press the top left corner of the touch screen for 2 seconds during power-on.
- The following message is displayed: **Firmware Erase Mode... Press at Bottom Right corner to confirm.** Press the bottom right button to confirm.
- After erasing the firmware the following message is displayed: **No firmware.... Download firmware.**

If the NQ-Series does not function correctly, erase the application and download a demo program. If the NQ-Series functions correctly, it is possible the previous application was incorrect.

7-2 Touch screen calibration

The touch screen is already calibrated. The calibration data is stored in the flash memory of the NQ-Series. Touch screen calibration is necessary if the user encounters the following problems:

- Any press inside a defined object boundary does not result in the expected action.
- An undefined area performs a task of some other defined object.

To calibrate the touch screen proceed as follows.

For accurate calibration use a stylus or wooden pencil.

- Press the centre of the touch screen for more than 2 seconds during power-up.
- A cross is displayed at the bottom in the left corner. This cross remains on the touch screen for approximately 4 seconds. If the centre of the cross is not pressed at this moment, the NQ-Series resumes to normal operation. Touch the centre of the cross with a pointed object (stylus).

Keep pressing until the NQ-Series reports valid point.

- The next screen is displayed with a cross at the top right corner of the touch screen. This cross remains on the touch screen for approximately 4 seconds. If the centre of the cross is not pressed at this moment, the NQ-Series resumes to normal operation. Touch the centre of the cross with a pointed object (stylus).

Keep pressing until the NQ-Series reports valid point.

- A successful calibration always results in a message **Calibration completed....restarting!!!** on screen.

7-3 Troubleshooting

Problems and errors are shown in two ways:

- With blue Run LED
- With self-diagnostic messages

7-3-1 Run LED

The Run LED on the touch screen is used to show the status, problems, and/or errors in the NQ-Series.

If the Run LED is on, the NQ-Series is functioning correctly and an application is downloaded into the NQ-Series. If the Run LED is off and stays off, even after touching the screen, the power to the NQ-Series is not correct. Check the cable connections and/or power supply.

Table 7.1: Run LED status

LED	Backlight	Action	Status/Solution
OFF	OFF	Press the touch screen. The backlight does not come on.	Failure in the power supply. Check the power supply and connections.
OFF	ON	Check the LED bit 36. The LED bit s36 is turned off.	The LED status bit s36 is turned off. Turn the LED status bit s36 on.
ON	OFF	Press the touch screen. The backlight comes on.	The NQ-Series is in screen saver mode.
ON	ON	-	The NQ-Series is in normal operation
ON (flashing slow)	ON	-	The NQ-Series is working correctly and is downloading or uploading.
ON (flashing fast)	ON	-	The NQ-Series is in normal operation but can not establish communication with one or more 'PLC' nodes

7-4 NQ-Series diagnostics

The NQ-Series' firmware contains a special application to test the NQ-Series' functions and to set the NQ-Series.

The following tools can be used for standalone NQ-Series diagnostic.

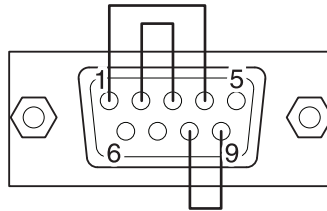

Figure 7.2: Loopback connector RS-232/RS-485/RS-422 for testing the serial ports

To access the special application proceed as follows.

- 1 Download a firmware and an application in the the NQ-Series. (This can be an empty project.)
- 2 Press (5 seconds) lower left corner of touch screen during power up of the NQ-Series. Wait for approximately 5 seconds until the following screen is displayed.

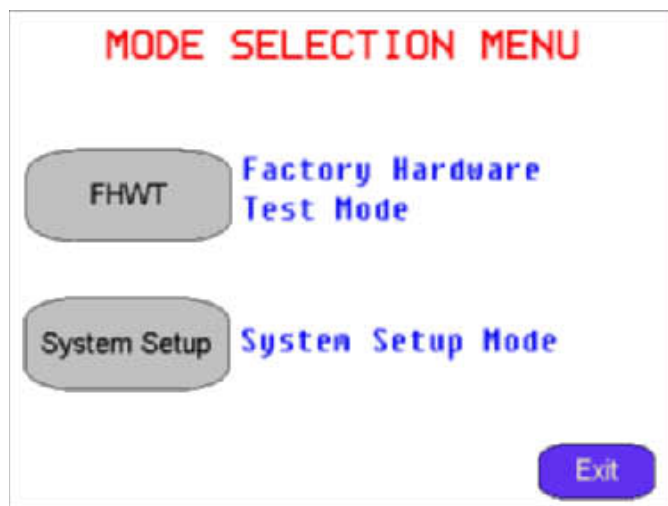

Figure 7.3: Mode selection menu

- 3 Choose the application **FHWT** or **System Setup**.
- 4 Press **Exit** to exit the factory application.

7-4-1 FHWT

The FHWT (Hardware Test) mode is used to test the HW of the NQ-Series. Examples are LCD test, Function key test, Communication port test, etc.

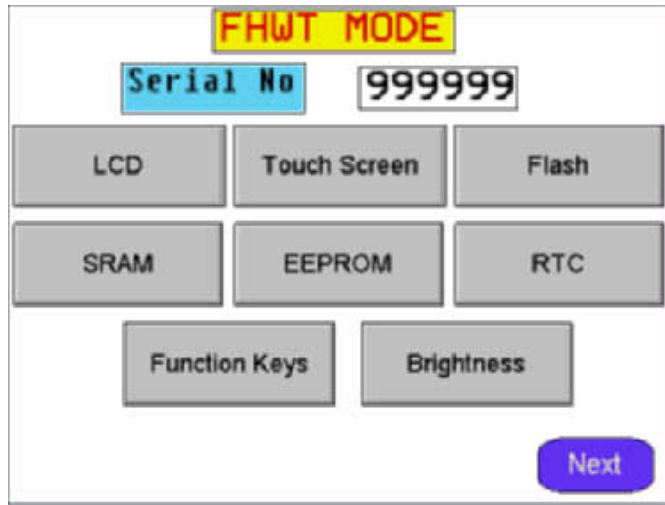

Figure 7.4: FHWT page 1

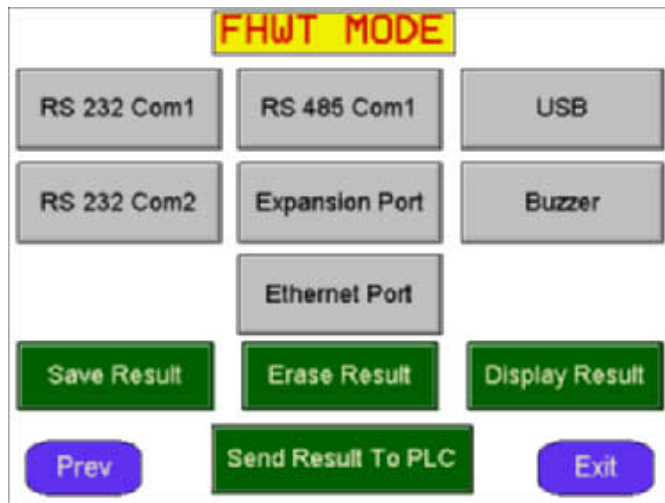

Figure 7.5: FHWT page 2

Table 7.2: FHWT mode tests

Test	Description
LCD	To test the LCD.
Touch Screen	To test the touch screen.
Flash	To test the flash.
SRAM	To test the SRAM.
EEPROM	To test the EEPROM.
RTC	To test the function of RTC.
Function keys	To test Function keys.
Brightness	To test the brightness of the screen.
Contrast	To test the contrast of the screen (NQ5)
RS-232 Com1	To test the RS-232 on Com1.
RS-485 Com1	To test the RS-485 on Com1.
RS-232 Com2	To test the RS-232 on Com2 (NQ5).
USB	To test the USB ports.
Expansion Port	Reserved.
Buzzer	To test the beeper.
Ethernet connection	To test Ethernet cable connection
Save Result	Reserved.
Display Result	Reserved.
Send Result to PLC	Reserved.

Pressing the above buttons on screen will start specific tests as indicated on the buttons. If needed follow the instruction shown on screen.

7-4-2 System set-up

System set-up menu can be used to set the NQ-Series. In this special application you can quickly set the RTC time, communication ports, clear the retentive registers, etc.

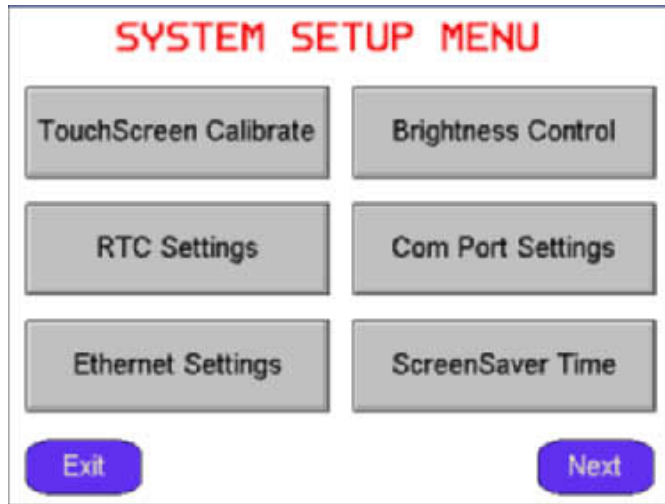

Figure 7.6: System set-up menu page 1

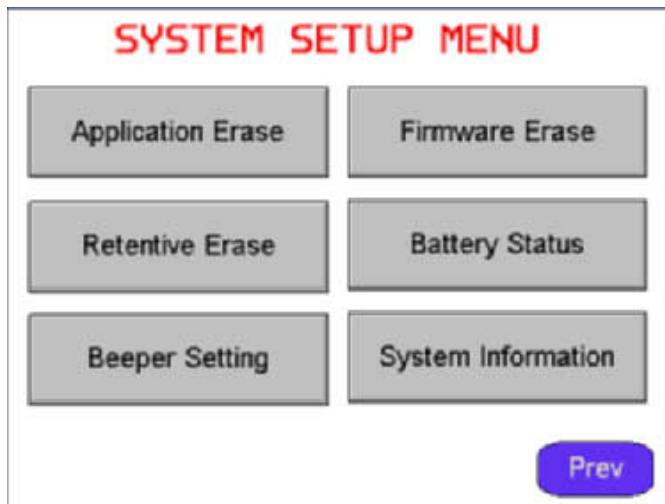

Figure 7.7: System set-up menu page 2

Table 7.3: System set-up settings

Setting	Description
TouchScreen Calibrate	To calibrate the touch screen. Refer also to 7-2 Touch screen calibration.
Brightness Control	To set the brightness of the screen.
Contrast Control	To set the constrast of the screen (NQ5)
RTC Settings	To set the RTC.
Com Port Settings	To set the com port.
Ethernet Settings	To set the Ethernet parameters for the NQ.
ScreenSaver Time	To set the screensaver time.
Application Erase	To erase the application. Note that if you perform this action you can not continue with NQ-Series diagnostics.
Firmware Erase	To erase the firmware. Note that if you perform this action you can not continue with NQ-Series diagnostics.
Beeper Setting	To set the beeper.
Battery Status	To view the battery status.
Clear retentive registers	To clear all retentive registers.
System Information	To view the system information.

Pressing the buttons on one of the 2 set-up screens will take you to the specific set-up procedures for the specific settings.

A Appendix A

A-1 OMRON communication cables

A-1-1 Cable references

The following tables provide an overview of the available cables from OMRON. The table shows which PLC can be used with the cable. OMRON provides three types of cables:

- Cables for PLCs with serial ports (DSUB9 to DSUB9)
- Cables for PLCs for mini-peripheral ports (DSUB9 to mini-peripheral)
- Programming cables

Table A.1: DSUB9 to DSUB9

PLC	Cable	Note
CP1*	NQ-CN222	2 meter cable
CJ*	NQ-CN521	5 meter cable
CS1		
CPM2*		
CQM1H		

Table A.2: Mini-peripheral to DSUB9

PLC	Cable	Note
CJ1	NQ-CN221	2 meter cable
CS1		
CPM2C		
CQM1H		

Table A.3: Programming cables

Cable	Note
CP1WCN221	USB cable (1.8 meter)
NT2SCN002	Serial cable (2 meter)

A-1-2 NQ-Series to PLC (NQC�222 / NQC�521)

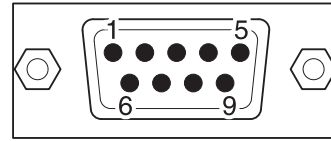
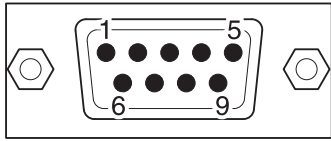

DB9 MALE PINOUTS (PLC)

Signals	Pin number
	1
TXD	2
RXD	3
RTS	4
CTS	5
	6
	7
	8
SG	9
Shield wire to DB9 body	

DB9 MALE PINOUTS (NQ)

Pin number	Signals
1	
2	TXD
3	RXD
4	
5	SG
6	
7	
8	
9	
Shield wire to DB9 body	

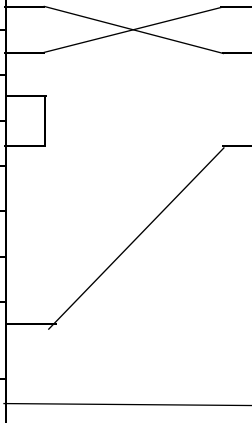

Cable configurations may be set to 2 configurations per page to reduce excess white area

A-1-3 NQ-Series to PC

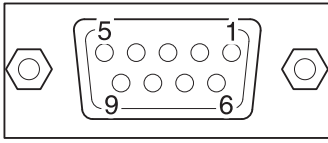

DB9 FEMALE PINOUTS (PC)

Signals	Pin number
	1
RXD	2
TXD	3
	4
SG	5
	6
	7
	8
	9
Shield wire to DB9 body	

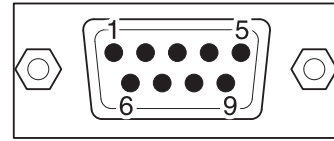

DB9 MALE PINOUTS (NQ)

Pin number	Signals
1	
2	TXD
3	RXD
4	
5	SG
6	
7	
8	
9	
Shield wire to DB9 body	

A-1-4 NQ-Series to inverter (V1000, RS-422 connection)

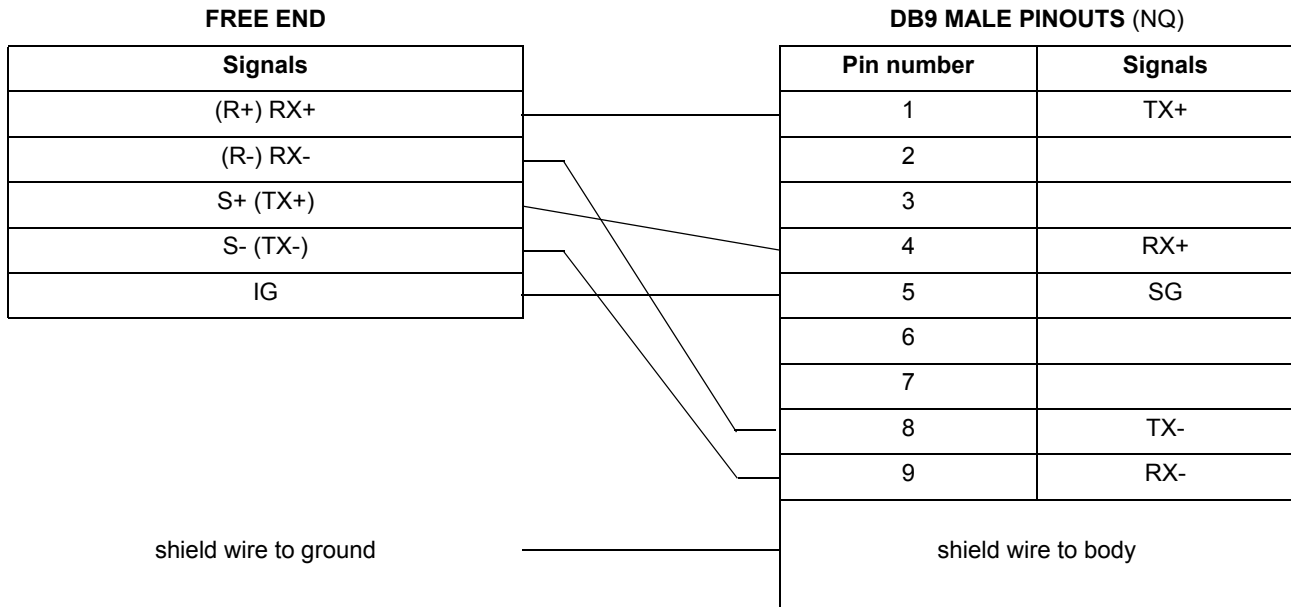
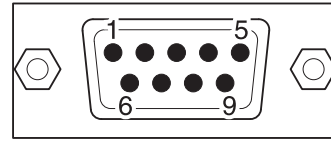

A-1-5 NQ-Series to inverter (V1000, RS-485 connection)

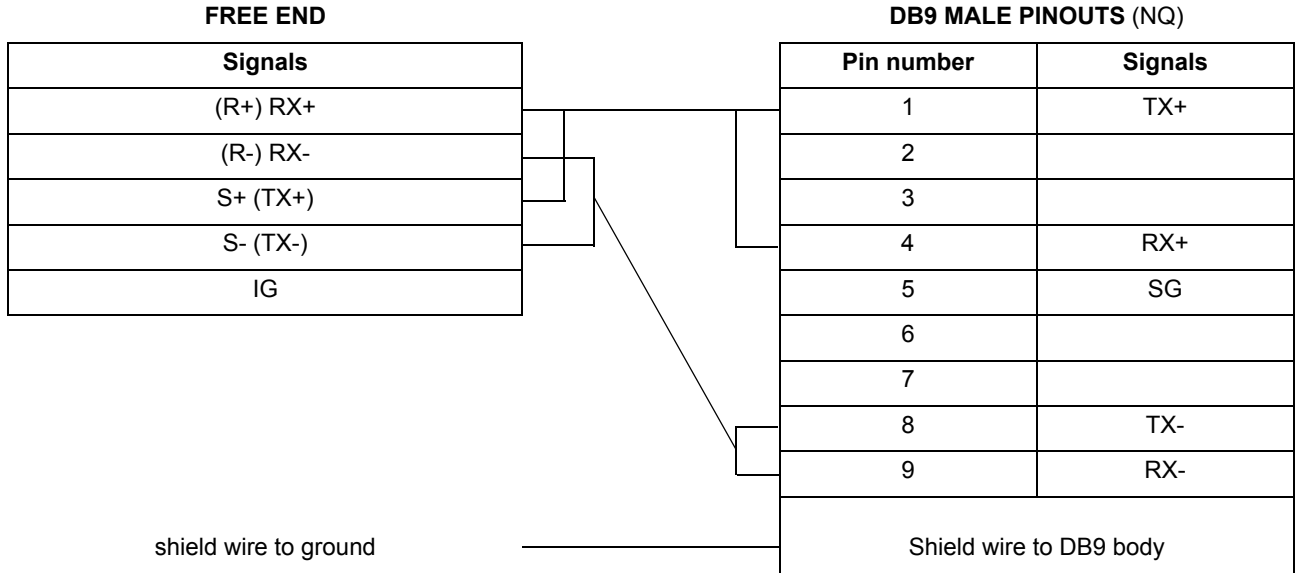
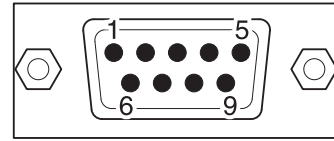

A-1-6 NQ-Series to CelciuX° (EJ1N) temperature controllers (RS-485 connection)

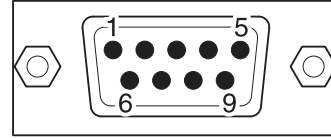

FREE END (EJ1-EDUA-NFLK)

Signals
7
6

DB9 MALE PINOUTS (NQ)

Pin number	Signals
1	TX+
2	
3	
4	RX+
5	SG
6	
7	
8	TX-
9	RX-
Shield wire to DB9 body	

shield wire to ground

A-2 Non-Omron devices to NQ-Series configurations

A-2-1 NQ-Series as Modbus RTU Master and ModSim (Slave-Simulation Software)

There are two options available in Modbus RTU: Modbus, 1 word length commands and Modbus, 16 word length commands. If Modbus driver is selected, all registers should be available in the slave.

In the following example ModSim (Modbus Slave Simulator www.wintech.com) is used to check whether the Modbus RTU master is communicating properly. The settings of the Modbus slave unit used should be set according to settings of ModSim to ensure a good communication.

To perform a successful communication proceed as follows.

- 1 Create a new project in NQ-Designer.
- 2 Right-click the **Nodes** folder and click **Add....**



Figure A.1: Project configuration

- 3 Set all data as shown in the screenshot.
- 4 Press OK
- 5 Go to nodes folder
- 6 Click on Modbus RTU node
- 7 Click on PLC specific settings
- 8 Make sure that the defined "default" communication register is an existing register in your Modbus slave or the communication will NOT be initiated.
- 9 Create PLC tag with address **HR400100**.
- 10 Add a **Data Entry** object with tag address **HR400100** on **screen1**.
- 11 Download the application and firmware to NQ-Series.
- 12 Open ModSim.
- 13 Click **New** on **File** menu.

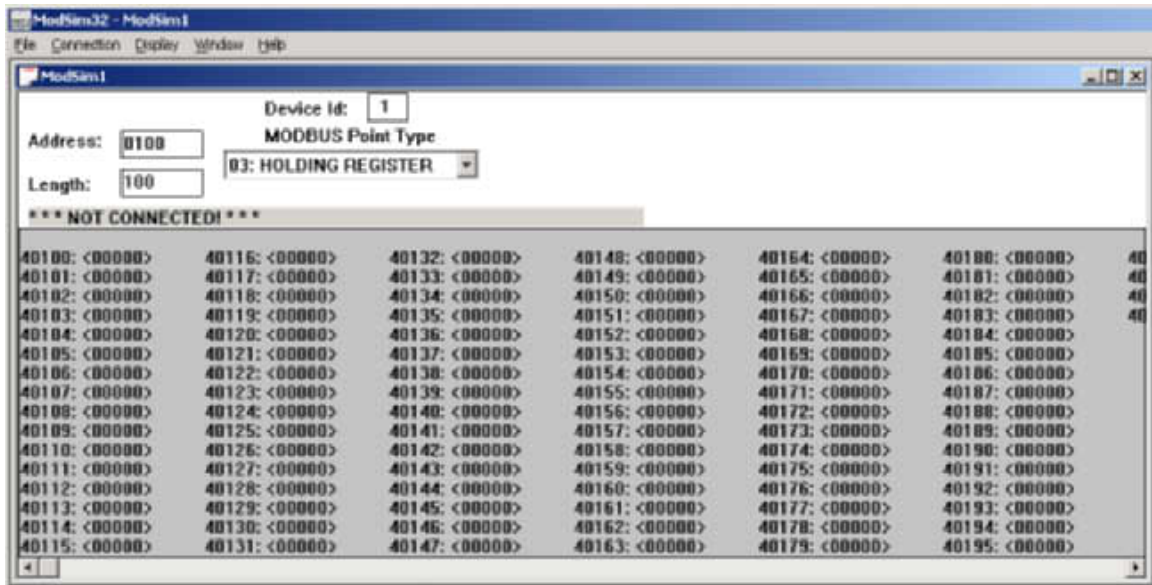

Figure A.2: ModSim32 - ModSim1

- 14 Set all data as shown in the screenshot.
- 15 Click **Connect** on **Connection** menu.

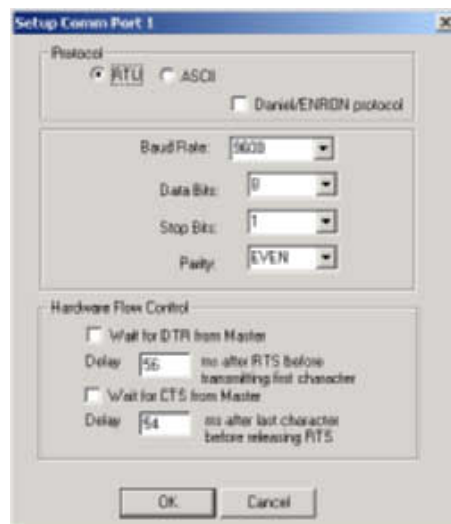

Figure A.3: Setup Comm Port 1

- 16 Set all data as shown in the screenshot. Click **OK**.
- 17 Connect the cable to the NQ-Series and PC (For the Modbus slave this means a proper RS-232 or RS-422 connection.) Refer to A-2-3 NQ-Series to PC. Connect the female port of the cable to the PC port and connect the male port of the cable to COM1 port of the NQ-Series.
- 18 Enter **123** in the NQ-Series' screen. If the connection has been correctly established the same value is shown in ModSim.

Note

The following messages are displayed on the NQ-Series' screen if problems occur:

- The NQ-Series establishes a connection to the slave by exchanging a default address **HR400020**. If this address is not available in the slave, the connection will not be established. To establish the connection proceed as follows.
 - 1 Click in the **Nodes** folder and right-click the Node1 inverter.
 - 2 Click **Edit**.
 - 3 Click **PLC Specific Setting**.

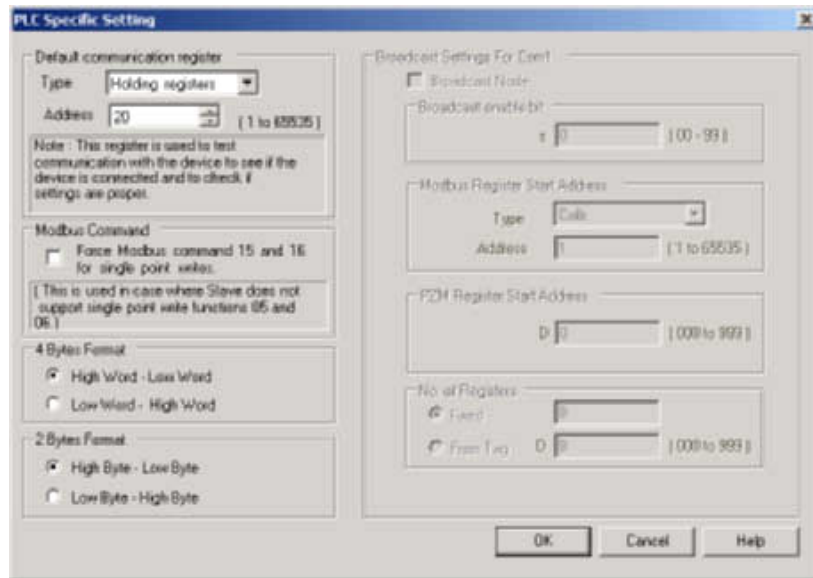

Figure A.4: PLC Specific Setting

- 5 Change **Default communication register** address to an available address in the slave.
 - 6 Click **OK**.
 - 7 Download the application to the NQ-Series.
- The following messages are displayed on the NQ-Series' screen if problems occur:
 - !!! no connection
 - ??? connection established, address unknown

A-2-2 NQ-Series as Modbus Slave and ModScan (Master-Simulation Software)

To perform a successful communication proceed as follows.

- 1 Right-click the **Nodes** folder and click **Add...**

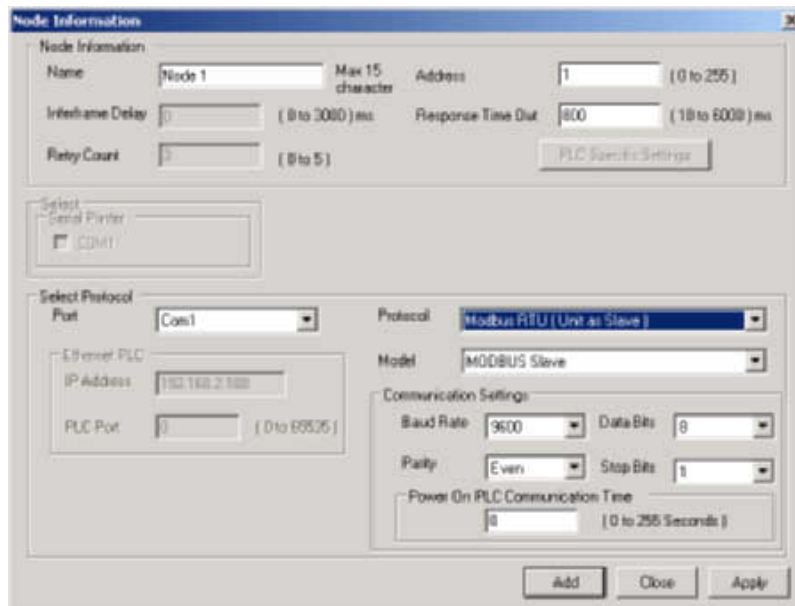

Figure A.5: Node information

- 2 Set all data as shown in the screenshot.
(Note that the scan time of the master is set lower then the response Time out (default 800ms))
- 3 Create PLC tag with **HR40001**.
- 4 Add a **Data Entry** object with tag address **HR40001** on **screen1**.
- 5 Download the application and firmware to the NQ-Series.
- 6 Open ModScan.
- 7 Click **New** on **File** menu.

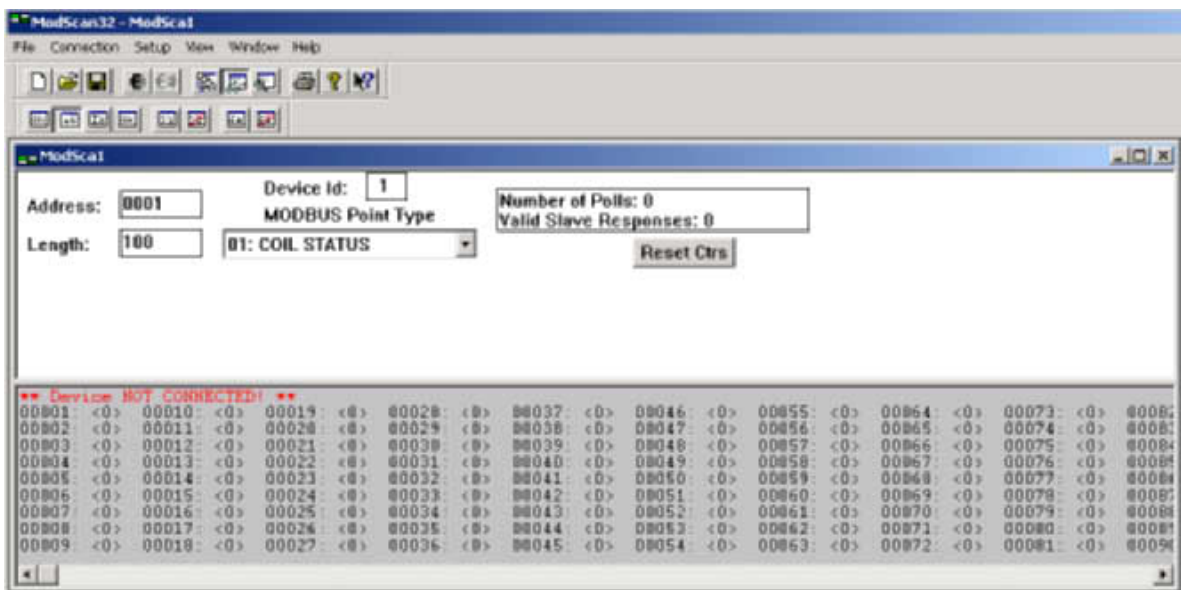

Figure A.6: ModScan32 - ModSca1

- 8 Set all data as shown in the screenshot.

- 9 Click **Connect** on **Connection** menu.
- 10 Select the PC port number to which the PC is connected.

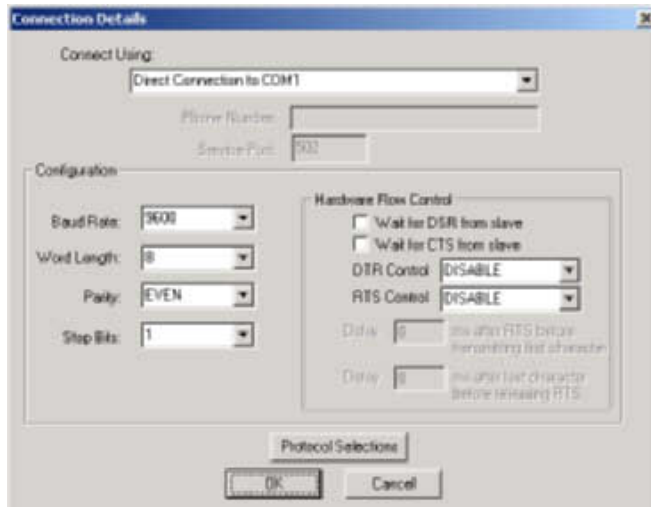

Figure A.7: Connection Details

- 11 Set all data as shown in the screenshot.
- 12 Connect the cable to the NQ-Series and PLC (For the Modbus slave this means a proper RS-232 or RS-422 connection.) Refer to A-2-3 NQ-Series to PC. Connect the female port of the cable to the PC port and connect the male port of the cable to COM1 port of the NQ-Series.
- 13 Enter **789** in the NQ-Series' screen. If the connection has been correctly established the same value is shown in ModSim.

Note

The following messages are displayed on the NQ-Series' screen if problems occur:

- !!! no connection
- ??? connection established, address unknown

A-2-3 NQ-Series with AB DF1 Driver to AB SLC Series

To perform a successful communication proceed as follows.

- 1 Right-click the **Nodes** folder and click **Add...**

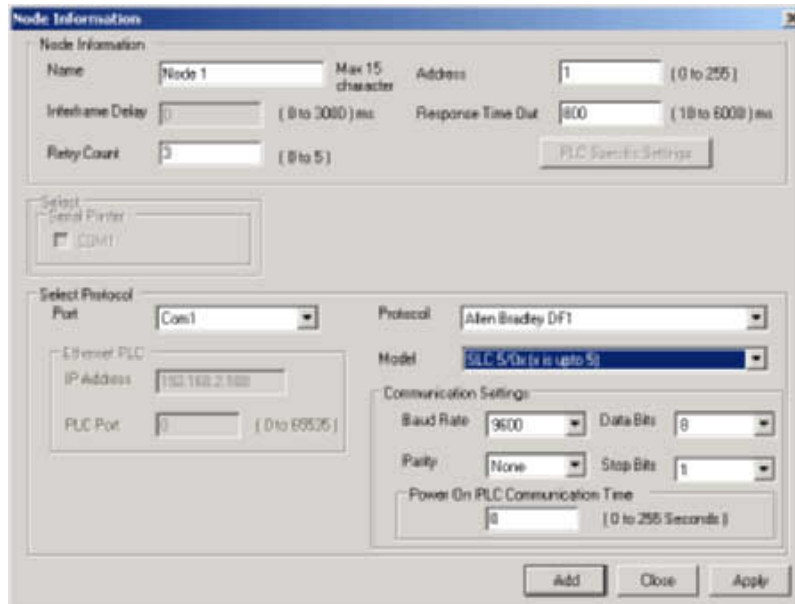

Figure A.8: Node Information

- 2 Set all data as shown in the screenshot.
- 3 Create PLC Integer tag with address **N007000**.
- 4 Add a **Numerical Data Entry** object with tag address **N007000** on **screen1**.
- 5 Download the application and firmware to the NQ-Series.
- 6 Open RS Logix500.
- 7 Click **Channel Configuration** on **File** menu.

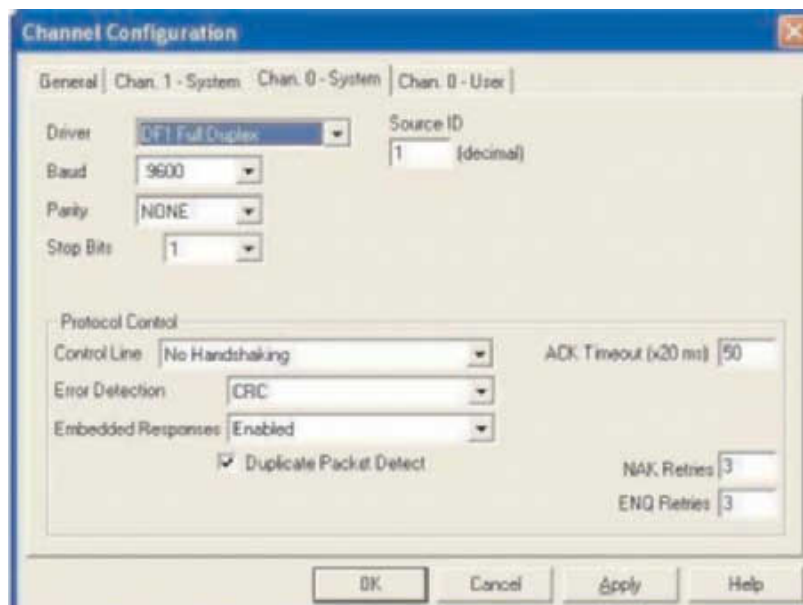

Figure A.9: Channel Configuration

- 8 Set all data as shown in the screenshot.
- 9 Download the application to the PLC.

10 Open **Data Files** from the tree structure and select the N7 (Integer Register) and double-click on the N007000 register.

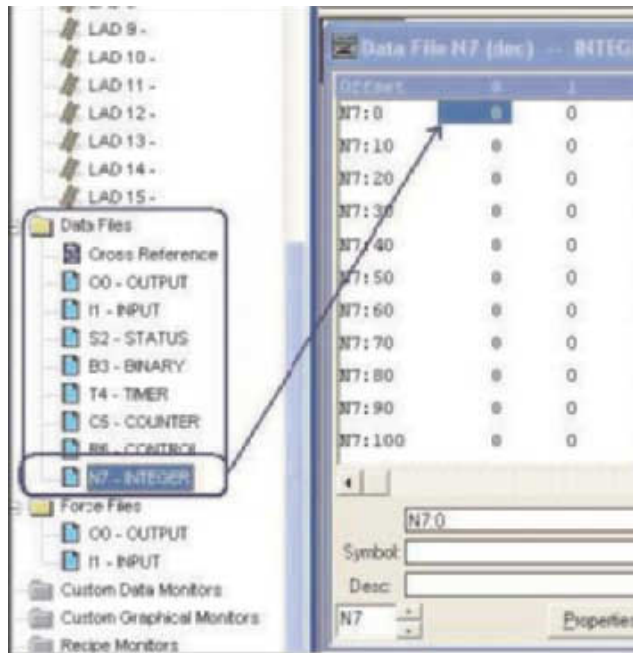

Figure A.10: Data Files

11 Connect the cable to the NQ-Series and PLC. Refer to A-3-1 NQ-Series to AB SLC Series.

12 Enter **123** in the NQ-Series' screen. If the connection has been correctly established the same value is shown in RS Logix 500 software.

Note

The following messages are displayed on the NQ-Series' screen if problems occur:

- !!! no connection
- ??? connection established, address unknown

A-2-4 NQ-Series with AB DF1 Driver to AB MicroLogix

To perform a successful communication proceed as follows.

- 1 Right-click the **Nodes** folder and click **Add...**

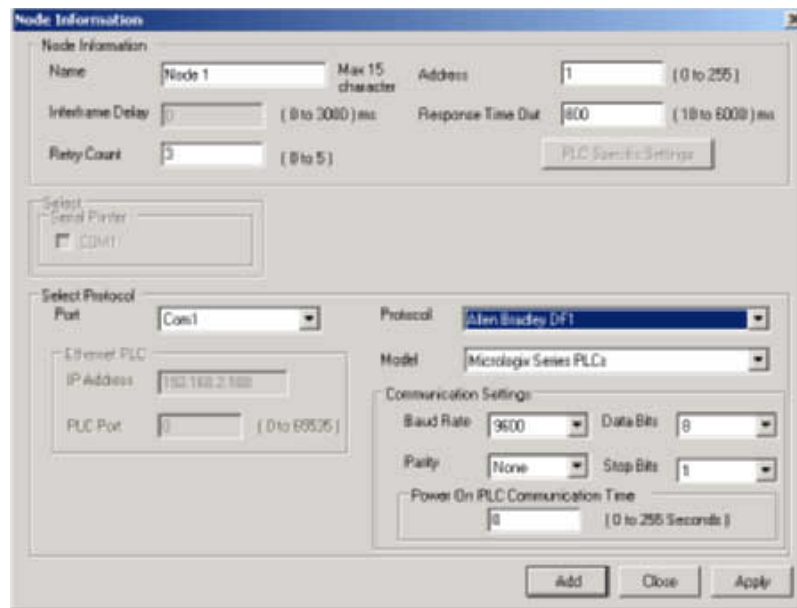

Figure A.11: Node information

- 2 Set all data as shown in the screenshot.
- 3 Create PLC tag with address **N007000**.
- 4 Add a Data Entry object with tag address **N007000** on **screen1**.
- 5 Download the application and firmware to the NQ-Series.
- 6 Open RS Logix500.
- 7 Click **Channel Configuration** on **File** menu.

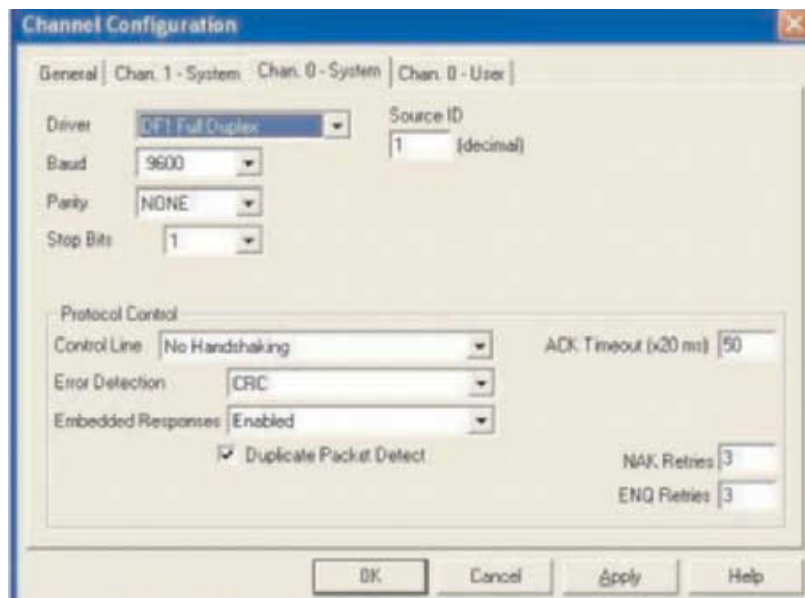

Figure A.12: Channel Configuration

- 8 Set all data as shown in the screenshot.
- 9 Download the application to the PLC.

10 Open **Data Files** from the tree structure and select the N7 (Integer Register) and double-click on the **N00700** register.

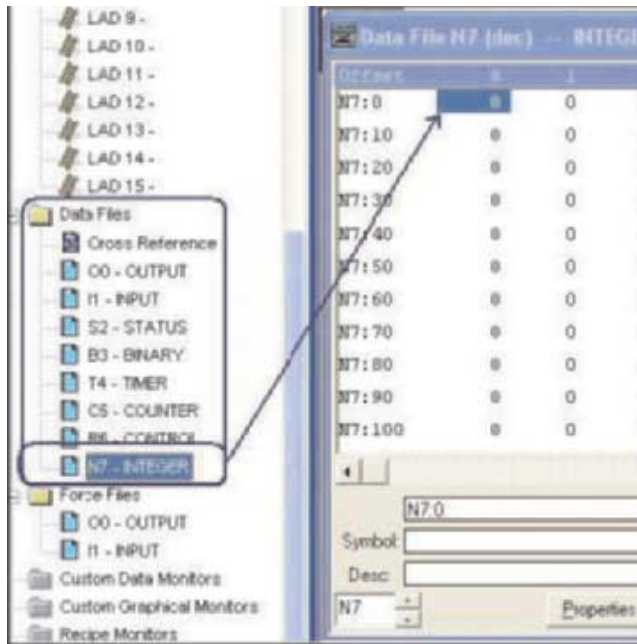

Figure A.13: Data Files

11 Connect the cable to the NQ-Series and PLC. Refer to A-3-2 NQ-Series to AB Micrologix Series. Connect the PLC end MiniDIN port to the AB DF1 Micrologix 1000 PLC. Connect the NQ-Series' male port of the cable to the COM1 port of the NQ-Series.

12 Enter **123** in the NQ-Series' screen. If the connection has been correctly established the same value is shown in RS Logix 500 software.

Note

The following messages are displayed on the NQ-Series' screen if problems occur:

- !!! no connection
- ??? connection established, address unknown

A-2-5 NQ-Series with AB DF1 Compact Logix Driver and AB Compact Logix L31

To perform a successful communication proceed as follows.

- 1 Right-click the **Nodes** folder and click **Add...**

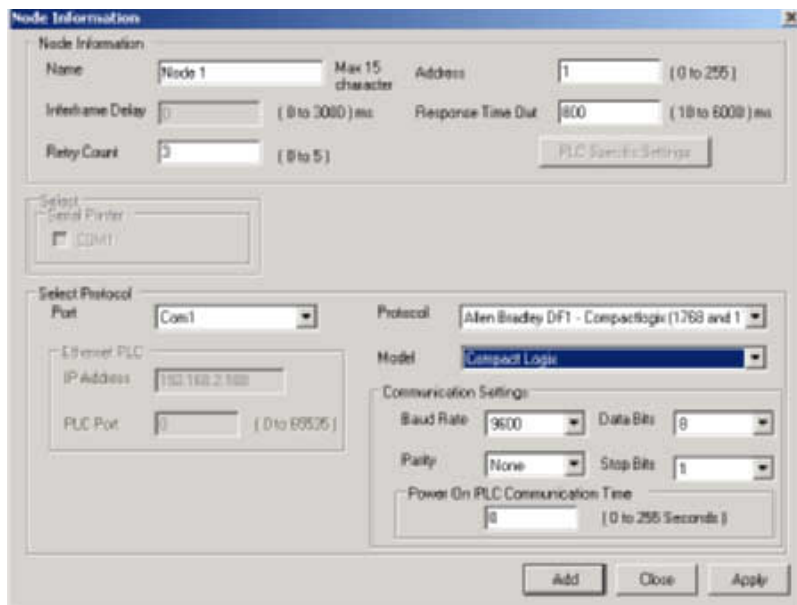

Figure A.14: Data Files

- 2 Set all data as shown in the screenshot.
- 3 Create PLC tag with address **N007000**.
- 4 Add a **Data Entry** object with tag address **N007000** on **screen1**.
- 5 Download the application and firmware to the NQ-Series.
- 6 Open RSLogix 5000 .
- 7 Click on **New** on file menu.
- 8 Create new project.
- 9 After PLC is selected above screen will be shown.
Click on the PLC model and select CH0-system protocol
Confirm if data is as shown below.

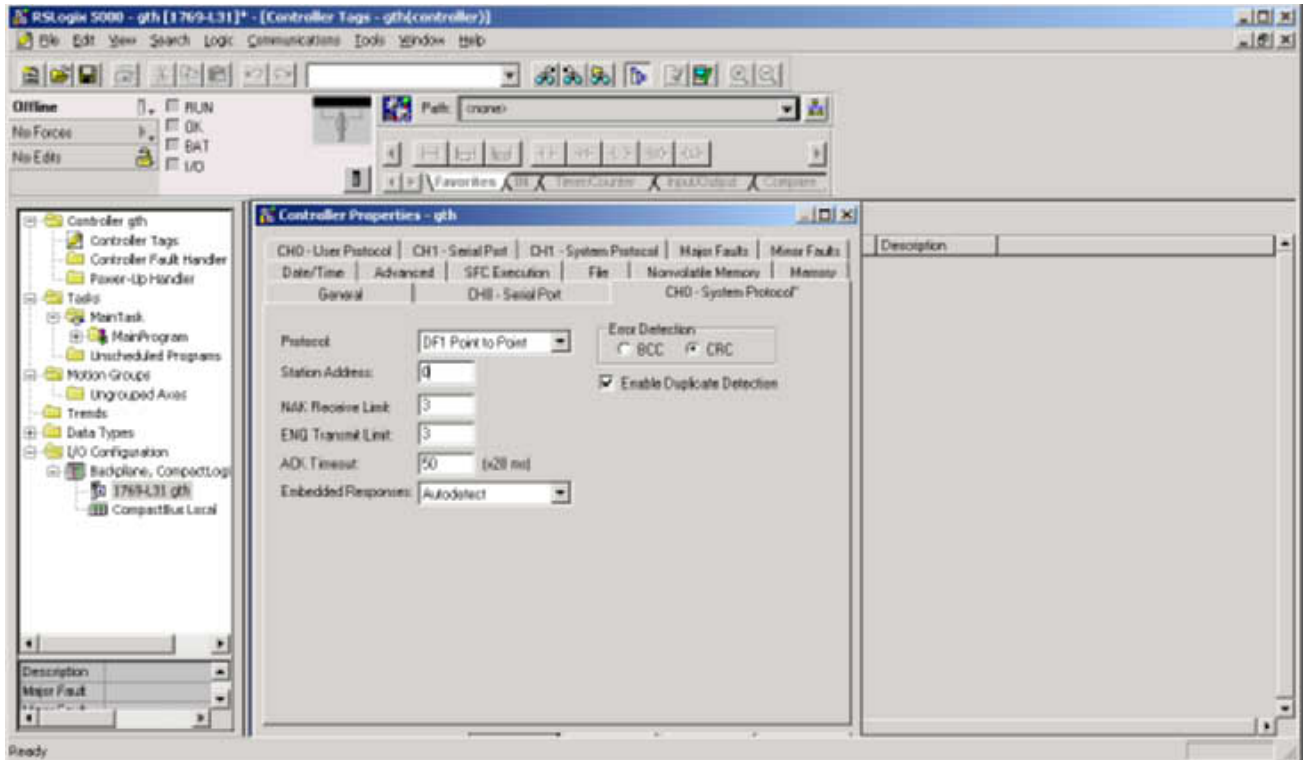

Figure A.15: Controller Properties

- 10 Switch to CH0 - Serial port and set all data as shown above
- 11 Download the application to the PLC.
- 12 Open **Controller Tags** window from **Monitor** section and change the value in the N70 register.

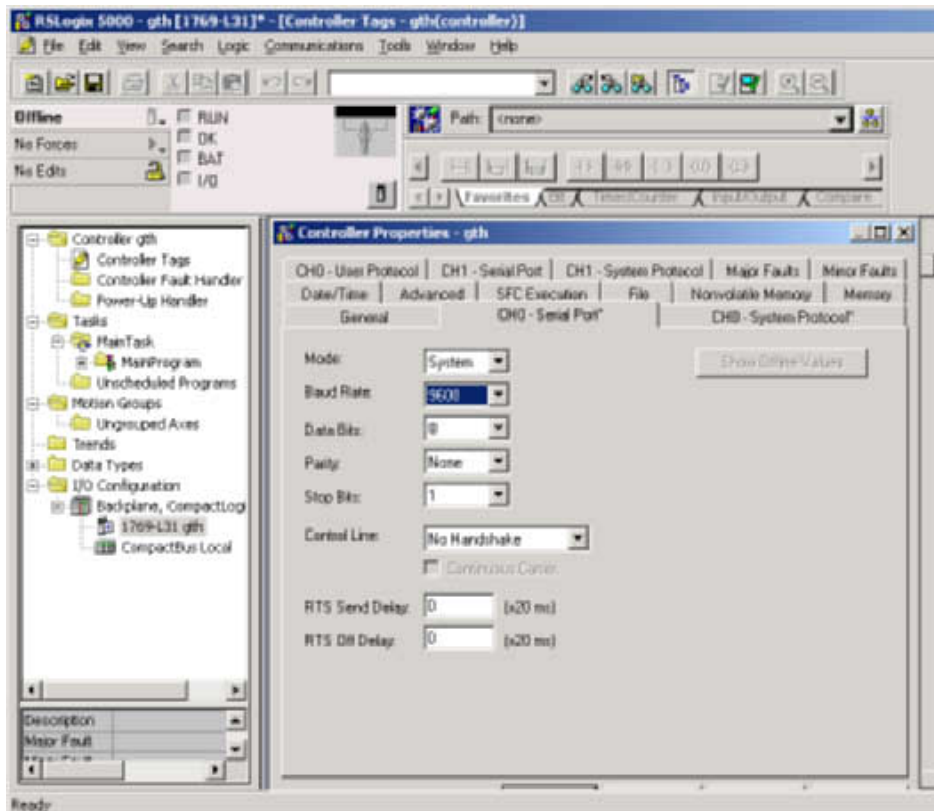

Figure A.16: Controller Properties

- 13 Connect the cable to the NQ-Series and PLC. Refer to A-3-3 NQ-Series to AB Compact Logix. Connect the PLC end port to AB DF1 Compact Logix L31 PLC. Connect the NQ-Series' male port of the cable to the defined COM1 port of the NQ-Series.
- 14 Enter **796** in the NQ-Series' screen. If the connection has been correctly established the same value is shown in RS Logix 5000 software.

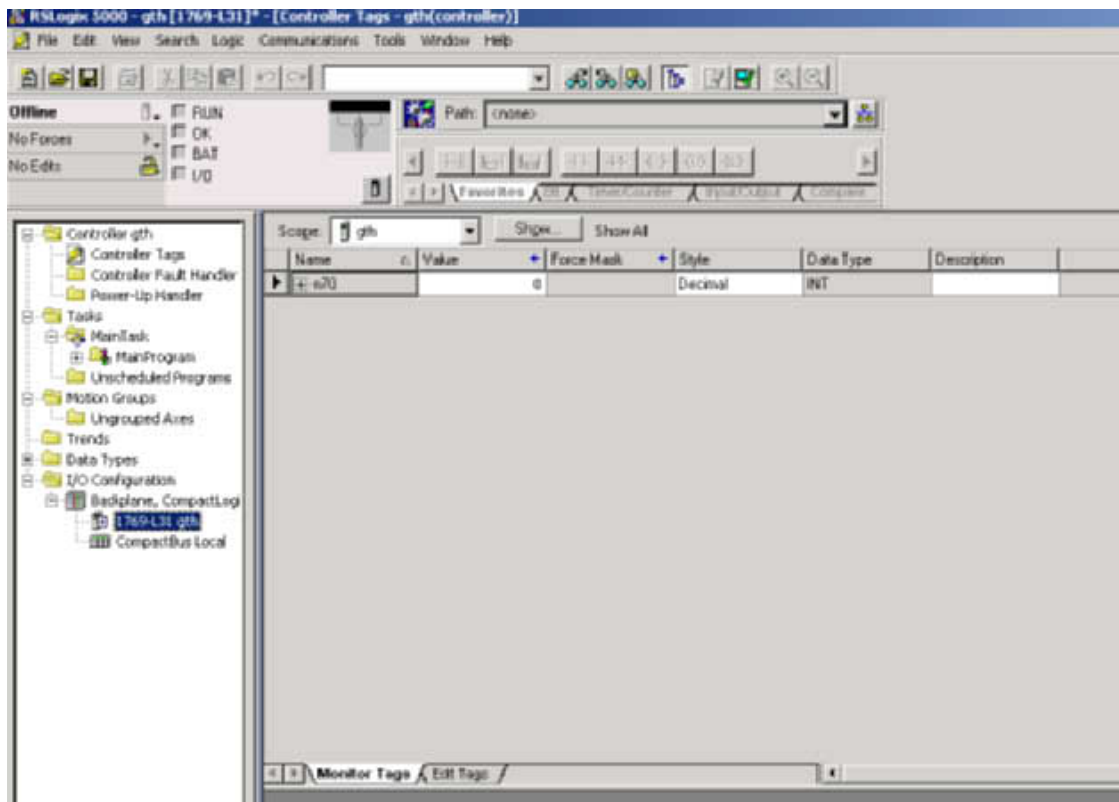

Figure A.17: Controller Tags

Note

The following messages are displayed on the NQ-Series' screen if problems occur:

- !!! no connection
- ??? connection established, address unknown

A-2-6 NQ-Series with Siemens S7 (PPI) Driver and Siemens S7-200 Series PLC

To perform a successful communication proceed as follows.

- 1 Right-click the **Nodes** folder and click **Add...**

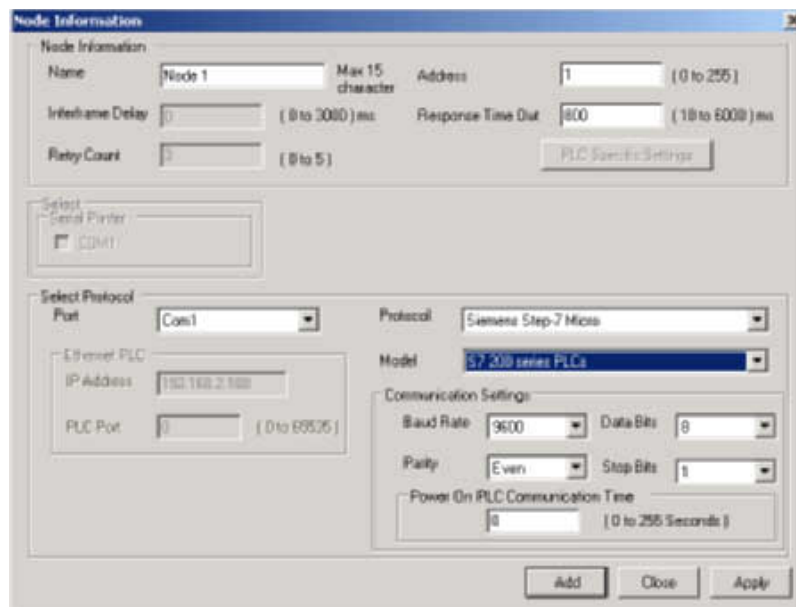

Figure A.18: Node information

- 2 Set all data as shown in the screenshot.
- 3 Create PLC tag with address **MW0000**.
- 4 Add a **Data Entry** object with tag address **MW0000** on **screen1**.
- 5 Download the application and firmware to the NQ-Series.
- 6 Open STEP 7-Micro/WIN.
- 7 Click **Communications in project window** and click then on **Communications ports**.

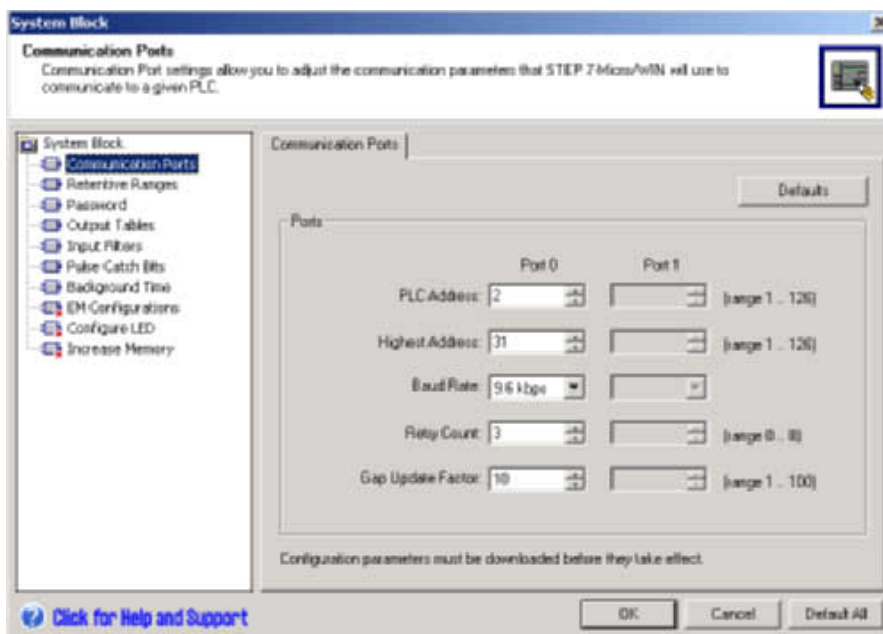

Figure A.19: Communication Ports

- 8 Set all data as shown in the screenshot.

- 9 Download the application to the PLC.
- 10 Click **Status chart** in project window and enter **MW0000** in the screen. Monitor the values in the field.

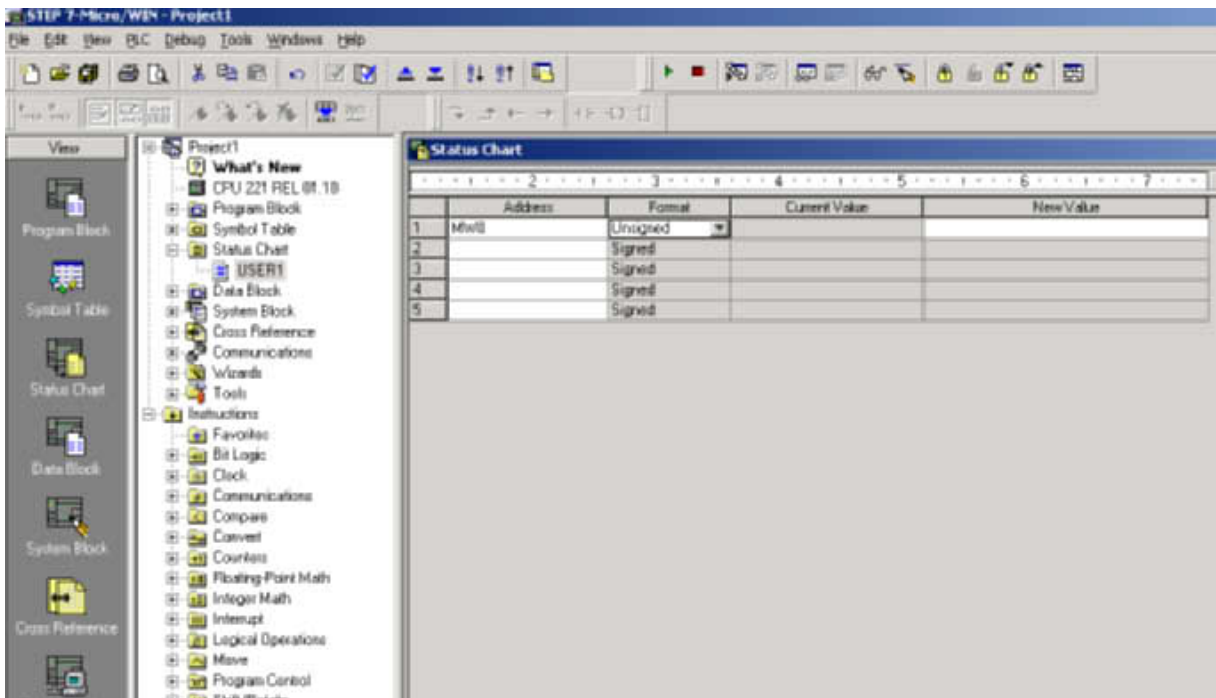

Figure A.20: Status chart

- 11 Connect the cable to the NQ-Series and PLC. Refer to A-3-4 NQ-Series to Siemens S7-200 Series. Connect the PLC end port to the Siemens S7-200 PLC. Connect the NQ-Series male port of the cable to the defined COM1 port of the NQ-Series.
- 12 Enter **10** on the NQ-Series screen. If the connection has been correctly established the same value is shown in Step 7 MICRO/WIN Siemens software.

Note

The following messages are displayed on the NQ-Series' screen if problems occur:

- !!! no connection
- ??? connection established, address unknown

A-2-7 NQ-Series with Siemens S7 (MPI) Driver and Siemens S7-300 Series PLC

To perform a successful communication proceed as follows.
Note that only **1 to 1 connection** is supported from NQ-Series.

- 1 Right-click the **Nodes** folder and click **Add...**

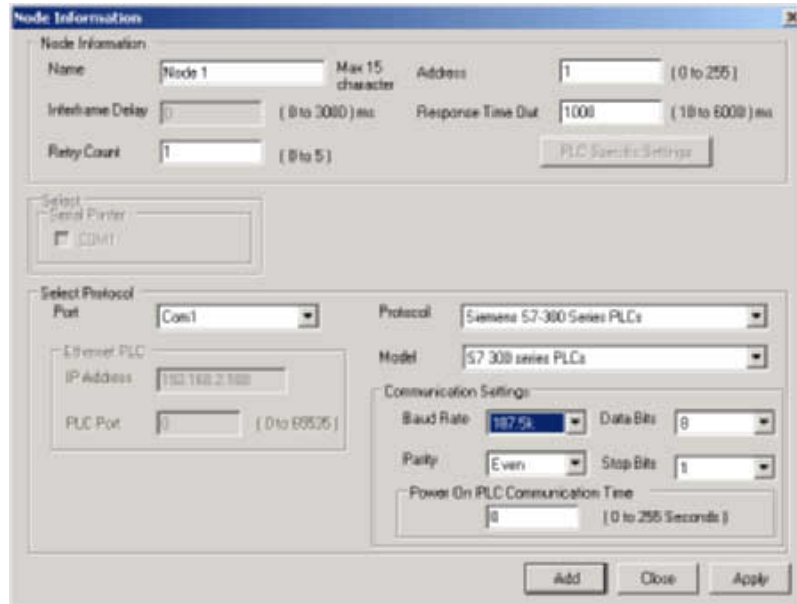

Figure A.21: Node information

- 2 Set all data as shown in the screenshot.
- 3 Create PLC tag with address **MW0000**.
- 4 Add a **Data Entry** object with tag address **MW0000** on **screen1**.
- 5 Download the application and firmware to the NQ-Series.
- 6 Open SIMATIC Manager.
- 7 Click **Properties** on **File** menu.

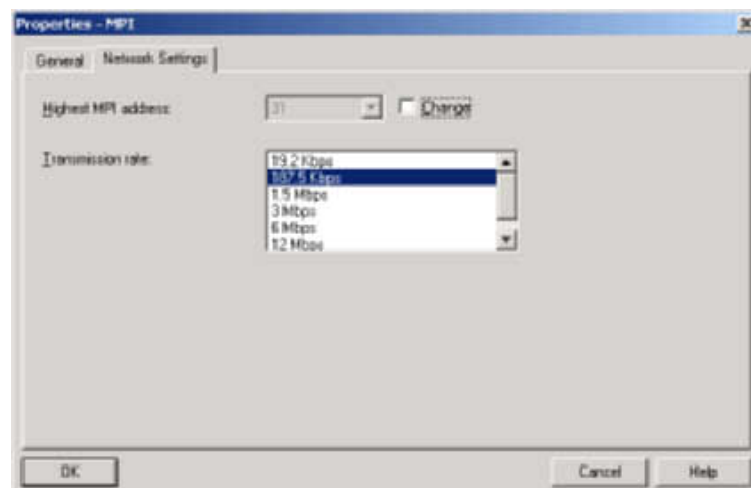

Figure A.22: Network Settings

- 8 Set all data as shown in the screenshot.
- 9 Download the application to the PLC.

10 Click **PLC/MODIFY Monitor Variables** on **PLC** menu.

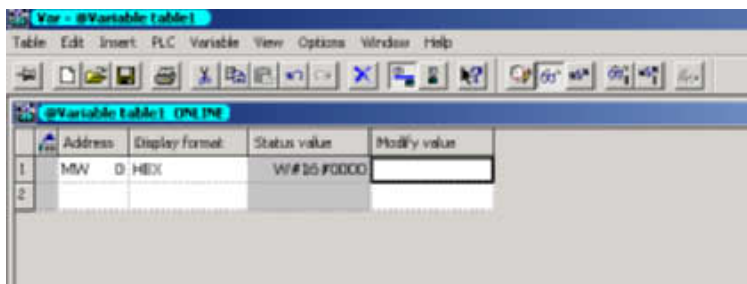

Figure A.23: Variable table

11 Connect the cable to the NQ-Series and PLC. Refer to A-3-5 NQ-Series to Siemens S7-300/400 Series. Connect the PLC end port to the Siemens S7-300 PLC. Connect the NQ-Series' male port of the cable to the defined COM1 port of the NQ-Series.

12 Enter **3000** in the NQ-Series screen. If the connection has been correctly established the same value is shown in SIMATIC Siemens software.

Note

The following messages are displayed on the NQ-Series screen if problems occur:

- !!! no connection
- ??? connection established, address unknown

A-2-8 NQ-Series with Mitsubishi FX PLC

To perform a successful communication proceed as follows.

- 1 Right-click the **Nodes** folder and click **Add...**

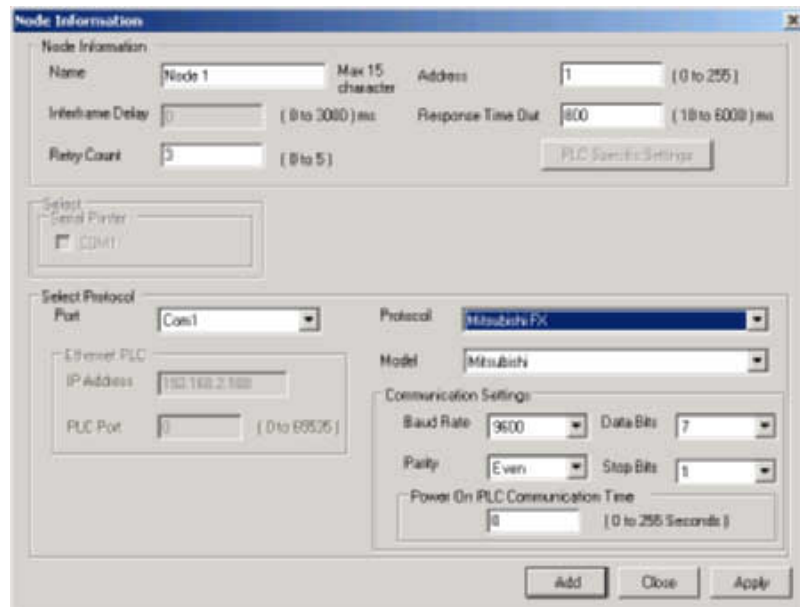

Figure A.24: Node information

- 2 Set all data as shown in the screenshot.
- 3 Create PLC tag with address **D0000** (Data Registers 1).
- 4 Add a **Data Entry** object with tag address **D0000** on **screen1**.
- 5 Download the application and firmware to the NQ-Series.
- 6 Open the GX Developer.
- 7 Click **Communications Setup** on **File** menu.

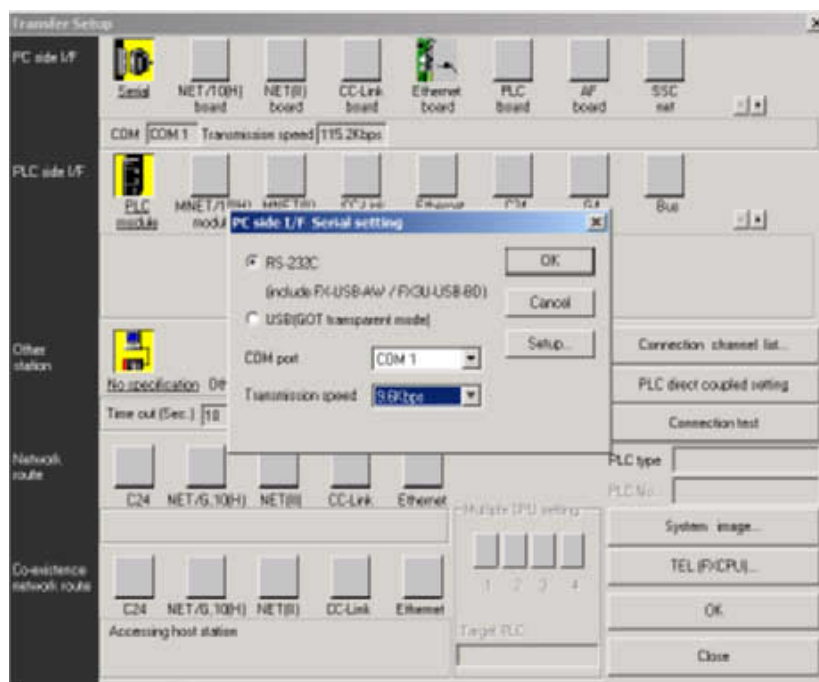

Figure A.25: Communication setup

- 8 Connect the cable to the NQ-Series and PLC. Refer to A-3-6 NQ-Series to Mitsubishi FX PLC (8 Pin Connector) or A-3-7 NQ-Series to Mitsubishi FRS Inverter. Connect the PLC end port to the Mitsubishi FX PLC. Connect the NQ-Series' male port of the cable to the defined COM1 port of the NQ-Series.
- 9 Enter **11** in the NQ-Series' screen. If the connection has been correctly established the same value is shown in Mitsubishi Series PLC software

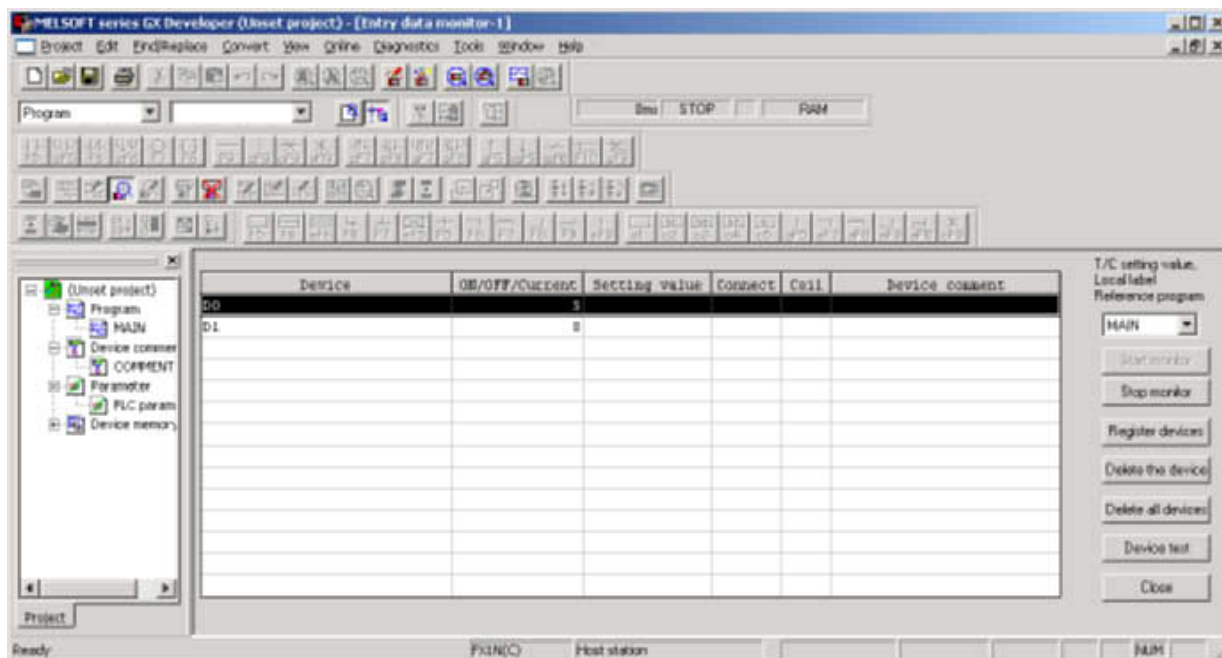

Figure A.26: NQ-series' screen

Note

The following messages are displayed on the NQ-Series' screen if problems occur:

- !!! no connection
- ??? connection established, address unknown

A-2-9 NQ with Mitsubishi FRS Inverter and Mitsubishi FRS520E

To perform a successful communication proceed as follows.

- 1 Right-click the **Nodes** folder and click **Add...**

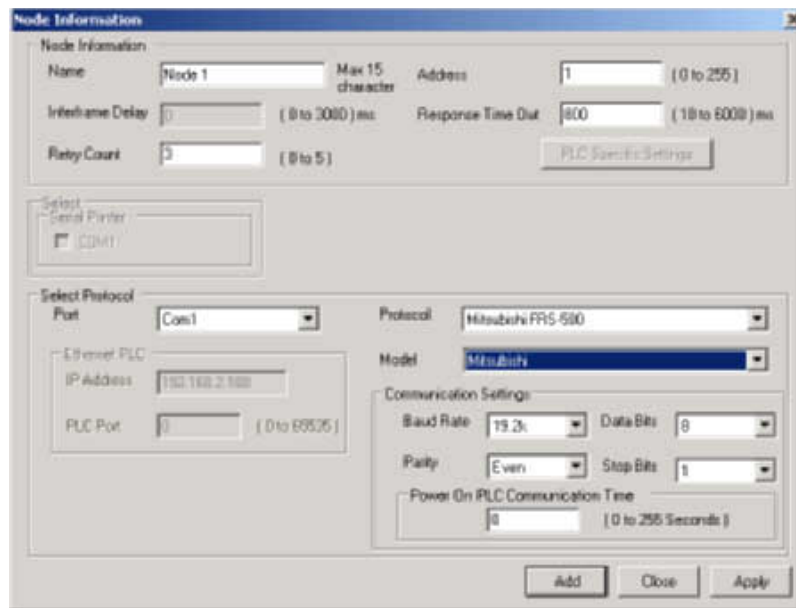

Figure A.27: Node information

- 2 Set all data as shown in the screen shot.
- 3 Create PLC tag with address **A000** (Run Command).
- 4 Add an **Advanced Bit Button** task with **Press** task:
 - Write **2** to **A000**:
To run/start the drive frequency to Max Freq Defined
 - Write **0** to **A000**:
To stop the inverter frequency to Min Freq 00.0
- 5 Create PLC tag with address **M000** (Link Parameter Exp) and **C000** (Operation Mode).
- 6 Create PLC tag with address **D000** (Output Frequency).
- 7 Add a **Numerical Data Entry** object with tag address **D000** with unsigned integer format of **###.##** (5,2) on **screen1**.
- 8 Create the following task in Poweron Task:
 - Write **0** to **M000**:
To access any of the parameters
 - Write **0** to **C000**:
To run/stop the drive
- 9 Download the application and firmware to the NQ-Series.
- 10 TBD: Click **Display Panel** on **File** menu.
- 11 Press **Set** key unless you observe P0 and rotate the POT wheel unless display changes to P0 ton1 and check/set the following parameters:
 - n1: Station Number Define 1.
 - n2: Communication Speed 192 Default (i.e. for baud rate 19200 bps)
 - n3: Change it to zero
 - n4: Parity check change it to 0 for even parity
- 12 Connect the cable to the NQ-Series and PLC. Refer to A-3-7 NQ-Series to Mitsubishi FRS Inverter. Connect the end RJ PORT to the FRS520E Drive.

- 13 Press **Start/Stop** button on the NQ-Series' screen. The frequency is changed in **D000** parameter as well as on display of the Drive.
- 14 Enter **11** in the NQ-Series' screen. If the connection has been correctly established the same value is shown in Mitsubishi Series PLC software.

Note

The following messages are displayed on the NQ-Series' screen if problems occur:

- !!! no connection
- ??? connection established, address unknown

A-2-10 NQ-Series Twido Driver and Twido PLC

To perform a successful communication proceed as follows.

- 1 Right-click the **Nodes** folder and click **Add...**

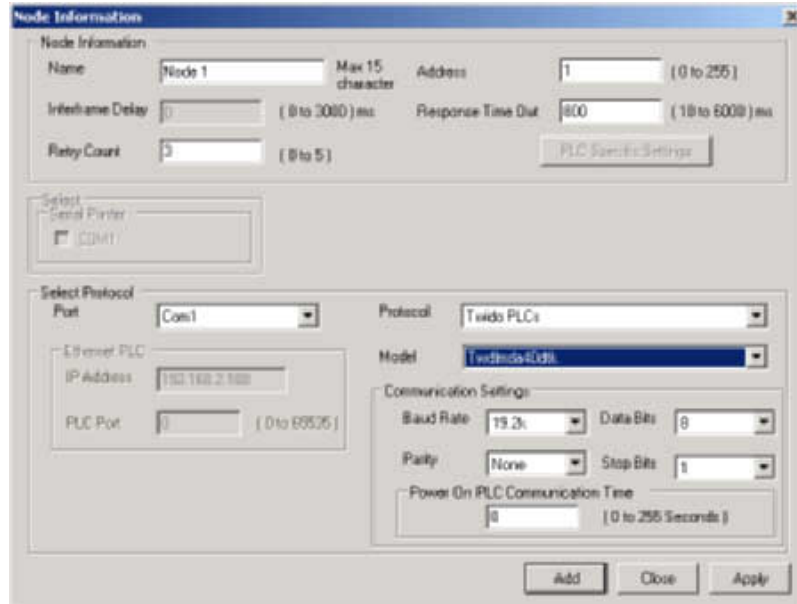

Figure A.28: Node information

- 2 Set all data as shown in the screenshot.
- 3 Create PLC tag with address **MW000**.
- 4 Add a **Data Entry** object with tag address **MW000** on **screen1**.
- 5 Download the application and firmware to the NQ-Series.
- 6 Open Twidosoft.
- 7 Click **Controller Communication Setup** on **File** menu.

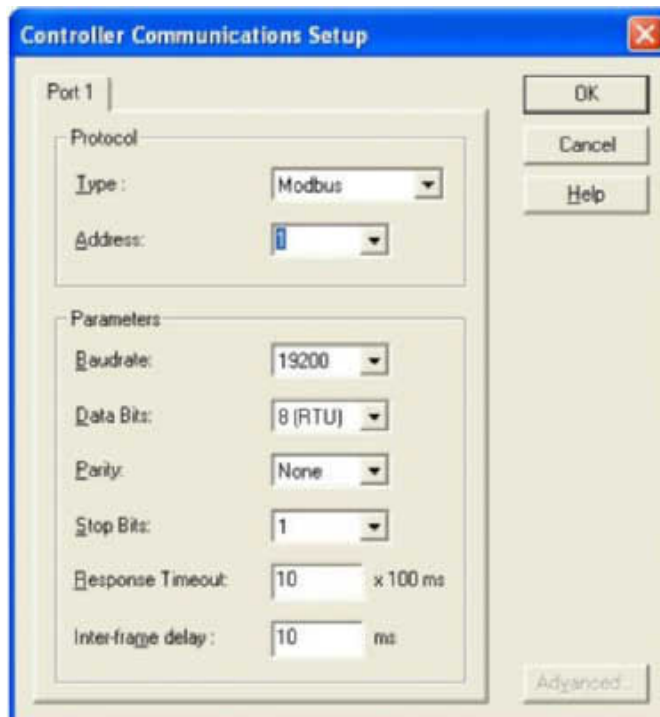

Figure A.29: Controller Communication Setup

- 8 Set all data as shown in the screenshot.
- 9 Download the application to the PLC.
- 10 Open PLC memory window to observe the change in MW0000 values.

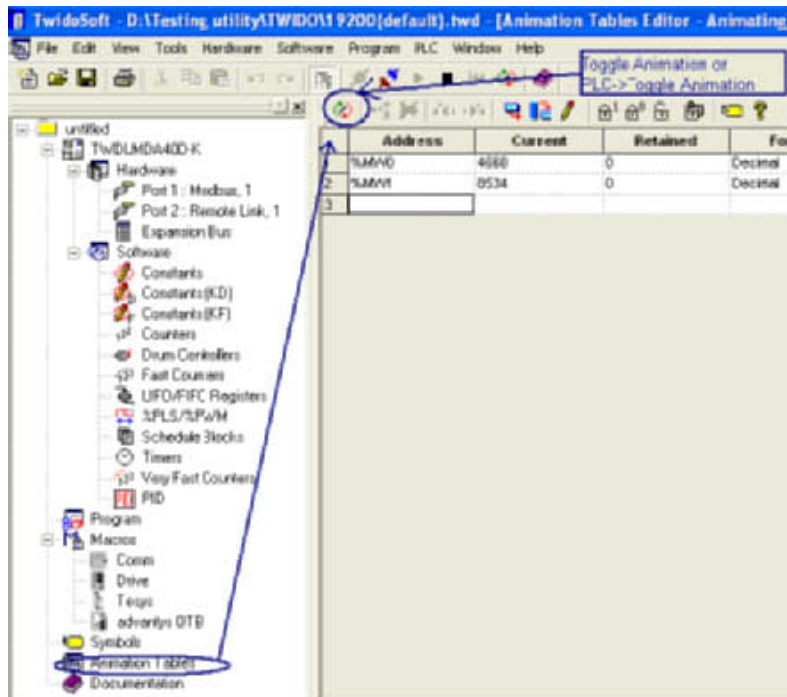

Figure A.30: Animation tables

- 11 Connect the cable to the NQ-Series and PLC. Refer to A-3-8 NQ-Series to Schneider Twido. Connect MiniDIN port of the cable to the PLC port. Connect the male port of the cable to the defined COM1 port of the NQ-Series.
- 12 Enter **4568** in the NQ-Series' screen. If the connection has been correctly established the same value is shown in Twido software.

Note

The following messages are displayed on the NQ-Series' screen if problems occur:

- !!! no connection
- ??? connection established, address unknown

A-2-11 NQ-Series with Schneider Modicon Driver and Schneider Quantum CPU 513

To perform a successful communication proceed as follows.

- 1 Right-click the **Nodes** folder and click **Add...**

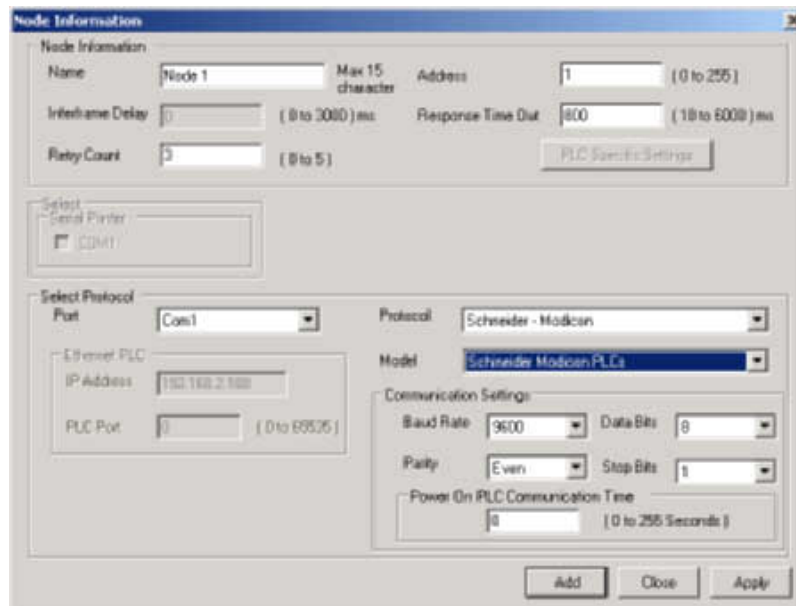

Figure A.31: Node information

- 2 Set all data as shown in the screenshot.
- 3 Create PLC tag with address **HR4 00001**.
- 4 Add a **Data Entry** object with tag address **HR4 00001** on **screen1**.
- 5 Download the application and firmware to the NQ-Series.
- 6 TBD: Open ProWorx32.
- 7 TBD: Click **Communications Setup** on **File** menu.

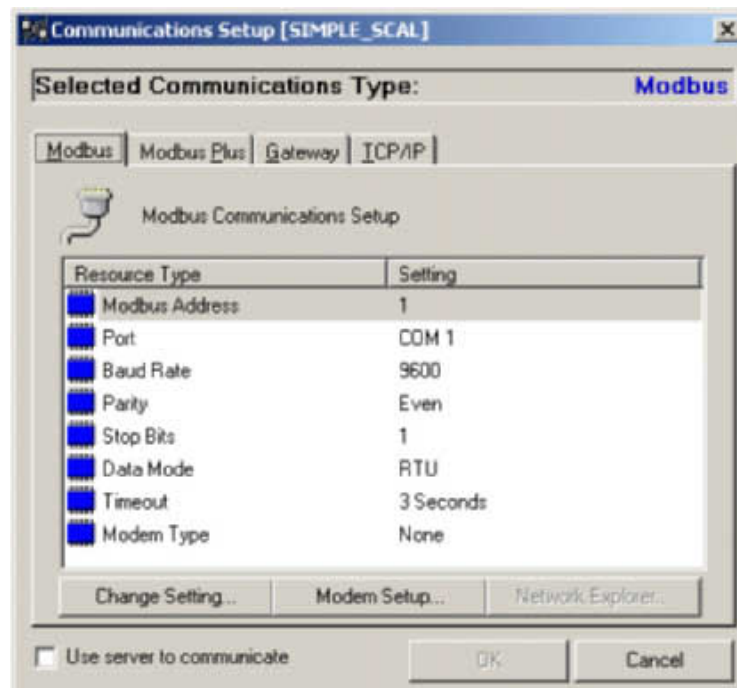

Figure A.32: Communication Setup

- 8 Set all data as shown in the screenshot.
- 9 Download the application to the PLC.
- 10 Open **Data Watch** window from **Data Editors** section of the Pro Worx software.

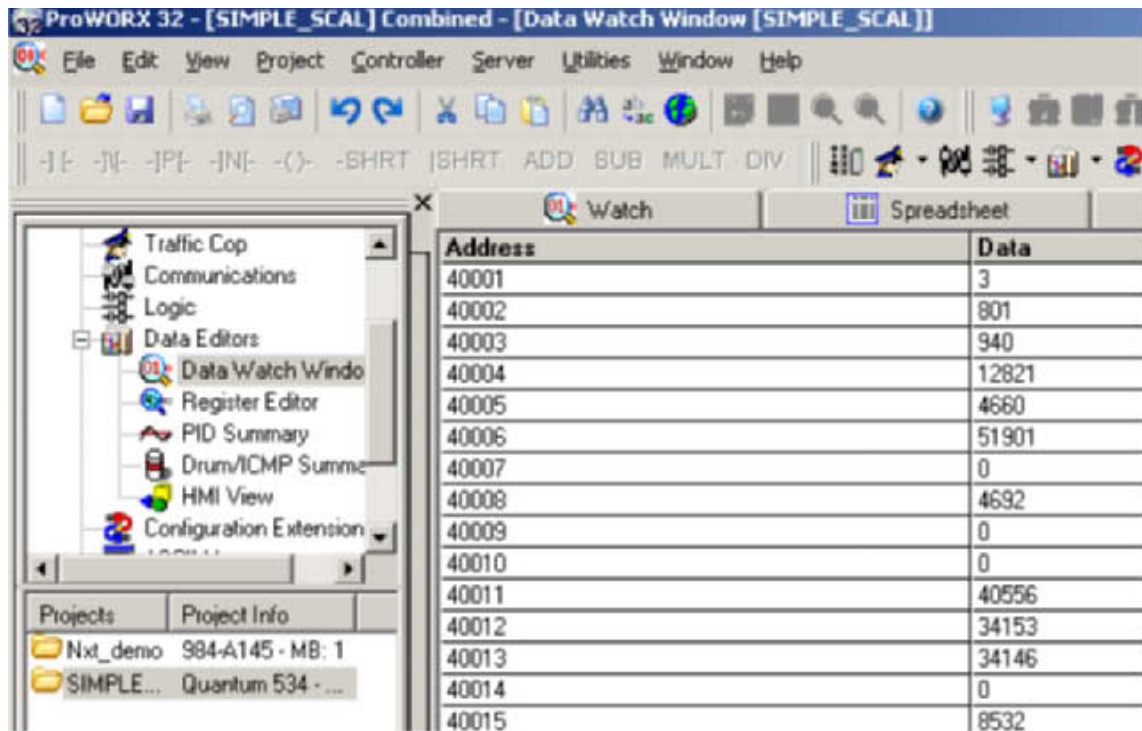

Figure A.33: Data Watch Window

- 11 Connect the cable to the NQ-Series and PLC. Refer to A-3-9 NQ-Series to Schneider Nano. Connect the PLC end port to the Schneider PLC. Connect the NQ-Series' male port of the cable to the defined COM1 port of the NQ-Series.
- 12 Enter **3** in the NQ-Series' screen. If the connection has been correctly established the same value is shown in ProWorx Schneider PLC software.

Note

The following messages are displayed on the NQ-Series' screen if problems occur:

- !!! no connection
- ??? connection established, address unknown

A-2-12 NQ-Series with Schneider Modicon Nano Driver and Schneider Quantum CPU 513

To perform a successful communication proceed as follows.

- 1 Define the setting in **Node Configuration** window of NQ-Designer as shown below.

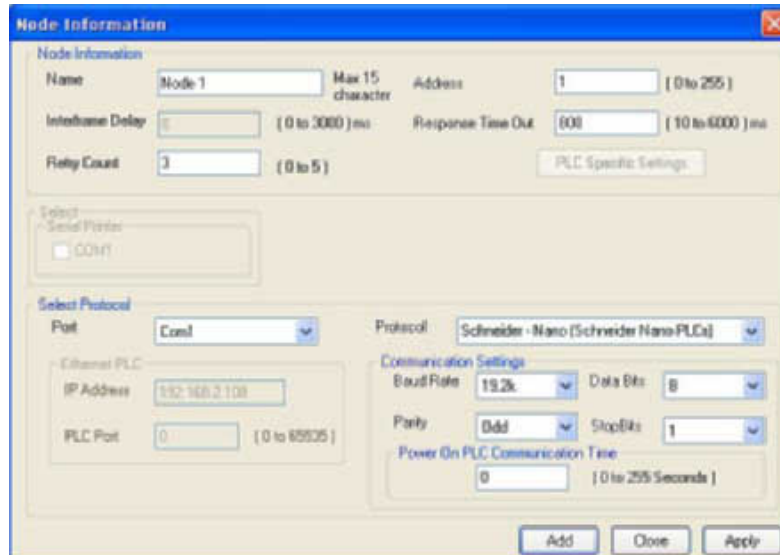

Figure A.34: Node information

- 2 Define the PLC Tag Address MW000 on unit screen.
- 3 Download the Application and Firmware in Unit.

To define the Settings in PLC through PL7Pro Software please follow the following steps.

Using PL7Pro as a client

TSX is a server client protocol. So PLC software PL7Pro can also be one client.

To work the software as a client, some setting has to do. The settings are as follows :

- 1 click on the PLC menu. Click on "Define PLC Address"
- 2 Click on options

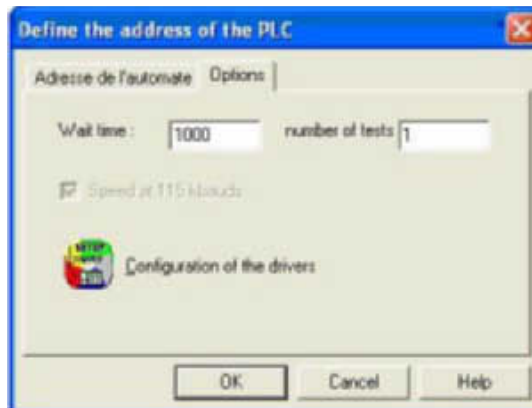

Figure A.35: Options

- 3 Keep wait time as 1000 or 2000
- 4 Click on Configuration of the drivers
- 5 This will pop up a window

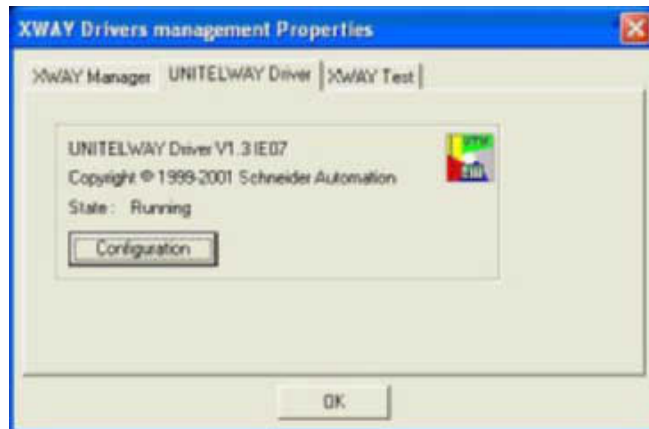

Figure A.36: XWAY Drivers management Properties

- 6 Click on Unitelway driver.
- 7 Click on configuration
- 8 This will pop up an another window :

Here you have to add the number of nodes in Station List that are actually going to be present on your network. If not defined the software will send the EOT to all the tokens except his token. If you had not defined the node then software will send EOT (0x04) to your token also and as you are also sending the command when received your token, then bus contamination will occur. To avoid this define the nodes in station list, so the software will not send the EOT to your client number.

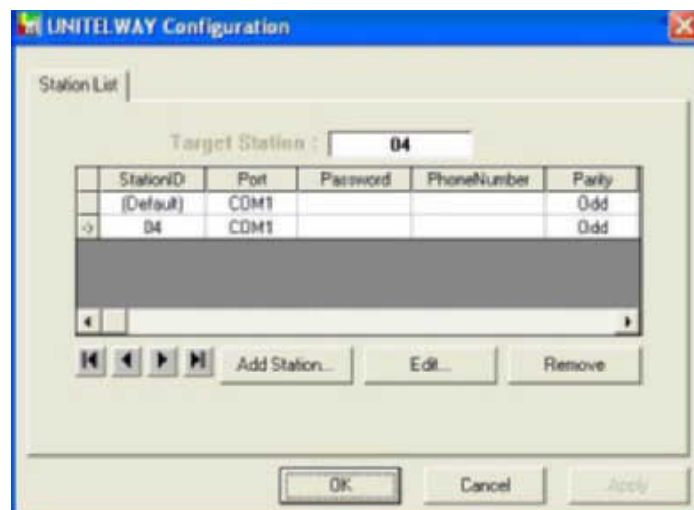

Figure A.37: UNITELWAY Configuration

9 Click on the station ID on default and click on the Edit This will popup a window:

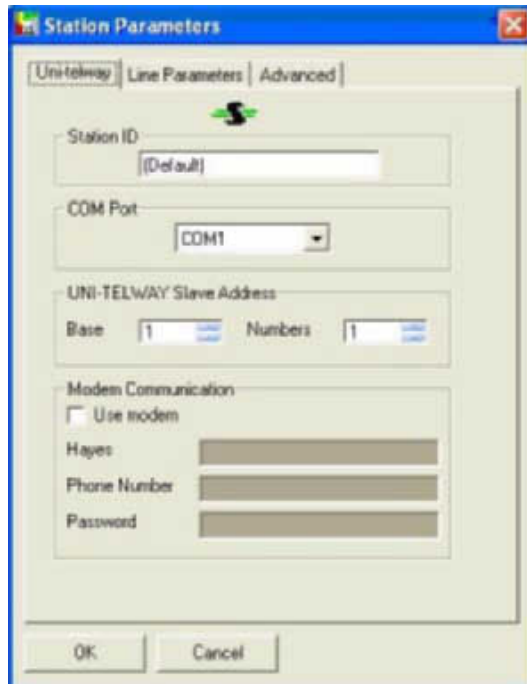

Figure A.38: Station Parameters

Here keep base as 1 and numbers as 1
10 Click on line parameters

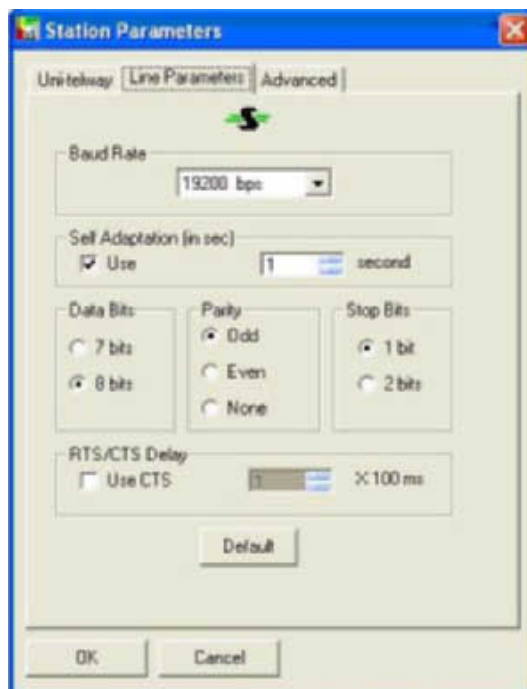

Figure A.39: Station Parameters

Set the baud rate, data bits, parity and number of stop bits. Click on OK and return to Station List window
11 Now add the stations that will be in your network.

Here we want the node 04,so we added that. Enter the Line parameters and Unitelway parameters keep base as 1 and numbers as 4.

Keep the pointer on default station.
 Click **Apply**. This will apply the settings by resetting the Unitelway driver.
 The following message will appear



Figure A.40: Resetting the Unitelway driver

Click on OK
 12 Click on tools. Click on configurations. The following picture will appear:

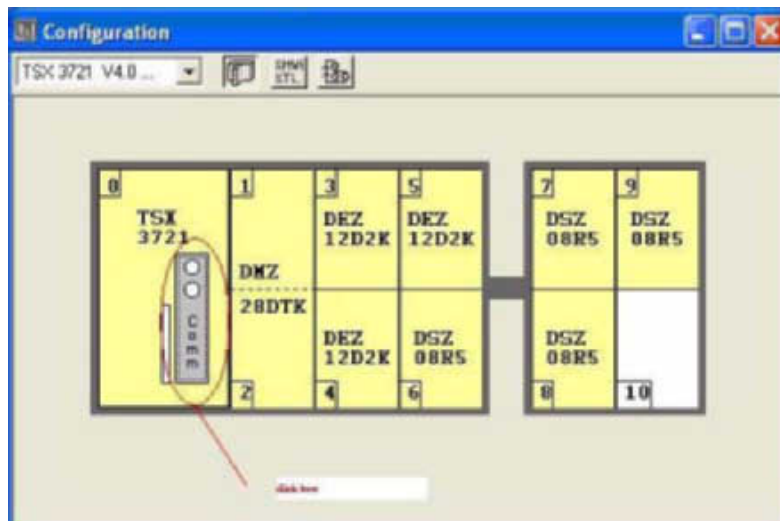

Figure A.41: Configuration

Double click on comm. The new window will appear :

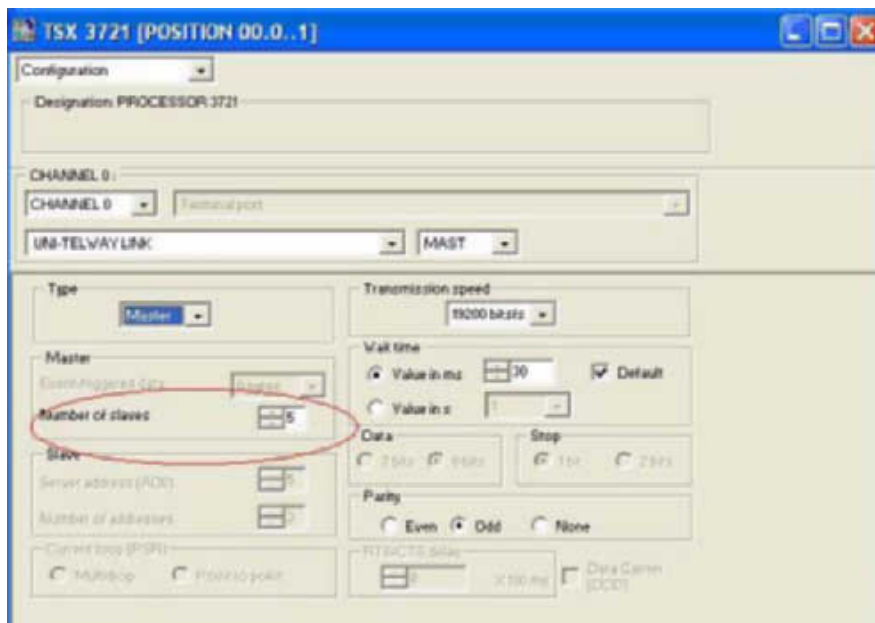

Figure A.42: Configuration - Number of slaves

Keep number of slaves as 5.

In order to increase the communication speed keep the slaves as are in your configuration. This will reduce the number of token sent from the server i.e. the server will send only those number of tokens.

This completes the configuration of the PL7PRO software to act it as a client.

13 Connect the cable to the NQ-Series and PLC. Refer to A-3-10 NQ-Series to Schneider Modicon. Connect the PLC end port to the Schneider PLC. Connect the NQ-Series' male port of the cable to the defined COM1 port of the NQ-Series.

Following the above steps properly will form successful communication between NQ-Series defined with Schneider Nano Driver and PLC.

Note

- Communication parameters defined on the unit's COM1 port and in the PLC settings should match.
- Node ID Set in NQ-Designer node information and communications setup settings from the PLC settings should match.
- PLC cable connected between PLC port and NQ-Series' COM port should be selected correctly.
- Cable should be connected correctly.
- Select a correct tag address and the same tag should be embedded on the unit screen.
- The following messages are displayed on the unit screen if the notes above are not taken into consideration:
 - !!! no connection
 - ??? connection established, address unknown

A-3 Non-Omron devices communication cables

The non-Omron devices communication cables are not available from OMRON.

A-3-1 NQ-Series to AB SLC Series

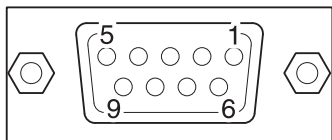

DB9 FEMALE PINOUTS (PLC)

Signals	Pin number
	1
RXD	2
TXD	3
	4
SG	5
	6
RTS	7
CTS	8
	9
Shield wire to DB9 body	

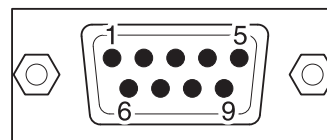

DB9 MALE PINOUTS (NQ)

Pin number	Signals
1	
2	TXD
3	RXD
4	
5	SG
6	
7	
8	
9	
Shield wire to DB9 body	

A-3-2 NQ-Series to AB Micrologix Series

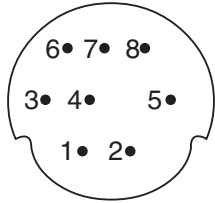

8 PIN MINI DIN CONNECTOR PINOUTS (PLC)

Signals	Pin number
	1
SG	2
	3
RXD	4
	5
	6
TXD	7
	8

shield wire to DB9 body

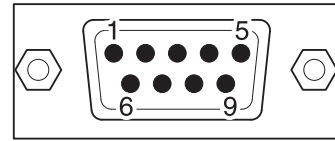

DB9 MALE PINOUTS (NQ)

Pin number	Signals
1	
2	TXD
3	RXD
4	
5	SG
6	
7	
8	
9	

shield wire to DB9 body

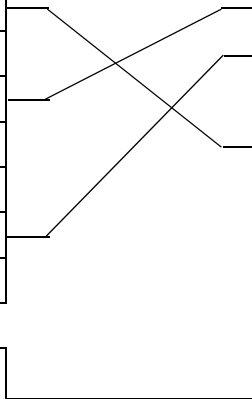

A-3-3 NQ-Series to AB Compact Logix

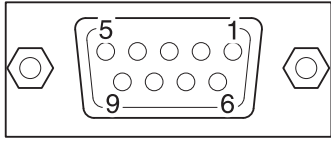

DB9 FEMALE PINOUTS (PLC)

Signals	Pin number
	1
RXD	2
TXD	3
	4
Common	5
	6
RTS	7
CTS	8
	9
shield wire to DB9 body	

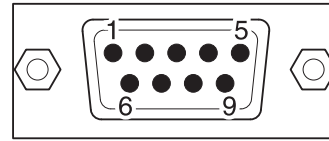

DB9 MALE PINOUTS (NQ)

Pin number	Signals
1	
2	TXD
3	RXD
4	
5	SG
6	
7	
8	
9	
shield wire to DB9 body	

A-3-4 NQ-Series to Siemens S7-200 Series

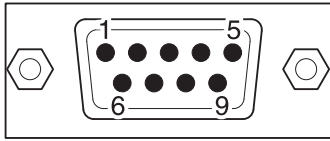

DB9 MALE PINOUTS (PLC)

Signals	Pin number
	1
	2
B	3
	4
SG	5
	6
	7
A	8
	9
shield wire to DB9 body	

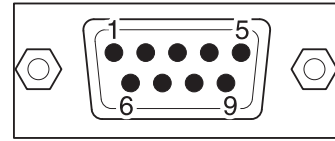

DB9 MALE PINOUTS (NQ)

Pin number	Signals
1	TX+
2	
3	
4	RX+
5	SG
6	
7	
8	TX-
9	RX-
shield wire to DB9 body	

A

B

A-3-5 NQ-Series to Siemens S7-300/400 Series

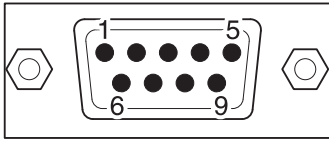

DB9 MALE PINOUTS (PLC)

Signals	Pin number
	1
	2
B	3
	4
SG	5
	6
	7
A	8
	9
shield wire to DB9 body	

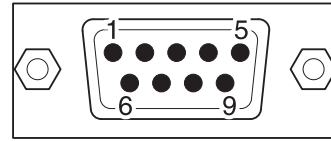

DB9 MALE PINOUTS (NQ)

Pin number	Signals
1	TX+
2	
3	
4	RX+
5	SG
6	
7	
8	TX-
9	RX-
shield wire to DB9 body	

A

B

A-3-6 NQ-Series to Mitsubishi FX PLC (8 Pin Connector)

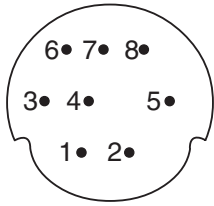

8 PIN MINI DIN CONNECTOR PINOUTS (PLC)

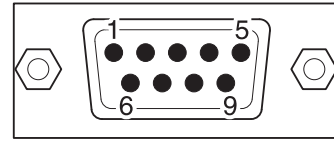

DB9 MALE PINOUTS (NQ)

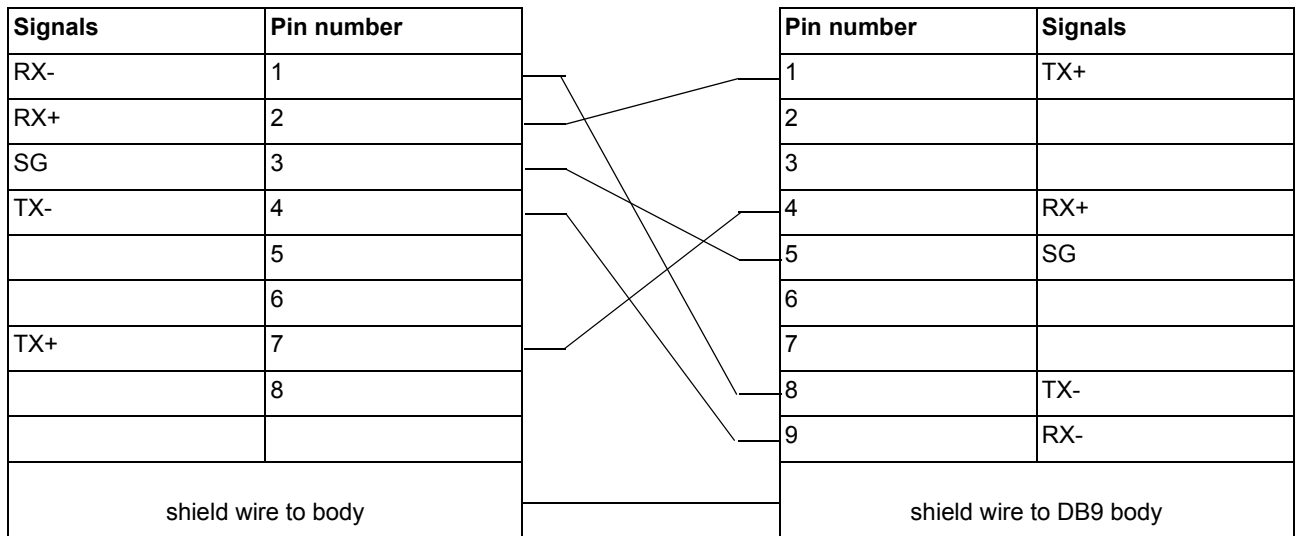

A-3-7 NQ-Series to Mitsubishi FRS Inverter

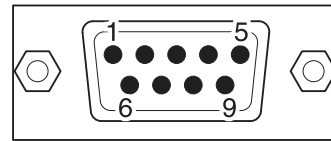
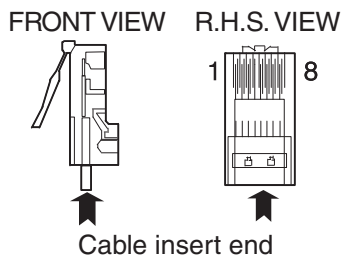

8 PIN MODULAR CONNECTOR
(RJ45 inverter)

DB9 MALE PINOUTS (NQ)

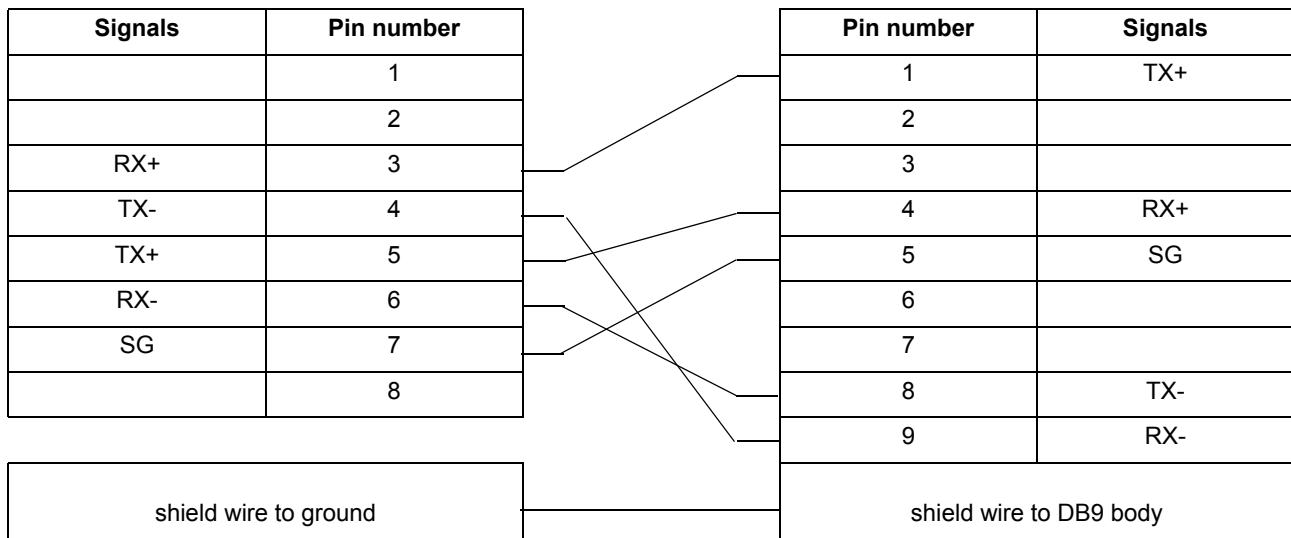

A-3-8 NQ-Series to Schneider Twido

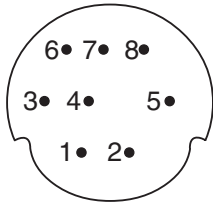

8 PIN MINI DIN CONNECTOR PINOUTS (PLC)

Signals	Pin number
A	1
B	2
	3
	4
	5
	6
SG	7
	8

shield wire to body

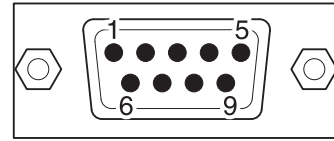

DB9 MALE PINOUTS (NQ)

Pin number	Signals
1	TX+
2	
3	
4	RX+
5	SG
6	
7	
8	TX-
9	RX-

shield wire to DB9 body

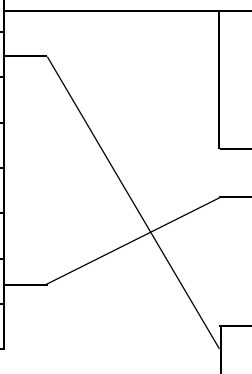

A-3-9 NQ-Series to Schneider Nano

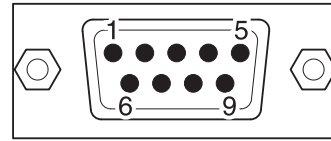
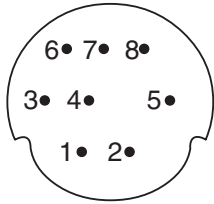

8 PIN MINI DIN CONNECTOR PINOUTS

Signals	Pin number
A	1
B	2
	3
	4
	5
	6
SG	7
	8

DB9 MALE PINOUTS

Pin number	Signals
1	TX+
2	
3	
4	RX+
5	SG
6	
7	
8	TX-
9	RX-

shield wire to body

shield wire to DB9 body

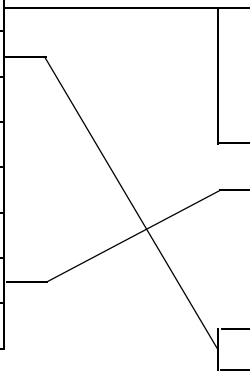

A-3-10 NQ-Series to Schneider Modicon

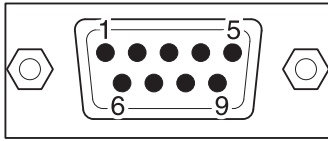

DB9 MALE PINOUTS (PLC)

Signals	Pin number
	1
RXD	2
TXD	3
DTR	4
SG	5
DSR	6
RTS	7
CTS	8
	9
shield wire to DB9 body	

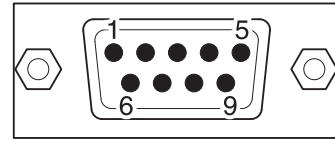

DB9 MALE PINOUTS (NQ)

Pin number	Signals
1	
2	TXD
3	RXD
4	
5	SG
6	
7	
8	
9	
shield wire to DB9 body	

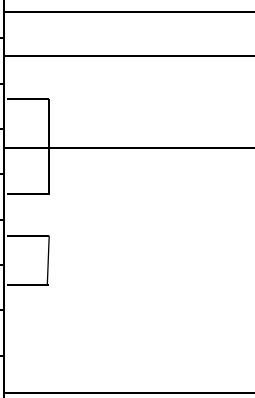

Revision history

Revision history

A manual revision code appears as a suffix to the catalogue number on the front cover of the manual.

Cat. No. V07-EN-02



Revision code

The following table outlines the changes made to the manual during each revision. The page numbers of a revision refer to the previous version.

Revision code	Date	Revised content
01	June 2009	First version
02	May 2011	