

SIMATIC



ET 200S distributed I/O Digital electronic module 8DO DC24V/0.5 A (6ES7132-4BF00-0AA0)

Manual

Legal information

Warning notice system

This manual contains notices you have to observe in order to ensure your personal safety, as well as to prevent damage to property. The notices referring to your personal safety are highlighted in the manual by a safety alert symbol, notices referring only to property damage have no safety alert symbol. These notices shown below are graded according to the degree of danger.

 DANGER
indicates that death or severe personal injury will result if proper precautions are not taken.
 WARNING
indicates that death or severe personal injury may result if proper precautions are not taken.
 CAUTION
indicates that minor personal injury can result if proper precautions are not taken.
NOTICE
indicates that property damage can result if proper precautions are not taken.

If more than one degree of danger is present, the warning notice representing the highest degree of danger will be used. A notice warning of injury to persons with a safety alert symbol may also include a warning relating to property damage.

Qualified Personnel

The product/system described in this documentation may be operated only by **personnel qualified** for the specific task in accordance with the relevant documentation, in particular its warning notices and safety instructions. Qualified personnel are those who, based on their training and experience, are capable of identifying risks and avoiding potential hazards when working with these products/systems.

Proper use of Siemens products

Note the following:

 WARNING
Siemens products may only be used for the applications described in the catalog and in the relevant technical documentation. If products and components from other manufacturers are used, these must be recommended or approved by Siemens. Proper transport, storage, installation, assembly, commissioning, operation and maintenance are required to ensure that the products operate safely and without any problems. The permissible ambient conditions must be complied with. The information in the relevant documentation must be observed.

Trademarks

All names identified by ® are registered trademarks of Siemens AG. The remaining trademarks in this publication may be trademarks whose use by third parties for their own purposes could violate the rights of the owner.

Disclaimer of Liability

We have reviewed the contents of this publication to ensure consistency with the hardware and software described. Since variance cannot be precluded entirely, we cannot guarantee full consistency. However, the information in this publication is reviewed regularly and any necessary corrections are included in subsequent editions.

Preface

Purpose of the manual

This manual supplements the *ET 200S Distributed I/O System* Operating Instructions. General functions for the ET 200S are described in the ET 200S Distributed I/O System Operating Instructions (<http://support.automation.siemens.com/WW/view/en/1144348>).

The information in this document along with the operating instructions enables you to commission the ET 200S.

Basic knowledge requirements

To understand these operating instructions you should have general knowledge of automation engineering.

Scope of the manual

This manual applies to this ET 200S module. It describes the components that are valid at the time of publication.

Recycling and disposal

Thanks to the fact that it is low in contaminants, this ET 200S module is recyclable. For environmentally compliant recycling and disposal of your electronic waste, please contact a company certified for the disposal of electronic waste.

Additional support

If you have any questions relating to the products described in this manual and do not find the answers in this document, please contact your local Siemens representative (<http://www.siemens.com/automation/partners>).

A guide to the technical documentation for the various SIMATIC products and systems is available on the Internet. (<http://www.siemens.com/simatic-docu>).

The online catalog and ordering systems are available on the Internet (<http://www.siemens.com/automation/mall>).

Training center

We offer courses to help you get started with the ET 200S and the SIMATIC S7 automation system. Please contact your regional training center or the central training center in D -90327, Nuremberg, Germany (<http://www.siemens.com/sitrain>).

Technical Support

You can contact Technical Support for all Industry Automation products by means of the Internet Web form for the Support Request (http://www.siemens.com/automation/csi_en_WW/support_request).

Additional information about Siemens Technical Support is available on the Internet (http://www.siemens.com/automation/csi_en_WW/service).

Service & Support on the Internet

In addition to our documentation, we offer a comprehensive knowledge base on the Internet (http://www.siemens.com/automation/csi_en_WW/support).

There you will find:

- Our Newsletter, which constantly provides you with the latest information about your products.
- The right documentation for you using our Service & Support search engine.
- The bulletin board, a worldwide knowledge exchange for users and experts.
- Your local contact for Automation & Drives in our contact database.
- Information about on-site services, repairs, spare parts, and lots more.

Table of contents

- Preface 3**
- 1 Properties 6**
 - 1.1 Digital electronic module 8DO DC24V/0.5 A (6ES7132-4BF00-0AA0) 6
- 2 Diagnostics 12**
 - 2.1 Diagnostics using LED display 12
- Index..... 13**

Properties

1.1 Digital electronic module 8DO DC24V/0.5 A (6ES7132-4BF00-0AA0)

Properties

- Digital electronic module with eight outputs
- Output current 0.5 A per output, total current 4 A
- Rated load voltage 24 V DC
- Short-circuit protection
- Suitable for solenoid valves, DC contactors, and indicator lights
- Supports isochronous operation

Special features

When the rated load voltage 24 V DC is applied to the power module via a mechanical contact, the digital outputs carry a "1" signal for about 50 μ s for switching reasons. You have to take this into consideration if you use this module in connection with high-speed counters.

Requirements for operation

It is possible to operate the 8DO DC24V 0.5A digital electronic module using the following interface modules with the order numbers specified (or higher). The interface modules listed in the table are not subject to any constraints.

Interface module	Order number (or higher)	Firmware version (or higher)
IM 151-1 STANDARD	6ES7151-1AA03-0AB0	---
IM 151-1 FO STANDARD	6ES7151-1AB02-0AB0	---
IM 151-1 HIGH FEATURE	6ES7151-1BA01-0AB0	V2.1.3
IM 151-3 PN	6ES7151-3AA20-0AB0	V4.0.1
IM 151-3 PN HIGH FEATURE	6ES7151-3BA20-0AB0	
IM 151-3 PN FO	6ES7151-3BB21-0AB0	

General terminal assignment

Note

Terminals A4, A8, A3 and A7 are only available at specified terminal modules.

Terminal assignment for 8DO DC24V/0.5A (6ES7132-4BF00-0AA0)				
Terminal	Allocation	Terminal	Allocation	Notes
1	DO ₀	5	DO ₁	<ul style="list-style-type: none"> DO_n: Output signal, channel n AUX1: Mass M (from power module) or voltage bus (freely usable up to 230 V AC)
2	DO ₂	6	DO ₃	
3	DO ₄	7	DO ₅	
4	DO ₆	8	DO ₇	
A4	AUX1	A8	AUX1	
A3	AUX1	A7	AUX1	

Usable terminal modules

Usable terminal modules for 8DO DC24V/0.5A (6ES7132-4BF00-0AA0)		
TM-E15C26-A1 (6ES7193-4CA50-0AA0)	TM-E15C24-01 (6ES7193-4CB30-0AA0)	← Spring terminal
TM-E15S26-A1 (6ES7193-4CA40-0AA0)	TM-E15S24-01 (6ES7193-4CB20-0AA0)	← Screw-type terminal
TM-E15N26-A1 (6ES7193-4CA80-0AA0)	TM-E15N24-01 (6ES7193-4CB70-0AA0)	← Fast Connect
		<p>Connection examples</p>

2-wire connection

The following configuration example shows a two-wire connection with the electronic modules 8DO DC24V. You require further terminals so that sufficient terminals are available for the mass M connection when the TM-E15S26-A1 terminal modules are used. In the example this is implemented by the add-on terminal TE-U120S4x10, which you can mount as of a width of 120 mm (8 EMs). You can naturally also use other terminals for this configuration (for example, ET 200S potential distribution module 4POTDIS).

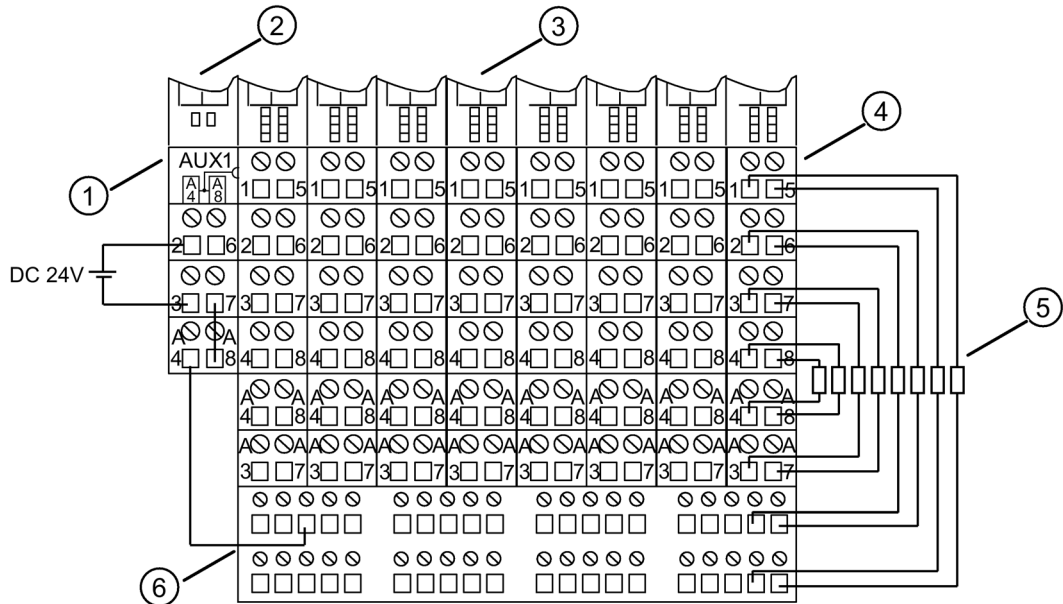

- ① Terminal module TM-P15S23-A0
- ② Power module PM-E 24 VDC
- ③ Electronic modules 8DI DC24V
- ④ Terminal modules TM-E15S26-A1
- ⑤ Actuator in 2-wire connection
- ⑥ Add-on terminal TE-U120S4x10

Block diagram

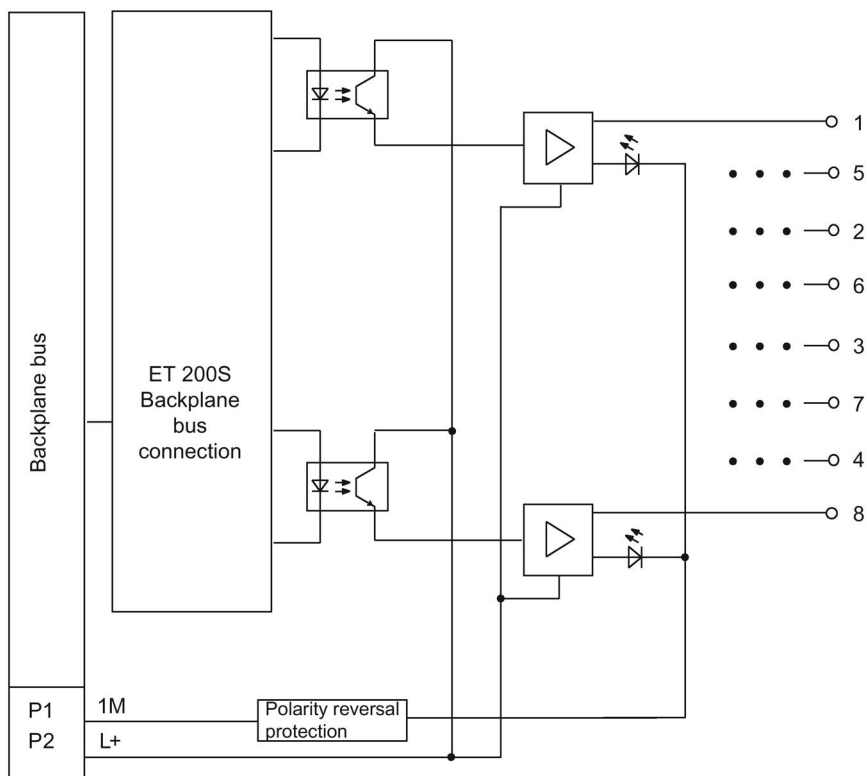

Figure 1-1 Block diagram of the 8DO DC24V 0.5A

Technical specifications 8DO DC24V/0.5A (6ES7132-4BF00-0AA0)

Technical specifications 8DO DC24V/0.5A (6ES7132-4BF00-0AA0)	
Dimensions and weight	
Width (mm)	15
Weight	Approx. 40 g
Module-specific data	
Supports isochronous operation	Yes
Number of outputs	8
Cable length	
• Unshielded	Max. 600 m
• Shielded	Max. 1000 m
Parameter length	3 bytes
Address space	1 byte
Voltages, currents, potentials	
Rated load voltage L+ (from power module)	24 V DC
• Polarity reversal protection	Yes ¹
Total current of the outputs (per module)	4 A
Electrical isolation	
• Between the channels	No
• Between the channels and backplane bus	Yes
Permissible potential difference	
• Between different circuits	75 V DC / 60 V AC
Isolation tested	500 V DC
Current consumption	
• From the rated load voltage L+ (no load)	Max. 5 mA per channel
Power loss of the module	Typically 1.5 W
Status, interrupts, diagnostics	
Status display	Green LED per channel
Diagnostics functions	No

Technical specifications 8DO DC24V/0.5A (6ES7132-4BF00-0AA0)	
Actuator selection data	
Output voltage	
• At signal "1"	Min. L+ (-1 V)
Output current	
• At signal "1"	0.5 A
– Rated value	7 mA to 0.6 A
– Permissible range	
• At "0" signal (residual current)	Max. 0.3 mA
Output delay (with resistive load)	
• At "0" to "1"	Max. 300 μ s
• At "1" to "0"	Max. 600 μ s
Load resistance range	48 Ω to 3.4 k Ω
Lamp load	Max. 5 W
Parallel switching of 2 outputs	
• For redundant control of a load	Yes (per module)
• For increased performance	No
Control of a digital input	Yes
Switching frequency	
• With resistive load	100 Hz
• With inductive load	2 Hz
• With lamp load	10 Hz
Limiting (internal) of inductive shut-down voltage	Typ. L+ (-55 to -60 V)
Reverse-voltage proof	Yes, if using the same load voltage as at the power module
Short-circuit protection of the output	Yes ²
• Response threshold	Typ. 1.5 A

¹⁾ Polarity reversal can lead to the digital outputs being switched through.

² per channel

Diagnostics

2.1 Diagnostics using LED display

LED display

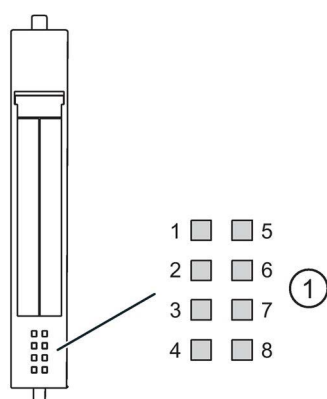

① Status display for output status (green)

Status and error displays

Event (LEDs)								Cause	Remedy
1	5	2	6	3	7	4	8		
On								Output on channel 0 activated.	—
	On							Output on channel 1 activated.	—
		On						Output on channel 2 activated.	—
			On					Output on channel 3 activated.	—
				On				Output on channel 4 activated.	—
					On			Output on channel 5 activated.	—
						On		Output on channel 6 activated.	—
							On	Output on channel 7 activated.	—

Index

2

2-wire connection, 8

B

Basic knowledge requirements, 3

Block diagram, 9

D

Disposal, 3

I

Internet

Service & Support, 4

L

LED display, 12

P

Properties, 6

R

Recycling, 3

S

Scope

Manual, 3

Service & Support, 4

T

Technical specifications, 10

Technical Support, 4

Terminal assignment, 7

Training Center, 4

