

EDH8200UE
00406193

Lenze

Manual



Global Drive
Frequency inverters 8200

This Manual is valid for 82XX controllers as of version:

	33.820X-	E-	1x.	1x		(8201 - 8204)
	33.8202-	E-	1x.	1x	-V002	Reduced assembly depth (8202)
	33.821X-	E-	0x.	1x		(8211 - 8218)
	33.821X-	E-	1x.	2x		(8211 - 8218)
	33.821X-	C-	1x.	2x	-V003	Cold plate (8215 - 8218)
	33.821X-	E-	3a.	3x	-V020	HVAC (8211 - 8218)
	33.822X-	E-	0x.	0x		(8221 - 8227)
	33.822X-	C-	1x.	2x	-V003	Cold plate (8221 - 8222)
	33.822X-	E-	3a.	3x	-V020	HVAC (8221 - 8227)
	33.824X-	E-	1x.	1x		(8241 - 8246)
	33.824X-	C-	1x.	1x	-V003	Cold plate (8241 - 8246)
	33.824X-	E-	3a.	3x	-V020	HVAC (8241 - 8246)
Type						
Design: B = Module C = Cold plate E = Built-in unit IP20						
Hardware version and index						
Software version and index						
Variant						
Explanation						

		revised	
Edition of:	01/1999		

Contents of the Manual				
Part	Contents	Material number	Edition of	Note
A	Table of contents Preface and general information Safety information	406181	01/99	
B	Technical data Installation	406182	01/99	
C	Commissioning During operation	406183	01/99	
D	Configuration	406184	01/99	
D1	Code table for series "Standard"	406185	01/99	
D2	Code table for series "HVAC"	406186	01/99	
E	Troubleshooting and fault elimination Maintenance	406187	01/99	
F	Network of several drives	406188	01/99	
		399907	02/98	Operating Instructions for regenerative power supply unit 9340
G	Application of brake units	393658	12/96	Operating Instructions for brake unit 8250
		394036	01/97	Operating Instructions for brake unit 9350
H	Automation	404788	11/98	Operating Instructions for fieldbus module 2102
		393434	12/96	Operating Instructions for fieldbus module 2111
		394179	01/97	Operating Instructions for fieldbus module 2131
		402381	06/98	Operating Instructions for fieldbus module 2171/2172
		391883	08/96	Operating Instructions PTC input module 8274
		391882	08/96	Operating Instructions I/O module 8275
		402956	11/96	Flyer: PC software Global Drive Control
I	Accessories and motors	406189	01/99	Overview
		403236	12/96	Catalog: Frequency inverter 8200
		401950	11/96	Flyer: Three-phase AC motors
K	Selection help Application examples	406190	01/99	
L	Signal-flow charts	406191	01/99	
M	Glossary Table of keywords	406192	01/99	
N				
O				
P				

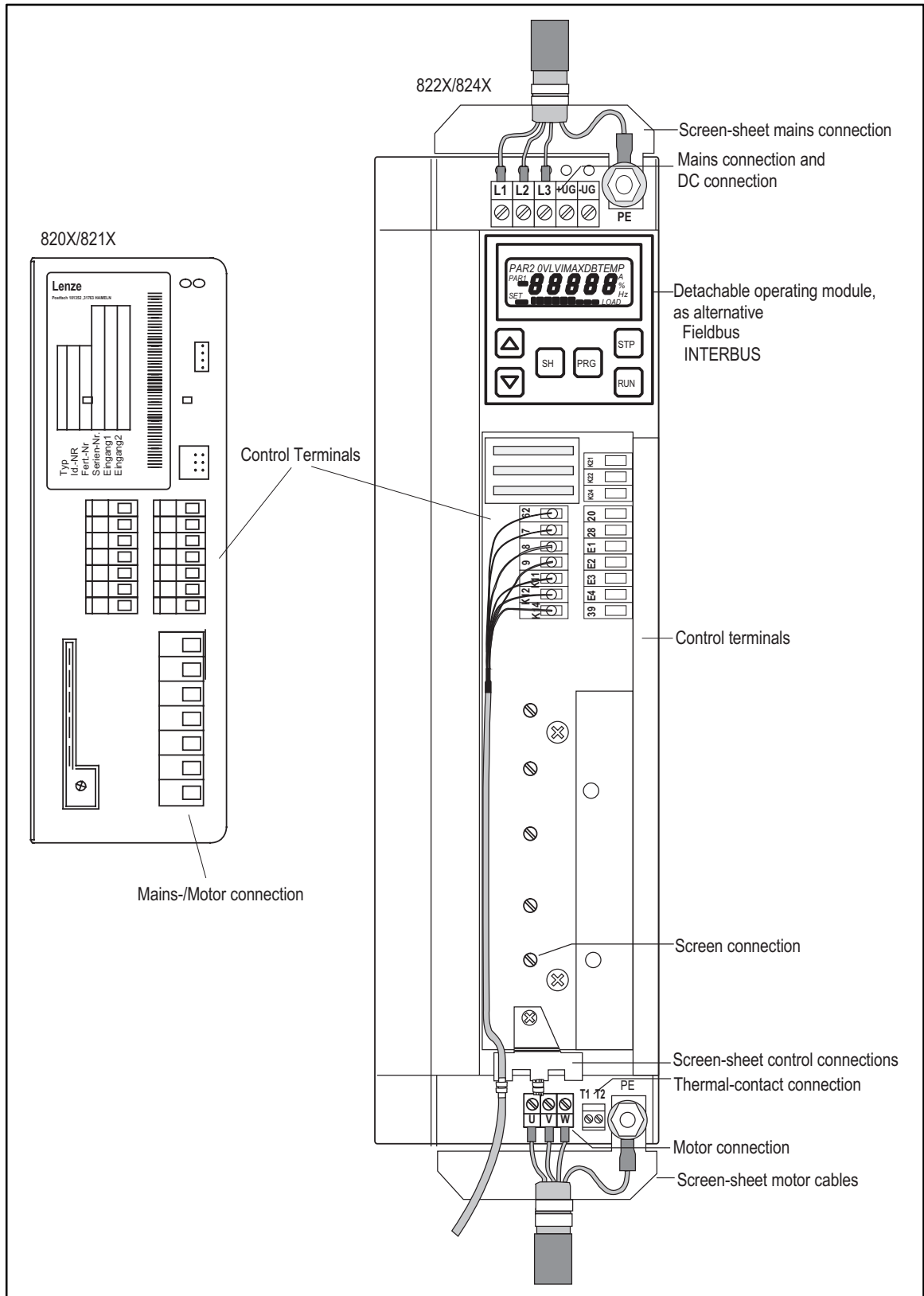

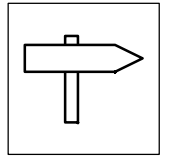

Part A

1	Preface and general information	1-1
1.1	How to use this Manual	1-1
1.1.1	Terminology used	1-1
1.2	Scope of delivery	1-1
1.3	Legal regulations	1-3
1.4	EC Directives/Declaration of Conformity	1-4
1.4.1	What is the purpose of EC directives?	1-4
1.4.2	What does the CE mark imply?	1-4
1.4.3	EC Low-Voltage Directive	1-5
1.4.4	EC Directive Electromagnetic Compatibility	1-7
1.4.5	EC Machinery Directive	1-11
2	Safety information	2-1
2.1	General safety information	2-1
2.2	Layout of the safety information	2-2
2.3	Residual hazards	2-2

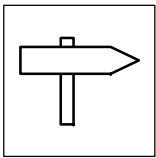

Part B

3	Technical data	3-1
3.1	Overview of types	3-1
3.2	Features	3-2
3.3	General data/application conditions	3-4
3.4	Rated data (Operation with 150 % overload)	3-5
3.4.1	Types 8201 to 8204	3-5
3.4.2	Types 8211 to 8214	3-6
3.4.3	Types 8215 to 8218	3-8
3.4.4	Types 8221 to 8224	3-10
3.4.5	Types 8225 to 8227	3-12
3.4.6	Types 8241 to 8243	3-14
3.4.7	Types 8244 to 8246	3-16
3.5	Rated data (Operation with 120 % overload)	3-18
3.5.1	Operating conditions	3-18
3.5.2	Types 821X	3-18
3.5.3	Types 822X	3-19
3.5.4	Types 824X	3-20
3.6	Fuses and cable cross-sections	3-21
3.6.1	Operation of controllers in UL-approved systems	3-21
3.6.1.1	Protection of the motor cables	3-21
3.6.2	Single drives with 150 % overload	3-22
3.6.3	Single drives with 120 % overload	3-23
3.7	Analog plug-in module 8279IB	3-24
3.7.1	Features	3-24
3.8	Dimensions	3-25
3.8.1	Analog plug-in module	3-25

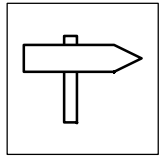

4	Installation	4-1
4.1	Mechanical installation	4-1
4.1.1	Important notes	4-1
4.1.2	Standard assembly with fixing rails or fixing brackets	4-3
4.1.2.1	Types 8201 to 8204	4-3
4.1.2.2	Type 8202-V002 (reduced assembly depth)	4-3
4.1.2.3	Types 8211 to 8214	4-4
4.1.2.4	Types 8215 to 8218	4-5
4.1.2.5	Types 8221 to 8227	4-6
4.1.2.6	Types 8241 to 8246	4-7
4.1.3	DIN-rail assembly	4-8
4.1.3.1	Types 8201 to 8204	4-8
4.1.3.2	Types 8211 to 8214	4-9
4.1.4	Assembly with thermally separated power stage ("push-through technique")	4-10
4.1.4.1	Types 8215 to 8218	4-11
4.1.4.2	Types 8221 to 8227	4-12
4.1.4.3	Types 8241 to 8246	4-13
4.1.5	Assembly of the variant 82XX-V003 "cold plate"	4-14
4.1.5.1	General	4-14
4.1.5.2	Demands on the cooler	4-15
4.1.5.3	Thermal performance of the system	4-16
4.1.5.4	Assembly preparations	4-17
4.1.5.5	Assembly of 821X-C-V003	4-18
4.1.5.6	Assembly of 822X-C-V003	4-21
4.1.5.7	Assembly of 824X-C-V003	4-22
4.1.6	Assembly with mains filter	4-23
4.1.7	Assembly of the analog plug-in module 8279IB	4-24
4.2	Electrical installation	4-25
4.2.1	Operator's safety	4-25
4.2.2	Protection of the controllers	4-26
4.2.3	Motor protection	4-26
4.2.4	Mains types/mains conditions	4-27
4.2.5	Combination with compensation equipment	4-27
4.2.6	Specification of the cables used	4-27
4.2.7	Power connections	4-28
4.2.7.1	Mains connection	4-28
4.2.7.2	Motor connection	4-29
4.2.7.3	Connection of a brake unit	4-34
4.2.7.4	Connection plan 820X	4-35
4.2.7.5	Connection plan 821X	4-36
4.2.7.6	Connection plan 822X/824X	4-37
4.2.8	Control connections	4-38
4.2.8.1	Control cables	4-38
4.2.8.2	Assignment of the control terminals	4-38
4.2.8.3	Connection diagrams	4-41
4.2.8.4	Connection diagrams: Analog plug-in module	4-42
4.3	Installation of a CE-typical drive system	4-43

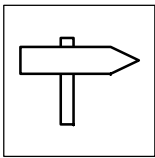

Part C

5	Commissioning	5-1
5.1	Before switching on	5-1
5.2	Short commissioning (factory setting)	5-2
5.2.1	Switch-on sequence	5-2
5.2.2	Factory setting of the most important drive parameters	5-2
5.3	Adapt machine data	5-3
5.3.1	Determine speed range (fdmin, fdmax)	5-3
5.3.2	Setting of acceleration and deceleration times (Tir, Tif)	5-4
5.3.3	Setting of current limit values (Imax limits)	5-5
5.4	Optimisation of the operating behaviour	5-6
5.4.1	Select control mode	5-6
5.4.2	Optimising operating modes	5-8
5.4.2.1	Optimising motor-current control (C014 = -4-)	5-8
5.4.2.2	Optimise V/f-characteristic control with auto boost (C014 = -0-/-1-)	5-10
5.4.2.3	Optimise V/f-characteristic control with constant Vmin boost (C014 = -2-/-3-)	5-12
5.4.2.4	Normalisation of an application datum	5-15
5.4.3	Operation with PID controller	5-16
5.5	Application examples for PID controllers	5-18
5.5.1	Pump application with pressure control	5-18
5.5.2	Pump application with level control	5-21
5.5.3	Dancer-position control (line drive)	5-23
5.5.4	Air conditioning system	5-26
6	During operation	6-1
6.1	Operating information	6-1
6.1.1	General	6-1
6.1.2	822X/824X	6-2
6.1.3	8218-V003	6-2
6.2	Display of the controller status	6-2

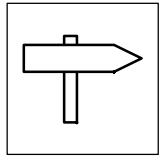

Part D

7	Configuration	7-1
7.1	8201BB operating module	7-2
7.2	Structure of the operating program	7-4
7.2.1	Operating level	7-4
7.2.2	Code level	7-4
7.2.3	Parameter level	7-5
7.3	Change and store parameters	7-5
7.3.1	Change and store parameters with the 8201BB operating module	7-6
7.3.2	Change and store parameters with fieldbus modules.	7-8
7.3.3	Dynamic parameter change	7-8
7.4	Operating functions	7-9
7.4.1	Operating mode	7-9
7.4.2	Working with parameter sets	7-10
7.4.3	Change parameter set via DC-bus voltage	7-12
7.4.3.1	AC-motor braking by means of parameter set changeover	7-12
7.4.3.2	Automatic parameter set changeover for controlled deceleration in the event of mains failure	7-13
7.5	Control functions	7-15
7.5.1	Speed range (fdmin, fdmax)	7-15
7.5.2	Acceleration and deceleration times T _{ir} , T _{if}	7-16
7.5.3	Current limit values (I _{max} limit values)	7-17
7.5.4	Current limitation controller (I _{max} controller)	7-18
7.5.5	Control mode	7-19
7.5.6	V/f characteristic	7-22
7.5.6.1	V/f-rated frequency f _{dr}	7-22
7.5.6.2	V _{min} setting	7-24
7.5.7	Configuration	7-26
7.5.8	Motor data detection	7-27
7.5.9	Running optimisation	7-28
7.5.9.1	Slip compensation	7-28
7.5.9.2	Chopper frequency	7-29
7.5.9.3	Oscillation damping	7-31
7.5.9.4	Ramp function generator S-shape	7-32
7.5.9.5	Skip frequencies	7-33
7.5.10	PID controller as process controller	7-34
7.5.10.1	Reset integral component and influence	7-38
7.5.10.2	Setpoint selection for the process controller	7-38
7.5.10.3	Frequency precontrol	7-39
7.5.10.4	Frequency setting range	7-39
7.5.11	Setpoint input	7-40
7.5.11.1	Analog setpoint input	7-40
7.5.11.2	Setpoint input using the keypad	7-42
7.5.11.3	Setpoint input via JOG frequencies	7-43
7.5.11.4	Setpoint input via function "Motor potentiometer"	7-44
7.5.11.5	Setpoint input via of the function "Motor potentiometer in combination with JOG value"	7-46
7.5.11.6	Setpoint sum	7-47

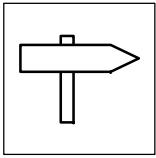

Contents

7.5.12	Controller enable RFR	7-48
7.5.13	Start conditions/flying-restart circuit	7-49
7.5.14	Function of the inputs to be configured block by block	7-50
7.5.14.1	Level inversion for digital inputs	7-52
7.5.14.2	Priority mask for digital inputs	7-53
7.5.14.3	Change of the direction of rotation (CW/CCW)	7-54
7.5.14.4	Quick stop QSP	7-55
7.5.14.5	DC-injection brake (DCB)	7-56
7.5.14.6	Parameter set changeover PAR	7-58
7.5.14.7	TRIP set	7-58
7.5.14.8	Manual/remote changeover	7-59
7.5.14.9	Digital frequency input	7-60
7.5.15	Indirect torque limitation	7-61
7.6	Display functions	7-62
7.6.1	Display values	7-62
7.6.2	Switch-on display	7-62
7.6.3	Normalisation of an application datum	7-63
7.6.4	Elapsed operating time meter	7-64
7.6.5	Software version and controller type	7-64
7.7	Monitoring functions	7-65
7.7.1	Relay outputs	7-65
7.7.2	Analog output	7-69
7.7.3	Thermal motor monitoring	7-71
7.7.3.1	I ² x t monitoring	7-71
7.7.3.2	PTC input	7-72
7.7.4	Motor-phase failure detection	7-73

Part D1

7.8	Code table for "Standard" series	7-77
-----	--	------

Part D2

7.9	Code table for "HVAC" series	7-85
-----	--	------

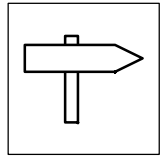

Part E

8	Troubleshooting and fault elimination	8-1
8.1	Troubleshooting	8-1
8.1.1	Display at the controller	8-1
8.1.2	Display at the operating module	8-1
8.1.3	Maloperation of the drive	8-2
8.2	Fault analysis with the history buffer	8-2
8.3	Fault messages	8-2
8.4	Reset of fault messages	8-4
9	Maintenance	9-1
9.1	Maintenance services	9-1
9.2	Service addresses	9-2

Part F

10	Network of several drives	10-1
10.1	Function	10-1
10.2	Conditions for trouble-free network operation	10-2
10.2.1	Possible combinations	10-2
10.2.2	Mains connection	10-3
10.2.2.1	Cable protection/cable cross-section	10-3
10.2.2.2	Mains choke/mains filter	10-3
10.2.2.3	Controller protection	10-3
10.2.3	DC-bus connection	10-4
10.2.4	Fuses and cable cross-sections for a network of several drives	10-6
10.2.5	Protection in networks of several drives	10-7
10.3	Selection basics	10-9
10.3.1	Conditions	10-9
10.3.2	Selection example for 4 drives	10-12
10.3.2.1	Supply only via controllers	10-12
10.3.2.2	Supply by means of 934X supply and feedback module	10-13
10.4	Central supply	10-14
10.4.1	Central supply of 820X	10-14
10.4.2	Central supply via 934X for 821X/822X/824X/93XX	10-15
10.5	Decentral supply	10-16
10.5.1	Decentral supply for 820X	10-16
10.5.2	Central supply for 821X/822X/824X/93XX/934X	10-17

See also table of contents of the attached Operating Instructions

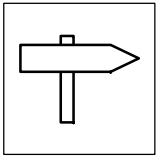

Part G

11 Application of brake units

See: Table of contents of the attached Operating Instructions

Part H

12 Automation

See: Table of contents of the attached Operating Instructions

Part I

13 Accessories (Survey)	13-1
13.1 Accessories for all types	13-1
13.2 Software	13-1
13.3 Type-specific accessories	13-2
13.3.1 Types 820X	13-2
13.3.2 Types 821X	13-3
13.3.3 Types 822X	13-4
13.3.4 Types 824X	13-5

Part K

14 Selection help	14-1
15 Application examples	15-1
15.1 Pump application with pressure control	15-1
15.2 Pump application with level control	15-4
15.3 Dancer-position control (line drive)	15-6
15.4 Air conditioning system	15-8

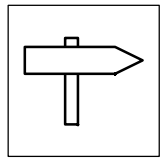

Part L

16	Signal-flow charts	16-1
16.1	Signal-flow chart for types 820X	16-2
16.1.1	Control structure	16-2
16.1.2	Inverter control	16-3
16.1.3	Monitorings	16-3
16.2	Signal-flow charts for types 821X/822X/824X	16-4
16.2.1	Control structure control mode V/f control	16-4
16.2.2	Control structure control mode motor current control	16-5
16.2.3	Inverter control	16-6
16.2.4	Monitorings	16-6
16.3	Signal-flow charts for types 821X/822X/824X-HVAC	16-7
16.3.1	Process and speed controller for C005 = -0-	16-7
16.3.2	Process and speed controller for C005 = -1- ... -7-	16-8

Part M

17	Glossary	17-1
18	Table of keywords	18-1

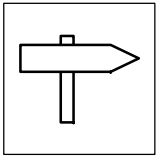

Contents

Manual

Part A

Table of contents

Preface and general information

Safety information

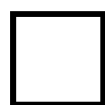

Global Drive

Frequency inverters 8200

This Manual is valid for 82XX controllers as of version:

	33.820X-	E-	1x.	1x		(8201 - 8204)
	33.8202-	E-	1x.	1x	-V002	Reduced assembly depth (8202)
	33.821X-	E-	0x.	1x		(8211 - 8218)
	33.821X-	E-	1x.	2x		(8211 - 8218)
	33.821X-	C-	1x.	2x	-V003	Cold plate (8215 - 8218)
	33.821X-	E-	3a.	3x	-V020	HVAC (8211 - 8218)
	33.822X-	E-	0x.	0x		(8221 - 8227)
	33.822X-	C-	1x.	2x	-V003	Cold plate (8221 - 8222)
	33.822X-	E-	3a.	3x	-V020	HVAC (8221 - 8227)
	33.824X-	E-	1x.	1x		(8241 - 8246)
	33.824X-	C-	1x.	1x	-V003	Cold plate (8241 - 8246)
	33.824X-	E-	3a.	3x	-V020	HVAC (8241 - 8246)
Type						
Design: B = Module C = Cold plate E = Built-in unit IP20						
Hardware version and index						
Software version and index						
Variant						
Explanation						

		revised	
Edition of:	01/1999		



1 Preface and general information

1.1 How to use this Manual

- This Manual completes the Operating Instructions for 82XX frequency inverters.
- It contains the Operating Instructions and additional information on planning, adaptability and the accessories valid at the time of printing.
 - In case of doubt, refer to the Operating Instructions delivered with the 82XX frequency inverters.
- The Manual is a help to select and adapt the 82XX frequency inverters and the accessories to ensure safe and trouble-free operation. It contains safety information which must be observed.
- The Manual must always be in a complete and perfectly readable state.

1.1.1 Terminology used

Term	In the following text used for
82XX	Any frequency inverter of the series 8200, 8210, 8220, 8240
Controllers	82XX frequency inverter
Drive system	Drive systems with 82XX frequency inverters and other Lenze drive components

1.2 Scope of delivery

Scope of delivery	Important
<ul style="list-style-type: none">• 1 82XX frequency inverter• 1 Operating Instructions• 1 accessory kit (components and pieces for mechanical and electrical installation)	<p>After reception of the delivery, check immediately whether the scope of supply matches the accompanying papers. Lenze does not accept any liability for deficiencies claimed subsequently.</p> <p>Claim</p> <ul style="list-style-type: none">• visible transport damage immediately to the forwarder.• visible deficiencies/incompleteness immediately to your Lenze representative.



Preface and general information

	Accessory kit								
	820X	821X	821X-V003	8221 8222 8223	8224 8225	8226 8227	8221-V003 8222-V003	824X	824X-V003
7-pole socket connectors for control cables	2	2	2	2	2	2	2	2	2
3-pole socket connectors for relay output K2	-	-	-	1	1	1	1	1	1
Fixing rails	2	2	2	-	-	-	-	2	-
Fixing units incl. screws for fixing the inverter to the housing	-	-	-	4	4	-	-	-	-
PG diaphragm gland 21	-	-	-	1	1	1	1	-	-
Screen sheet for control cables incl. fixing screw	-	-	-	1	1	1	1	1	1
Screen sheet for motor cable incl. two fixing screws	-	-	-	1	1	1	1	1	1
Hexagon nuts incl. washers and spring-lock washers for the electrical connection of the power stage	-	-	-	8 M6	8 M8	8 M10	8 M6	-	-
Heat-conducting paste	-	-	1 tube	-	-	-	1 tube	-	1 tube
Gasket	-	-	1	-	-	-	1	-	1
Tightening frame	-	-	1	-	-	-	2	-	2



1.3 Legal regulations

Identification	Nameplate	CE-identification	Manufacturer
	Lenze controllers are unambiguously designated by the contents of the nameplate.	Conforms to the EC Low Voltage Directive	Lenze GmbH & Co KG Postfach 101352 D-31763 Hameln
Application as directed	<p>82XX frequency inverter</p> <ul style="list-style-type: none"> operate the controller only under the conditions prescribed in these operating instructions. are components <ul style="list-style-type: none"> for open and closed looped control of variable speed drives with asynchronous standard motors, reluctance motors, PM synchronous motors with asynchronous damper cage, for installation into a machine, used for assembly together with other components to form a machine. are electric units for the installation into control cabinets or similar enclosed operating housing. comply with the requirements of the Low-Voltage Directive. are not machines for the purpose of the Machinery Directive. are not to be used as domestic appliances, but only for industrial purposes. <p>Drive systems with 82XX frequency inverters</p> <ul style="list-style-type: none"> meet the EC Electromagnetic Compatibility Directive if they are installed according to the guidelines of CE-typical drive systems. can be used <ul style="list-style-type: none"> on public and non-public mains, in industrial as well as residential and commercial premises. The user is responsible for the compliance of his application with the EC directives. <p>Any other use shall be deemed inappropriate!</p>		
Liability	<ul style="list-style-type: none"> The information, data, and notes in these instructions met the state of the art at the time of printing. Claims on modifications referring to controllers which have already been supplied cannot be derived from the information, illustrations, and descriptions. The specifications, processes, and circuitry described in these instructions are for guidance only and must be adapted to your own specific application. Lenze does not take responsibility for the suitability of the process and circuit proposals. The specifications in these instructions describe the product features without guaranteeing them. Lenze does not accept any liability for damage and operating interference caused by: <ul style="list-style-type: none"> disregarding the operating instructions unauthorised modifications to the controller operating errors improper working on and with the controller 		
Warranty	<ul style="list-style-type: none"> Warranty conditions: See Sales and Delivery Conditions of Lenze GmbH & Co KG. Warranty claims must be made to Lenze immediately after detecting the deficiency or fault. The warranty is void in all cases where liability claims cannot be made. 		
Disposal	Material	Recycle	Dispose
	Metal	●	-
	Plastic	●	-
	Assembled PCBs	-	●

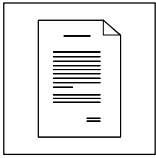

1.4 EC Directives/Declaration of Conformity

1.4.1 What is the purpose of EC directives?

EC directives are issued by the European Council and are intended for the determination of common technical requirements (harmonisation) and certification procedures within the European Community. At the moment, there are 21 EC directives of product ranges. The directives are or will be converted to national laws of the member states. A certification issued by one member state is valid automatically without any further approval in all other member states.

The texts of the directive are restricted to the essential requirements. Technical details are or will be determined by European harmonised standards.

1.4.2 What does the CE mark imply?

After a verification, the conformity according to the EC directives is certified by affixing a CE mark. Within the EC there are no commercial barriers for a product with the CE mark.

The enclosure of a conformity certification is not necessary according to most directives. Therefore, the customer is not able to appreciate which of the 21 EC directives applies to a product and which harmonised standards are considered in the conformity verification.

Controllers on their own with the CE mark exclusively correspond to the Low Voltage Directive. For the compliance with the EMC Directive only general recommendations have been issued so far. The CE conformity of the installed machine remains the responsibility of the user. For the installation of CE-typical drive systems, Lenze has already proved the CE conformity to the EMC Directive.



1.4.3 EC Low-Voltage Directive

(73/23/EEC)

amended by: CE Mark Directive (93/68/EEC)

General

- The Low-Voltage Directive is effective for all electrical equipment for use with a rated voltage between 50 V and 1000 V AC and between 75 V and 1500 V DC, and under normal ambient conditions. The use of e.g. electrical equipment in explosive atmospheres and electrical parts in passenger and goods lifts are excepted.
- The objective of the Low Voltage Directive is to ensure that only electrical equipment which does not endanger the safety of persons or animals is placed on the market. It should also be designed to conserve material assets.

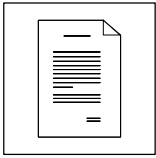

Preface and general information

EC Declaration of Conformity '95

for the purpose of the EC Low-Voltage Directive (73/23/EEC)

amended by: CE Mark Directive (93/68/EEC)

820X/821X/822X/824X controllers are developed, designed, and manufactured in compliance with the above mentioned EC Directive under the sole responsibility of

Lenze GmbH & Co KG, Postfach 10 13 52, D-31763 Hameln

Standards considered:

Standard	
DIN VDE 0160 5.88 + A1 / 4.89 + A2 / 10.88 DIN EN 50178 Classification VDE 0160 / 11.94	Electronic equipment for use in electrical power installations
DIN VDE 0100 EN 60529	Standards for the installation of power installations IP degrees of protection
IEC 249 / 1 10/86, IEC 249 / 2-15 / 12/89	Base material for printed circuits
IEC 326 / 1 10/90, EN 60097 / 9.93	Printed circuits, printed boards
DIN VDE 0110 / 1-2 / 1/89 / 20/ 8/90	Creepage distances and clearances

Hameln, 01 October, 1995

(i. V. Loy)
Product Manager



1.4.4 EC Directive Electromagnetic Compatibility

(89/336/EEC)

amended by: First Amendment Directive (92/31/EEC)
CE Mark Directive (93/68/EEC)

General

- The EC Electromagnetic Compatibility Directive is effective for "devices" which may cause electromagnetic interference or the operation of which may be impaired by such interference.
- The aim is to limit the generation of electromagnetic interference so that an operation without interference to radio and telecommunication systems and other equipment is possible. The devices must also show an appropriate resistance against electromagnetic interference to ensure the application as directed.
- Controllers cannot be driven in stand-alone operation and therefore the controllers cannot be evaluated on their own in terms of EMC. Only after the integration of the controllers into a drive system, can this system be tested concerning the objectives of the EC EMC Directive and the compliance with the "Law about the Electromagnetic Compatibility of Devices".
- Lenze has verified the conformity of controllers integrated into certain defined drive systems. In the following these systems are called "CE-typical drive systems".

The following configurations can now be selected by the user:

- The user himself can determine the system components and their integration into the drive system and is then held responsible for the conformity of the drive.
- The user can select the CE-typical drive systems for which the manufacturer has already proved the conformity.

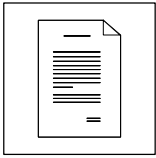

Preface and general information

Components of the CE-typical drive system

System component	Specification
Controller	820X/821X/822X/824X controllers For type designation see inner cover page
RFI filter	For data and data assignment, see chapter "Accessories"
Mains choke	For data and data assignment, see chapter "Accessories"
Mains filters	For data and data assignment, see chapter "Accessories"
Motor cable	Screened power cable with tinned E-CU braid with a minimum of 85 % optical coverage
Mains cable between RFI filter and controller	As from cable length 300 mm: Screened power cable with tinned E-CU braid with a minimum of 85 % optical coverage
Control cables	Screened signal cable type LIYCY
Motor	Standard three-phase AC asynchronous motor Lenze type DXRA or similar
Accessories	For rated accessories, see inner cover page.

- Controller, RFI filter and mains choke are mounted on one assembly board.
- The system components are functionally wired according to chapter 4, "Electrical installation".

Application as directed/Scope of application

- The 820X/821X/822X/824X controllers are intended for the use in control cabinets.
- The 820X/821X/822X/824X controllers are directed as components for the control of variable-speed drives with three-phase AC motors to be assembled together with other components to form a drive system. The drive systems are intended for installation into a machine or for the construction together with other components to form a machine or a plant.
- Drive systems with the 820X/821X/822X/824X controllers, which are installed according to the guidelines of CE-typical drive systems, correspond to the EC EMC Directive and the standards mentioned below.
- The CE-typical drive systems are suitable for the operation on public and non-public mains.
- The CE-typical drive systems are provided for the operation in industrial premises as well as in residential and commercial areas.
- Because of the earth-potential reference of the RFI filters, the described CE-typical drive systems are not suitable for the connection to IT-mains (mains without earth-reference potential).
- The controllers are not domestic appliances, but they are intended as a part of drive systems for commercial use.



EC Declaration of Conformity '95 for the purpose of the EC Directive

on Electromagnetic Compatibility (89/336/EEC)

amended by: First Amendment Directive (92/31/EEC)
CE Mark Directive (93/68/EEC)

820X/821X/822X/824X controllers cannot be driven in stand-alone operation for the purpose of the Regulation about Electromagnetic Compatibility (EMVG of 9/11/92 and 1. EMVGÄndG of 08 August, 1995). The EMC can only be verified when the controller is integrated into a drive system.

Lenze GmbH & Co KG, Postfach 10 13 52, D-31763 Hameln

declares that the described "CE-typical drive systems" with the controllers of the types 820X/821X/822X/824X comply with the above mentioned EC Directive.

The conformity evaluation is based on the working paper of the product standard for drive systems:

IEC 22G-WG4 5/94	EMC product standard including specific test methods for power drive systems"
------------------	---

Generic standards considered:

Generic standard	
EN 50081-1 /92	Generic standard for the emission of noise Part 1: Residential area, commercial premises, and small businesses
EN 50081-2 /93 (used in addition to the requirements of IEC 22G)	Generic standard for the emission of noise Part 2: Industrial premises The emission of noise in industrial premises is not limited in IEC 22G.
prEN 50082-2 3/94	Generic standard for noise immunity Part 2: Industrial premises The requirements of noise immunity for residential areas were not considered since they are less strict.

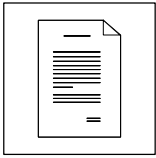

Preface and general information

Considered basic standards for the test of noise emission:

Basic standard	Test	Limit value
EN 55022 7/92	Radio interference housing and mains Frequency range 0.15 - 1000 MHz	Class B for use in residential areas and commercial premises
EN 55011 7/92 (used in addition to the requirements of IEC 22G)	Radio interference housing and mains Frequency range 0.15 - 1000 MHz The emission of noise in industrial premises is not limited in IEC 22G.	Class A for use in industrial premises
IEC 801-2 /91	Electrostatic discharge on housing and heat sink	Severity 3 6 kV with contact discharge 8 kV air discharge
IEC 1000-4-3	Electromagnetic fields Frequency range 26 - 1000 MHz	Severity 3 10 V/m
ENV 50140 /93	High-frequency field Frequency range 80 - 1000 MHz, 80 % amplitude modulated	Severity 3 10 V/m
	Fixed frequency 900 MHz with 200 Hz, 100 % modulated	10 V/m
IEC 801-4 /88	Fast transients burst on power terminals	Severity 3 2 kV / 5 kHz
	Burst on bus and control cables	Severity 4 2 kV / 5 kHz
IEC 801-5	Surge test Mains cables	Installation class 3

Hameln, 01 October, 1995

(i. V. Loy)
Product Manager



1.4.5 EC Machinery Directive

(89/392/EEC)

amended by: First Amendment Directive (91/368/EEC)
Second Amendment Directive (93/44/EEC)
CE Mark Directive (93/68/EEC)

General

For the purpose of the Machinery Directive, "machinery" means an assembly of linked parts or components, at least one of which moves, with the appropriate actuators, control and power circuits, etc., joined together for a specific application, in particular for the processing, treatment, moving or packaging of a material.

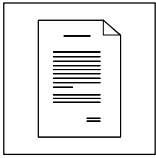

Preface and general information

EC Manufacturer's Declaration

for the purpose of the EC Machinery Directive (98/392/EEC)

amended by: First Amendment Directive (91/368/EEC)
Second Amendment Directive (93/44/EEC)
CE Mark Directive (93/68/EEC)

The 820X/821X/822X/824X controllers were developed, designed, and manufactured under the sole responsibility of

Lenze GmbH & Co KG, Postfach 10 13 52, D-31763 Hameln

Commissioning of the controllers is prohibited until it is proven that the machine in which they are to be installed corresponds to the EC Machinery Directive.

Hameln, 01 October, 1995

(i. V. Loy)
Product Manager



2 Safety information

2.1 General safety information



Safety and application notes for controllers

(to: Low-Voltage Directive 73/23/EEC)

1. General

During operation, drive controllers may have, according to their type of protection, live, bare, in some cases also movable or rotating parts as well as hot surfaces.

Non-authorized removal of the required cover, inappropriate use, incorrect installation or operation, creates the risk of severe injury to persons or damage to material assets.

Further information can be obtained from the documentation.

All operations concerning transport, installation, and commissioning as well as maintenance must be carried out by qualified, skilled personnel (IEC 364 and CENELEC HD 384 or DIN VDE 0100 and IEC report 664 or DIN VDE 0110 and national regulations for the prevention of accidents must be observed).

According to this basic safety information qualified skilled personnel are persons who are familiar with the erection, assembly, commissioning, and operation of the product and who have the qualifications necessary for their occupation.

2. Application as directed

Drive controllers are components which are designed for installation in electrical systems or machinery.

When installing in machines, commissioning of the drive controllers (i.e. the starting of operation as directed) is prohibited until it is proven that the machine corresponds to the regulations of the EC Directive 89/392/EEC (Machinery Directive); EN 60204 must be observed.

Commissioning (i.e. starting of operation as directed) is only allowed when there is compliance with the EMC Directive (89/336/EEC).

The drive controllers meet the requirements of the Low Voltage Directive 73/23/EEC. The harmonised standards of the EN 50178/ DIN VDE 0160 series together with EN 60439-1/DIN VDE 0660 part 500 and EN 60146/DIN VDE 0558 are applicable to drive controllers.

The technical data and information on the connection conditions must be obtained from the nameplate and the documentation and must be observed in all cases.

3. Transport, storage

Notes on transport, storage and appropriate handling must be observed.

Climatic conditions must be observed according to EN 50178.

4. Erection

The devices must be erected and cooled according to the regulations of the corresponding documentation.

The drive controllers must be protected from inappropriate loads. Particularly during transport and handling, components must not be bent and/or isolating distances must not be changed. Touching of electronic components and contacts must be avoided.

Drive controllers contain electrostatically sensitive components which can easily be damaged by inappropriate handling. Electrical components must not be damaged or destroyed mechanically (health risks are possible!).

5. Electrical connection

When working on live drive controllers, the valid national regulations for the prevention of accidents (e.g. VBG 4) must be observed.

The electrical installation must be carried out according to the appropriate regulations (e.g. cable cross-sections, fuses, PE connection). More detailed information is included in the documentation.

Notes concerning the installation in compliance with EMC - such as screening, grounding, arrangement of filters and laying of cables - are included in the documentation of the drive controllers. These notes must also be observed in all cases for drive controllers with the CE mark. The compliance with the required limit values demanded by the EMC legislation is the responsibility of the manufacturer of the system or machine.

6. Operation

Systems where drive controllers are installed must be equipped, if necessary, with additional monitoring and protective devices according to the valid safety regulations, e.g. law on technical tools, regulations for the prevention of accidents, etc.

Modifications of the drive controllers by the operating software are allowed.

After disconnecting the drive controllers from the supply voltage, live parts of the controller and power connections must not be touched immediately, because of possibly charged capacitors. For this, observe the corresponding labels on the drive controllers. During operation, all covers and doors must be closed.

7. Maintenance and servicing

The manufacturer's documentation must be observed.

This safety information must be kept!

The product-specific safety and application notes in these Operating Instructions must also be observed!



Safety information





2.2 Layout of the safety information

- All safety information has a uniform layout:
 - The icon characterises the type of danger.
 - The signal word characterises the severity of danger.
 - The note describes the danger and suggests how to avoid the danger.



Signal word

Note

	Icons used		Signal words	
Warning of danger to persons		Warning of hazardous electrical voltage	Danger!	Warns of impending danger . Consequences if disregarded: Death or severe injuries.
		Warning of a general danger	Warning!	Warns of potential, very hazardous situations . Possible consequences if disregarded: Death or severe injuries.
			Caution!	Warns of potential, hazardous situations . Possible consequences if disregarded: Light or minor injuries.
Warning of damage to material			Stop!	Warns of potential damage to material . Possible consequences if disregarded: Damage of the controller/drive system or its environment.
Other notes			Note!	Designates a general, useful note. If this note is observed, handling of the controller/drive system is easier.

2.3 Residual hazards

Operator's safety	After mains disconnection, the power terminals U, V, W and +U _G , -U _G remain live for at least 3 minutes. <ul style="list-style-type: none"> • Before working on the controller, check that no voltage is applied to the power terminals.
Protection of devices	Cyclic connection and disconnection of the controller supply voltage at L1, L2, L3 or +U _G , +U _G may overload the internal input current limit. <ul style="list-style-type: none"> • Allow at least 3 minutes between disconnection and reconnection.
Overspeeds	Drive systems can reach dangerous overspeeds (e.g. setting high field frequencies for motors and machines which are not suitable): <ul style="list-style-type: none"> • The controllers do not offer any protection against these operating conditions. Use additional components for this.

EDS8200U--B
00406182

Manual

Part B

Technical data

Installation

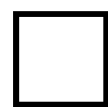

Global Drive
Frequency inverters 8200

This Manual is valid for 82XX controllers as of version:

	33.820X-	E-	1x.	1x		(8201 - 8204)
	33.8202-	E-	1x.	1x	-V002	Reduced assembly depth (8202)
	33.821X-	E-	0x.	1x		(8211 - 8218)
	33.821X-	E-	1x.	2x		(8211 - 8218)
	33.821X-	C-	1x.	2x	-V003	Cold plate (8215 - 8218)
	33.821X-	E-	3a.	3x	-V020	HVAC (8211 - 8218)
	33.822X-	E-	0x.	0x		(8221 - 8227)
	33.822X-	C-	1x.	2x	-V003	Cold plate (8221 - 8222)
	33.822X-	E-	3a.	3x	-V020	HVAC (8221 - 8227)
	33.824X-	E-	1x.	1x		(8241 - 8246)
	33.824X-	C-	1x.	1x	-V003	Cold plate (8241 - 8246)
	33.824X-	E-	3a.	3x	-V020	HVAC (8241 - 8246)
Type						
Design: B = Module C = Cold plate E = Built-in unit IP20						
Hardware version and index						
Software version and index						
Variant						
Explanation						

		revised	
Edition of:	01/1999		

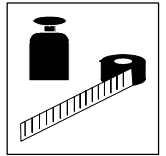

3 Technical data

3.1 Overview of types

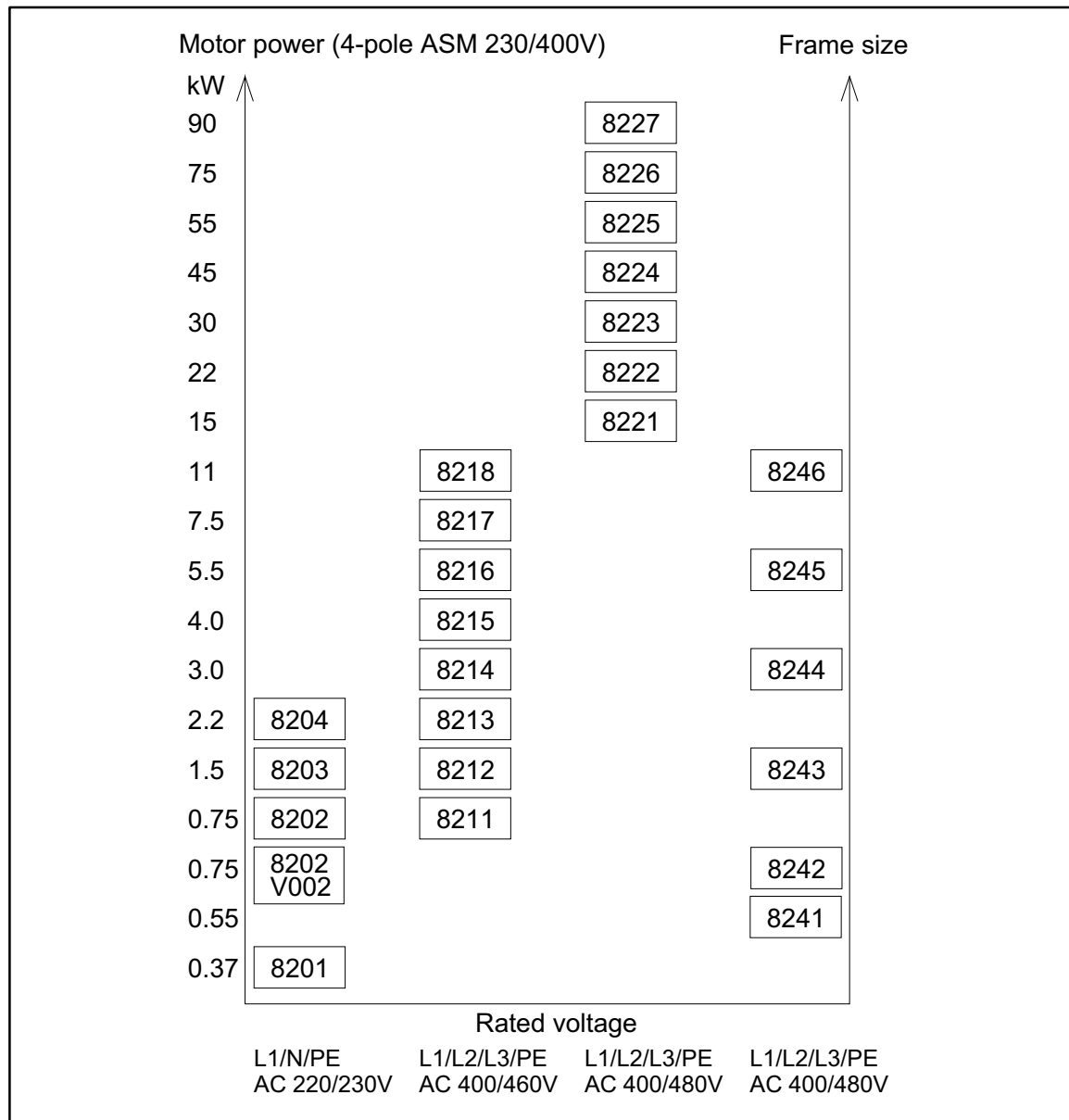
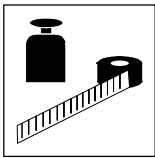

FIG 3-1 Overview of types



Technical Data

3.2 Features

	820X	821X	822X	824X
Compact design	●	●	●	●
Load capacity of up to 150 % I _r for 1 min	●	●	●	●
Inverter outputs are protected against short circuit	●	●	●	●
Earth-fault check at mains connection	●	●	●	●
Chopper frequency 9.2 kHz	●			
Chopper frequency selectable: 4 kHz, 8 kHz, 12 kHz, 16 kHz		●	●	●
V/f-characteristic control with constant V _{min} boost or auto boost	●			
Motor-current control or V/f-characteristic control selectable		●	●	●
Mains-voltage compensation	●	●	●	●
Slip compensation	●	●	●	●
Adjustable current limitation with V/f-override	●	●	●	●
PWM converter with IGBT-power stages	●	●	●	●
DC-bus connection and brake-chopper connection	●	●	●	●
Isolated analog input and output	●	●	●	●
Relay outputs (change-over contact)	1	1	2	2
PLC-compatible digital outputs (I/O module 8275)	3 (option)	3 (option)	3 (option)	3 (option)
Isolated digital inputs with programmable functions	4	4	4	4
Up to 3 JOG frequencies per parameter set	●	●	●	●
DC-injection brake	●	●	●	●
TRIP set and TRIP reset function	●	●	●	●
Motor potentiometer	●	●	●	●
Output frequency up to 240 Hz / 480 Hz	●			
Output frequency up to 480 Hz		●	●	●
Flying restart circuit	●	●	●	●
2 parameter sets	●	●	●	●
Elapsed time meter	●	●	●	●
Assembly with thermal separation of the power stage		as from 8215E	●	●
Temperature-dependent blower activation			●	●
PTC monitoring of the motor by integrated evaluation	option	option	●	●
Process and speed controller		●*	●*	●*
Setpoint summation		●*	●*	●*
Level inversion for digital inputs		●*	●*	●*
Priority for digital inputs		●*	●*	●*
Manual/remote changeover (H/Re)		●*	●*	●*
Belt monitoring		●*	●*	●*
Selection of an inverse analog setpoint		●*	●*	●*
Limit frequencies		●*	●*	●*
Ramp function generator S-shape		●*	●*	●*
Motor phase failure detection			●*	●*

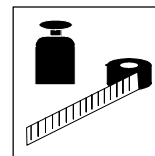

	820X	821X	822X	824X
Attachable accessories				
8201BB operating module for control and parameter setting with memory for parameter-set transmission	●	●	●	●
Serial 2102IB LECOM fieldbus module for RS232/485 or optical fibre	●	●	●	●
INTERBUS 2111IB fieldbus module	●	●	●	●
2171 system bus module (CAN)	●	●	●	●
I/O module 8275 IB	●	●	●	●
PTC module 8274 IB	●	●		
Monitor module 8276 IB	●	●	●	●
Bipolar analog input 8278 IB	●	●	●	●
Analog plug-in module 8279IB (2. analog channel)		●*	●*	●*

* Only for 821X/2X/4X HVAC (V020) controllers.

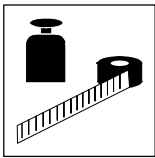

Technical Data

3.3 General data/application conditions

Field	Values		
Vibration resistance	Germanischer Lloyd, general conditions		
Humidity class	Humidity class F without condensation (average relative humidity 85 %)		
Permissible temperature range	During transport of the controller: -25 °C...+70 °C		
	During storage of the controller: -25 °C...+55 °C		
	During operation of the controller: 0 °C...+40 °C without power derating +40 °C...+50 °C with power derating		
Permissible installation height	$h \leq 1000$ m a.m.s.l. without power derating		
	1000 m a.m.s.l. < $h \leq 4000$ m a.m.s.l. with power derating		
Degree of pollution	VDE 0110 part 2 pollution degree 2		
Noise emission	Requirements to EN 50081-2, EN 50082-1, IEC 22G-WG4 (Cv) 21 Limit value class A to EN 55011 (industry) with mains filter Limit value class B to EN 55022 (residential area) with mains filter and installation into control cabinet		
Noise immunity	Limit values maintained with mains filter Requirements to EN 50082-2, IEC 22G-WG4 (Cv) 21		
	Requirements	Standard	Severities
	ESD	EN61000-4-2	3, i.e. 8 kV with air discharge, 6 kV with contact discharge
	RF interference (enclosure)	EN61000-4-3	3, i.e. 10 V/m; 27...1000 MHz
	Burst	EN61000-4-4	3/4, i.e. 2 kV/5 kHz
	Surge (Surge on mains cable)	IEC 1000-4-5	3, i.e. 1.2/50 μ s, 1 kV phase-phase, 2 kV phase-PE
Insulation strength	Overvoltage category III to VDE 0110		
Packaging to DIN 4180	Types 820X, 821X, 824X Dust packaging Types 822X, Transport packaging 821X/2X/4X HVAC (V020)		
Enclosure	Types 82XX, 82XX HVAC (V020)	IP20 NEMA 1: Protection against contact	
	Types 8215 - 8218, 822X, 824X, 8215/16/17/18/2X/4X HVAC (V020)	IP41 on the heat-sink side with thermal separation in push-through technique	
Approvals	Types 82XX, 82XX HVAC (V020)	CE: Low-Voltage Directive and Electromagnetic Compatibility	
	Types 822X, 824X, 822X/4X HVAC (V020)	UL 508: Industrial Control Equipment UL 508C: Power Conversion Equipment	

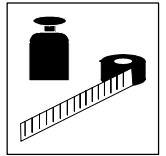

3.4 Rated data (Operation with 150 % overload)

3.4.1 Types 8201 to 8204

150 % overload		Type	8201	8202	8203	8204
		Order No.	EVF8201-E	EVF8202-E	EVF8203-E	EVF8204-E
Variant "reduced assembly depth"		Type		8202-V002		
		Order No.		EVF8202-E- V002		
Mains voltage	V_r [V]	190 V -0 % $\leq V_r \leq$ 260 V +0 %; 45 Hz ... 65 Hz \pm 0%				
Alternative DC supply	V_{DC} [V]	270 V -0 % $\leq V_{DC} \leq$ 360 V +0 %				
Mains current ⁴⁾ with mains filter/mains choke without mains filter/mains choke	I_{mains} [A]	4.2 5.0	7.5 9.0	12.5 15.0	17.0 -	
Data for mains operation with 1 AC / 230 V / 50 Hz/60 Hz; 270 V $\leq V_{DC} \leq$ 275 V						
Motor power (4 pole ASM) at 9.2 kHz*	P_r [kW]	0.37	0.75	1.5	2.2	
	P_r [hp]	0.5	1.0	2.0	2.9	
Output power U, V, W at 9.2 kHz*	$S_{9,2}$ [kVA]	1.0	1.5	2.7	3.6	
Output power + U_G , - U_G ¹⁾	P_{DC} [kW]	0.0	0.0	0.0	0.0	
Output current	I_r [A]	2.6	4.0	7.0	9.5	
Max. output current for 60 s ²⁾	I_{rmax} [A]	3.9	6.0	10.5	14.2	
Motor voltage ³⁾	V_M [V]	0 - 3 x V_{mains} / 0 Hz ... 50 Hz, if required up to 240 Hz				
Power loss (operation with I_r)	P_{loss} [W]	30	50	70	100	
Power derating	$\frac{[\%]}{[K]}$ $\frac{[\%]}{[m]}$	40 °C < T_v < 50 °C: 2.5 %/K 1000 m a.m.s.l. < $h \leq$ 4000 m a.m.s.l.: 5 %/1000 m				
Field frequency	Resolution	Absolute	0.05 Hz			
	Digital setpoint selection	Accuracy	\pm 0.05 Hz			
	Analog setpoint selection	Linearity	\pm 0.5 % (max. selected signal level, 5 V or 10 V)			
		Temperature sensitivity	0 ... 40 °C: +0.4 %			
	Offset	\pm 0.3 %				
Weight	m [kg]	1.0	1.3 Variant 1.0	2.2	2.2	

- 1) This power can be additionally obtained when operating a matching motor
 - 2) The currents apply to a periodical load cycle with 1 minute overcurrent with the current mentioned here and 2 minutes base load with 75 % I_r .
 - 3) With mains choke/mains filter: max. output voltage = approx. 96 % of the mains voltage
 - 4) Observe the N-conduction load when having a symmetrical mains distribution! (See electrical installation)
- * Chopper frequency of the inverter

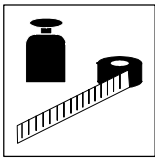

Technical Data

3.4.2 Types 8211 to 8214

150 % overload	Type	8211	8212	8213	8214					
	Order No.	EVF8211-E	EVF8212-E	EVF8213-E	EVF8214-E					
	Variant "HVAC"	8211-V020	8212-V020	8213-V020	8214-V020					
	Order No.	EVF8211-E-V020	EVF8212-E-V020	EVF8213-E-V020	EVF8214-E-V020					
Mains voltage	V_f [V]	$320\text{ V} - 0\% \leq V_f \leq 510\text{ V} + 0\%$; 45 Hz ... 65 Hz $\pm 0\%$								
Alternative DC supply	V_{DC} [V]	$450\text{ V} - 0\% \leq V_{DC} \leq 715\text{ V} + 0\%$								
Mains current with mains filter/mains choke without mains filter/mains choke	I_{mains} [A] I_{mains} [A]	2.5 3.75	3.9 5.85	5.0 7.5	7.0 --					
Data for mains operation with 3 AC / 400 V / 50 Hz/60 Hz ; $450\text{ V} \leq V_{DC} \leq 650\text{ V}$ or 3 AC/460 V/50 Hz/60 Hz; $460\text{ V} \leq V_{DC} \leq 725\text{ V}$										
Motor power (4 pole ASM) at 4 kHz/8 kHz*	P_r [kW]	0.75	1.1	1.5	1.5	2.2	2.2	3.0	3.7	
	P_r [hp]	1.0	1.5	2.0	2.0	2.9	2.9	4.0	5.0	
Output power U, V, W at 4 kHz/8 kHz*	S_{r8} [kVA]	1.6	1.9	2.7	3.1	3.8	4.3	5.2	5.8	
Output power + U_G , - U_G ¹⁾	P_{DC} [kW]	0.7	0.7	0.0	0.0	1.0	1.0	0.0	0.0	
Output current	4 kHz*	I_{r4} [A]	2.4	2.4	3.9	3.9	5.5	5.5	7.3	7.3
	8 kHz*	I_{r8} [A]	2.4	2.4	3.9	3.9	5.5	5.5	7.3	7.3
	12 kHz*	I_{r12} [A]	2.0	1.9	3.3	3.0	4.6	4.3	6.1	5.7
	16 kHz*	I_{r16} [A]	1.8	1.7	2.9	2.7	4.1	3.8	5.5	5.1
	Noise optimised 4 kHz* ⁴⁾	I_{r4} [A]	2.4	2.3	3.9	3.7	5.5	5.2	7.3	6.9
	Noise optimised 8 kHz* ⁴⁾	I_{r8} [A]	2.1	2.0	3.4	3.2	4.7	4.5	6.3	6.0
	Noise optimised 12 kHz*	I_{r12} [A]	1.9	1.8	3.1	2.9	4.4	4.1	5.8	5.4
	Noise optimised 16 kHz*	I_{r16} [A]	1.6	1.5	2.5	2.3	3.6	3.3	4.7	4.4
Max. output current for 60 s ²⁾	4 kHz*	I_{max4} [A]	3.6	3.6	5.9	5.9	8.3	8.3	11.0	11.0
	8 kHz*	I_{max8} [A]	3.6	3.6	5.9	5.9	8.3	8.3	11.0	11.0
	12 kHz*	I_{max12} [A]	3.0	2.8	4.9	4.6	6.9	6.6	9.2	8.7
	16 kHz*	I_{max16} [A]	2.7	2.5	4.4	4.1	6.2	5.8	8.2	7.7
	Noise optimised 4 kHz* ⁴⁾	I_{max4} [A]	3.6	3.7	5.9	5.6	8.3	7.8	11.0	10.4
	Noise optimised 8 kHz* ⁴⁾	I_{max8} [A]	3.1	2.9	5.1	4.8	7.1	6.7	9.4	8.9
	Noise optimised 12 kHz*	I_{max12} [A]	2.9	2.7	4.7	4.4	6.6	6.2	8.8	8.2
	Noise optimised 16 kHz*	I_{max16} [A]	2.4	2.1	3.8	3.5	5.4	5.0	7.1	6.6

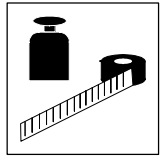

150 % overload		Type	8211	8212	8213	8214
		Order No.	EVF8211-E	EVF8212-E	EVF8213-E	EVF8214-E
Variant "HVAC"		Type	8211-V020	8212-V020	8213-V020	8214-V020
		Order No.	EVF8211-E-V020	EVF8212-E-V020	EVF8213-E-V020	EVF8214-E-V020
Motor voltage ³⁾		V _M [V]	0 - 3 x V _{mains} / 0 Hz ... 50 Hz, if required up to 480 Hz			
Power loss (operation with I _x)		P _{loss} [W]	55	75	90	100
Power derating		[%/K] [%/m]	40 °C < T _V < 50 °C: 2.5 %/K 1000 m a.m.s.l. < h ≤ 4000 m a.m.s.l.: 5 %/1000 m			
Field frequency	Resolution	Absolute	0.02 Hz			
	Digital setpoint selection	Accuracy	± 0.05 Hz			
	Analog setpoint selection	Linearity	± 0.5 % (max. selected signal level: 5 V or 10 V)			
		Temperature sensitivity	0 ... 40 °C: +0.4 %			
		Offset	± 0 %			
Weight		m [kg]	2.2	2.2	2.2	2.2

Printed in bold Data for the operation with factory setting and a chopper frequency of 8 kHz.

- 1) This power can be additionally obtained when operating a matching motor
 - 2) The currents apply to a periodical load cycle with 1 minute overcurrent with the current mentioned here and 2 minutes base load with 75 % I_x.
 - 3) With mains choke/mains filter: max. output voltage = approx. 96 % of the mains voltage
 - 4) Only with variant "HVAC"
- * Chopper frequency of the inverter

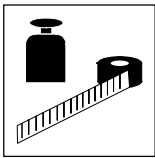

Technical Data

3.4.3 Types 8215 to 8218

150 % overload	Type	8215	8216	8217	8218					
	Order No.	EVF8215-E	EVF8216-E	EVF8217-E	EVF8218-E					
	Variant "Cold Plate"	Type	8215-V003	8216-V003	8217-V003	8218-V003				
		Order No.	EVF8215-C-V003	EVF8216-C-V003	EVF8217-C-V003	EVF8218-C-V003				
	Variant "HVAC"	Type	8215-V020	8216-V020	8217-V020	8218-V020				
		Order No.	EVF8215-E-V020	EVF8216-E-V020	EVF8217-E-V020	EVF8218-E-V020				
Mains voltage	V_f [V]	320 V -0 % $\leq V_f \leq$ 510 V +0 %; 45 Hz ... 65 Hz \pm 0 %								
Alternative DC supply	V_{DC} [V]	450 V -0 % $\leq V_{DC} \leq$ 715 V +0 %								
Mains current with mains filter/mains choke	I_{mains} [A]	8.8	12.0	15.0	20.5					
	without mains filter/mains choke	I_{mains} [A]	13.2	18.0	22.5	--				
Data for mains operation with 3 AC / 400 V / 50 Hz/60 Hz ; 450 V $\leq V_{DC} \leq$ 650 V or 3 AC/460 V/50 Hz/60 Hz; 460 V $\leq V_{DC} \leq$ 725 V										
Motor power (4 pole ASM) at 4 kHz/8 kHz*	P_r [kW]	4.0	5.5	5.5	7.5	7.5	11.0	11.0	15.0	
	P_r [hp]	5.4	7.5	7.5	10.0	10.0	15.0	15.0	20.0	
Output power U, V, W at 4 kHz/8 kHz*	S_{r8} [KVA]	6.5	7.5	9.0	10.3	11.4	13.7	16.3	19.5	
Output power + U_G , - U_G ¹⁾	P_{DC} [KW]	1.0	1.0	0.0	0.0	3.9	3.9	0.0	0.0	
Output current	4 kHz*	I_{r4} [A]	9.4	9.4	13.0	13.0	16.5	16.5	23.5	23.5
	8 kHz*	I_{r8} [A]	9.4	9.4	13.0	13.0	16.5	16.5	23.5	23.5
	12 kHz*	I_{r12} [A]	7.9	7.4	10.9	10.3	13.9	13.0	19.7	18.5
	16 kHz*	I_{r16} [A]	7.0	6.6	9.7	9.1	12.3	11.6	17.6	16.5
	Noise optimised 4 kHz* ^{d)}	I_{r4} [A]	9.4	8.9	13.0	12.3	16.5	15.6	23.5	22.1
	Noise optimised 8 kHz* ^{d)}	I_{r8} [A]	8.0	7.6	11.1	10.5	14.1	13.3	20.0	18.8
	Noise optimised 12 kHz*	I_{r12} [A]	7.5	7.0	10.4	9.7	13.2	12.4	18.8	17.6
	Noise optimised 16 kHz*	I_{r16} [A]	6.1	5.6	8.4	7.8	10.7	9.9	15.3	14.1
Max. output current for 60 s ²⁾	4 kHz*	I_{rmax4} [A]	14.1	14.1	19.5	19.5	24.8	24.8	35.3	35.3
	8 kHz*	I_{rmax8} [A]	14.1	14.1	19.5	19.5	24.8	24.8	35.3	35.3
	12 kHz*	I_{rmax12} [A]	11.9	11.1	16.4	15.4	20.8	19.6	29.6	27.9
	16 kHz*	I_{rmax16} [A]	10.6	9.8	14.6	13.6	18.6	17.4	26.5	24.7
	Noise optimised 4 kHz* ^{d)}	I_{rmax12} [A]	14.1	13.3	19.5	18.3	24.8	23.4	35.3	55.1
	Noise optimised 8 kHz* ^{d)}	I_{rmax12} [A]	12.0	11.3	16.6	15.6	21.1	19.9	30.0	28.2
	Noise optimised 12 kHz*	I_{rmax12} [A]	11.3	10.6	15.6	14.6	19.8	18.8	28.2	26.4
	Noise optimised 16 kHz*	I_{rmax16} [A]	9.1	8.5	12.7	11.7	16.1	14.9	22.9	21.1

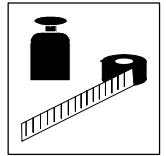

150 % overload		Type	8215	8216	8217	8218
			Order No.	EVF8215-E	EVF8216-E	EVF8217-E
Variant "Cold Plate"		Type	8215-V003	8216-V003	8217-V003	8218-V003
		Order No.	EVF8215-C-V003	EVF8216-C-V003	EVF8217-C-V003	EVF8218-C-V003
Variant "HVAC"		Type	8215-V020	8216-V020	8217-V020	8218-V020
		Order No.	EVF8215-E-V020	EVF8216-E-V020	EVF8217-E-V020	EVF8218-E-V020
Motor voltage ³⁾		V_M [V]	0 - 3 x V_{mains} / 0 Hz ... 50 Hz, if required up to 480 Hz			
Power loss (operation with I_N)		P_{loss} [W]	150	200	280	400
Power derating		$\left[\frac{\%}{K} \right]$ $\left[\frac{\%}{m} \right]$	40 °C < T_V < 50 °C: 2.5 %/K 1000 m a.m.s.l. < h ≤ 4000 m a.m.s.l.: 5 %/1000 m			
Field frequency	Resolution	Absolute	0.02 Hz			
	Digital setpoint selection	Accuracy	± 0.05 Hz			
	Analog setpoint selection	Linearity	± 0.5 % (max. selected signal level: 5 V or 10 V)			
		Temperature sensitivity	0 ... 40 °C: +0.4 %			
	Offset	± 0 %				
Weight		m [kg]	5.3	5.3	5.3	5.3
"Cold Plate" without heat sink			2.8	2.8	2.8	2.8
"Cold Plate" with heat sink			20.8	20.8	20.8	20.8

Printed in bold Data for the operation with factory setting and a chopper frequency of 8 kHz.

- 1) This power can be additionally obtained when operating a matching motor
 - 2) The currents apply to a periodical load cycle with 1 minute overcurrent with the current mentioned here and 2 minutes base load with 75 % I_N .
 - 3) With mains choke/mains filter: max. output voltage = approx. 96 % of the mains voltage
 - 4) Only with variant "HVAC"
- * Chopper frequency of the inverter

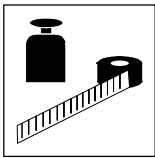

Technical Data

3.4.4 Types 8221 to 8224

150 % overload	Type	8221	8222	8223	8224					
	Order No.	EVF8221-E	EVF8222-E	EVF8223-E	EVF8224-E					
	Variant "Cold Plate"	Type	8221-V003	8222-V003						
		Order No.	EVF8221-C-V003	EVF8222-C-V003						
	Variant "HVAC"	Type	8221-V020	8222-V020	8223-V020	8224-V020				
Order No.		EVF8221-E-V020	EVF8222-E-V020	EVF8223-E-V020	EVF8224-E-V020					
Mains voltage	V_f [V]	320 V -0 % $\leq V_f \leq$ 528 V +0 %; 45 Hz ... 65 Hz \pm 0 %								
Alternative DC supply	V_{DC} [V]	460 V -0 % $\leq V_{DC} \leq$ 740 V +0 %								
Mains current with mains filter/mains choke without mains filter/mains choke	I_{mains} [A]	29.0	42.0	55.0	80.0					
	I_{mains} [A]	43.5	--	--	--					
Data for mains operation with 3 AC / 400 V / 50 Hz/60 Hz; 460 V $\leq V_{DC} \leq$ 620 V or 3 AC / 480 V / 50 Hz/60 Hz; 460 V $\leq V_{DC} \leq$ 740 V										
Motor power (4 pole ASM) at 4 kHz/8 kHz*	P_r [kW]	15	18.5	22	30	30	37	45	55	
	P_r [hp]	20	25	30	40	40	49.5	60	74	
Output power U, V, W at 4 kHz/8 kHz*	S_{r8} [kVA]	22.2	26.6	32.6	39.1	41.6	49.9	61.7	73.9	
Output power + U_G , - U_G ¹⁾	P_{DC} [kW]	10.2	11.8	4.0	4.6	0	0	5.1	5.9	
Output current	4 kHz*	I_{r4} [A]	32	32	47	47	59	56	89	84
	8 kHz*	I_{r8} [A]	32	32	47	47	59	56	89	84
	12 kHz*	I_{r12} [A]	27	25	40	37	50	47	71	67
	16 kHz*	I_{r16} [A]	24	22	35	33	44	41	62	58
	Noise optimised 4 kHz* ⁴⁾	I_{r4} [A]	32	30.5	47	45	59	56	89	84
	Noise optimised 8 kHz* ⁴⁾	I_{r8} [A]	29	27	43	41	47 ⁵⁾	44 ⁵⁾	59 ⁵⁾	55 ⁵⁾
	Noise optimised 12 kHz*	I_{r12} [A]	25	24	37	35	44	38	62	58
	Noise optimised 16 kHz*	I_{r16} [A]	21	19	30	28	35	30	53	49
Max. output current for 60 s ²⁾	4 kHz*	I_{max4} [A]	48	48	70.5	70.5	89	84	134	126
	8 kHz*	I_{max8} [A]	48	48	70.5	70.5	89	84	134	126
	12 kHz*	I_{max12} [A]	40	38	59	56	75	70	92	87
	16 kHz*	I_{max16} [A]	36	33	53	49	66	61	81	75
	Noise optimised 4 kHz* ⁴⁾	I_{max4} [A]	48	46	70.5	66.5	89	56	134	126
	Noise optimised 8 kHz* ⁴⁾	I_{max8} [A]	43	41	64	61	70 ⁵⁾	65 ⁵⁾	88 ⁵⁾	82 ⁵⁾
	Noise optimised 12 kHz*	I_{max12} [A]	38	36	56	53	66	57	81	75
	Noise optimised 16 kHz*	I_{max16} [A]	31	29	46	42	53	45	69	63
Motor voltage ³⁾	V_M [V]	0 - 3 x V_{mains} / 0 Hz ... 50 Hz, if required up to 480 Hz								
Power loss (operation with I_{r4})	P_{loss} [W]	430	640	810	1100					

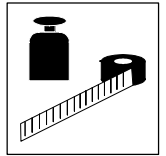

150 % overload		Type	8221	8222	8223	8224
		Order No.	EVF8221-E	EVF8222-E	EVF8223-E	EVF8224-E
Variant "Cold Plate"		Type	8221-V003	8222-V003		
		Order No.	EVF8221-C-V003	EVF8222-C-V003		
Variant "HVAC"		Type	8221-V020	8222-V020	8223-V020	8224-V020
		Order No.	EVF8221-E-V020	EVF8222-E-V020	EVF8223-E-V020	EVF8224-E-V020
Power derating		[%/K] [%/m]	40 °C < T _V < 50 °C: 2.5 %/K 1000 m a.m.s.l. < h ≤ 4000 m a.m.s.l.: 5 %/1000 m			
Field frequency	Resolution	Absolute	0.02 Hz			
	Digital setpoint selection	Accuracy	± 0.05 Hz			
	Analog setpoint selection	Linearity	± 0.5 % (max. selected signal level: 5 V or 10 V)			
		Temperature sensitivity	0 ... 40 °C: +0.4 %			
		Offset	± 0 %			
Weight "Cold Plate" without heat sink		m [kg]	15 11	15 11	15 -	33.5 -

Printed in bold Data for the operation with factory setting and a chopper frequency of 8 kHz.

- 1) This power can be additionally obtained when operating a matching motor
 - 2) The currents apply to a periodical load cycle with 1 minute overcurrent with the current mentioned here and 2 minutes base load with 75 % I_x.
 - 3) With mains choke/mains filter: max. output voltage = approx. 96 % of the mains voltage
 - 4) Only with variant "HVAC"
 - 5) Must only be operated with C144 = -1- (automatic chopper frequency derating at $\vartheta_{max} = +5\text{ °C}$). Ensure not to exceed the currents.
- * Chopper frequency of the inverter

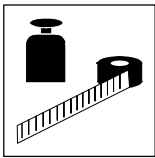

Technical Data

3.4.5 Types 8225 to 8227

150 % overload	Type	8225		8226		8227		
	Order No.	EVF8225-E		EVF8226-E		EVF8227-E		
Variant "HVAC"	Type	8225-V020		8226-V020		8227-V020		
	Order No.	EVF8225-E-V020		EVF8226-E-V020		EVF8227-E-V020		
Mains voltage	V_r [V]	320 V -0 % $\leq V_r \leq$ 528 V +0 %; 45 Hz ... 65 Hz \pm 0 %						
Alternative DC supply	V_{DC} [V]	460 V -0 % $\leq V_{DC} \leq$ 740 V +0 %						
Mains current with mains filter/mains choke	I_{mains} [A]	100		135		165		
without mains filter/mains choke	I_{mains} [A]	--		--		--		
Data for mains operation with 3 AC / 400 V / 50 Hz/60 Hz ; 460 V $\leq V_{DC} \leq$ 620 V or 3 AC / 480 V / 50 Hz/60 Hz ; 460 V $\leq V_{DC} \leq$ 740 V								
		400 V	480 V	400 V	480 V	400 V	480 V	
Motor power (4 pole ASM) at 4 kHz/8 kHz*	P_r [kW]	55	75	75	90	90	110	
	P_r [hp]	74	100	100	120	120	148	
Output power U, V, W at 4 kHz/8 kHz*	S_{r8} [kVA]	76.2	91.4	103.9	124	124.7	149	
Output power + U_G , - U_G ¹⁾	P_{DC} [kW]	0	0	28.1	32.4	40.8	47.1	
Output current	4 kHz*	I_{r4} [A]	110	105	150	142	180	171
	8 kHz*	I_{r8} [A]	110	105	150	142	171	162
	12 kHz*	I_{r12} [A]	88	83	120	112	126	117
	16 kHz*	I_{r16} [A]	77	72	105	98	108	99
	Noise optimised 4 kHz* ⁴⁾	I_{r4} [A]	110	104	150	141	159 ⁵⁾	149 ⁵⁾
	Noise optimised 8 kHz* ⁴⁾	I_{r8} [A]	76 ⁵⁾	71 ⁵⁾	92 ⁵⁾	86 ⁵⁾	100 ⁵⁾	94 ⁵⁾
	Noise optimised 12 kHz*	I_{r12} [A]	66	60	82	75	90	81
	Noise optimised 16 kHz*	I_{r16} [A]	60	55	67	60	72	63
Max. output current for 60 s ²⁾	4 kHz*	I_{rmax4} [A]	165	157	225	213	270	256
	8 kHz*	I_{rmax8} [A]	165	157	225	213	221	211
	12 kHz*	I_{rmax12} [A]	114	108	156	147	164	153
	16 kHz*	I_{rmax16} [A]	100	94	136	128	140	130
	Noise optimised 4 kHz* ⁴⁾	I_{rmax4} [A]	165	156	225	212	238 ⁵⁾	223 ⁵⁾
	Noise optimised 8 kHz* ⁴⁾	I_{rmax8} [A]	114 ⁵⁾	107 ⁵⁾	138 ⁵⁾	169 ⁵⁾	150 ⁵⁾	141 ⁵⁾
	Noise optimised 12 kHz*	I_{rmax12} [A]	85	78	107	98	117	106
	Noise optimised 16 kHz*	I_{rmax16} [A]	78	72	87	78	94	83
Motor voltage ³⁾	V_M [V]	0 - 3 x V_{mains} / 0 Hz ... 50 Hz, if required up to 480 Hz						
Power loss (operation with I_{rv})	P_{loss} [W]	1470		1960		2400		

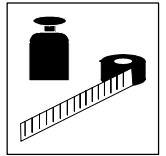

150 % overload		Type	8225	8226	8227
		Order No.	EVF8225-E	EVF8226-E	EVF8227-E
Variant "HVAC"		Type	8225-V020	8226-V020	8227-V020
		Order No.	EVF8225-E-V020	EVF8226-E-V020	EVF8227-E-V020
Power derating		[%/K] [%/m]	40 °C < T _V < 50 °C: 2.5 %/K 1000 m a.m.s.l. < h ≤ 4000 m a.m.s.l.: 5 %/1000 m		
Field frequency	Resolution	Absolute	0.02 Hz		
	Digital setpoint selection	Accuracy	± 0.05 Hz		
	Analog setpoint selection	Linearity	± 0.5 % (max. selected signal level: 5 V or 10 V)		
		Temperature sensitivity	0 ... 40 °C: +0.4 %		
	Offset		± 0 %		
Weight		m [kg]	36.5	59	59

Printed in bold Data for the operation with factory setting and a chopper frequency of 8 kHz.

- 1) This power can be additionally obtained when operating a matching motor
 - 2) The currents apply to a periodical load cycle with 1 minute overcurrent with the current mentioned here and 2 minutes base load with 75 % I_x.
 - 3) With mains choke/mains filter: max. output voltage = approx. 96 % of the mains voltage
 - 4) Only with variant "HVAC"
 - 5) Must only be operated with C144 = -1- (automatic chopper frequency derating at $\vartheta_{max} = +5 \text{ °C}$). Ensure not to exceed the currents.
- * Chopper frequency of the inverter

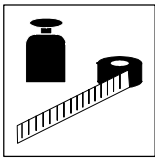

Technical Data

3.4.6 Types 8241 to 8243

150 % overload		Typ	8241		8242		8243	
		Order No.	EVF8241-E		EVF8242-E		EVF8243-E	
Variant "Cold Plate"		Type	8241-V003		8242-V003		8243-V003	
		Order No.	EVF8241-C-V003		EVF8242-C-V003		EVF8243-C-V003	
Variant "HVAC"		Type	8241-V020		8242-V020		8243-V020	
		Order No.	EVF8241-E-V020		EVF8242-E-V020		EVF8243-E-V020	
Mains voltage		V_r [V]	320 V -0 % $\leq V_r \leq$ 528 V +0 % ; 45 Hz ... 65 Hz \pm 0 %					
Alternative DC supply		V_{DC} [V]	460 V -0 % $\leq V_{DC} \leq$ 740 V +0 %					
Mains current with mains filter/mains choke without mains filter/mains choke		I_{mains} [A]	1.5		2.5		3.9	
		I_{mains} [A]	2.1		3.5		5.5	
Data for mains operation with 3 AC / 400 V / 50 Hz/60 Hz ; 460 V $\leq V_{DC} \leq$ 620 V or 3 AC / 480 V / 50 Hz/60 Hz ; 460 V $\leq V_{DC} \leq$ 740 V								
Motor power (4 pole ASM) at 4 kHz/8 kHz*		P_r [kW]	400 V	480 V	400 V	480 V	400 V	480 V
		P_r [hp]	0.37	0.37	0.75	0.75	1.5	1.5
Output power U, V, W at 4 kHz/8 kHz*		S_{r8} [kVA]	1.0	1.2	1.7	2.1	2.7	3.2
Output power + U_G , - U_G ¹⁾		P_{DC} [kW]	1.9	2.3	0.7	0.9	0	0
Output current	4 kHz*	I_{r8} [A]	1.5	1.5	2.5	2.5	3.9	3.9
	8 kHz*	I_{r8} [A]	1.5	1.5	2.5	2.5	3.9	3.9
	12kHz*	I_{r12} [A]	1.35	1.35	2.2	2.2	3.5	3.5
	16 kHz*	I_{r16} [A]	1.2	1.2	2.0	2.0	3.1	3.1
	Noise optimised 4 kHz* ⁴⁾	I_{r4} [A]	1.5	1.5	2.5	2.4	3.9	3.7
	Noise optimised 8 kHz* ⁴⁾	I_{r8} [A]	1.3	1.3	2.2	2.1	2.9	2.8
	Noise optimised 12 kHz*	I_{r12} [A]	1.3	1.3	2.1	2.1	3.4	3.4
	Noise optimised 16 kHz*	I_{r16} [A]	1.1	1.1	1.8	1.8	2.9	2.9
Max. output current for 60 s ²⁾	4 kHz*	I_{rmax8} [A]	2.2	2.25	3.7	3.75	5.8	5.85
	8 kHz*	I_{rmax8} [A]	2.2	2.25	3.7	3.75	5.8	5.85
	12 kHz*	I_{rmax12} [A]	2.0	2.0	3.3	3.3	5.2	5.2
	16 kHz*	I_{rmax16} [A]	1.8	1.8	3.0	3.0	4.7	4.7
	Noise optimised 4 kHz* ⁴⁾	I_{rmax4} [A]	2.3	2.2	3.8	3.6	5.8	5.5
	Noise optimised 8 kHz* ⁴⁾	I_{rmax8} [A]	2.0	1.8	3.2	3.0	5.0	4.7
	Noise optimised 12 kHz*	I_{rmax12} [A]	1.9	1.9	3.2	3.2	5.1	5.1
	Noise optimised 16 kHz*	I_{rmax16} [A]	1.6	1.6	2.7	2.7	4.3	4.3
Motor voltage ³⁾		V_M [V]	0 - 3 x V_{mains} / 0 Hz ... 50 Hz, if required up to 480 Hz					
Power loss (operation with I_{rj})		P_{loss} [W]	50		65		100	

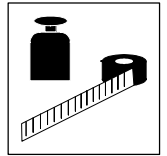

150 % overload		Type	8241	8242	8243
		Order No.	EVF8241-E	EVF8242-E	EVF8243-E
Variant "Cold Plate"		Type	8241-V003	8242-V003	8243-V003
		Order No.	EVF8241-C-V003	EVF8242-C-V003	EVF8243-C-V003
Variant "HVAC"		Type	8241-V020	8242-V020	8243-V020
		Order No.	EVF8241-E-V020	EVF8242-E-V020	EVF8243-E-V020
Power derating		[%/K] [%/m]	40 °C < T _V < 50 °C: 2.5 %/K 1000 m a.m.s.l. < h ≤ 4000 m a.m.s.l.: 5 %/1000 m		
Field frequency	Resolution	Absolute	0.02 Hz		
	Digital setpoint selection	Accuracy	± 0.05 Hz		
	Analog setpoint selection	Linearity	± 0.5 % (max. selected signal level: 5 V or 10 V)		
		Temperature sensitivity	0 ... 40 °C: +0.4 %		
		Offset	± 0 %		
Weight "Cold Plate" without heat sink		m [kg]	3.5	3.5	5.0

Printed in bold Data for the operation with factory setting and a chopper frequency of 8 kHz.

- 1) This power can be additionally obtained when operating a matching motor
 - 2) The currents apply to a periodical load cycle with 1 minute overcurrent with the current mentioned here and 2 minutes base load with 75 % I_x.
 - 3) With mains choke/mains filter: max. output voltage = approx. 96 % of the mains voltage
 - 4) Only with variant "HVAC"
- * Chopper frequency of the inverter

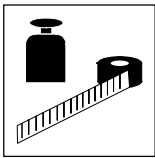

Technical Data

3.4.7 Types 8244 to 8246

150 % overload		Type	8244		8245		8246	
		Order No.	EVF8244-E		EVF8245-E		EVF8246-E	
Variant "Cold Plate"		Type	8244-V003		8245-V003		8246-V003	
		Order No.	EVF8244-C-V003		EVF8245-C-V003		EVF8246-C-V003	
Variant "HVAC"		Type	8244-V020		8245-V020		8246-V020	
		Order No.	EVF8244-E-V020		EVF8245-E-V020		EVF8246-E-V020	
Mains voltage		V_f [V]	320 V -0 % $\leq V_f \leq$ 528 V +0 %; 45 Hz ... 65 Hz \pm 0 %					
Alternative DC supply		V_{DC} [V]	460 V -0% $\leq V_{DC} \leq$ 740 V +0 %					
Mains current with mains filter/mains choke without mains filter/mains choke		I_{mains} [A]	7.0		12.0		20.5	
		I_{mains} [A]	-		16.8		-	
Data for mains operation with 3 AC / 400 V / 50 Hz/60 Hz ; 460 V $\leq V_{DC} \leq$ 620 V or 3 AC / 480 V / 50 Hz/60 Hz ; 460 V $\leq V_{DC} \leq$ 740 V								
Motor power (4 pole ASM) at 4 kHz/8 kHz*		P_r [kW]	400 V	480 V	400 V	480 V	400 V	480 V
		P_r [hp]	3.0	3.0	5.5	5.5	11.0	11.0
Output power U, V, W at 4 kHz/8 kHz*		S_{r8} [kVA]	4.0	4.0	7.5	7.5	15.0	15.0
Output power + U_G , - U_G ¹⁾		P_{DC} [kW]	4.8	5.8	9.0	10.8	16.3	10.8
Output current	4 kHz*	I_{r4} [A]	2.0	2.5	0	0	0	0
	8 kHz*	I_{r8} [A]	7.0	7.0	13.0	13.0	23.5	23.5
	12 kHz*	I_{r12} [A]	7.0	7.0	13.0	13.0	23.5	23.5
	16 kHz*	I_{r16} [A]	6.3	6.3	11.7	11.7	20.0	19.1
	Noise optimised 4 kHz* ⁴⁾	I_{r4} [A]	5.6	5.6	10.4	10.4	16.5	15.7
	Noise optimised 8 kHz* ⁴⁾	I_{r8} [A]	7.0	6.6	13.0	12.3	23.5	22.1
	Noise optimised 12 kHz*	I_{r12} [A]	6.0	5.6	11.1	10.4	20.0	18.8
	Noise optimised 16 kHz*	I_{r16} [A]	6.1	6.1	11.3	11.3	19.4	18.4
Max. output current for 60 s ²⁾	4 kHz*	I_{max8} [A]	5.2	5.2	9.7	9.7	15.2	14.6
	8 kHz*	I_{max8} [A]	10.5	10.5	19.5	19.5	35.0	33.5
	12 kHz*	I_{max12} [A]	10.5	10.5	19.5	19.5	35.0	33.5
	16 kHz*	I_{max16} [A]	9.5	9.5	17.5	17.5	30.0	28.7
	Noise optimised 4 kHz* ⁴⁾	I_{max4} [A]	8.4	8.4	15.6	15.6	24.6	23.6
	Noise optimised 8 kHz* ⁴⁾	I_{max8} [A]	10.5	8.4	19.5	15.6	35.5	28.2
	Noise optimised 12 kHz*	I_{max12} [A]	7.8	7.8	14.5	14.5	22.9	21.8
	Noise optimised 16 kHz*	I_{max16} [A]	9.1	9.1	16.5	16.5	29.0	27.6
Motor voltage ³⁾	V_M [V]	7.8	7.8	14.5	14.5	22.9	21.8	
Power loss (operation with I_{r8})	P_{loss} [W]	150		210		360		
Power derating	$\frac{\%}{K}$ $\frac{\%}{m}$	40 °C < T_V < 50 °C: 2.5 %/K 1000 m a.m.s.l. < h \leq 4000 m a.m.s.l.: 5 %/1000 m						

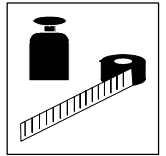

150 % overload		Type	8244	8245	8246
		Order No.	EVF8244-E	EVF8245-E	EVF8246-E
Variant "Cold Plate"		Type	8244-V003	8245-V003	8246-V003
		Order No.	EVF8244-C-V003	EVF8245-C-V003	EVF8246-C-V003
Variant "HVAC"		Type	8244-V020	8245-V020	8246-V020
		Order No.	EVF8244-E-V020	EVF8245-E-V020	EVF8246-E-V020
Field frequency	Resolution	Absolute	0.02 Hz		
	Digital setpoint selection	Accuracy	± 0.05 Hz		
	Analog setpoint selection	Linearity	± 0.5 % (max. selected signal level: 5 V or 10 V)		
		Temperature sensitivity	0 ... 40 °C: +0.4 %		
		Offset	± 0 %		
Weight "Cold Plate" without heat sink		m [kg]	5.0	7.5	7.5

Printed in bold Data for the operation with factory setting and a chopper frequency of 8 kHz.

- 1) This power can be additionally obtained when operating a matching motor
 - 2) The currents apply to a periodical load cycle with 1 minute overcurrent with the current mentioned here and 2 minutes base load with 75 % I_x .
 - 3) With mains choke/mains filter: max. output voltage = approx. 96 % of the mains voltage
 - 4) Only with variant "HVAC"
- * Chopper frequency of the inverter

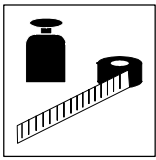

Technical Data

3.5 Rated data (Operation with 120 % overload)

3.5.1 Operating conditions

- Applications:
 - Pumps with square characteristic
 - Fans
- Operation only
 - with mains filter or mains choke,
 - with mains voltage 3 AC / 400 V / 50 Hz/60 Hz,
 - 821X with chopper frequencies ≤ 8 kHz,
 - 822X/824X with chopper frequencies = 4 kHz (chopper frequencies ≤ 16 kHz possible, load-dependent derating).
- Automatic chopper-frequency reduction to 4 kHz.
- Adapt mains-side accessories to the increased mains current:
 - Fuses and cable cross-sections, see chapter 3.6.3.
 - For data of other components, see "Accessories".

3.5.2 Types 821X

120 % overload		Type	8211	8212	8213	8214	8215	8216	8217	8218
Rated mains current with mains filter/mains choke		I_r [A]	3.0	3.9	7.0	7.0	12.0	12.0	20.5	20.5
Data for mains operation with 3 AC / 400 V / 50 Hz/60 Hz ; $450 \text{ V} \leq V_{DC} \leq 650 \text{ V}$										
Motor power (4 pole ASM)		P_r [kW]	1.1	1.5	3.0	3.0	5.5	5.5	11.0	11.0
		P_r [hp]	1.5	2.0	4.0	4.0	7.5	7.5	15.0	15.0
Output power U, V, W		S_r [kVA]	2.1	2.7	5.2	5.2	9.0	9.0	16.3	16.3
Output current	4 kHz	I_r [A]	3.0	3.9	7.3	7.3	13.0	13.0	23.5	23.5
	8 kHz ^{*1)}	I_r [A]	3.0	3.9	7.3	7.3	13.0	13.0	23.5	23.5
Max. output current for 60 s ²⁾	4 kHz	I_{Nm} [A]	3.6	5.9	8.3	11.0	14.1	19.5	24.8	35.3
	8 kHz ^{*1)}	I_{Nm} [A]	3.6	5.9	8.3	11.0	14.1	19.5	24.8	35.3
Power loss		P_{loss} [W]	65	75	100	100	200	200	400	400

¹⁾ Only with variant "HVAC"

* No dyn. chopper frequency derating of the inverter
All other data, see chapter 3.4.2 and chapter 3.4.3.

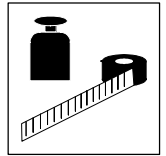

3.5.3 Types 822X

120 % overload		Type	8221	8222	8223 ¹⁾	8224	8225 ¹⁾	8226	8227 ¹⁾
Mains current with mains filter/mains choke		I_{mains} [A]	39.0	50.0	60.0	97.0	119	145	185
Data for mains operation with 3 AC / 400 V / 50 Hz/60 Hz ; $460 \text{ V} \leq V_{\text{DC}} \leq 620 \text{ V}$									
Motor power (4 pole ASM) at 4 kHz/8 kHz*		P_r [kW]	22	30	37.5	55	75	90	110
		P_r [hp]	30	40	50	74	100	120	148
Output power U, V, W at 4 kHz/8 kHz*		S_{r4} [kVA]	29.8	39.5	46.4	74.8	91.5	110	142
		S_{r8} [kVA]	22.2	32.6	41.6	61.7	76.2	103.9	124.7
Output current	4 kHz*	I_{r4} [A]	43	56	66	100	135	159	205
	8 kHz*	I_{r8} [A]	32	47	59	89	110	150	171
	12 kHz*	I_{r12} [A]	27	40	50	62	88	120	126
	16 kHz*	I_{r16} [A]	24	35	44	54	77	105	108
	Noise optimised 4 kHz* ³⁾	I_{r4} [A]	32	47	59	89	110	150	159 ⁴⁾
	Noise optimised 8 kHz* ³⁾	I_{r8} [A]	29	43	47 ⁴⁾	59 ⁴⁾	76 ⁴⁾	92 ⁴⁾	100 ⁴⁾
	Noise optimised 12 kHz*	I_{r12} [A]	25	37	44	54	66	82	90
	Noise optimised 16 kHz*	I_{r16} [A]	21	30	35	46	60	67	72
Max. output current for 60 s ²⁾	4 kHz*	$I_{\text{max}4}$ [A]	48	70.5	89	134	165	225	270
	8 kHz*	$I_{\text{max}8}$ [A]	48	70.5	89	134	165	225	221
	12 kHz*	$I_{\text{max}12}$ [A]	40	59	75	92	114	156	164
	16 kHz*	$I_{\text{max}16}$ [A]	36	53	66	81	100	136	140
	Noise optimised 4 kHz* ³⁾	$I_{\text{max}4}$ [A]	48	70.5	89	134	165	225	238 ⁴⁾
	Noise optimised 8 kHz* ³⁾	$I_{\text{max}8}$ [A]	43	64	70 ⁴⁾	88 ⁴⁾	114 ⁴⁾	138 ⁴⁾	150 ⁴⁾
	Noise optimised 12 kHz*	$I_{\text{max}12}$ [A]	38	56	66	81	85	107	117
	Noise optimised 16 kHz*	$I_{\text{max}16}$ [A]	31	46	53	69	78	87	94
Power loss (operation with I_{r4})		P_{loss} [W]	640	810	810	1350	1470	2100	2400

- 1) Max. permissible ambient operating temperature +35 °C
 - 2) The currents apply to a periodical load cycle with 1 minute overcurrent with the current mentioned here and 2 minutes base load with 75 % I_{rx} .
 - 3) Only with variant "HVAC"
 - 4) Must only be operated with C144 = -1- (automatic chopper frequency derating at $\vartheta_{\text{max}} = +5 \text{ °C}$). Ensure not to exceed the currents.
- * Chopper frequency of the inverter
For more data, see chapter 3.4.4 and chapter 3.4.5.

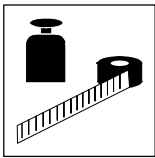

Technical Data

3.5.4 Types 824X

120 % overload		Type	8241	8242	8243	8244	8245	8246
Mains current with mains filter/mains choke		I_{mains} [A]	1.7	2.8	5.0	8.8	15.0	20.5
Data for mains operation with 3 AC / 400 V / 50 Hz/60 Hz ; $460 \text{ V} \leq V_{\text{DC}} \leq 620 \text{ V}$								
Motor power (4 pole ASM) at 4 kHz/8 kHz*		P_r [kW]	0.55	1.1	2.2	4.0	7.5	11.0
		P_r [hp]	0.75	1.5	2.9	5.4	10.0	15.0
Output power U, V, W at 4 kHz/8 kHz*		S_{r4} [kVA]	1.3	2.1	3.8	6.5	11.1	16.3
		S_{r8} [kVA]	1.0	1.7	2.7	4.8	9.0	16.3
Output current	4 kHz*	I_{r4} [A]	1.8	3.1	5.5	9.2	16.0	23.5
	8 kHz*	I_{r8} [A]	1.5	2.5	3.9	7.0	13.0	23.5
	12 kHz*	I_{r12} [A]	1.35	2.2	3.5	6.3	11.7	20.0
	16 kHz*	I_{r16} [A]	1.2	2.0	3.1	5.6	10.4	16.5
	Noise optimised 4 kHz* ²⁾	I_{r4} [A]	1.5	2.5	3.9	7.0	13.0	23.5
	Noise optimised 8 kHz* ²⁾	I_{r8} [A]	1.3	2.2	2.9	6.0	11.1	20.0
	Noise optimised 12 kHz*	I_{r12} [A]	1.3	2.1	3.4	6.1	11.3	19.4
	Noise optimised 16 kHz*	I_{r16} [A]	1.1	1.8	2.9	5.2	9.7	15.2
Max. output current for 60 s ¹⁾		$I_{\text{max}4}$ [A]	2.25	3.6	6.6	11.0	19.5	35.3
	8 kHz*	I_{r8} [A]	2.2	3.7	5.8	10.5	19.5	35
	12 kHz*	I_{r12} [A]	2.0	3.3	5.2	9.5	17.5	30.0
	16 kHz*	I_{r16} [A]	1.8	3.0	4.7	8.4	15.6	24.6
	Noise optimised 4 kHz* ²⁾	I_{r4} [A]	2.3	3.8	5.8	10.5	19.5	35.5
	Noise optimised 8 kHz* ²⁾	I_{r8} [A]	2.0	3.2	5.0	7.8	14.5	22.9
	Noise optimised 12 kHz*	I_{r12} [A]	1.9	3.2	5.1	9.1	16.5	29.0
	Noise optimised 16 kHz*	I_{r16} [A]	1.6	2.7	4.3	7.8	14.5	22.9
Power loss (operation with I_{rx})		P_{loss} [W]	50	65	115	165	260	360

1) The currents apply to a periodical load cycle with 1 minute overcurrent with the current mentioned here and 2 minutes base load with 75 % I_{rx} .

2) Only with variant "HVAC"

* Chopper frequency of the inverter
For more data see chapter 3.4.6 and chapter 3.4.7.

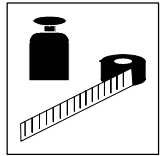

3.6 Fuses and cable cross-sections

3.6.1 Operation of controllers in UL-approved systems

- Use only UL-approved fuses and fuse holders:
 - 500 V to 600 V in the mains input (AC, F1 ... F3),
 - 700 V in the voltage DC bus (DC, F4/F5),
 - Activation characteristic "H" or "K5".
- Only use UL-approved cables



Note!

- UL-approved fuses and fuse holder are produced and sold by e.g. Gemballa Electronics GmbH in Kaltenkirchen, Germany.
 - DC fuses as part of the Lenze accessories are UL approved.
-

3.6.1.1 Protection of the motor cables

- For functional reasons, the motor cables need not to be protected by fuses if you only connect a motor per controller.
- If you want to drive several motors in parallel connected to a controller, an individual cable protection is required when reducing the cable cross-section.
- Refer to the data listed in "Operation with mains filter/mains choke"

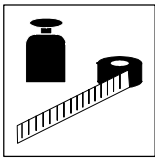

Technical Data

3.6.2 Single drives with 150 % overload

The table values are valid for the operation of 82XX controllers as single drives with a matching motor and 150 % overload.

Type	Mains input L1, N, PE / motor connection U, V, W, PE									
	Operation without mains filter/mains choke					Operation with mains filter/mains choke				
	Fuse F1, F2, F3		E.I.c.b.	Cable cross-section ¹⁾		Fuse F1, F2, F3		E.I.c.b.	Cable cross-section ¹⁾	
	VDE	UL	VDE	mm ²	AWG	VDE	UL	VDE	mm ²	AWG
8201	M 10A	-	C 10A	1.5	15	M 10A	-	C 10A	1.5	15
8202	M 15A	-	C 16A	2.5	13	M 15A	-	C 16A	2.5 [1.5]	13 [15]
8203	M 20A	-	C 20A	4	11	M 15A	-	C 16A	2.5 [1.5]	13 [15]
8204	-	-	-	-	-	M 20A	-	C 20A	4 [2.5]	11 [13]

Values in square brackets are valid for motor connection

Type	Mains input L1, L2, L3, PE / motor connection U, V, W, PE									
	Operation without mains filter/mains choke					Operation with mains filter/mains choke				
	Fuse F1, F2, F3		E.I.c.b.	Cable cross-section ¹⁾		Fuse F1, F2, F3		E.I.c.b.	Cable cross-section ¹⁾	
	VDE	UL	VDE	mm ²	AWG	VDE	UL	VDE	mm ²	AWG
8211	M 6A	-	B 6A	1	17	M 6A	-	B 6A	1	17
8212	M 10A	-	B 6A	1.5	15	M 6A	-	B 6A	1	17
8213	M 10A	-	B 10A	1.5	15	M 10A	-	B 10A	1.5	15
8214	-	-	-	-	-	M 10A	-	B 10A	1.5	15
8215	M 16A	-	B 16A	2.5	13	M 16A	-	B 13A	2.5	13
8216	M 25A	-	B 25A	6	10	M 20A	-	B 20A	4	11
8217	M 32A	-	B 32A	6	10	M 25A	-	B 25A	6	10
8218	-	-	-	-	-	M 32A	-	B 32A	6	10

Type	Mains input L1, L2, L3, PE / motor connection U, V, W, PE									
	Operation without mains filter/mains choke					Operation with mains filter/mains choke				
	Fuse F1, F2, F3		E.I.c.b.	Cable cross-section ¹⁾		Fuse F1, F2, F3		E.I.c.b.	Cable cross-section ¹⁾	
	VDE	UL	VDE	mm ²	AWG	VDE	UL	VDE	mm ²	AWG
8221	63A	--	--	16	5	M 35A	35A	--	10	7
8222	--	--	--	--	--	M 50A	50A	--	16	5
8223	--	--	--	--	--	M 80A	80A	--	25	3
8224	--	--	--	--	--	M 100A	100A	--	50	0
8225	--	--	--	--	--	M 125A	125A	--	70	2 / 0
8226	--	--	--	--	--	M 160A	175A	--	95	3 / 0
8227	--	--	--	--	--	M 200A	200A	--	120	4 / 0
8241	M 6A	5A	B 6A	1	17	M 6A	5A	B 6A	1	17
8242	M 6A	5A	B 6A	1	17	M 6A	5A	B 6A	1	17
8243	M 10A	10A	B 10A	1.5	15	M 10A	10A	B 10A	1.5	15
8244	--	--	--	--	--	M 10A	10A	B 10A	1.5	15
8245	M 25A	25A	B 25A	6	10	M 20A	20A	B 20A	4	11
8246	--	--	--	--	--	M 32A	25A	B 32A	6	10

¹⁾ Observe national and regional regulations (e.g. VDE/EVU)!

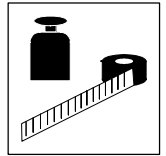

3.6.3 Single drives with 120 % overload

The table values are valid for operation of 82XX controllers with matching motor and 120 % overload in pump and fan drives.

Type	Mains input L1, L2, L3, PE / motor connection U, V, W, PE				
	Operation with mains filter/mains choke				
	Fuse F1, F2, F3		E.I.c.b.	Cable cross-section ¹⁾	
	VDE	UL	VDE	mm ²	AWG
8211	M 6A	-	B 6A	1	17
8212	M 6A	-	B 6A	1	17
8213	M 10A	-	B 10A	1.5	15
8214	M 10A	-	B 10A	1.5	15
8215	M 20A	-	B 20A	4	11
8216	M 20A	-	B 20A	4	11
8217	M 32A	-	B 32A	6	10
8218	M 32A	-	B 32A	6	10

Type	Mains input L1, L2, L3, PE / motor connection U, V, W, PE				
	Operation only with mains filter/mains choke				
	Fuse F1, F2, F3		E.I.c.b.	Cable cross-section ¹⁾	
	VDE	UL	VDE	mm ²	AWG
8221	M 50A	50A	--	16	5
8222	M 63A	63A	--	25	3
8223	M 80A	80A	--	25	3
8224	M 125A	125A	--	70	2 / 0
8225	M 160A	175A	--	95	3 / 0
8226	M 160A	175A	--	95	3 / 0
8227	M 200A	200A	--	120	4 / 0
8241	M 6A	5A	B 6A	1	17
8242	M 6A	5A	B 6A	1	17
8243	M 10A	10A	B 10A	1.5	15
8244	M 10A	10A	B 10A	1.5	15
8245	M 20A	20A	B 20A	4	11
8246	M 32A	25A	B 32A	6	10

¹⁾ Observe national and regional regulations (e.g. VDE/EVU)!

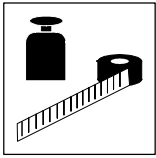

3.7 Analog plug-in module 8279IB

Order No. EMZ8279IB



Note!

Only controllers of the 8210, 8220 and 8240 HVAC (V020) series can be equipped with an analog plug-in module 8278IB, because they provide the required software.

3.7.1 Features

The analog plug-in module 8279IB provides a second analog input. It converts an analog input signal (0 ... 10 V or 0 ... 20 mA) into a digital signal (pulse frequency 0 ... 10 kHz) with the following levels:

- LOW level = 0 V ... 3 V
- HIGH level = 12 V ... 30 V

For operation with 4 ... 20 mA, the following codes must be parameterised:

- C426 = 125 %
- C427 = -12.5 %

Further notes can be obtained from the code table.

Controllers of the 8210, 8220 and 8240 series equipped with an analog plug-in module, can be used for the following process controller applications:

- Pressure regulation
- Temperature or volume control
- Setpoint summation
- Speed or dancer-position control

To operate the analog plug-in module, the terminal configuration C007 has to be set to -28-...-45- or -48- ... -51-.

The inverters with plug-in module are subject to the technical data and application conditions of the controllers.

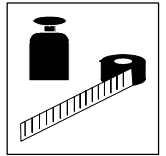

3.8 Dimensions

The controller dimensions depend on the mechanical installation (see chapter 4.1).

3.8.1 Analog plug-in module



Note!

Only controller of the series 8210, 8220 and 8240 HVAC (V020) can be equipped with the analog plug-in module.

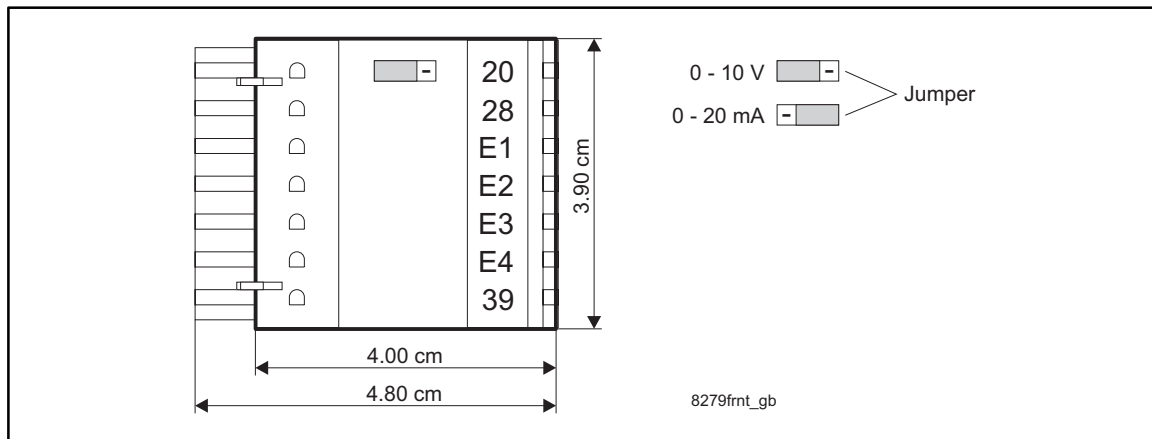
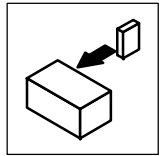

FIG 3-2 Dimensions of analog plug-in module

The changeover of the analog input between 0 V ... 10 V (factory setting) or 0 mA ... 20 mA (internal 500 Ω load) is carried out via a jumper on the PCB.

The jumper can be accessed when removing the cover from the internal PCB.



4 Installation

4.1 Mechanical installation

4.1.1 Important notes

- Use the controllers only as built-in devices!
- If the cooling air contains pollutants (dust, fluff, grease, aggressive gases):
 - Take suitable preventive measures, e.g. separate air duct, installation of filters, regular cleaning, etc.
- Ensure free space!
 - You can install several controllers next to each other without free space in a control cabinet.
 - Ensure unimpeded ventilation of cooling air and outlet of exhaust air!
 - Allow a free space of 100 mm at the top and at the bottom.
- Do not exceed the ambient temperature permitted during operation (see chapter 3.3).
- With continuous oscillations or vibrations:
 - Check the use of shock absorbers.

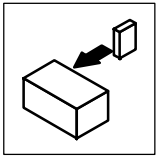

Installation

Possible mounting positions for types 8201 to 8214

- In vertical position at the back of the control cabinet, terminals point to the front:
 - With attached fixing rails.
 - With special fixing unit on one or two DIN rails.
- Turned by 90° (flast assembly on the backside of the control cabinet):
 - Insert the attached fixing rail into the guides at the heat sink.
- Horizontally with an additional fan.
- On a pivoting frame for assembly depths < 198 mm:
 - Therefore easy handling and installation of the front interfaces possible.

Possible mounting positions for types 8215 to 8218

- In vertical position at the back of the control cabinet, terminals point to the front:
 - With attached fixing rails.
 - Thermally separated with external heat sink ("push-through technique").
 - Variant V003 thermally separated with external cooler in "Cold plate" technique (e.g. with convection cooler).

Possible mounting positions types 822X/824X

- In vertical position at the back of the control cabinet, terminals point to the front:
 - With attached fixing brackets.
 - Thermally separated with external heat sink ("push-through technique").
 - Variant V003 thermally separated with external cooler in "Cold plate" technique (e.g. with convection cooler).

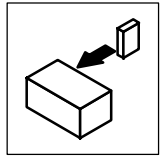

4.1.2 Standard assembly with fixing rails or fixing brackets

4.1.2.1 Types 8201 to 8204

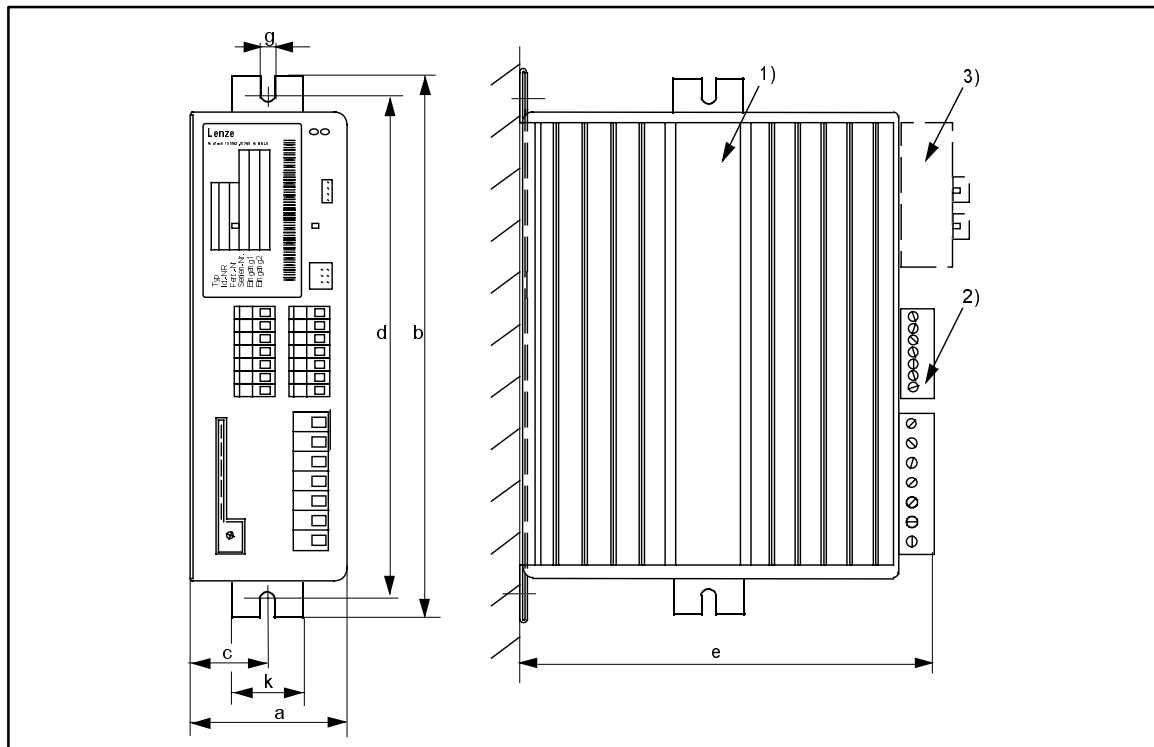

FIG 4-1 Dimensions 8201 - 8204: Standard assembly

- 1) Insert the fixing rail here for side assembly
- 2) Observe the free space required for the connection cables
- 3) With attachable fieldbus or I/O module:
Observe assembly depth and assembly space required for connection cables

[mm]	a	b	c	d	e ³⁾	g	k
8201	64	210	29	190	158	6.5	30
8202	64	210	29	190	198	6.5	30
8202-V002	64	210	29	190	158	6.5	30
8203 / 8204	83	283	38	263	211	6.5	30

4.1.2.2 Type 8202-V002 (reduced assembly depth)

This variant is equipped with a heat sink with a smaller surface. Observe the following points to comply with the technical data:

- Assembly on an unpainted, metallic assembly board.
- Area > 0.15 m².
- Sheet thickness at least 2 mm.

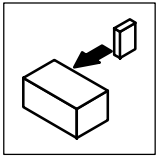

Installation

4.1.2.3 Types 8211 to 8214

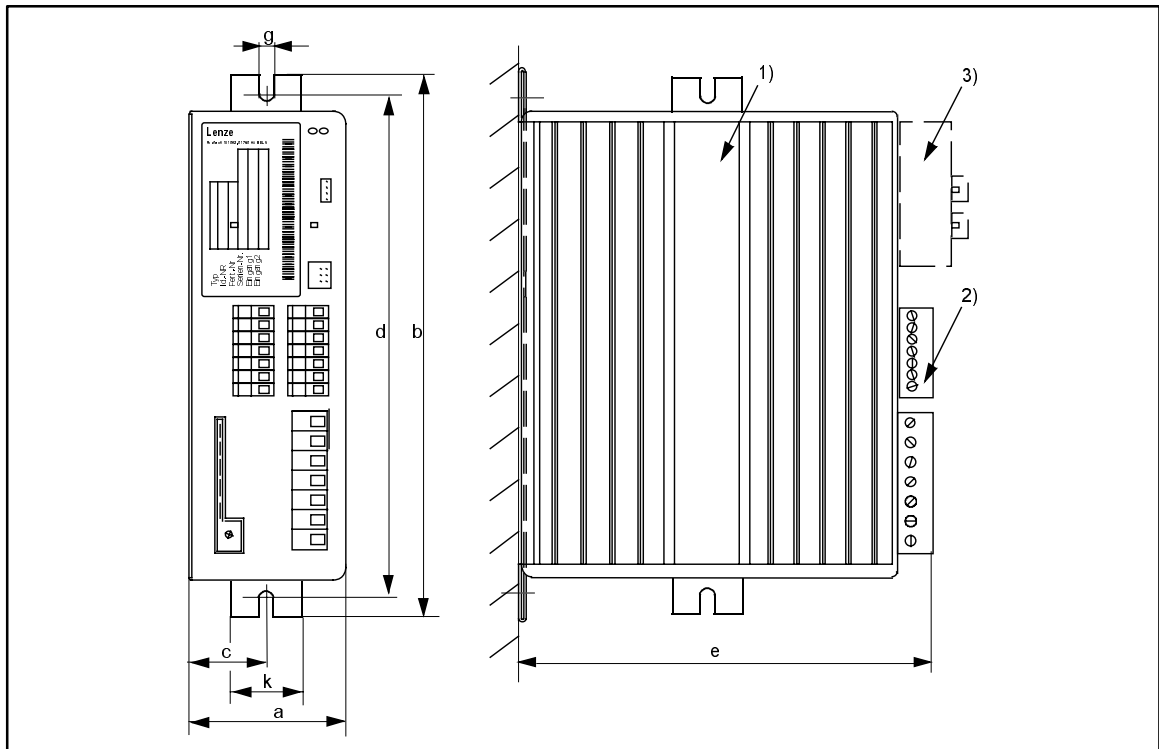
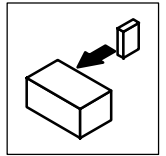

FIG 4-2 Dimensions 8211 - 8214: Standard assembly

- 1) Insert the fixing rail here for side assembly
- 2) Observe the free space required for the connection cables
- 3) With attachable fieldbus or I/O module:
Observe assembly depth and assembly space required for connection cables

[mm]	a	b	c	d	e ³⁾	g	k
8211 / 8212 / 8213 / 8214	83	283	38	263	211	6.5	30



4.1.2.4 Types 8215 to 8218

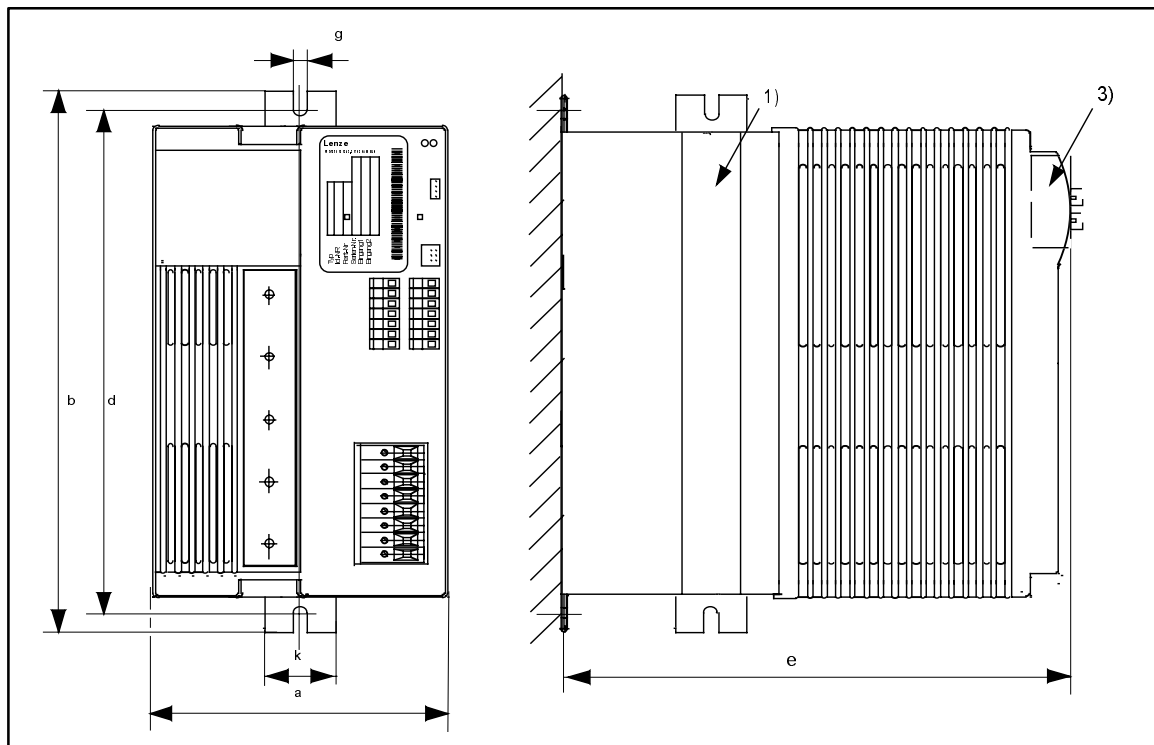
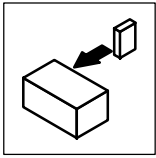

FIG 4-3 Dimensions 8215 - 8218: Standard assembly

- 1) Insert the fixing rail here for side assembly
- 2) Observe the free space required for the connection cables
- 3) With attachable fieldbus or I/O module:
Observe assembly depth and assembly space required for connection cables

[mm]	a	b	d	e ³⁾	g	k
8215 / 8216 / 8217 / 8218	125	283	263	218	6.5	30



Installation

4.1.2.5 Types 8221 to 8227

Assembly preparation (see FIG 4-4)	
To assemble and install the controller it is necessary to remove the unit cover. The accessory kit inside the controller contains the parts required for assembly and installation.	<ol style="list-style-type: none"> 1. Loosen screws (x). 2. Swing cover to the top and detach. 3. Screw fixing brackets onto the housing.

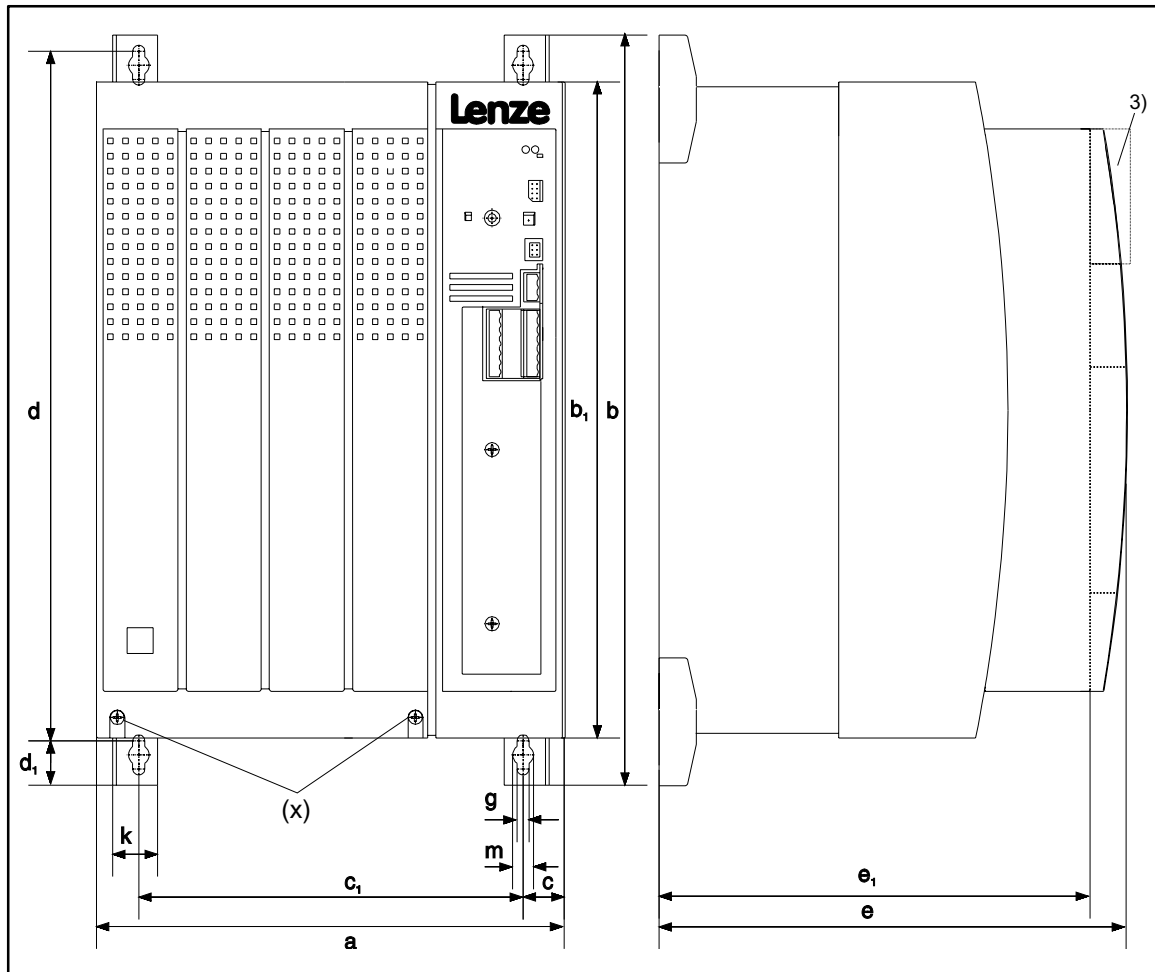
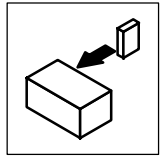

FIG 4-4 Dimensions 8221 - 8227: Standard assembly

³⁾ With attachable fieldbus or I/O module:
Observe assembly depth and assembly space required for connection cables

[mm]	a	b	b1	c	c1	d	d1	e ³⁾	e1	g	k	m
8221 / 8222 / 8223	250	402	350	22	206	370	24	250	230	6.5	24	11
8224	340	580	510	28.5	283	532	38	285	265	11	24	18
8225	340	672	591	28.5	283	624	38	285	265	11	28	18
8226 / 8227	450	748.5	680	30.5	389	702	38	285	265	11	28	18



4.1.2.6 Types 8241 to 8246

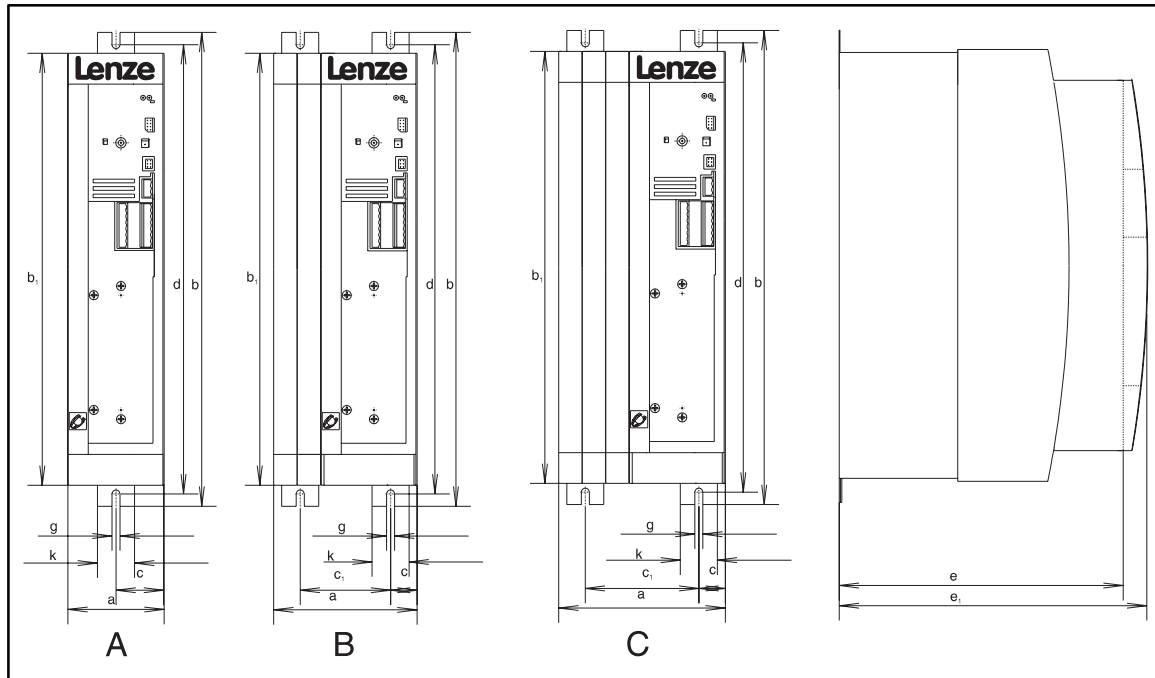
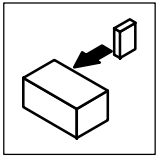

FIG 4-5 Dimensions 8241 - 8246: Standard assembly

- 3) With attachable fieldbus or I/O module:
Observe assembly depth and assembly space required for connection cables

[mm]	Fig.	a	b	b1	c	c1	d	d1	e ³⁾	e1	g	k	m
8241 / 8242	A	78	384	350	39	-	365	-	230	250	6.5	30	-
8243 / 8244	B	97	384	350	48.5	-	365	-	230	250	6.5	30	-
8245 / 8246	C	135	384	350	21.5	92	365	-	230	250	6.5	30	-



Installation

4.1.3 DIN-rail assembly

4.1.3.1 Types 8201 to 8204

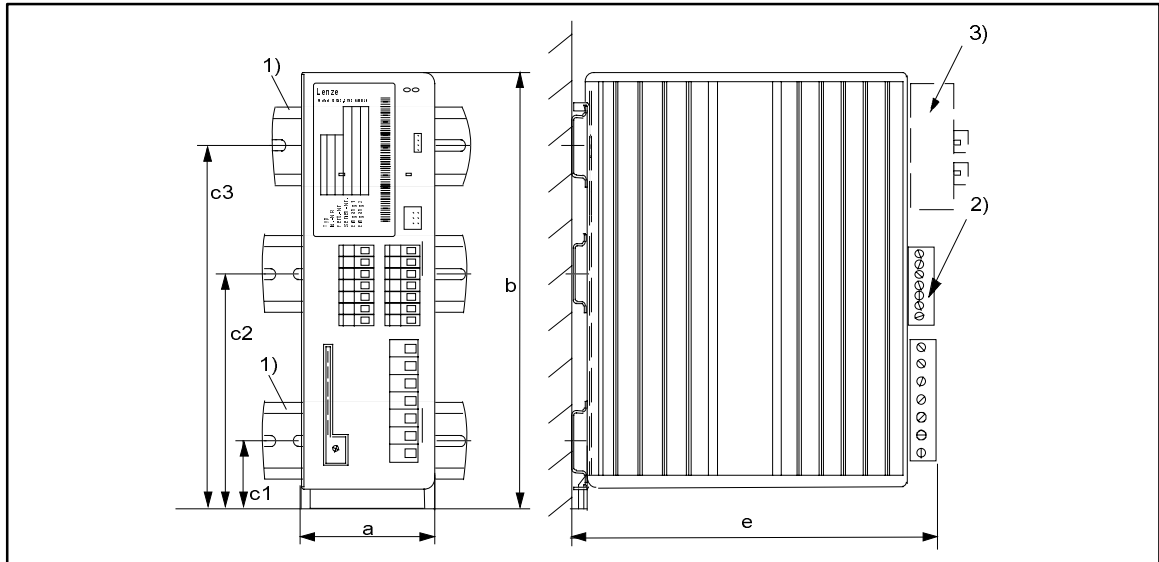
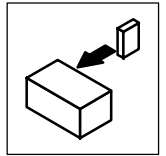

FIG 4-6 Dimensions 8201 - 8204: DIN rail assembly

- 1) 8201/8202: Assembly on a DIN rail (middle) or two DIN rails (top and bottom) possible
8203 - 8204: Assembly on two DIN rails required
- 2) Observe the free space required for the connection cables
- 3) With attachable fieldbus or I/O module:
Observe assembly depth and assembly space required for connection cables

[mm]	a	b	c1	c2	c3	e ³⁾
8201	64	188	16	98	149	173
8202	64	188	16	98	149	213
8203 / 8204	83	258	16	-	149	237



4.1.3.2 Types 8211 to 8214

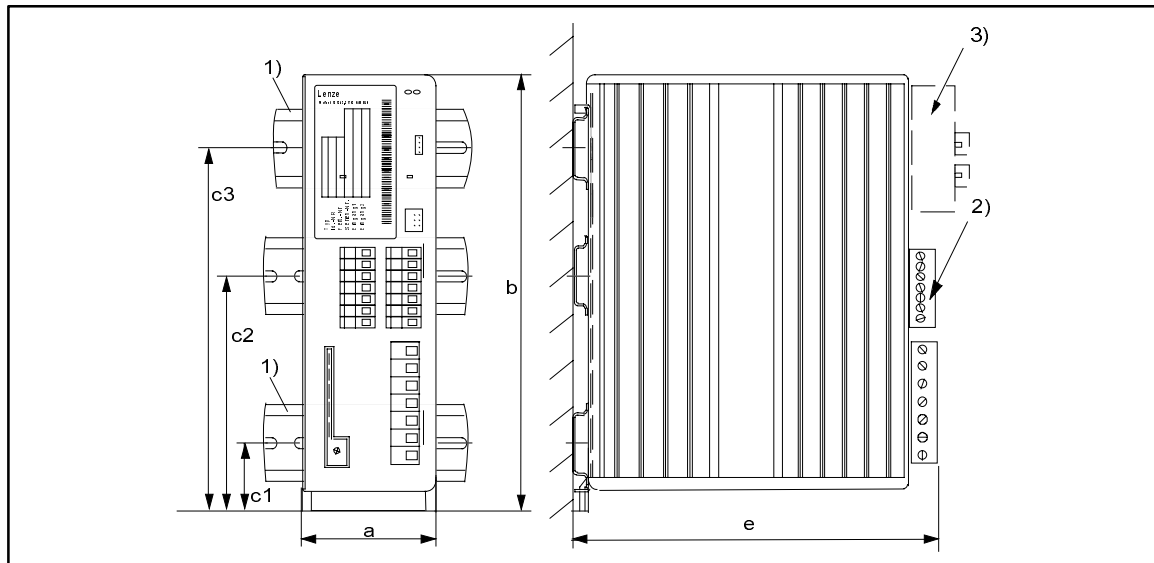
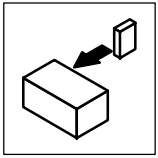

FIG 4-7 Dimensions 8211 - 8214: DIN-rail assembly

- 1) Assembly on two DIN rails required
- 2) Observe the free space required for the connection cables
- 3) With attachable fieldbus or I/O module:
Observe assembly depth and assembly space required for connection cables

[mm]	a	b	c1	c2	c3	e ³⁾
8211 / 8212 / 8213 / 8214	83	258	16	-	149	226



Installation

4.1.4 Assembly with thermally separated power stage ("push-through technique")

The heat sink of the controllers

- 8215 to 8218
- 8221 to 8227
- 8241 to 8246

can also be externally mounted to reduce the heat generated in the control cabinet. You need an assembly frame with seal (see Accessories).

- Distribution of the power loss of the controller:
 - Enter approx. 65 % via the separated heat sink (heat sink + blower)
 - Enter approx. 35 % inside the controller
- The enclosure of the separated heat sink (heat sink + blower) is IP41.
- The rated data of the controller is still valid.

Assembly preparation

1. Lay the halves of the assembly frame into the slot provided on the controller.
2. Push the frame halves together until the ends catch.
3. Slip the seal over the heat sink and lay it into the provided slot.

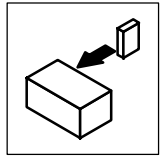

4.1.4.1 Types 8215 to 8218

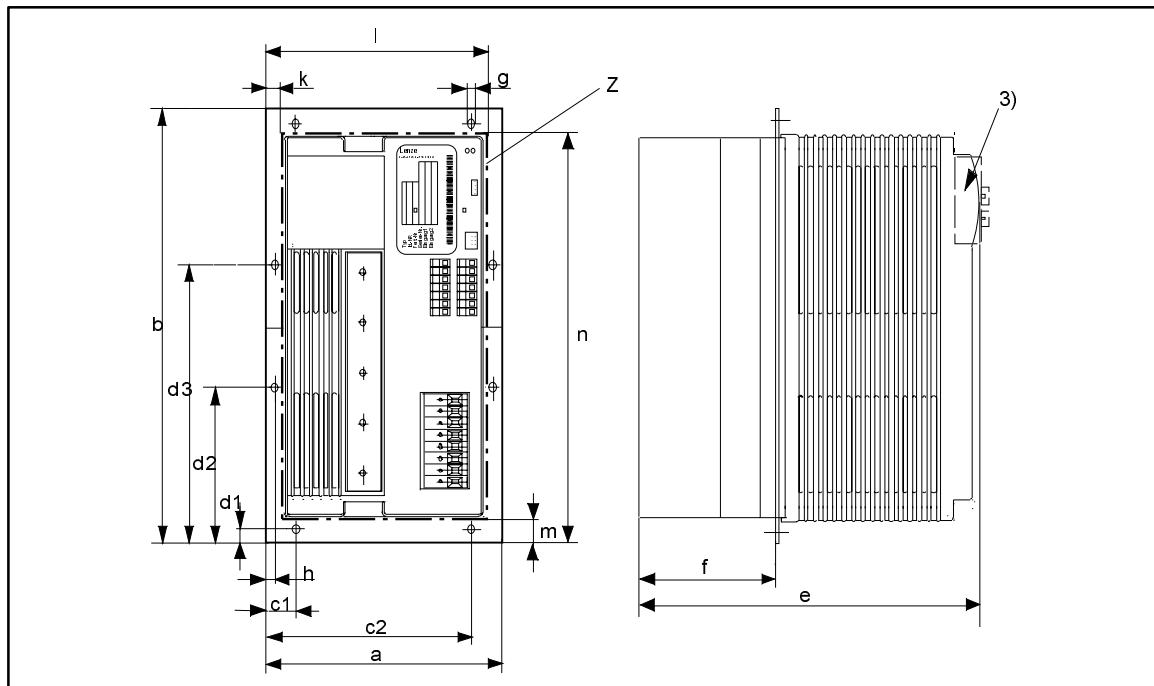
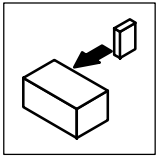

FIG 4-8 Dimensions 8215 - 8218: Assembly with thermally separated power stage

3) With attachable fieldbus or I/O module:
Observe assembly depth and assembly space required for connection cables

[mm]	a	b	c1	c2	d1	d2	d3	e ³⁾	f	g	h
8215 / 8216 / 8217 / 8218	162	283	31	132	10	90.5	192.5	218	88	6.5	8.5

Assembly cut-out [mm]	Height	Width	k	l	m	n
Line Z	250 ±5	132 ±5	16 ±2	147 ±2	19 ±2	266 ±2



Installation

4.1.4.2 Types 8221 to 8227

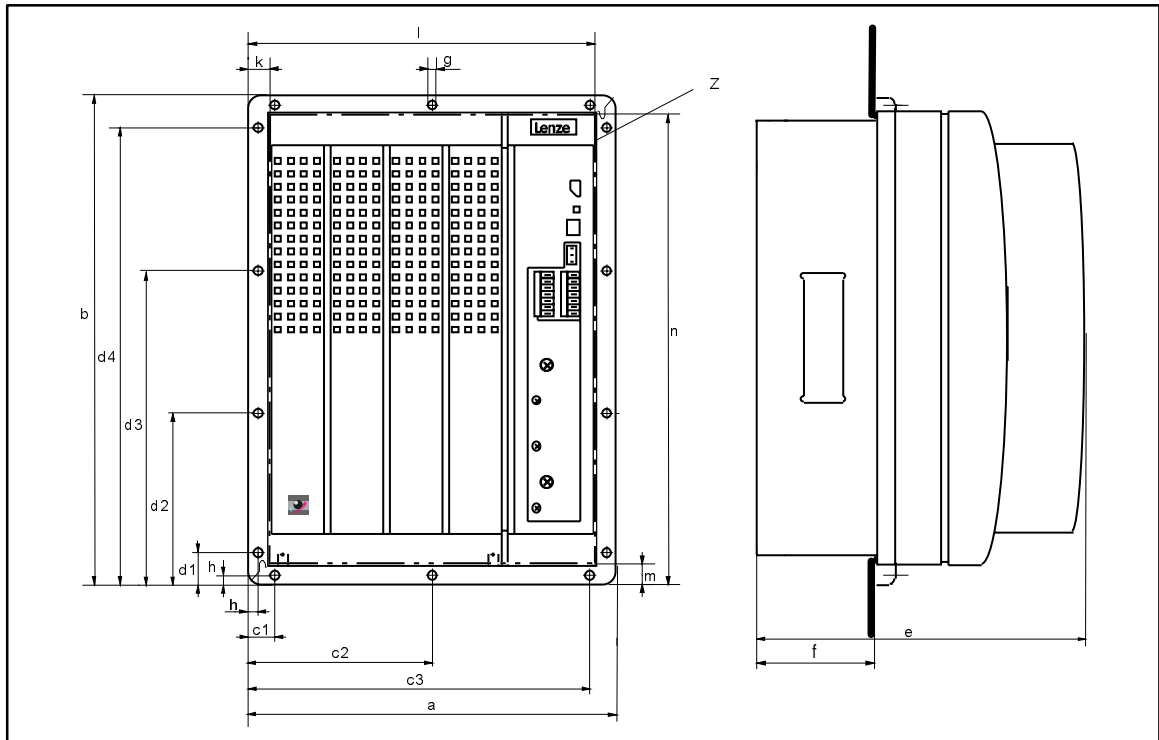
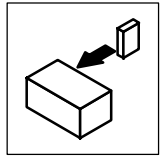

FIG 4-9 Dimensions 8221 - 8227: Assembly with thermally separated power stage

3) With attachable fieldbus or I/O module:
Observe assembly depth and assembly space required for connection cables

[mm]	a	b	c1	c2	c3	d1	d2	d3	d4	e ³⁾	f	g	h
8221 / 8222 / 8223	280	379	28	140	252	41	141	238	338	250	90	6	9
8224 / 8225													
8226 / 8227													

Assembly cut-out Z [mm]	Height	Width	k	l	m	n
8221 / 8222 / 8223	338 ±1	238 ±1	20 ±2	259 ±2	20 ±2	359 ±2
8224 / 8225						
8226 / 8227						



4.1.4.3 Types 8241 to 8246

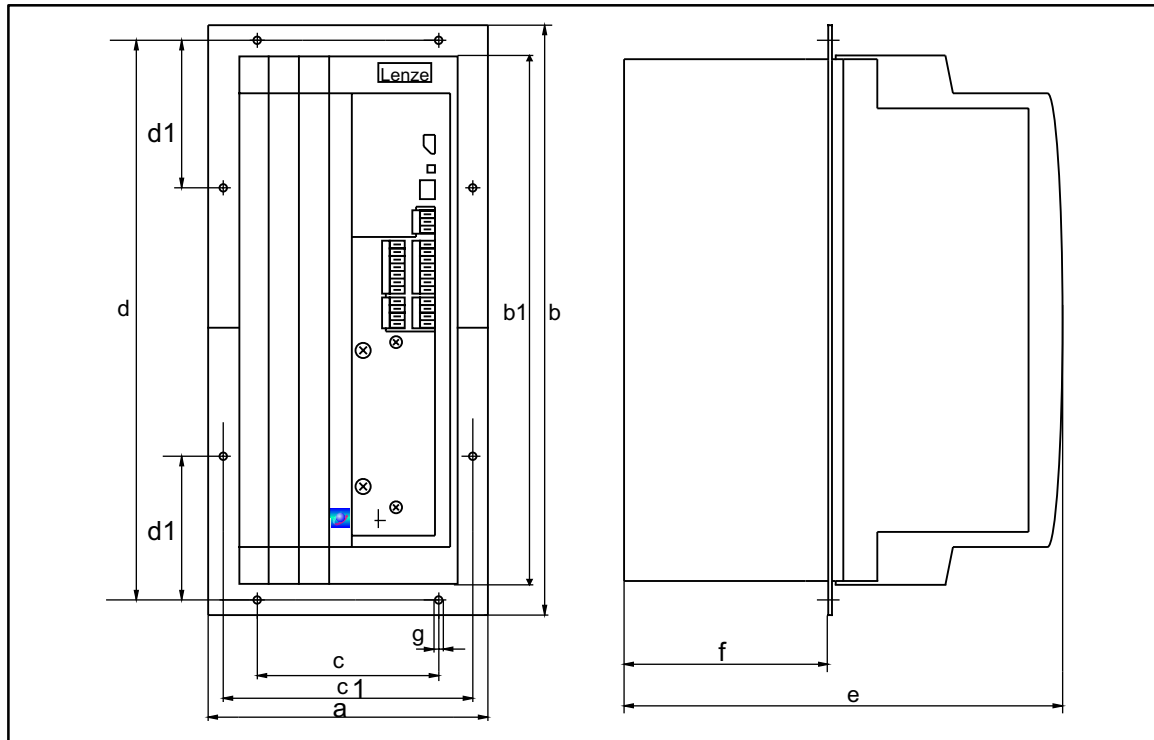
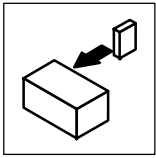

FIG 4-10 Dimensions 8241 - 8246: Assembly with thermally separated power stage

- 3) With attachable fieldbus or I/O module:
Observe assembly depth and assembly space required for connection cables

[mm]	a	b	b1	c	c1	d	d1	e ³⁾	f	g
8241 / 8242	112.5	385.5	350	60	95.5	365.5	105.5	250	92	6.5
8243 / 8244	131.5	385.5	350	79	114.5	365.5	105.5	250	92	6.5
8245 / 8246	135	385.5	350	117	137.5	365.5	105.5	250	92	6.5

Assembly cut-out [mm]	Height	Width
8241 / 8242	350 ±3	82 ±3
8243 / 8244	350 ±3	101 ±3
8245 / 8246	350 ±3	139 ±3



Installation

4.1.5 Assembly of the variant 82XX-V003 "cold plate"

4.1.5.1 General

Fields of application

- Application of coolers without separately driven fan:
 - If e.g. the cooling air is so contaminated that it is not possible to use separately driven fans. The performance as well as the service life of the fan would be reduced.
- High enclosure with thermal separation:
 - If thermal separation is required because of the heat generation in the control cabinet and if the enclosure class of the cooling unit must be higher than IP41.
- Application of controllers directly in the machine with reduced assembly depth:
 - Machine components adopt the cooling function.
- The drive concept provides common cooling units (water cooler, forced-air cooler, etc.) for all controllers.
- Because of technical reasons, the convection cooling is not suitable for continuous powers > 22 kW. Here, forced cooling (e.g. water cooling) is required.

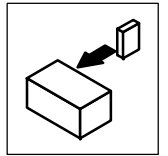

4.1.5.2 Demands on the cooler

Coolers, which can be operated with different coolants (air, water, oil, etc.), can dissipate the power loss of the controller.

In addition to the features required by the user, the following features are important for safe operation:

- Good thermal connection with the cooler
 - The contact surface between cooler and controller must be at least as large as the cold plate of the controller.
 - Smooth contact surface: approx. 0.05 mm
 - Connect cooler and cold plate by means of the provided screws.
 - For further information see chapter 4.1.5.4 ff.
- Observe the thermal resistance $R_{\text{thmin heat sink}}$ (transition cooler - coolant) according to the table. The values are valid for
 - the operation of controllers under rated conditions (see chapter 3.4),
 - a max. temperature of the cold plate of 75 °C, measuring point: see FIG 4-11, FIG 4-13, FIG 4-14.

Controller / brake units	Cooling path	
	Power to be dissipated $P_{\text{loss ctrl}}$ [W]	$R_{\text{thmin heat sink}}$ [K/W]
8215-V003	135	0.25
8216-V003	180	0.19
8217-V003	250	0.14
8218-V003	360	0.10
8221-V003	410	0.085
8222-V003	610	0.057
8241-V003	24	1.45
8242-V003	42	0.85
8243-V003	61	0.57
8244-V003	105	0.33
8245-V003	180	0.19
8246-V003	360	0.10
9351-V003	100	0.3
9352-V003	63	0.3

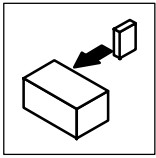

Installation

4.1.5.3 Thermal performance of the system

The thermal conditions of a system are influenced by several factors. Take the following into account for the selection of a control cabinet/system:

Ambient temperature of the controller

The rated data and the corresponding derating factors for higher temperatures are still valid for the ambient temperature of the controller.

Heat generation inside control cabinets

In addition to the unit losses, which are to be dissipated via the external heat sink, further losses must be taken into account:

- Losses inside the controller
 - These losses are generated by the electronics supply, fans, DC-bus capacitors, etc.
- Losses of the mains and motor components:
 - You find detailed information about the losses of these components in the corresponding technical data (Part 1) of the catalogs.
- Heat radiation from the external cooler into the unit:
 - This portion of the thermal energy depends, among others, on the type of cooling unit and assembly.
 - 821X-V003:
Lenze convection coolers dissipate approx. 65 % of the total power loss of the controller via the cooler, approx. 35 % must be dissipated via the control-cabinet cooling.
 - 822X-V003/824X-V003:
No details at present.

Thermal distribution to common cooling units/in the control cabinet

If several components (controller, brake units, etc.) are mounted onto a common cooler, it must be ensured that the cold plate temperature at the controller does not exceed 75 °C.

Measures:

- 821X-V003 with Lenze convection coolers
 - Min. free space required for the convection coolers:
200 mm left and right / 500 mm top and bottom.
 - Do not install one controller on top of the other.
 - If necessary, use integral fans to avoid heat concentration inside the control cabinet.
- 82XX-V003 with other coolers:
 - No details at present, empirical testing required.

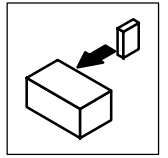

4.1.5.4 Assembly preparations

- Apply the heat-conducting paste before you bolt the cooler onto the cold plate of the controller to reduce the heat-transfer resistance to a minimum.
- The heat-conducting paste, which you will find in the accessory kit, will be enough for an area of approx. 1000 cm².

Application of heat-conducting paste

1. Clean the contact surfaces of the cooler and cold plate with ethanol.
2. Apply the heat-conducting paste thinly with a scraper or a brush.

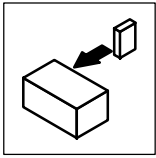

Installation

4.1.5.5 Assembly of 821X-C-V003



Note!

With 821X-C-V003, the cooler is screwed to the back of the controller cold plate. Provide enough free space for the dismantling of the controller.

Control-cabinet assembly of Lenze convection coolers

The fixing screws are included in the delivery package of the convection cooler.

1. Use the 8 fixing screws M5 x 20 to screw the convection cooler onto the cold plate.
 - For other screws observe the insertion depth t into the cold plate:
 $8 \text{ mm} \leq t \leq 10 \text{ mm}$
 - Tightening torque: 3.4 Nm.
2. Push the gasket over the front onto the convection cooler.
3. Push the controller from behind through the cut-out at the back of the control cabinet.
4. Screw the fixing screws 8 x M6 x 12 from inside the control cabinet through the back and the gasket in the tapped holes of the heat sink.
 - Tighten screws crosswise.
 - Tightening torque: 5.4 Nm.

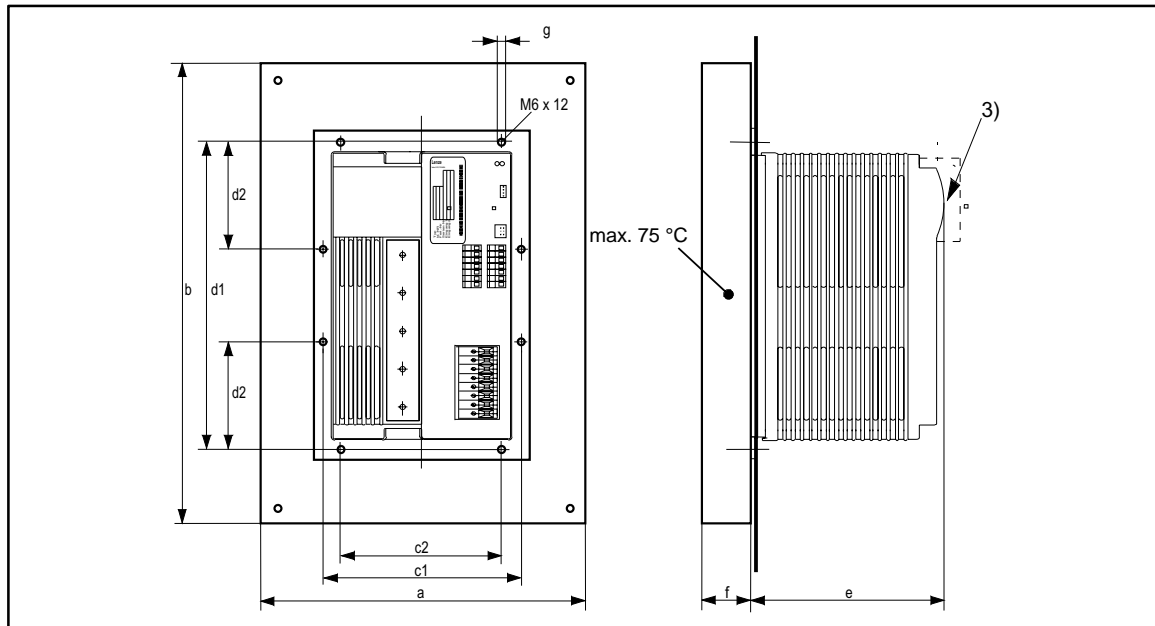
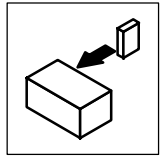
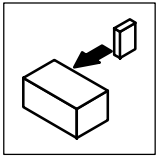

FIG 4-11 Dimensions 821X-V003: Control-cabinet assembly of Lenze convection coolers

- 3) With attachable fieldbus or I/O module:
Observe assembly depth and assembly space required for connection cables

[mm]	a	b	c1	c2	d1	d2	e ³⁾	f	g
8215-V003	300	400	145	100	263	80.5	138	83	6.5
8216-V003	300	500	145	100	263	80.5	138	83	6.5
8217-V003	300	600	145	100	263	80.5	138	83	6.5
8218-V003	300	750	145	100	263	80.5	138	83	6.5

Assembly cut-out [mm]	Height	Width
	250 ±5	132 ±5



Installation

Wall mounting of Lenze convection coolers

1. Use the 8 fixing screws M5 x 20 to screw the convection cooler onto the cold plate.
 - The fixing screws are included in the delivery package of the convection cooler.
 - For other screws observe the insertion depth t in the cold plate:
 $8 \text{ mm} \leq t \leq 10 \text{ mm}$
 - Tightening torque: 3.4 Nm.
2. Fix the unit at the wall by screwing the 4 screws (max. diameter 8 mm) through the bores provided.

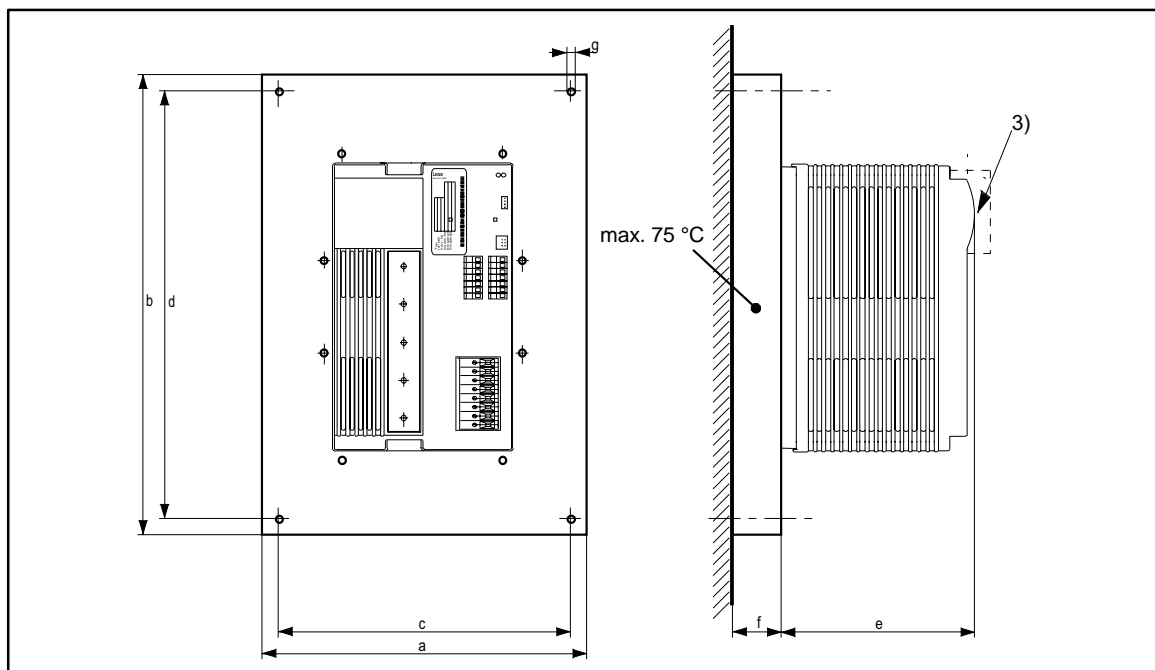
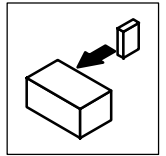

FIG 4-12 Dimensions 821X-V003: Wall mounting of Lenze convection coolers

- 3) With of attachable fieldbus or I/O modules:
 Observe the assembly depth and the space required for connection cables.

[mm]	a	b	c	d	e ³⁾	f	g
8215-V003	300	400	230	320	138	83	9
8216-V003	300	500	230	320	138	83	9
8217-V003	300	600	230	320	138	83	9
8218-V003	300	750	230	320	138	83	9



4.1.5.6 Assembly of 822X-C-V003

- Fix the controller to the heat sink using the fixing screws M5 x 25.
- Tightening torque: 3.4 Nm.

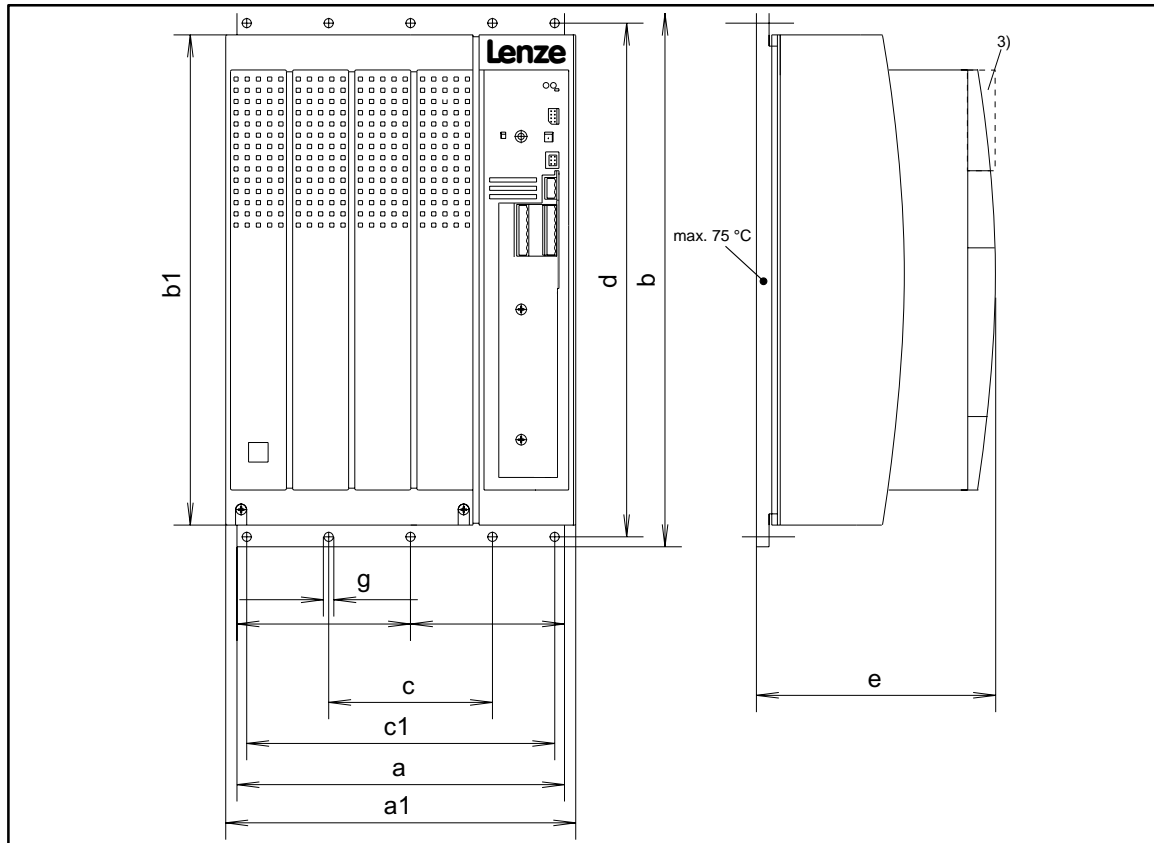
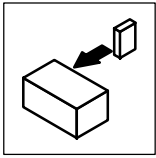

FIG 4-13 Dimensions 822X-C-V003: Control-cabinet assembly

- 3) With attachable fieldbus or I/O module:
Observe assembly depth and assembly space required for connection cables

[mm]	a	a1	b	b1	c	c1	d	e ³⁾	g
8221-V003	234	250	381	350	110	220	367	171	6.5
8222-V003									



Installation

4.1.5.7 Assembly of 824X-C-V003

- Fix the controller to the heat sink using the fixing brackets and the fixing screws M5x20.
- Tightening torque: 3.4 Nm.

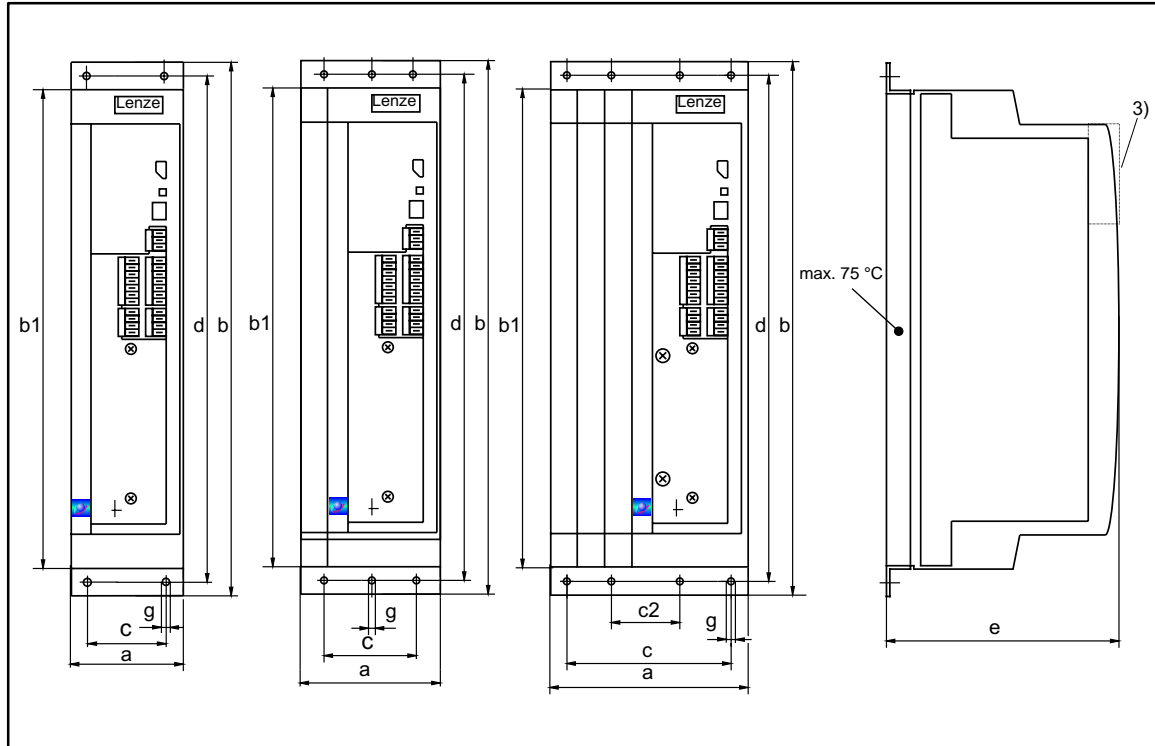
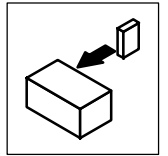

FIG 4-14 Dimensions 824X-C-V003: Control-cabinet assembly

³⁾ With attachable fieldbus or I/O module:
Observe assembly depth and assembly space required for connection cables

[mm]	a	b	b1	c	c2	d	e ³⁾	g
8241-V003 8242-V003	78	381	350	48	-	367	168	6.5
8243-V003 8244-V003	97	381	350	67	-	367	168	6.5
8245-V003 8246-V003	135	381	350	105	38	367	168	6.5



4.1.6 Assembly with mains filter



Note!

More information about dimensions, installation and selection of the appropriate mains filter can be obtained from the catalog Global Drive 8200 Frequency Inverters.

Standard assembly

1. Screw the fixing brackets to the housing of the controller and the mains filter.
2. Connect the ready-to-use output cables (unit/load) of the filter to the mains input of the controller (L1, L2, L3, PE).
3. Use all fixing brackets to mount the unit to the assembly wall.

Assembly with thermally separated power stage

1. For assembly preparations, see chapter 4.1.4.
2. Dismantle the housing of the mains filter.
3. Mount the controller into the assembly cut-out.
4. Connect the ready-to-use output cables of the filter (unit/load) to the mains input of the controller (L1, L2, L3, PE).

Assembly of the variant "Cold plate"

1. For assembly preparations, see chapter 4.1.5.
2. Dismantle the housing of the mains filter.
3. Mount the controller into the assembly cut-out.
4. Connect the ready-to-use output cables of the filter (unit/load) to the mains input of the controller (L1, L2, L3, PE).

Assembly, if the assembly space is not deep enough

1. Mount the mains filter next to the controller.
2. Refer to the dimensions for assembly with thermally separated power stage.

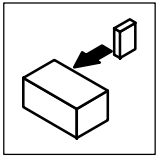

Installation

4.1.7 Assembly of the analog plug-in module 8279IB



Note!

Only controllers of the series 8210, 8220 and 8240 HVAC (V020) can be equipped with the analog plug-in module 8279IB.

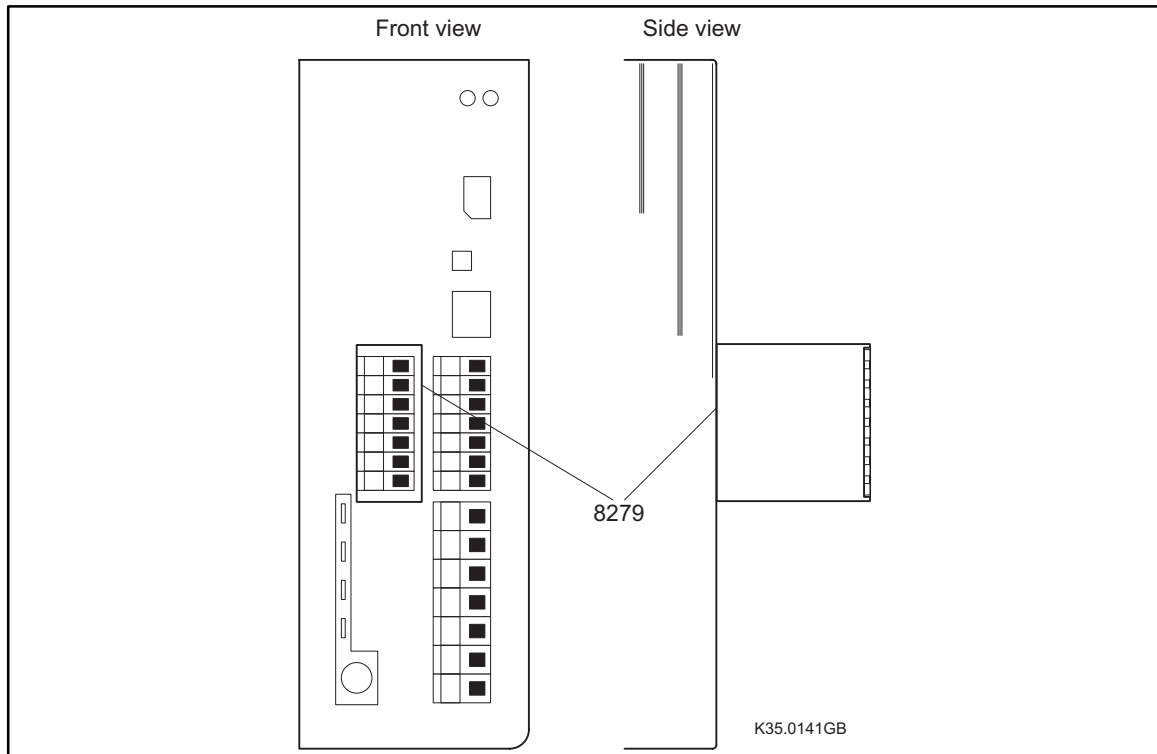

FIG 4-15 Analog plug-in module directly mounted onto the controller

Assembly

- The analog plug-in module is plugged onto the right terminal strip (terminals 20 ... 39).
- The assembly depth of the controller is thus increased by 40 mm.

Step	What to do
1.	If mounted, remove the socket connector mounted to terminals 20 ... 39.
2.	Connect the plug-in module to the terminals 20 ... 39.
3.	Plug the socket connector in the terminals strip of the analog plug-in module (the plug-in module serves as intermediate adapter).
4.	Connect the analog input to the terminals E1 and 39 of the socket connector.



Note!

Because of the mechanical instability, the installation of an analog plug-in module **and** a PTC input module should be avoided.

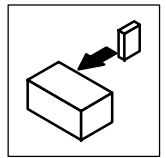

4.2 Electrical installation



For information on the installation according to EMC, see chapter 4.3.

4.2.1 Operator's safety



Danger!

All power terminals remain live up to 3 minutes after mains disconnection.

Labelling of the r.c.c.b.	Meaning
	AC-sensitive residual-current circuit breaker (RCCB, type AC)
	Pulse-current sensitive residual-current circuit breaker (RCCB, type A)
	All-current sensitive residual-current circuit breaker (RCCB, type B)

Definition

In the following text "RCCB" is used for "residual-current circuit breaker".

Protection of persons and animals

DIN VDE 0100 with residual-current operated protective devices (RCCB):

- The controllers are internally equipped with a mains rectifier. In the event of a short circuit to frame a smooth DC fault current can block the activation of the AC sensitive or pulse-current sensitive r.c.c.b. and thus eliminate the protective function for all units connected to this r.c.c.b. We therefore recommend:
 - "Pulse-current sensitive r.c.c.b." in systems with 820X controllers (L1/N).
 - "All-current sensitive r.c.c.b." in systems with 821X/822X/824X controllers (L1/L2/L3).

Rated fault current

Please observe the rated fault current for the selection of the r.c.c.b.

The r.c.c.b. may be activated unintentionally by

- capacitive leakage currents between the cable screens (especially with long screened motor cables),
- simultaneous connection of several controllers to the mains,
- using RFI filters.

Installation

The r.c.c.b. must only be installed between the supplying mains and the controller.

Note about the use of all-current sensitive r.c.c.b.

- All-current sensitive r.c.c.b. are described for the first time in the European standard EN 50178 (version October 1997). The EN 50178 has been harmonised and has been effective since October 1997. It replaces the national standard VDE 0160. The r.c.c.b. are also described in the IEC 755.
- R.c.c.b. with a rated fault current of
 - 30 mA are only suitable for systems with 820X controllers,
 - 300 mA are only suitable for systems with 821X/822X/824X controllers.

Electrical isolation / protection against contact

The control inputs and outputs of all controllers are mains isolated. Please observe the terminal description of the different controllers.

Replacement of defective fuses

Replace defective fuses with the prescribed type only when no voltage is applied.

- For single drives, the controller carries a hazardous voltage up to three minutes after mains disconnection.
- In DC-bus operation, all controllers must be inhibited and separated from the mains.

Separate controller from the mains

Make a safety disconnection between the controller and mains only via a contactor at the input side.

- Ensure that all controllers connected to the DC-bus are inhibited.

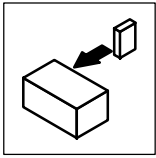

Installation

4.2.2 Protection of the controllers



Stop!

The controllers contain electrostatically sensitive components:

- Prior to assembly and service operations, the personnel must be free of electrostatic charge.
- Discharging is possible by touching the PE fixing screw or another grounded metal part in the control cabinet.

-
- The controller is protected by external fuses.
 - Unused control inputs and outputs should be covered with plugs.
 - Frequent mains switching can overload the internal switch-on current limitation. For cyclic mains switching, the controller can be switched on every three minutes as a maximum.
 - The controllers 8204, 8214, 8218, 8222 - 8227, 8224, 8246 must only be operated together with appropriate mains filter/mains choke.
 - In case of condensation, connect the controller to the mains voltage only after the visible humidity has evaporated.

4.2.3 Motor protection

- Total motor protection according to VDE:
 - By overcurrent relays or temperature monitoring
 - Required for group drives (motors connected in parallel to a controller)
 - We recommend the use of PTC thermistors or thermostats with PTC characteristic for monitoring the motor temperature. (As standard, Lenze three-phase AC motors are equipped with PTCs.)
 - The PTC or thermostat can be directly connected to the units 822X/824X. With the units 820X/821X, they are connected by means of the PTC module 8274 or the I/O module 8275 (see Accessories).
- When using motors with insulation which is not suitable for inverter operation:
 - Please contact your motor supplier. Lenze-three-phase AC motors are designed for inverter operation.
 - In general, operation with the assigned motor filters is possible.
- With the corresponding parameter setting, the controllers reach field frequencies up to 240 Hz/480 Hz:
 - When operating inappropriate motors, dangerous overspeeds may occur and result in the destruction of the drive.

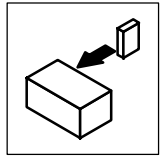

4.2.4 Mains types/mains conditions

Please observe the restrictions of each mains type!

Mains	Operation of the controllers	Notes
With grounded neutral (TT/TN mains)	No restrictions	Observe controller ratings.
	Operation of several 820X controllers connected to a mains 3AC / N / PE and symmetrical distribution to the three outer conductors excepted	<ul style="list-style-type: none"> Observe the load of the common N conductor. - For r.m.s. current see chapter 3.4 Possibly enlarge the cross-section of the N conductor.
With isolated neutral (IT mains)	Possible, if the controller is protected from an earth fault in the supplying mains <ul style="list-style-type: none"> by corresponding equipment which detects the earth fault and immediately separates the controller from the mains. 	Safe operation in the event of an earth fault in the output of the controller cannot be guaranteed.
With grounded phase	Operation is only possible with one variant.	Contact Lenze.
DC-supply via $+U_G/-U_G$	The DC voltage must be symmetrical to PE.	The controller will be destroyed when grounding $+U_G$ -conductor or $-U_G$ -conductor.

4.2.5 Combination with compensation equipment

- The controllers take up a very low fundamental reactive power from the supplying AC mains. Therefore compensation is not necessary.
- If the controllers are operated at a mains with compensation, this equipment must be used with chokes.
 - For this, contact the supplier of the compensation equipment.

4.2.6 Specification of the cables used

- The cables used must comply with the approvals required at the site (e.g. UL).
- The prescribed minimum cross-sections of PE conductors must be maintained in all cases. The cross-section of the PE conductor must be at least as large as the cross-section of the power connections.
- The screening quality of a cable is determined by
 - a good screen connection,
 - a low screen resistance.
 - Only use screens with tin-plated or nickel-plated copper braids!
 - Screens of steel braid are not suitable.
 - For the overlapping degree of the screen braid:
 - At least 70 % to 80 % with an overlapping angle of 90°.

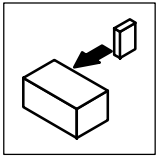

Installation

4.2.7 Power connections

4.2.7.1 Mains connection

Types 8221 to 8227	Types 8241 to 8246
<p>Correct screen connection with screened cables:</p> <ul style="list-style-type: none"> • Connect the screen with suitable clamp to the conducting control cabinet mounting plate. • To improve the screen connection: Connect screen additionally to the stud next to the power connections. 	<p>Correct screen connection with screened cables (required parts in the accessory kit):</p> <ul style="list-style-type: none"> • Screw screen plate ① on fixing bracket ②. • Fix screen using cable lugs. Do not use as a strain relief! • To improve the screen connection: Connect the screen additionally to the stud next to the power connections.

FIG 4-16 Proposal for mains connection 822X/824X

- Connect the mains cables to the screw terminals L1, L2, L3.
- Connect cables for brake unit (935X), supply module (934X) or further controllers in the DC-bus connection to the screw terminals +U_G, -U_G at the top of the controller.
- Max. permissible cable cross-sections and tightening torques:

Type	Max. permissible cable cross-sections	Terminals	
		L1, L2, L3, +U _G , -U _G	PE connection
8201 - 8214	2.5 mm ²	0.5 ... 0.6 Nm (4.4 ... 5.3 lbin)	1.7 Nm (15 lbin)
8215 - 8218	4 mm ² ¹⁾	0.5 ... 0.6 Nm (4.4 ... 5.3 lbin)	1.7 Nm (15 lbin)
8221 - 8223	25 mm ² ²⁾	4 Nm (35 lbin)	
8224 - 8225	95 mm ² ²⁾	7 Nm (62 lbin)	
8226 - 8227	120 mm ² ²⁾	12 Nm (106.2 lbin)	
8241 - 8246	4 mm ² ¹⁾	0.5 ... 0.6 Nm (4.4 ... 5.3 lbin)	3.4 Nm (30 lbin)

- ¹⁾ With pin-end connector: 6 mm²
 With wire crimp cap: 4 mm²
- ²⁾ With ring cable lug: The cross-section is only limited by the cable cut-out in the housing.

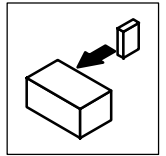

Protection	
Fuses and cable cross-sections	The specifications in chapter 3.6 are recommendations and refer to the application <ul style="list-style-type: none"> • in control cabinets and machines, • installation in the cable duct, • max. ambient temperature +40 °C, • as single drive with matching motor.
Selection of the cable cross-section	For selection take into account the voltage drop when being loaded (to DIN 18015 part 1: ≤ 3 %).
Protection of cables and controller on the AC side (L1, L2, L3)	<ul style="list-style-type: none"> • By standard commercial fuses. • Fuses in UL-conform plants must have UL approval. • The rated voltages of the fuses must be dimensioned according to the mains voltage at the site. The activation characteristic is defined by "H" or "K5".
Protection of cables and controller on the DC side (+U_G, -U_G)	<ul style="list-style-type: none"> • By means of recommended DC fuses. • The fuses/fuse holders recommended by Lenze are all UL-approved.
For DC group drives or supply via DC source	Observe notes in Part F.
Connection of a brake unit	If the unit is connected to the terminals +U _G / -U _G , the fuses and cross-sections indicated in chapter 3.6 are not valid. These unit-specific data can be obtained from the technical documentation for the brake unit.
Further information	For protection of cables and controllers, see chapter "Accessories".
Further standards	The compliance with other standards (e.g. VDE 0113, VDE 0289, etc.) remains in the responsibility of the user.

4.2.7.2 Motor connection

For EMC safety reasons we recommend the use of screened motor cables.



Note!

The screening of the motor cable is only required to comply with existing standards (e.g. VDE 0160, EN 50178).

Screen connection

- 820X: On the front FAST-ON connector.
- 8211 - 8214: On the front FAST-ON connector.
- 8215 - 8218: On the front metal surface.

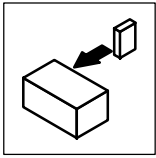

Installation

Types 8221/8222/8223

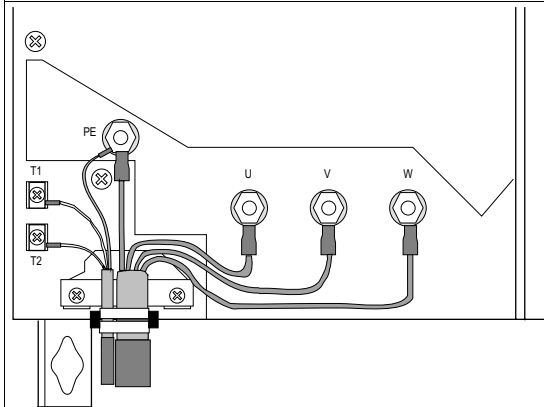

- Correct screen connection with screened cables:
- Fix the screen of the motor cable and thermal contact. Do not use as a strain relief!
 - To improve the screen connection: Connect the screen additionally to the stud PE next to the controller.

Types 8224/8225

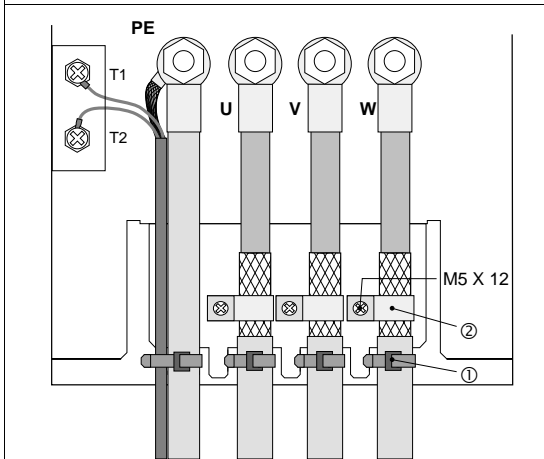

- Strain relief by using cable binders ①.
- Correct screen connection with screened cables:
 - Apply motor cable screen to the screening plate using clamp and screws M5x12 ②.
 - Connect thermal contact screen to the stud PE next to the motor connection over a large surface.

Types 8226/8227

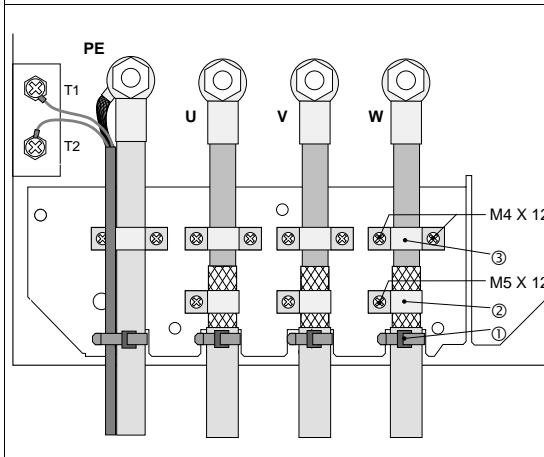

- Strain relief by using cable clamps and screws M4x12 ③.
 - An additional strain relief/fixing is possible with cable binders ①.
- Correct screen connection with screened cables:
 - Apply motor cable screen to the screening plate using clamp and screws M5x12 ②.
 - Connect thermal contact screen to the stud PE next to the motor connection over a large surface.

FIG 4-17 Proposal for motor connection with 822X

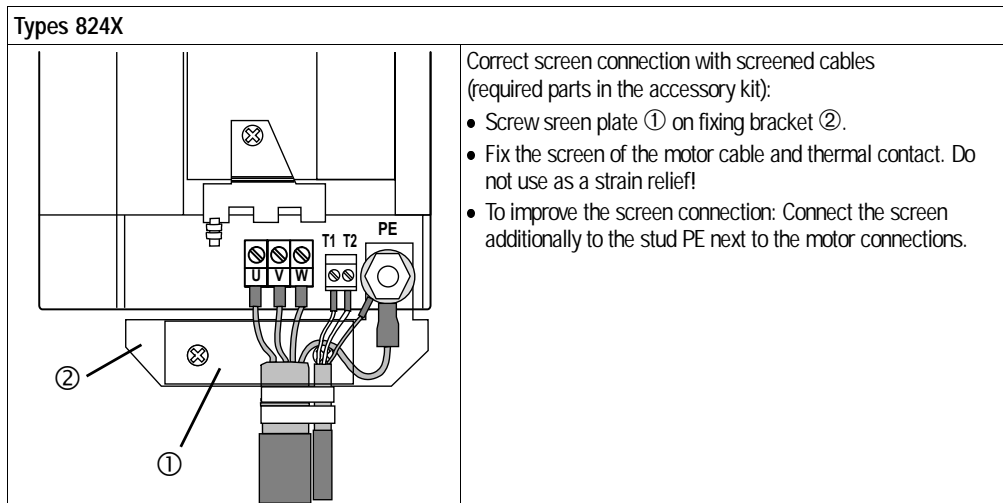
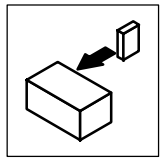

FIG 4-18 Proposal for motor connection with 824X

- Connect the motor cables to the screw terminals U, V, W.
 - Observe correct pole connection.
 - Max. permissible cable cross-sections and tightening torques

Type	Max. permissible cable cross-sections	Terminals			
		U, V, W	PE connection	Screen/strain relief	T1, T2
8201 - 8214	2.5 mm ²	0.5 ... 0.6 Nm (4.4 ... 5.3 lbin)	1.7 Nm (15 lbin)	-	-
8215 - 8218	4 mm ² 1)	0.5 ... 0.6 Nm (4.4 ... 5.3 lbin)	1.7 Nm (15 lbin)	-	-
8221 - 8223	25 mm ² 2)	4 Nm (35 lbin)		-	0.5 ... 0.6 Nm (4.4 ... 5.3 lbin)
8224 - 8225	95 mm ² 2)	7 Nm (62 lbin)		3.4 Nm (30 lbin)	
8226 - 8227	120 mm ² 2)	12 Nm (106.2 lbin)		M4: 1.7 Nm (15 lbin) M5: 3.4 Nm (30 lbin)	
8241 - 8246	4 mm ² 1)	0.5 ... 0.6 Nm (4.4 ... 5.3 lbin)	3.4 Nm (30 lbin)	-	

1) With pin-end connector:

6 mm²

With wire crimp cap:

4 mm²

2) With ring cable lug:

The cross-section is only limited by the cable cut-out in the housing.



Note!

- Switching on the motor side of the controller is permitted
 - for safety switch-off (emergency switch-off),
 - under load.

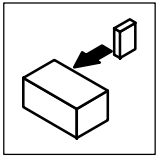

Installation

- The motor cable should be as short as possible because of the positive effect on the drive characteristic.
 - FIG 4-19 shows the relation between the motor cable length and the possibly required output filters.
 - For group drives (several motors connected to one controller) it is necessary to calculate the resulting cable length l_{res} :

$$l_{res} = \text{sum of all motor cable lengths} \cdot \sqrt{\text{No. of motor cables}}$$

- The components stated in FIG 4-19 are valid for chopper frequencies ≤ 8 kHz (C018 = -0-, -1-). When using controllers with chopper frequencies > 8 kHz, different measures may be required. Please contact Lenze.
- When using unscreened motor cables, the data indicated in FIG 4-19 are valid for the double motor cable length.
- Please contact Lenze when the absolute or resulting motor cable lengths are > 200 m.

Type	Permissible control mode C014			
8201				
8202	-0-, -1-,	-2-, -3-	-2-, -3-	-2-, -3-
8203	-2-, -3-		+ motor filter/	+ sine filter
8204				

0 15 25 50 100 200

Motor cable length (resulting), screened in m

Type	Permissible control mode C014			
8211	-2-, -3-, -4-	-2-, -3-		
8212	-2-, -3-, -4-	-2-, -3-		
8213/8214			-2-, -3- + motor filter/ motor choke	-2-, -3- + sine filter
8215/8216				
8217/8218	-2-, -3-, -4-			

0 15 25 50 100 200

Motor cable length (resulting), screened in m

Type	Additionally required output filters in the motor cable		
8221/8222		motor filter/motor choke	
8223/8224/8225	none	none	motor choke (contact Lenze)
8226/8227			
8241/8242/8243	none	motor filter/motor choke	sine filter
8244/8245/8246			

0 50 100 200

Motor-cable length (resulting), screened in m

FIG 4-19 Output filters additionally required in the motor cable

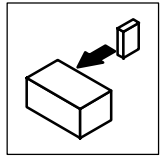

- When switching on the motor side, the switching units must be rated for DC voltages.
 - 820X: $V_{DC} \max \leq 400 \text{ V}$
 - 821X, 822X, 824X: $V_{DC} \max \leq 800 \text{ V}$
 - If you only switch when no voltage is applied, e.g. electrical latching via controller inhibit, you can also use standard AC switching units.



Note!

- When switching with controller enabled, the fault indication "OCx" (short-circuit/earth fault during operation x) can be activated.
 - When using long motor cables and controllers with low output power, leakage currents via parasitic cable capacities can activate the fault indication "OCx".
 - In such a case, motor filters or sine filters should be used.
 - Further information on long motor cables for stand-alone and group drives can be obtained from the corresponding application reports.
-

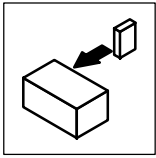

Installation

4.2.7.3 Connection of a brake unit

- When connecting a brake unit (brake module with internal brake resistor or brake chopper with external brake resistor) observe the corresponding Operating Instructions in all cases.



Stop!

- Design the circuit so that, if the temperature monitoring of the brake unit is activated,
 - the controllers are inhibited (X5/28 = LOW),
 - the mains is disconnected.
-

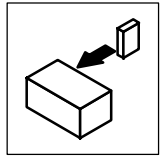

4.2.7.4 Connection plan 820X

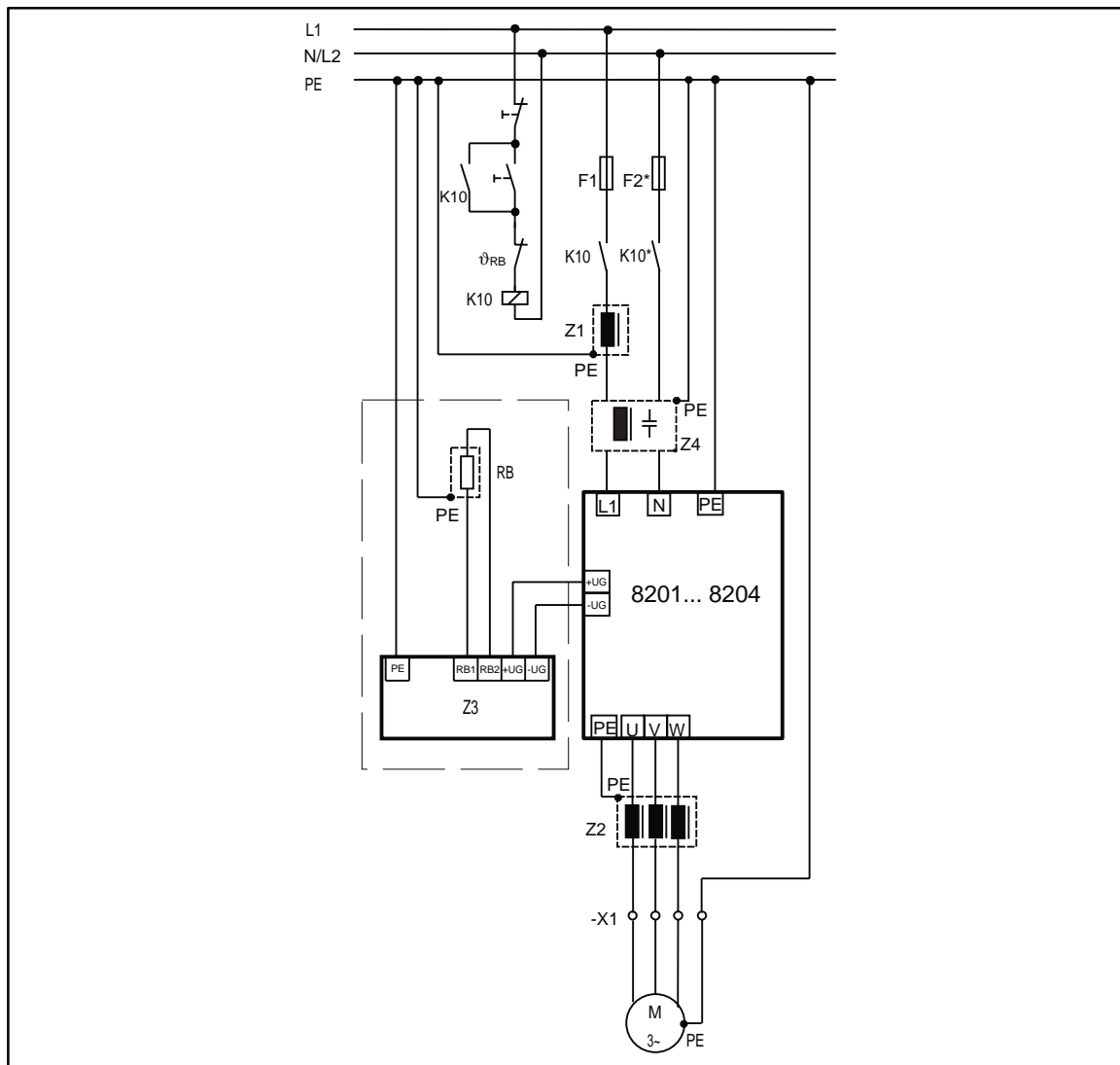
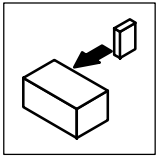

FIG 4-20 820X power connections

- F1, F2* Fuses, F2* only for supply with 2AC / PE / 190 - 260 V
- K10, K10* Mains contactor, K10* only for supply with 2AC / PE / 190 - 260 V
- Z1 Mains choke, see Accessories (not required when using mains filters)
8204 operation only with assigned mains choke/mains filter
- Z2 Motor filter/sine filter, see Accessories
- Z3 Brake chopper/brake module, see Accessories
- Z4 RFI filter/mains filter (symmetrically designed filters for L1/N (L2))
- RB Brake resistor, see Accessories
- ϑ_{RB} Temperature monitoring brake resistor
- X1 Terminal strip in control cabinet



Installation

4.2.7.5 Connection plan 821X

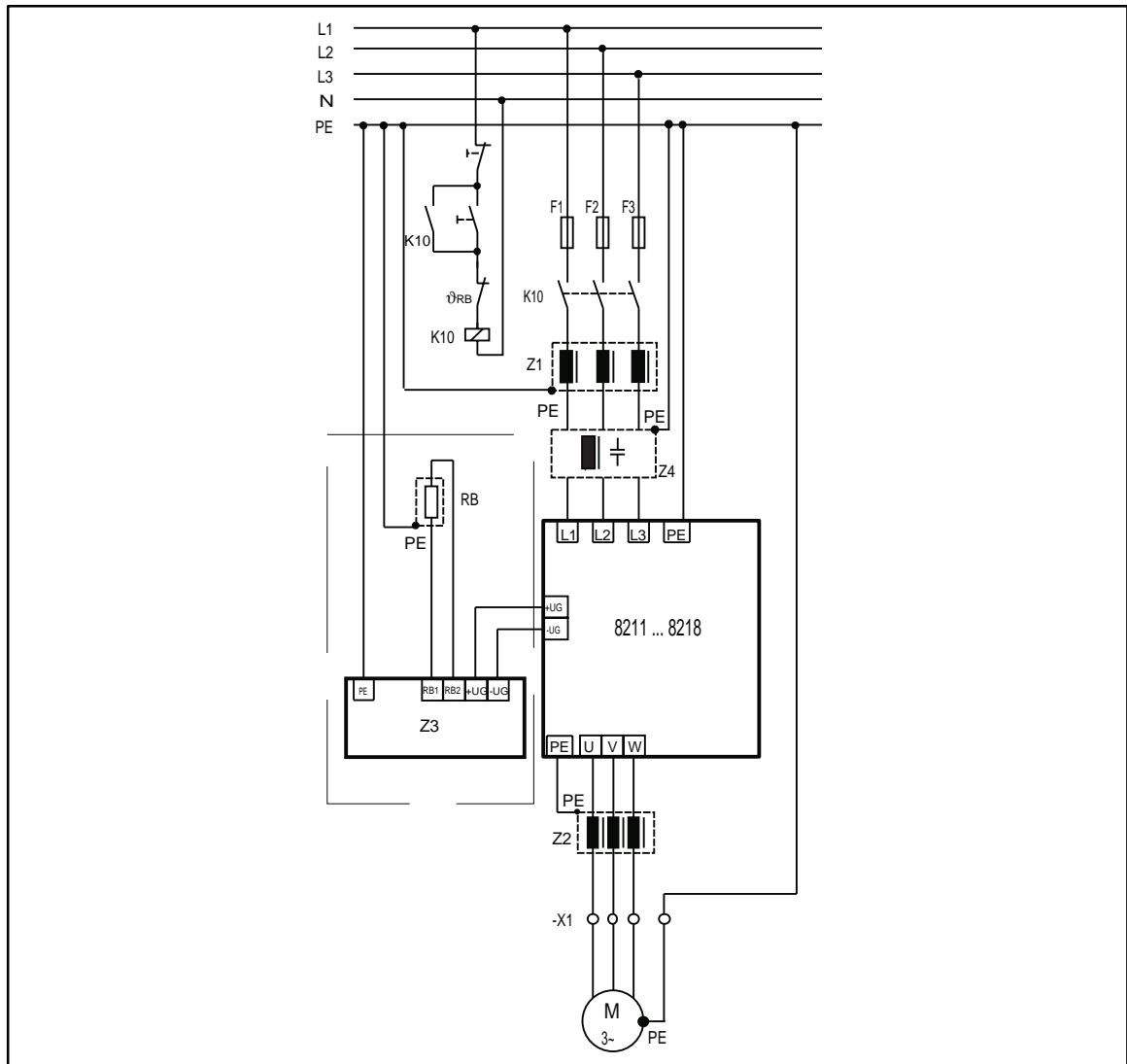
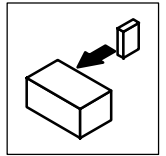

FIG 4-21 821X power connections

- | | |
|---|--|
| F1, F2, F3 | Fuses |
| K10 | Mains contactor |
| Z1 | Mains choke, see Accessories (not required when using mains filters) |
| Types 8214/8218 should only be operated with assigned mains choke/mains filter | |
| Z2 | Motor filter/sine filter, see Accessories |
| Z3 | Brake chopper/brake module, see Accessories |
| Z4 | RFI filter/mains filter |
| RB | Brake resistor, see Accessories |
| ϑ_{RB} | Temperature monitoring brake resistor |
| X1 | Terminal strip in control cabinet |



4.2.7.6 Connection plan 822X/824X

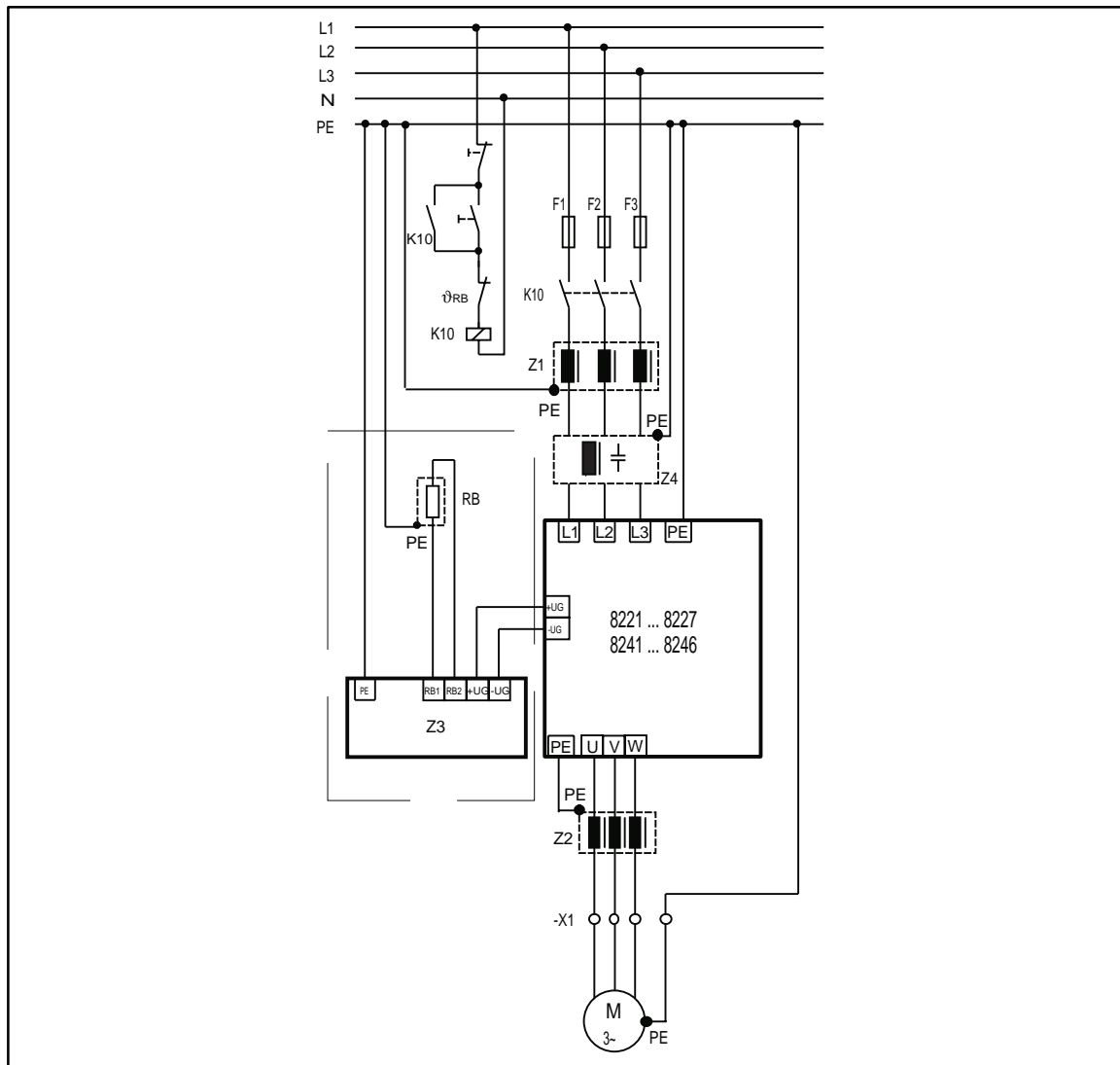
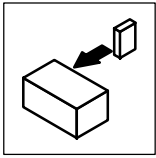

FIG 4-22 822X/824X power connections

- F1, F2, F3 Fuses
- K10 Mains contactor
- Z1 Mains choke, see Accessories (not required when using mains filters)
- Operate types 8222-8227, 8244/8246 only with assigned mains choke/mains filter**
- Z2 Motor filter/sine filter, see Accessories
- Z3 Brake chopper/brake module, see Accessories
- Z4 RFI filter/mains filter
- RB Brake resistor, see Accessories
- Θ_{RB} Temperature monitoring brake resistor
- X1 Terminal strip in control cabinet



Installation

4.2.8 Control connections

4.2.8.1 Control cables

- Connect the control cables to the screw terminals:

Max. permissible cable cross-section	Tightening torques
2.5 mm ²	0.5 ... 0.6 Nm (4.4 ... 5.3 lbin)

- We recommend the unilateral screening of all cables for analog signals to avoid signal distortion.
- Connect the screens of the control cables
 - 820X:
To the front FAST-ON connector
 - 8211 - 8214:
To the front FAST-ON connector
 - 8215 - 8218:
To the front metal surface (screw length max. 12 mm).
 - 822X, 824X
With the screen sheet to the front metal surface (screw length max. 12 mm).

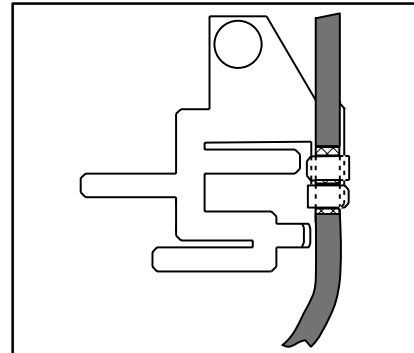

- If the control cables are interrupted (terminal strips, relays), the screens must be reconnected over the shortest possible distance.
- Connect the fixing screw of the setpoint potentiometer to PE.
- Motor-temperature monitoring (Optionally for 820X/821X, as standard for 822X/824X)
 - If possible, separate the cables from the motor cable.

4.2.8.2 Assignment of the control terminals

Protection against contact - 820X/821X

- The control terminals have a basic isolation (single insulating distance).
- If protection against contact is required,
 - a double insulating distance must be provided,
 - the components to be connected must have a second insulating distance.

Protection against contact - 822X/824X

- The control terminals are separated (VDE 0160, EN50178), the protection against contact is ensured without additional measures.

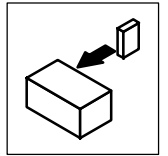

Protection against polarity reversal

- The protection against polarity reversal prevents the wrong connection of the internal control inputs. It is however possible to overcome the protection against polarity reversal by applying great force.

Overview

820X/821X

822X/824X

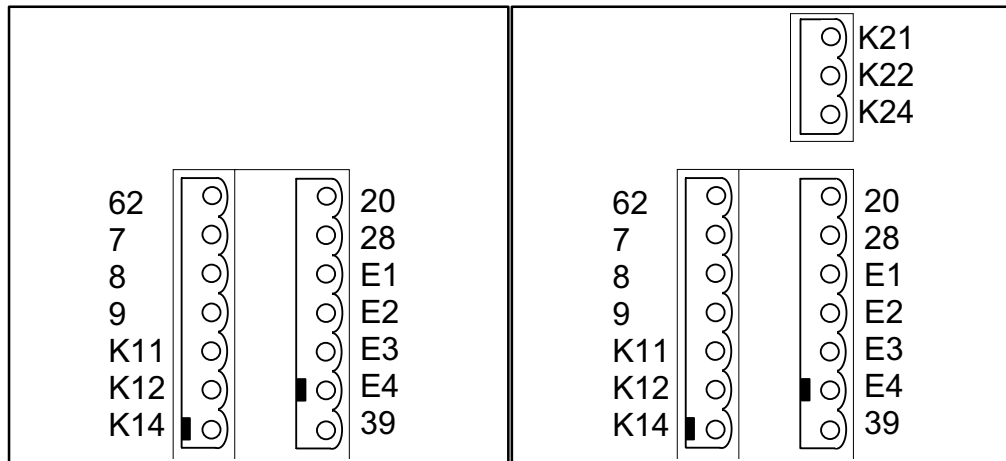
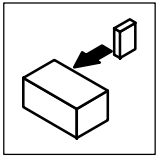
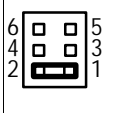

FIG 4-23 Layout of the control terminals



Installation

	Terminal	Use (Factory setting is printed in bold)	Level	Data	
Analog inputs	7	GND 1			
	8	Setpoint input, reference: Terminal 7 (0 to 10 V)	 Jumper	5 - 6 0 to 20 mA 5 - 6 4 to 20 mA 3 - 4 0 to 5 V 1 - 2 0 to 10 V	Resolution: 820X: 9 bit, 821X/822X/824X: 10 bit Linearity fault: $\pm 0.5\%$ Temperature fault: 0.3% (0 ... +40 °C) Input resistance Voltage signal: > 100 k Ω Current signal: 250 Ω
	9	Supply for setpoint potentiometer	5.2 V / 6 mA		
Analog output	62	Analog output, reference: Terminal 7 (Field frequency)	0 ... 6 V / 2 mA 0 ... 10 V / 2 mA ¹⁾	Resolution: 820X: 8 bit 821X/822X/824X: 10 bit	
Digital inputs	20	Voltage supply for digital inputs 820X: 12 V / 20 mA 821X/822X/824X: 15 V / 20 mA			
	28	Controller enable	HIGH	HIGH: 12 V ... 30 V LOW: 0 V ... 3 V	
	E4	CW/CCW rotation (CW/CCW)	CW: LOW CCW: HIGH		
	E3	DC-injection brake	HIGH		
	E2	JOG frequencies	Binary code		
	E1	20 Hz, 30 Hz, 40 Hz			
39	GND 2 (reference for external voltages)				
Monitoring	T1	Motor-temperature monitoring (PTC thermistor/thermal contact)		If not used: Set parameter C119 = -0-!	
	T2	Motor-temperature monitoring (PTC thermistor/thermal contact)			

	Terminal	Use (Factory setting is printed in bold)	Relay position (switched)	Data
Relay output K1	K 11	Relay output normally-closed contact (TRIP)	Opened	24 V AC / 3.0 A or 60 V DC / 0.5 A
	K 22	Relay mid-position contact		
	K 24	Relay output normally-open contact (TRIP)	Closed	
Relay output K2	K 21	Relay output normally-closed contact (Ready for operation)	Opened	250 V AC / 3.0 A or 60 V DC / 0.5 A
	K 22	Relay mid-position contact		
	K 24	Relay output normally-open contact (Ready for operation)	Closed	

¹⁾ With 821X/822X/824X HVAC (V020)

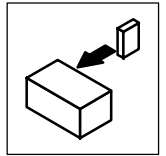

4.2.8.3 Connection diagrams

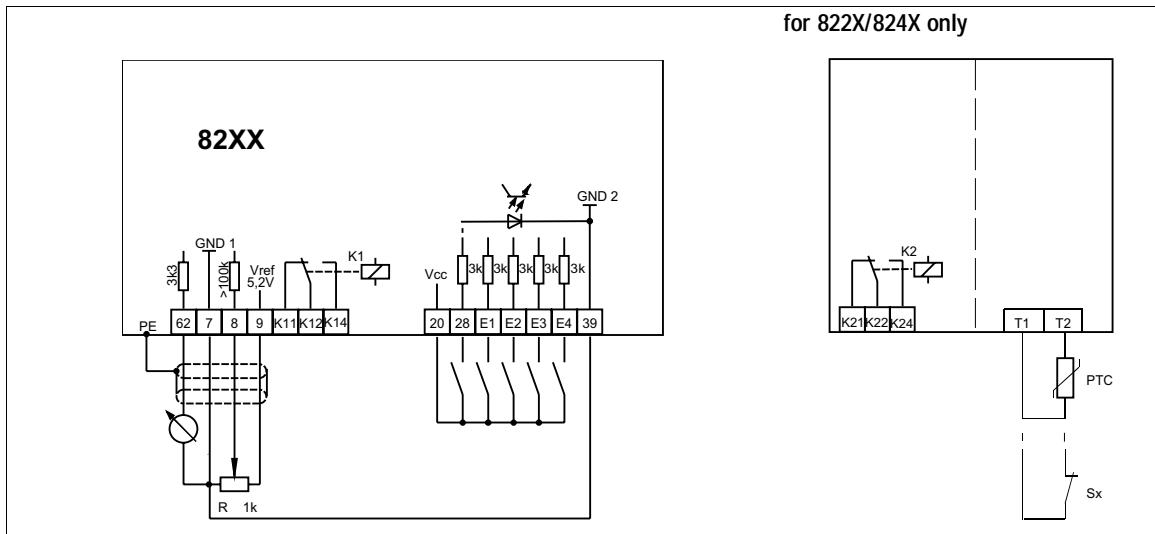

FIG 4-24 Control connections: Supply with internal control voltage

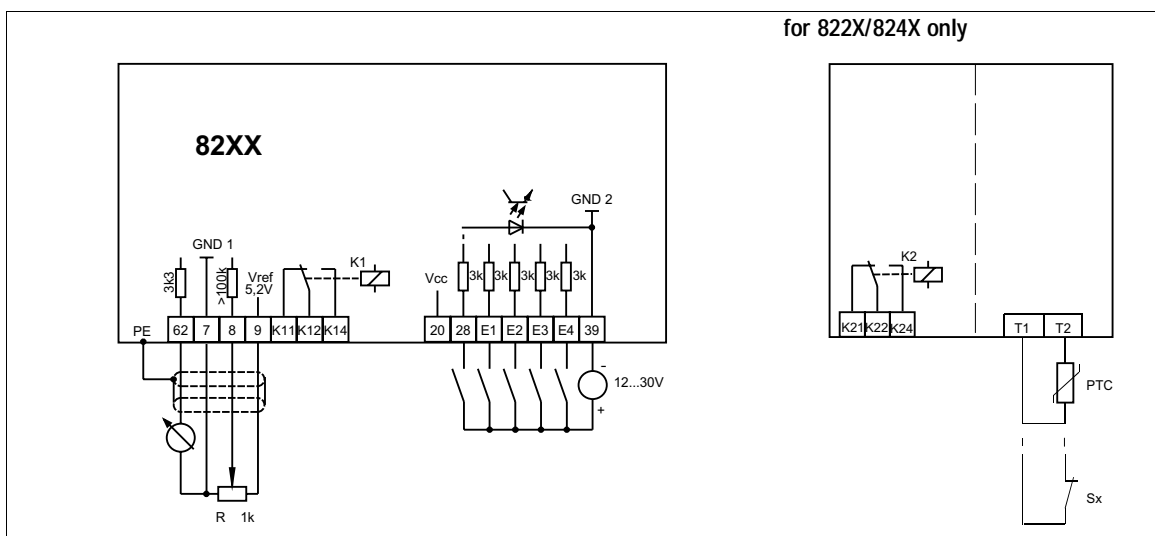
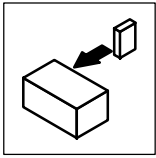

FIG 4-25 Control connections: External voltage supply (+12 V ... +30 V)

- GND1 Reference for internal voltages
- GND2 Reference for external voltages
- GND1 and GND2 have a potential isolation inside the unit.

The connections for the motor temperature monitoring (T1, T2) are next to the connection terminals U, V, W.



Installation

4.2.8.4 Connection diagrams: Analog plug-in module



Note!

Only controllers of the series 8210, 8220 and 8240 HVAC can be equipped with an analog plug-in module.

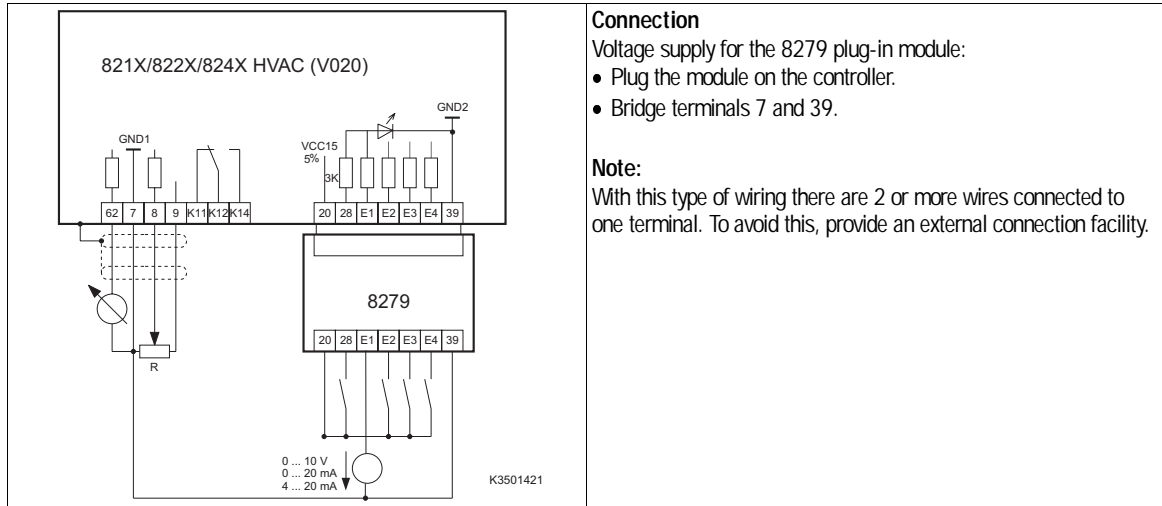

Connection

Voltage supply for the 8279 plug-in module:

- Plug the module on the controller.
- Bridge terminals 7 and 39.

Note:

With this type of wiring there are 2 or more wires connected to one terminal. To avoid this, provide an external connection facility.

FIG 4-26 Control connections: Supply with internal control voltage

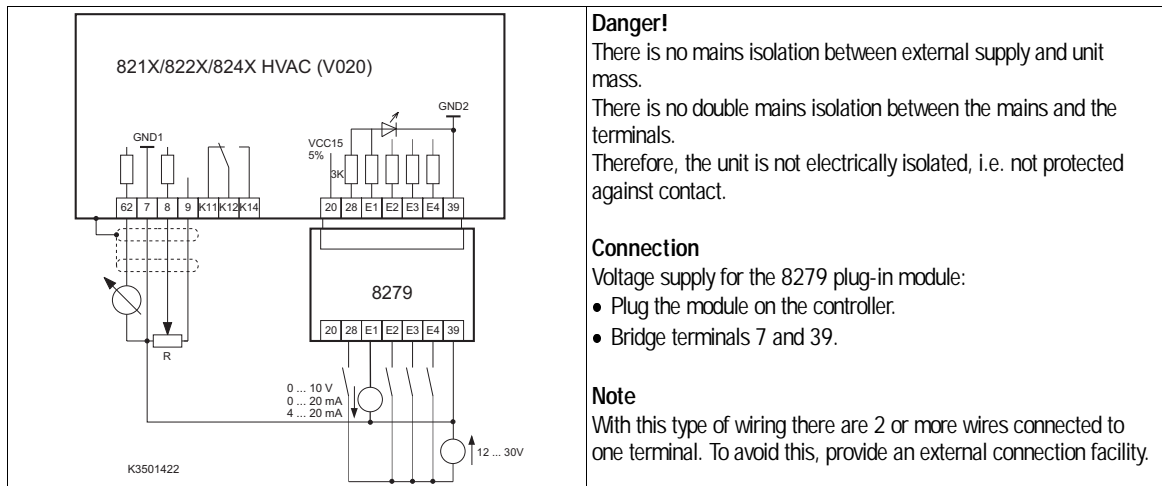

Danger!

There is no mains isolation between external supply and unit mass.

There is no double mains isolation between the mains and the terminals.

Therefore, the unit is not electrically isolated, i.e. not protected against contact.

Connection

Voltage supply for the 8279 plug-in module:

- Plug the module on the controller.
- Bridge terminals 7 and 39.

Note

With this type of wiring there are 2 or more wires connected to one terminal. To avoid this, provide an external connection facility.

FIG 4-27 Control connections: Supply with external control voltage (+12 V ... +30 V)

GND1 Reference for internal voltages

GND2 Reference for external voltages

GND1 and GND2 have a potential isolation inside the unit.

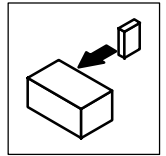

4.3 Installation of a CE-typical drive system

<p>General notes</p>	<ul style="list-style-type: none"> • The electromagnetic compatibility of a machine depends on the type of installation and care taken. Please observe: <ul style="list-style-type: none"> - Assembly - Filters - Screening - Grounding • For diverging installations, the conformity to the CE EMC Directive requires a check of the machine or system regarding the EMC limit values. This is for instance valid for <ul style="list-style-type: none"> - the use of unshielded cables, - the use of group RFI filters instead of assigned RFI filters, - the operation without mains filter. • The compliance of the machine application with the EMC Directive is in the responsibility of the user. <ul style="list-style-type: none"> - If you observe the following measures, you can assume that the machine will operate without any EMC problems caused by the drive system, and that compliance with the EMC Directive and the EMC law is achieved. - If devices which do not comply with the CE requirement concerning noise immunity EN 50082-2 are operated close to the controller, these devices may be disturbed electromagnetically by the controllers.
<p>Assembly</p>	<ul style="list-style-type: none"> • Connect controller, mains choke, and mains filter to the grounded mounting plate with a wire of large a cross-section as possible: <ul style="list-style-type: none"> - Mounting plates with conductive surfaces (zinc-coated, stainless steel) allow permanent contact. - Painted plates are not suitable for the installation in accordance with the EMC. • If you use several mounting plates: <ul style="list-style-type: none"> - Connect as much surface as possible of the mounting plates (e.g. with copper bands). • Ensure the separation of motor cable and signal or mains cable. • Do not use the same terminal strip for mains input and motor output. • Cable guides as close as possible to the reference potential. Unguided cables have the same effect as aerials.
<p>Filters</p>	<ul style="list-style-type: none"> • Use mains filters or RFI filters and mains chokes which are assigned to the controller: <ul style="list-style-type: none"> - RFI filters reduce impermissible high-frequency interference to a permissible value. - Mains chokes reduce low-frequency interferences which depend on the motor cable and its length. - Mains filters combine the functions of mains choke and RFI filter.

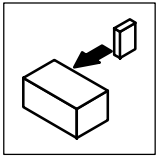

Installation

Screening	<ul style="list-style-type: none"> • Connect the screen of the motor cable to the controller <ul style="list-style-type: none"> - to the screen connection of the controller, - additionally to the mounting plate with a surface as large as possible. - Recommendation: For the connection, use ground clamps on bare metal mounting surfaces. • If contactors, motor-protecting switches or terminals are located in the motor cable: <ul style="list-style-type: none"> - Connect the screens of the connected cables also to the mounting plate, with a surface as large as possible. • Connect the screen in the motor terminal box or on the motor housing to PE: <ul style="list-style-type: none"> - Metal glands at the motor terminal box ensure a connection of the screen and the motor housing. • If the mains cable between mains filter and controller is longer than 300 mm: <ul style="list-style-type: none"> - Screen mains cables. - Connect the screen of the mains cable directly to the inverter and to the mains filter and connect it to the mounting plate with as large a surface as possible. • Use of a brake chopper: <ul style="list-style-type: none"> - Connect the screen of the brake resistor cable directly to the mounting plate, at the brake chopper and the brake resistor with as large a surface as possible. - Connect the screen of the cable between controller and brake chopper directly to the mounting plate, at the inverter and the brake chopper with a surface as large as possible. • Screen the control cables: <ul style="list-style-type: none"> - Connect both screen ends of the digital control cables. - Connect one screen end of the analog control cables. - Always connect the screens to the screen connection at the controller over the shortest possible distance. • Application of the controllers 821X/822X/824X in residential areas: <ul style="list-style-type: none"> - Use an additional screen damping ≥ 10 dB to limit the radio interference. This is usually achieved by installation in enclosed and grounded control cabinets made of metal.
Grounding	<ul style="list-style-type: none"> • Ground all metallically conductive components (controller, mains filter, motor filter, mains choke) using suitable cables connected to a central point (PE bar). • Maintain the minimum cross-sections prescribed in the safety regulations: <ul style="list-style-type: none"> - For EMC not the cable cross-section but the surface and the contact with a cross-section as large as possible, are important.

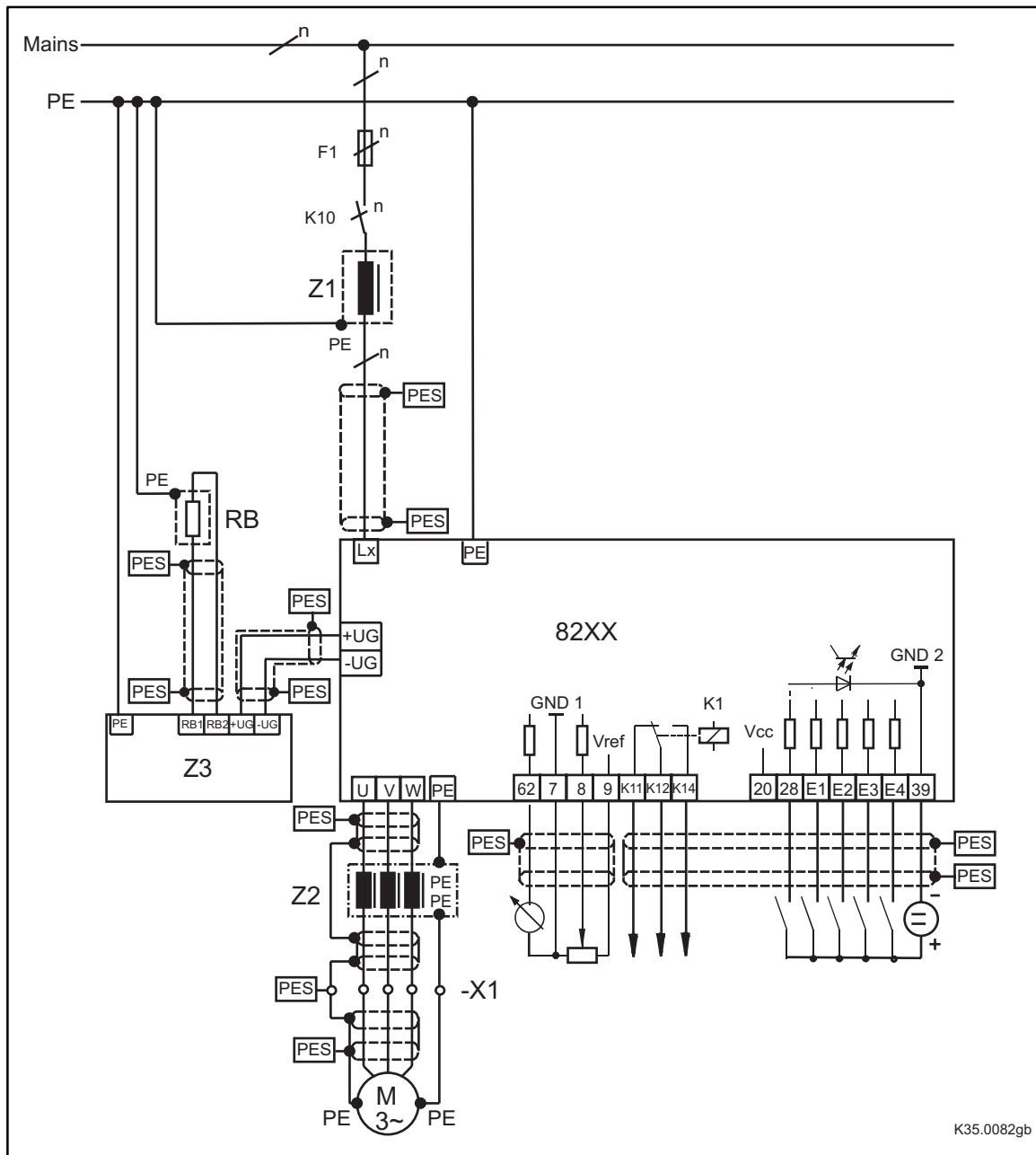
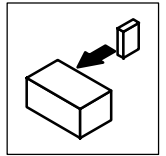
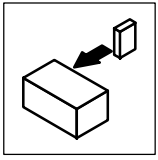

FIG 4-28 Example for an installation in accordance with the EMC regulations:

- | | |
|-----|---|
| F1 | Fuse |
| K10 | Mains contactor |
| Z1 | Mains filter "A" or "B", see Accessories |
| Z2 | Motor filter/sine filter, see Accessories |
| Z3 | Brake module/brake chopper, see Accessories |
| -X1 | Terminal strip in control cabinet |
| RB | Brake resistor |
| PES | HF screen because auf PE connection with a surface as large as possible (see "Screening" in this chapter) |
| n | Number of phases |



Installation

Manual

Part C

Commissioning

During operation

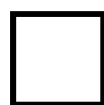

Global Drive

Frequency inverters 8200

This Manual is valid for 82XX controllers as of version:

	33.820X-	E-	1x.	1x		(8201 - 8204)
	33.8202-	E-	1x.	1x	-V002	Reduced assembly depth (8202)
	33.821X-	E-	0x.	1x		(8211 - 8218)
	33.821X-	E-	1x.	2x		(8211 - 8218)
	33.821X-	C-	1x.	2x	-V003	Cold plate (8215 - 8218)
	33.821X-	E-	3a.	3x	-V020	HVAC (8211 - 8218)
	33.822X-	E-	0x.	0x		(8221 - 8227)
	33.822X-	C-	1x.	2x	-V003	Cold plate (8221 - 8222)
	33.822X-	E-	3a.	3x	-V020	HVAC (8221 - 8227)
	33.824X-	E-	1x.	1x		(8241 - 8246)
	33.824X-	C-	1x.	1x	-V003	Cold plate (8241 - 8246)
	33.824X-	E-	3a.	3x	-V020	HVAC (8241 - 8246)
Type						
Design: B = Module C = Cold plate E = Built-in unit IP20						
Hardware version and index						
Software version and index						
Variant						
Explanation						

		revised	
Edition of:	01/1999		

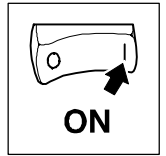

5 Commissioning

820X

The controllers are factory-set to drive a corresponding four-pole standard motor with 230/400 V, 50 Hz. Further settings are not necessary.

821X/822X/824X

The controllers are factory-set to drive the following matching four-pole asynchronous standard motors without any further settings:

- 230/400 V, 50 Hz
- 265/460 V, 60 Hz
- 280/480 V, 60 Hz

Only a few settings via the 8201BB operating module or a fieldbus module are necessary to adapt your drive to your application. The required steps are summarised in chapter 5.3 and chapter 5.4.

Further information about the optimisation of the controller can be obtained from part D, "Configuration".

5.1 Before switching on

Prior to initial switch-on of the controller, check the wiring for completeness, short-circuit, and earth fault:

- Power connection:
 - Via terminals L1/N - 820X
 - Via L1, L2 and L3 - 821X
 - Via L1, L2 and L3 - 822X/824X
 - Alternatively via terminals +U_G, -U_G (DC-group drive)
- Control terminals:
 - Reference potential for the control terminals is terminal 39.
 - Controller enable: Terminal 28
 - Selection of direction of rotation: Terminal E3 or E4
 - External setpoint selection: Terminals 7, 8
 - Check jumper position! Factory setting: 0 - 10 V (see chapter 4.2.8.2).
 - During operation with an internal voltage supply via terminal 20, bridge the terminals 7 and 39.
- In case of condensation, connect the controller to the mains voltage only after the visible humidity has evaporated.
- The plug-in power terminals of the 820X controller must only be connected or disconnected when no voltage is applied.

Keep to the switch-on sequence!

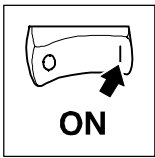

Commissioning

5.2 Short commissioning (factory setting)

5.2.1 Switch-on sequence

Step	
1. Connect to the mains.	The controller is ready for operation after approx. 2 seconds.
2. Enter the direction of rotation.	<ul style="list-style-type: none"> • CW rotation: <ul style="list-style-type: none"> - Apply a LOW signal to terminal E4 (0 ... + 3 V). • CCW rotation: <ul style="list-style-type: none"> - Apply a HIGH signal to terminal E4 (+12 ... + 30 V).
3. Enter the setpoint.	Apply a voltage 0 ... + 10 V to terminal 8.
4. Enable controller.	Apply a HIGH signal (+ 12 ... + 30 V) to terminal 28.
5. The drive is now running with factory setting.	

5.2.2 Factory setting of the most important drive parameters

Setting	Code	Factory setting	Adaptation to the application		
Operating mode	C001	-0- Setpoint selection via terminal 8 Control via terminals Parameter setting via 8201BB	See code table, chapter 7.8 for "Standard" See code table, chapter 7.9 for "HVAC"		
Terminal configuration	C007	-0- E4 E3 E2 E1 CW/CCW DC injection brake JOG1/2/3	See code table, chapter 7.8 for "Standard" See code table, chapter 7.9 for "HVAC"		
Machine data			Chapter 5.3 ff.		
Speed range	Min. field frequency	C010	0.00 Hz	Chapter 5.3.1	
	Max. field frequency	C011	50.00 Hz		
Acceleration and deceleration times	Acceleration time	C012	5.00 s	Chapter 5.3.2	
	Deceleration time	C013	5.00 s		
Current limit values	Motor mode	C022	150 %	Chapter 5.3.3	
	Generator mode	C023	80 %		
Drive performance			Chapter 5.4 ff.		
Current / torque/power/performance	Operating mode	C014	-0-	Linear characteristic $V \sim f_d$ with auto boost	Motor-current control, see chapter 5.4.2.1 V/f-characteristic control <ul style="list-style-type: none"> • with auto boost, chapter 5.4.2.2 • with V_{min} boost, chapter 5.4.2.3
			820X		
	V/f-rated frequency	C015	50.0 Hz		
	V_{min} -setting	C016			
			820X	type-dependent	
			821X/822X/824X	0 %	
Slip compensation	C021	0 %			

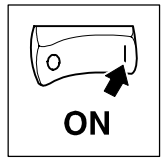

5.3 Adapt machine data

5.3.1 Determine speed range (f_{dmin} , f_{dmax})

Code	Name	Possible settings				IMPORTANT	
		Lenze	Choice	Info			
C010	Minimum field frequency	820X	0.00	0.00	{0.05 Hz}	480.00	
		821X/822X/824X	0.00	0.00	{0.02 Hz}	480.00	
C011	Maximum field frequency	820X	50.00	30.00	{0.05 Hz}	480.00	
		821X/822X/824X	50.00	7.50	{0.02 Hz}	480.00	

Function The speed range required for the application can be selected via the input of field frequencies f_{dmin} and f_{dmax} :

- f_{dmin} corresponds to the speed at 0 % speed setpoint selection.
- f_{dmax} corresponds to the speed at 100 % speed setpoint selection.

Adjustment Relation between field frequency and synchronous motor speed:

$$n_{Nsyn} = \frac{f_{dmax} \cdot 60}{p}$$

n_{Nsyn} Synchronous motor speed [min^{-1}]
 f_{dmax} Max. field frequency [Hz]
 p No. of pole pairs (1, 2, 3, ...)

Example: 4 pole asynchronous motor:

$$p = 2, f_{dmax} = 50 \text{ Hz} \quad n_{Nsyn} = \frac{50 \cdot 60}{2} = 1500 \text{ min}^{-1}$$

Important

- With the setting of $f_{dmin} > f_{dmax}$, the field frequency is limited to f_{dmax} .
- With setpoint selection via JOG values, f_{dmax} acts as limitation.
- f_{dmax} is an internal normalisation variable:
 - Use the LECOM interface only for important modifications, when the controller is inhibited.
- Observe the maximum speed of the motor!
- f_{dmin} is only effective:
 - With analog setpoint input.
 - With the motor potentiometer function "DOWN".

Special features

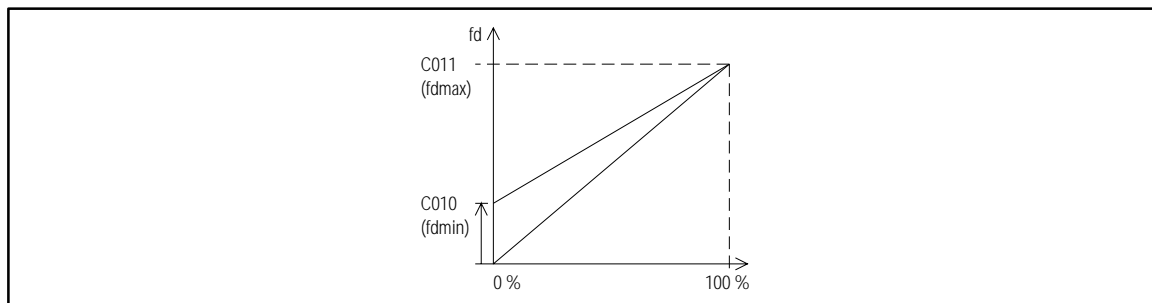

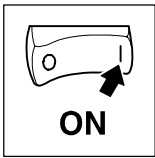

Commissioning

5.3.2 Setting of acceleration and deceleration times (T_{ir} , T_{if})

Code	Name	Possible settings				IMPORTANT		
		Lenze	Choice	Info				
C012	Acceleration time	820X	5.00	0.00	{0.05 s}	999.00	T_{ir}	Variant "Standard"
		821X/822X/ 824X	5.00	0.00	{0.02 s}	999.00		
C013	Deceleration time	820X	5.00	0.00	{0.05 s}	999.00	T_{ir}	Variant "Standard"
		821X/822X/ 824X	5.00	0.00	{0.02 s}	999.00		
C012	Acceleration time	5.00	0.00	{0.02 s}	1300.00	T_{ir}	Variant "HVAC"	
C013	Deceleration time	5.00	0.00	{0.02 s}	1300.00	T_{if}		

Function The acceleration and deceleration times determine the controller response after a setpoint change.

- Adjustment**
- The acceleration and deceleration times refer to a change of the field frequency from 0 Hz to the max. field frequency set under C011.
 - Calculate the times T_{ir} and T_{if} , which must be set under C012 and C013.
 - t_{ir} and t_{if} are the times desired for the change between f_{d1} and f_{d2} .

$$T_{ir} = t_{ir} \cdot \frac{f_{dmax}}{f_{d2} - f_{d1}} \qquad T_{if} = t_{if} \cdot \frac{f_{dmax}}{f_{d2} - f_{d1}}$$

Important Under unfavourable operating conditions, too short acceleration and deceleration times can lead to the deactivation of the controller under overload with the indication of TRIP OC5. In these cases, the acceleration and deceleration times should be set such that the drive can follow the speed profile without reaching I_{max} of the controller.

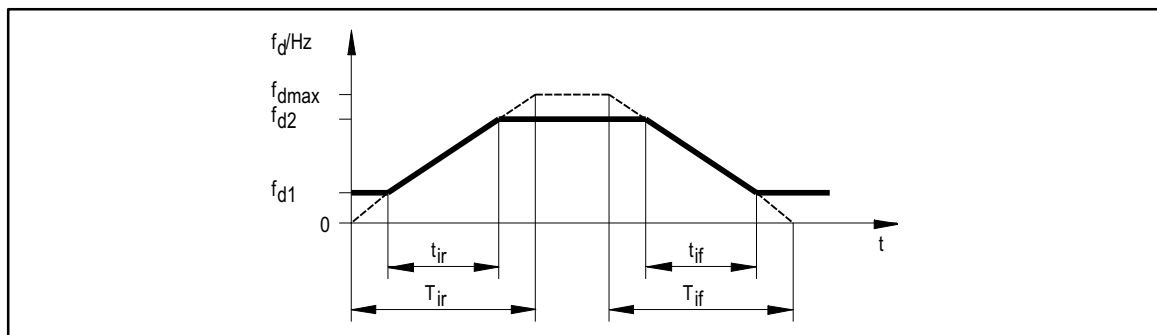
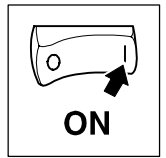

FIG 5-1 Acceleration and deceleration times



5.3.3 Setting of current limit values (I_{\max} limits)

Code	Name	Possible settings				IMPORTANT	
		Lenze	Choice		Info		
C022	I_{\max} limit (motor mode)	150	30	{1 %}	150		
C023	I_{\max} limit (generator mode)		80	30	{1 %}	110	Standard controllers
		822X/824X	80	30	{1 %}	150	
C023	I_{\max} limit (generator mode)		80	30	{1 %}	150	Variant "HVAC"

Function The controllers are equipped with a current-limit control which determines the dynamic response under load. The measured load is compared with the limit values set under C022 for motor load and under C023 for generator load. If the current limits are exceeded, the controller changes its dynamic behaviour.

Adjustment Set the acceleration and deceleration times so that the drive can follow the speed profile without reaching I_{\max} .

Controller behaviour when a limit value is reached

- During acceleration:
 - Increasing the acceleration ramp
- During deceleration:
 - Increasing the deceleration ramp
- With increasing load and constant speed:
 - When reaching the generator-current limit value: Increase of the field frequency to the max. frequency (C011).
 - When reaching the motor-current limit value: Lower the field frequency until the drive load is reduced.
 - Stop the field frequency change if the load falls below the limit value.

Important

821X/822X/824X

- A correct current control in the generator mode is possible only with a connected brake unit or in the DC-bus connection with energy exchange.
- For operation with chopper frequencies > 8 kHz, the current limit values should be set to the currents " I_{\max} for 60 s" (see chapter 3.4). (Derating at higher chopper frequencies.)

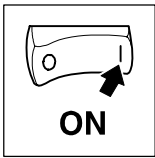

Commissioning

5.4 Optimisation of the operating behaviour

The following settings are used to determine the current and torque behaviour as well as the performance of the connected motor.

Choose between the control modes "Motor current control" and "V/f-characteristic control". Information to help you with the selection can be obtained from chapter 5.4.1.

5.4.1 Select control mode

Code	Name	Possible settings			IMPORTANT
		Lenze	Choice	Info	
C014	Control mode	820X	-0-	-0- Linear characteristic $V \sim f_d$ with auto boost	Control modes of the voltage characteristic
			-1-	-1- Square characteristic $V \sim f_d^2$ with auto boost	
			-2-	-2- Linear characteristic $V \sim f_d$ with constant V_{min} boost	
		-3-	-3- Square characteristic $V \sim f_d^2$ with constant V_{min} boost		
821X/822X/824X	-4-	-4- Motor-current control			

Function

- Under C014 you can set the control mode and the voltage characteristic.
- The V/f-characteristic control with auto boost enables a low-loss operation of stand-alone drives with standard three-phase AC motors with load-dependent V_{min} boost.
- The motor-current control enables a "Sensorless Speed Control". Compared to the V/f-characteristic control, the drive can operate with a considerably higher torque and less current consumption during idle running.

C014 = -2-
Linear characteristic

C014 = -3-
Square characteristic (e.g. for pumps, fans)

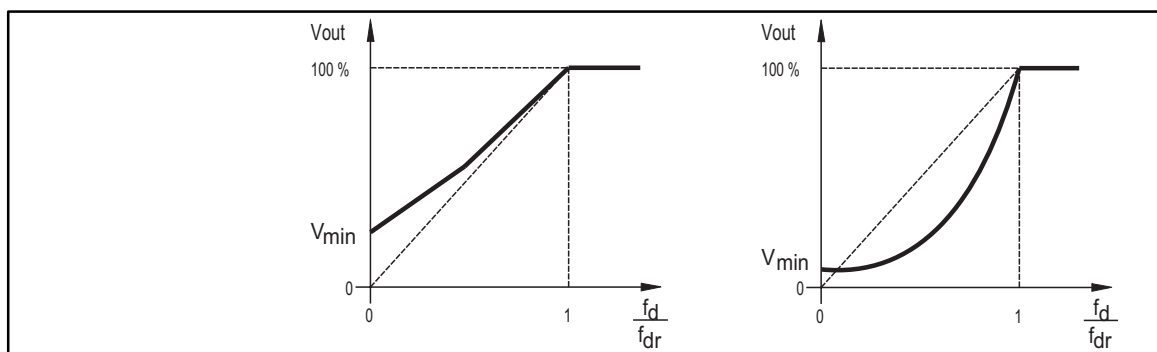

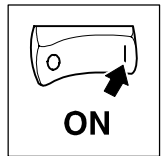

Help for the selection of 820X	Motor cable			
	shielded ≤ 25 m unshielded ≤ 50 m		shielded > 25 m unshielded > 50 m	
	C014			
Stand-alone drives	recommended	alternatively	recommended	alternatively
with constant load	-0-	-2-	-2-	-
with extremely alternating loads	-0-	-2-	-2-	-
with heavy start conditions	-0-	-2-	-2-	-
positioning and infeed drives with high dynamic response	-0-	-	-2-	-
hoists	-0-	-2-	-2-	-
pumps and blowers	-1-	-3-	-3-	-2-
three-phase AC reluctance motors	-2-	-	-2-	-
three-phase sliding rotor motors	-2-	-	-2-	-
three-phase motors with fixed frequency-voltage characteristic	-2-	-	-2-	-
Group drives (depending on the resulting motor-cable length)	$I_{res} = \sqrt{i \cdot (l_1 + l_2 + \dots + l_p)}$			
identical motors and identical loads	-2-	-	-2-	-
different motors and/or changing loads	-2-	-	-2-	-

Help to decide for 821X/822X/824X	Motor cable*			
	shielded ≤ 50 m unshielded ≤ 100 m		shielded > 50 m unshielded > 100 m	
	C014			
Single drives	recommended	alternatively	recommended	alternatively
with constant load	-4-	-2-	-2-	-
with extremely alternating loads	-4-	-2-	-2-	-
with heavy start conditions	-4-	-2-	-2-	-
positioning and infeed drives with high dynamic response	-2-	-	-2-	-
hoists	-4-	-2-/-4-	-2-	-
pumps and blowers	-3-	-2-	-3-	-2-
three-phase AC reluctance motors	-2-	-	-2-	-
three-phase sliding rotor motors	-2-	-	-2-	-
three-phase motors with fixed frequency-voltage characteristic	-2-	-	-2-	-
Group drives (depending on the resulting motor-cable length)	$I_{res} = \sqrt{i \cdot (l_1 + l_2 + \dots + l_p)}$			
identical motors and identical loads	-4-	-2-	-2-	-
different motors and/or changing loads	-2-	-	-2-	-

- * 8211: shielded ≤ 15 m, unshielded ≤ 30 m
 8212: shielded ≤ 25 m, unshielded ≤ 50 m

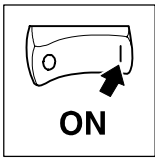

Commissioning

5.4.2 Optimising operating modes

5.4.2.1 Optimising motor-current control (C014 = -4-)

820X setting range: Function is not available

821X/822X/824X setting range:

Required codes

Code	Name	Possible settings			IMPORTANT
		Lenze	Choice	Info	
C015	V/f rated frequency	50.00	7.50 {0.02 Hz}	960.00	
C021	Slip compensation	0.0	0.0 {0.1 %}	20.0	
C088	Rated motor current	*	0.0 ... 2.0 - rated output current	*	depends on the unit Input only necessary when motors not adapted
C091	Motor cos φ	*	0.40 {0.01}	1.00	

Setting sequence

- Drives with matching 4-pole standard motors 230/400 V in star connection must not be connected. After having started the drive, the controller itself detects all further motor data.
- The following drives can be optimised by entering the nameplate data "rated motor current" and "cos φ" under C088 or C091:
 - Motor, one power class smaller than the motor assigned to the controller.
 - Motor, one or two power classes smaller than the motor assigned to the controller.
 - Drives with 2, 6, 8, 10 and 12 pole standard motors.
 - Drives with special motors.
- The sensorless speed control can be optimised for your application with the "sensorless speed control".

1. If necessary, select C014 = -4-.

(Factory setting)

2. Select V/f-rated frequency (C015).

Adjustment

Calculate the frequency to be set under C015:

$$C015 \text{ [Hz]} = \frac{400 \text{ V}}{V_{\text{motor}} \text{ [V]}} \cdot f_r \text{ [Hz]}$$

V_{motor} Rated voltage to motor nameplate [V]
 f_{dr} Rated frequency to motor nameplate [Hz]

For standard motors with $f_{\text{dr}} = 50 \text{ Hz}$, the following settings result for C015:

Motor voltage	Motor connection	C015
230/400 V	Y	50 Hz
230/400 V	Δ	87 Hz

3. If necessary, parameterise C088, C091.

These motor data must only be entered for non-matching motors.

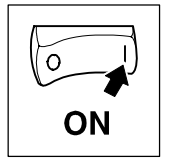

4. Set slip compensation (C021):

Rough setting according to motor data:

$$s = \frac{n_{Nsyn} - n_r}{n_{Nsyn}} \cdot 100 \%$$

$$n_{Nsyn} = \frac{f_{dr} \cdot 60}{p}$$

s	Slip constant (C021)
n_{Nsyn}	Synchronous motor speed [min^{-1}]
n_r	Rated speed to motor nameplate [min^{-1}]
f_{dr}	Rated frequency to motor nameplate [Hz]
p	No. of pole pairs (1, 2, 3, ...)

Precise setting:

- Correct C021 until no load-dependent speed drop occurs in the required speed range between idle running and max. motor load.
- If the values under C021 are too high, the drive may become unstable (overcompensation).
- In the field frequency range between 5 Hz ... 50 Hz (87 Hz) the deviation of the rated speed is $\leq 1 \%$ (guide value). In field-weakening operation, the fault increases.

Important

- The change from V/f-characteristic control to motor-current control should only be carried out when the controller is inhibited.
- The idle current of the motor (magnetising current) must not exceed the rated current of the controller.
- With very small friction values, it is possible that a phase offset of up to 180° occurs at the motor shaft when enabling the controller.

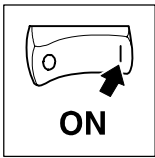

Commissioning

5.4.2.2 Optimise V/f-characteristic control with auto boost (C014 = -0/-1-)

821X/822X/824X setting range: Function is not available

820X setting range:

Required codes

Code	Name	Possible settings				IMPORTANT
		Lenze	Choice		Info	
C015	V/f-rated frequency	50.00	30.00	{0.05 Hz}	960.00	
C016	V _{min} setting	*	0.00	{0.02 %}	40.00	* depends on the unit
C021	Slip compensation	0.0	0.0	{0.1 %}	12.0	

Setting sequence

1. If necessary, select V/f characteristic with auto boost (C014 = -0- or -1-).

2. Select V/f-rated frequency (C015).

- The V/f-rated frequency determines the slope of the V/f characteristic and has considerable influence on the current, torque and power performance of the motor.
- An internal mains voltage compensation compensates deviations in the mains during operation. Therefore, they do not have to be considered for the setting of C015.
- Use standard motors with 230/400 V with Δ connection, since with an input voltage of 230 V a max. of 3AC 230 V is at the output.

Adjustment

Calculate the frequency to be set under C015:

$$C015 \text{ [Hz]} = \frac{230 \text{ V}}{V_{r \text{ motor}} \text{ [V]}} \cdot f_{dr} \text{ [Hz]}$$

$V_{r \text{ motor}}$ Rated voltage to motor nameplate [V]
Observe the connection mode (e.g. with a motor voltage to nameplate 230/400 V / Δ $V_{r \text{ motor}} = 230 \text{ V AC}$.)

f_{dr} Rated frequency to motor nameplate [Hz]

C014 = -0-
Linear characteristic

C014 = -1-
Square characteristic (e.g. for pumps, fans)

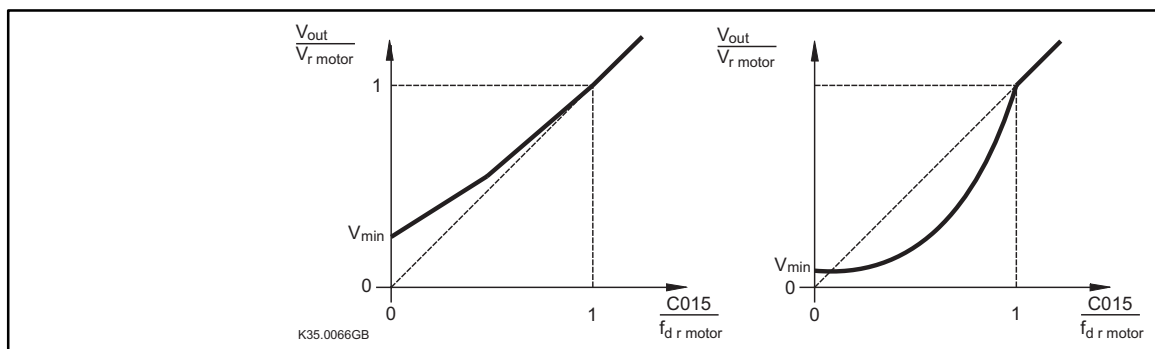

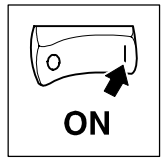

3. Set V_{\min} boost (C016).

Load-dependent boost of the motor voltage in the field frequency range below the V/f-rated frequency. C016 acts as gain factor of the auto-boost function.

Adjustment

In general, an adjustment is not necessary. An optimisation can be advantageous:

For drives with very high starting torques:

A Operate the motor under load.

B Select the frequency setpoint.

C Increase V_{\min} until the required motor current (torque) occurs.

If the setting of V_{\min} is too high, a positive-feedback effect can occur and activate the TRIP "overcurrent" (OCx).

For drives with square load torques (fans, pumps):

A Operate the motor under load.

B Select the frequency setpoint.

C Adapt V_{\min} until the motor is running steadily and smoothly over the whole frequency range.

If the setting of V_{\min} is too high, the TRIP "overcurrent" (OCx) can be activated and lead to an excessive motor temperature.

For drives with special motors:

A Operate the motor under load.

B Select the frequency setpoint.

C Increase V_{\min} until the required motor current (torque) occurs.

If the setting of V_{\min} is too high, a positive-feedback effect can occur and activate the TRIP "overcurrent" (OCx).

D Check the current consumption during idle running when no load is applied.

4. Set the slip compensation (C021).

Rough setting according to motor data:

$$s = \frac{n_{Nsyn} - n_r}{n_{Nsyn}} \cdot 100 \%$$

$$n_{Nsyn} = \frac{f_{dr} \cdot 60}{p}$$

s	Slip constant (C021)
n_{Nsyn}	Synchronous motor speed [min^{-1}]
n_r	Rated speed to motor nameplate [min^{-1}]
f_{dr}	Rated frequency to motor nameplate [Hz]
p	No. of pole pairs (1, 2, 3, ...)

Precise setting:

- Correct C021 until no load-dependent speed drop occurs in the required speed range between idle running and max. motor load.
- If the values under C021 are too high, the drive may become instable (overcompensation).
- In the field frequency range between 5 Hz ... 50 Hz (87 Hz) the deviation of the rated speed is $\leq 1\%$ (guide value). In field-weakening operation, the fault increases.

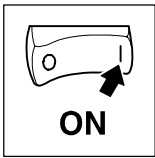

Commissioning

5.4.2.3 Optimise V/f-characteristic control with constant V_{min} boost (C014 = -2/-3-)

Required codes

Code	Name	Possible settings				IMPORTANT	
		Lenze	Choice	Info			
C015	V/f-rated frequency	820X	50.00	30.0	{0.05 Hz}	960.00	Standard controllers
		821X/822X/ 824X	50.00	7.50	{0.02 Hz}	960.00	
C015	V/f-rated frequency	50.00	7.50	{0.02 Hz}	960.00	Variant "HVAC"	
C016	V_{min} setting	820X	*	0.0	{0.2 %}	40.0	* depends on the unit
		821X/822X/ 824X	0.0	0.0	{0.2 %}	40.0	
C021	Slip compensation	820X	0.0	0.0	{0.1 %}	12.0	Standard controllers
		821X/822X/ 824X	0.0	0.0	{0.1 %}	20.0	
C021	Slip compensation	0.0	-50.0	{0.1 %}	50.0	* depends on the unit	Variant "HVAC"
C077*	Gain I_{max} controller	0.25	0.00	{0.01}	1.00		Variant "HVAC"
C078*	Integral action time I_{max} controller	65	12	{1 ms}	9990		(see chapter 7.5.4)

Setting sequence

1. If necessary, select V/f characteristic (C014).

2. Select V/f-rated frequency (C015).

- The V/f-rated frequency determines the slope of the V/f characteristic and has considerable influence on the current, torque and power performance of the motor.
- An internal mains voltage compensation compensates deviations in the mains during operation. Therefore, they do not have to be considered for the setting of C015.

Adjustment

Calculate the frequency to be set under C015:

$$C015 \text{ [Hz]} = \frac{400 \text{ V}}{V_{\text{motor}} \text{ [V]}} \cdot f_{\text{dr}} \text{ [Hz]}$$

V_{motor} Rated voltage to motor nameplate [V]
 f_{dr} Rated frequency to motor nameplate [Hz]

For standard motors with $f_{\text{dr}} = 50 \text{ Hz}$, the following settings result for C015:

Motor voltage	Motor connection	C015
230/400 V	Y	50 Hz
230/400 V	Δ	87 Hz

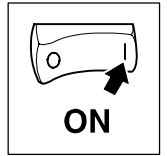

C014 = -2-
Linear characteristic

C014 = -3-
Square characteristic (e.g. for pumps, fans)

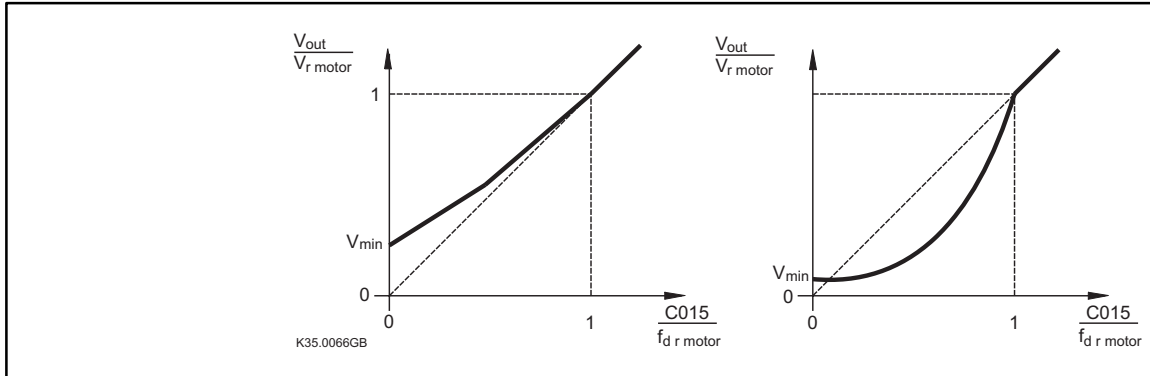

3. Set V_{\min} boost (C016).

- **Load-independent** boost of the motor voltage for field frequencies below the V/f-rated frequency. It is thus possible to optimise the torque performance of the inverter drive.
- It is absolutely necessary to adapt C016 to the asynchronous motor used. Otherwise the motor may be overheated or the inverter may be operated with overcurrent.

Adjustment

Observe the thermal performance of the connected asynchronous motor at low field frequencies when adjusting it:

- Usually, self-ventilated standard asynchronous motors with insulation class B can be driven for a short time with rated frequency with the frequency range between $0 \text{ Hz} \leq f_d \leq 25 \text{ Hz}$.
- Contact the motor manufacturer for exact setting values for the max. permissible motor current in the lower frequency range of self-ventilated motors.

A Operate the motor in idle running with $f_d \approx$ slip frequency:

- $P_{\text{mot}} \leq 7.5 \text{ kW}$: $f_d \approx 5 \text{ Hz}$
- $P_{\text{mot}} > 7.5 \text{ kW}$: $f_d \approx 2 \text{ Hz}$

Detect the slip frequency:

$$f_s = f_{\text{dr}} \cdot \frac{n_{\text{NSyn}} - n_r}{n_{\text{NSyn}}}$$

$$n_{\text{NSyn}} = \frac{f_{\text{dr}} \cdot 60}{p}$$

f_s	Slip frequency [Hz]
f_{dr}	Rated frequency to motor nameplate [Hz]
n_{NSyn}	Synchronous motor speed [min^{-1}]
n_r	Rated speed to motor nameplate [min^{-1}]
p	No. of pole pairs (1, 2, 3, ...)

B Increase V_{\min} until the following motor current is reached:

- Motor in short-term operation at $0 \text{ Hz} \leq f_d \leq 25 \text{ Hz}$:
 Self-ventilated motors: $I_{\text{motor}} \leq I_r \text{ motor}$
 Forced-ventilated motors: $I_{\text{motor}} \leq I_r \text{ motor}$
- Motor in continuous operation at $0 \text{ Hz} \leq f_d \leq 25 \text{ Hz}$:
 Self-ventilated motors: $I_{\text{motor}} \leq 0.8 \cdot I_r \text{ motor}$
 Forced-ventilated motors: $I_{\text{motor}} \leq I_r \text{ motor}$

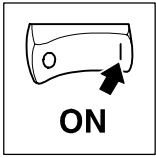

Commissioning

4. Set the slip compensation (C021).

Rough setting according to motor data:

$$s = \frac{n_{Nsyn} - n_r}{n_{Nsyn}} \cdot 100 \%$$

$$n_{Nsyn} = \frac{f_{dr} \cdot 60}{p}$$

s	Slip constant (C021) [%]
n_{Nsyn}	Synchronous motor speed [min^{-1}]
n_r	Rated speed to motor nameplate [min^{-1}]
f_{dr}	Rated frequency to motor nameplate [Hz]
p	No. of pole pairs (1, 2, 3, ...)

Precise setting:

- Correct C021 until no load-dependent speed drop occurs in the required speed range between idle running and max. motor load.
- If the values under C021 are too high, the drive may become instable (overcompensation).
- In the field frequency range between 5 Hz ... 50 Hz (87 Hz) the deviation of the rated speed is $\leq 1 \%$ (guide value). In field-weakening operation, the fault increases.

Important

- The change from V/f-characteristic control and motor-current control should only be carried out when the controller is inhibited.

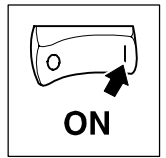

5.4.2.4 Normalisation of an application datum

820X setting range: Function not available.

Setting range 821X/822X/824X:

Code	Name	Possible settings			IMPORTANT
		Lenze	Choice	Info	
C500*	Display factor Application datum - numerator	2000	1 {1} 25000		
C501*	Display factor Application datum - denominator	10	1 {1} 25000		

Function Adaptation of field-frequency related parameters

- C010, C011, C017, C019, C037, C038, C039, C046, C049, C050 and
- for controllers of the "HVAC" series C051, C181, C625, C626, C627 additionally

to an application datum to be controlled, e.g. pressure, temperature, flow rate, humidity or speed.
The normalisation

- implements an absolute or relative selection or display of an application datum,
- is always carried out simultaneously for all codes indicated.

Adjustment The display value is calculated from:

$$c_{xxx} = \frac{C011}{200} \cdot \frac{C500}{C501}$$

Example The speed setpoint is to be input and displayed as relative or absolute value.
Values: $P_{set} = 5 \text{ bar}$, if $f_{dmax} = 50 \text{ Hz}$ (C011)

a) Relative normalisation in %

$$100.00 \text{ (\%)} = \frac{50}{200} \cdot \frac{4000}{10}$$

e.g. C500 = 4000, C501 = 10

b) Absolute normalisation in physical units

$$5.00 \text{ (bar)} = \frac{50}{200} \cdot \frac{200}{10}$$

e.g. C500 = 200; C501 = 10

Important

- All codes indicated above are normalised at the same time.
- After a normalisation, the output frequency [Hz] (C050) can only be recalculated with the display factors C500 and C501.

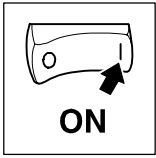

Commissioning

5.4.3 Operation with PID controller

The following controls can be implemented with the internal PID controller:

- pressure,
- temperature,
- flow rate,
- speed,
- dancer-position controls.

Functions

Configuration	Set C005 = -6- or -7- for controlled operation with a PID controller
Variables	<ul style="list-style-type: none">● C070 = gain● C071 = integral action time● C072 = differential component● The I component of the controller can be reset when reaching the Q_{\min} threshold (C017), to suppress the initial conditions because of the missing actual value.
Influence and setpoint precontrol	<ul style="list-style-type: none">● Set the PID controller influence under C074.● Select whether setpoint precontrol is to be used under C238.<ul style="list-style-type: none">- The setpoint precontrol is advantageous for applications which provide an actual value signal which is directly proportional to the speed of the drive. The influence of the PID controller can then be limited that only the maximum expectable slip of the machine will be controlled.● For application where the PID controller is used as process controller, the settings C238 = -0- (without setpoint precontrol) and C074 = 100 % are required.
Setpoint input	<ul style="list-style-type: none">● Enter a fixed setpoint under C181:<ul style="list-style-type: none">- For instance, for dancer position control to select the dancer position.
Via terminal 8 or terminal E1.	<ul style="list-style-type: none">● The setpoint can be selected either via terminal 8 or terminal E1. The terminal not used for setpoint selection is used for the feedback.● With the analog plug-in module 8279IB terminal E1 is used as 2nd analog input (0 ... 10 V / 0/4 ... 20 mA).● Without the analog plug-in module 8279IB terminal E1 can be used as digital input (pulse frequency 0 kHz ... 10 kHz, LOW level = 0 V ... 3 V, HIGH level = 12 V ... 30 V).
Adjustment	<p>The adjustment of the analog inputs limits the control range.</p> <ul style="list-style-type: none">● C026 and C027:<ul style="list-style-type: none">- Adjustment terminal 8.● C426 and C427:<ul style="list-style-type: none">- Adapt C426 and C427 if a 4 ... 20 mA signal is assigned via terminal E1 (8279IB).
Actual value	C051 indicates the actual value of the PID controller.

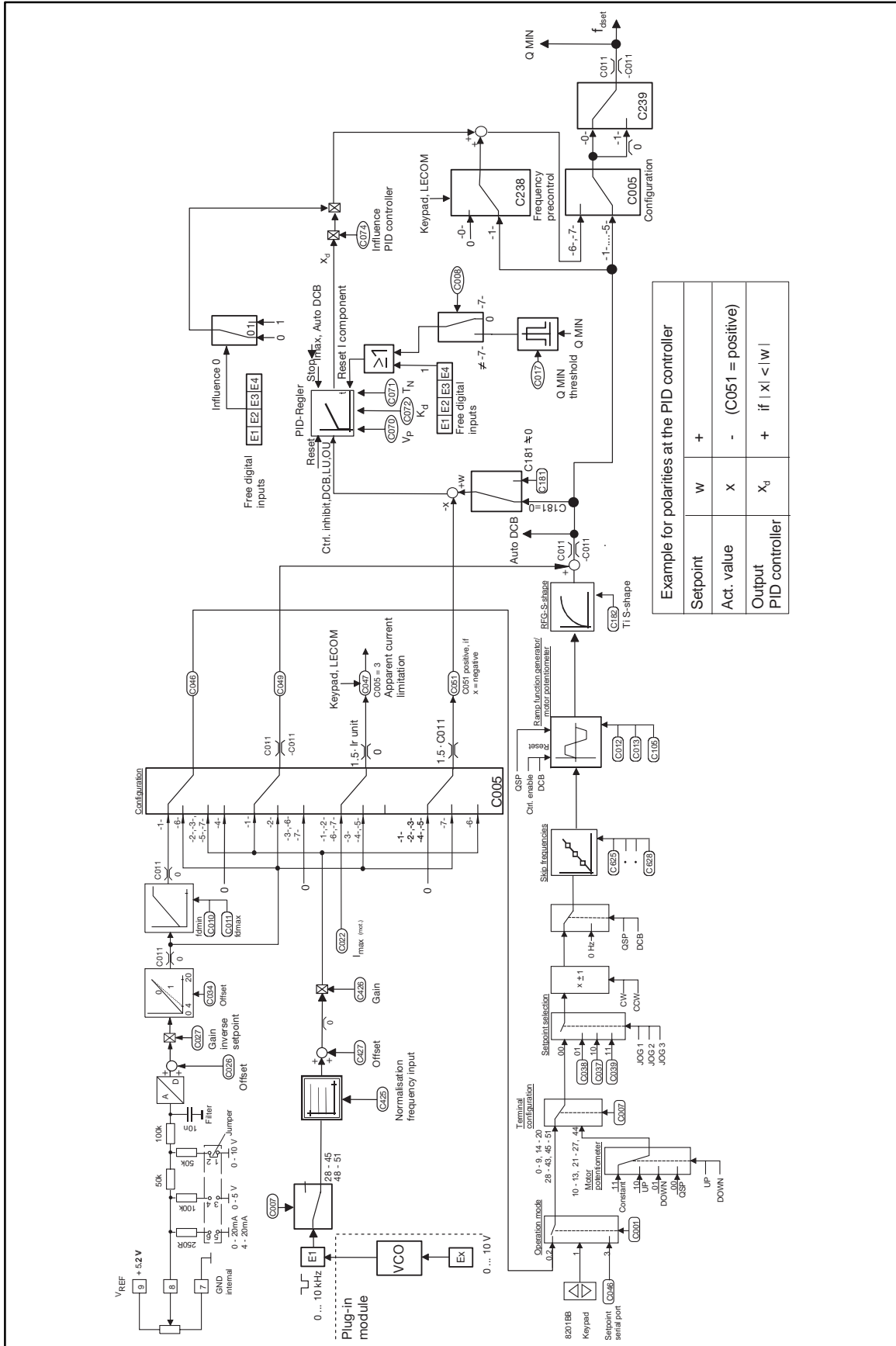
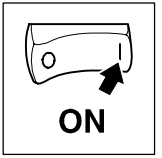

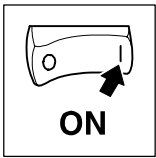

Commissioning

5.5 Application examples for PID controllers

5.5.1 Pump application with pressure control

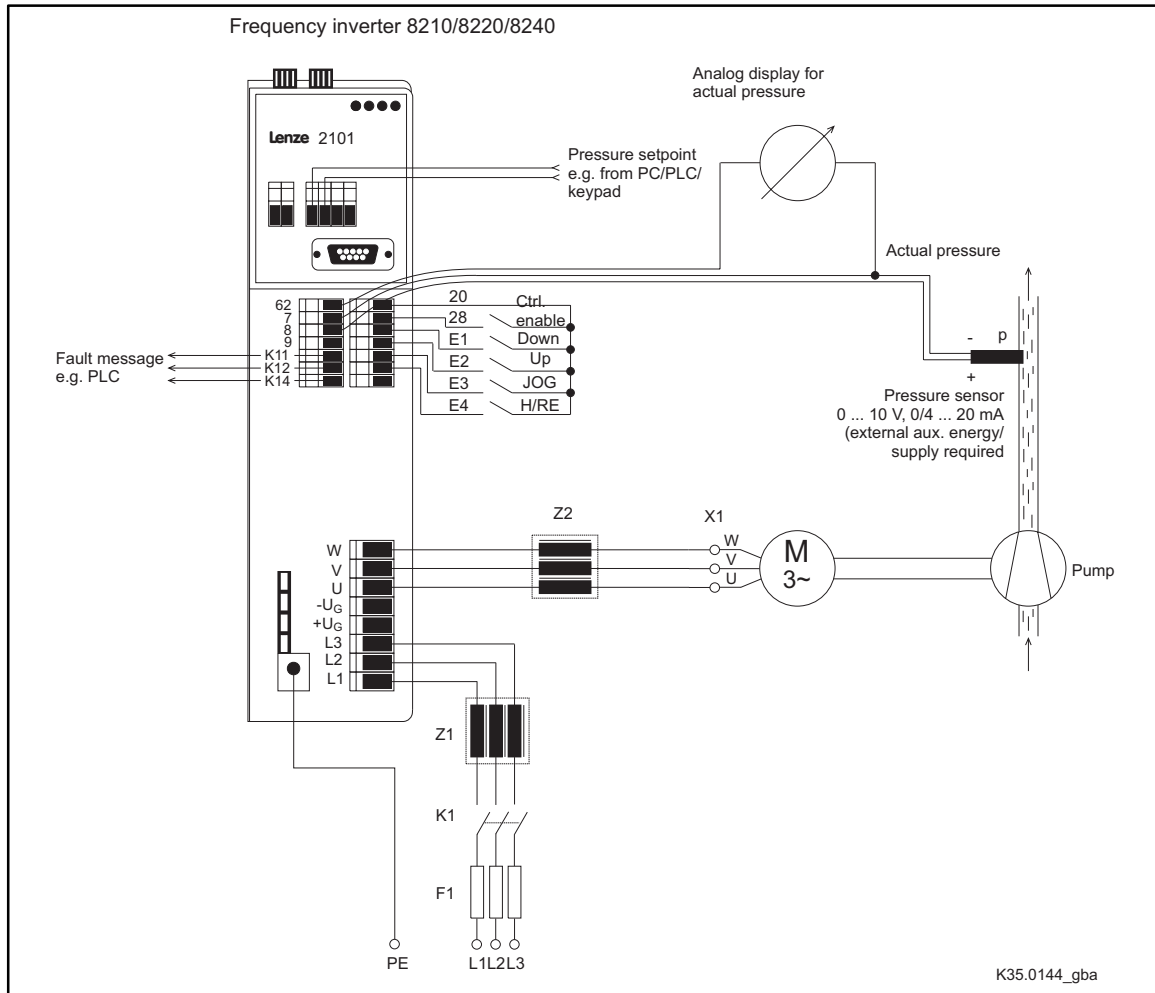
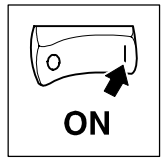

FIG 5-2 Application of a pump with pressure control

Z1 Mains filter required for radio interference level A or B. For mains chokes see chapter 3.4 ff.

Z2 Motor filter/sine filter required for long motor cables or motors not designed for inverter operation (see chapter 4.2.7.2).

Shield all signal and motor cables. Please observe the corresponding installation instructions in chapters 4.2 and 4.3.



Sensor connection

<p>3-phase pressure sensor</p>	<ol style="list-style-type: none"> 1. DC mains supply, e.g. 24 V 2. Pressure sensor 0 - 10 V (jumper 1-2) 0 - 20 mA (jumper 5-6) 4 - 20 mA (jumper 5-6, C034 = 1) 3. Controller
<p>2-phase pressure sensor</p>	<ol style="list-style-type: none"> 1. DC mains supply, e.g. 24 V 2. Pressure sensor 4 - 20 mA (jumper 5-6, C034 = 1) 250 R load 3. Controller
<p>3-phase pressure sensor with supply via controller</p>	<ol style="list-style-type: none"> 1. Pressure sensor 4 - 20 mA (jumper 5-6, C034 = 1) 250 R load 2. Controller <p>Note: Since terminal 20 can be loaded with max. 20 mA, the digital inputs E1 ... E4 must not be addressed.</p>

Application FIG 5-2:

A centrifugal pump is used to ensure constant pressure in a pipeline system (e.g. for water supply of residential and industrial premises).

The application does not only require remote control from a central operating panel but also setting possibilities at site. The pressure is to be reduced to a fixed value during times when only few water is required. Thus, indirectly possible burst pipes can be detected by monitoring the actual pressure.

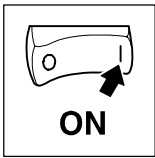

Commissioning

Functions used

- Internal PID controller for pressure control.
 - Regular control, setpoint selection via fieldbus with feedback via analog channel terminal 8.
- Networking via fieldbus (e.g. via plug-in module 2102).
- Manual/remote changeover (H/Re).
 - Setpoint selection change via key (E1 = DOWN / E2 = UP).
- Process setpoint selection (e.g. pressure [p]) via inverter JOG value.
- Electrical controller inhibit (Ctrl. enable).

Code settings:

Code	Name	Possible settings			IMPORTANT
		Lenze	Choice	Info	
C001	Operating mode	-0-	-3-	Setpoint selection - control, parameter setting via LECOM	
C005	Configuration	-0-	-7-	Controlled operation, with analog feedback via term. 8	
C007	Terminal configuration	-0-	-26-	Motor potentiometer, JOG, H/Re	
C037	JOG value 1	20.00	16.67 Hz	Fixed reduction to 1/3 of the rated pressure	
C051	Actual PID controller value				Only display of actual pressure
C070	Gain PID controller	1.00	0.02 ... 0.1		Adaptation to process
C071	Integral action time PID controller	100	0.2 ... 1 s		
C072	Differential component PID controller	0.0	0.0		Inactive
C074	Influence PID controller	0.0	100.0 %		
C111	Monitor signal	-0-	-8-	Actual PID controller value	
C238	Frequency precontrol	-1-	-0-	No precontrol	
C239	Frequency setting range	-0-	-1-	Unipolar	Direction of rotation cannot be changed via the process controller

- All other parameters are based on the factory setting.
- Set the rated motor data under C088 (rated motor current) and C091 (motor $\cos \varphi$) depending on the motor connected.
- In addition to the setpoint input via fieldbus, the pressure setpoint can also be selected via the 8201BB keypad (installation up to max. 10 m away from the controller) or via an analog input signal (using the 8274 plug-in module).



Note!

- For more detailed information on the process controller see chapter 7.5.10.
- Calibration of the setpoints and actual values to the application datum under C500 and C501. (See chapter 5.4.2.4).

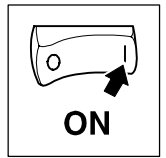

5.5.2 Pump application with level control

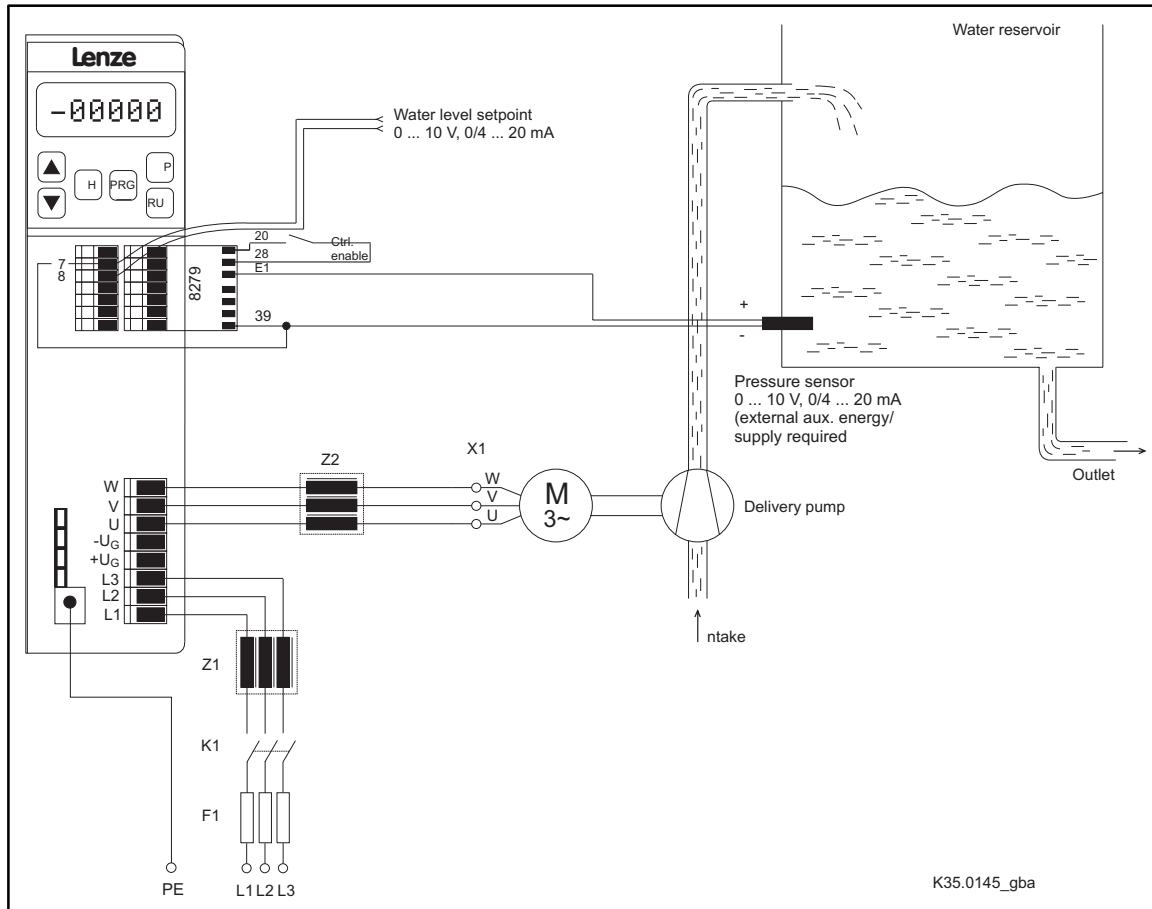
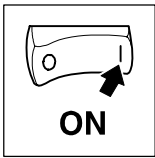

FIG 5-3 Application of a pump with level control

- Z1 Mains filter required for radio interference level A or B. For mains chokes see chapter 3.4 ff.
- Z2 Motor filter/sine filter required for long motor cables or motors not designed for inverter operation (see chapter 4.2.7.2).

Shield all signal and motor cables. Please observe the corresponding installation instructions given in chapters 4.2 and 4.3.



Commissioning

Application FIG 5-3:

In a tank the water is to be held at a constant level. The speed of the pump must be controlled depending on the amount of water delivered.

Functions used

- Internal PID controller for level control.
 - Regular control, analog setpoint selection via terminal 8 with feedback via analog channel E1 with plug-in module 8279IB.

Code settings:

Code	Name	Possible settings			IMPORTANT
		Lenze	Choice	Info	
C005	Configuration	-0-	-6-	Operation with closed-loop control; setpoint via terminal 8 with digital frequency feedback via terminal E1	
C007	Terminal configuration	-0-	-28- ... -45- or -48- ... -51-		Act. level value via terminal E1
C070	Gain PID controller	1.00	0.02 ... 0.1		Adaptation to process
C071	Integral action time PID controller	100	0.2 ... 1 s		
C072	Differential component of PID controller	0.0	0		Inactive
C074	Influence PID controller	0.0	100.0 %		
C238	Frequency precontrol	-1-	-0-	No precontrol	
C239	Frequency setting range	-0-	-1-	Unipolar	Direction of rotation cannot be changed via the process controller

- All other parameters are based on the factory setting.
- For the level setpoint observe the jumper setting at terminal 8 (see chapter 5.5.1).
Set 4 - 20 mA code C034 = 1.
- Set the rated motor data under C088 (rated motor current) and C091 (motor $\cos \varphi$) depending on the motor connected.



Note!

- Adapt C426 and C427 if the actual value input is 4 mA ... 20 mA. (See chapter 3.7.1 and chapter 7.5.14.9).
- Calibration of the setpoints and actual values to the application datum under C500 and C501. (See chapter 5.4.2.4).

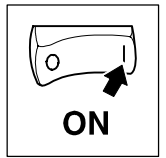

5.5.3 Dancer-position control (line drive)

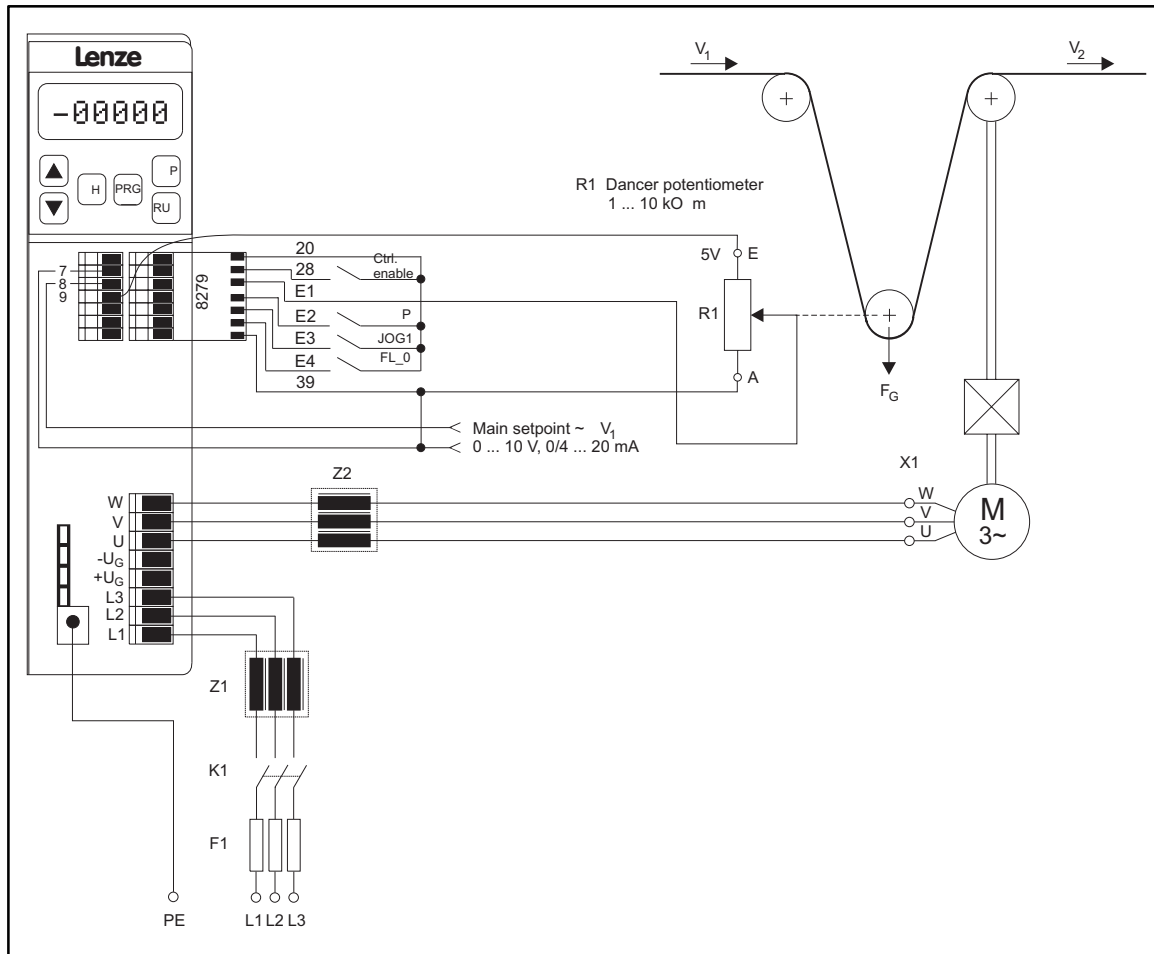
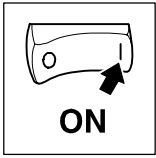

FIG 5-4 Application of a dancer-position control

- Z1 Mains filter required for radio interference level A or B. For mains chokes see chapter 3.4 ff.
- Z2 Motor filter/sine filter required for long motor cables or motors not designed for inverter operation (see chapter 4.2.7.2).

Shield all signal and motor cables. Please observe the corresponding installation instructions given in chapters 4.2 and 4.3.



Commissioning

Application FIG 5-4:

The material speed v_2 is to be synchronised to the line speed v_1 by means of a dancer-position control. The dancer-position setpoint is internally set.

Functions used

- Internal PID controller as position controller.
- Selection of the line speed v_1 via terminal 8.
- Actual dancer-position value from the dancer potentiometer via the analog plug-in module 8279IB.
- Set-up speed via terminal Klemme E3 (JOG1).
- Switch-off of the influence of the dancer controller via terminal E4 (externally) or internally via Q_{\min} (C017) and C008 = 7.

Code settings:

Code	Name	Possible settings			IMPORTANT
		Lenze	Choice	Info	
C005	Configuration	-0-	-6-	Controlled operation; setpoint via terminal 8 with digital frequency feedback via terminal E1	Jumper setting for terminal 8 must be adapted to 5 V (see chapter 4.2.8.2).
C007	Terminal configuration	-0-	-49-		Actual dancer position via terminal E1
C037	JOG value 1	20.00		Fixed set-up speed v_1 for material guidance, individually adjustable	
C070	Gain PID controller	1.00			Adaptation to process
C071	Integral action time PID controller	100			
C072	Differential component PID controller	0.0			
C074	Influence PID controller	0.0	10.0 %		
C105	Deceleration time QSP	5.00		Enter approx. 1 s	E.g. emergency-off function: <ul style="list-style-type: none"> • The drive geometry must be adjusted so that it is possible to brake the controller to standstill within a very short time. A brake chopper might be required.
C181	Setpoint PID controller	0.0		Set the dancer to the position required, C051 = read the actual dancer value and store it under C181.	C181 must not be 0, because here the position setpoint is generated by the main setpoint.
C239	Frequency setting range	-0-	-1-	Unipolar	Direction of rotation cannot be changed via the process controller.

- All other parameters are based on the factory setting.
- Adapt the jumper setting to the main setpoint signal (see chapter 5.5.1).
- Set the rated motor data under C088 (rated motor current) and C091 (motor $\cos \varphi$) depending to the motor connected.

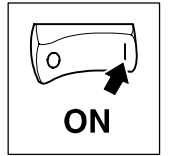

Note!

- For more detailed information on the process controller, see chapter 7.5.10.
 - Calibration of the setpoints and actual values to the application datum under C500 and C501.
(See chapter 5.4.2.4).
-

Notes for the adjustment of the dancer controller:

Set the gain V_p (C070), the integral action time T_N (C071) and the differential component (C072) so that the original position can be reached quickly with only minimum overshooting, if the dancer is adjusted manually (change of the act. value).

For the adjustment start with code C070, then set C071 and C072. C071 must be deactivated (via terminal E4) when setting C070. C072 must be deactivated (via 0) for setting C071.

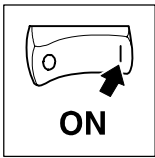

Commissioning

5.5.4 Air conditioning system

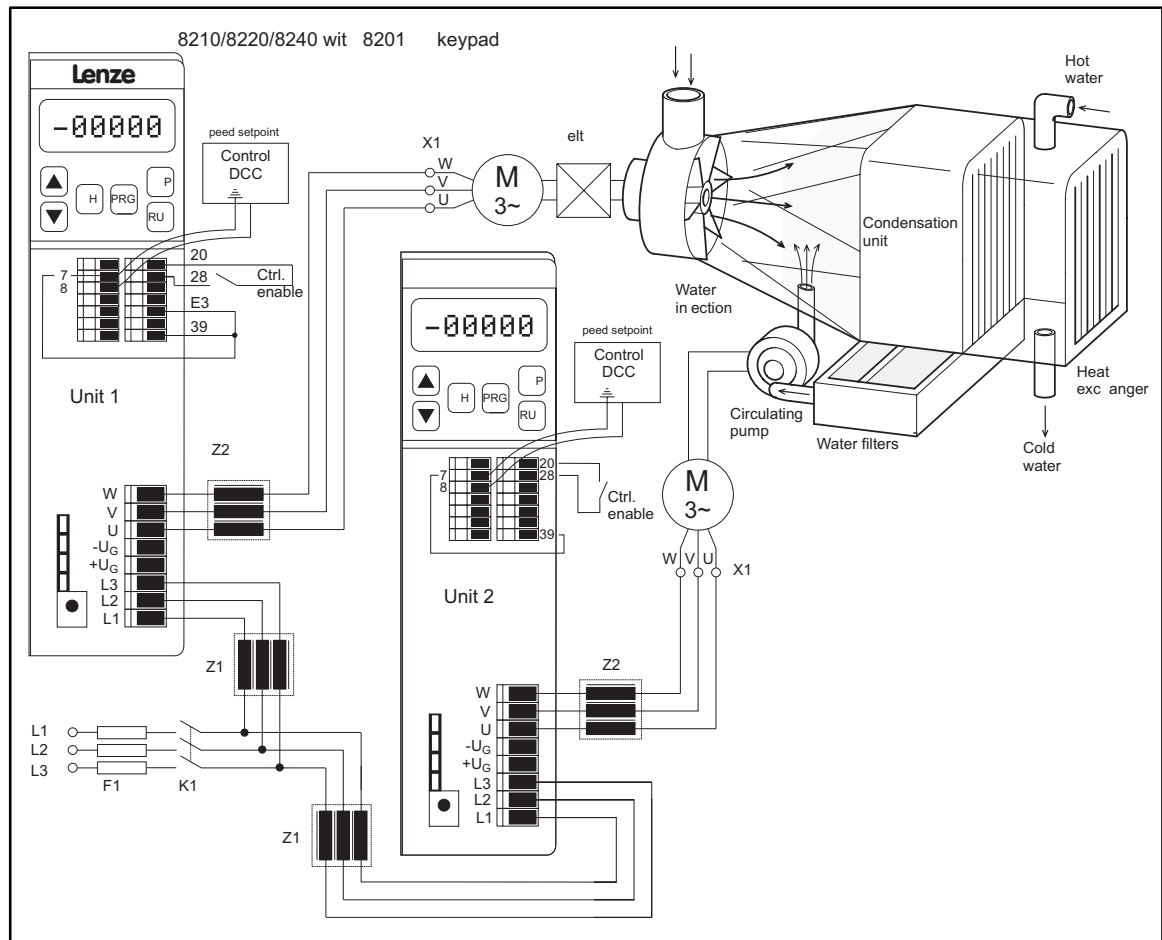
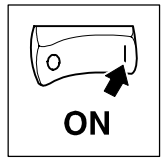

FIG 5-5 Application example of an air conditioning system

Z1 Mains filter required for radio interference level A or B. For mains chokes see chapter 3.4 ff.

Z2 Motor filter/sine filter required for long motor cables or motors not designed for inverter operation (see chapter 4.2.7.2).

Shield all signal and motor cables. Please observe the corresponding installation instructions in chapters 4.2 and 4.3.



Application FIG 5-5:

The air conditioning system of a department store is to be controlled according to the number of persons present. The fans must circulate an amount of air that depends on the number of people (e.g. data provided by a person counter).

Functions used

- Belt monitoring
- Flying-restart circuit on coasting motor
- Suppression of mechanical resonances
- Smooth start and stop with S-ramps

Code settings for unit 1:

Code	Name	Possible settings		
		Lenze	Choice	Info
C001	Operating mode	-0-	-0-	Setpoint selection via term. 8 (jumper setting, see chapter 4.2.8.2) Control via terminals parameter setting with 8201BB
C005	Configuration	-0-	-0-	Operation with open-loop control via terminal 8
C008	Function relay K1	-1-	-14-	Apparent motor current (C054) < Current threshold C156 and acceleration finished (Belt monitoring)
C014	Control mode	-0-	-3-	Square characteristic $V \sim f_d^2$ with constant V_{\min} boost
C142	Start condition	-1-	-3-	Automatic start, if term. 28 HIGH, flying-restart circuit active
C156	Current threshold	0	50 %	
C182	$t_{\text{integration}}$ RFG S-shape	0.00	0.50 s	Smooth start / stop
C625	Skip frequency 1	480.00	30.00 Hz	Removal of mechanical resonances
C628	Skipping bandwidth, f_{skip}	0.00	10.00 %	

Procedure for setting skip frequencies



Stop!

If the mechanical resonance points are approached, the mechanics may be damaged.

1. Remain C625 to C628 in factory setting.
2. Detect mechanical resonances (if not already known).
3. Detect the bandwidth of the mechanical resonances.
4. Set C625 to C628 according to the data available.



Note!

Terminal E3 must always be at L level (PAR2: normal operation; PAR1: QSP).

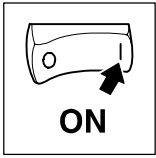

Commissioning

Code settings for unit 2:

Code	Name	Possible settings		
		Lenze	Choice	Info
C001	Operating mode	-0-	-0-	Setpoint selection via term. 8 (jumper setting, see chapter 4.2.8.2) Control via terminals parameter setting with 8201BB
C005	Configuration	-0-	-0-	Operation with open-loop control via terminal 8
C014	Control mode	-0-	-3-	Square characteristic $V \sim f_{\sigma}^2$ with constant V_{\min} boost

According to the information given in both tables (code setting for unit 1 and 2):

- All other parameters are based on the factory setting.

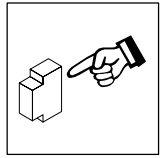

6 During operation

6.1 Operating information

6.1.1 General

- Replace defective fuses with the prescribed type only when no voltage is applied.
There are no fuses in the controller.
- With cyclic mains connection and disconnection:
 - Do not switch on the controller more than every three minutes, otherwise the internal initial-current limitation can be overloaded.
- Switching on the motor side:
 - Permissible for emergency switch-off.
 - Monitoring messages can be activated when switching the motor when the controller is enabled.
- The plug-in connection terminals of the 820X controllers must only be connected or disconnected when no voltage is applied.
- Depending on the controller settings, the connected motor can be overheated:
 - For instance, longer DC-braking operations.
 - Longer operation of self-ventilated motors at low speed.
- With the corresponding parameter setting, the controllers reach an output frequency of up to 480 Hz:
 - If an inappropriate motor is connected, a hazardous overspeed may occur.
 - With frequencies > 240 Hz, the overcurrent switch-off of the 820X controllers can be activated.
- With the function CW/CCW (selection of the direction of rotation) in configuration C007 = -0- ... -13-, -23 ... -45-:
 - The drive can reverse the direction of rotation in the event of a control-voltage failure or a cable break.
- If the function "flying-restart circuit" (C142 = -2-, -3-) is used with machines with low inertia torque and friction:
 - After the controller has been enabled in standstill, the motor can start for a short time or reverse the direction of rotation.

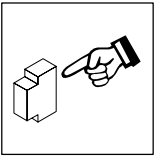

During operation

6.1.2 822X/824X

- The controllers 822X/824X have a temperature-dependent fan circuit:
 - The fans are only activated when the heat sink temperature, which is a fixed factory setting, is exceeded.

6.1.3 8218-V003

- For use of the variant 8218-V003 with the Lenze convection cooling system:
 - Depending on the application conditions, the temperature monitoring (message "OH") can be activated during low-noise operation with a 16 kHz chopper frequency (C018=-5-).

6.2 Display of the controller status

During operation without an operating module, the operating state of the controller is displayed on two LEDs at the front of the unit.

LED		Operating status
green	red	
on	off	Controller enabled
on	on	Mains switched on and automatic start inhibited (AS_LC)
blinking	off	Controller inhibited
off	blinking every second	Fault message
off	blinking every 0.4 seconds	Undervoltage switch-off
off	off	Programming mode (only 820X)

Manual

Part D

Configuration

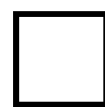

Global Drive
Frequency inverters 8200

This Manual is valid for 82XX controllers as of version:

	33.820X-	E-	1x.	1x		(8201 - 8204)
	33.8202-	E-	1x.	1x	-V002	Reduced assembly depth (8202)
	33.821X-	E-	0x.	1x		(8211 - 8218)
	33.821X-	E-	1x.	2x		(8211 - 8218)
	33.821X-	C-	1x.	2x	-V003	Cold plate (8215 - 8218)
	33.821X-	E-	3a.	3x	-V020	HVAC (8211 - 8218)
	33.822X-	E-	0x.	0x		(8221 - 8227)
	33.822X-	C-	1x.	2x	-V003	Cold plate (8221 - 8222)
	33.822X-	E-	3a.	3x	-V020	HVAC (8221 - 8227)
	33.824X-	E-	1x.	1x		(8241 - 8246)
	33.824X-	C-	1x.	1x	-V003	Cold plate (8241 - 8246)
	33.824X-	E-	3a.	3x	-V020	HVAC (8241 - 8246)
Type						
Design: B = Module C = Cold plate E = Built-in unit IP20						
Hardware version and index						
Software version and index						
Variant						
Explanation						

		revised	
Edition of:	01/1999		

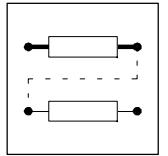

7 Configuration

- The configuration of the controller is used to adapt the drive to your applications.
- For this, you have the following functions available:
 - Operating functions
 - Control functions
 - Display functions
 - Monitoring functions
- The possible settings for the functions are organised in codes:
 - Codes are numerically sorted, starting from the code with the smallest number to the one with the highest number. All codes start with a "C".
 - They are listed in the code table.
 - Each codes provides parameters, which can be used to adjust and optimise your drive.
- The configuration of the controller can be entered by means of the keypad of the 8201BB operating module or by means of a fieldbus via the serial interface.
 - The operating module and fieldbus modules are available as accessories.

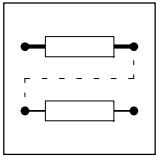

Configuration

7.1 8201BB operating module

(Not included in the delivery package, see Accessories).

The 8201BB operating module is equipped with a 5-digit LCD and 6 function keys.

Functions:

- Parameter setting
- Display
- Setpoint selection via keypad
- Controller inhibit and enable via keypad
- Parameter transfer with other controllers of the same type series.
 - The parameter transfer with other type series is not possible because of the different code sets!

The operating module can be attached or detached during operation.

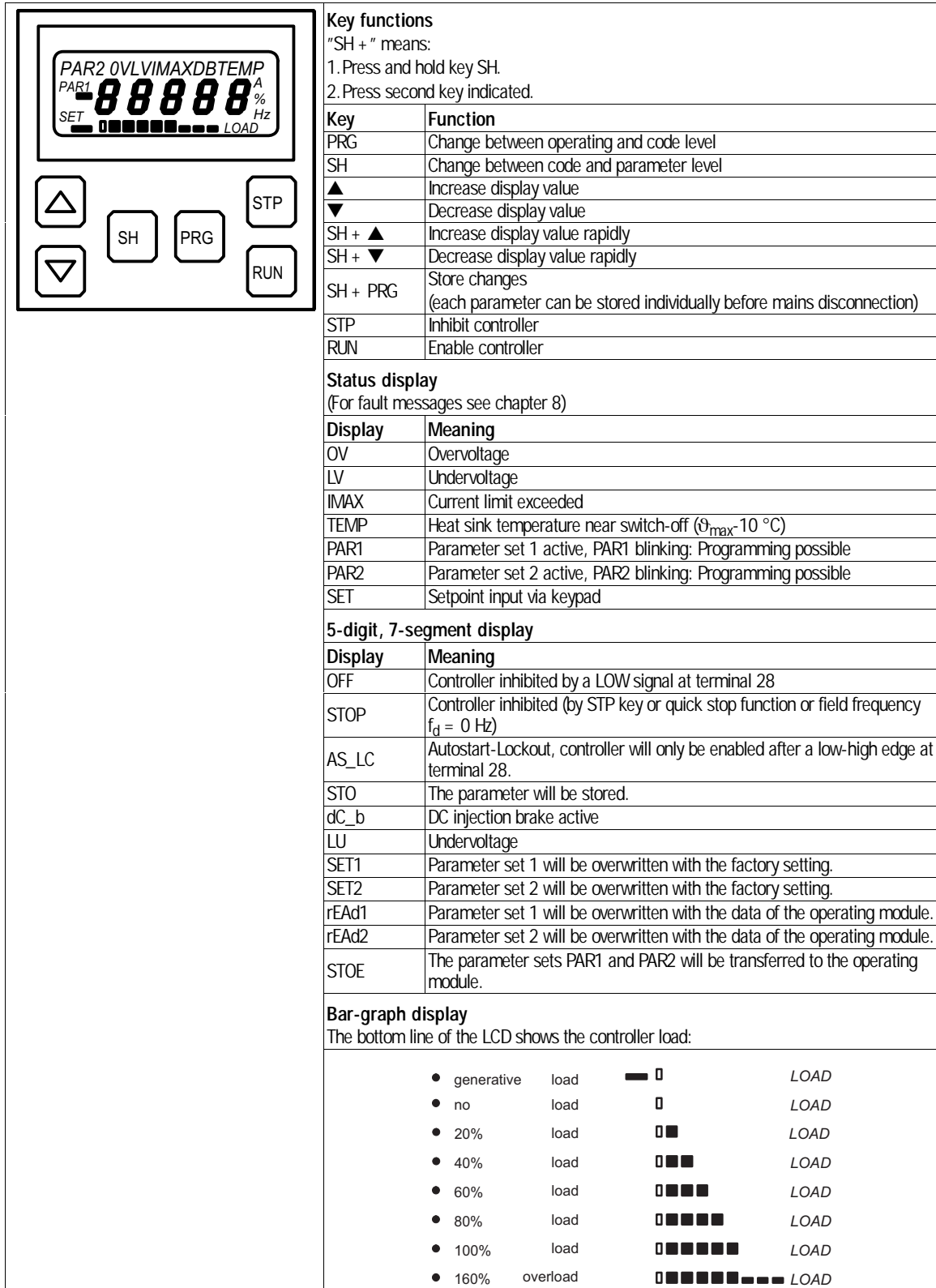
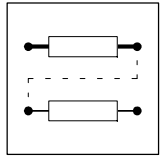
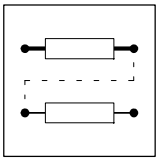

FIG 7-1 8201BB operating modules - functions, displays



Configuration

7.2 Structure of the operating program

The operating program has three program levels: operating level, code level, and parameter level. The controller parameters are set in the code level and the parameter level.

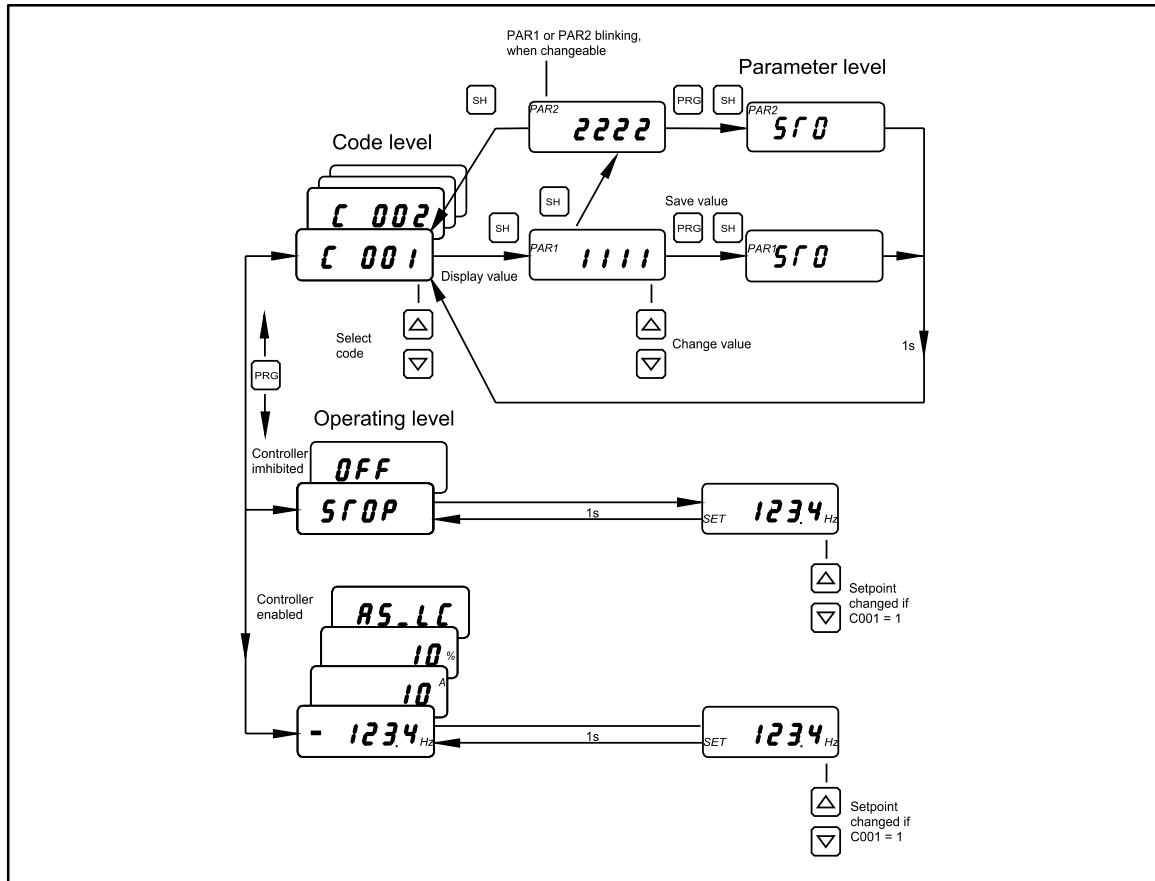

FIG 7-2 Flow chart for parameter setting

7.2.1 Operating level

- The controller is in the operating level after mains connection.
- You can see the switch-on display (C004).
- You can change to the code level by pressing the key PRG.

7.2.2 Code level

- In the code level you select a code by pressing ▲ or ▼.
- Change to the parameter level by pressing the key SH.

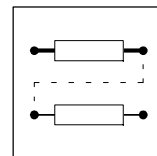

7.2.3 Parameter level

- The parameter level contains two parameter sets, PAR1 and PAR2. Press the key SH to change from PAR1 to PAR2.
- Each code provides parameters which can be used for drive adjustment.
 - The blinking of PAR1 or PAR2 indicates in which parameter set you are.
- There are four different parameter types:
 - Absolute physical values (e.g. 400 V, 10 s)
 - Relative physical values (e.g. 50 % setpoint)
 - Numbers for certain states (e.g. -0- = controller inhibited, -1- = controller enabled)
 - Display values
These values can be displayed but not changed. (e.g. motor-current).
- Absolute and relative values can be modified in discrete steps. The steps can change in the parameter-setting range.
Example: Acceleration time T_{ir} (C012):
3 steps in the whole parameter setting range
 - T_{ir} of 0.0 2 s ... 1 s (step 0.02 s, with 820X step 0.05 s)
 - T_{ir} of 1 s ... 10 s (step 0.1 s)
 - T_{ir} of 10 s ... 100 s (step 1 s)

7.3 Change and store parameters

Each code with parameters which can be changed is factory set. There are three possibilities, depending on the code, to change a parameter:

	Labelling in code table
Acceptance and storage without acknowledgement	Cxxx
Acceptance and storage acknowledged with SH + PRG	Cxxx↓
Acceptance and storage acknowledged with SH + PRG at controller inhibit	[Cxxx]

- Parameters can be changed when the controller is enabled.
- Changes of the operating parameters are accepted ONLINE.
- Parameters, which influence the initialisation of the controller, must be acknowledged with SH+PRG.



Note!

Overwriting of the parameter sets (C002) is only possible when the controller is inhibited.

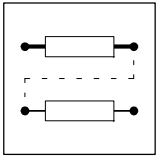

7.3.1 Change and store parameters with the 8201BB operating module

Acceptance without acknowledgement (ONLINE)

The controller accepts the changed parameter immediately.

1. Change from the operating level to the code level by pressing PRG.
2. Select a code with ▲ or ▼.
3. Change to parameter set PAR1 by pressing SH.
 - If necessary, press SH again to change to parameter set PAR 2.
4. If PAR1 or PAR2 is blinking, change the parameter with ▲ or ▼.
 - The controller accepts the changed parameter immediately.
 - This is also possible during operation of the drive.
5. Change to the code level by pressing SH.
6. Change to the operating level by pressing PRG.

The changed parameter is now stored permanently.

Acceptance acknowledged with SH + PRG

(Labelled with "↵" in the code table.)

The controller accepts the changed parameter only after pressing SH+PRG.

1. Change from the operating level to the code level by pressing PRG.
2. Select a code with ▲ or ▼.
3. Change to parameter set PAR1 by pressing SH.
 - If necessary, press SH again to change to parameter set PAR 2.
4. If PAR1 or PAR2 is blinking, change the parameter with ▲ or ▼.
 - This is also possible during operation of the drive.
5. Press SH + PRG.
 - STO is displayed for approx. 1 s.
 - The program jumps back to the code level.
 - The controller now works with the new parameter.
6. Change to the operating level by pressing PRG.

The changed parameter is now stored permanently.

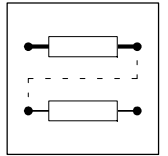

Acceptance acknowledged with SH + PRG when the controller is inhibited.

(Labelled with "[Cxxx]" in the code table.)

The controller only accepts the changed parameter when the controller is inhibited and after pressing SH + PRG.

1. In the operating level you inhibit the controller by pressing STP.
2. Change from the operating level to the code level by pressing PRG.
3. Select a code with ▲ or ▼.
4. Change to parameter set PAR1 by pressing SH.
 - If necessary, press SH again to change to parameter set PAR 2.
5. If PAR1 or PAR2 is blinking, change the parameter with ▲ or ▼.
6. Press SH + PRG.
 - STO is displayed for approx. 1 s.
 - The program jumps back to the code level.
7. Change to the operating level by pressing PRG.
 - The changed parameter is now stored permanently.
8. Enable the controller again using RUN.
 - The controller now works with the new parameter.



Note!

Fast loading of the factory setting for 820X:

Press the keys ▲ and ▼ at the same time in the parameter level to load the factory setting of the selected code.

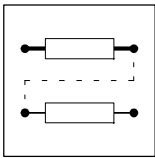

Configuration

7.3.2 Change and store parameters with fieldbus modules.

RS232/485 fieldbus module 2102IB

- Parameter setting via the serial LECOM interface is supported by the PC programs "Global Drive Control" and "LEMOC2" (see Accessories).
- The codes of parameters set PAR 1 are set via the LECOM interface by entering the code number as address. To address the codes of parameter set PAR 2 it is necessary to add 2000 to the code number.
 - Example: Address of minimum field frequency f_{dmin} :
In the parameter set PAR1: C011.

INTERBUS fieldbus module 2111IB

The parameter setting for controller with INTERBUS is described in the Operating Instructions for the 2111IB fieldbus module.

System bus module 2171IB/2172IB

The parameter setting for controllers with the system bus (CAN) is described in the Operating Instructions for the 2171IB/2172IB system bus module.

7.3.3 Dynamic parameter change

Only "HVAC" controllers

Code	Name	Possible settings			IMPORTANT
		Lenze	Choice	Info	
C003	Save parameter set	-1-	-0- -1-	Data will not be stored on EEPROM; all data will be lost when switching off the mains Data will be stored on EEPROM; setting when switching on the mains	

Function Continuous change of parameters is possible via a bus connection module. The EEPROM is not damaged by exceeding the max. permissible number of write accesses.

Selection

- C003 = -0-
- Continuous parameter change is not permitted because the data is not stored on EEPROM.
- C003 = -1-
- Changed parameters are immediately stored on EEPROM.

Important C003 = -0- is only valid for C010, C011, C012, C013, C037, C038, C105, C181 and C182. With C003 -1- the continuous change of parameters is not permitted because the max. permissible write accesses of the EEPROM can be exceeded.

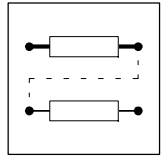

7.4 Operating functions

7.4.1 Operating mode

Code	Name	Possible settings			IMPORTANT
		Lenze	Choice	Info	
C001 ↙	Operating mode	-0-	-0-	Setpoint selection via term. 8 Control via terminals Parameter setting via 8201BB	
			-1-	Setpoint selection via 8201BB or LECOM Control via terminals Parameter setting via 8201BB	
			-2-	Setpoint selection via term. 8 Control via terminals Parameter setting via LECOM	
			-3-	Setpoint selection via LECOM Control via LECOM Parameter setting via LECOM	

Function

With the selection of the operating mode you determine the control, the setpoint selection and the parameter setting of the drive. This setting should always be made first.

Important

When you select the setpoint via the keypad or the motor-potentiometer function, the setpoint will be saved when switching the mains or interrupting the operation.
When changing the operating mode to "setpoint selection via keypad" or "setpoint selection via LECOM", the drive might start after enabling the controller.

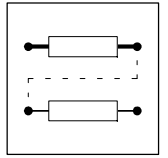

- Function** The controllers are equipped with two parameter sets: PAR1 and PAR2. You can switch from one parameter set to the other during operation. If the second parameter set is activated, for instance, additional acceleration and deceleration times or three additional JOG frequencies can be activated.
- Selection** Change to PAR2 via the digital input terminal PAR, e.g. terminal E3 if C007 = -1- (see table "Terminal configuration").
- Overwrite parameter sets with factory setting.
 - Copy the parameter sets to different controllers of the same type using the keypad:
 - 820X→820X
 - 821X→821X
 - 822X/824X→822X/824X
- Series "HVAC":
- Copy the parameter sets to different controller using the keypad.
 - Overwrite parameter sets with controller-dependent data (C002 = -7-).
- Important**
- The controller works with PAR1 when using the factory setting.
 - For copying the data from the keypad (C002 = -3-, -4-, -5-):
 - Parameters C016, C036, C088, C091, C079 will not be transferred.
 - Select C002 = -7- to transfer these parameters (only series "HVAC").
 - The LCD displays the activated parameter set only in the code level.
 - The codes marked with * in the code table are the same for PAR1 and PAR2.

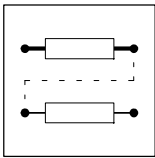

Configuration

7.4.3 Change parameter set via DC-bus voltage

Only series "HVAC"

7.4.3.1 AC-motor braking by means of parameter set changeover

Code		Possible settings		IMPORTANT
No.	Name	Lenze	Choice	
C988*	DC-bus voltage threshold for DC-bus voltage control	0	0 (1 %) 200	<ul style="list-style-type: none"> • C988 = 0 % - Parameter set changeover deactivated via DC-bus voltage • Changeover always between PAR1 and PAR2 • Parameter set changeover via terminal, bus or PC is not possible if C988 > 0!

Function

With the parameter set changeover in dependence of the DC-bus voltage, the AC motor braking can be used as alternative for DC braking.

- The AC motor braking is a braking method without external brake resistor for the control mode "V/f-characteristic control with linear characteristic" (C014 = -2-).
- With mains voltages up to approx. 3 AC 400 V it is possible to achieve braking times shorter than with the DC-brake.
- The braking times for generative braking via external brake resistor are approx. 33 % shorter than for AC motor braking.

Configuration of the parameter sets

Code	PAR1 setting (active in normal operation)	PAR2 setting (active in braking operation)	Note
C013C 105	Braking time required for AC braking	Deceleration time of the drive with max. inertia load without getting the message OU (overvoltage) during deceleration.	<ul style="list-style-type: none"> • C0013 for braking along the main setpoint ramp • C0105 for braking along the QSP ramp
C015	Value adapted to the drive, e.g. V/f vertex = 50 Hz	Depending on the drive power up to min. 25 % of the value under C015 in PAR1: <ul style="list-style-type: none"> • Rule of thumb: 2.2 kW ⇒ 50 % • Decrease for lower drive power, increase for higher drive power. 	Thus the energy in the motor is decreased by overexcitation in PAR2.
C016	Value adapted to the drive, e.g. V _{min} = 5 %	Depending on the drive power up to 500 % of the value under C0016 in PAR1: <ul style="list-style-type: none"> • Rule of thumb: 2.2 kW ⇒ factor 3 • For lower drive power increase the factor, for higher power decrease it. 	Thus also in the lower speed range, the energy in the motor is decreased by overexcitation in PAR2.
C988	Threshold Setting according to the mains voltage: 400 V ⇒ 112 % 440 V ⇒ 123 % 460 V ⇒ 129 % 480 V ⇒ 133 %		

Important

- AC motor braking can only be used together with the control mode "V/f-characteristic control with linear characteristic" (C014 = -2-).
- Parameter set changeover is not possible via terminal, bus or PC, if C988 > 0!
- The higher the mains voltage, the longer the deceleration time for AC braking must be set in PAR1, to fulfill the requirements stated above. It is therefore possible to achieve shorter deceleration times with the DCB, if the mains voltage is high.
- C988 is the same in all parameter sets.

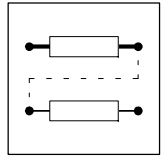

7.4.3.2 Automatic parameter set changeover for controlled deceleration in the event of mains failure

Code		Possible settings			IMPORTANT
No.	Name	Lenze	Choice		
C988*	DC-bus voltage threshold for DC-bus voltage control	0	0 {1 %}	200	<ul style="list-style-type: none"> • C988 = 0 % - Parameter set changeover deactivated via DC-bus voltage • Changeover always between PAR1 and PAR2 • Parameter set changeover is not possible via terminal, bus or PC if C988 > 0!

Function

- Controlled deceleration of the motor to standstill ($f_d = 0$) when switching the mains or in the event of mains failure.
- If the motor is not standing still when being reconnected to the mains, it is accelerated along the acceleration ramp (C0012) to the preselected setpoint. There is no delay time as it occurs with active flying-restart circuit.

The function can be used with or without external brake resistor:

Without external brake resistor

- Controlled deceleration of the motor to standstill ($f_d = 0$) when the controller is active.
- The braking energy is generated through the system losses (controller and motor).

With external brake resistor

- Automatic, fast deceleration of the motor to standstill ($f_d = 0$).
- The deceleration time is shorter than without external brake resistor.

Functionality

1. Mains voltage is interrupted.
2. U_G becomes lower than the value in C0988 \Rightarrow PAR1 is activated.
3. QSP in PAR1 starts operation in generator mode.
4. U_G becomes higher than the value in C0988.
5. PAR2 is activated \Rightarrow The motor accelerates with T_{ir} (C012 in PAR2).
6. The rotation energy in the motor keeps U_G at its min. value until the motor speed is approx. 0.

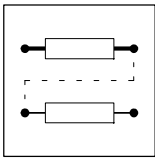

Configuration

Adjustment	Code	PAR1 setting (active in the event of mains failure)	PAR2 setting (active in normal operation)	Note
Threshold	C988	Threshold C0988 = 100 % corresponds exactly to the mains voltage 3 AC 400 V. Adapt C0988 to the mains-voltage dependent undervoltage: 3 AC 400 V - 10 % 3 AC 460 V - 10 % ⇒ C0988 = 75 % ... 85 % ⇒ C0988 = 75 % ... 98 %		Most uniform deceleration can be achieved by setting the upper limit of the bandwidth.
Terminal configuration	C007	Select terminal configuration with terminal for QSP function. <ul style="list-style-type: none"> Invert QSP input via C114. Do not assign the QSP input. 	Select terminal configuration for normal operation. <ul style="list-style-type: none"> The QSP input selected in PAR1 must only be used if not inverted. Invert the QSP input selected in PAR1 via C114. 	With factory setting, the QSP input is low active.
With QSP In normal operation Without QSP In normal operation				
Quick stop without external brake resistor	C105	Ensure with the setting that the motor decelerates to standstill in a controlled way after mains disconnection: 1. Set the same value as in PAR2. 2. Switch off the mains voltage. <ul style="list-style-type: none"> PAR1 will be activated. Observe whether the controller indicates "Overvoltage OU" during controlled deceleration. 3. Reduce the value and switch the mains until the controller indicates OU during deceleration. 4. Increase this value by approx. 20 % as final setting.	Set the deceleration time for QSP required for the application.	
Quick stop with external brake resistor	C105	1. Set the same value as in PAR2. 2. Reduce the value until the required deceleration time after mains switch-off is available.	Set the deceleration time for QSP required for the application.	<ul style="list-style-type: none"> Do not exceed the generative current limit during deceleration. Select the external brake resistor large enough.

Important

- Parameter set changeover via terminal, bus or PC is not possible, if C988 > 0!
- C988 is not the same in all parameter sets.

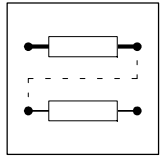

7.5 Control functions

7.5.1 Speed range (f_{dmin} , f_{dmax})

Code	Name	Possible settings				IMPORTANT	
		Lenze	Choice	Info			
C010	Minimum field frequency	820X	0.00	0.00	{0.05 Hz}	480.00	
		821X/822X/824X	0.00	0.00	{0.02 Hz}	480.00	
C011	Maximum field frequency	820X	50.00	30.00	{0.05 Hz}	480.00	
		821X/822X/824X	50.00	7.50	{0.02 Hz}	480.00	

Function The speed range required for the application can be selected via the input of field frequencies f_{dmin} and f_{dmax} :

- f_{dmin} corresponds to the speed at 0 % speed setpoint selection.
- f_{dmax} corresponds to the speed at 100 % speed setpoint selection.

Adjustment Relation between field frequency and synchronous motor speed:

$$n_{Nsyn} = \frac{f_{dmax} \cdot 60}{p}$$

n_{Nsyn} Synchronous motor speed [min^{-1}]

f_{dmax} Max. field frequency [Hz]

p No. of pole pairs (1, 2, 3, ...)

Example: 4 pole asynchronous motor:

$p = 2$, $f_{dmax} = 50$ Hz

$$n_{Nsyn} = \frac{50 \cdot 60}{2} = 1500 \text{ min}^{-1}$$

Important

- With the setting $f_{dmin} > f_{dmax}$ the field frequency is limited to f_{dmax} .
- With setpoint selection via JOG values, f_{dmax} acts as limitation.
- f_{dmax} is an internal normalisation variable:
 - Use the LECOM interface only for important modifications, when the controller is inhibited.
- Observe the maximum speed of the motor!
- f_{dmin} is only effective:
 - With analog setpoint input.
 - With the motor potentiometer function "DOWN".

Special features

820X

- With field frequencies $f_d > 240$ Hz:
 - The overcurrent switch-off can be activated.

821X/822X/824X

- With field frequencies $f_d > 300$ Hz:
 - Avoid chopper frequencies < 8 kHz.
- The display value of f_{dmin} and f_{dmax} can be related to an application datum using C500 and C501.

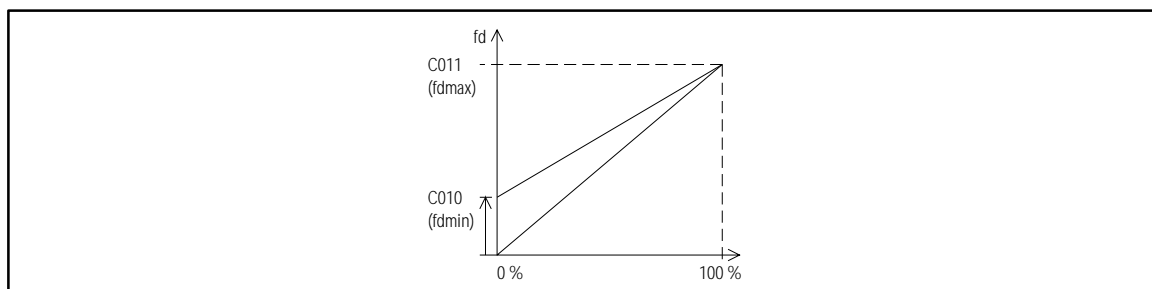

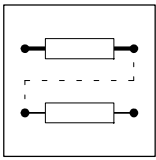

Configuration

7.5.2 Acceleration and deceleration times T_{ir} , T_{if}

Code	Name	Possible settings				IMPORTANT	
		Lenze	Choice	Info			
C012	Acceleration time T_{ir}	820X	5.00	0.00	{0.05 s}	999.00	
		821X/822X/ 824X	5.00	0.00	{0.02 s}	999.00	
							0.00
C013	Deceleration time T_{if}	820X	5.00	0.00	{0.05 s}	999.00	
		821X/822X/ 824X	5.00	0.00	{0.02 s}	999.00	
							0.00

Function The acceleration and deceleration times determine the controller response after a setpoint change.

Adjustment

- The acceleration and deceleration times refer to a change of the field frequency from 0 Hz to the max. field frequency set under C011.
- Calculate the times T_{ir} and T_{if} , which must be set under C012 and C013.
 - t_{ir} and t_{if} are the times desired for the change between f_{d1} and f_{d2} :

$$T_{ir} = t_{ir} \cdot \frac{f_{dmax}}{f_{d2} - f_{d1}} \qquad T_{if} = t_{if} \cdot \frac{f_{dmax}}{f_{d2} - f_{d1}}$$

Important

Under unfavourable operating conditions, too short acceleration and deceleration times can lead to the deactivation of the controller with the indication of TRIP OC5. In these cases, the acceleration and deceleration times should be short enough that the drive can follow the speed profile without reaching I_{max} of the controller.

Special features

820X The slope is adjustable between 0.095 Hz/s and 780 Hz/s.

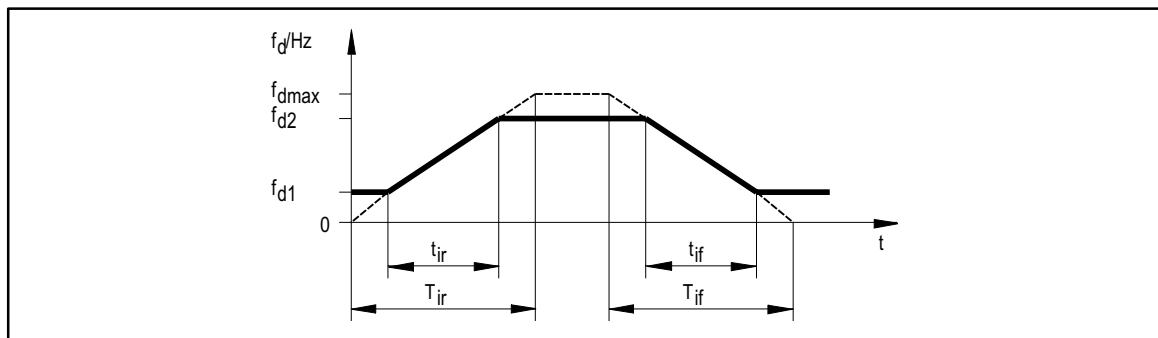

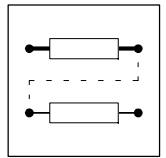

7.5.3 Current limit values (I_{\max} limit values)

Code	Name	Possible settings				IMPORTANT
		Lenze	Choice		Info	
C022	I_{\max} limit (motor mode)	150	30	{1 %}	150	
C023	I_{\max} limit (generator mode)	80	30	{1 %}	110	
	822X/824X	80	30	{1 %}	150	as of software 1.6 and HVAC

Function The controllers are equipped with a current-limit control which determines the dynamic response under load. The measured load is compared with the limit values set under C022 for motor load and under C023 for generator load. If the current limits are exceeded, the controller changes its dynamic behaviour.

Series "HVAC":

- C023 = 30 %
 - Current limit controller for generator mode not active (only for applications with special machines running at high field frequencies at the same time).
 - Only possible with control mode V/f-characteristic control (C014 = -2-) (see chapter 7.5.5).
- C023 = 30 % or C023 = 149 %
 - Earth-fault detection not active.

Adjustment Set the acceleration and deceleration times so that the drive can follow the speed profile without reaching I_{\max} .

Controller behaviour when reaching the limit value

- During acceleration:
 - Increase of the acceleration ramp
- During deceleration:
 - Increase of the deceleration ramp
- With increasing load and constant speed:
 - When reaching the motor-current limit value:
 - Decrease of the field frequency to 10 Hz at 820X
 - 0 Hz at 821X/822X/824X.
 - When reaching the generator-current limit value:
 - Increase of the field frequency to the max. frequency (C011).
 - Stop the field-frequency change if the load falls below the limit value.

Important

821X/822X/824X

- A correct current control in the generator mode is possible only with a connected brake unit or in the DC-bus connection with energy exchange.
- For operation with chopper frequencies > 8 kHz, the current limit values should be set to the currents " I_{\max} for 60 s" indicated in the rated data (see chapter 3.4). (Derating at higher chopper frequencies)

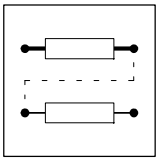

Configuration

7.5.4 Current limitation controller (I_{\max} controller)

Only "HVAC" controllers

Code	Name	Possible settings			IMPORTANT
		Lenze	Choice	Info	
C077*	Gain (V_p) I_{\max} controller	0.25	0.00 {0.01} 1.00		
C078*	Integral action time (T_i) I_{\max} controller	65	12 {1 ms} 9990		

Function

For power control, the I_{\max} controller can be adjusted under C077 and C078.
The following values for V_p and T_i are internally set if C077 and C078 are factory set:

Control mode	I_{\max} controller works internally with		Setting for	
	V_p	T_i	C077	C078
C014 = -2-, -3-	0.25	65 ms	0.25	65 ms
C014 = -4-	0.5 *	87 ms *	0.25	65 ms

* Internally converted with a factor

Adjustment

The I_{\max} controller is factory set to stability.
For power control of extreme masses set the following:

- C014 = -2- or C014 = -3- (characteristic control)
- V_p and T_i are to be rated as follows:
 - C077 = 0.06
 - C078 = 750 ms

Important

C077 and C078 are only stored in parameter set 1.

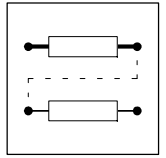

7.5.5 Control mode

Code	Name	Possible settings			IMPORTANT
		Lenze	Choice	Info	
C014 ↓	Control mode	820X	-0-	Linear characteristic $V \sim f_d$ with auto boost	
			-1-	Square characteristic $V \sim f_d^2$ with auto boost	
		-2-	Linear characteristic $V \sim f_d$ with constant V_{min} boost		
		-3-	Square characteristic $V \sim f_d^2$ with constant V_{min} boost		
	821X/822X/824X	-4-	-4-	Motor-current control	

Function

Under C014 you can set the control mode and the voltage characteristic. It is also possible to adapt your drive to different load characteristics:

- Linear characteristic for drives with constantly increasing load torques in relation to the speed
 - Square-law characteristics for drives with a load torque squared in relation to the speed
- Square-law V/f characteristics are mainly used for centrifugal pump and fan drives. It is however necessary to check whether your individual pump or fan application can be driven with this control mode.
- If your pump or fan drive cannot be operated with a square-law V/f characteristic, you should select the control mode C014 = -0-, -2- or -4-.

820X

V/f-characteristic control with auto boost

The control mode mentioned above enables low-loss operation of stand-alone drives with three-phase AC standard asynchronous motors with load dependent V_{min} boost.

C014 = -0-
Linear characteristic

C014 = -1-
Square characteristic
(e.g. for pumps, fans)

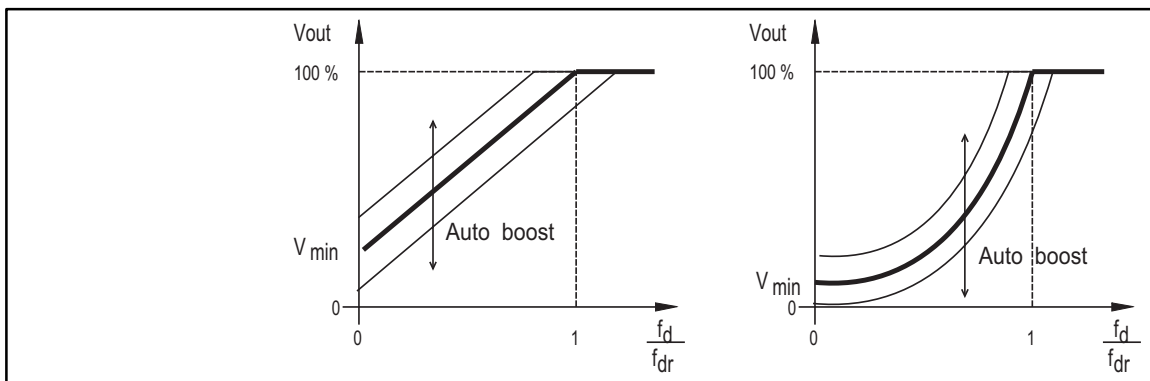

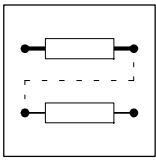

Configuration

820X
821X
822X
824X

V/f-characteristic control with V_{\min} boost

Select the classical V/f-control with constant V_{\min} boost to operate the following drives:

- Multi-motor applications (several motors connected to one controller)
- Three-phase AC reluctance motors
- Three-phase sliding rotor motors
- Operation with special motors with assigned frequency-voltage characteristic
- Positioning and infeed drives with high dynamic response
- Hoists

C014 = -2-
Linear characteristic

C014 = -3-
Square characteristic
(e.g. for pumps, fans)

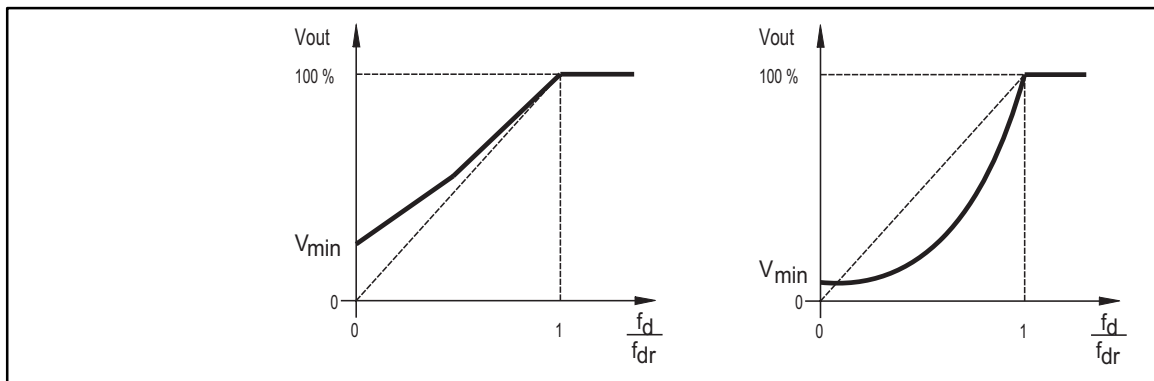

821X
822X
824X

Motor-current control

Compared with the V/f-characteristic control the motor-current control offers considerably higher torque and reduced current consumption during idle running. Select the motor-current control for operation with the following drives:

- Single drives with extremely variable loads
- Single drives with heavy start conditions
- Multi-motor applications with the same motors and the same load distribution
- Sensorless speed control of standard three-phase AC motors together with slip compensation (C021)

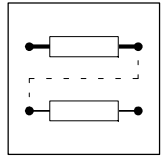

Adjustment

C014 = -0- or C014 = -1-:

1. Select V/f-rated frequency C015
2. Select V_{\min} boost C016

C014 = -2- or C014 = -3-:

1. Select V/f-rated frequency C015
2. Select V_{\min} boost (C016)

C014 = -4-

- Drives with matching four-pole standard motors need not be adapted. The data are save in the factory setting. After having started the drive, the controller itself detects all further motor data.
- Drives with non matching motors must be optimised. Non-matching motors have the following features.
 - Rated motor power $> 1.4 \cdot$ rated inverter power
 - Rated motor power $< 0.6 \cdot$ rated inverter power
 - Operation with 2, 6, 8, 10 and 12-pole standard motors
 - Operation with special motors

The drive can be optimised by entering motor data under C088/C091.

- The control mode C014 = -4- should only be used with the slip compensation. The "sensorless speed control" is thus optimised for the process.
- The idle current of the motor (magnetising current) must not exceed the rated current of the controller.
- The power code of the connected motor should not be more the two classes lower than the one of the motor assigned to the controller.

Important

The change from V/f-characteristic control to motor-current control should only be carried out when the controller is inhibited.

Special features

821X/822X/824X

Control mode motor-current control C014 = -4-

- Motor-current control (factory setting) is **not** possible if
 - drives with different loads are connected to an inverter,
 - drives with different rated powers are connected to an inverter,
 - you use motor chokes, motor filters, sine filters or sine-interference suppression filters.
- With very small friction values, a phase offset of up to 180° occurs at the motor shaft when enabling the controller.

Control mode square characteristic $V \sim f_d^2$ (C014 = -3-)

- High inertias result in a reduced acceleration of the drive.
 - This behaviour can be avoided by changing the parameter sets (e.g. acceleration with C014 = -2-).

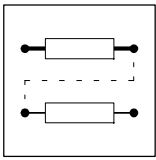

Configuration

7.5.6 V/f characteristic

7.5.6.1 V/f-rated frequency f_{dr}

Code	Name	Possible settings				IMPORTANT	
		Lenze	Choice	Info			
C015	V/f-rated frequency						
		820X	50.00	30.00	{0.05 Hz}	960.00	
		821X/822X/ 824X	50.00	7.50	{0.02 Hz}	960.00	

Function when
C014 = -0-, -1-, -2-, -3-

The V/f-rated frequency determines the slope of the V/f characteristic and has considerable influence on the current, torque and power performance of the motor.

Adjustment

Calculate the frequency to be set under C015
820X:

$$C015 \text{ [Hz]} = \frac{230 \text{ V}}{V_{\text{motor}} \text{ [V]}} \cdot \text{rated motor frequency [Hz]}$$

821X/822X/824X:

$$C015 \text{ [Hz]} = \frac{400 \text{ V}}{V_{\text{motor}} \text{ [V]}} \cdot \text{rated motor frequency [Hz]}$$

C014 = -2-
Linear characteristic

C014 = -3-
Square characteristic
(e.g. for pumps, fans)

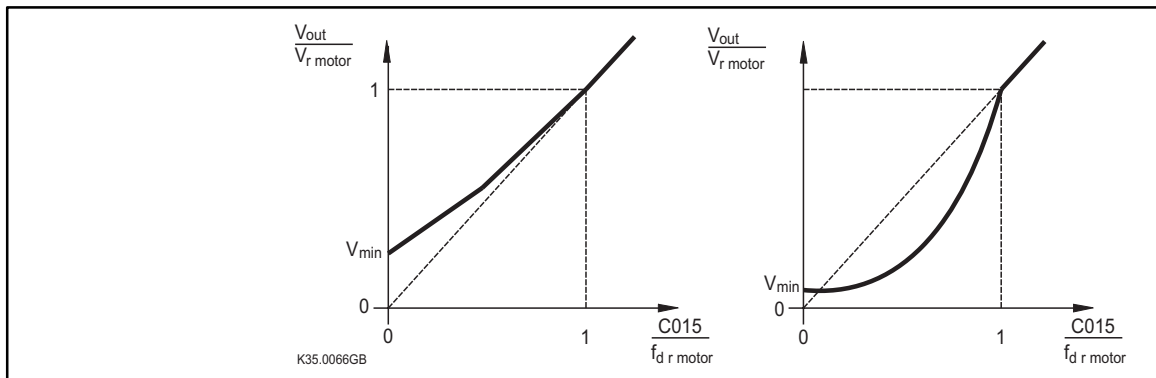

Important

An internal mains voltage compensation compensates deviation in the mains during operation. Therefore, they do not have to be considered for the setting of C015.

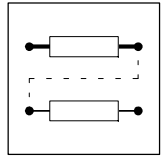

Function when C014 = -4- The V/f-rated frequency influences the internal parameters of the motor model when using the control mode "motor current control".

Adjustment

Setting of C015	Motor connection	Motor voltage	Rated motor frequency
50 Hz	Y	230/400 V	50 Hz
52.6 Hz	Y	220/380 V	50 Hz
50 Hz	Y	280/480 V	60 Hz
50 Hz	Δ	400/690 V 400 V Δ	50 Hz 50 Hz
87 Hz	Δ	230/400 V 280/480 V	50 Hz 60 Hz
90.9 Hz	Δ	220/380 V	50 Hz



Note!

- 4-pole asynchronous motors, which are designed for a rated frequency of 50 Hz at 230 V in star connection, can be operated in delta connection when being constantly excited up to 87 Hz at 400 V.
 - The motor current and the motor power are then increased by the factor $\sqrt{3} = 1.73$.
 - The field weakening range begins above 87 Hz.
- Advantages:
 - Higher speed-setting range
 - 73 % higher power efficiency with standard motors.
 - Improved motor cooling in the lower speed range with self-ventilated motors.
- In principle, this method can also be used with higher-pole motors (6, 8, ...).
 - Observe the mechanical speed limit when using 2-pole asynchronous motors.

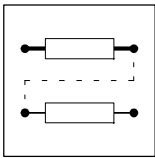

Configuration

7.5.6.2 V_{min} setting

Code	Name	Possible settings				IMPORTANT	
		Lenze	Choice	Info			
C016	V_{min} setting	820X	*	0.00	{0.05 %}	40.00	* depends on the unit
		821X/822X/ 824X	0.00	0.00	{0.02 %}	40.00	

Function when
C014 = -0-, -1-

Load-dependent boost of the motor voltage in the field frequency range below the V/f-rated frequency. C016 acts as gain factor of the auto-boost function (only with 820xE).

Adjustment

As known from experience, an adjustment is not required when having the conditions mentioned above.

An optimisation can be advantageous

for drives with very high starting torques:

1. Operate motor under load.
2. Select the frequency setpoint.
3. Increase V_{min} until the required motor current (torque) occurs.
 - If the setting of V_{min} is too high, a positive-feedback effect can occur and activate the TRIP "overcurrent" (OCx).

for drives with square load torques (fans, pumps):

1. Operate motor under load.
2. Select the frequency setpoint.
3. Adapt V_{min} until the drive runs steadily and smoothly over the whole frequency range.
 - If the setting of V_{min} is too high, the TRIP "overcurrent" (OCx) can be activated and lead to an excessive motor temperature.

for drives with special motors:

1. Operate motor under load.
2. Select the frequency setpoint.
3. Increase V_{min} until the required motor current (torque) occurs.
 - If the setting of V_{min} is too high, a positive-feedback effect can occur and activate the TRIP "overcurrent" (OCx).
4. Check the current consumption during idle running when no load is applied.

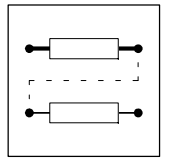

Function when C014 = -2-, -3-

Load-independent boost of the motor voltage in the field frequency range below the V/f-rated frequency. Thus, the torque performance of the inverter drive can be optimised.

Adjustment

It is absolutely necessary to adapt C016 to the asynchronous motor used. Otherwise, the motor might be destroyed by overtemperature or the inverter might be driven with overcurrent.

1. Operate the motor in idle running with a slip frequency of $f_d \approx$:

- $P_{\text{mot}} \leq 7.5 \text{ kW}$: $f_d \approx 5 \text{ Hz}$
- $P_{\text{mot}} > 7.5 \text{ kW}$: $f_d \approx 2 \text{ Hz}$

Slip-frequency calculation

$$f_s = f_{\text{dr}} \cdot \frac{n_{\text{NSyn}} - n_r}{n_{\text{NSyn}}}$$

$$n_{\text{NSyn}} = \frac{f_{\text{dr}} \cdot 60}{p}$$

f_s	Slip frequency
f_{dr}	Rated frequency to motor nameplate [Hz]
n_{NSyn}	Synchronous motor speed [min^{-1}]
n_r	Rated speed to motor nameplate [min^{-1}]
p	Number of pole pairs

2. Increase V_{min} until the following motor current is reached:

- Motor in short-term operation at $0 \text{ Hz} \leq f_d \leq 25 \text{ Hz}$:

Self-ventilated motors: $I_{\text{motor}} \leq I_{r \text{ motor}}$

Forced-ventilated motors: $I_{\text{motor}} \leq I_{r \text{ motor}}$

- Motor in continuous operation at $0 \text{ Hz} \leq f_d \leq 25 \text{ Hz}$:

Self-ventilated motors: $I_{\text{motor}} \leq 0.8 \cdot I_{r \text{ motor}}$

Forced-ventilated motors: $I_{\text{motor}} \leq I_{r \text{ motor}}$

Important

The change from V/f-characteristic control to motor-current control should only be carried out when the controller is inhibited.

Observe the thermal performance of the connected asynchronous motor at low field frequencies when adjusting it:

- Usually, standard asynchronous motors with insulation class B can be driven for a short time with rated frequency within the frequency range $0 \text{ Hz} \leq f_d \leq 25 \text{ Hz}$.
- Contact the manufacturer for exact setting values for the max. permissible motor current in the lower frequency range of self-ventilated motors.

Function when C014 = -4-

V_{min} is not effective when using the control mode "motor current control".

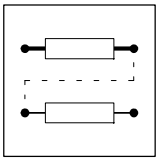

Configuration

7.5.7 Configuration

Only "HVAC" controllers

Code	Name	Possible settings			IMPORTANT	
		Lenze	Choice	Info		
C005 ↙	Configuration	-0-	-0-	Operation with open-loop control via terminal 8	If C005 = -0- • 2 ms cycle time If C005 = -1- ... -7- • 4 ms cycle time	
			-1-	Operation with open-loop control via terminal 8 with setpoint summation via frequency input E1		
			-2-	Operation with open-loop control via frequency input E1 with setpoint summation via terminal 8		
			-3-	Open-loop operation via frequency input E1 with apparent current limitation via terminal 8		C005 = -3- possible with C014 = -2-, -4-
			-6-	Operation with closed-loop control; setpoint via terminal 8 with digital frequency feedback via terminal E1		
-7-	Closed-loop operation; setpoint via frequency input E1 with analog feedback via terminal 8					

Function

The signal flow in the controller can be changed under C005. The functionality of the controller will be changed when changing C005. The signal-flow charts in chapter 16.3 show the structure for each configuration.

Special features

The selection C005 = -4-, -5- cannot be used.

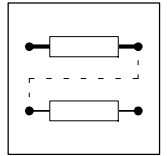

7.5.8 Motor data detection

820X setting range: Function not available.

Setting range 821X/822X/824X:

Code	Name	Possible settings			IMPORTANT
		Lenze	Choice	Info	
C088	Rated motor current 821X/822X/824X	*	0.0 ... 1.2 · rated output current 0.0 ... 2.0 · rated output current	HVAC only	* depends on the unit
C091	Motor cos φ 821X/822X/824X	*	0.4 {0.1} 1.0		* depends on the unit

Function Is used to adapt not matching motors, special motors, etc.

Adjustment Enter the rated current and cos φ of your motor.

Important

- The motor data detection is only effective with the control mode C014 = -4-.
- Drives with matching 4 pole standard motors 230/400 V in star connection do not need to be adapted. After having started the drive, the controller itself detects all further motor data.
- The following drives can be optimised by entering the nameplate data "rated motor current" and "cos φ " under C088 or C091:
 - Motor, one power class smaller than the motor assigned to the controller.
 - Motor, one or two power classes smaller than the motor assigned to the controller.
 - Drives with 2, 6, 8, 10 and 12 pole standard motors.
 - Drives with special motors.

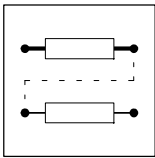

Configuration

7.5.9 Running optimisation

7.5.9.1 Slip compensation

Code	Name	Possible settings				IMPORTANT
		Lenze	Choice	Info		
C021	Slip compensation					
		820X	0.0	0.0 {0.1 %}	12.0	
		821X/822X/ 824X	0.0	0.0 {0.1 %}	50.0	* With C014 = -2-, -3-, controller dependent
			0.0 {0.1 %}	20.0	* With C014 = -4-	

Function

Under load, the speed of an asynchronous machine is reduced. This load-dependent speed reduction is called slip. The slip can be partly compensated by setting C021 accordingly. The slip compensation is effective with all control modes (C014).

- C021 < 0 (with C014 = -2-, -3-)
 - "Smoother" drive characteristic, if strong load shock occur or application of several motors.
- In the field frequency range between 5 Hz ... 50 Hz (87 Hz), the deviation of the rated speed is ≤ 1 % (guide value). In field-weakening operation, the fault increases.

Adjustment

1. Rough setting of the slip constants (C021) by using the motor data:

$$s = \frac{n_{Nsyn} - n_r}{n_{Nsyn}} \cdot 100 \%$$

$$n_{Nsyn} = \frac{f_{dr} \cdot 60}{p}$$

s	Slip constant (C021) [%]
n_{Nsyn}	Synchronous motor speed [min^{-1}]
n_r	Rated speed to motor nameplate [min^{-1}]
f_{dr}	Rated frequency to motor nameplate [Hz]
p	No. of pole pairs (1, 2, 3, ...)

2. Empirical precise setting of the slip compensation:

- Correct C021 until no load-dependent speed drop occurs in the required speed range between idle running and max. motor load.

3. Example:

- Motor data: 4 kW / 1435 min^{-1} / 50 Hz

$$n_{Nsyn} = \frac{50 \text{ Hz} \cdot 60}{2} = 1500 \text{ min}^{-1}$$

$$s = \frac{1500 \text{ min}^{-1} - 1435 \text{ min}^{-1}}{1500 \text{ min}^{-1}} \cdot 100 \% = 4.33 \%$$

Preset C021 = 4.33 %

Important

If C021 is set too high, overcompensation can occur and lead to an instability of the drive.

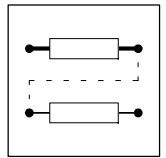

7.5.9.2 Chopper frequency

820X setting range: Fixed chopper frequency up to 9.2 kHz.
Automatic lowering of the chopper frequency is not possible.

Setting range 821X/822X/824X:

Code	Name	Possible settings			IMPORTANT
		Lenze	Choice	Info	
C018↓	Chopper frequency 821X/822X/824X	-1-	-0- 4 kHz -1- 8 kHz -2- 12 kHz -3- 16 kHz -4- 12 kHz reduced noise emission -5- 16 kHz reduced noise emission -4- 4 kHz reduced noise emission -5- 8 kHz reduced noise emission -6- 12 kHz reduced noise emission -7- 16 kHz reduced noise emission	HVAC only HVAC only HVAC only HVAC only	
C144↓	Chopper-frequency reduction 821X/822X/824X	-1-	-0- No chopper-frequency lowering -1- Automatic chopper-frequency at $\vartheta_{max} - 10\text{ °C}$		

Function C018

With this function, you set the chopper frequency of the inverter. With factory setting, the chopper frequency (C018) is set to 8 kHz. Reasons for other parameter settings may be:

- < 8 kHz:
 - Improved running performance with smaller field frequencies
- > 8 kHz:
 - Reduced noise emission in the connected motor
 - Good sine wave of the motor current for applications with field frequencies > 150 Hz, e.g. middle frequency drives (C018 = -4- or -5-)

Important

With chopper frequencies > 8 kHz, the unit suffers high power losses, which must be compensated by derating the output current. Please observe the indications in chapter 3.4 and the corresponding parameter setting of the current limit under C022/C023 to " I_{max} for 60 s".

- Filters and chokes in the motor cable must meet the requirements of chopper frequency (e.g. sine interference suppression filter, if C018 = -5-). Please observe the notes of the manufacturers.

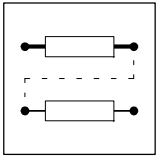

Configuration

Function C144

- C144 = -0-
 - With chopper frequencies of 12 kHz or 16 kHz and if the max. permissible heat sink temperature is exceeded (ϑ_{\max}) because of higher losses, the inverter will be inhibited, TRIP will be indicated and the motors idles.
- C144 = -1- (automatic chopper frequency derating):
 - With chopper frequencies of 12 kHz or 16 kHz, the inverter reduces the chopper frequency automatically to 8 kHz and thus ensures operation, if a heat-sink temperature of $\vartheta_{\max} - 10\text{ °C}$ is exceeded.
 - After the heat sink has cooled down, the chopper frequency is automatically increased again.

Important

- The automatic chopper frequency reduction leads to a higher noise generation compared to the operation with 12 kHz or 16 kHz.
- The current limitation C022/C023 is not automatically influenced by the selected chopper frequency.
- For 822X/824X only if C144 = -1-
 - With chopper frequencies of 8 kHz, 12 kHz or 16 kHz, the controller reduces the chopper frequency automatically to 4 kHz, if the maximum current is exceeded.

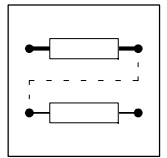

7.5.9.3 Oscillation damping

Setting range 820X/821X: Function not available.

Setting range 822X/824X:

Code	Name	Possible settings			IMPORTANT
		Lenze	Choice	Info	
C079	Oscillation damping				Is not transferred when transferring parameters via the operating module.
		822X/824X	5	0 {1} 80	

Function

Suppression of idling oscillations when:

- a drive does not match, i.e. rated controller power - motor e.g. operation with high chopper frequency and the related power derating,
- operation of higher-pole motors,
- operation of special motors,
- having a resonance phenomenon in the drive set.

Adjustment

1. Approach the area with speed oscillations.
2. Reduce the oscillation by changing C079 step by step.
 - Indicators for smooth running can be a uniform motor current or the reduction of the mechanical vibrations in the bearing seat.

Important

- Parameter transfer from C079 **not** possible via keypad.
- Compensate the resonances in speed controlled operation via the parameters of the controller.

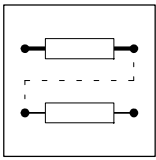

Configuration

7.5.9.4 Ramp function generator S-shape

Only "HVAC" controllers

Code	Name	Possible settings			IMPORTANT
		Lenze	Choice	Info	
C182*	Integration time ramp function generator S-shape	0.00	0.00 {0.01 s} 50.00		

Function An adjustable transmission element (PT1) is connected behind the ramp function generator. The integration time (T_i) is set. It rounds the frequency setpoint. This function enables absolutely smooth starting of the drive.

Adjustment

- C182 = 0.00
 - The ramp function generator work linearly.
- C182 > 0.00
 - The ramp function generator works as S-shape with the time $T_i = C182$.

Important C182 is only stored in parameter set 1.

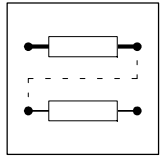

7.5.9.5 Skip frequencies

Only "HVAC" controllers

Code	Name	Possible settings				IMPORTANT
		Lenze	Choice		Info	
C625*	Skip frequency 1	480.00	0.00	{0.02 Hz}	480.00	
C626*	Skip frequency 2	480.00	0.00	{0.02 Hz}	480.00	
C627*	Skip frequency 3	480.00	0.00	{0.02 Hz}	480.00	
C628	Bandwidth of skip frequencies	0.00	0.00	{0.01 %}	100.00	

Function

With certain output frequencies, mechanical resonances might occur in the drive (e.g. fan). The skip frequencies eliminate these unwanted output frequencies. The bandwidth (Δf) determines the range of skip frequencies.

With skip frequency = 480.00 Hz, the function is not active.

The function is within the frequency setpoint range of the ramp function generator.

Adjustment

- Set the required skip frequencies under C625, C626, C627.
- C628 defines the bandwidth of skip frequencies.
 - Calculate the bandwidth (Δf) for the corresponding skip frequency:

$$\Delta f \text{ [Hz]} = \text{Skip frequency [Hz]} \cdot \frac{\text{C628 [\%]}}{100 \%}$$

Important

- The skip frequencies are only effective in the main setpoint channel (see signal flow chart).
- C625, C626, C627, C628 are only stored in parameter set 1.

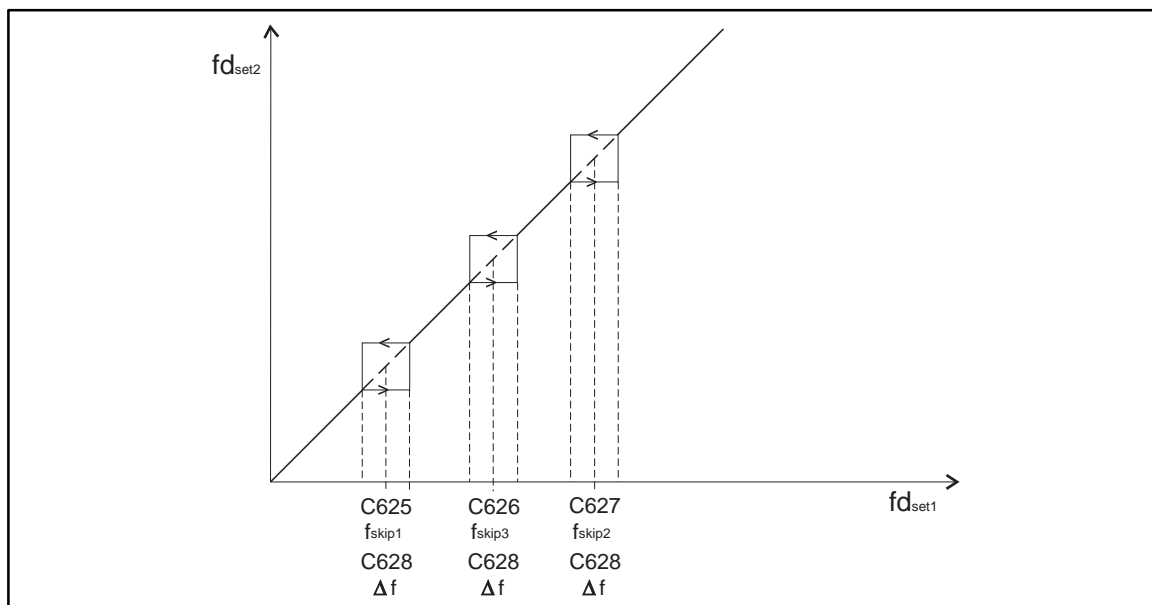
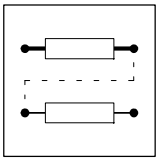

FIG 7-3 Skip frequencies and their bandwidth (Δf)



Configuration

7.5.10 PID controller as process controller

Only "HVAC" controllers

Code	Name	Possible settings			IMPORTANT
		Lenze	Choice	Info	
C070	Gain PID controller	1.00	0.00 {0.01}	300.00	0.0 = P-component not active
C071	Integral action time PID controller	100	10	9999	See table under "Adjustment" 9999 = I-component not active
C072	Differential component PID controller	0.0	0.0 {0.1}	5.0	0.0 = D-component not active
C074	Influence PID controller	0.0	0.0 {0.1 %}	100.0	ref. to C011 (f_{dmax})

Function

The process controller is active with the following configuration:

Configuration	Terminal function
C005 = -6-	Setpoint via terminal 8 (JOG value, motor potentiometer, fieldbus) Actual value via terminal E1
C005 = -7-	Setpoint via terminal E1 (JOG value, motor potentiometer, fieldbus) Actual value via terminal 8

Setpoints

Setpoints can be selected and displayed under the following codes:

Code	Setpoint selection and display
C037	JOG value1 [Hz]
C038	JOG value2 [Hz]
C039	JOG value3 [Hz]
C046	Frequency setpoint [Hz] (Only with keypad 8201BB or interface)
C181	Setpoint PID controller [Hz]

Actual value

The actual value can be displayed under the following codes:

Code	Actual value display
C051	Actual value PID controller [Hz]

A digital frequency can be selected as actual value via terminal E1 (see chapter 4.2.8.3).

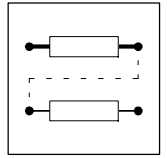

Normalisation

- Adaptation of a field related parameter to an application datum to be controlled (e.g. pressure, temperature, flow rate, humidity, speed) under C500 and C501.
- The following codes are normalised at the same time:
 - C010, C011, C017, C019, C037, C038, C039, C046, C049, C050, C051, C181, C625, C626, C627
- After a normalisation, the output frequency [Hz] (C050) can only be recalculated with the display factors C500 and C501 (see formulas in chapter 7.6.3).
- In factory setting, all field related parameters refer to the frequency. Input and display in Hz. The values of C037, C038, C039, C046, C051, C181 refer to C011.

Factory setting

A percentage of the input or display values corresponds to the frequency in Hz.

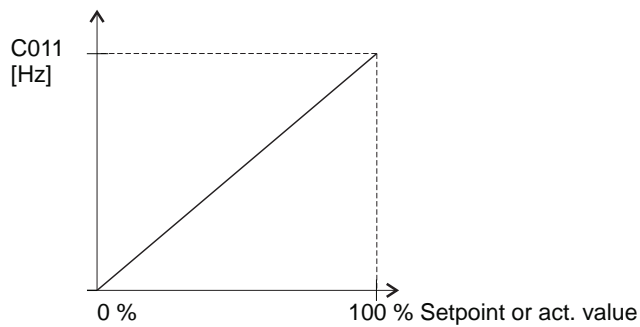

Adjustment

The value set under C071 correspond to the following integral action times T_n .

Values under C071	Integral action time T_n
10 ... 5000	10 ms ... 5000 ms
5000 ... 6000	5 s ... 10 s
6000 ... 7000	10 s ... 100 s
7000 ... 8000	100 s ... 1000 s
8000 ... 9999	1000 s ... 9999 s

Guide values for pressure control and flow rate

The values in the following table are for guidance for pressure and flow-rate controls. A fine adjustment is therefore always necessary.

C070, C071 and C072 must be set so that the target value is

- reached quickly and
- with minimum overshooting

when the setpoints and actual values are changed.

The differential component K_D (C072) is usually not required for pressure and flow-rate controls (set C072 = 0).

Guide values for pressure control and flow rate

Code	Gases	Liquids
C070 (V_p)	0.1	0.02 ... 0.1
C071 (T_n)	5000 (5 s)	200 ... 1000 (0.2 s ... 1 s)

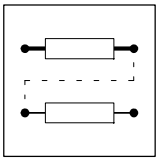

Configuration

Influence PID controller

When using a process control with frequency precontrol (C238 = -1-), the control factor is very important.

- The control factor is calculated from the difference of the values under C050 and C051.
- The control factor determines the influence C074 of the PID controller.
- The influence (C074) refers to f_{dmax} (C011).
- C074 influences the stability of the control circuit. It should be set to a value as low as possible.

The influence C074 [%] is calculated as follows:

$$\text{Influence [\%]} = \frac{C050 - C051}{C011} \cdot 100 \%$$

Example

The influence is to be calculated for the following values:

C011 = 50 Hz, C050 = 53 Hz, C051 = 50 Hz

$$6 \% = \frac{53 \text{ Hz} - 50 \text{ Hz}}{50 \text{ Hz}} \cdot 100 \%$$

- Set the influence so that the output of the process controller covers the calculated value in every operating point.
 - For this example (influence = 6 %) set for instance C074 = 10 %. This is a guide value and includes tolerances which must always be considered.
- If the influence (C074) is too high, the control circuit may become instable.

Additive influence of the process controller

Conditions:

- C051 = Positive actual value
- C181 = Select positive setpoint
- C238 = -1- (with frequency precontrol)
- Potentiometer connections of the dancer
 - End (E) = +10 V
 - Beginning (A) = GND

The direction of control action of the process controller output is added to the main setpoint.

Example of a dancer control with additive influence of the process controller

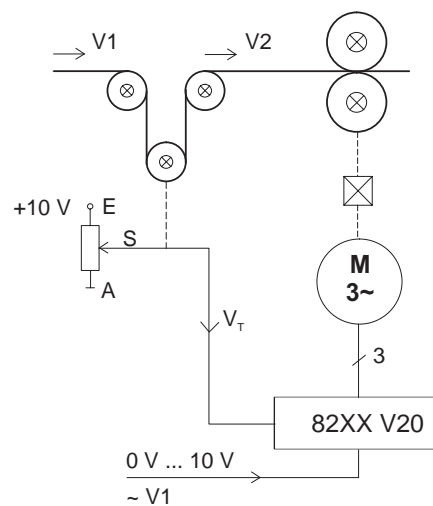

Function:

1. The dancer deflects to the bottom. (V_T decreases)
2. V_2 increases.

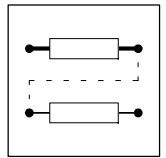

Subtractive influence
of the process controller

Conditions:

- C051 = Positive actual value
- C181 = Select positive setpoint
- C238 = -1- (with frequency precontrol)
- Potentiometer connections of the dancer
 - Beginning (A) = +10 V
 - End (E) = GND

The direction of control action of the process controller is subtracted from the main setpoint.

Example of a dancer control with subtractive
influence of the process controller

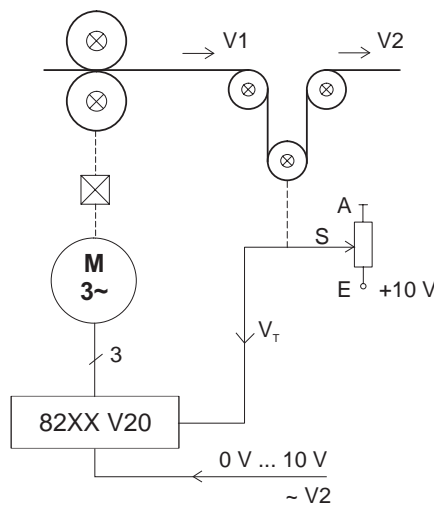

Function:

1. The dancer deflects to the bottom.
(V_T increases)
2. $V1$ decreases.

Important

Caution

The direction of rotation must not be changed, if the process controller is used as speed controller.

- If C070 = 0.0, the proportional component K_P is not active.
- If C071 = 9999, the integral component K_I is not active.
- If C072 = 0.0, the differential component K_D is not active.
- The process controller is not suitable for inverse process control.
(Inverse control means that the speed becomes lower, if the actual value is lower than the setpoint.)

Inverse controls are for instance, vacuum pressure control or humidity controls. Here, the 93XX VECTOR should be used.

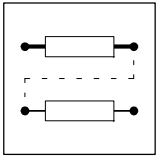

Configuration

7.5.10.1 Reset integral component and influence

- Function** The following functions are possible:
- Reset the integral component K_I of the PID controller via terminal.
 - Set the influence of the PID controller to 0.
- Activation**
- C007 = -28- ... -34-, -48-, -50-, -51-:
- HIGH level at terminal E2
 - Reset of K_I
- C007 = -48-, -49-, -50-:
- HIGH level at terminal E4
 - Reset influence
- The signal levels are indicated for C114 = -0- (see chapter 7.5.14.1)

7.5.10.2 Setpoint selection for the process controller

Code	Name	Possible settings			IMPORTANT
		Lenze	Choice	Info	
C181*	Setpoint PID controller	0.00	-480.00 {0.02 Hz} 480.00		

- Function** Selection of a frequency setpoint, e.g. for
- the dancer position for a dancer control in a line drive,
 - the pressure setpoint in a pressure control.
- Adjustment**
- C181 = 0
- The setpoint of the PID controller is
 - selected externally (terminal 8 or E1),
 - set via the keys (▲, ▼) of the operating module 8201BB.
- C181 \neq 0
- Setpoint selection for the PID controller via this code.
- Important**
- The setpoint selection via this code is only active, if C181 \neq 0.
 - C181 is only stored in parameter set 1.
- Special features**
- The setpoint can also be entered as application datum (C500, C501) (see chapter 7.6.3).

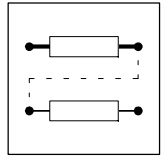

7.5.10.3 Frequency precontrol

Code	Name	Possible settings			IMPORTANT
		Lenze	Choice	Info	
C238↓	Frequency precontrol	-1-	-0- -1-	No precontrol With setpoint precontrol	

Function

C238 = -1-

- The process controller has only limited influence on the process.

The following setpoint precontrol is possible:

A The setpoint of the process controller is derived from the precontrol value (C181 = 0).

- Applications with frequency precontrol are e.g. speed controls.

B The setpoint of the process controller is selected under C181 (C181 ≠ 0).

- Applications are e.g. dancer controls, pressure and flow-rate controls

7.5.10.4 Frequency setting range

Code	Name	Possible settings			IMPORTANT
		Lenze	Choice	Info	
C239↓	Frequency setting range	-0-	-0- -1-	Bipolar Unipolar	

Function

C239 = -0-

- Allows both directions of rotations for the control process.

C239 = -1-

- Allows only one direction of rotation for the control process.

Application with frequency setting range are, for instance:

- Fan controls
- Dancer controls

Important

Only if C005 > -0-, C239 has an influence.

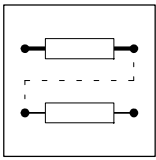

Configuration

7.5.11 Setpoint input

7.5.11.1 Analog setpoint input

Code	Name	Possible settings			IMPORTANT
		Lenze	Choice	Info	
C026	Offset adjustment analog input	0.00	-10.00 {0.01 V} 10.00	HVAC only	Not effective with C005 = -0-
C027	Scaling factor of analog input	100.0	-200.0 {0.1 %} 200.0	HVAC only	Not effective with C005 = -0-
C034 ↙	Master current	-0-	-0- 0 mA ... 20 mA / 0 V ... 5 V / 0 V ... 10 V -1- 4 mA ... 20 mA		

Function

An analog setpoint signal can be selected via terminal 8.

- You can select different setpoint ranges by reconnection of the jumper at the front of the controller.
- Inverse setpoint input because of negative terminal adjustment.
- Offset adjustment of the analog channel (only series "HVAC")

Adjustment

Setpoint range	Jumper position
0 mA ... 20 mA / 4 mA ... 20 mA	5 - 6
0 V ... 5 V	3 - 4
0 V ... 10 V	1 - 2 (Factory setting)

To select the setpoint by means of the master current, you change the ranges under C034:

C034 = -0- 0 mA ... 20 mA
C034 = -1- 4 mA ... 20 mA

Important

- With an internal reference voltage of 5 V:
- Plug in the jumper at position 3-4
- If the setpoint is input by means of a master voltage 0 V ... 5 V / 0 V ... 10 V:
- Set C034 = -0-
- Analog setpoint input is not possible with setpoint input via the function "Motor potentiometer" (C007 = -10-, -11-, -12-, -13-, -21-).

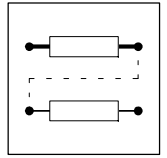

Only series "HVAC":

Adjustment

Scaling factor of the analog channel via C027:

- C027 = 0.0 % ... 200.0 %
 - Set-value input
- C027 = -200.0 % ... -0.1%
 - Inverse setpoint input

Offset adjustment of the analog channel via C026:

The adjustment of -10.00 V ... +10.00 V refers to an input voltage of 10 V.

Setpoint input

C034 = -0-, C027 > 0 %

Offset adjustment via C026

Inverse setpoint input

C034 = -0-, C027 < 0 %

Offset adjustment via C026

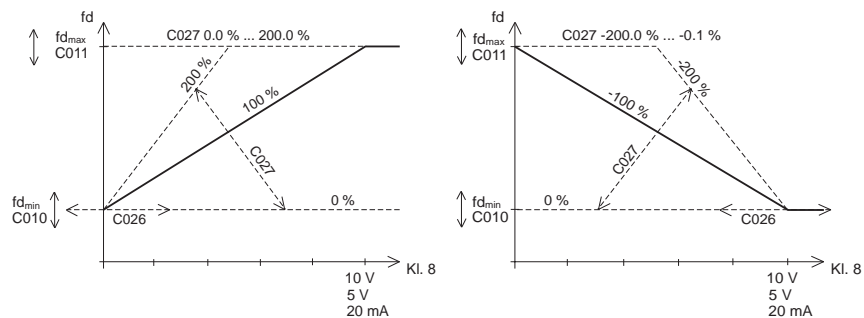

Calibration when using a PID controller

If, for instance, the control range of a pressure control (C0005 = -6-) is to be limited to a value lower than the rated sensor value, the effective pressure setpoint can be proportionally reduced under C0027.

Example:

- Pressure sensor 0 - 200 mbar (= P_r) at E1.
- Analog input of the pressure setpoint via terminal 8.
- The max. pressure is to be limited to 120 mbar under C0027:

$$C0027 = \frac{P_1}{P_r} \cdot 100 \% = \frac{120 \text{ mbar}}{200 \text{ mbar}} \cdot 100 \% = 60 \%$$

Important

- With C026 < 0 V, f_{dmin} can fall below the value set under C010.
- With C005 = -0-, C026 and C027 are not active.
- C026 and C027 are only stored in parameter set 1.
- For terminal configurations with manual/remote changeover (C007 = -23- ... -27-):
 - Change between motor potentiometer and manual/remote changeover via terminal (E1 ... E4).
- For terminal configurations with manual/remote changeover (C007 = -23- ... -27-, -46-) and the control mode LECOM (C001 = -3-):
 - Change between setpoint via master current (C046, process setpoint) and setpoint input possible via terminal (E1 ... E4).

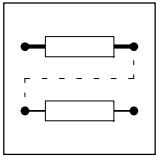

Configuration

7.5.11.2 Setpoint input using the keypad

Function	If you select the operating mode C001 = -1-, the setpoint can be selected by means of the keypad of the operating module.
Adjustment	<ol style="list-style-type: none">1. Press key ▲ or ▼.2. The display changes and indicates the current setpoint together with SET.3. Set the setpoint using ▲ or ▼.<ul style="list-style-type: none">- If the controller is enabled, the changed setpoint has a direct effect on the drive.- The setpoint is saved when the controller is inhibited. After the controller has been enabled, the drive accelerates or decelerates to the last setpoint.
Important	<p>Setpoints selected by means of the keypad are saved when separating the controller from the mains or interrupting the operation. The drive can start again after controller enable!</p> <p>Observe the start conditions under C142:</p> <ul style="list-style-type: none">• Series "Standard": See chapter 7.8, "Code table".• Series "HVAC": See chapter 7.9, "Code table".

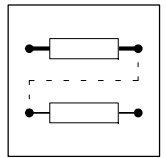

7.5.11.3 Setpoint input via JOG frequencies

Code	Name	Possible settings			IMPORTANT
		Lenze	Choice	Info	
C037	JOG value 1	20.00	0.00	{0.02 Hz} 480.00	
			-480.00	{0.02 Hz} 480.00	HVAC only
C038	JOG value 2	30.00	0.00	{0.02 Hz} 480.00	
			-480.00	{0.02 Hz} 480.00	HVAC only
C039	JOG value 3	40.00	0.00	{0.02 Hz} 480.00	
			-480.00	{0.02 Hz} 480.00	HVAC only

Function

The setpoint input via JOG frequencies is only active, if C007 is set accordingly (series "Standard": see chapter 7.8, "Code table"; series "HVAC": see chapter 7.9, "Code table").

Activate

- JOG value 1 via control terminal E1 or
- binary coded up to three JOG frequencies via the control terminals E1 and E2.

Activation

Series "Standard":

- C007 = -3-, -4-, -5-, -6-, -9-, -14-, -15-, -20-, -22-:

Function	E1
Other setpoint source	LOW
JOG 1 active	HIGH

- C007 = -0-, -1-, -2-, -16-:

Function	E1	E2
Other setpoint source	LOW	LOW
JOG 1 active	HIGH	LOW
JOG 2 active	LOW	HIGH
JOG 3 active	HIGH	HIGH

Series "HVAC":

- C007 = -0-, ... -6-, -9-, -14-, -15-, -16-, -20-, -22-, -28-, -29-, -30-, -35-, -37- ... -41-, -46-, -47-, -49-, -50-:

Function	EX
Other setpoint source	LOW
JOG 1 active	HIGH

or

Function	E1 (E3)	E2 (E4)
Other setpoint source	LOW	LOW
JOG 1 active	HIGH	LOW
JOG 2 active	LOW	HIGH
JOG 3 active	HIGH	HIGH

Important

- The setting of f_{dmax} (C011) limits the field frequency also for JOG values.
- The setting of f_{dmin} (C010) is not effective for setpoint input by means of JOG values.

Special features

The display value of the parameter can be related to an application datum (C500, C501) (see chapter 7.6.3).

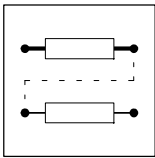

Configuration

7.5.11.4 Setpoint input via function "Motor potentiometer"

Function

The setpoint input via the function "Motor potentiometer" is only active, if C007 is set accordingly. (Series "Standard": see chapter 7.8, "Code table"; series "HVAC": see chapter 7.9, "Code table"). The field frequency is changed via the set acceleration and deceleration times.

Activation

Series "Standard":

- C007 = -10-, -11-, -12-, -13-, -21-:

Function	E1	E2
Setpoint = 0 Hz	LOW	LOW
Reduce setpoint until f_{dmin}	HIGH	LOW
Increase setpoint until f_{dmax}	LOW	HIGH
Setpoint remains constant	HIGH	HIGH

Series "HVAC":

- C007 = -10-, -11-, -12-, -13-, -21-, -23-, -24-, -25-, -26-, -27-, -44-:

Function	E1	E2	E3 ³⁾	E4 ³⁾
Setpoint = 0 Hz (T_{IQSP} C105) ¹⁾	LOW	LOW	LOW	LOW
Reduce setpoint until f_{dmin} (T_{ifr} C013) ²⁾	HIGH	LOW	HIGH	LOW
Increase setpoint until f_{dmax} (T_{ifr} C012)	LOW	HIGH	LOW	HIGH
Setpoint remains constant	HIGH	HIGH	HIGH	HIGH

1) LOW level at terminals E1 and E2 reduces the setpoint along the QSP ramp (C105) until $f_d = 0$ Hz

2) Only possible, if the setpoint has exceeded f_{dmin} before.

3) Only, if C007 = -44-

Activation of the function "Motor potentiometer" via normally-closed contacts

Series "Standard":

C007 = -10- ... -13-, -21-

Series "HVAC":

C007 = -10- ... -13-, -21- ... -27-

C007 = -44-

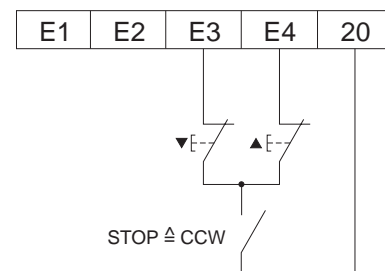
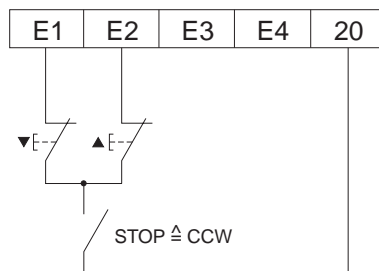

Important

The setpoint is saved

- when switching off the mains,
- when inhibiting the controller,
- when having fault messages.

Exception:

- If the control terminals are set to LOW in the event of mains failure (e.g. external voltage supply), the setpoint 0 Hz will be stored.
- Activation of the QSP function (C007 = -13-, -21-) resets the motor potentiometer to 0 Hz.

Special features

The terminal configuration C007 = -13- provides an open-circuit protection for quick stop.

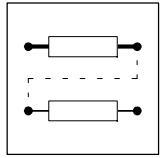

Only series "HVAC":

Level inversion

The function "Motor potentiometer" can be influenced through level inversion.

Example

- C114 = -3-
 - Terminals E1 and E2 are level inverted. The function "Motor potentiometer" is then activated according to the following table:

Function	E1	E2
Setpoint = 0 Hz (T_{iQSP} C105) ¹⁾	HIGH	HIGH
Reduce setpoint until f_{dmin} (T_{if} , C013) ²⁾	LOW	HIGH
Increase setpoint until f_{dmax} (T_{in} , C012)	HIGH	LOW
Setpoint remains constant	LOW	LOW

- 1) HIGH level at terminals E1 and E2 reduce the setpoint via the QSP ramp (C105) until $f_d = 0$ Hz.
- 2) Only possible, if the setpoint has exceeded f_{dmin} before.

Activation of the function "Motor potentiometer" via normally-open contacts.

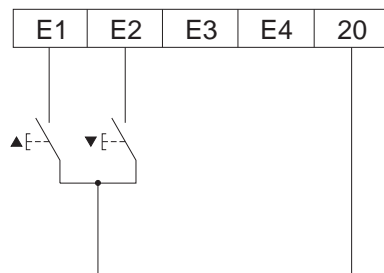

- C007 = -26-
 - The JOG value has priority over the function "Motor potentiometer".

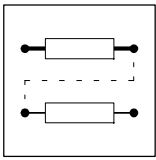

Configuration

7.5.11.5 Setpoint input via function "Motor potentiometer in combination with JOG value"

Function The setpoint input via the function "Motor potentiometer in combination with JOG value" is only active, if C007 is set accordingly (see chapter 7.8, "Code table"). The field frequency is changed:

- For acceleration over acceleration ramp C012.
- For deceleration:
 - via the deceleration ramp C013 (820X controllers),
 - via the quick-stop ramp C105 (821X/822X/824X controllers).

Activation C007 = -22-

Function	Setpoint	K1	K2	K3	K4
DOWN	0 Hz	*	*	1	0
CW rotation	determined by E1/E2	*	*	0	0
CCW rotation	determined by E1/E2	*	*	1	1
UP	f_{dmax} (C011)	0	1	0	0
CONSTANT	constant	0	0	0	0
JOG	JOG value 1 (C037)	1	*	0	0
		* arbitrary			

Important

- In the event of maloperation, i.e. UP = E2 and DOWN = E3 both activated, the controller is set to 0 Hz.
- The field-frequency value activated via the motor-potentiometer function represents the max. limit value for the JOG function E1, i.e. it is not possible to activate a JOG value higher than the last motor-potentiometer value. Smaller values are however possible.
- In the event of mains disconnection (interruption > approx. 10 s) the last motor potentiometer value will not be stored, i.e. the new start value is 0 Hz.
- With CCW rotation (E3 = 1, E4 = 1) the "DOWN" function changes from E3 = 1 to E4 = 0.

Special features The function can be influenced through level inversion of the terminals (C114). (Only series "HVAC")

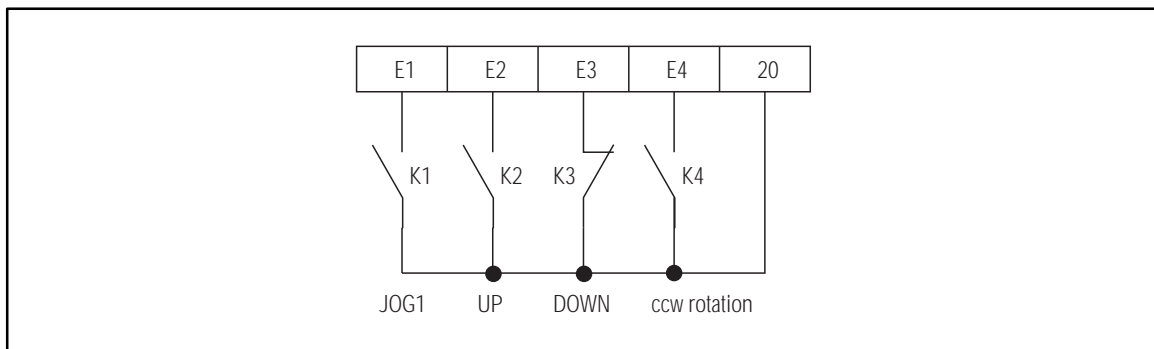
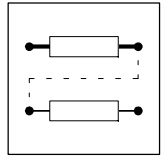

FIG 7-4 Control of the motor-potentiometer function, C007= -22-



7.5.11.6 Setpoint sum

Only "HVAC" controllers

Code	Name	Possible settings			IMPORTANT
		Lenze	Choice	Info	
C049*	Additional setpoint		-480.00 {0.02 Hz} 480.00		Display only

Function

In controlled operation (C005 = -1-, -2-) the setpoint sum can be generated with

- the signal of the analog input (terminal 8) or
- the digital frequency at terminal E1 or
- the function "Motor potentiometer" or
- the process setpoint C046 (LECOM).

The additional setpoint is indicated under C049.

Special features

The display value of the parameter can be related to an application datum (C500, C501). (see chapter 7.6.3)

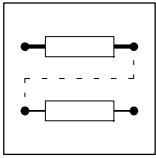

Configuration

7.5.12 Controller enable RFR

Function	Terminal 28 controls the controller enable.
Activation	<ul style="list-style-type: none">• LOW level: Controller inhibited• HIGH level: Controller enabled
Important	<ul style="list-style-type: none">• During operation with the 8201BB operating module, you can inhibit the controller with the STP key and enable it again by pressing the RUN key. Here control terminal 28 and the keypad of the operating module have the same effect as two separate switches connected in series.• For control via a fieldbus module, the controller enable via terminal 28 still has priority.

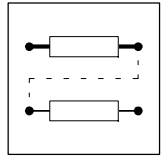

7.5.13 Start conditions/flying-restart circuit

Code	Name	Possible settings			IMPORTANT
		Lenze	Choice	Info	
C142 ↙	Start condition	-1-	-0- Automatic start inhibited, flying-restart circuit not active -1- Automatic start, if term. 28 HIGH, flying-restart circuit not active -2- Automatic start inhibited, flying-restart circuit active -3- Automatic start, if term. 28 HIGH, flying-restart active		

Function Determines the controller performance after mains connection or reconnection. With activated flying-restart circuit, the controller automatically synchronises to a coasting motor after mains disconnection. For this, the controller calculates the output frequency required for the current speed of the coasting motor, the controller is then connected and accelerates the motor to the selected setpoint. Steady and soft deceleration and acceleration is therefore possible.

Drive performance

Start options with flying-restart circuit

- C142 = -0-
- After mains disconnection, the drive does not start before LOW/HIGH level change at the input ctrl. enable (term. 28). The operating module displays AS_LC (Autostart-Lockout).
- C142 = -1-
- After mains disconnection, the drive starts automatically if a HIGH level is assigned to.

Start options with flying-restart circuit

- C142 = -2-
- Start with flying-restart circuit after a LOW/HIGH level change at input ctrl. enable (term. 28). The operating module displays AS_LC.
- C142 = -3-
- Automatic start with flying-restart circuit, if a HIGH level is assigned to ctrl. enable.

Important

- The flying-restart circuit must not be used, if several motors with different inertias are connected to a controller.
- The flying-restart circuit does only search the selected direction of rotation for the synchronisation.
- The flying restart works properly for drives with high moments of inertia.
- Machines with low moments of inertia and small friction:
- With activated flying-restart circuit, the motor can start briefly or reverse from standstill after enabling the controller.

Series "HVAC":

- The flying-restart circuit must only be used during operation with a PID controller, if a speed proportional signal is assigned to C0051!
- With a normalisation to an application datum (see page 7-63), it is absolutely necessary to check whether C0051 contains a speed proportional value.



Note!

If the flying-restart circuit **is not required** for every drive start, but only after mains reconnection:

- bridge terminal 28 and start the controller with the "QSP" function (C142 = -3- and C106 = 0 s),
- the flying-restart circuit is now only **activated** for the first mains connection.

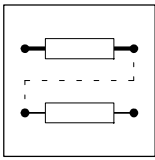

Configuration

7.5.14 Function of the inputs to be configured block by block

	C007	E1	E2	E3	E4
	-0-	JOG 1, JOG 2, JOG 3		DC injection brake	CW/CCW
	-1-	JOG 1, JOG 2, JOG 3		PAR	CW/CCW
	-2-	JOG 1, JOG 2, JOG 3		QSP	CW/CCW
	-3-	JOG 1	DC injection brake	PAR	CW/CCW
	-4-	JOG 1	PAR	QSP	CW/CCW
	-5-	JOG 1	TRIP set	DC injection brake	CW/CCW
	-6-	JOG 1	TRIP set	PAR	CW/CCW
	-7-	TRIP set	DC injection brake	PAR	CW/CCW
	-8-	TRIP set	PAR	QSP	CW/CCW
	-9-	JOG 1	TRIP set	QSP	CW/CCW
	-10-	DOWN	UP	TRIP set	CW/CCW
	-11-	DOWN	UP	DC injection brake	CW/CCW
	-12-	DOWN	UP	PAR	CW/CCW
	-13-	DOWN	UP	QSP	CW/CCW
	-14-	JOG 1	DC injection brake	CW/QSP	CCW/QSP
	-15-	JOG 1	PAR	CW/QSP	CCW/QSP
	-16-	JOG 1, JOG 2, JOG 3		CW/QSP	CCW/QSP
	-17-	DC injection brake	PAR	CW/QSP	CCW/QSP
	-18-	TRIP set	PAR	CW/QSP	CCW/QSP
	-19-	TRIP set	DC injection brake	CW/QSP	CCW/QSP
	-20-	JOG 1	TRIP set	CW/QSP	CCW/QSP
	-21-	DOWN	UP	CW/QSP	CCW/QSP
	-22-	JOG 1	UP	CW/QSP	CCW/QSP
only series "HVAC"	-23-	DOWN	UP	CW/CCW	H/RE
	-24-	DOWN	UP	PAR	H/RE
	-25-	DOWN	UP	DC injection brake	H/RE
	-26-	DOWN	UP	JOG1	H/RE
	-27-	DOWN	UP	TRIP set	H/RE
	-28-	D/F	I-OFF	JOG 1, JOG 2, JOG 3	
	-29-	D/F	I-OFF	DC injection brake	JOG 1
	-30-	D/F	I-OFF	QSP	JOG 1
	-31-	D/F	I-OFF	QSP	DC injection brake
	-32-	D/F	I-OFF	QSP	TRIP set
	-33-	D/F	I-OFF	PAR	QSP
	-34-	D/F	I-OFF	CW/QSP	CCW/QSP
	-35-	D/F	PAR	JOG 1, JOG 2, JOG 3	
	-36-	D/F	PAR	QSP	CCW/QSP
	-37-	D/F	PAR	QSP	CCW/QSP
	-38-	D/F	TRIP set	PAR	CCW/QSP
	-39-	D/F	TRIP set	JOG 1, JOG 2, JOG 3	

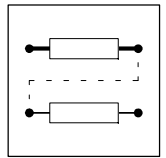

	C007	E1	E2	E3	E4
only series "HVAC"	-40-	D/F	TRIP set	OSP	JOG1
	-41-	D/F	TRIP set	DC injection brake	JOG1
	-42-	D/F	TRIP set	DC injection brake	OSP
	-43-	D/F	TRIP set	OSP	CW/CCW
	-44-	D/F	PAR	DOWN	UP
	-45-	D/F	PAR	OSP	CW/CCW
	-46-	JOG1	OSP	PAR	H/Re
	-47-	JOG1	H/Re	CCW/QSP	CW/QSP
	-48-	D/F	I-OFF	DC injection brake	INFL_0
	-49-	D/F	OSP	JOG1	INFL_0
	-50-	D/F	I-OFF	JOG1	INFL_0
	-51-	D/F	I-OFF	PAR	DCB

Function Depending on your application you can select a function group under C007. A binary signal code at the digital inputs E1 ... E4 activates the functions.

Important Response time of the inputs E1 ... E4:
 820X 16 ... 24 ms
 821X/822X/824X 2.5 ... 4 ms

Special features

820X The digital inputs E1 ... E4 are without function when using the operating mode "Control via LECOM" (C001 = -3-).

821X/822X/824X With the operating mode "Control via LECOM" (C001 = -3-), the functions "TRIP set" and "OSP" remain effective.

Series "HVAC" With the operating mode "Control via LECOM" (C001 = -3-), the functions "TRIP set" and "OSP" remain effective. They can be switched-off with the priority mask (C115).

- The levels for the input terminals can be inverted under C114.
- Use the following terminal configuration, if terminal E1 is used for the setpoint or the act. value: (see chapter 7.5.14.9)
 - C007 = -28- ... -45, -48- ... -51-

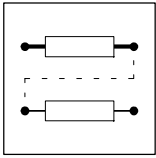

Configuration

7.5.14.1 Level inversion for digital inputs

Only "HVAC" controllers

Code	Name	Possible settings					Info	IMPORTANT
		Lenze	Choice					
C114	Signal level digital inputs	-0-	E4	E3	E2	E1		0: Ex is not inverted 1: Ex is inverted
		-0-	0	0	0	0		
		-1-	0	0	0	1		
		-2-	0	0	1	0		
		-3-	0	0	1	1		
		-4-	0	1	0	0		
		-5-	0	1	0	1		
		-6-	0	1	1	0		
		-7-	0	1	1	1		
		-8-	1	0	0	0		
		-9-	1	0	0	1		
		-10-	1	0	1	0		
		-11-	1	0	1	1		
		-12-	1	1	0	0		
		-13-	1	1	0	1		
		-14-	1	1	1	0		
-15-	1	1	1	1				

Function

The levels of the digital inputs E1 ... E4 can be adapted according to the available signal levels.

Adjustment

Example

Task:

- Terminal configuration C007 = -0- is set.
- The DC-injection brake is to be activated via a LOW level at terminal E3.

Solution:

- Set level inversion C114 = -4-.
 - Terminal E3 reacts on LOW level, the DCB is activated.

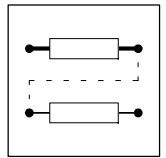

7.5.14.2 Priority mask for digital inputs

Only "HVAC" controllers

Code	Name	Possible settings					Info	IMPORTANT
		Lenze	Choice					
C115	Priority mask digital inputs	-0-	E4	E3	E2	E1		0: Function Ex depends on C001 1: Function Ex is independent of C001
		-0-	0	0	0	0		
		-1-	0	0	0	1		
		-2-	0	0	1	0		
		-3-	0	0	1	1		
		-4-	0	1	0	0		
		-5-	0	1	0	1		
		-6-	0	1	1	0		
		-7-	0	1	1	1		
		-8-	1	0	0	0		
		-9-	1	0	0	1		
		-10-	1	0	1	0		
		-11-	1	0	1	1		
		-12-	1	1	0	0		
		-13-	1	1	0	1		
		-14-	1	1	1	0		
-15-	1	1	1	1				

Function

- Independently of the operating mode C001 = -3- (control via LECOM), it is possible to activate **additional** digital inputs.
 - It is now possible to use additional control functions via terminals E1 ... E4. The signals are assigned by means of an OR link.
- C115 = -0- is always active with terminal configuration (C007) with manual/remote changeover.

Adjustment

Example

The DC injection brake is to be activated via terminal 3:

- Operating mode C001 = -3- (control via LECOM).
- Terminal configuration C007 = -0-.

Solution:

- Set the priority mask C115 = -4-
 - The DC injection brake can now be activated via terminal E3.

Important

- Controller inhibit and TRIP reset always have priority.
- With C115 = -0-, also TRIP set and QSP have priority.

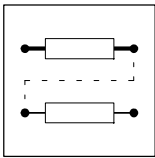

Configuration

7.5.14.3 Change of the direction of rotation (CW/CCW)

	Not failsafe change of the direction of rotation															
Function	<p>Settings C007 = -0- ... -13-, or C007 = -0- ... -13-, -23-, -43-, -45- (only series "HVAC") enable the change of the motor direction via terminal E4. The change depends on</p> <ul style="list-style-type: none"> • the set times T_{ir} (C012) and T_{if} (C013), • the connected ramp function generator S-shape (C182). (Series "HVAC") 															
Adjustment	<p>When connecting the controller in phase</p> <ul style="list-style-type: none"> • a CW field of rotation will occur at LOW signal, • a CCW field of rotation will occur at HIGH level. <p>Series "HVAC": The signal levels are indicated for C114 = -0- (see chapter 7.5.14.1).</p>															
Important	<ul style="list-style-type: none"> • In the event of wire breakage or a failure of the external voltage supply, the direction of rotation can be changed. • CW/CCW changeover only in the main setpoint. 															
	Failsafe change of the direction of rotation															
Function	<p>Settings C007 = -14- ... -22-, or C007 = -14- ... -22-, -34-, -47- (only series "HVAC") enable the failsafe change of the direction of rotation via terminals E3 and E4. The change depends on</p> <ul style="list-style-type: none"> • the set times T_{ir} (C012) and T_{if} (C013), • the connected ramp function generator S-shape (C182). (Series "HVAC") 															
Adjustment	<table border="1" style="width: 100%; border-collapse: collapse;"> <thead> <tr> <th style="text-align: left;">Function</th> <th style="text-align: center;">E3 *</th> <th style="text-align: center;">E4 *</th> </tr> </thead> <tbody> <tr> <td>CCW rotation</td> <td style="text-align: center;">LOW</td> <td style="text-align: center;">HIGH</td> </tr> <tr> <td>CW rotation</td> <td style="text-align: center;">HIGH</td> <td style="text-align: center;">LOW</td> </tr> <tr> <td>Quick stop</td> <td style="text-align: center;">LOW</td> <td style="text-align: center;">LOW</td> </tr> <tr> <td>Unchanged</td> <td style="text-align: center;">HIGH</td> <td style="text-align: center;">HIGH</td> </tr> </tbody> </table>	Function	E3 *	E4 *	CCW rotation	LOW	HIGH	CW rotation	HIGH	LOW	Quick stop	LOW	LOW	Unchanged	HIGH	HIGH
Function	E3 *	E4 *														
CCW rotation	LOW	HIGH														
CW rotation	HIGH	LOW														
Quick stop	LOW	LOW														
Unchanged	HIGH	HIGH														
	<p>*Series "HVAC": The signal levels are indicated for C114 = -0- (see chapter 7.5.14.1).</p>															
Important	<ul style="list-style-type: none"> • If a HIGH signal is assigned to terminals E3 and E4, the terminal signal which was activated first determines the direction of rotation. • If a HIGH signal is assigned to terminals E3 and E4 when connecting the mains, the controller will activate the quick stop function. • CW/CCW changeover only in the main setpoint. • For speed control with actual value feedback, the CW/CCW changeover is not possible. 															

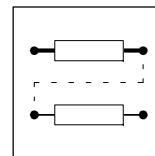

7.5.14.4 Quick stop QSP

Setting range 820X

Code	Name	Possible settings				IMPORTANT
		Lenze	Choice	Info		
C013	Deceleration time T_{if} 820X	5.00	0.00	{0.05 s}	999.00	

Setting range 821X/822X/824X

Code	Name	Possible settings				IMPORTANT
		Lenze	Choice	Info		
C105	Deceleration time quick stop 821X/822X/824X	5.00	0.00	{0.02 s}	999.00	
			0.00	{0.02 s}	1300.00	HVAC only

Function

820X

If you activate the function quick stop, the drive will be decelerated to standstill over the set deceleration time (C013). If the value falls below $f_d = 0.1\text{Hz}$, the DC-injection brake (DCB) will be activated.

821X/822X/824X

The activation of quick stop decelerates the drive to standstill according to the deceleration time set and C105. If f_d falls below the threshold C019, the DC-injection brake (DCB) will be activated.

Activation

Series "Standard":

- C007 = -14- ... -22-:
 - LOW level at terminals E3 and E4
 - HIGH level at terminals E3 and E4 when switching on the mains
- C007 = -2-, -4-, -8-, -9-, -13-:
 - LOW level at terminal E3

Series "HVAC":

- C007 = -14- ... -22-, -34-, -47-:
 - LOW level at terminals E3 and E4
 - HIGH level at terminals E3 and E4 when switching on the mains
- C007 = -46-, -49-:
 - LOW level at terminal E2
- C007 = -2-, -4-, -8-, -9-, -13-, -30-, -31-, -32-, -36-, -37-, -40-, -43-, -45-:
 - LOW level at terminal E3
- C007 = -33-, -42-:
 - LOW level at terminal E4

The signal levels are indicated for C114 = -0- (see chapter 7.5.14.1).

Special features

821X/822X/824X

- Independently of the operating mode C001, quick stop can always be activated via terminals.

Series "HVAC":

- The activation of quick stop via terminals can be switched-off with the priority mask (C115).
- Quick stop acts on the main setpoint only. Quick stop does not have an effect on the additional setpoint (C049) and the correction value of the process controller (software level 3.0).

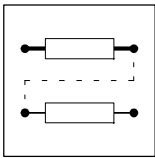

Configuration

7.5.14.5 DC-injection brake (DCB)

Code	Name	Possible settings			IMPORTANT		
		Lenze	Choice	Info			
C019	Threshold auto DC brake 821X/822X/824X	0.10	0.10	{0.02 Hz} 5.00			
			0.00	{0.02 Hz} 5.00		HVAC only	
C035* ↙	Selection DC brake	-0-	-0-	Selection of brake voltage under C036	HVAC only		
			-1-	Selection of brake current under C036			
C036	Voltage for DC brake	*	0.00	{0.02 %} 40.00	* depends on the unit		
	Voltage/current for DCB		0.00	{0.02 %} 150.00		HVAC only	
C106	Holding time for autom. DC injection brake						
			820X	0.00		0.00	{0.01s} 50.00
			821X/822X 824X	0.02		0.00	{0.01s} 999.00
C196* ↙	Input condition autom. DC injection brake	-0-	-0- -1-	DC brake active at C050 < C019 DC brake active at C050 < C019 and Setpoint < C019	HVAC only		

Series "Standard":

- Function**
- DC braking enables fast deceleration of the drive to standstill without using a brake unit.
- Activation**
- Via terminal
 - C007 = -3-, -7-, -14-, 19:
HIGH level at terminal E2
The DC-injection brake remains active until a LOW signal is reassigned to terminal E2.
 - C007 = -0-, -5-, -11-:
HIGH level at terminal E3
The DC-injection brake remains active until a LOW signal is reassigned to terminal E3.
 - Automatically
 - If the field-frequency setpoint falls below the operating threshold, the DC-injection brake will be activated for the holding time set under C106. Afterwards, the drive will set controller inhibit.
- Important**
- The DC-motor current is directly set under code C036 (voltage for DC brake). Please observe, that the connected motor can be overheated by overlong operation and excessive DC-motor current.
- Special features**
- 820X Fixed operating threshold for DCB $f_d = 0.1$ Hz.
- 821X/822X/824X Operating threshold for DC brake adjustable under C019.
The display value of the parameter can be related to an application datum.

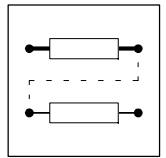

Series "HVAC":

Function

- DC braking enables fast deceleration of the drive to standstill without using a brake unit.
- The brake torque is lower as for braking in generator mode (via chopper or DC-bus operation).
 - The possible brake torque is approx. 20 % ... 30 % of the rated motor torque.
- A brake voltage or a brake current can be selected.
- C196 enables an improved motor start when the automatic DC-injection brake is activated (e.g. for hoists).
- The DCB function is activated either automatically when falling below the threshold set under C019 or via dig. input terminals E1 ... E4 (depending on C007).
- With the auto-DCB function, also a dead band in the setpoint can be set via C019. If DC braking is not required here, set C106 = 0.

Adjustment

1. Select, whether a brake voltage (C035 = -0-) or a brake current is to be entered.
2. Select the brake voltage or brake current in per cent under C036.
 - With C035 = -0-, the indication refers to the rated controller voltage [V_r].
 - With C035 = -1-, the indication refers to the rated controller current [I_r].
3. Select how to activate the DC-injection brake (DCB):
 - Via terminals E1 ... E4
 - Automatically

Activation via terminals E1 ... E4

Setting C007	High level at	Function
-17-	Terminal E1 *	DCB remains active until a LOW signal is assigned to terminal E1.
-3-, -7-, -14-, 19	Terminal E2 *	DCB remains active until a LOW signal is assigned to terminal E2.
-0-, -5-, -11-, -25-, -29-, -41-, -42-, -48-	Terminal E3 *	DCB remains active until a LOW signal is assigned to terminal E3.
-31-, -36-, -51-	Terminal E4 *	DCB remains active until a LOW signal is assigned to terminal E4.

* The signal levels are indicated for C114 = -0- (see chapter 7.5.14.1).

Automatic activation

1. Select under C106:
 - C106 = 0,00 - auto DCB is not active (no reaction on $f_d < C019$).
 - C106 > 0.00 - the DC injection brake is active for the time set. Afterwards, the drive will set controller inhibit.
2. Select the input conditions for the automatic DC injection braking under C196.
 - C196 = -0- DCB active, if C050 < C019
 - C196 = -1- GSB active, if C050 < C019 **and** setpoint < C019
3. Set the operating threshold under C019.
 - The operating threshold indicates, when the DC injection brake is activated (see step 2.).

Important

- C035 = -1-
 - The DC motor current is directly set under C036 (ref. to rated controller current).
- C035 = -0-
 - The DC motor current is indirectly set under C036 (ref. to rated controller voltage).
- Please observe, that the connected motor can be overheated by overlong operation and excessive DC-motor current.

Special features

- Set the operating threshold for auto DCB under C019. The display value of the parameter can be related to an application datum (C500, C501) (see chapter 7.6.3.)
- With C106 = 0.00, the automatic DC-injection brake is not active.
- C035 and C196 are only stored in parameter set 1.

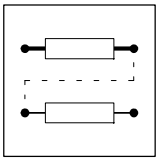

Configuration

7.5.14.6 Parameter set changeover PAR

Function	Switches between the two parameter sets (ONLINE) during controller operation.
Activation	<p>C007 = -4-, -8-, -15-, -17-, -18-, or C007 = -4-, -8-, -15-, -17-, -18-, -35-, -36-, -37-, -44-, -45- (only series "HVAC")</p> <ul style="list-style-type: none"> - LOW level at terminal E2 activates PAR1 - HIGH level at terminal E2 activates PAR2 <p>C007 = -1-, -3-, -6-, -7-, -12-, or C007 = -1-, -3-, -6-, -7-, -12-, -24-, -33-, -38-, -46-, -51- (only series "HVAC")</p> <ul style="list-style-type: none"> - LOW level at terminal E3 activates PAR1 - HIGH level at terminal E3 activates PAR2
Series "HVAC":	The signal levels are indicated for C114 = -0- (see chapter 7.5.14.1)
Important	<ul style="list-style-type: none"> • In the code level the active code set is indicated by blinking of "PAR1" or "PAR2". • The codes marked with * in the code table are similar for PAR1 and PAR2. The active parameter set is only displayed on the operating module in the code level. • For changeover between the parameter sets via terminal, the same terminal of both parameter sets must be assigned with PAR.
Special features 821X/822X/824X	If the control mode (C014) is set differently in the parameter sets, the parameter sets should only be changed when the controller is inhibited.

7.5.14.7 TRIP set

Function	If the function TRIP set is activated, the unit detects external faults that can thus be taken into account. The controller indicates the fault EEr and sets controller inhibit.
Activation	<ul style="list-style-type: none"> • C007 = -7-, -8-, -18-, -19-: - LOW level at terminal E1 • C007 = -5-, -6-, -9-, -20-, or C007 = -5-, -6-, -9-, -20-, -38-...-43- (only series "HVAC"): - LOW level at terminal E2 • C007 = -10-, or C007 = -10-, -27- (only series "HVAC"): - LOW level at terminal E3 • C007 = -32-: - LOW level at terminal E4 (only series "HVAC")
Series "HVAC":	The signal levels are indicated for C114 = -0- (see chapter 7.5.14.1)
Important	For fault reset, see chapter 8.4, "Reset of fault messages".
Special features 820X	With the operating mode "control via LECOM" (C001 = -3-), the function TRIP set cannot be activated via terminals.
821X/822X/824X Series "HVAC":	<ul style="list-style-type: none"> • Independently of the operating mode C001, TRIP set can always be activated via terminals. • The activation of TRIP set via terminals can be switched-off with the priority mask (C115).

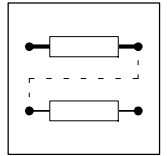

7.5.14.8 Manual/remote changeover

Only "HVAC" controllers

Function	<ul style="list-style-type: none"> • With manual/remote changeover (H/Re), it is for instance possible to change from remote operation to manual operation in the event of setting-up the drive or service. <ul style="list-style-type: none"> - For manual operation, the remote operation must not be changed (e. g. LECOM). - In manual operation, the setpoint is entered via potentiometer or motor potentiometer. • The function "Motor potentiometer" is activated via terminal E1 ... E4. <ul style="list-style-type: none"> - If the function "Motor potentiometer" is activated, the operating mode is set to C001-internal = -0-. • The change between manual and remote operation can only be carried out through terminals E1 ... E4. The following changeover is possible: <ul style="list-style-type: none"> - Fieldbus ↔ Function "Motor potentiometer" - Fieldbus ↔ Analog terminal setpoint (terminal 8, terminal E1, additional setpoint) - Function "Motor potentiometer" ↔ Analog terminal setpoint (terminal 8, terminal E1, additional setpoint)
Activation	<p>C007 = -47-:</p> <ul style="list-style-type: none"> • HIGH level at terminal E2 <ul style="list-style-type: none"> - Manual operation, function "Motor potentiometer" is active, C001-internal = -0- - Setpoint selection via analog channel <p>C007 = -23-, -24-, -25-, -26-, -27-:</p> <ul style="list-style-type: none"> • HIGH level at terminal E4 <ul style="list-style-type: none"> - Manual operation, function "Motor potentiometer" is active, C001-internal = -0- - Setpoint selection via UP (term. E2), DOWN (term. E1) <p>C007 = -46:</p> <ul style="list-style-type: none"> • HIGH level at terminal E4 <ul style="list-style-type: none"> - Manual operation, function "Motor potentiometer" is active, C001-internal = -0- - Setpoint selection via analog channel <p>C007 = -23-, -24-, -25-, -26-, -27-, -46-, -47-:</p> <ul style="list-style-type: none"> • LOW level at terminal E2 (if C007 = -47-) or terminal E4 <ul style="list-style-type: none"> - Remote operation, function "Motor potentiometer" is not active, C001-internal = C001 - Setpoint selection via C046, analog channel or JOG frequency <p>The signal level is indicated for C114 = -0- (see chapter 7.5.14.1).</p>
Important	<p>Safety functions ctrl. inhibit and QSP activated in remote operation are reset when changing to manual operation. Check, whether the master sets these safety functions again when changing from manual operation to remote operation.</p>

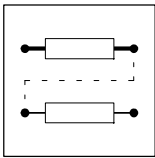

Configuration

7.5.14.9 Digital frequency input

Only "HVAC" controllers

Code	Name	Possible settings				IMPORTANT
		Lenze	Choice	Info		
C425 _↵ *	Adjustment of digital frequency	-2-	Dig.-freq. Resolution Scanning Max.-freq.			
		-0-	100 Hz 1/200 1 s 300 Hz			
		-1-	1 kHz 1/200 100 ms 3 kHz			
		-2-	10 kHz 1/200 10 ms 10 kHz			
		-3-	10 kHz 1/1000 50 ms 10 kHz			
		-4-	10 kHz 1/10000 500 ms 10 kHz			
C426*	Gain adjustment frequency input E1	100.0	-200.0	{0.1 %}	200.0	
C427	Offset adjustment frequency input E1	0.0	-12.5	{0.1 %}	12.5	

Function Select a digital frequency of 0 Hz ... 10 kHz as setpoint or as actual value using terminal E1. With C007 = -28- ... -45-, -48-, -49-, -50-, -51-, the terminal E1 is configured for this function.

Adjustment

- C425
 - Selection of the frequency to be assigned to terminal E1.
 - Resolution and scanning time for reading the frequency.
- C426
 - Sets the gain of the input signal. 100 % corresponds to a gain factor = 1.
 - If E1 is used as actual value, C426 must be set as positive value, e.g. for pressure control, if the motor speed is to increase when the pressure falls.
- C427
 - Sets the offset of the input signal.
 - If C427 = -12.5 %, an offset of -20 % is internally set for the input.
- Select input E1 for master current 4 mA ... 20 mA:
 - Use an analog plug-in module 8279.
 - Set C426 = 125 %.
 - Set C427 = -12.5 %.

Important

- When using the analog input module 8279 for the frequency input E1:
 - Set C425 = -2-, -3- or -4-.
- With C005 = -0-, C425 and C426 are not active.
- C425, C426, C427 are only stored in parameter set 1.

Special features

- For higher accuracy requirements at 10 kHz digital frequency, select a higher resolution under C425 taking into account the scanning time.
- After addition to the signal at terminal E1, the offset (C427) is only effective as positive value (see signal flow-chart in chapter 16.3.2, as of software version 3.0).
- The digital frequency refers to internal normalisation (e.g. C011 etc.)
- The maximum frequency is the maximum to be processed by the input E1. If the value is exceeded, it must be adapted proportionally under C426.

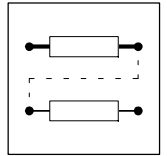

7.5.15 Indirect torque limitation

Only "HVAC" controllers

Code	Name	Possible settings			IMPORTANT
		Lenze	Choice	Info	
C005			-3- Open loop operation via frequency input E1 with limitation of the apparent motor current via terminal 8	C005 = -3- possible with C014 = -2-, -4-	

Function With C005 = -3-, the apparent motor current (indirect torque limitation) can be limited with an external signal via the analog input terminal 8. Enter a motor current limit.

Adjustment The influence of the torque limitation is adjusted via the analog input terminal 8 (see chapter 7.5.11.1).

- The effective current limit is indicated in % in C047.
- C022 has no influence. The external signal via terminal 8 selects the current limit.
- C023 remains effective.

Example Constant mass flow control:

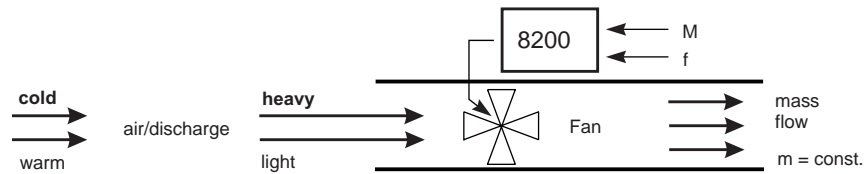

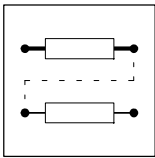

Configuration

7.6 Display functions

7.6.1 Display values

Code	Name	Possible settings			IMPORTANT
		Lenze	Choice	Info	
C040	Controller enable	*	-0- Controller inhibited -1- Controller enabled	HVAC only	* see Operating Instructions 2102
C046	Frequency setpoint	*	-480.00 {0.02 %} 480.00	[Hz] HVAC only	
C047*	Current setpoint I_{max} limit value			[%] HVAC only	Display only 150 % for rated value at term. 8 and factory setting
C049*	Additional setpoint			[Hz] HVAC only	Display only • Only if C005 = -1-, -2-
C050*	Output frequency			[Hz]	Display only
C051*	Actual PID controller value			[Hz] HVAC only	Display only
C052*	Motor voltage			[V]	Display only
C053*	DC-bus voltage			[V] HVAC only	Display only
C054*	Motor current			[A]	Display only
C056*	Unit load			[%]	Display only
C061*	Temperature Heat sink			[°C]	Display only

Function Some parameters, which are measured by the controller during operation, can be displayed on the 8201BB operating module.

Important • Display under C050 corresponds to the setpoint without slip compensation (C021).

Series "HVAC":

- Display under C047:
 - If C005 = -0-, -1-, -2-, -6-, -7-, → I_{max} limit value (C022).
- Display under C049, only if C005 = -1- and -2-.

Special features

821X/822X/824 • The display value of a parameter can be related to an application datum (see chapter 7.6.3).

Series "HVAC":

- Codes C046, C049, C050, C051: Hz display only in factory setting (C500 = 2000; C501 = 10) (see chapter 7.6.3).

7.6.2 Switch-on display

Code	Name	Possible settings			IMPORTANT
		Lenze	Choice	Info	
C004 _↙	Switch-on display	-0-	-0- Field frequency f_d (C050) -1- Unit load (C056) -2- Motor current (C054)		

Function The here selected display is active after mains connection, if the 8201BB operating module is plugged on.

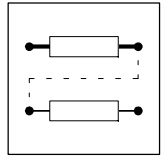

7.6.3 Normalisation of an application datum

820X setting range: This function is not available.

Setting range 821X/822X/824X:

Code	Name	Possible settings			IMPORTANT
		Lenze	Choice	Info	
C500*	Display factor Application datum numerator 821X/822X/824X	2000	1 {1} 25000		
C501*	Display factor for process variable denominator 821X/822X/824X	10	1 {1} 25000		

Function

- Adaptation of field-frequency related parameters C010, C011, C017, C019, C037, C038, C039, C050, or C010, C011, C017, C019, C037, C038, C039, C046, C049, C050, C051, C181, C625, C626, C627 (series "HVAC") to an application datum to be controlled, e.g. pressure, temperature, flow rate, humidity or speed.
- The normalisation implements an absolute or relative selection of an application datum.
- All codes indicated are normalised at the same time.

Adjustment

The display value is calculated from:

$$CXXX = \frac{C011}{200} \cdot \frac{C500}{C501}$$

Example

The speed setpoint is to be input and displayed as relative or absolute value.
Values: $P_{set} = 5 \text{ bar}$, if $f_{dmax} = 50 \text{ Hz}$ (C011)

a) Relative normalisation in %

$$100.00 \text{ (\%)} = \frac{50}{200} \cdot \frac{4000}{10}$$

e.g. C500 = 4000, C501 = 10

b) Absolute normalisation in physical units

$$5.00 \text{ (bar)} = \frac{50}{200} \cdot \frac{200}{10}$$

e.g. C500 = 200; C501 = 10

Important

- All codes indicated above are normalised at the same time.
- After a normalisation, the output frequency [Hz] (C050) can only be recalculated with the display factors C500 and C501.

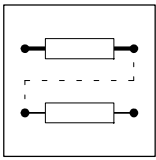

Configuration

7.6.4 Elapsed operating time meter

Code	Name	Possible settings			IMPORTANT
		Lenze	Choice	Info	
C178*	Operating time			[h]	Display only
C179*	Mains connection time			[h]	Display only

Function

The following times can be displayed:

- Operating time: Time during which the controller is enabled.
- Mains connection time: Time during which the controller is connected to the mains.

7.6.5 Software version and controller type

Code	Name	Possible settings			IMPORTANT
		Lenze	Choice	Info	
C093*	Type		82xx		Display only
C099*	Software version		82 x.x		Display only

Function

Reading of type and software version of the controller.

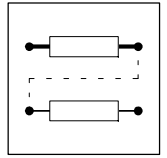

7.7 Monitoring functions

7.7.1 Relay outputs

Relay output K1

Code	Name	Possible settings			IMPORTANT	
		Lenze	Choice	Info		
C008↓	Function relay K1	-1-	-0-	Ready for operation		
			-1-	TRIP fault message		
			-2-	Motor is running		
			-3-	Motor is running / CW rotation		
			-4-	Motor is running / CCW rotation		
			-5-	Field frequency $f_d = 0$		
			-6-	f_{dset} reached		
			-7-	Q_{min} reached		
			-8-	I_{max} reached		
			-9-	Overtemperature ($\vartheta_{max} - 10\text{ °C}$)		
			-10-	TRIP or Q_{min} or IMP		
	822X/824X		-11-	PTC warning	HVAC only	
			-12-	Apparent motor current (C054) < threshold C156	HVAC only	
			-13-	Apparent motor current (C054) < current threshold C156 and $f_d > Q_{min}$ threshold (C017)	HVAC only	
			-14-	Apparent motor current (C054) < threshold C156 and input of ramp function generator = output of ramp function generator	HVAC only	
	822X/824X		-15-	Warning motor phase failure	HVAC only	
			-16-	f_d (C050) < f_{dmin} (C010)	HVAC only	
C054*	Motor current				HVAC only	Display only
C156*	Current threshold	0	0	{1 %} 150	HVAC only	

Function

To monitor the drive, the changeover contact of the relay K1 - terminals K11, K12, K14 - can be assigned with different functions.

Series "HVAC":

C008 = -12-, -13-, -14-:

- The display value(C054) is smoothened with a ring memory with 500 ms.
- The value set under C156 corresponds to a percentage of the rated controller current $[I_r]$.
- With the control mode "Square characteristic" (C014 = 3), C156 is internally adapted via the field frequency (C011):

$$C156_{\text{internal}} [\%] = C156 [\%] \cdot \frac{f_d^2 [\text{Hz}^2]}{C011^2 [\text{Hz}^2]}$$

For instance, a belt monitoring can be implemented with this function extension.

Important

C156 is only stored in PAR1.

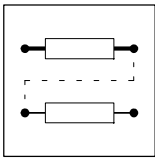

Configuration

Switching conditions	Monitoring functions	Relay
	Ready for operation	energised when controller is ready drop-out when <ul style="list-style-type: none"> • TRIP fault message • Undervoltage/overvoltage
	TRIP fault message	energised with TRIP fault message
	Motor is running	energised when $f_d \neq 0$ Hz
	Motor is running / CW rotation; Motor is running / CCW rotation	energised when $f_d \neq 0$ Hz, direction of rotation via terminal CCW rotation: $f_d > 0$ Hz, CW rotation: $f_d < 0$ Hz
	Field frequency $f_d = 0$	energised when $f_d = 0$ Hz, because <ul style="list-style-type: none"> • $f_{dset} = 0$ Hz, t_{if} over • DC brake active • Controller inhibited
	f_{dset} reached	energised when $f_d = f_{dset}$
	Q_{min} reached	energised when $f_d > f_{dQmin}$ (C017)
	I_{max} reached	energised when motor current = <ul style="list-style-type: none"> • I_{max} motor mode (C022) • I_{max} generator mode (C023)
	Overtemperature	energised when the heat sink temperature = $\vartheta_{max} - 10$ °C
	TRIP, Q_{min} or IMP (only "HVAC" controllers)	drop-out when <ul style="list-style-type: none"> • TRIP fault message • $f_d \leq f_{dQmin}$ • Pulse inhibit because of controller inhibit, overvoltage or undervoltage
	PTC warning (only "HVAC" controllers)	drop-out when <ul style="list-style-type: none"> • connected PTC thermistor has detected motor overtemperature.
	Apparent motor current < current threshold (only "HVAC" controllers)	drop-out when I_{motor} (C054) < current threshold (C156)
	Apparent motor current < current threshold and $f_d > Q_{min}$ threshold (C017) (only "HVAC" controllers)	drop-out when I_{motor} (C054) < current threshold (C156) and $f_d > f_{dQmin}$ (C017)
	Apparent motor current < current threshold and ramp-function generator input = ramp-function generator output (only "HVAC" controllers)	drop-out when I_{motor} (C054) < current threshold (C156) and ramp-function generator input = ramp-function generator output
	Warning motor phase failure (only "HVAC" controllers)	energised in the event of a motor-phase failure
	f_d (C050) < f_{dmin} (C010) (only "HVAC" controllers)	energised when $f_d > C010$

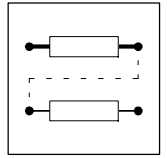

Relay output K2

Setting range 820X/821X: K2 not available.

Setting range 822X/824X:

Code	Name	Possible settings			IMPORTANT	
		Lenze	Choice	Info		
C117 _↓	Function relay K2	-1-	-0-	Ready for operation		
			-1-	TRIP fault message		
			-2-	Motor is running		
			-3-	Motor is running / CW rotation		
			-4-	Motor is running / CCW rotation		
			-5-	Field frequency $f_d = 0$		
-6-	f_{dset} reached					
-7-	Q_{min} reached					
-8-	I_{max} reached					
-9-	Overtemperature ($\vartheta_{max} - 10 \text{ }^\circ\text{C}$)					
-10-	TRIP or Q_{min} or IMP					
822X/824X		-11-	PTC warning	HVAC only		
		-12-	Apparent motor current (C054) < threshold C156	HVAC only		
		-13-	Apparent motor current (C054) < current threshold C156 and $f_d > Q_{min}$ threshold (C017)	HVAC only		
		-14-	Apparent motor current (C054) < threshold C156 and input of ramp function generator = output of ramp function generator	HVAC only		
822X/824X		-15-	Warning motor phase failure	HVAC only		
		-16-	f_d (C050) < f_{dmin} (C010)	HVAC only		
C054*	Motor current			HVAC only	Display only	
C156*	Current threshold	0	0	{1 %}	150	HVAC only

Function The changeover contact of relay K2 - terminals K21, K22, K24 - can be assigned with different function to monitor the drive.

Series "HVAC":
 C008 = -12-, -13-, -14-:
 • The display value (C054) is smoothened with a ring memory with 500 ms.
 • The value set under C156 corresponds to a percentage of the rated controller current [I_r].
 • With the control mode "Square characteristic" (C014 = 3), C156 is internally adapted via the field frequency (C011):

$$C156_{\text{internal}} [\%] = C156 [\%] \cdot \frac{f_d^2 [\text{Hz}^2]}{C011^2 [\text{Hz}^2]}$$

For instance, a belt monitoring can be implemented with this function extension.

Important C156 is only stored in PAR1.

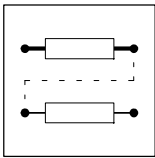

Configuration

Switching conditions	Monitoring functions	Relay
	Ready for operation	energised when controller is ready drop-out when <ul style="list-style-type: none"> • TRIP fault message • Undervoltage/overvoltage
	TRIP fault message	energised with TRIP fault message
	Motor is running	energised when $f_d \neq 0$ Hz
	Motor is running / CW rotation; Motor is running / CCW rotation	energised when $f_d \neq 0$ Hz, direction of rotation via terminal CCW rotation: $f_d > 0$ Hz, CW rotation: $f_d < 0$ Hz
	Field frequency $f_d = 0$	energised when $f_d = 0$ Hz, because <ul style="list-style-type: none"> • $f_{dset} = 0$ Hz, t_{ff} over • DC-injection brake active • Controller inhibited
	f_{dset} reached	energised when $f_d = f_{dset}$
	Q_{min} reached	energised when $f_d > f_{d0min}$ (C017)
	I_{max} reached	energised when motor current = <ul style="list-style-type: none"> • I_{max} motor mode (C022) • I_{max} generator mode (C023)
	Overtemperature	energised when the heat sink temperature = $\vartheta_{max} - 10$ °C
	TRIP, Q_{min} or IMP (only "HVAC" controllers)	drop-out when <ul style="list-style-type: none"> • TRIP fault message • $f_d \leq f_{d0min}$ • Pulse inhibit because of controller inhibit, overvoltage or undervoltage
	PTC warning (only "HVAC" controllers)	drop-out when <ul style="list-style-type: none"> • connected PTC thermistor has detected motor overtemperature.
	Apparent motor current < current threshold (only "HVAC" controllers)	drop-out when I_{motor} (C054) < current threshold (C156)
	Apparent motor current < current threshold and $f_d > Q_{min}$ -threshold (C017) (only "HVAC" controllers)	drop-out when I_{motor} (C054) < current threshold (C156) and $f_d > f_{d0min}$ (C017)
	Apparent motor current < current threshold and ramp-function generator input = ramp-function generator output (only "HVAC" controllers)	drop-out when I_{motor} (C054) < current threshold (C156) and ramp-function generator input = ramp-function generator output
	Warning motor phase failure (only "HVAC" controllers)	energised in the event of a motor-phase failure
	f_d (C050) < f_{dmin} (C010) (only "HVAC" controllers)	energised when $f_d > C010$

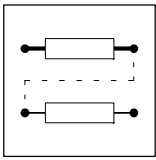

Configuration

Adjustment	C111	820X:	Voltage at terminal 62, if C108 = 220
		821X/822X/824X:	Voltage at terminal 62, if C108 = 128
Series "HVAC":	-0-	6 V, if $f_d = f_{dmax}$	
	-1-	3 V, if C056 = 100 %	
	-2-	3 V, if C054 = rated controller current	
	-3-	820X:	6 V, if $V_{DC} = 380$ VDC
		821X/822X/824X:	6 V, if $V_{DC} = 1000$ VDC
	-4-	3 V at rated power, $P_r = C052 * C056$	
	-5-	4.8 V at motor voltage = 400 V	
	-6-	2 V, if C011 = 50 Hz, C050 = 20 Hz	
	-7-	Monitor output voltage [V] = $6.00V \cdot \frac{f_d - C011}{C011 - C010}$	
-8-	6 V, if C051 = f_{dmax}		

Important

- The gain of the analog output (C108) can be adjusted ONLINE.

Series "HVAC":

- C111 = -9- to C111 = -25- correspond to the relay output functions C008 and C117:
 - LOW = 0 V
 - HIGH = 10 V

Series "HVAC":

C111 = -6-

Normalisation of the monitor output voltage with a reciprocal field frequency output:

$$\text{Monitor output voltage [V]} = 1.00 \text{ V} \cdot \frac{C011 \text{ [Hz]}}{C050 \text{ [Hz]}} \cdot \frac{C108}{128}$$

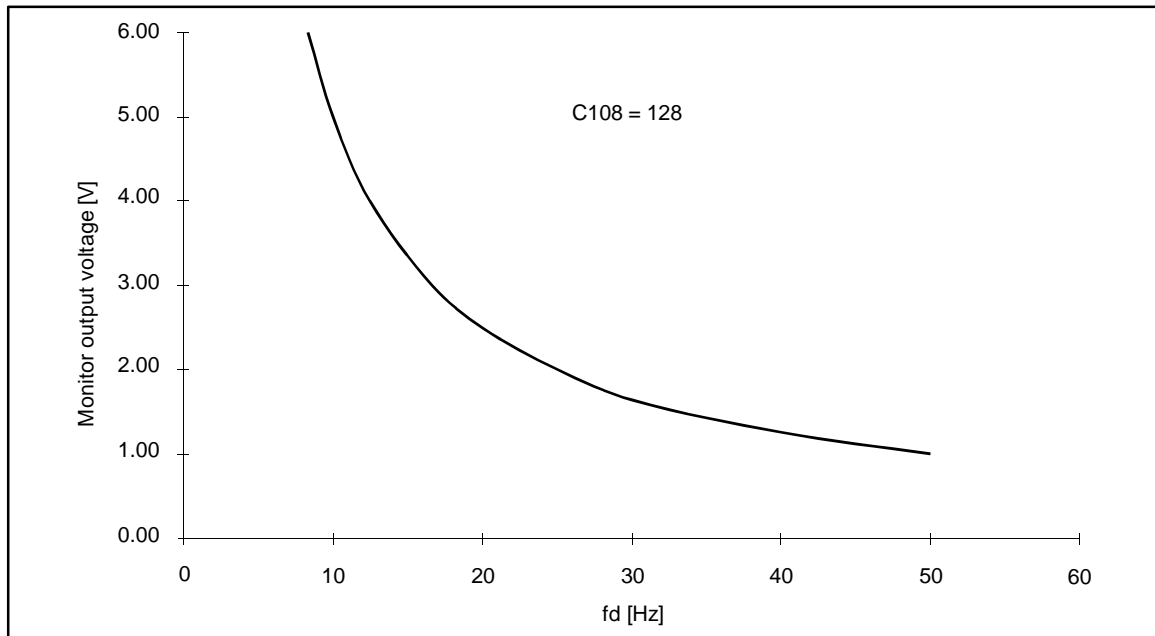

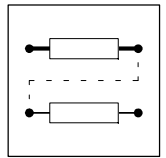

7.7.3 Thermal motor monitoring

7.7.3.1 $I^2 \cdot t$ monitoring

Code	Name	Possible settings			IMPORTANT
		Lenze	Choice	Info	
C120	$I^2 \cdot t$ switch-off	0	0 {1 %}	100	

Function With the $I^2 \cdot t$ monitoring, self-ventilated three-phase AC motors can be thermally monitored without using sensors.

- Adjustment**
- Enter an individual load limit for the motor connected.
 - If this values is exceeded for a longer period of time, the controller will set the fault OC6 and switch-off (see chart).
 - The current limits C022 and C023 only have an indirect influence on the $I^2 \cdot t$ calculation:
 - The settings of C022 and C023 can make the operation with maximum controller load (C056) impossible.
 - When selecting a drive which does not match (output current much higher than rated motor current):
 - Reduce C120 by the factor of the mismatch.

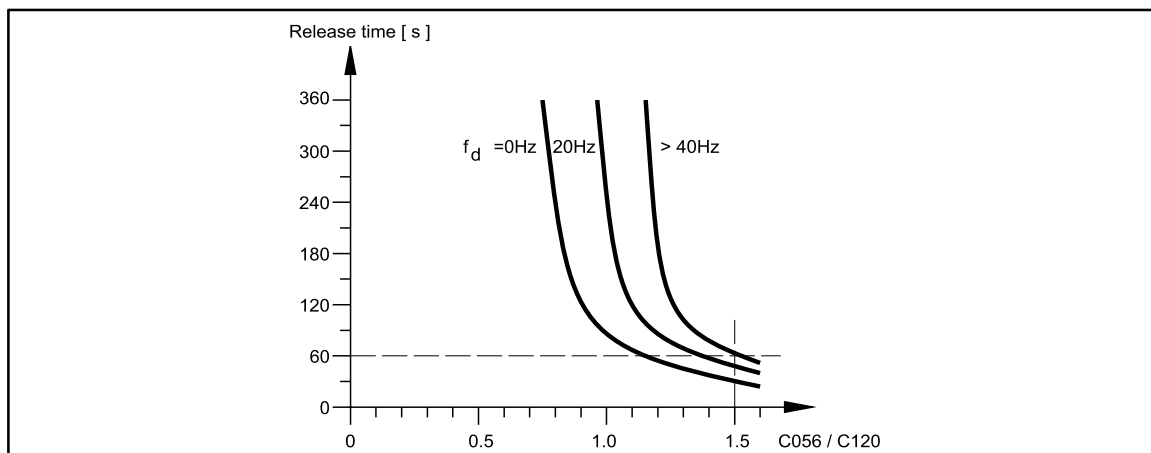

Example:

With C120 = 100 % and a load of C056 = 150 %, the controller switches off after 60 s when reaching $f_d > 40$ Hz, or earlier with $f_d < 40$ Hz.

- Important**
- The setting 0 % deactivates the function.
 - This monitoring does not provide full motor protection since the calculated motor temperature is set to "0" after every mains connection or disconnection. The connected motor can be overheated, if
 - it is already hot but still overloaded,
 - the cooling-air stream is interrupted or the air is too hot.
 - Full motor protection can be achieved with a PTC thermistor in the motor.
 - We recommend the general use of PTC monitoring systems for multi-motor drives.
 - To prevent motors with forced ventilation from starting too early, this function can be deactivated.
 - If load-adapted motors are to be monitored at a load of < 100 %, C120 must also be reduced accordingly.
 - The operation of the controller with 120 % overload might lead to the activation of the $I^2 \cdot t$ switch-off, because the setting of C120 > 100 % is not possible.
 - Deactivate the $I^2 \cdot t$ switch-off for the operation of the controller at 120 % overload.

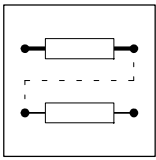

Configuration

7.7.3.2 PTC input

Setting range 820X/821X: Option, see Accessories

Setting range 822X/824X:

Code	Name	Possible settings			IMPORTANT
		Lenze	Choice	Info	
C119 ↙	Function PTC 822X/824X	-0-	-0- -1-	PTC input not active PTC input active TRIP and IMP inhibit are set (OH3 message)	
			-2-	PTC input active Warning via relay (adjustable)	Message not visible in the history buffer (C161 ... C164)

Function Input for the connection of PTC resistors to DIN44081 and DIN44082. The motor temperature can be detected and integrated in the drive monitoring. This input can also be used for the connection of a thermostat (normally-close).

Activation

1. Connect the monitoring circuit of the motor to the provided terminals T1 and T2.
2. Parameter setting for the evaluation of the PTC signal:
If the PTC evaluation detects an overtemperature, it can be evaluated in three ways:
 - C119 = -0- PTC not active
 - C119 = -1- TRIP
 - C119 = -2- warning

Important

- The controller can only evaluate a motor-PTC system.
 - Several motor-PTC systems connected in parallel or in series are not allowed.
- If you connect several motors to an inverter, use thermistors (normally-close) to monitor the motor temperature.
 - For the evaluation, thermistors can be connected in series.
- The OH3 message is activated at approx. $R \geq 1.6 \text{ k}\Omega$. If, for a functionality test, the PTC input is assigned to a variable resistor, the following occurs:
 - $R > 2 \text{ k}\Omega$ a message is set.
 - $R < 250 \Omega$ no message is set.

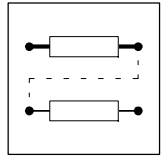

7.7.4 Motor-phase failure detection

Only series "HVAC"

Setting range 821X: not possible

Setting range 822X/824X:

Code	Name	Possible settings			IMPORTANT
		Lenze	Choice	Info	
C597* _↓	Activation of motor-phase failure detection	-0-	-0- Inactive -1- TRIP -2- Warning		
C599	Current limit for motor-phase failure detection	5	1 {1 %} 50		

Function If the function is activated under C597, the controller monitors the motor phases for failure. The current limit value (C599) defines the threshold when a motor phase failure is indicated. The value set under C599 corresponds to the percentage of the rated controller current [I_r].

Activation

- C597 = -0- function not active
- C597 = -1- fault message TRIP
- C597 = -2- warning message

Fault indication

- 8201BB operating module:
 - TRIP: LP1
 - Warning: LP1
- Fieldbus:
 - TRIP: 32
 - Warning: 182

Important C597 and C599 are only stored in parameter set 1.

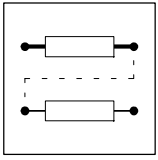

Configuration

EDS8200U--D1
00406185

Manual

Part D1

Code table

for the series
8200/10/20/40 standard

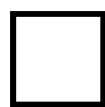

Global Drive
Frequency inverters 8200

This Manual is valid for 82XX controllers as of version:

	33.820X-	E-	1x.	1x		(8201 - 8204)
	33.8202-	E-	1x.	1x	-V002	Reduced assembly depth (8202)
	33.821X-	E-	0x.	1x		(8211 - 8218)
	33.821X-	E-	1x.	2x		(8211 - 8218)
	33.821X-	C-	1x.	2x	-V003	Cold plate (8215 - 8218)
	33.821X-	E-	3a.	3x	-V020	HVAC (8211 - 8218)
	33.822X-	E-	0x.	0x		(8221 - 8227)
	33.822X-	C-	1x.	2x	-V003	Cold plate (8221 - 8222)
	33.822X-	E-	3a.	3x	-V020	HVAC (8221 - 8227)
	33.824X-	E-	1x.	1x		(8241 - 8246)
	33.824X-	C-	1x.	1x	-V003	Cold plate (8241 - 8246)
	33.824X-	E-	3a.	3x	-V020	HVAC (8241 - 8246)
Type						
Design: B = Module C = Cold plate E = Built-in unit IP20						
Hardware version and index						
Software version and index						
Variant						
Explanation						

		revised	
Edition of:	01/1999		

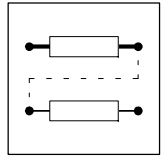

7.8 Code table for “Standard” series

How to read the code table:

Column	Abbreviation	Meaning
Code	C013	Code C013 <ul style="list-style-type: none"> The parameter of the code can be different in PAR1 and PAR2. The parameter value is accepted immediately (ONLINE).
	C009*	<ul style="list-style-type: none"> The parameter value of the code is always the same in PAR1 and PAR2, but is always displayed in PAR1.
	C001↓	<ul style="list-style-type: none"> The parameter value of the code will be accepted after pressing SH+ PRG.
	[C002]	<ul style="list-style-type: none"> The parameter value of the code will be accepted after pressing SH+ PRG but only, if the controller is inhibited.
	C010•	<ul style="list-style-type: none"> Parameter value of the code will only be displayed in [Hz], if C500 = 2000 and C501 = 10 (factory setting). See chapter 7.6.3.
Name		Name of the code. 820X Unit-specific setting possibilities (here for 820X). Without unit designation the code is valid for all unit types.
Lenze		Factory setting of the code
	*	The column “Important” contains further information
Choice	1 {1 %} 99	Min. value {Steps/Unit} Max. value
Info	-	Meaning of the code
IMPORTANT	-	Additional, important explanation of the code

Code	Name	Possible settings			IMPORTANT
		Lenze	Choice	Info	
C001↓	Operating mode	-0-	-0- Setpoint selection via term. 8 Control via terminals Parameter setting via 8201BB -1- Setpoint selection via 8201BB or LECOM Control via terminals Parameter setting via 8201BB -2- Setpoint selection via term. 8 Control via terminals Parameter setting via LECOM -3- Setpoint selection via LECOM Control via LECOM Parameter setting via LECOM	Page 7-9, 7-42	
[C002]*	Parameter set		-0- Function executed -1- Overwrite PAR1 with factory setting -2- Overwrite PAR2 with factory setting -3- Overwrite PAR1 and PAR2 with the data of the operating module -4- Overwrite PAR1 with the data of the operating module -5- Overwrite PAR2 with the data of the operating module -6- Transmit PAR1 and PAR2 to the operating module	Page 7-10	
C004↓	Switch-on display	-0-	-0- Field frequency f_d -1- Unit load -2- Motor current	Page 7-62	

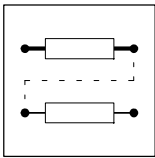

Configuration

Code	Name	Possible settings				Info	IMPORTANT	
		Lenze	Choice					
[C007]*	Terminal configuration	-0-	E4	E3	E2	E1	Page 7-10, 7-44, 7-46, 7-50, 7-54, 7-58,	<ul style="list-style-type: none"> • R = CW rotation • L = CCW rotation • GSB = DC-injection brake • PAR = Parameter set changeover • JOG = Fixed frequency • QSP = Quick stop • TRIP Set = External fault • UP/DOWN = Motor potentiometer functions <p>For parameter set changeover via terminals, the corresponding terminal must be assigned with PAR in both parameter sets.</p>
C008 ↙	Function relay K1	-1-	-0-	Ready for operation			Page 7-65	
			-1-	TRIP fault message				
			-2-	Motor is running				
			-3-	Motor is running / CW rotation				
			-4-	Motor is running / CCW rotation				
			-5-	Field frequency $f_d = 0$				
			-6-	f_{dset} reached				
			-7-	Q_{min} reached				
			-8-	I_{max} reached				
			-9-	Overtemperature ($\vartheta_{max} - 10 \text{ }^\circ\text{C}$)				
			-10-	TRIP or Q_{min} or IMP				
C009* ↙	Device address	1	1	{1}	99		Only for LECOM applications	
C010•	Minimum field frequency					Page 7-15		
		820X	0.00	0.00	{0.05 Hz}			480.00
		821X/822X/824X	0.00	0.00	{0.02 Hz}			480.00
C011•	Maximum field frequency					Page 7-15		
		820X	50.00	30.00	{0.05 Hz}			480.00
		821X/822X/824X	50.00	7.50	{0.02 Hz}			480.00
C012	Acceleration time T_{Ir}					Page 7-16		
		820X	5.00	0.00	{0.05 s}			999.00
		821X/822X/824X	5.00	0.00	{0.02 s}			999.00

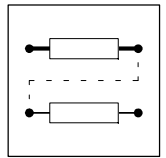

Code	Name	Possible settings				Info	IMPORTANT		
		Lenze	Choice						
C013	Deceleration time T_{ff}	820X	5.00	0.00	{0.05 s}	999.00	Page 7-16, 7-55		
		821X/822X/824X	5.00	0.00	{0.02 s}	999.00			
C014↓	Control mode	820X	-0-	-0-	Linear characteristic $V \sim f_d$ with auto boost	Page 7-19, 7-22, 7-24			
			-1-	-1-	Square characteristic $V \sim f_d^2$ with auto boost				
			-2-	-2-	Linear characteristic $V \sim f_d$ with constant V_{min} boost				
		-3-	-3-	Square characteristic $V \sim f_d^2$ with constant V_{min} boost					
821X/822X/824X	-4-	-4-	Motor-current control						
C015	V/f-rated frequency	820X	50.00	30.00	{0.05 Hz}	960.00	Page 7-22		
		821X/822X/824X	50.00	7.50	{0.02 Hz}	960.00			
C016	V_{min} setting	820X	*	0.00	{0.02 %}	40.00	Page 7-24		
		821X/822X/824X	0.00	0.00	{0.02 %}	40.00			
C017•	Threshold Q_{min}	0.00	0.00		{0.02 Hz}	480.00	Page 7-65		
C018↓	Chopper frequency 821X/822X/824X	-1-	-0-	-0-	4 kHz power-loss optimised	Page 7-29			
			-1-	-1-	8 kHz power-loss optimised				
			-2-	-2-	12 kHz power-loss optimised				
			-3-	-3-	16 kHz power-loss optimised				
			-4-	-4-	12 kHz noise optimised				
			-5-	-5-	16 kHz noise optimised				
C019•	Threshold auto DC brake 821X/822X/824X	0.10	0.10		{0.02 Hz}	5.00	Page 7-56		
C021	Slip compensation	820X	0.0*	0.0	{0.1 %}	12.0	Page 7-28	* If C014 = -2-, -3-, controller dependent	
		821X/822X/824X	0.0*	0.0	{0.1 %}	20.0			
C022	I_{max} limit (motor mode)	150	30		{1 %}	150	Page 7-17		
C023	I_{max} limit (generator mode)		80	30		{1 %}	110	Page 7-17	The current-limit controller for operation in generator mode is not active at 30 %.
		822X/824X	80	30		{1 %}	150		
C034↓	Master current	-0-	-0-	-0-	0 to 20 mA / 0 to 5 V / 0 to 10 V	Page 7-40			
			-1-	-1-	4 to 20 mA				

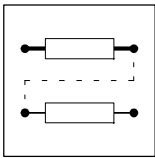

Configuration

Code	Name	Possible settings				Info	IMPORTANT	
		Lenze	Choice					
C036	Voltage/current for DCB	*	0.00	{0.02 %}	40.00	Page 7-56	* depends on the unit	
C037•	JOG value 1	20.00	0.00	{0.02 Hz}	480.00	Page 7-43		
C038•	JOG value 2	30.00	0.00	{0.02 Hz}	480.00	Page 7-43		
C039•	JOG value 3	40.00	0.00	{0.02 Hz}	480.00	Page 7-43		
C050*•	Output frequency					Page 7-62	Display only	
C052*	Motor voltage					Page 7-62	Display only [V]	
C054*	Motor current					Page 7-62	Display only [A]	
C056*	Unit load					Page 7-62	Display only [%]	
C061*	Heat sink temperature					Page 7-62	Display only [°C]	
C079	Oscillation damping	*				Page 7-31	* depends on the unit Is not transferred when transferring parameters via the operating module.	
		822X/824X	5	0	{1}			80
C088	Rated motor current 821X/822X/824X	*	0.0 ... 1.2 · rated output current			Page 7-27	* depends on the unit	
C091	Motor cos φ 821X/822X/824X	*	0.4	{0.1}	1.0	Page 7-27		
C093*	Type		820X	820X		Page 7-64	Display only	
			821X	821X				
			822X/824X	822X				
C099*	Software version		820X	82 1x (Software 1x)		Page 7-64	Display only	
			821X	82 2x (Software 2x)				
				82 1x (Software 1x)				
			822X/824X	82 1x (Software 1x)				
C105	Deceleration time QSP 821X/822X/824X	5.00	0.00	{0.02 s}	999.00	Page 7-55		
C106	Holding time for autom. DC injection brake					Page 7-56		
		820X	0.00	0.00	{0.01 s}			50.00
		821X/822X 824X	0.02	0.00	{0.01 s}			999.00
C108*	Gain (C111)					Page 7-69		
		820X	220	0	{1}			255
		821X/822X/ 824X	128	0	{1}			255
C111↵	Monitor signal	-0-	-0- -1- -2- -3-	Field frequency Unit load Motor current DC-bus voltage		Page 7-69		

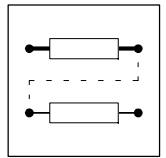

Code	Name	Possible settings			IMPORTANT
		Lenze	Choice	Info	
C117↓	Function relay K2 822X/824X	-0-	-0- Ready for operation -1- TRIP fault message -2- Motor is running -3- Motor is running / CW rotation -4- Motor is running / CCW rotation -5- Field frequency $f_d = 0$ -6- f_{dset} reached -7- Q_{min} reached -8- I_{max} reached -9- Overtemperature ($\vartheta_{max} - 10^\circ\text{C}$) -10- TRIP or Q_{min} or IMP -11- PTC warning	Page 7-65 ff	
C119↓	Function PTC 822X/824X	-0-	-0- PTC input not active -1- PTC input active, TRIP and pulse inhibit will be set -2- PTC input active Warning	Page 7-72	
C120	$I^2.t$ switch-off 822X/824X	0	0 {1 %} 100	Page 7-71	If C120 = 0, the function is not active
C125↓*	LECOM baud rate	-0-	-0- 9600 baud -1- 4800 baud -2- 2400 baud -3- 1200 baud -4- 19200 baud		Only for LECOM applications
C142↓	Start condition	-1-	-0- Automatic start inhibited, flying-restart circuit not active -1- Automatic start, if term. 28 HIGH, flying-restart circuit not active -2- Automatic start inhibited, flying-restart circuit active -3- Automatic start, if term. 28 HIGH, flying-restart circuit active	Page 7-49	
C144↓	Chopper-frequency reduction 821X/822X/824X	-1-	-0- No chopper-frequency lowering -1- Automatic chopper frequency reduction at $\vartheta_{max} - 10^\circ\text{C}$	Page 7-29	
C161*	Current fault			Page 8-2	Display only
C162*	Last fault			Page 8-2	
C163*	Last but one fault			Page 8-2	
C164*	Last but two fault			Page 8-2	
C170↓	TRIP-reset selection		-0- TRIP reset by pressing the STP key or LOW signal at ctrl. enable or fieldbus -1- Auto TRIP reset or TRIP reset by pressing the STP key or LOW signal at ctrl. enable or fieldbus	Page 8-4	
C171	Deceleration for Auto-TRIP reset	0.00	0.00 {0.01 s} 60.00	Page 8-4	
C178*	Operating time			Page 7-64	Display only

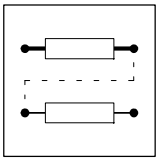

Configuration

Code	Name	Possible settings			Info	IMPORTANT
		Lenze	Choice			
C179*	Mains connection time				Page 7-64	Display only
C377* ↙	Gain voltage detection 822X/824X					Should only be changed by the Lenze Service!
C500*	Display factor Application datum numerator 821X/822X/824X	2000	1	{1}	25000	Page 7-63
C501*	Display factor for process variable denominator 821X/822X/824X	10	1	{1}	25000	Page 7-63

EDS8200U--D2
00406186

Manual

Part D2

Code table

for the series
8210/20/40 HVAC (V020)

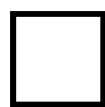

Global Drive
Frequency inverters 8200

This Manual is valid for 82XX controllers as of version:

	33.820X-	E-	1x.	1x		(8201 - 8204)
	33.8202-	E-	1x.	1x	-V002	Reduced assembly depth (8202)
	33.821X-	E-	0x.	1x		(8211 - 8218)
	33.821X-	E-	1x.	2x		(8211 - 8218)
	33.821X-	C-	1x.	2x	-V003	Cold plate (8215 - 8218)
	33.821X-	E-	3a.	3x	-V020	HVAC (8211 - 8218)
	33.822X-	E-	0x.	0x		(8221 - 8227)
	33.822X-	C-	1x.	2x	-V003	Cold plate (8221 - 8222)
	33.822X-	E-	3a.	3x	-V020	HVAC (8221 - 8227)
	33.824X-	E-	1x.	1x		(8241 - 8246)
	33.824X-	C-	1x.	1x	-V003	Cold plate (8241 - 8246)
	33.824X-	E-	3a.	3x	-V020	HVAC (8241 - 8246)
Type						
Design: B = Module C = Cold plate E = Built-in unit IP20						
Hardware version and index						
Software version and index						
Variant						
Explanation						

		revised	
Edition of:	01/1999		

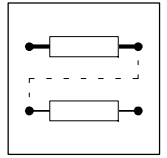

7.9 Code table for “HVAC” series

How to read the code table:

Column	Abbreviation	Meaning
Code	C013	Code C013 <ul style="list-style-type: none"> The parameter of the code can be different in PAR1 and PAR2. The parameter value is accepted immediately (ONLINE).
	C009*	<ul style="list-style-type: none"> The parameter value of the code is always the same in PAR1 and PAR2, but is always displayed in PAR1.
	C001 ↵	<ul style="list-style-type: none"> The parameter value of the code will be accepted after pressing SH+ PRG.
	[C002]	<ul style="list-style-type: none"> The parameter value of the code will be accepted after pressing SH+ PRG, but only if the controller is inhibited.
	C010*	<ul style="list-style-type: none"> Parameter value of the code will only be displayed in [Hz], if C500 = 2000 and C501 = 10 (factory setting). See chapter 7.6.3.
Name	821X	Name of the code. Controller-specific setting possibilities (here for 821X). Without unit designation, the code is valid for all unit types.
Lenze		Factory setting of the code
	*	The column “Important” contains further information.
Choice	1 {1 %} 99	Min. value {Steps/Unit} Max. value
Info	-	Meaning of the code
IMPORTANT	-	Additional, important explanation of the code

Code	Name	Possible settings			IMPORTANT
		Lenze	Choice	Info	
C001 ↵	Operating mode	-0-	-0- Setpoint selection via term. 8 Control via terminals Parameter setting via 8201BB -1- Setpoint selection via 8201BB or LECOM Control via terminals Parameter setting via 8201BB -2- Setpoint selection via term. 8 Control via terminals Parameter setting via LECOM -3- Setpoint selection via LECOM Control via LECOM Parameter setting via LECOM	Page 7-9, 7-42	
[C002]*	Parameter set	-0-	-0- Function executed -1- Overwrite PAR1 with factory setting -2- Overwrite PAR2 with factory setting -3- Overwrite PAR1 and PAR2 with the data of the operating module -4- Overwrite PAR1 with the data of the operating module -5- Overwrite PAR2 with the data of the operating module -6- Transmit PAR1 and PAR2 to the operating module -7- Overwrite PAR1, PAR2 and the unit-dependent data (C016, C036, C088, C091) with the data of the operating module	Page 7-10	

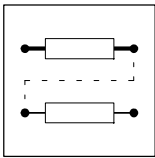

Configuration

Code	Name	Possible settings			IMPORTANT
		Lenze	Choice	Info	
C003↓	Save parameter set	-1-	-0- -1-	Data will not be saved on EEPROM; all data will be lost when switching off the mains Data will be saved on EEPROM; setting when switching on the mains	Page 7-8 -0- only valid for C010, C011, C012, C013, C037, C038, C105, C181 and C182
C004↓	Switch-on display	-0-	-0- -1- -2-	Field frequency f_d Unit load Motor current	Page 7-62
C005↓	Configuration	-0-	-0- -1- -2- -3- -6- -7-	Operation with open-loop control via terminal 8 Operation with open-loop control via terminal 8 with setpoint summation via frequency input E1 Operation with open-loop control via frequency input E1 with setpoint summation via terminal 8 Open loop operation via frequency input E1 with limitation of the apparent motor current via terminal 8 Operation with closed-loop control; setpoint via terminal 8 with digital frequency feedback via terminal E1 Operation with closed-loop control, setpoint via frequency input E1 with analog feedback via terminal 8	Page 7-26, 7-61 If C005 = -0- • 2 ms cycle time If C005 = -1- ... -7- • 4 ms cycle time C005 = -4-, -5- not applicable C005 = -3- with C014 = -2-, -4- possible
C007↓	Terminal configuration	-0-	-0- -1- -2- -3- -4- -5- -6- -7- -8- -9- -10-	E4 E3 E2 E1 CW/CCW GSB JOG1/2/3 CW/CCW PAR JOG1/2/3 CW/CCW QSP JOG1/2/3 CW/CCW PAR GSB JOG1 CW/CCW QSP PAR JOG1 CW/CCW GSB TRIP set JOG1 CW/CCW PAR TRIP set JOG1 CW/CCW PAR GSB TRIP set CW/CCW QSP PAR TRIP set CW/CCW QSP TRIP set JOG1 CW/CCWTRIP set UP DOWN	Page 7-10, 7-44, 7-46, 7-50, 7-54, 7-58, • R = CW rotation • L = CCW rotation • GSB = DC-injection brake • PAR = Parameter set changeover • JOG = Fixed frequency • QSP = Quick stop

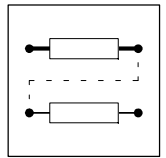

Code	Name	Possible settings				IMPORTANT	
		Lenze	Choice				Info
C007 (continued)	Terminal configuration	-0-	E4	E3	E2	E1	<ul style="list-style-type: none"> • TRIP Set = External fault • UP/DOWN = Motor potentiometer functions • H/Re = Manual/remote changeover • I-OFF = Reset of the I-component of the PID controller • D/F = Digital frequency input 0 - 10 kHz • EINFL_0 = Set the influence of the PID controller to 0 <p>For parameter set changeover via terminals, the corresponding terminal must be assigned with PAR in both parameter sets.</p>
		-11-	CW/CCW	GSB	UP	DOWN	
		-12-	CW/CCW	PAR	UP	DOWN	
		-13-	CW/CCW	QSP	UP	DOWN	
		-14-	CCW/QSPCW/QSP	GSB	JOG1		
		-15-	CCW/QSPCW/QSP	PAR	JOG1		
		-16-	CCW/QSPCW/QSP	JOG1/2/3			
		-17-	CCW/QSPCW/QSP	PAR	GSB		
		-18-	CCW/QSPCW/QSP	PAR	TRIP set		
		-19-	CCW/QSPCW/QSP	GSB	TRIP set		
		-20-	CCW/QSPCW/QSP	TRIP set	JOG1		
		-21-	CCW/QSPCW/QSP	UP	DOWN		
		-22-	CCW/QSPCW/QSP	UP	JOG1		
		-23-	H/Re	CW/CCW	UP	DOWN	
		-24-	H/Re	PAR	UP	DOWN	
		-25-	H/Re	GSB	UP	DOWN	
		-26-	H/Re	JOG1	UP	DOWN	
		-27-	H/Re	TRIP set	UP	DOWN	
		-28-	JOG1/2/3		I-OFF	D/F	
		-29-	JOG1	GSB	I-OFF	D/F	
		-30-	JOG1	QSP	I-OFF	D/F	
		-31-	GSB	QSP	I-OFF	D/F	
		-32-	TRIP set	QSP	I-OFF	D/F	
		-33-	QSP	PAR	I-OFF	D/F	
		-34-	CCW/QSPCW/QSP		I-OFF	D/F	
		-35-	JOG1/2/3		PAR	D/F	
		-36-	GSB	QSP	PAR	D/F	
		-37-	JOG1	QSP	PAR	D/F	
		-38-	JOG1	PAR	TRIP set	D/F	
		-39-	JOG1/2/3		TRIP set	D/F	
		-40-	JOG1	QSP	TRIP set	D/F	
		-41-	JOG1	GSB	TRIP set	D/F	
		-42-	QSP	GSB	TRIP set	D/F	
		-43-	CW/CCW	QSP	TRIP set	D/F	
		-44-	UP	DOWN	PAR	D/F	
		-45-	CW/CCW	QSP	PAR	D/F	
		-46-	H/Re	PAR	QSP	JOG1	
		-47-	CW/QSPCCW/QSP	H/Re	JOG1		
		-48-	INFL_0	GSB	I-OFF	D/F	
		-49-	INFL_0	JOG1	QSP	D/F	
		-50-	INFL_0	JOG1	I-OFF	D/F	
		-51-	GSB	PAR	I-OFF	D/F	

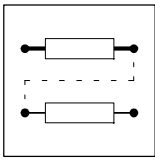

Configuration

Code	Name	Possible settings				IMPORTANT	
		Lenze	Choice		Info		
C008 \downarrow	Function relay K1	-1-	-0-	Ready for operation	Page 7-65		
			-1-	TRIP fault message			
			-2-	Motor is running			
			-3-	Motor is running / CW rotation			
			-4-	Motor is running / CCW rotation			
	-5-	Field frequency $f_d = 0$					
	-6-	f_{dset} reached					
	-7-	Q_{min} reached					
	-8-	I_{max} reached					
	-9-	Overtemperature ($\vartheta_{max} - 10\text{ }^\circ\text{C}$)					
	-10-	TRIP or Q_{min} or IMP					
	822X/824X		-11-	PTC warning			
			-12-	Apparent motor current (C054) < threshold C156			
			-13-	Apparent motor current (C054) < current threshold C156 and $f_d > Q_{min}$ threshold (C017)			
			-14-	Apparent motor current (C054) < threshold C156 and input of ramp function generator = output of ramp function generator			
	822X/824X		-15-	Warning motor phase failure			
			-16-	f_d (C050) < f_{dmin} (C010)			
C009* \downarrow	Device address	1	1	{1}	99	Only for LECOM applications	
C010•	Minimum field frequency	0.00	0.00	{0.02 Hz}	480.00	Page 7-15	
C011•	Maximum field frequency	50.00	7.50	{0.02 Hz}	480.00	Page 7-15	
C012	Acceleration time T_{ir}	5.00	0.00	{0.02 s}	1300.00	Page 7-16	
C013	Deceleration time T_{if}	5.00	0.00	{0.02 s}	1300.00	Page 7-16, 7-55	
C014 \downarrow	Control mode	-4-	-2-	Linear characteristic $V \sim f_d$ with constant V_{min} boost	Page 7-19, 7-22, 7-24		
			-3-	Square characteristic $V \sim f_d^2$ with constant V_{min} boost			
			-4-	Motor-current control			
C015	V/f rated frequency	50.00	7.50	{0.02 Hz}	960.00	Page 7-22	
C016	V_{min} setting	*	0.00	{0.02 %}	40.00	Page 7-24	* depends on the unit
C017•	Threshold Q_{min}	0.00	0.00	{0.02 Hz}	480.00	Page 7-65	
C018 \downarrow	Chopper frequency	-1-	-0-	4 kHz power-loss optimised	Page 7-29		
			-1-	8 kHz, power-loss optimised			
			-2-	12 kHz power-loss optimised			
			-3-	16 kHz power-loss optimised			
			-4-	4 kHz noise optimised			
			-5-	8 kHz noise optimised			
			-6-	12 kHz noise optimised			
			-7-	16 kHz noise optimised			
C019•	Threshold auto DC brake	0.10	0.00	{0.02 Hz}	5.00	Page 7-56	

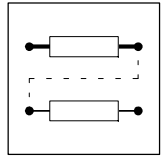

Code	Name	Possible settings				Info	IMPORTANT
		Lenze	Choice				
C021	Slip compensation	0.0*	-50.0	{0.1 %}	50.0	Page 7-28	* If C014 = -2-, -3-, controller dependent
		0.0	0.0	{0.1 %}	20.0		If C014 = -4-
C022	I_{max} limit (motor mode)	150	30	{1 %}	150	Page 7-17	
C023	I_{max} limit (generator mode)	80	30	{1 %}	150	Page 7-17	The current-limit controller for operation in generator mode is not active at 30 %.
C026	Offset adjustment analog input	0.00	-10.00	{0.01 V}	10.00	Page 7-40	C026 < 0 V • f_{dmin} can fall below the value set under C010
C027	Scaling factor of analog input	100.0	-200.0	{0.1 %}	200.0	Page 7-40	
C034 \downarrow	Master current	-0-	-0- 0 to 20 mA / -1- 0 to 5 V / 0 to 10 V 4 to 20 mA			Page 7-40	
C035* \downarrow	Selection DC brake	-0-	-0- Selection of brake voltage under C036 -1- Selection of brake current under C036			Page 7-56	
C036	Voltage/current for DCB	*	0.00	{0.02 %}	150.00	Page 7-56	* depends on the unit
C037•	JOG value 1	20.00	-480.00	{0.02 Hz}	480.00	Page 7-43	
C038•	JOG value 2	30.00	-480.00	{0.02 Hz}	480.00	Page 7-43	
C039•	JOG value 3	40.00	-480.00	{0.02 Hz}	480.00	Page 7-43	
C040	Controller enable	*	-0- Controller inhibited -1- Controller enabled			Page 7-62	
C043	TRIP reset	*	-0- No current fault -1- Current fault				* see Operating Instructions 2102
C046•	Frequency setpoint	*	-480.00	{0.02 %}	480.00	Page 7-62	
C047*	Current setpoint I_{max} limit value					Page 7-62	Display only [%] I_{max} limit value (C022)
C049*•	Additional setpoint					Page 7-47, 7-62	Display only • Only if C005 = 1, 2
C050*•	Output frequency					Page 7-62	
C051*•	Actual PID controller value					Page 7-34, 7-62	Display only
C052*	Motor voltage					Page 7-62	
C053*	DC-bus voltage					Page 7-62	Display only [V]
C054*	Motor current					Page 7-62, 7-65	Display only [A]
C056*	Unit load					Page 7-62	Display only [%]
C061*	Heat sink temperature					Page 7-62	Display only [°C]

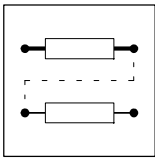

Configuration

Code	Name	Possible settings				Info	IMPORTANT
		Lenze	Choice				
C070	Gain PID controller	1.00	0.00	{0.01}	300.00	Page 7-34	0.0 = P-component not active
C071	Integral action time PID controller	100	10		9999	Page 7-34	9999 = I-component not active
C072	Differential component of PID controller	0.0	0.0	{0.1}	5.0	Page 7-34	0.0 = D-component not active
C074	Influence PID controller	0.0	0.0	{0.1 %}	100.0	Page 7-34	
C077*	Gain I_{max} controller	0.25	0.00	{0.01}	1.00	Page 7-18	
C078*	Integral action time I_{max} controller	65	12	{1 ms}	9990	Page 7-18	
C079	Oscillation damping	*				Page 7-31	
		822X/824X	5	0	{1}		
C088	Rated motor current	*	0	{1 A}	480	Page 7-27	* depends on the unit
C091	Motor $\cos \varphi$	*	0.0 ... 2.0 · rated output current			Page 7-27	
			0.4	{0.1}	1.0		
C093*	Type					Page 7-64	Display only
		821X	821X				
		822X	822X				
		824X	824X				
C099*	Software version		82 3x	(Software 3x)		Page 7-64	
C105	Deceleration time QSP	5.00	0.00	{0.02 s}	1300.00	Page 7-55	
C106	Holding time for autom. DC injection brake	0.02	0.00	{0.01 s}	999.00	Page 7-56	
C108*	Gain (C111)	128	0	{1}	255	Page 7-69	

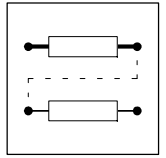

Code	Name	Possible settings				Info	IMPORTANT		
		Lenze	Choice						
C111 _d	Monitor signal	-0-	-0-	Field frequency			Page 7-69	Selection -9- ... -25- corresponds to the relay output functions C008 and C117: • LOW = 0 V • HIGH = 10 V	
			-1-	Unit load					
			-2-	Motor current					
			-3-	DC-bus voltage					
			-4-	Motor power					
			-5-	Motor voltage					
			-6-	Analog output $1/f_d$ (1/C050)					
			-7-	Field frequency of f_{dmin} (C010) ... f_{dmax} (C011)					
			-8-	Actual PID controller value					
				-9-	Ready for operation				
		-10-	TRIP fault message						
		-11-	Motor is running						
		-12-	Motor is running / CW rotation						
		-13-	Motor is running / CCW rotation						
		-14-	Field frequency $f_d = 0$						
		-15-	f_{dset} reached						
		-16-	Q_{min} reached						
		-17-	I_{max} reached						
		-18-	Overtemperature ($\vartheta_{max} - 10^\circ$)						
		-19-	TRIP, Q_{min} or IMP set						
	822X/824X		-20-	PTC warning					
			-21-	Apparent motor current (C054) < current threshold (C156)					
			-22-	Apparent motor current (C054) < current threshold (C156) and $f_d > Q_{min}$ threshold					
			-23-	Apparent motor current (C054) < threshold (C156) and input of ramp function generator = output of ramp function generator					
	822X/824X		-24-	Warning motor phase failure					
			-25-	f_d (C050) < f_{dmin} (C010)					
C114 _d	Signal level digital inputs	-0-	E4	E3	E2	E1	Page 7-52	0: Ex is not inverted 1: Ex is inverted	
			-0-	0	0	0			0
			-1-	0	0	0			1
			-2-	0	0	1			0
			-3-	0	0	1			1
			-4-	0	1	0			0
			-5-	0	1	0			1
			-6-	0	1	1			0
			-7-	0	1	1			1
			-8-	1	0	0			0
			-9-	1	0	0			1
			-10-	1	0	1			0
			-11-	1	0	1			1
			-12-	1	1	0			0
			-13-	1	1	0			1
			-14-	1	1	1			0
-15-	1	1	1	1					

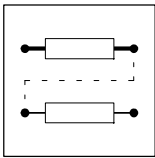

Configuration

Code	Name	Possible settings					Info	IMPORTANT	
		Lenze	Choice						
C115↓	Priority mask digital inputs	-0-	E4	E3	E2	E1	Page 7-53	0: Function Ex depends on C001 1: Function Ex is independent of C001 • Ctrl. inhibit and TRIP reset always have first priority. • With -0- also TRIP set and QSP have priority.	
			-0-	0	0	0			0
			-1-	0	0	0			1
			-2-	0	0	1			0
			-3-	0	0	1			1
			-4-	0	1	0			0
			-5-	0	1	0			1
			-6-	0	1	1			0
			-7-	0	1	1			1
			-8-	1	0	0			0
			-9-	1	0	0			1
			-10-	1	0	1			0
			-11-	1	0	1			1
			-12-	1	1	0			0
			-13-	1	1	0			1
			-14-	1	1	1			0
-15-	1	1	1	1					
C117↓	Function relay K2	-0-	-0-	Ready for operation			Page 7-65 ff		
			-1-	TRIP fault message					
			-2-	Motor is running					
			-3-	Motor is running / CW rotation					
			-4-	Motor is running / CCW rotation					
			-5-	Field frequency $f_d = 0$					
			-6-	f_{dset} reached					
			-7-	Q_{min} reached					
			-8-	I_{max} reached					
			-9-	Overtemperature ($\vartheta_{max} -10^\circ\text{C}$)					
822X/824X			-10-	TRIP or Q_{min} or IMP					
			-11-	PTC warning					
			-12-	Apparent motor current (C054) < threshold C156					
			-13-	Apparent motor current (C054) < current threshold C156 and $f_d > Q_{min}$ threshold (C017)					
			-14-	Apparent motor current (C054) < threshold C156 and input of ramp function generator = output of ramp function generator					
			-15-	Warning motor phase failure					
822X/824X			-16-	f_d (C050) < f_{dmin} (C010)					
C119↓	Function PTC 822X/824X	-0-	-0-	PTC input not active			Page 7-72		
			-1-	PTC input active, TRIP and pulse inhibit will be set					
			-2-	PTC input active Warning					
C120	I^2t switch-off 822X/824X	0	0	{1 %}	100	Page 7-71	If C120 = 0, the function is not active		

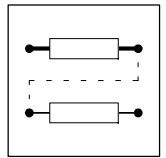

Code	Name	Possible settings			IMPORTANT
		Lenze	Choice	Info	
C125 _↓ *	LECOM baud rate	-0-	-0- 9600 baud -1- 4800 baud -2- 2400 baud -3- 1200 baud -4- 19200 baud		Only for LECOM applications
C126*	Selection of communication fault	-0-	-0- No TRIP when stopping the communication in the process channel -1- TRIP (-CEO-) when stopping the communication in the process channel		Only for bus operation
C127	Choice Set-value input	-0-	-0- Absolute setpoint selection in Hz via C046 or process channel -1- Normalised setpoint selection via C141 (0 ... 100 %) or process channel ($\pm 16384 = f_{dmax} (C011)$)		
C135*	Control word				See Operating Instructions 2102
C141*	Standardised setpoint		-100.00 {0.01 %} 100.00		Only for bus operation Only when C127 = 1 active
C142 _↓	Start condition	-1-	-0- Automatic start inhibited, flying-restart circuit not active -1- Automatic start, if term. 28 HIGH, flying-restart circuit not active -2- Automatic start inhibited, flying-restart circuit active -3- Automatic start, if term. 28 HIGH, flying-restart circuit active	Page 7-49	
C144 _↓	Chopper frequency reduction	-1-	-0- No chopper-frequency reduction -1- Automatic chopper frequency reduction at $\vartheta_{max} - 10 \text{ }^\circ\text{C}$	Page 7-29	
C150*	Status word				See Operating Instructions 2102
C156*	Current threshold	0	0 {1 %} 150	Page 7-65 E.g. with belt monitoring	
C161*	Actual fault			Page 8-2	Display only
C162*	Last fault			Page 8-2	
C163*	Last but one fault			Page 8-2	
C164*	Last but two fault			Page 8-2	
C170 _↓	TRIP-reset selection		-0- TRIP reset by pressing the STP key or LOW signal at ctrl. enable or fieldbus -1- Auto TRIP reset or TRIP reset by pressing the STP key or LOW signal at ctrl. enable or fieldbus	Page 8-4	
C171	Deceleration for Auto-TRIP reset	0.00	0.00 {0.01 s} 60.00	Page 8-4	
C178*	Operating time			Page 7-64	Display only
C179*	Mains connection time			Page 7-64	
C181*•	Setpoint PID controller	0.00	-480.00 {0.02 Hz} 480.00	Page 7-34, 7-38	Only with C181 \neq 0 active

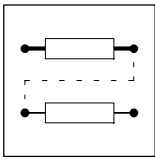

Configuration

Code	Name	Possible settings				Info	IMPORTANT	
		Lenze	Choice					
C182*	Integration time ramp function generator S-shape	0.00	0.00	{0.01 s}	50.00	Page 7-32	<ul style="list-style-type: none"> • C182 = 0.00 - Linear ramp function generator • C182 > 0.00 - Ramp function generator S shape with T_i time = C182 	
C196*↓	Input condition autom. DC injection brake	-0-	-0- -1-	DC brake active at C050 < C019 DC brake active at C050 < C019 and Setpoint < C019		Page 7-56		
C200	Software EKZ							
C238↓	Frequency precontrol	-1-	-0- -1-	No precontrol With setpoint precontrol		Page 7-34, 7-39		
C239↓	Frequency setting range	-0-	-0- -1-	Bipolar Unipolar		Page 7-39		
C304	Password1						Should only be changed by the Lenze Service!	
C305	Password2							
C307	Contents of the address							
C308	Address							
C377*↓	Gain voltage detection 822X/824X							
C395	LWORD process input data						Only for bus operation	
C396	LWORD process output data							
C425*↓	Adjustment of digital frequency	-2-	-0- -1- -2- -3- -4-	Dig.- freq. 100 Hz 1 kHz 10 kHz 10 kHz	Reso- lution 1/200 1/200 1/200 1/1000 1/10000	Scann- ing 1 s 100 ms 10 ms 50 ms 500 ms	Max.- freq. 300 Hz 3 kHz 10 kHz 10 kHz	Page 7-60 When using the analog input module 9279 for the frequency input E1: <ul style="list-style-type: none"> • Set C425 to 2, 3 or 4
C426*	Gain adjustment frequency input E1	100	-200.0	{0.1 %}	200.0	Page 7-60		
C427	Offset adjustment frequency input E1	0.0	-12.5	{0.1 %}	12.5	Page 7-60		
C500*	Display factor Application datum numerator	2000	1	{1}	25000	Page 7-63		
C501*	Display factor for process variable denominator	10	1	{1}	25000	Page 7-63		
C597*↓	Activation of motor phase failure detection 822X/824X	-0-	-0- -1- -2-	Inactive TRIP Warning		Page 7-73		

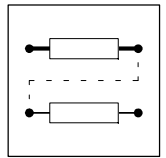

Code	Name	Possible settings				IMPORTANT	
		Lenze	Choice		Info		
C599* ↓	Current limit value Motor phase failure detection 822X/824X	5	1	{1 %}	50	Page 7-73	
C625*•	Skip frequency 1	480.00	0.00	{0.02 Hz}	480.00	Page 7-33	
C626*•	Skip frequency 2	480.00	0.00	{0.02 Hz}	480.00	Page 7-33	
C627*•	Skip frequency 3	480.00	0.00	{0.02 Hz}	480.00	Page 7-33	
C628*	Bandwidth of skip frequencies	0.00	0.00	{0.01 %}	100.00	Page 7-33	
C988*	DC-bus voltage threshold for DC-bus voltage control	0	0	{1 %}	200	Page 7-12	<ul style="list-style-type: none"> • C988 = 0 % - No parameter set changeover via DC-bus voltage • C988 = 1 ... 200 % - Parameter set changeover via DC-bus voltage is active <p>Parameter set changeover via terminal or LECOM is not possible with C988 > 0!</p>

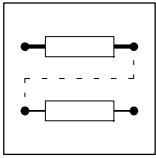

Configuration

EDS8200U--E
00406187

Manual

Part E

*Troubleshooting and
fault elimination*

Maintenance

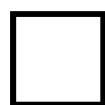

Global Drive
Frequency inverters 8200

This Manual is valid for 82XX controllers as of version:

	33.820X-	E-	1x.	1x		(8201 - 8204)
	33.8202-	E-	1x.	1x	-V002	Reduced assembly depth (8202)
	33.821X-	E-	0x.	1x		(8211 - 8218)
	33.821X-	E-	1x.	2x		(8211 - 8218)
	33.821X-	C-	1x.	2x	-V003	Cold plate (8215 - 8218)
	33.821X-	E-	3a.	3x	-V020	HVAC (8211 - 8218)
	33.822X-	E-	0x.	0x		(8221 - 8227)
	33.822X-	C-	1x.	2x	-V003	Cold plate (8221 - 8222)
	33.822X-	E-	3a.	3x	-V020	HVAC (8221 - 8227)
	33.824X-	E-	1x.	1x		(8241 - 8246)
	33.824X-	C-	1x.	1x	-V003	Cold plate (8241 - 8246)
	33.824X-	E-	3a.	3x	-V020	HVAC (8241 - 8246)
Type						
Design: B = Module C = Cold plate E = Built-in unit IP20						
Hardware version and index						
Software version and index						
Variant						
Explanation						

		revised	
Edition of:	01/1999		



8 Troubleshooting and fault elimination

Occuring faults can be easily recognized through the display elements or status information (chapter 8.1).

The faults can be analysed with the history buffer (chapter 8.2) and the list in chapter 8.3, which helps you to eliminate the faults.

8.1 Troubleshooting

8.1.1 Display at the controller

During operation without operating module, two LEDs at the front indicate the operating status of the controller.

LED		Operating status
green	red	
on	off	Controller enabled
on	on	Mains switched on, automatic start inhibited (AS_LC)
blinking	off	Controller inhibited
off	blinking every second	Fault message, check under C161
off	blinking every 0.4 seconds	Undervoltage switch-off
off	off	Programming mode (only 820X)

8.1.2 Display at the operating module

Status message in the display indicate the controller status.

Display	Meaning
OV	Overvoltage
UV	Undervoltage
IMAX	Set current limit exceeded
TEMP	Heat sink temperature near switch-off limit



Troubleshooting and fault elimination

8.1.3 Maloperation of the drive

Maloperation	Possible causes
Motor does not rotate	<ul style="list-style-type: none"> • DC-bus voltage too low (Red LED is blinking every 0.4 seconds, message LU is indicated) • Controller inhibited (Green LED is blinking, display of the operating module: OFF, STOP or AS_LC) • Setpoint = 0 • DC braking active • Quick-stop function active • JOG setpoint activated and JOG frequency = 0 • Fault message is displayed (see chapter 8.3) • Mechanical motor brake is not released
Motor does not rotate smoothly	<ul style="list-style-type: none"> • Defective motor cable • Maximum current C022 and C023 too low • Motor underexcited or overexcited (check parameter setting)
Current consumption of motor too high	<ul style="list-style-type: none"> • Setting of C016 too high • Setting of C015 too low • C088 and C091 are not adapted to the motor data

8.2 Fault analysis with the history buffer

The history buffer is used to trace faults. The fault messages are stored in the history buffer in the order of their occurrence.

The memory locations can be retrieved via the codes.

Structure of the history buffer			
Code	Memory unit	Entry	Note
C161	Memory unit 1	Active fault	If the fault is no longer active or has been acknowledged: <ul style="list-style-type: none"> • The contents of the memory locations 1 - 3 will be saved in a "higher" location. • The contents of the memory location 4 will be eliminated from the history buffer and cannot be read any longer. • Memory location 1 will be deleted (= no active fault).
C162	Memory unit 2	Last fault	
C163	Memory unit 3	Last but one fault	
C164	Memory unit 4	Last but two fault	

8.3 Fault messages

Display	Fault	Cause	Remedy
---	No fault	-	-
EEr	External fault (TRIP-Set)	A digital input assigned to the TRIP-Set function has been activated.	Check external encoder
H05	Internal fault		Contact Lenze
LP1	Motor phase failure	<ul style="list-style-type: none"> - Failure of one or several motor phases - Motor current too low 	Check motor cables, check V_{\min} setting, connect motor with corresponding power or adapt motor under C599.
LU	Undervoltage	DC-bus voltage too low	<ul style="list-style-type: none"> • Check mains voltage • Check supply module
OC1	Short-circuit	Short-circuit	Find out cause of short circuit; check cable
		Excessive capacitive charging current of the motor cable	Use shorter motor cables or cables with less capacitance



Display	Fault	Cause	Remedy
OC2	Earth fault	Grounded motor phase	Check motor; check cable
		Excessive capacitive charging current of the motor cable	Use motor cable which is shorter or has a lower capacitance
OC3	Overload inverter during acceleration or short circuit	Acceleration time too short (C012)	<ul style="list-style-type: none"> • Increase acceleration time • Check drive selection
		Defective motor cable	Check wiring
		Interturn fault in the motor	Check motor
OC4	Overload controller during deceleration	Deceleration time too short (C013)	<ul style="list-style-type: none"> • Increase deceleration time • Check the selection of the brake resistor or connect the brake chopper
OC5	I x t overload	Frequent and too long acceleration processes with overcurrent	Check drive selection
		Permanent overload with $I_{motor} > 1.05 \times I_x$	
OC6	Overload motor	Motor is thermally overloaded, for instance, because of <ul style="list-style-type: none"> • impermissible continuous current • frequent or too long acceleration processes 	<ul style="list-style-type: none"> • Check drive selection • Check the setting under C120
OH	Heat sink temperature is higher than the value set in the controller	Ambient temperature $T_{amb} > +40\text{ °C}$ or $+50\text{ °C}$	<ul style="list-style-type: none"> • Allow controller to cool and ensure ventilation • Check the ambient temperature in the control cabinet
		Heat sink very dirty	Clean heat sink
		Incorrect mounting position	Change mounting position
OH3	PTC monitoring	Motor too hot because of excessive currents or frequent and too long accelerations	Check drive selection
		PTC not connected	Connect PTC or switch-off monitoring (C0585 = 3)
OH4	Overtemperature unit	Inside unit too hot	<ul style="list-style-type: none"> • Reduce controller load • Improve cooling • Check fan in the controller
OU	Overvoltage	Mains voltage too high	Check voltage supply
		Feedback operation Braking operation	<ul style="list-style-type: none"> • Prolong deceleration times • For operation with brake choppers: <ul style="list-style-type: none"> - Check the selection and connection of the brake resistor - Increase the deceleration times
		Earth leakage on the motor side	Check motor cable and motor for earth fault (disconnect motor from inverter)
OUE	Overvoltage	Mains overvoltage longer than 5 s	Check mains voltage
Pr	Faulty parameter transfer via the operating module	PAR1 and PAR2 are defective	It is absolutely necessary to repeat the data transfer or load the factory setting before enabling the controller.
Pr1	Faulty PAR1 transfer via the operating module	PAR1 is defective	
Pr2	Faulty PAR2 transfer via the operating module	PAR2 is defective	
rSt	Faulty auto-TRIP reset	More than 8 fault messages in 10 minutes	Depends on the fault message



8.4 Reset of fault messages

TRIP

After eliminating the fault, the pulse inhibit will only be reset after the acknowledgement of TRIP.



Note!

If the TRIP source is still active, the TRIP cannot be reset.

Code	Name	Possible settings			IMPORTANT
		Lenze	Choice	Info	
C170	TRIP-reset selection		-0- TRIP reset by pressing the STP key or LOW signal at ctrl. enable or fieldbus -1- Auto-TRIP reset or TRIP reset by pressing the STP key or LOW signal at ctrl. enable or fieldbus		
C171	Deceleration for Auto-TRIP reset	0.00	0.00 {0.01 s}	60.00	

Function

You can select whether the fault is to be reset automatically or manually. Auto-TRIP reset does not reset all faults automatically.

Activation

C170 = -0-:

- TRIP reset (fieldbus)
- STP key
- LOW signal at terminal 28

C170 = -1-:

- Auto-TRIP reset resets all faults after the time set under C171.
- TRIP reset (fieldbus)
- STP key
- LOW signal at terminal 28

Important

- Mains switching always resets TRIP.
- With more than 8 auto-TRIP resets within 10 minutes (internal counter), the controller sets TRIP and indicates rST (counter exceeded).
 - With TRIP reset by pressing the STP key or LOW signal at ctrl. enable or fieldbus, the controller resets the internal counter.



9 Maintenance

9.1 Maintenance services

- The controller is free of maintenance, if the prescribed conditions are observed (see chapter 3.3).
- If the ambient air is polluted, the air vents of the controller may be obstructed.
 - Check the air vents periodically (depending on the degree of pollution approx. every 4 weeks).
 - Free the obstructed air vents using a vacuum cleaner.



Stop!

Do not use sharp or pointed tools, such as knives or screwdrivers, to clean the air vents.



9.2 Service addresses

The addresses of your Lenze world-wide representatives are listed on the back cover of every Lenze publication.

EDS8200U--F
00406188

Manual

Part F

Network of several drives



Global Drive
Frequency inverters 8200

This Manual is valid for 82XX controllers as of version:

	33.820X-	E-	1x.	1x		(8201 - 8204)
	33.8202-	E-	1x.	1x	-V002	Reduced assembly depth (8202)
	33.821X-	E-	0x.	1x		(8211 - 8218)
	33.821X-	E-	1x.	2x		(8211 - 8218)
	33.821X-	C-	1x.	2x	-V003	Cold plate (8215 - 8218)
	33.821X-	E-	3a.	3x	-V020	HVAC (8211 - 8218)
	33.822X-	E-	0x.	0x		(8221 - 8227)
	33.822X-	C-	1x.	2x	-V003	Cold plate (8221 - 8222)
	33.822X-	E-	3a.	3x	-V020	HVAC (8221 - 8227)
	33.824X-	E-	1x.	1x		(8241 - 8246)
	33.824X-	C-	1x.	1x	-V003	Cold plate (8241 - 8246)
	33.824X-	E-	3a.	3x	-V020	HVAC (8241 - 8246)
Type						
Design: B = Module C = Cold plate E = Built-in unit IP20						
Hardware version and index						
Software version and index						
Variant						
Explanation						

		revised	
Edition of:	01/1999		

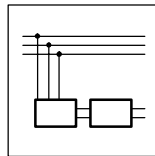

10 Network of several drives

10.1 Function

- A DC-bus network of controllers enables the energy exchange between the connected controllers on the DC-voltage level.
- If one or more controllers operate in generator mode (braking), the recovered energy will be fed into the shared DC-voltage bus or the DC source. The energy will then be available in the network of controllers which operate in motor mode.
- The energy from the three-phase AC mains can be supplied as follows:
 - Central supply via a 934X supply and feedback module.
 - Decentral supply by connecting several controllers of the network to the mains.
- The use of brake units, supply units and the energy consumption from the three-phase AC mains can be reduced.
- The number of mains supplies can be perfectly adapted to your application.

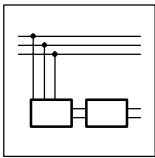

Network of several drives

10.2 Conditions for trouble-free network operation



Stop!

- The installation and assembly notes must be applied (chapter 4).
- Connect controllers only when they have similar DC-bus/mains-voltage ranges (see the following table).
- Adapt the thresholds of brake units and input and feedback modules.
- All supplies should only be operated with the prescribed mains chokes/mains filters! (See page 10-11)

10.2.1 Possible combinations

Possible combinations of Lenze controllers in DC-bus connection:

Type	Data	820X	821X	822X	824X	93XX
820X ^{**)}	①	1 / N / PE / AC / 190 ... 260 V ± 0 % / 50 Hz/60 Hz				
	②	270 V ... 360 V				
	③	375 V				
821X	①					3 / PE / AC / 320 ... 510 V ± 0 % / 50 Hz/60 Hz
	②					450 V ... 715 V
	③					725 V ^{*)}
822X	①					3 / PE / AC / 320 ... 528 V ± 0 % / 50 Hz/60 Hz
	②					460 V ... 740 V
	③					725/765 V ^{*)}
824X	①					3 / PE / AC / 320 ... 528 V ± 0 % / 50 Hz/60 Hz
	②					460 V ... 740 V
	③					725/765 V ^{*)}
93XX	①					3 / PE / AC / 320 ... 528 V ± 0 % / 50 Hz/60 Hz
	②					460 V ... 740 V
	③					725/765 V ^{*)}

① Max. permissible mains-voltage range

② DC-bus voltage range

③ Operating threshold - brake unit

^{*)} Set the thresholds of all units connected to the DC-bus to the same value.
Procedure: See the corresponding Operating Instructions.

^{**)} Central supply only possible from a DC source

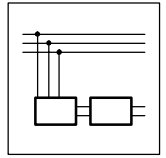

10.2.2 Mains connection

10.2.2.1 Cable protection/cable cross-section

- Mains fuses and cable cross-section of the mains cables must be selected according to the mains current which results from the input power P_{DC100} %. Observe national standards, temperatures and other conditions.
- Rule of thumb for the mains current in networks:

$$I_{\text{mains}} [\text{A}] \approx \frac{P_{\text{DC100 \%}} \cdot 575}{V_{\text{mains}}}$$

- See page 10-10.

10.2.2.2 Mains choke/mains filter

- Use the mains chokes/mains filters assigned to the network operation.
Function:
 - Mains-current limitation
 - Current/power symmetry of the mains input circuits of the controllers in decentral network operation.
- Mains choke/mains filter must be selected according to the mains current and the required radio interference suppression (see page 10-11).

10.2.2.3 Controller protection

Switch-on conditions

- **Ensure simultaneous mains connection of all controller connected to the network.**

Mains-failure detection at the controller when selecting decentral supply

- Monitoring of the mains supply of each controller:
 - In the event of failure, the controllers still connected to the mains can be overloaded.
- Measure:
 - Switch-off the whole drive network, if a mains supply fails.
- Possibilities for detecting/indicating mains failures:
 - Application of mains fuses with alarm contact.
 - Application of thermal overcurrent releases (bimetal relay), which is connected after the mains fuses.
 - Application of power switches with thermal and magnetic releases as well as integrated alarm contact to protect the cable.

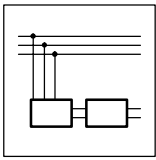

Network of several drives

10.2.3 DC-bus connection

- Use short cable connections to the shared DC-bus star point.
- Cross-section of the DC-bus connection cable $\pm U_G \leftrightarrow$ DC-bus
 - must be selected according to the fuses F1 ... F3 of the corresponding controller and the local conditions.
- Cable cross-section of the DC-bus
 - must be selected according to the sum of the mains supplies in the DC-bus (see chapter 10.2.4).
- Example:

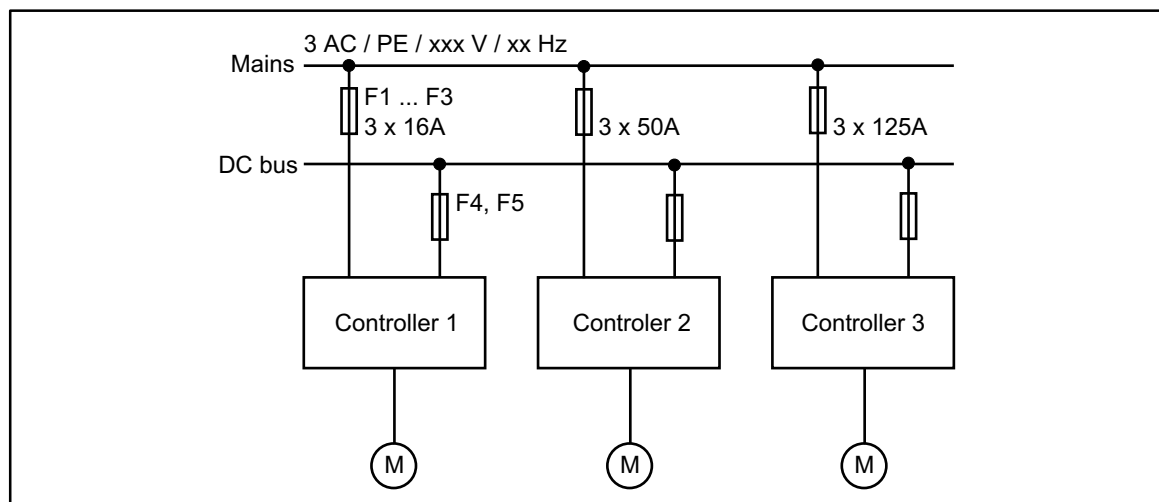
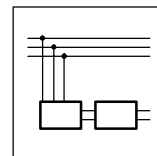
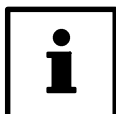

FIG 10-1 Example for the rating of the cable cross-section of the DC-bus

- Sum of the possible permanent r.m.s. currents of the parallel mains supplies: 16 A + 50 A + 125 A = 191 A
- The cable cross-section is selected according to the resulting current of 191 A and the local conditions, as for instance, ambient temperature, conductor material, conductor type, type of laying, expansion, standards, and regulations.
- Ensure smallest possible line inductivity by selecting the corresponding type of installation:
 - DC-bus star point in control cabinet above parallel busbar.
 - Cables between controller (connections $+U_G$ and $-U_G$) and DC-bus start point must be in parallel or twisted.



- Use the assigned DC-bus fuses F4, F5.
(For protection, see chapter 10.2.5).
The controller is protected by the two-pole, type-dependent protection of the controller and the DC-bus against:
 - internal short circuit,
 - internal earth fault,
 - a short circuit $+U_G \rightarrow -U_G$ on the DC-bus,
 - an earth fault via $+U_G \rightarrow PE$ or $-U_G \rightarrow PE$.



Note!

- With only two controllers connected to the network, one fuse pair F4/F5 is sufficient.
 - The rating must be made taking into account the weakest controller.
 - Connect an additional fuse pair F4/F5 before each controller, if more than two controllers are connected to the DC-bus.
-

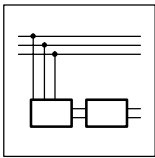

Network of several drives

10.2.4 Fuses and cable cross-sections for a network of several drives

The table values are valid for the operation of 821X/822X/824X controller in DC-bus operation with PDC100 %, i.e. use of the max. rated controller power on the DC-bus level (see page 10-10).

For operation with reduced power, it is possible to select smaller fuses and cable cross-sections.

Type	821X/822X/824X: Mains input L1, L2, L3, PE					DC input +V _{DC} , -V _{DC} , PE		
	Operation with mains filter/mains choke					Fuse F4, F5	Cable cross-section ¹⁾	
	Fuse F1, F2, F3 VDE		UL	E.l.c.b. VDE	Cable cross-section ¹⁾ mm ² AWG		mm ²	AWG
8211	M 6A	-	-	B 6A	1 17	6.3A	1	17
8212	M 6A	-	-	B 6A	1 17	6.3A	1	17
8213	M 10A	-	-	B 10A	1.5 15	12A	1.5	15
8214	M 10A	-	-	B 10A	1.5 15	12A	1.5	15
8215	M 16A	-	-	B 13A	2.5 13	16A	2.5	13
8216	M 16A	-	-	B 16A	2.5 13	20A	4	11
8217	M 32A	-	-	B 32A	6 10	40A	6	10
8218	M 32A	-	-	B 32A	6 10	40A	6	10
8221	M 50A	50A	-	-	16 5	80A	16	7
8222	M 80A	80A	-	-	25 3	100A	25	5
8223	M 80A	80A	-	-	25 3	100A	25	3
8224	M 125A	125A	-	-	70 2/0	2x 100A ²⁾	2x 25 (1x 70)	2x 3 (1x 2/0)
8225	M 125A	125A	-	-	70 2/0	2x 100A ²⁾	2x 25 (1x 70)	2x 3 (1x 2/0)
8226	M 160A	175A	-	-	95 3/0	3x 80A ²⁾	3x 16 (1x 95)	3x 5 (1x 3/0)
8227	M 200A	200A	-	-	120 4/0	3x 100A ²⁾	3x 25 (1x 120)	3x 3 (1x 4/0)
8241	M 6A	5A	-	B 6A	1 17	6.3A	1	17
8242	M 6A	5A	-	B 6A	1 17	6.3A	1	17
8243	M 10A	10A	-	B 10A	1.5 15	12A	1.5	15
8244	M 10A	10A	-	B 10A	1.5 15	12A	1.5	15
8245	M 16A	20A	-	B 16A	2.5 13	20A	4	11
8246	M 32A	25A	-	B 32A	6 10	40A	6	10

¹⁾ Observe national and regional regulations (e.g. VDE/EVU)!

²⁾ F4, F5 are possible because of parallel fuse connection.
Parallel connection cables can be used accordingly.

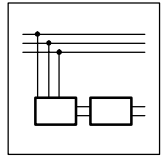

10.2.5 Protection in networks of several drives

You have the possibility of selecting a graded protection concept for network operation. The damage risk depends on the type of protection. The following table helps to analyse the risk.

Please note:

- The rating of the cable cross-section of the common DC-bus must be appropriate for the sum of parallel mains supplies:
 - The sum of the rated fuse currents is the rated value for the cross-section of the busbars.
 - Observe the local standards and regulations.
- On the motor side, the cable protection is supported by the current limitation of the controller. Condition:
 - The current limit set for the controller corresponds to the rated current of the connected motor.
 - For group drives, additional protection of the single drives is required/recommended.

Definition: "internal fault"

- Controllers:
 - The fault is located between the connection point at the DC-bus and inside the unit in front of the terminals U, V, W.
- Supply modules:
 - The fault is located between the mains input (terminals L1, L2, L3) and the farthest point of the DC-bus.

Protection by	F1 ... F3	
Protection of	Cable protection <ul style="list-style-type: none"> ● on the mains side ● on the DC-bus ● on the motor side 	No unit protection
Possible faults	One or more controllers with <ul style="list-style-type: none"> - internal short circuit (+ U_G → -U_G) - internal earth fault (+ U_G → PE / -U_G → PE) - motor-side earth fault on phase W 	Mains failure of a controller with decentral supply.
Risk	Several parallel controllers supply the fault location(s) via the DC-bus. This may lead to overload of the intact controller, as the faulty controller is not selectively activated on the DC-bus. <ul style="list-style-type: none"> ● Possible damage with central and decentral supply <ul style="list-style-type: none"> - destruction of the controller concerned - destruction of the controllers still intact - destruction of the supply unit 	If a mains-side supply/input fails because F1 ... F3 blows, the active controller which is connected can be overloaded.
Note	The extent of destructions depends on the ratio "DC-bus power of the whole system / rated power of the controller concerned".	

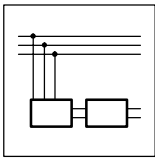

Network of several drives

Protection by	F1 ... F3 with alarm contact		
Protection of	Cable protection <ul style="list-style-type: none"> • on the mains side • on the DC-bus • on the motor side 	Unit protection in the event of overload If a supply/input fails because F1 ... F3 blows, the remaining controllers which are connected will not be overloaded as the alarm contact switches off the mains and thus the whole network.	No unit protection in the event of short circuit
Possible faults	One or more controllers with <ul style="list-style-type: none"> - internal short circuit (+ U_G → - U_G) - internal earth fault (+ U_G → PE / - U_G → PE) - motor-side earth fault on phase W 		
Risk	Several parallel controllers supply the fault location(s) via the DC-bus. This may lead to overload of the intact controller, as the faulty controller is not selectively activated on the DC-bus. <ul style="list-style-type: none"> • Possible damage with central and decentral supply <ul style="list-style-type: none"> - destruction of the controller concerned - destruction of the controllers still intact - destruction of the supply unit 		
Note	The extent of the destructions depends on the ratio "DC-bus power of the whole system / rated power of the controller concerned".		

Protection by	F1 ... F3 with alarm contact + F4 ... F5		
Protection of	Cable protection <ul style="list-style-type: none"> • on the mains side • on the DC-bus • on the motor side 	Unit protection in the event of overload If a supply/input fails because F1...F3 blows, the remaining controllers which are connected will not be overloaded as the alarm contact switches off the mains and thus the whole network.	Unit protection in the event of short circuit
Possible faults	One or more controllers with <ul style="list-style-type: none"> - internal short circuit (+ U_G → - U_G) - internal earth fault (+ U_G → PE / - U_G → PE) - motor-side earth fault on phase W 		
Risk	<ul style="list-style-type: none"> • Possible damage with central supply <ul style="list-style-type: none"> - destruction of the controller concerned • Possible damage with decentral supply <ul style="list-style-type: none"> - destruction of the controller concerned 		
Note	The selective activation of the mains and DC side reduces the extent of destruction.		

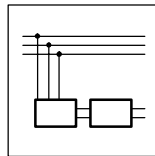

10.3 Selection basics

In the following table you will find some basic data to select a drive network. Two examples explain the use of the tables.

10.3.1 Conditions

The unit data list in the table TAB 1 are only valid, if the network fulfills the following conditions:

- All inputs are connected to the three-phase AC mains by means of the mains filters prescribed in TAB 2.
- Chopper frequencies:
 - 93XX: 8 kHz.
 - 821X/822X/824X: 4 kHz or 8 kHz.
- Motors (three-phase AC asynchronous motors, asynchronous servo motor, synchronous servo motors):
 - Simultaneity factor $F_g = 1$, i.e. all motors operate simultaneously with 100 % motor load.
 - Mains voltage $V_{\text{mains}} = 400 \text{ V} / 50 \text{ Hz}$
 - Ambient temperature during operation: max. $+40 \text{ }^\circ\text{C}$

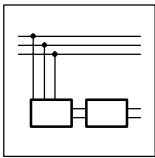

Network of several drives

Supply power in network operation																			
First input with type	9341	9342	9343	9330 8224	9322 8242	8211	8212	8215	9326 8246 8218	8217	9328 8222	8213	8214	9329 8223	9323 8243	9325 8245 8216	9327 8221	9324 8244	9321 8241
Power loss P_V [kW]	0.1	0.2	0.4	1.1	0.065	0.0055	0.075	0.15	0.36	0.28	0.64	0.09	0.1	0.81	0.1	0.21	0.43	0.15	0.05
$P_{DC100\%}$ [kW]	8.3	16.6	31.2	51.8	2	2	2	6.2	13	13	32.7	4.1	4.1	34.5	4.2	7.2	28	4.6	2.7
Further inputs with type																			
9341																			
9342																			
9343																			
9330, 8224	22.9	33.5	39.3	42.4															
9322, 8242	0.9	1.3	1.5	1.6	1.6														
8211	0.9	1.3	1.5	1.6	1.6	1.6													
8212	0.9	1.3	1.5	1.6	1.6	1.6	1.6												
8215	2.6	3.8	4.5	4.8	4.9	4.9	4.9	5.1											
8326, 8246, 8218	5.2	7.6	8.9	9.6	9.7	9.7	9.7	10.2	10.6										
8217	5.2	7.6	8.9	9.6	9.7	9.7	9.7	10.2	10.6	10.6									
9328, 8222	12.9	19	22.3	24	24.3	24.3	24.3	25.4	26.6	26.6	26.8								
8213	1.6	2.3	2.7	2.9	2.9	2.9	2.9	3.1	3.2	3.2	3.2	3.4							
8214	1.6	2.3	2.7	2.9	2.9	2.9	2.9	3.1	3.2	3.2	3.2	3.4	3.4						
9329, 8223	13	19	22.3	24	24.3	24.3	24.3	25.4	26.6	26.6	26.8	27.9	27.9	28.2					
9323, 8243	1.5	2.3	2.7	2.9	2.9	2.9	2.9	3	3.2	3.2	3.2	3.3	3.3	3.4	3.4				
9325, 8245, 8216	2.6	3.8	4.5	4.8	4.9	4.9	4.9	5.1	5.3	5.3	5.4	5.6	5.6	5.7	5.8	5.9			
9327, 8221	9.7	14.3	16.7	18	18.2	18.2	18.2	19	20	20	20.1	20.9	20.9	21.2	21.6	22.1	22.9		
9324, 8244	1.5	2.3	2.7	2.9	2.9	2.9	2.9	3	3.2	3.2	3.2	3.3	3.3	3.4	3.4	3.5	3.6	3.8	
9321, 8241	0.9	1.3	1.5	1.6	1.6	1.6	1.6	1.7	1.8	1.8	1.8	1.9	1.9	1.9	1.9	2	2	2.1	2.2

TAB 1 Supply power in DC-bus connection

Network of several drives

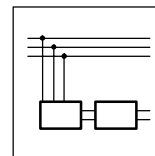

Filter assignment in network operation																			
Input with type	9341	9342	9343	9330 8224	9322 8242	8211	8212	8215	9326 8246 8218	8217	9328 8222	8213	8214	9329 8223	9323 8243	9325 8245 8216	9327 8221	9324 8244	9321 8241
Filter inductivity [mH]	1.2	0.88	0.55	0.34	9	9	9	3	1.5	1.5	0.6	5	5	0.6	5	3	0.8	5	9
Filter current [A]	17	35	55	100	4	4	4	13	24	24	54	7	7	54	7	13	42	7	4
Order No.	EZN3A0120H017	EZN3A0088H035	EZN3A0055H055	EZN3A0034H100	EZN3A0900H004	EZN3A0900H005	EZN3A0900H006	EZN3A0300H013	EZN3A0150H024	EZN3A0150H025	EZN3A0060H054	EZN3A0500H007	EZN3A0500H008	EZN3A0060H054	EZN3A0500H007	EZN3A0300H013	EZN3A0500H042	EZN3A0500H007	EZN3A0900H004

TAB 2 Prescribed mains filters for the supply in network operation

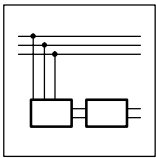

Network of several drives

10.3.2 Selection example for 4 drives

10.3.2.1 Supply only via controllers

Drive data			
Drive	Controller type	Motor P _M	Efficiency
Drive 1	9328	22 kW	η = 0.9
Drive 2	9325	5.5 kW	
Drive 3	8214	3.0 kW	
Drive 4	8212	1.5 kW	

1. Determine DC-power requirements:

- Power loss P_{loss} TAB 1.

$$P_{DC} = \sum_{i=1}^4 \left(\frac{P_{M_i}}{\eta} + P_{V_i} \right)$$

$$P_{DC} = \frac{22 \text{ kW}}{0.9} + 0.64 \text{ kW} + \frac{5.5 \text{ kW}}{0.9} + 0.21 \text{ kW} + \frac{3.0 \text{ kW}}{0.9} + 0.1 + \frac{1.5 \text{ kW}}{0.9} + 0.075$$

$$P_{DC} = 34.575 \text{ kW}$$

2. Determine first input:

- P_{DC100%} TAB 1.

	9328	9325	8214	8212
P _{DC100%}	32.7 kW	7.2 kW	4.1 kW	2.0 kW

- First input selected is 9328.
- Additionally required input powers are:
34.573 kW - 32.7 kW = 1.875 kW

3. Determine the second input:

- Input power for 9325/8214/8212 from "9328/8222" in TAB 1.

	9325	8214	8212
P _{DC2}	5.4 kW	3.2 kW	not possible

- The power of 8214 is not sufficient.

4. Result:

- This drive network must be connected to the three-phase AC mains via the controllers 9328 and 8214.

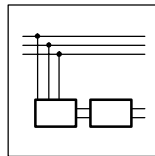

10.3.2.2 Supply by means of 934X supply and feedback module

The same drive is to be additionally equipped with 934X.

Drive data			
Drive	Controller type	Motor P _M	Efficiency
Drive 1	9328	22 kW	η = 0.9
Drive 2	9325	5.5 kW	
Drive 3	8214	3.0 kW	
Drive 4	8212	1.5 kW	

1. Determine DC-power requirements:

- Power loss P_{loss} from TAB 1.

$$P_{DC} = \sum_{i=1}^4 \left(\frac{P_{M_i}}{\eta} + P_{V_i} \right)$$

$$P_{DC} = \frac{22 \text{ kW}}{0.9} + 0.64 \text{ kW} + \frac{5.5 \text{ kW}}{0.9} + 0.21 \text{ kW} + \frac{3.0 \text{ kW}}{0.9} + 0.1 + \frac{1.5 \text{ kW}}{0.9} + 0.075$$

$$P_{DC} = 34.575 \text{ kW}$$

2. Determine the required supply module:

	Powers	9341	9342	9343
	P _{DC}	34.575 kW	34.575 kW	34.575 kW
	P _{V934X}	0.1 kW	0.2 kW	0.4 kW
	P _{DCtotal}	34.675 kW	34.775 kW	34.975 kW
Input	P _{DC100%934X}	8.3 kW	16.6 kW	31.2 kW
Input (s)	P _{DC2100%9328}	12.9 kW	19.0 kW	22.3 kW
	P _{DC2100%9325}	2.6 kW	3.8 kW	4.5 kW
	P _{DC2100%8214}	1.6 kW	2.3 kW	2.7 kW
	P _{DC2100%8212}	0.9 kW	1.3 kW	1.5 kW
	Max. possible input power	26.3 kW	43.0 kW	62.2 kW

- Network operation is possible with 9342 or 9343. Since P_{DCtotal} is higher than P_{DC100%934X}, the network requires a second supply. The selection of the regenerative power supply module is now only dependent on the regenerative power.

3. Determine the second input:

- Network with 9342: Second input at 9328
- Network with 9343: Second input at 9328 or 9325

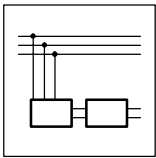

Network of several drives

10.4 Central supply

The DC-bus is supplied via a central supply source. Supply sources are:

- DC source - 820X.
- Supply and feedback module - 821X/822X/824X/93XX.
- Controller with reserve power.

10.4.1 Central supply of 820X

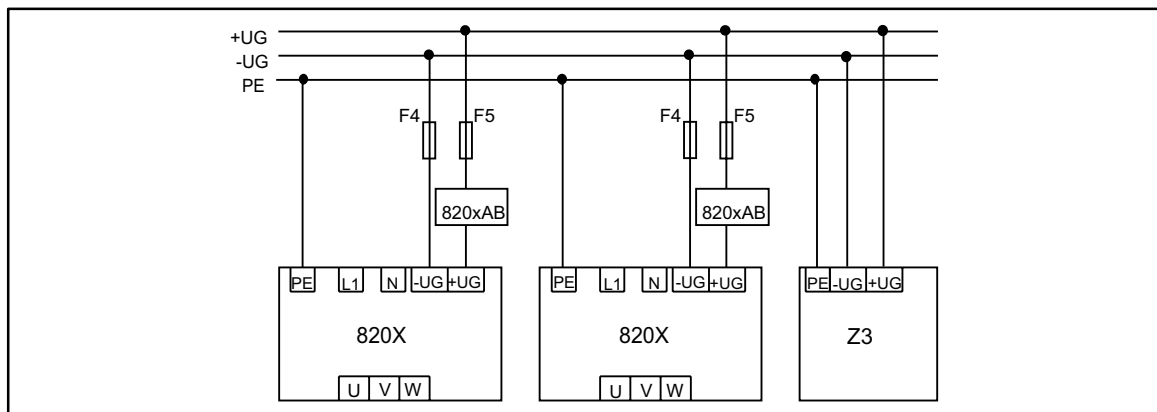

FIG 10-2 Block diagram: Central supply of several 820X controllers connected to a network
 F4, F5 Fuses, DC level, see Accessories
 Z3 Brake chopper/brake module, see Accessories
 820XAB Current-limitation module, see Accessories



Stop!

For faultless network operation, the following conditions must be fulfilled in addition to the conditions described in chapter 10.2:

- The voltage flow $+U_G \rightarrow PE$ / $-U_G \rightarrow PE$ must be symmetrical!
 - The controller will be destroyed, if $+U_G$ or $-U_G$ are grounded.
- Use the current limitation module 820XAB.

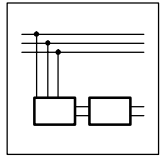

10.4.2 Central supply via 934X for 821X/822X/824X/93XX

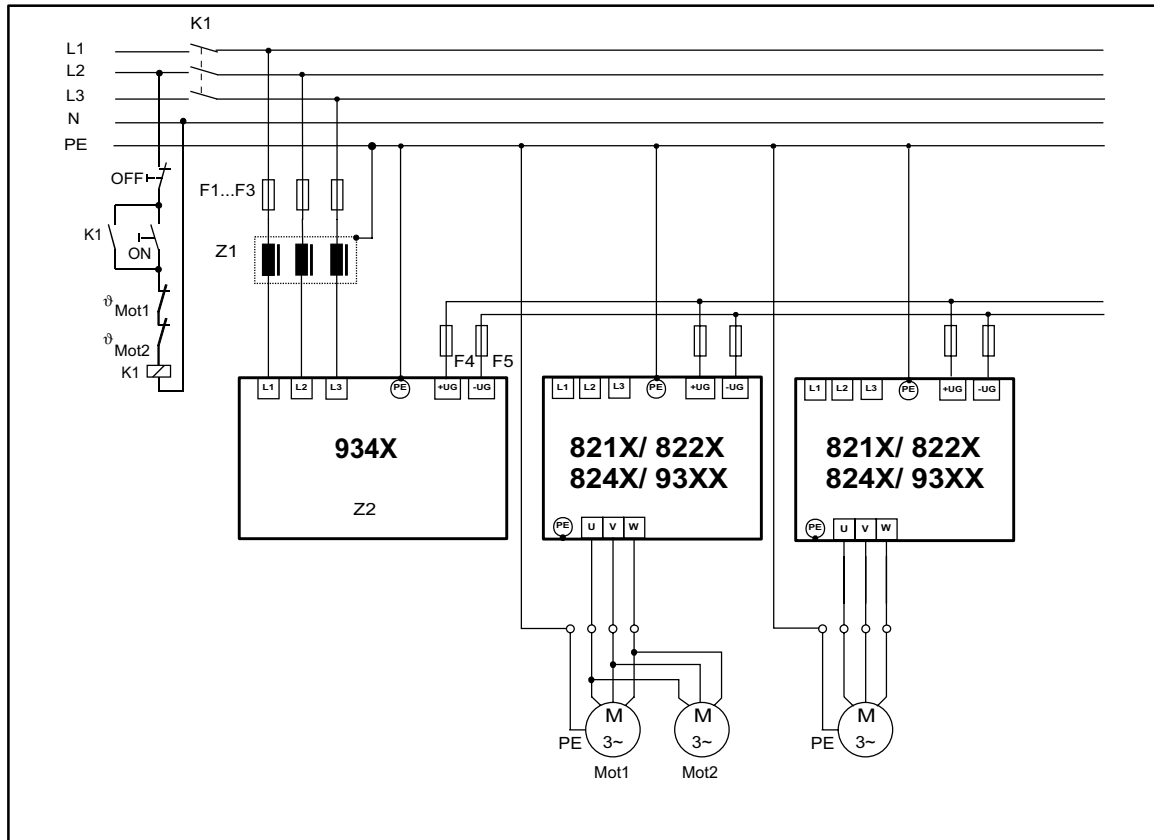

FIG 10-3 Principle diagram: Central supply for network operation of 821X/822X/824X/93XX
 Z1 Mains filter/choke
 Z2 Regenerative power supply
 F1 ... F5 Fuses
 K1 Main contactor



Stop!

The DC-bus voltage thresholds of the 93XX controller and the 934X supply unit must be set to the same value.



Note!

Z2 is selected after balancing the power in the DC-bus. If the power supply of the supply is not sufficient, a parallel supply can be installed via the mains input of a controller (see Network of several drives with decentral supply).

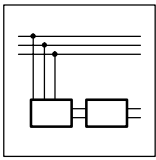

Network of several drives

10.5 Decentral supply

The DC-bus is supplied via several controllers or supply units connected in parallel to the mains.

10.5.1 Decentral supply for 820X

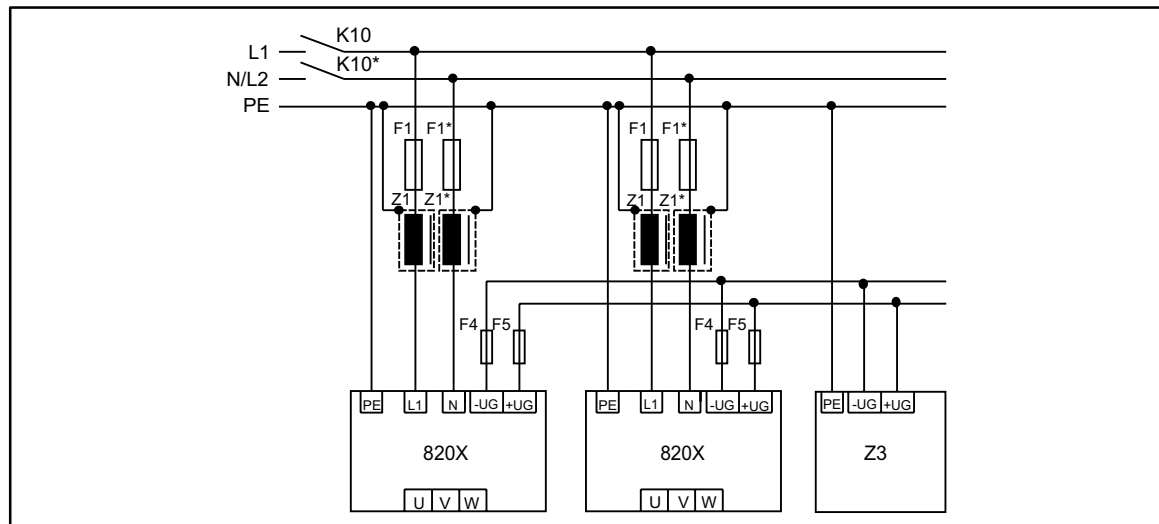

FIG 10-4 Block diagram: Decentral supply of several 820X controllers connected to a network

F1, F1*	Fuses, see Accessories F1* only for supply voltage 2AC / PE / 190 - 260 V $\pm 0\%$ / 45 - 65 Hz $\pm 0\%$
K10, K10*	Mains contactor K10* only for supply voltage 2AC / PE / 190 - 260 V $\pm 0\%$ / 45 - 65 Hz $\pm 0\%$
F4, F5	Fuses, DC level, see Accessories
Z1, Z1*	Mains choke/mains filter, see Accessories Z1* only for supply voltage 2AC / PE / 190 - 260 V $\pm 0\%$ / 45 - 65 Hz $\pm 0\%$
Z3	Brake chopper/brake module, see Accessories



Stop!

For faultless network operation, the following conditions must be fulfilled in addition to the conditions described in chapter 10.2:

- In-phase connection on the mains side
- With two-phase supply
 - Cable and overload protection via second assigned mains fuse F1*
 - Ensure current and power symmetry by providing a second mains choke/mains filter Z1*.

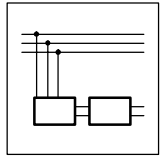

10.5.2 Central supply for 821X/822X/824X/93XX/934X

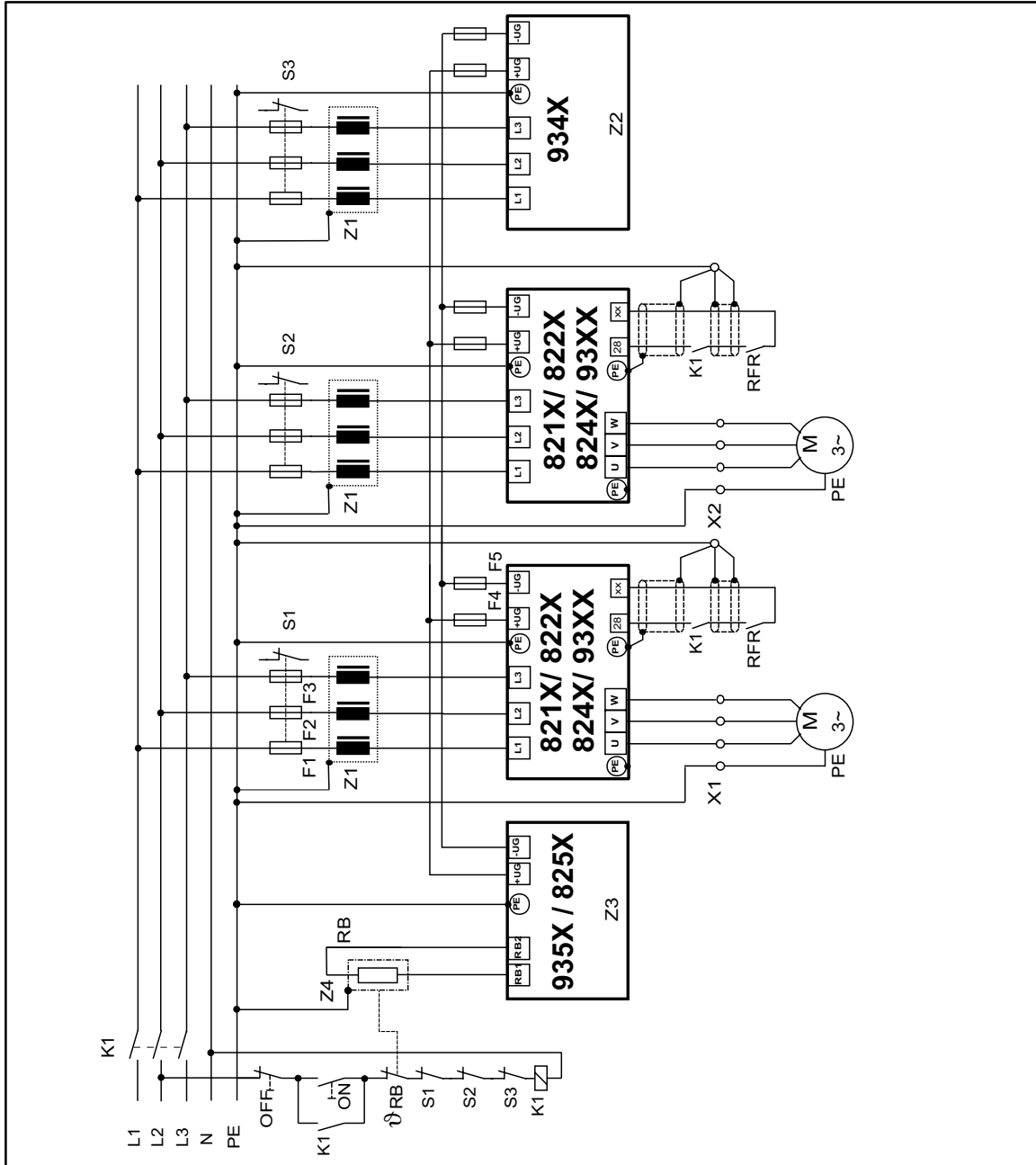
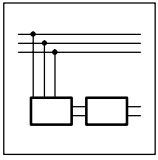
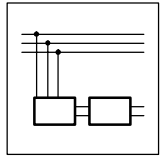

FIG 10-5 Block diagram: Decentral supply of several controllers (821X/822X/824X/93XX/934X) connected to a network

- | | |
|------------|---|
| F1, F2, F3 | Fuses, see Accessories |
| K10 | Mains contactor |
| F4, F5 | Fuses, DC level, see Accessories |
| Z1 | Mains choke/mains filter, see Accessories |
| Z2 | Supply module |
| Z3 | Brake unit, see Accessories |
| Z4 | Brake resistor |



Network of several drives



See: Table of contents of the attached Operating Instructions

EDS8200D--G
00393452

Manual

Teil G

Application of brake units

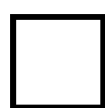

Global Drive

Frequency inverters 8200

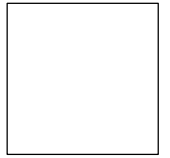

11 Application of brake units

See: Table of contents of the attached Operating Instructions

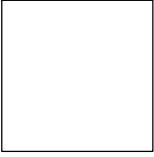

Application of brake units

EDS8200D--H
00393453

Manual

Teil H

Automation

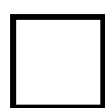

Global Drive
Frequency inverters 8200

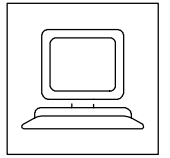

12 Automation

See: Table of contents of the attached Operating Instructions

EDS8200U--I
00406189

Manual

Part I

Accessories and motors

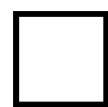

Global Drive

Frequency inverters 8200

This Manual is valid for 82XX controllers as of version:

	33.820X-	E-	1x	1x		(8201 - 8204)
	33.8202-	E-	1x	1x	-V002	Reduced assembly depth (8202)
	33.821X-	E-	0x	1x		(8211 - 8218)
	33.821X-	E-	1x	2x		(8211 - 8218)
	33.821X-	C-	1x	2x	-V003	Cold plate (8215 - 8218)
	33.821X-	E-	3a.	3x	-V020	HVAC (8211 - 8218)
	33.822X-	E-	0x	0x		(8221 - 8227)
	33.822X-	C-	1x	2x	-V003	Cold plate (8221 - 8222)
	33.822X-	E-	3a.	3x	-V020	HVAC (8221 - 8227)
	33.824X-	E-	1x	1x		(8241 - 8246)
	33.824X-	C-	1x	1x	-V003	Cold plate (8241 - 8246)
	33.824X-	E-	3a.	3x	-V020	HVAC (8241 - 8246)
Type						
Design: B = Module C = Cold plate E = Built-in unit IP20						
Hardware version and index						
Software version and index						
Variant						
Explanation						

		revised	
Edition of:	01/1999		

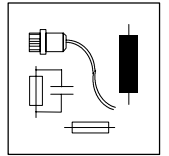

13 Accessories (Survey)

A detailed description of the accessories and Lenze three-phase AC motors can be obtained from the corresponding catalogs.

13.1 Accessories for all types

Name	Order number
8201BB operating module	EMZ8201BB
Diagnosis terminal (2.5 m cable)	EMZ8272BB-V001
Diagnosis terminal (5.0 m cable)	EMZ8272BB-V002
Diagnosis terminal (10 m cable)	EMZ8272BB-V003
Digital display	EPD203
Setpoint potentiometer	ERP0001k0001W
Rotary button for potentiometer	ERZ0001
Scale for potentiometer	ERZ0002
RS232/485 fieldbus module	EMF2102IB-V001
RS485 fieldbus module	EMF2102IB-V002
Level converter for RS485	EMF2101IB
PC system cable RS232/485	EWL0020
Optical fibre fieldbus module	EMF2102IB-V003
Optical fibre adaptor for PLC 0 ... 40 m	EMF2125IB
Supply unit for optical fibre adaptor 2125	EJ0013
INTERBUS module	EMF2111IB
PROFIBUS module	EMF2131IB
System bus module (CAN)	EMF2171IB
System bus module (CAN) with addressing	EMF2172IB
PTC module	EMZ8274IB
I/O module	EMZ8275IB
Monitor module	EMZ8276IB
Bipolar setpoint module	EMZ8278IB

13.2 Software

Name	Order number
PC program for Global Drive controllers	ESP-GDC 1

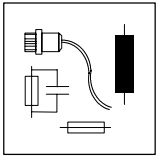

Accessories

13.3 Type-specific accessories

13.3.1 Types 820X

Name	Order number			
	8201	8202	8203	8204
E.l.c.b.	EFA1C10A	EFA1C16A	EFA1C20A	EFA1C20A
Fuse	EFSM-0100ASB	EFSM-0150ASB	EFSM-0200ASC	EFSM-0200ASC
Fuse holder	EFH30001	EFH30001	EFH30001	EFH30001
Mains filter type "A"	EZN2-004A001	EZN2-008A001	EZN2-013A001	EZN2-017A001
Mains choke	ELN1-0900H005	ELN1-0500H009	ELN1-0350H014	ELN1-0160H017
RFI filter for operation:				
With mains choke	EZF1-006A002	EZF1-009A002	EZF1-018A002	EZF1-018A002
Without mains choke	EZF1-006A002	EZF1-009A002	EZF1-018A002	inadmissible
Motor filter	ELM3-030H003	ELM3-020H004	ELM3-010H010	ELM3-014H010
Sine filter	EZS3-003A001	EZS3-004A002	EZS3-007A001	EZS3-010A001
Brake module	EMB8251-E	EMB8251-E	EMB8251-E	EMB8251-E
Swivel wall assembly	EJ0001	EJ0001	EJ0001	EJ0001
DIN-rail assembly	EJ0002	EJ0002	EJ0002	EJ0002
Fan for flat assembly	EJ0003	EJ0003	EJ0003	EJ0003
Current-limiting module	EMZ8201AB	EMZ8201AB	EMZ8203AB	EMZ8203AB
DC-bus fuse	EFSM-0060AWE	EFSM-0060AWE	EFSM-0100AWE	EFSM-0160AWE
Fuse holder	EFH10001	EFH10001	EFH10001	EFH10001

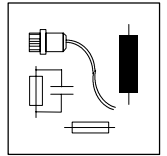

13.3.2 Types 821X

Name	Order number			
	8211	8212	8213	8214
E.I.c.b.	EFA3B06A	EFA3B06A	EFA3B10A	EFA3B10A
Fuse	EFSM-0060AWE	EFSM-0060AWE	EFSM-0100AWE	EFSM-0100AWE
Fuse holder	EFH10001	EFH10001	EFH10001	EFH10001
Mains filter type B	EZN3B1500H003	EZN3B0800H004	EZN3B0750H005	EZN3B0500H007
Mains choke	ELN3-0700H003	ELN3-0450H004	ELN3-0350H006	ELN3-0250H007
RFI filter				
Operating with mains choke	EZF3-008A003	EZF3-008A003	EZF3-008A003	EZF3-016A003
Operation without mains choke	EZF3-008A003	EZF3-008A003	EZF3-008A003	inadmissible
Motor filter	ELM3-030H004	ELM3-030H004	ELM3-014H010	ELM3-014H010
Sine filter	EZS3-002A001	EZS3-004A001	EZS3-006A001	EZS3-010A001
Brake module	EMB8252-E	EMB8252-E	EMB8252-E	EMB8252-E
Brake chopper	EMB8253-E	EMB8253-E	EMB8253-E	EMB8253-E
Brake resistor	ERBM470R100W	ERBM370R150W	ERBM240R200W	ERBD180R300W
Swivel wall assembly	EJ0001	EJ0001	EJ0001	EJ0001
DIN-rail assembly	EJ0002	EJ0002	EJ0002	EJ0002
DC-bus fuse	EFSCC0063AYJ	EFSCC0063AYJ	EFSCC0080AYJ	EFSCC0120AYJ
Fuse holder	EFH20004	EFH20004	EFH20004	EFH20004

Name	Order number			
	8215	8216	8217	8218
E.I.c.b.	EFA3B13A	EFA3B20A	EFA3B25A	EFA3B32A
Fuse	EFSM-0160AWE	EFSM-0200AWE	EFSM-0250AWH	EFSM-0320AWH
Fuse holder	EFH10001	EFH10001	EFH10001	EFH10001
Mains filter type B	EZN3B0400H009	EZN3B0300H013	EZN3B0250H015	EZN3B0150H024
Mains choke	ELN3-0160H012	ELN3-0160H012	ELN3-0120H017	ELN3-0120H025
RFI filter				
Operating with mains choke	EZF3-016A003	EZF3-016A003	EZF3-016A003	EZF3-024A001
Operation without mains choke	EZF3-016A003	EZF3-024A001	EZF3-024A001	inadmissible
Motor filter	ELM3-014H010	ELM3-007H025	ELM3-007H025	ELM3-007H025
Sine filter	EZS3-009A002	EZS3-013A001	EZS3-017A001	EZS3-024A001
Brake module	EMB8252-E	EMB8252-E	EMB8252-E	EMB8252-E
Brake chopper	EMB8253-E	EMB8253-E	EMB8253-E	EMB8253-E
Brake resistor	ERBD100R600W	ERBD082R600W	ERBD068R800W	ERBD047R01k2
Thermal separation ("Push-through technique")	EJ0004	EJ0004	EJ0004	EJ0004
Heat sink with assembly kit only for variant V003	EJ0005	EJ0005	EJ0005	EJ0005
DC-bus fuse	EFSCC0160AYJ	EFSCC0200AYJ	EFSCC0320AYJ	EFSCC0400AYJ
Fuse holder	EFH20004	EFH20004	EFH20004	EFH20004

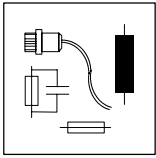

Accessories

13.3.3 Types 822X

Name	Order number			
	8221	8222	8223	8224
Mains filter type A	EZN3A0110A030	EZN3A0080A042	EZN3A0060H054	
Mains filter type B	EZN3B0110A030	EZN3B0080A042	EZN3B0060H054	
Mains choke	ELN3-088H035	ELN3-0075H045	ELN3-0055H055	ELN3-0038H085
Motor filter	ELM3-004H055	ELM3-004H055	on request	on request
Sine filter	on request	on request	on request	on request
Brake module	EMB9351-E	EMB9351-E	EMB9351-E	EMB9351-E
Brake chopper	EMB9352-E	EMB9352-E	EMB9352-E	EMB9352-E (2 x)
Brake resistor	ERBD033R02k0	ERBD022R03k0	ERBD018R03k0	ERBD022R03k0 (2 x)
Thermal separation ("Push-through technique")	EJ0011	EJ0011	EJ0011	EJ0011
DC-bus fuse	EFSCC0500AYJ	EFSCC0800AYJ	EFSCC1000AYJ	EFSCC0800AYJ (2 x)
Fuse holder	EFH20004	EFH20004	EFH20004	EFH20004 (2 x)

Name	Order number		
	8225	8226	8227
Mains filter type A			
Mains filter type B			
Mains choke	ELN3-0027H105	ELN3-0022H130	ELN3-0017H170
Motor filter	on request	on request	on request
Sine filter	on request	on request	on request
Brake module	EMB9351-E	EMB9351-E	EMB9351-E
Brake chopper	EMB9352-E (2 x)	EMB9352-E (3 x)	EMB9352-E (3 x)
Brake resistor	ERBD018R03k0 (2 x)	ERBD022R03k0 (3 x)	ERBD018R03k0 (3 x)
Thermal separation ("Push-through technique")			
DC-bus fuse	EFSCC1000AYJ (2 x)	EFSCC0800AYJ (3 x)	EFSCC1000AYJ (3 x)
Fuse holder	EFH20004 (2 x)	EFH20004 (3 x)	EFH20004 (3 x)

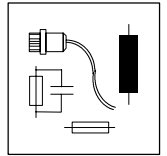

13.3.4 Types 824X

Name	Order number			
	8241	8242	8243	8244
E.I.c.b.	EFA3B06A	EFA3B06A	EFA3B10A	EFA3B10A
Fuse	EFSM-0060AWE	EFSM-0060AWE	EFSM-0100AWE	EFSM-0100AWE
Fuse holder	EFH10001	EFH10001	EFH10001	EFH10001
Mains filter type A	EZN3A2400H002	EZN3A1500H003	EZN3A0900H004	EZN3A0500H007
Mains filter type B	EZN3B2400H002	EZN3B1500H003	EZN3B0900H004	EZN3B0500H007
Motor filter	ELM3-030H004	ELM3-030H004	ELM3-014H010	ELM3-014H010
Sine filter	EZS3-002A001	EZS3-004A001	EZS3-006A001	EZS3-010A001
Brake module	EMB9351-E	EMB9351-E	EMB9351-E	EMB9351-E
Brake chopper	EMB9352-E	EMB9352-E	EMB9352-E	EMB9352-E
Brake resistor	ERBD180R300W	ERBD180R300W	ERBD082R600W	ERBD068R800W
Thermal separation ("Push-through technique")	EJ0036	EJ0036	EJ0037	EJ0037
DC-bus fuse	EFSCC0060AYJ	EFSCC0060AYJ	EFSCC0080AYJ	EFSCC0120AYJ
Fuse holder	EFH20004	EFH20004	EFH20004	EFH20004

Name	Order number	
	8245	8246
E.I.c.b.	EFA3B13A	EFA3B20A
Fuse	EFSM-0160AWE	EFSM-0200AWE
Fuse holder	EFH10001	EFH10001
Mains filter type A	EZN3A0300H013	EZN3B0300H013
Mains filter type B	EZN3B0300H013	ELN3-0160H012
Motor filter	ELM3-014H010	EZN3A0150H024
Sine filter	EZS3-009A002	EZN3B0150H024
Brake module	EMB9351-E	EMB9351-E
Brake chopper	EMB9352-E	EMB9352-E
Brake resistor	ERBD047R01k2	ERBD047R01k2
Thermal separation ("Push-through technique")	EJ0038	EJ0038
DC-bus fuse	EFSCC0200AYJ	EFSCC0400AYJ
Fuse holder	EFH20004	EFH20004

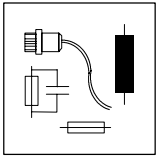

Accessories

EDS8200U--K
00406190

Manual

Part K

Selection help

Application examples

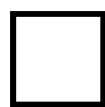

Global Drive

Frequency inverters 8200

This Manual is valid for 82XX controllers as of version:

	33.820X-	E-	1x.	1x		(8201 - 8204)
	33.8202-	E-	1x.	1x	-V002	Reduced assembly depth (8202)
	33.821X-	E-	0x.	1x		(8211 - 8218)
	33.821X-	E-	1x.	2x		(8211 - 8218)
	33.821X-	C-	1x.	2x	-V003	Cold plate (8215 - 8218)
	33.821X-	E-	3a.	3x	-V020	HVAC (8211 - 8218)
	33.822X-	E-	0x.	0x		(8221 - 8227)
	33.822X-	C-	1x.	2x	-V003	Cold plate (8221 - 8222)
	33.822X-	E-	3a.	3x	-V020	HVAC (8221 - 8227)
	33.824X-	E-	1x.	1x		(8241 - 8246)
	33.824X-	C-	1x.	1x	-V003	Cold plate (8241 - 8246)
	33.824X-	E-	3a.	3x	-V020	HVAC (8241 - 8246)
Type						
Design: B = Module C = Cold plate E = Built-in unit IP20						
Hardware version and index						
Software version and index						
Variant						
Explanation						

		revised	
Edition of:	01/1999		



14 Selection help

will be added

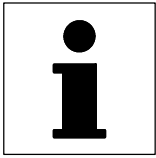

Selection help

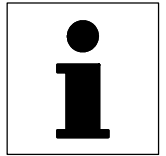

15 Application examples

15.1 Pump application with pressure control

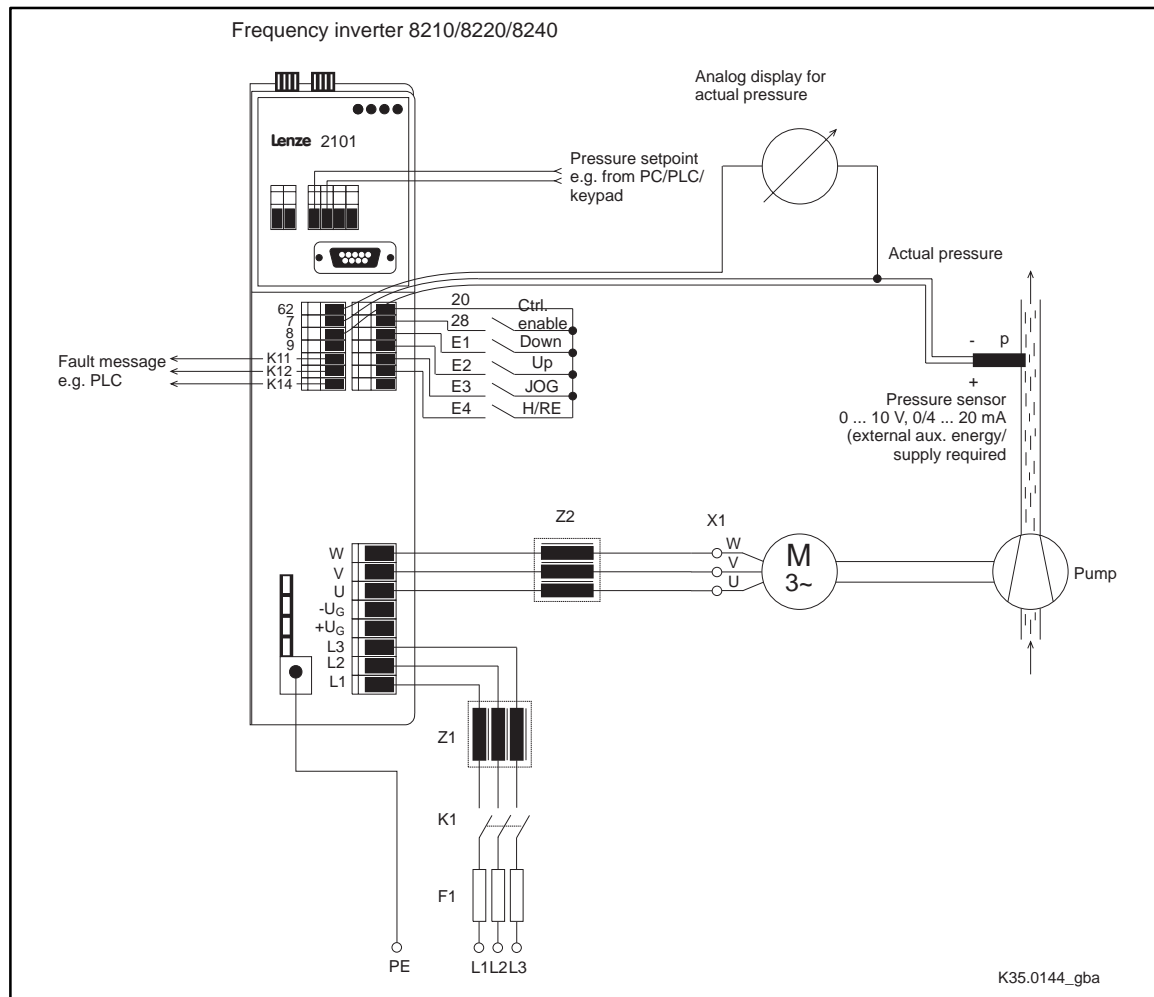

FIG 15-1 Application of a pump with pressure control

- Z1 Mains filter required for radio interference level A or B. For mains chokes see chapter 3.4 ff.
- Z2 Motor filter/sine filter required for long motor cables or motors not designed for inverter operation (see chapter 4.2.7.2).

Shield all signal and motor cables. Please observe the corresponding installation instructions given in chapters 4.2 and 4.3.



Exercise for FIG 15-1:

A centrifugal pump is used to ensure constant pressure in a pipeline system (e.g. for water supply of residential and industrial premises).

The application does not only require remote control from a central operating panel but also setting possibilities at site. The pressure is to be reduced to a fixed value during times when only few water is required. Thus, indirectly possible burst pipes can be detected by monitoring the actual pressure.

Functions used

- Internal PID controller for pressure control
 - Regular control, setpoint selection via fieldbus with feedback via analog channel terminal 8.
- Networking via fieldbus (e.g. via plug-in module 2102)
- Manual/remote changeover (H/Re)
 - Setpoint selection change via key (E1 = DOWN / E2 = UP)
- Process setpoint selection (e.g. pressure [p]) via inverter JOG value
- Electrical controller inhibit (ctrl. enable)

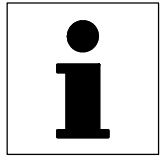

Code settings:

Code	Name	Possible settings			IMPORTANT
		Lenze	Choice	Info	
C001	Operating mode	-0-	-3-	Setpoint selection - control, parameter setting via LECOM	
C005	Configuration	-0-	-7-	Controlled operation, with analog feedback via term. 8	
C007	Terminal configuration	-0-	-26-	Motor potentiometer, JOG, H/Re	
C037	JOG value 1	20.00	16.67 Hz	Fixed reduction to 1/3 of the rated pressure	
C051	Actual PID controller value				Only display of actual pressure
C070	Gain PID controller	1.00	0.02 ... 0.1		Adaptation to process
C071	Integral action time PID controller	100	0.2 ... 1 s		
C072	Differential component PID controller	0.0	0.0		Inactive
C074	Influence PID controller	0.0	100.0 %		
C111	Monitor signal	-0-	-8-	Actual PID controller value	
C238	Frequency precontrol	-1-	-0-	No precontrol	
C239	Frequency setting range	-0-	-1-	Unipolar	Direction of rotation cannot be changed via the process controller

All other parameters are based on the factory setting.

Set the rated motor data under C088 (rated motor current) and C091 (motor $\cos \varphi$) depending on the motor connected.

In addition to the setpoint input via fieldbus, the pressure setpoint can also be selected via the 8201BB keypad (installation up to max. 10 m away from the controller) or via an analog input signal (using the 8274 plug-in module).



Note!

- For more detailed information on the process controller, see chapter 7.5.10.
- Calibration of the setpoints and actual values to the application datum under C500 and C501. (See chapter 7.6.3)

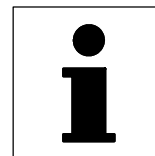

Application FIG 15-2:

In a tank the water is to be held at a constant level. The speed of the pump must be controlled depending on the amount of water delivered.

Functions used

- Internal PID controller for level control.
 - Regular control, analog setpoint input via terminal 8 with feedback via analog channel E1 with plug-in module 8279IB.

Code settings:

Code	Name	Possible settings			IMPORTANT
		Lenze	Choice	Info	
C005	Configuration	-0-	-6-	Operation with closed-loop control; setpoint via terminal 8 with digital frequency feedback via terminal E1	
C007↓	Terminal configuration	-0-	-28- ... -45- or -48- ... -51-		Act. level value via terminal E1
C070	Gain PID controller	1.00	0.02 ... 0.1		Adaptation to process
C071	Integral action time PID controller	100	0.2 ... 1 s		
C072	Differential component of PID controller	0.0			Inactive
C074	Influence PID controller	0.0	100.0 %		
C238↓	Frequency precontrol	-1-	-0-	No precontrol	
C239↓	Frequency setting range	-0-	-1-	Unipolar	Direction of rotation cannot be changed via the process controller.

All other parameters are based on the factory setting.

Set the rated motor data under C088 (rated motor current) and C091 (motor $\cos \varphi$) depending on the motor connected.



Note!

- Adapt C426 and C427 if the actual value input is 4 mA ... 20 mA. (See chapter 3.7.1 and chapter 7.5.14.9)
- Calibration of the setpoints and actual values to the application datum under C500 and C501. (See chapter 7.6.3)



Application FIG 15-3:

The material speed v_2 is to be synchronised to the line speed v_1 by means of a dancer-position control. The dancer-position setpoint is internally set.

Functions used

- Internal PID controller as position controller.
- Selection of the line speed v_1 via terminal 8.
- Act. dancer position from the dancer potentiometer to the analog plug-in module 8279IB.

Code settings:

Code	Name	Possible settings			IMPORTANT
		Lenze	Choice	Info	
C005	Configuration	-0-	-6-	Controlled operation; setpoint via terminal 8 with digital frequency feedback via terminal E1	Jumper setting for terminal 8 must be adapted to 5 V (see chapter 4.2.8.2).
C007	Terminal configuration	-0-	-49-		Actual dancer position via terminal E1
C037	JOG value 1	20.00		Fixed in-take speed v_1 for material guidance, individually adjustable	
C070	Gain PID controller	1.00			Adaptation to process
C071	Integral action time PID controller	100			
C072	Differential component PID controller	0.0			
C074	Influence PID controller	0.0	10.0 %		
C105	Deceleration time QSP	5.00		Enter approx. 1 s	Emergency-stop function: <ul style="list-style-type: none"> • The drive geometry must be adjusted so that it is possible to brake the controller to standstill within a very short time.
C239	Frequency setting range	-0-	-1-	Unipolar	Direction of rotation cannot be changed via the process controller.

All other parameters are based on the factory setting.

Set the rated motor data under C088 (rated motor current) and C091 (motor $\cos \varphi$) depending on the motor connected.



Note!

- For more detailed information on the process controller, see chapter 7.5.10.
- Calibration of the setpoints and actual values to the application datum under C500 and C501. (See chapter 7.6.3)



15.4 Air conditioning system

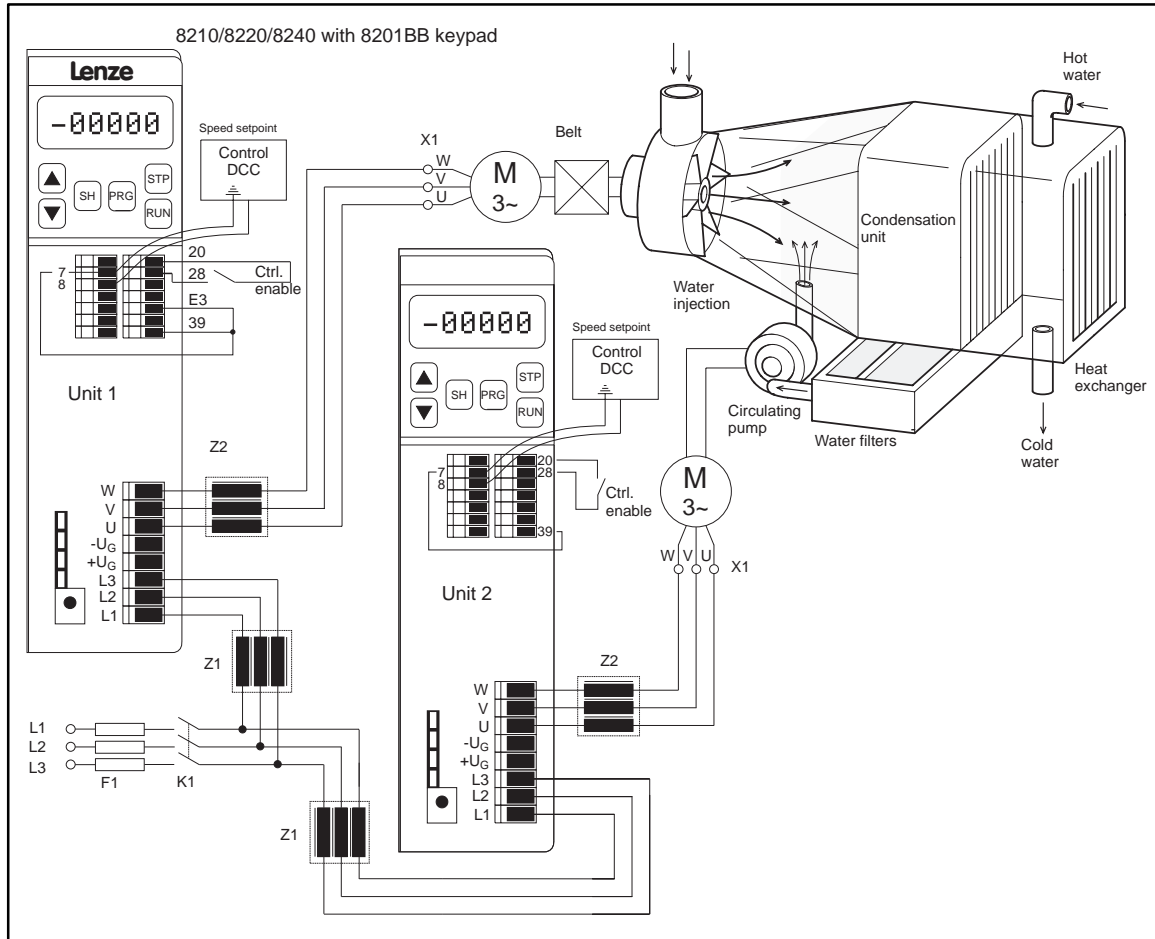
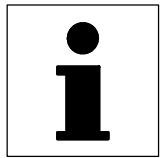

FIG 15-4 Application example of an air conditioning system

Z1 Mains filter required for radio interference level A or B. For mains chokes see chapter 3.4 ff.

Z2 Motor filter/sine filter required for long motor cables or motors not designed for inverter operation (see chapter 4.2.7.2).

Shield all signal and motor cables. Please observe the corresponding installation instructions given in chapters 4.2 and 4.3.



Application FIG 15-4:

The air conditioning system of a department store is to be controlled according to the number of persons present. The fans must circulate an amount of air that depends on the number of people (e.g. data provided by a person counter).

Functions used

- Belt monitoring
- Mains failure detection
 - Controlled deceleration and stopping of the drive after mains failure
- Flying-restart circuit on coasting motor
- Suppression of mechanical resonances
- Smooth start/stop with S ramps

Code settings for unit 1:

Code	Name	Possible settings		
		Lenze	Choice	Info
C001 C2001	Operating mode	-0-	-0-	Setpoint selection via term. 8 (jumper setting see chapter 4.2.8.2) Control via terminals parameter setting with 8201BB
C005 C2005	Configuration	-0-	-0-	Operation with open-loop control via terminal 8
C008 C2008	Function relay K1	-1-	-14-	Apparent motor current (C054) < Current threshold C156 and acceleration finished (Belt monitoring)
C014 C2014	Control mode	-0-	-3-	Square characteristic $V \sim f_d^2$ with constant V_{\min} boost
C142 C2142	Start condition	-1-	-3-	Automatic start, if term. 28 HIGH, flying-restart circuit active
C156	Current threshold	0	50 %	
C182	$t_{\text{integration}}$ RFG S-shape	0.00	0.50 s	Smooth start / stop
C625	Skip frequency 1	480.00	30.00 Hz	Removal of mechanical resonances
C628	Skipping bandwidth, f_{skip}	0.00	10.00 %	
C988	DC-bus voltage threshold for DC-bus voltage control	0	81 %	Controlled deceleration after mains failure by changing the parameter set

Motor deceleration after mains failure

Parameter set changeover via DC-bus voltage control

PAR 1	PAR 2 (Code = C2XXX)
C007 = 2 C105 = 0.5 s	C2007 = 0 C2105 = 5.00 s



Note!

Terminal E3 must always be at L-level (PAR2: normal operation; PAR1: QSP)



Application examples

Code settings for unit 2:

Code	Name	Possible settings		
		Lenze	Choice	Info
C001	Operating mode	-0-	-0-	Setpoint selection via term. 8 (jumper setting see chapter 4.2.8.2) Control via terminals parameter setting with 8201BB
C005	Configuration	-0-	-0-	Operation with open-loop control via terminal 8
C014	Control mode	-0-	-3-	Square characteristic $V \sim f_{\sigma}^2$ with constant V_{\min} boost

According to the information given in both tables (code setting for unit 1 and 2):

1. All other parameters are based on the factory setting.
2. Set the rated motor data under C088 (rated motor current) and C091 (motor $\cos \varphi$) depending on the motor connected.

EDS8200U--L
00406191

Manual

Part L

Signal-flow charts

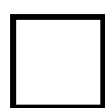

Global Drive
Frequency inverters 8200

This Manual is valid for 82XX controllers as of version:

	33.820X-	E-	1x.	1x		(8201 - 8204)
	33.8202-	E-	1x.	1x	-V002	Reduced assembly depth (8202)
	33.821X-	E-	0x.	1x		(8211 - 8218)
	33.821X-	E-	1x.	2x		(8211 - 8218)
	33.821X-	C-	1x.	2x	-V003	Cold plate (8215 - 8218)
	33.821X-	E-	3a.	3x	-V020	HVAC (8211 - 8218)
	33.822X-	E-	0x.	0x		(8221 - 8227)
	33.822X-	C-	1x.	2x	-V003	Cold plate (8221 - 8222)
	33.822X-	E-	3a.	3x	-V020	HVAC (8221 - 8227)
	33.824X-	E-	1x.	1x		(8241 - 8246)
	33.824X-	C-	1x.	1x	-V003	Cold plate (8241 - 8246)
	33.824X-	E-	3a.	3x	-V020	HVAC (8241 - 8246)
Type						
Design: B = Module C = Cold plate E = Built-in unit IP20						
Hardware version and index						
Software version and index						
Variant						
Explanation						

		revised	
Edition of:	01/1999		

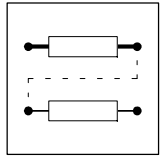

16 Signal-flow charts

blank

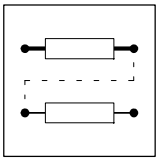

Signal flow charts

16.1 Signal-flow chart for types 820X

16.1.1 Control structure

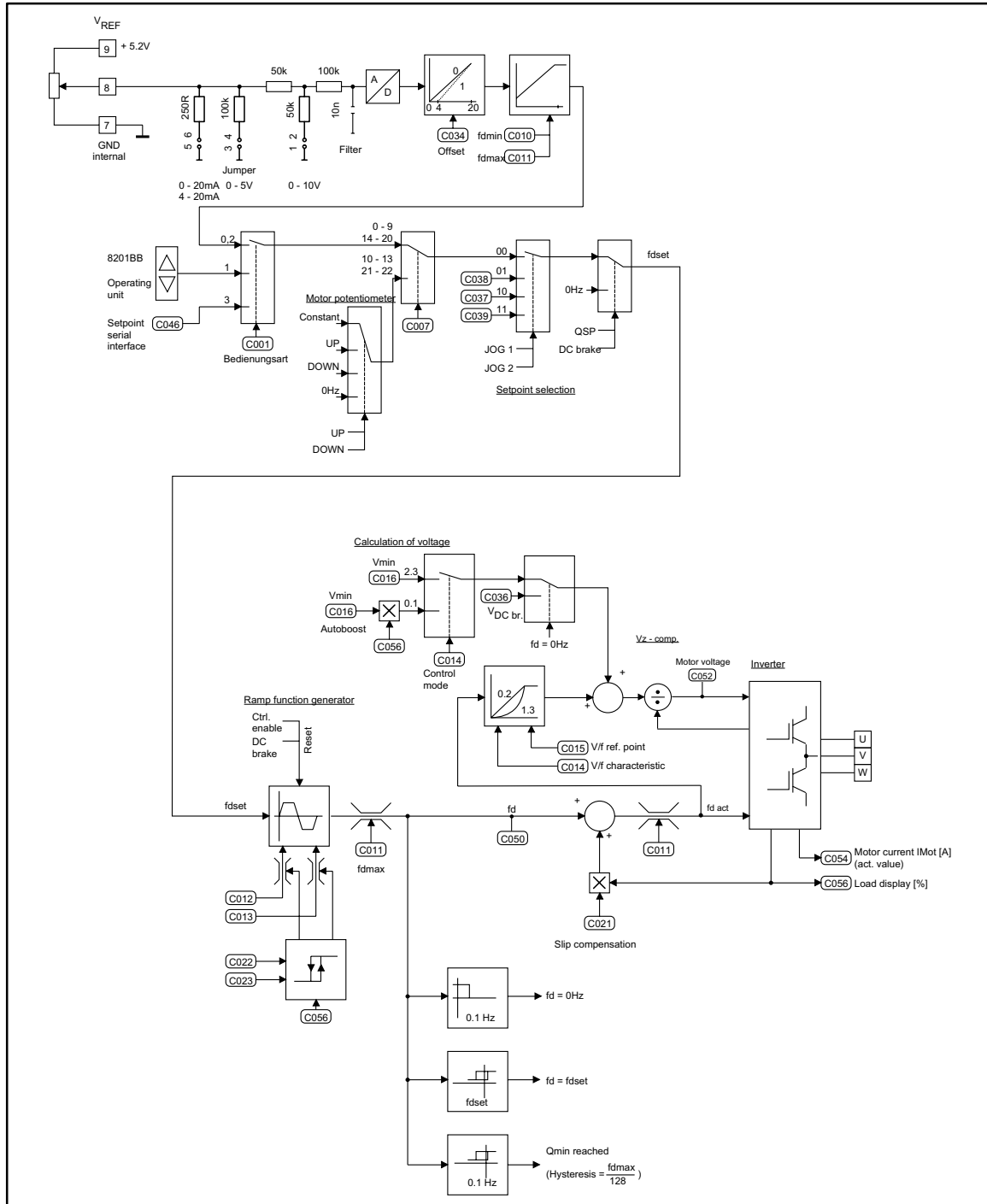
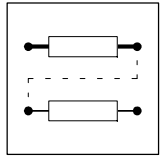

FIG 16-1 Signal flow 8200: Control structure



16.1.2 Inverter control

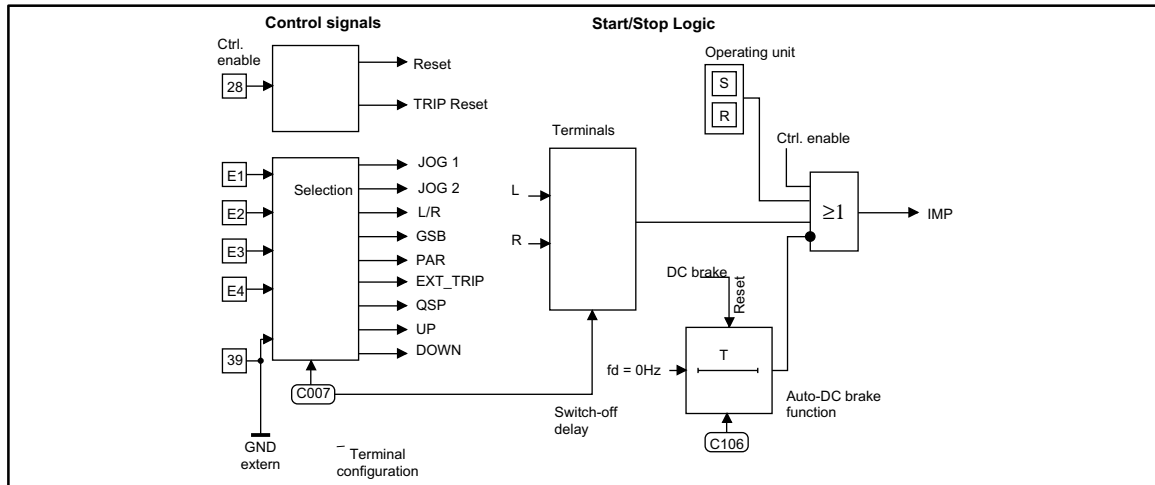

FIG 16-2 820X signal flow: Inverter control

16.1.3 Monitorings

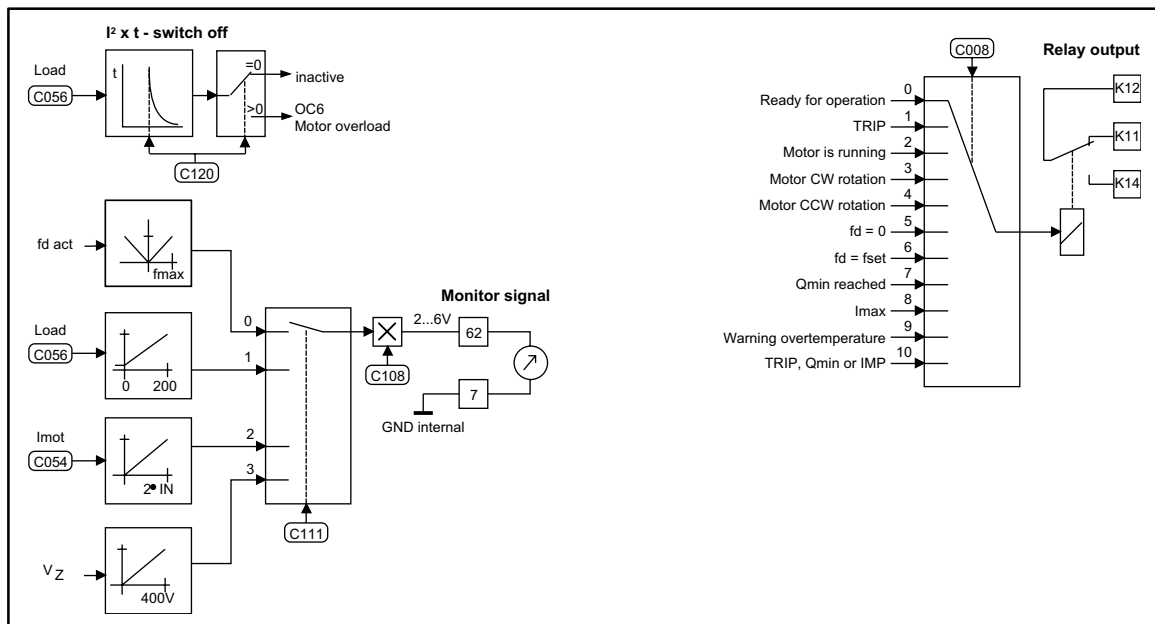
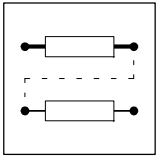

FIG 16-3 Signal flow 820X: Monitorings



Signal flow charts

16.2 Signal-flow charts for types 821X/822X/824X

16.2.1 Control structure control mode V/f control

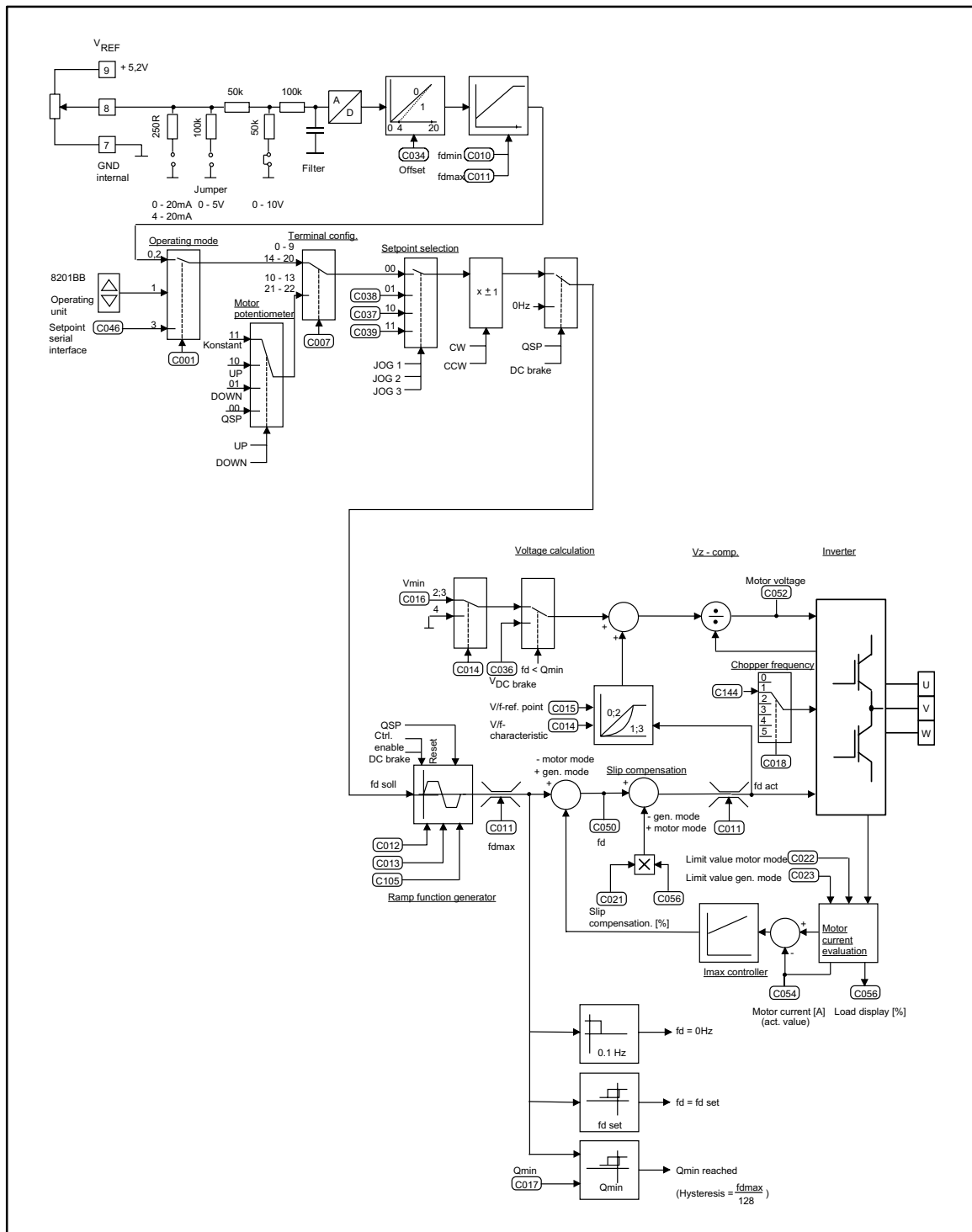
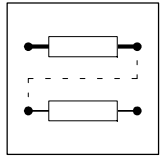

FIG 16-4 Signal flow 821X/822X/824X: Control structure control mode V/f-control



16.2.2 Control structure control mode motor current control

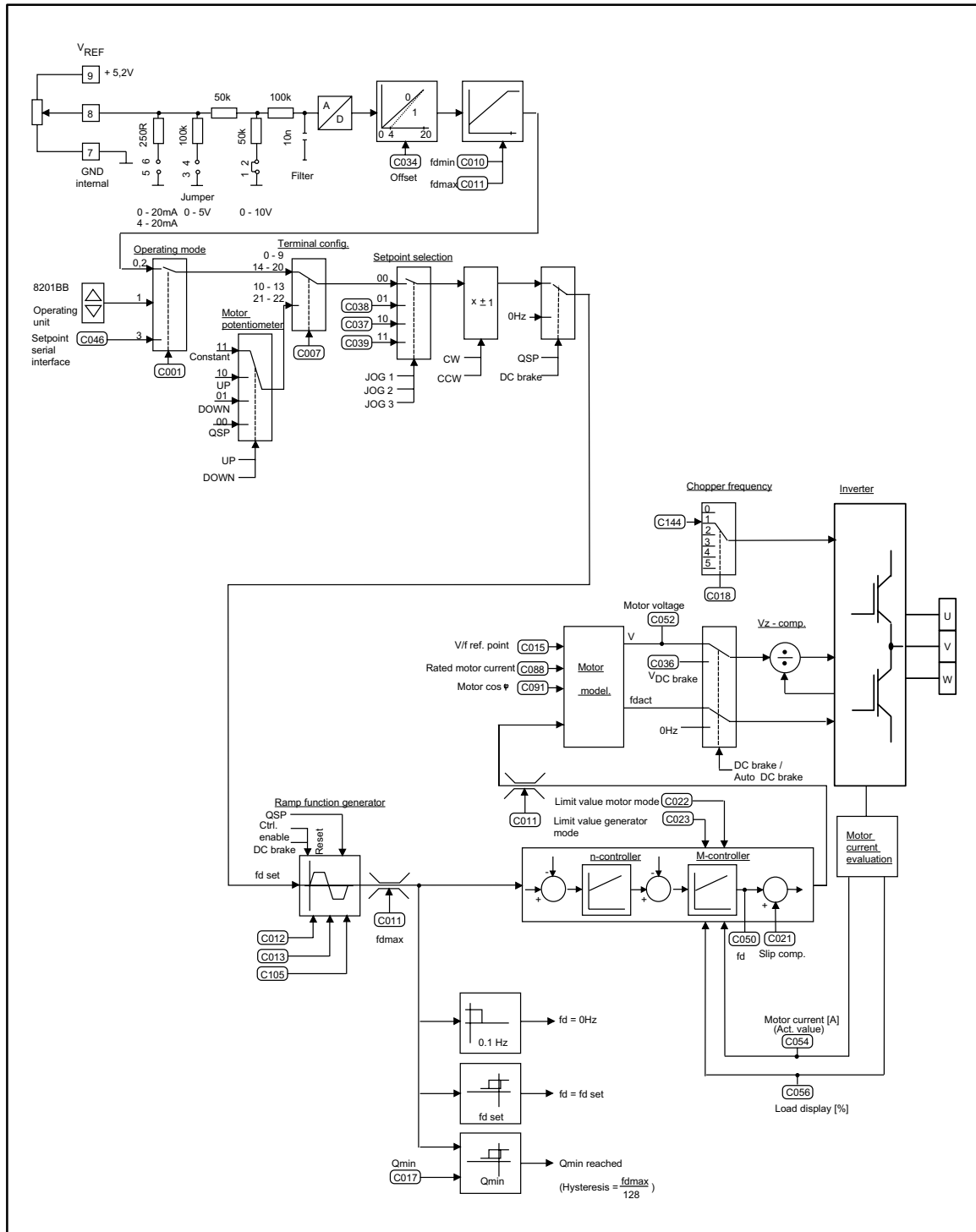
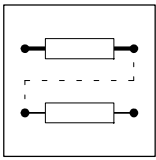

FIG 16-5 Signal-flow 821X/822X/824X: Control structure control mode motor current control



Signal flow charts

16.2.3 Inverter control

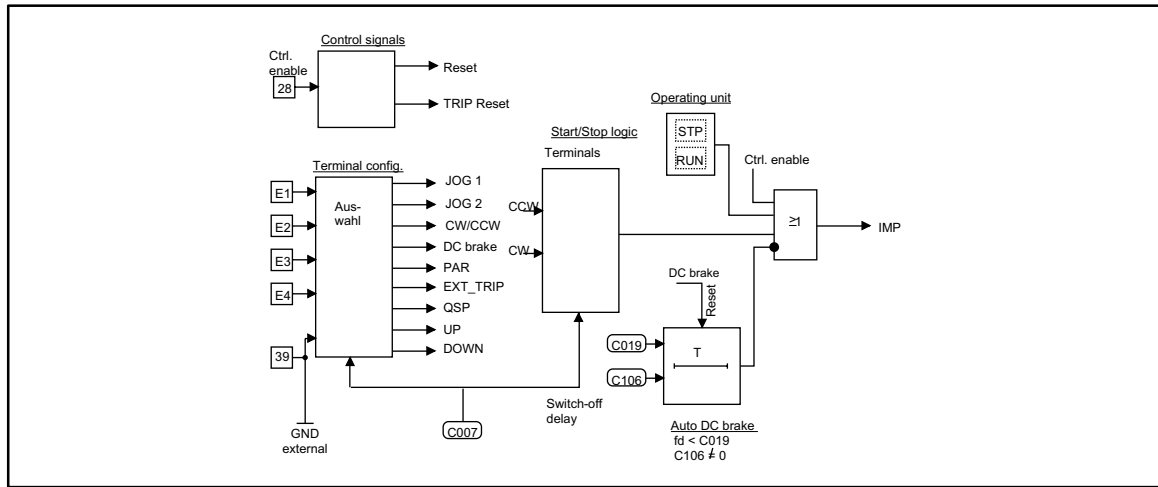

FIG 16-6 821X/822X/824X signal flow: Inverter control

16.2.4 Monitorings

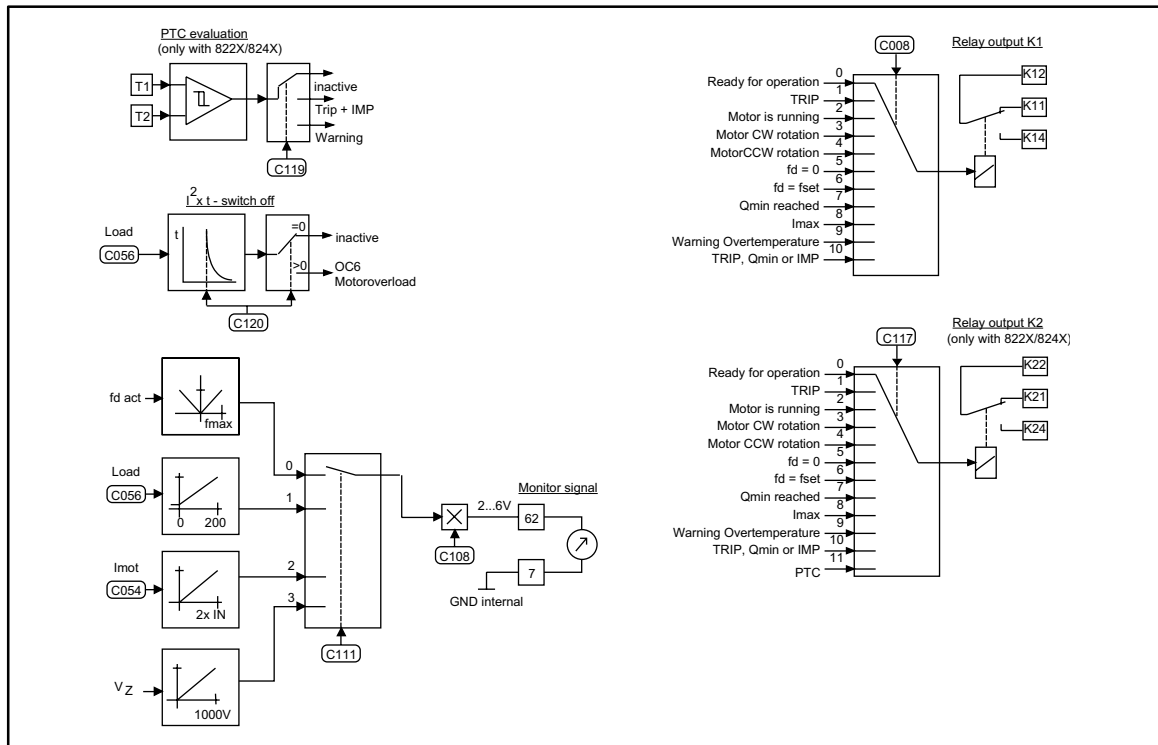
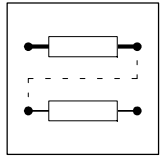

FIG 16-7 Signal-flow 821X/822X/824X: Monitorings



16.3 Signal-flow charts for types 821X/822X/824X-HVAC

16.3.1 Process and speed controller for C005 = -0-

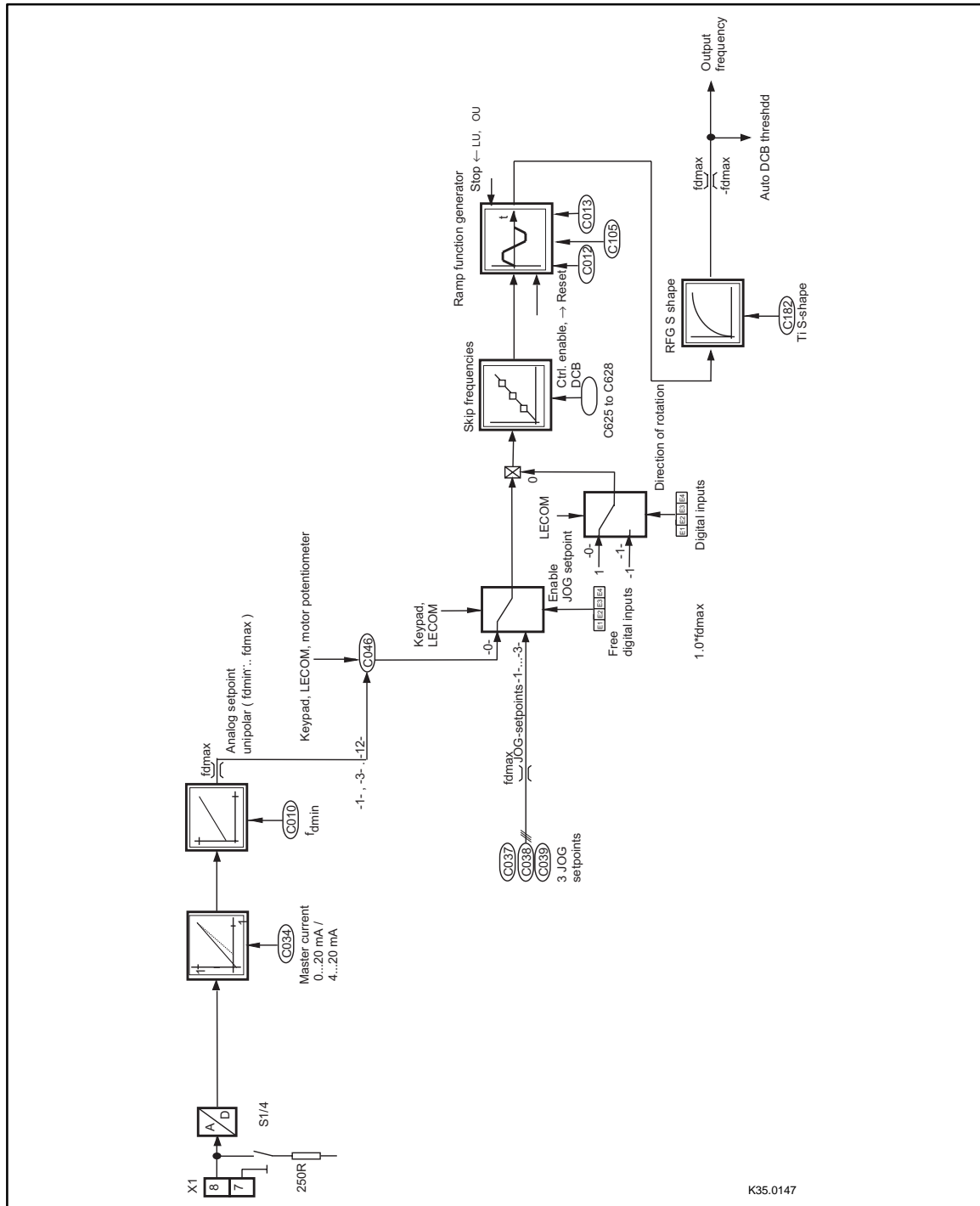

FIG 16-8 Process and speed controller for C005 = -0-

EDS8200U--M
00406192

Manual

Part M

Glossary

Table of keywords

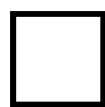

Global Drive

Frequency inverters 8200

This Manual is valid for 82XX controllers as of version:

	33.820X-	E-	1x.	1x		(8201 - 8204)
	33.8202-	E-	1x.	1x	-V002	Reduced assembly depth (8202)
	33.821X-	E-	0x.	1x		(8211 - 8218)
	33.821X-	E-	1x.	2x		(8211 - 8218)
	33.821X-	C-	1x.	2x	-V003	Cold plate (8215 - 8218)
	33.821X-	E-	3a.	3x	-V020	HVAC (8211 - 8218)
	33.822X-	E-	0x.	0x		(8221 - 8227)
	33.822X-	C-	1x.	2x	-V003	Cold plate (8221 - 8222)
	33.822X-	E-	3a.	3x	-V020	HVAC (8221 - 8227)
	33.824X-	E-	1x.	1x		(8241 - 8246)
	33.824X-	C-	1x.	1x	-V003	Cold plate (8241 - 8246)
	33.824X-	E-	3a.	3x	-V020	HVAC (8241 - 8246)
Type						
Design: B = Module C = Cold plate E = Built-in unit IP20						
Hardware version and index						
Software version and index						
Variant						
Explanation						

		revised	
Edition of:	01/1999		

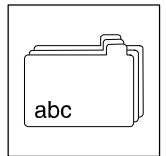

17 Glossary

Term	Meaning
AIF	Automation interface (X1)
CAN	Controller Area Network
CE	Communauté Européenne (English: European Community)
Code	For entry and display (access) of parameter values Variable addressing according to the format "code/subcode" (Cxxx/xx) All variables can be addressed via the code digits.
Ctrl. enable	Controller enable
Ctrl. inhibit	Controller inhibit (= Controller enable)
Fieldbus	For data exchange between superimposed control and positioning control, e.g. INTERBUS or PROFIBUS
FPDA	Freely programmable digital output
FPDE	Freely programmable digital input
GDC	Global Drive Control (PC-program (Windows) for Lenze controllers)
RFG	Ramp generator
INTERBUS	Industrial communication standard to DIN E19258
JOG	Fixed speed or input for fixed speed
Target position	The target which is to be approached by means of a defined traversing profile
LECOM	Lenze Communication
LEMOC2	PC-program (DOS) for Lenze controllers
LU	Undervoltage
Master	Masters are host systems, e.g. PLC or PC.
OU	Overvoltage
PC	Personal Computer
P _{DC}	This power can be additionally obtained from the DC bus when operating a matching motor.
PM	Permanent magnet
PROFIBUS	Communication standard DIN 19245, consisting of part 1, part 2 and part 3
Process data	For instance, setpoints and actual values of controllers which must be exchanged within a minimum of time Process data are usually small amounts of data which are to be transmitted cyclically. For PROFIBUS, these data are transmitted in the logic process data channel.
QSP	Quick stop
Slave	Bus device which may only send after the request of the master. Controllers are slaves.
PLC	Programmable logic controller

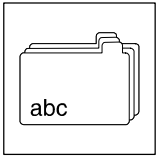

Glossary

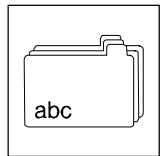

18 Table of keywords

A

AC-motor braking: *Part D 7-12*
 Acceleration times: *Part C 5-4; Part D 7-16*
 Accessory kit: *Part A 1-1*
 Actual value, Digital supply: *Part D 7-60*
 Aggressive gases: *Part B 4-1*
 Analog output: *Part D 7-69*
 Analog plug-in module
 Assembly: *Part B 4-24*
 Features: *Part B 3-24*
 Technical data: *Part B 3-24*
 Application as directed: *Part A 1-3*
 Application conditions: *Part B 3-4*
 Application datum, Display: *Part C 5-15; Part D 7-63*
 Application examples: *Part K 15-1*
 Air conditioning: *Part K 15-8*
 Air conditioning system: *Part C 5-26*
 Dancer position control: *Part C 5-23; Part K 15-6*
 For PID controllers: *Part C 5-18*
 Pump with level control: *Part C 5-21; Part K 15-4*
 Pump with pressure control: *Part C 5-18; Part K 15-1*
 Approvals: *Part B 3-4*
 Assembly: *Part B 4-1*
 Analog plug-in module: *Part B 4-24*
 Cold plate technique
 Demands on the cooler: *Part B 4-15*
 Fields of application: *Part B 4-14*
 Preparations: *Part B 4-17*
 Thermal performance: *Part B 4-16*
 Types 821X: *Part B 4-18*
 Types 822X: *Part B 4-21*
 Types 824X: *Part B 4-22*
 DIN-rail
 Types 820X: *Part B 4-8*
 Types 821X: *Part B 4-9*
 Thermally separated: *Part B 4-10*
 Types 821X: *Part B 4-11*
 Types 822X: *Part B 4-12*
 Types 824X: *Part B 4-13*
 Variant with reduced assembly depth, Type 8202-V002: *Part B 4-3*

With fixing brackets, Types 824X: *Part B 4-7*
 With fixing rails
 Types 820X: *Part B 4-3*
 Types 821X: *Part B 4-4*
 With mains filter: *Part B 4-23*

Asynchronous standard motors: *Part A 1-3*
 Auto-TRIP reset: *Part E 8-4*

B

Bar-graph display: *Part D 7-3*
 Brake unit: *Part B 4-34*

C

Cable cross-section, Network of several drives: *Part F 10-6*
 Cable cross-sections: *Part B 4-29*
 Control cables: *Part B 4-38*
 DC-bus: *Part F 9-4*
 Max. permissible: *Part B 4-28*
 Single drives: *Part B 3-21*
 120 % overload: *Part B 3-23*
 150 % overload: *Part B 3-22*
 Cable specification: *Part B 4-27*
 CE mark: *Part A 1-4*
 Central supply. *See Network of several drives*
 Changeover, Manual/remote operation: *Part D 7-59*
 Chopper frequency derating: *Part D 7-30*
 Chopper frequency of inverter: *Part D 7-29*
 Noise optimised: *Part D 7-29*
 Cleaning: *Part E 9-1*
 Code: *Part D 7-1*
 Code level: *Part D 7-4*
 Code table
 Explanation: *Part D 7-77, 7-85*
 HVAC series: *Part D 7-85*
 Standard series: *Part D 7-77*
 Cold Plate
 Demands on the cooler: *Part B 4-15*
 Fields of application: *Part B 4-14*
 Max. temperature of heat sink: *Part B 4-15*
 Variant: *Part B 4-14*

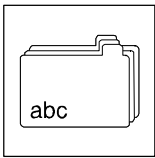
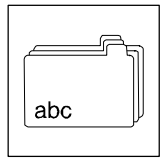

Table of keywords

- Cold plate, Thermal resistance: *Part B* 4-15
- Commissioning: *Part C* 5-1
- Condensation: *Part C* 5-1
- Configuration: *Part D* 7-1
- Acceleration and deceleration times: *Part C* 5-4; *Part D* 7-16
 - Analog output: *Part D* 7-69
 - Basics: *Part D* 7-1
 - Change of the direction of rotation: *Part D* 7-54
 - Chopper frequency of inverter: *Part D* 7-29
 - Code: *Part D* 7-1
 - Code table: *Part D* 7-77, 7-85
 - Control functions: *Part D* 7-15
 - Control mode: *Part D* 7-19
 - Controller enable: *Part D* 7-48
 - Current limit values: *Part C* 5-5; *Part D* 7-17
 - Current limitation controller: *Part D* 7-18
 - DC-injection brake (DCB): *Part D* 7-56
 - Digital inputs: *Part D* 7-50
 - Display functions: *Part D* 7-62
 - Level inversion: *Part D* 7-52
 - Manual / remote operation: *Part D* 7-59
 - Maximum field frequency: *Part C* 5-3; *Part D* 7-15
 - Minimum field frequency: *Part C* 5-3; *Part D* 7-15
 - Monitoring functions: *Part D* 7-65
 - Motor data detection: *Part D* 7-27
 - Operating functions: *Part D* 7-9
 - Oscillation damping: *Part D* 7-31
 - Parameter set changeover (PAR): *Part D* 7-58
 - Parameters: *Part D* 7-1
 - Priority mask: *Part D* 7-53
 - Quick stop (QSP): *Part D* 7-55
 - Relay outputs: *Part D* 7-65
 - Setpoint input: *Part D* 7-40
 - Signal-flow charts: *Part L* 16-1
 - Slip compensation: *Part D* 7-28
 - Start conditions/flying-restart circuit: *Part D* 7-49
 - Thermal motor monitoring: *Part D* 7-71
 - TRIP set: *Part D* 7-58
 - V/f-rated frequency: *Part D* 7-22
 - Vmin setting: *Part D* 7-24
- Connection
- Analog plug-in module: *Part B* 4-42
 - Brake unit: *Part B* 4-34
 - Control, Connection diagram: *Part B* 4-41
 - Control cables: *Part B* 4-38
 - Mains: *Part B* 4-28
 - Motor: *Part B* 4-29
- Power
- Connection diagram 820X: *Part B* 4-35
 - Connection diagram 821X: *Part B* 4-36
 - Connection diagram 822X/824X: *Part B* 4-37
 - Temperature monitoring: *Part B* 4-41
- Connection diagram
- Control connections: *Part B* 4-41
 - Analog plug-in module: *Part B* 4-42
 - Power connection 820X: *Part B* 4-35
 - Power connection 821X: *Part B* 4-36
 - Power connection 822X/824X: *Part B* 4-37
- Connections, Power: *Part B* 4-28
- Control cables: *Part B* 4-38
- Control connections: *Part B* 4-38
- Control functions: *Part D* 7-15
- Control mode: *Part D* 7-19
- Permissible: *Part B* 4-32; *Part C* 5-6
- Control terminals: *Part B* 4-38
- Max. permissible cross-sections, For motor connection: *Part B* 4-38
 - Overview: *Part B* 4-38
 - Protection against polarity reversal: *Part B* 4-39
 - Terminal assignment: *Part B* 4-38
- Controlled deceleration in the event of mains failure: *Part D* 7-13
- Controller
- Application as directed: *Part A* 1-3
 - Identification: *Part A* 1-3
 - Protection: *Part B* 4-26
- Controller enable: *Part D* 7-48
- Controllers: *Part A* 1-1
- Cooling air: *Part B* 4-1
- Current limitation controller: *Part D* 7-18
- Current limits: *Part C* 5-5; *Part D* 7-17
- Controller not active: *Part D* 7-17
 - Earth-fault detection: *Part D* 7-17



D

DC-bus, Cable cross-section: *Part F 9-4*
 DC-bus fuse: *Part F 9-5*
 DC-injection brake: *Part D 7-56*
 Deceleration times: *Part C 5-4; Part D 7-16*
 Decentral supply. *See Network of several drives*
 Definitions: *Part A 1-1*
 Degree of pollution: *Part B 3-4*
 Derating: *Part C 5-5; Part D 7-17, 7-29, 7-31*
 Digital inputs: *Part D 7-50*
 Dimensions
 8202-V002 reduced assembly depth: *Part B 4-3*
 820X on DIN rails: *Part B 4-8*
 820X with fixing rails: *Part B 4-3*
 821X on DIN rails: *Part B 4-9*
 821X thermally separated: *Part B 4-11*
 821X with fixing rails: *Part B 4-4*
 821X-V003 cold plate: *Part B 4-18*
 822X thermally separated: *Part B 4-12*
 822X-V003 cold plate: *Part B 4-21*
 824X thermally separated: *Part B 4-13*
 824X with fixing brackets: *Part B 4-7*
 824X-V003 cold plate: *Part B 4-22*
 Analog plug-in module: *Part B 3-25*
 Controllers: *Part B 3-25*
 With mains filter: *Part B 4-23*
 Direction of rotation
 Failsafe change: *Part D 7-54*
 Not failsafe change: *Part D 7-54*
 Display
 Application datum: *Part C 5-15; Part D 7-63*
 Bar-graph: *Part D 7-3*
 LCD: *Part D 7-3*
 LED: *Part C 6-2; Part E 8-1*
 Operating module: *Part D 7-2*
 Operating status: *Part C 6-2; Part E 8-1*
 Operating time/mains connection time: *Part D 7-64*
 Software version/controller type: *Part D 7-64*
 Status: *Part D 7-3*
 Display functions: *Part D 7-62*
 Application datum: *Part D 7-63*
 Elapsed operating time meter: *Part D 7-64*
 Possible values: *Part D 7-62*

Software version/controller type: *Part D 7-64*
 Switch-on display: *Part D 7-62*

Display values: *Part D 7-62*
 Disposal: *Part A 1-3*
 Drive parameters, Factory setting: *Part C 5-2*
 Drive performance, Influence of the motor cable length: *Part B 4-32*
 Drive system: *Part A 1-1*

E

Earth fault, Detection: *Part D 7-17*
 EC Directives: *Part A 1-4*
 Electromagnetic compatibility: *Part A 1-7*
 CE-typical drive system: *Part A 1-8*
 Declaration of conformity: *Part A 1-9*
 Standards considered: *Part A 1-9*
 Low Voltage: *Part A 1-5*
 Declaration of conformity: *Part A 1-6*
 Standards considered: *Part A 1-6*
 Machinery: *Part A 1-11*
 Manufacturer's Declaration: *Part A 1-12*
 Elapsed operating time meter: *Part D 7-64*
 Electrical installation: *Part B 4-25*
 Important notes: *Part B 4-25*
 EMC
 Assembly: *Part B 4-43*
 CE-typical drive system, Installation: *Part B 4-43*
 Filters: *Part B 4-43*
 Grounding: *Part B 4-44*
 Installation: *Part B 4-43*
 Screening: *Part B 4-44*
 Emergency switch-off: *Part C 6-1*
 Enclosure: *Part B 3-4*
F
 Factory setting: *Part D 7-5*
 Important drive parameters: *Part C 5-2*
 Short commissioning: *Part C 5-2*
 Switch-on sequence: *Part C 5-2*
 Fans, Application 82XX: *Part B 3-18*
 FAST-ON connector: *Part B 4-29*
 Fault analysis: *Part E 8-2*
 Fault elimination: *Part E 8-1*
 Fault indication, Reset: *Part E 8-4*

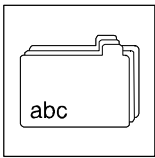

Table of keywords

Fault message, External: *Part D 7-58*

Fault messages: *Part E 8-2*

Features: *Part B 3-2*

Field frequency

Maximum: *Part C 5-3; Part D 7-15*

Minimum: *Part C 5-3; Part D 7-15*

Fieldbus module

Change/store parameters: *Part D 7-8*

INTERBUS: *Part D 7-8*

RS232/RS485: *Part D 7-8*

System bus (CAN): *Part D 7-8*

Flying-restart circuit: *Part C 6-1; Part D 7-49*

Free space for assembly: *Part B 4-1*

Frequency, Skipping: *Part D 7-33*

Frequency input, Digital: *Part D 7-60*

Frequency inverters. *See* Controllers

Frequency precontrol: *Part D 7-39*

Frequency setting range: *Part D 7-39*

Fuses

In UL-approved systems: *Part B 3-21*

Mains connection: *Part B 4-29*

Network of several drives: *Part F 10-6*

Single drives: *Part B 3-21*

120 % overload: *Part B 3-23*

150 % overload: *Part B 3-22*

G

General data: *Part B 3-4*

Glossary: *Part M 16-1*

See Glossary

H

Heat-conducting paste: *Part B 4-17*

History buffer: *Part E 8-2*

Assembly: *Part E 8-2*

Humidity class: *Part B 3-4*

I

Identification, Controller: *Part A 1-3*

Initial switch-on: *Part C 5-1*

Initial-current limitation: *Part C 6-1*

Inputs

Analog: *Part B 4-40*

Digital: *Part B 4-40; Part D 7-50*

digital, Response times: *Part D 7-50*

PTC: *Part D 7-72*

Installation

CE-typical drive system: *Part B 4-43*

Assembly: *Part B 4-43*

Filters: *Part B 4-43*

Grounding: *Part B 4-44*

Screening: *Part B 4-44*

Electrical: *Part B 4-25*

Mechanical: *Part B 4-1*

Installation height: *Part B 3-4*

Insulation: *Part B 4-25*

Insulation strength: *Part B 3-4*

INTERBUS: *Part D 7-8*

Interface

LECOM: *Part D 7-8*

RS232/RS485: *Part D 7-8*

J

JOG frequencies: *Part D 7-43*

Jumper

Analog setpoint input: *Part D 7-40*

Analog setpoint selection: *Part B 4-40*

K

Keypad, Setpoint input: *Part D 7-42*

L

LECOM: *Part D 7-8*

Legal regulations: *Part A 1-3*

Lenze convection coolers

Assembly in the control cabinet: *Part B 4-18*

Wall mounting: *Part B 4-20*

Level inversion: *Part D 7-52*

Liability: *Part A 1-3*

Light emitting diode: *Part C 6-2; Part E 8-1*

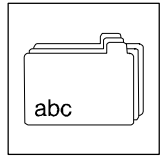

M

Mains conditions: *Part B 4-27*
Mains connection: *Part B 4-28*
 Protection: *Part B 4-29*
Mains connection and disconnection, Cyclic: *Part C 6-1*
Mains connection time: *Part D 7-64*
Mains types: *Part B 4-27*
Mains voltage compensation: *Part C 5-10, 5-12; Part D 7-22*
Maintenance: *Part E 9-1*
Maloperation of the drive: *Part E 8-2*
Manual operation: *Part D 7-59*
Manufacturer: *Part A 1-3*
Max. temperature: *Part B 4-15*
Mechanical installation: *Part B 4-1*
Messages, Fault: *Part E 8-2*
Monitor output: *Part B 4-40; Part D 7-69*
Monitoring, Motor temperature: *Part B 4-40*
Monitoring functions: *Part D 7-65*
Motor
 Adaptation: *Part C 5-6*
 Thermal monitoring
 Sensorless: *Part D 7-71*
 With PTC resistor: *Part D 7-72*
Motor adaptation: *Part C 5-6*
Motor cable
 Influence of the length: *Part B 4-32*
 Screening: *Part B 4-29*
Motor cables, Protection: *Part B 3-21*
Motor connection: *Part B 4-29*
 Types 822X: *Part B 4-30*
 Types 824X: *Part B 4-31*
Motor data detection: *Part D 7-27*
Motor monitoring: *Part D 7-71*
Motor potentiometer: *Part D 7-44, 7-46*
Motor protection: *Part B 4-26*
Motor-current control: *Part D 7-20*
Motor, Phase failure: *Part D 7-73*
Phase, Failure detection: *Part D 7-73*

Mounting positions

Types 820X: *Part B 4-2*
Types 8211-8214: *Part B 4-2*
Types 8215-8218: *Part B 4-2*
Types 822X/824X: *Part B 4-2*

N

Network of several drives: *Part F 9-1*
 Central supply: *Part F 10-14*
 820X: *Part F 10-14*
 821X/822X/824X/93XX: *Part F 10-15*
 Conditions: *Part F 9-2*
 DC-bus connection: *Part F 9-4*
 Decentral supply: *Part F 10-16*
 820X: *Part F 10-16*
 821X/822X/824X/93XX: *Part F 10-17*
 Filter assignment: *Part F 10-11*
 Function: *Part F 9-1*
 Mains connection: *Part F 9-3*
 Possible combinations: *Part F 9-2*
 Protection concept: *Part F 10-7*
 Selection basics: *Part F 10-9*
 Several drives: *Part F 9-1*
 Supply power: *Part F 10-10*
Noise emission: *Part B 3-4*
Noise immunity: *Part B 3-4*
Noise optimised operation: *Part D 7-29*
Normalisation, Application datum: *Part C 5-15*

O

ONLINE: *Part D 7-5*
Operating functions: *Part D 7-9*
Operating information: *Part C 6-1*
Operating level: *Part D 7-4*
Operating mode: *Part D 7-9*
Operating module
 Bar-graph display: *Part D 7-3*
 Change/store parameters: *Part D 7-6*
 Fault indication: *Part E 8-1*
 Functions: *Part D 7-2*
 Key functions: *Part D 7-3*
 LCD display: *Part D 7-3*
 Parameter transfer: *Part D 7-2*
 Status display: *Part D 7-3*

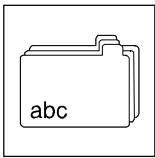
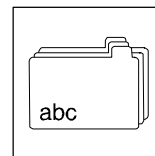

Table of keywords

- Operating program: *Part D 7-4*
Code level: *Part D 7-4*
Operating level: *Part D 7-4*
Parameter level: *Part D 7-5*
- Operating status, Display: *Part C 6-2; Part E 8-1*
- Operating time: *Part D 7-64*
- Operation
Noise optimised: *Part D 7-29*
Status display: *Part C 6-2; Part E 8-1*
- Operator's safety: *Part A 2-2; Part B 4-25*
- Oscillation damping: *Part D 7-31*
Reduction of speed oscillations: *Part D 7-31*
- Oscillations: *Part B 4-1*
- Output, Analog: *Part D 7-69*
- Outputs, Analog: *Part B 4-40*
- Overspeed: *Part C 6-1*
- Overspeeds: *Part A 2-2*
- Overview of types: *Part B 3-1*
- P**
- Packaging: *Part B 3-4*
- Parameter: *Part D 7-1*
Absolute: *Part D 7-5*
Change: *Part D 7-5*
Dynamic: *Part D 7-8*
Change ONLINE: *Part D 7-6*
Change when the controller is inhibited: *Part D 7-7*
Change with acknowledgement: *Part D 7-6*
Change/store with the fieldbus module: *Part D 7-8*
Change/store with the operating module: *Part D 7-6*
Relative: *Part D 7-5*
Store: *Part D 7-5*
Types: *Part D 7-5*
- Parameter level: *Part D 7-5*
- Parameter set changeover
AC-motor braking: *Part D 7-12*
Controlled deceleration in the event of mains failure: *Part D 7-13*
- Parameter sets: *Part D 7-5*
Changeover via terminal PAR: *Part D 7-58*
Dynamical storage: *Part D 7-8*
Working with: *Part D 7-10*
- Parameter setting, Flow chart: *Part D 7-4*
- Parameter transfer: *Part D 7-2*
- Parameters: *Part D 7-5*
- PID controller: *Part C 5-16; Part D 7-34*
Air conditioning system: *Part C 5-26; Part K 15-8*
Application examples: *Part C 5-18*
Dancer position control: *Part C 5-23; Part K 15-6*
Integral component, Reset: *Part D 7-38*
Pump with level control: *Part C 5-21; Part K 15-4*
Pump with pressure control: *Part C 5-18; Part K 15-1*
Setpoint input: *Part D 7-38*
Setpoint precontrol: *Part D 7-39*
Setting: *Part D 7-34*
Influence: *Part D 7-38*
- PM synchronous motors: *Part A 1-3*
- Power connections: *Part B 4-28*
Max. permissible cross-sections: *Part B 4-28*
- Priority mask: *Part D 7-53*
- Protection against contact: *Part B 4-25, 4-38*
- Protection against polarity reversal: *Part B 4-39*
- Protection of controller: *Part B 4-26*
- Protection of devices: *Part A 2-2*
- PTC input: *Part D 7-72*
- Pulse inhibit: *Part D 7-66, 7-68*
- Pumps, Application of 82XX: *Part B 3-18*
- Push-through technique: *Part B 4-10*
- Q**
- Quick stop: *Part D 7-55*
- R**
- R.c.c.b.: *Part B 4-25*
- Rated data
Types 8201-8204, 150 % overload: *Part B 3-5*
Types 8211-8214, 150 % overload: *Part B 3-6*
Types 8215-8218, 150 % overload: *Part B 3-8*
Types 821X, 120 % overload: *Part B 3-18*
Types 8221-8224, 150 % overload: *Part B 3-10*
Types 8225-8227, 150 % overload: *Part B 3-12*
Types 822X, 120 % overload: *Part B 3-19*
Types 8241-8243, 150 % overload: *Part B 3-14*
Types 8244-8246, 150 % overload: *Part B 3-16*
Types 824X, 120 % overload: *Part B 3-20*
- Relay output: *Part B 4-40*



Relay outputs: *Part D 7-65*
 Reluctance motors: *Part A 1-3*
 Remote operation: *Part D 7-59*
 Reset, Fault indication: *Part E 8-4*
 Residual hazards: *Part A 2-2*
 Residual-current operated protective devices: *Part B 4-25*
 Response times of digital inputs: *Part D 7-50*
 Running optimisation: *Part D 7-28*

S

Safety information: *Part A 2-1*
 For controllers to Low-Voltage Directive: *Part A 2-1*
 Layout: *Part A 2-2*
 Other notes: *Part A 2-2*
 Warning of damage to material: *Part A 2-2*
 Warning of danger to persons: *Part A 2-2*

Scope of delivery: *Part A 1-1*

Screen sheet: *Part B 4-38*

Screening

Control cables: *Part B 4-38*
 EMC: *Part B 4-44*
 Motor cable: *Part B 4-29*

Service addresses: *Part E 9-2*

Setpoint input: *Part D 7-40, 7-41*

Analog: *Part D 7-40*
 Jumper position: *Part D 7-40*

Digital: *Part D 7-60*

Inverse: *Part D 7-41*

PID controller: *Part D 7-38*

Using the keypad: *Part D 7-42*

Via JOG frequencies: *Part D 7-43*

Via motor potentiometer: *Part D 7-44*

Via motor potentiometer and JOG: *Part D 7-46*

Setpoint precontrol: *Part D 7-39*

Setpoint sum: *Part D 7-47*

Short commissioning: *Part C 5-2*

Signal-flow charts: *Part L 16-1*

820X: *Part L 16-2*

821X/822X/824X: *Part L 16-4*

HVAC: *Part L 16-7*

Motor current control: *Part L 16-5*

V/f-control: *Part L 16-4*

Skip frequency: *Part D 7-33*

Slip compensation: *Part D 7-28*

Software, Operating programs: *Part D 7-8*

Software version: *Part D 7-64*

Special motors, Operation of: *Part D 7-31*

Speed oscillations: *Part D 7-31*

Start options: *Part D 7-49*

Switch-on, Initial: *Part C 5-1*

Switch-on display: *Part D 7-62*

Switch-on sequence, Factory setting: *Part C 5-2*

Switching on the motor side: *Part B 4-31*

Switching units: *Part B 4-33*

System bus module: *Part D 7-8*

T

Technical data: *Part B 3-1*

Analog plug-in module: *Part B 3-24*
 Features: *Part B 3-24*

Controller features: *Part B 3-2*

General data/application conditions: *Part B 3-4*

Overview of types: *Part B 3-1*

Temperature monitoring: *Part B 4-41*

Temperature range: *Part B 3-4*

Thermal monitoring, Motor

Sensorless: *Part D 7-71*

With PTC resistor: *Part D 7-72*

Thermal resistance: *Part B 4-15*

Thermal separation: *Part B 4-10*

Tightening torques

Control terminals: *Part B 4-38*

Power terminals: *Part B 4-28, 4-31*

Torque, Indirect limitation: *Part D 7-61*

Transport, storage: *Part A 2-1*

TRIP: *Part E 8-4*

TRIP set: *Part D 7-58*

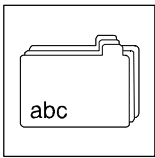

Table of keywords

Troubleshooting: *Part E 8-1*

Display at the operating module: *Part E 8-1*

Fault analysis with the history buffer: *Part E 8-2*

Fault message reset: *Part E 8-4*

Fault messages: *Part E 8-2*

LED display: *Part E 8-1*

Maloperation of the drive: *Part E 8-2*

TRIP: *Part E 8-4*

Type: *Part D 7-64*

U

Use, As directed: *Part A 1-3*

V

V/f characteristic: *Part D 7-22*

V/f-characteristic control

Auto boost: *Part D 7-22*

With auto boost: *Part D 7-19*

With V_{min} boost: *Part D 7-20*

V/f-rated frequency: *Part D 7-22*

87 Hz technique: *Part D 7-23*

Variant

821X-V003: *Part B 4-18*

822X-V003: *Part B 4-21*

824X-V003: *Part B 4-22*

Cold Plate: *Part B 4-14*

V002: *Part B 4-3*

V003: *Part B 4-14*

Vibration resistance: *Part B 3-4*

Vibrations: *Part B 4-1*

V_{min} setting: *Part D 7-24*

Drives with special motors: *Part C 5-11; Part D 7-24*

Voltage drop: *Part B 4-29*

W

Warranty: *Part A 1-3*