

SIEMENS

SIMATIC HMI

Industrial PC SIMATIC HMI IPC677C

Operating Instructions

Preface	
Safety	1
Description	2
Planning the use	3
Mounting	4
Connecting	5
Integration into an automation system	6
Commissioning	7
Operation and configuration	8
Operation	9
Functions	10
Service and maintenance	11
Alarm, error, and system messages	12
Troubleshooting/FAQs	13
Technical data	14
Dimensional drawings	15
Detailed descriptions	16
Appendix	A
List of abbreviations	B

Legal information

Warning notice system

This manual contains notices you have to observe in order to ensure your personal safety, as well as to prevent damage to property. The notices referring to your personal safety are highlighted in the manual by a safety alert symbol, notices referring only to property damage have no safety alert symbol. These notices shown below are graded according to the degree of danger.

⚠ DANGER
indicates that death or severe personal injury will result if proper precautions are not taken.
⚠ WARNING
indicates that death or severe personal injury may result if proper precautions are not taken.
⚠ CAUTION
indicates that minor personal injury can result if proper precautions are not taken.
NOTICE
indicates that property damage can result if proper precautions are not taken.

If more than one degree of danger is present, the warning notice representing the highest degree of danger will be used. A notice warning of injury to persons with a safety alert symbol may also include a warning relating to property damage.

Qualified Personnel

The product/system described in this documentation may be operated only by **personnel qualified** for the specific task in accordance with the relevant documentation, in particular its warning notices and safety instructions. Qualified personnel are those who, based on their training and experience, are capable of identifying risks and avoiding potential hazards when working with these products/systems.

Proper use of Siemens products

Note the following:

⚠ WARNING
Siemens products may only be used for the applications described in the catalog and in the relevant technical documentation. If products and components from other manufacturers are used, these must be recommended or approved by Siemens. Proper transport, storage, installation, assembly, commissioning, operation and maintenance are required to ensure that the products operate safely and without any problems. The permissible ambient conditions must be complied with. The information in the relevant documentation must be observed.

Trademarks

All names identified by ® are registered trademarks of Siemens AG. The remaining trademarks in this publication may be trademarks whose use by third parties for their own purposes could violate the rights of the owner.

Disclaimer of Liability

We have reviewed the contents of this publication to ensure consistency with the hardware and software described. Since variance cannot be precluded entirely, we cannot guarantee full consistency. However, the information in this publication is reviewed regularly and any necessary corrections are included in subsequent editions.

Preface

Purpose of this manual

These operating instructions contain all the information you need for commissioning and operating the SIMATIC IPC677C.

It is intended both for programming and testing personnel who commission the device and connect it with other units (automation systems, programming devices), as well as for service and maintenance personnel who install add-ons or carry out fault/error analyses.

Basic knowledge required

A solid background in personal computers and Microsoft operating systems is required to understand this manual. General knowledge in the field of automation control engineering is recommended.

Scope of this manual

This manual applies to devices with order numbers 6AV789....

Approvals

For more information, please refer to the chapter "Certificates and Guidelines" in the appendix.

CE marking

For more information, please refer to "Directives and Declarations" in the "Certificates and Guidelines" section of the appendix.

Standards

Please refer to sections "Application planning" and "Technical data".

Position in the information landscape

The documentation for the Panel PC includes the following sections:

- SIMATIC HMI IPC677C, Operating Instructions (compact), with the following information:
 - Commissioning
 - Legal information
- SIMATIC HMI IPC677C, Operating Instructions

The documentation is supplied with the Panel PC in electronic form as a PDF file on the "Documentation and Drivers" CD. The documentation is available in German, English, French, Italian, Spanish, and Chinese.

Conventions

Representation	Validity
"File"	<ul style="list-style-type: none"> • Terminology that appears in the user interface, for example menu commands, tabs, buttons • Required input, for example limit values, tag values • Path information
"File > Edit"	Operational sequences, for example, menu commands, shortcut menu commands
<F1>, <Shift>+<F1>	Keys and key combinations

The "IPC677C", "control unit" and "computer unit" are uniformly referred to as "device" in these operating instructions. The full term is only used when a concrete reference is necessary.

Furthermore, the "CP 1616 onboard" is referred to as "CP".

Note

A note is important information about the product, handling the product or a reference to specific sections of the documentation that require special consideration.

Trademarks

All names labeled with ® symbol are registered trademarks of Siemens AG. Other names used in this documentation may be trademarks, the use of which by third parties for their own purposes could violate the rights of the owner.

HMI®
SIMATIC®
SIMATIC HMI®
SIMATIC WinCC®
SIMATIC WinCC flexible®
Panel PC 677B®
IPC677C®

Table of contents

	Preface	3
1	Safety	11
1.1	Safety guidelines.....	11
1.2	General Information	13
1.3	ESD directives.....	16
2	Description	19
2.1	Design of IPC677C	19
2.2	Features	21
2.3	Accessories of IPC677C	24
3	Planning the use	25
3.1	Overview	25
3.2	Unpacking and checking the delivery	26
3.3	Device identification data	27
3.4	Mounting positions and fastening	28
3.4.1	Installation guidelines.....	28
3.4.2	Installation information stainless steel front	30
3.4.3	Permitted mounting positions.....	30
3.4.4	Type of fixation.....	31
3.4.5	Stainless steel front type of fixation	31
3.4.6	Protection against dust and water	32
3.5	Mounting cutout	33
3.5.1	Preparing the mounting cut-out.....	33
3.5.2	Mounting depth of the device.....	35
4	Mounting	37
4.1	Securing the device with clamps.....	37
4.2	Securing with screws	38
4.3	Fix the device with stainless steel front using clamps	39
5	Connecting	43
5.1	Connection elements	43
5.2	Connecting the 100 - 240 V AC Power Supply.....	46
5.3	Connecting the (24 V) DC power supply	49
5.4	Connecting the Equipotential Bonding Circuit	50
5.5	Equipotential bonding with stainless steel front.....	51
5.6	Connecting Ethernet/USB strain relief.....	51

5.7	Connecting the PROFINET strain relief	52
5.8	Connecting the power plug locking mechanism.....	52
6	Integration into an automation system	53
6.1	Overview	53
6.2	Device in SIMATIC S7 network.....	54
6.2.1	MPI/PROFIBUS-DP network.....	54
6.2.2	Connecting an S7 automation system	55
6.3	Transferring authorizations	56
6.4	Networking via Industrial Ethernet	56
6.5	PROFINET	57
7	Commissioning	59
7.1	Requirements for commissioning.....	59
7.2	Switching on the device	59
7.3	Windows XP, Windows 7 Security Center	60
7.4	Setting up the Microsoft Windows operating system	61
7.5	Windows XP and Windows Embedded Standard 2009.....	61
7.5.1	Touch Panel set-up	63
7.5.2	Key Panel adjustment	65
7.6	Windows 7 (32 and 64-bit)	65
7.6.1	Installation software	65
7.7	BIOS settings	67
7.8	USB	67
7.9	Notes on operation.....	68
7.9.1	DVD burner	68
7.9.2	2HDD system (optional).....	69
7.9.3	RAID1 system (optional).....	70
7.9.4	Replacing a defective drive in the RAID system.....	72
7.9.5	Compact Flash card (optional).....	75
8	Operation and configuration.....	77
8.1	Operator Controls.....	77
8.2	Normal operation.....	79
8.2.1	Switching on the device	79
8.2.2	Logging on to the operating system using the on-screen keyboard	80
8.2.3	Switching off the device	81
8.3	Additional drivers and applications	81
8.3.1	Standard calibration procedure.....	82
8.3.2	Activate touch functionality.....	83
8.3.3	Extended Touch touch functionality	84
8.3.4	Deactivate touch functionality	85
8.3.5	KeyTools (for key panel devices).....	86
8.3.6	On-screen keyboard (for touch panel device).....	86
8.3.7	Panel PC Tools for Windows XP and Windows Embedded Standard 2009	87

8.3.8	Panel PC Tools for Windows 7	88
8.3.8.1	SetBrightness.....	88
8.3.8.2	BbcScreenSaver	92
8.3.9	CheckLanguageID	94
8.3.10	Multilingual settings for the operating system.....	95
8.3.11	USB keyboard controller	95
9	Operation.....	97
9.1	Status displays	97
9.2	Device with key panel	98
9.2.1	Safety	98
9.2.2	Overview	99
9.2.3	Keys	100
9.2.3.1	Control keys	100
9.2.3.2	Alphanumeric and numeric keys.....	101
9.2.3.3	Cursor keys.....	102
9.2.4	External keyboards	103
9.2.5	Labelling function keys and softkeys	103
9.2.6	Using the integrated mouse	105
9.3	Device with touch panel	105
9.3.1	Operating a touch panel.....	105
10	Functions.....	107
10.1	Introduction	107
10.2	Temperature monitoring.....	108
10.3	Watchdog (WD).....	108
10.4	Fan monitoring	109
10.5	Status display.....	110
10.6	SRAM buffer memory	110
10.7	Battery monitoring.....	111
10.8	Active Management Technology (AMT)	111
11	Service and maintenance	113
11.1	Maintenance.....	113
11.2	Maintenance and care of devices with stainless steel front.....	114
11.3	Chemical resistance of stainless steel fronts.....	116
11.4	Handling of stainless steel surfaces	116
11.5	Spare parts.....	118
11.6	Separating the control unit from the computer unit.....	119
11.7	Expansion and parameter assignment	121
11.7.1	Opening the Device	121
11.7.2	Memory expansion.....	123
11.7.2.1	Removing/Installing Memory Module.....	123
11.7.3	Installing PCI/PCIe cards	125
11.7.3.1	Notes on the modules	125

11.7.3.2	Installing / removing expansion modules	125
11.7.4	Installing drives	127
11.7.4.1	Options of installing disk drives	127
11.7.4.2	Installing/removing a drive bay module.....	128
11.7.4.3	Removing / installing an optical drive.....	129
11.7.4.4	Installing / removing hard disks.....	130
11.7.4.5	Removing/installing an SSD drive.....	131
11.7.5	Installing/removing an on-board Compact Flash card	132
11.7.6	Installing/removing an additional Compact Flash card	135
11.8	Removing and installing hardware components	137
11.8.1	Repairs.....	137
11.8.2	Preventive maintenance.....	138
11.8.3	Replacing the Backup Battery.....	138
11.8.4	Removing/Installing the Power Supply	141
11.8.5	Installing / removing the bus board	142
11.8.6	Installing / removing the motherboard.....	143
11.8.7	Installing / removing the equipment fan	145
11.8.8	Installing / removing the power supply fan.....	146
11.8.9	Processor replacement	147
11.9	Reinstalling the software	148
11.9.1	General installation procedure	148
11.9.2	Restoring the delivery state.....	148
11.9.3	Installing Windows	150
11.9.3.1	Installing Windows	150
11.9.3.2	Installing Windows XP.....	150
11.9.3.3	Installation of Windows 7	152
11.9.4	Setting up the language selection by means of the Multilanguage User Interface (MUI).....	153
11.9.5	Recovery of Windows 7	154
11.9.6	Installing drivers and software	158
11.9.7	Installing the Intel RAID controller software	158
11.9.8	Installing the optional burner or DVD software	158
11.9.9	Update installation.....	159
11.9.9.1	Updating the operating system	159
11.9.9.2	Installing or updating application programs and drivers	159
11.9.10	Data backup / subsequent modification of partitions	160
11.9.10.1	Hardware supported	160
11.9.10.2	Creating an image.....	160
11.9.10.3	Modifying the partitions	160
11.9.11	CP 1616 onboard	161
11.10	Installing the RAID Controller software	161
11.11	BIOS update.....	161
11.12	BIOS Recovery	162
12	Alarm, error, and system messages	163
12.1	Boot error messages.....	163
12.2	Introduction to the BIOS beep codes	164
12.3	BIOS beep codes	164

13	Troubleshooting/FAQs	171
13.1	General problems	171
13.2	Problems when Using Modules of Third-party Manufacturers.....	173
13.3	Display a temperature error by means of the DiagBase application	173
14	Technical data	175
14.1	General specifications.....	175
14.2	Ports and status displays	180
14.3	Current/power requirements of the device.....	181
14.4	AC voltage supply	181
14.5	DC power supply.....	183
14.6	Keyboard table	184
15	Dimensional drawings	191
15.1	Dimension drawing IPC	191
15.2	Dimensional drawings for the installation of expansion modules	193
16	Detailed descriptions	195
16.1	Motherboard.....	195
16.1.1	Structure and functions of the motherboard	195
16.1.2	Technical features of the motherboard	196
16.1.3	Position of the interfaces on the motherboard	198
16.1.4	External ports	199
16.1.5	Internal interfaces	204
16.1.6	Front ports.....	206
16.2	Bus board.....	210
16.2.1	Layout and principle of operation.....	210
16.2.2	PCI slot pin assignment	211
16.2.3	Pin assignment 12 V power supply connection for WinAC module.....	212
16.2.4	PCI Express slot x16 pin assignment	213
16.3	System resources	215
16.3.1	Currently allocated system resources.....	215
16.3.2	System resources used by the BIOS/DOS	215
16.3.2.1	I/O address allocation	216
16.3.2.2	Interrupt Assignments	218
16.3.2.3	Exclusive PCI hardware interrupt.....	219
16.3.2.4	Memory address assignments.....	220
16.3.2.5	Addresses used by SRAM	221
16.3.2.6	Accessing addresses of LEDs, watchdog and battery status.....	221
16.4	BIOS-Setup	221
16.4.1	Overview	221
16.4.2	Starting BIOS Setup.....	222
16.4.3	BIOS Setup menus	223
16.4.4	Main menu	225
16.4.5	Advanced menu	226
16.4.6	"Advanced, Active Management Technology Support" menu	233

16.4.7	Security menu	237
16.4.8	Power menu	238
16.4.9	Boot Menu	239
16.4.10	Version Menu	242
16.4.11	Exit menu	243
16.4.12	BIOS Setup default settings	244
16.5	Active Management Technology (AMT).....	248
16.5.1	AMT basics.....	248
16.5.2	Enabling AMT, basic configuration	249
16.5.3	Advanced settings	250
16.5.4	Resetting with Un-configure	250
16.5.5	Determining the network address	251
16.5.6	Forcing user consent.....	251
16.6	Communications processor CP 1616 onboard	252
16.6.1	Introduction	252
16.6.1.1	Properties	252
16.6.1.2	Network connections.....	252
16.6.1.3	Typical Communication Partners	253
16.6.2	Firmware loader	254
16.6.2.1	Loading firmware.....	256
16.6.3	Further actions in STEP 7/NCM PC.....	258
A	Appendix.....	259
A.1	Guidelines and declarations.....	259
A.2	Standards, certificates and approvals	260
A.3	Service and support	264
B	List of abbreviations.....	265
B.1	Abbreviations	265
	Glossary	271
	Index.....	277

Safety

1

1.1 Safety guidelines

 WARNING
Emergencies In the event of a device fault, interrupt the power supply immediately. Inform the customer service personnel responsible. Malfunctions can occur when the operator controls or power cable are damaged or when liquids or foreign objects penetrate the device.

 WARNING
Following the results of a risk analysis, additional protection equipment on the machine or the system is necessary to avoid endangering persons. With this, especially the programming, configuration and wiring of the inserted I/O modules have to be executed, in accordance with the safety performance (SIL, PL or Cat.) identified by the necessary risk analysis. The intended use of the device has to be ensured. The proper use of the device has to be verified with a function test on the system. This test can detect programming, configuration and wiring errors. The test results have to be documented and, if necessary, entered into the relevant documents that verify safety.

Note

This device corresponds to the regulations of the EU low-voltage directive and the GPSG, verified by conformity with national and international standards (DIN EN, IEC) by a UL approval (cULuc). Please comply with all the information in these operating instructions when assembling the device.

Electrical connection

 WARNING
Disconnect the device from the mains before every intervention. Do not touch power lines or data transmission lines during electrical storms and do not connect any cables.

System expansions

Only install system expansion devices designed for this device. If you install other expansions, you may damage the system or violate the safety requirements and regulations for radio frequency interference suppression. Contact your technical support team or where you purchased your PC to find out which system expansion devices may safely be installed.

NOTICE

If you install or exchange system expansions and damage your device, the warranty becomes void.

High frequency radiation

NOTICE

Unintentional operating situations

High frequency radiation, from cell phones for example, can cause unintentional operating situations under some circumstances. Further information is available in the section "EMC requirements" of the "Technical data" chapter.
--

Handling and disposal of lithium batteries

 WARNING
--

Danger of explosion and the release of harmful substances!

Do not throw lithium batteries into fire, do not solder onto the cell body, do not open, do not short circuit, do not reverse pole, do not heat above 100 °C, dispose of according to regulations, and protect from direct sunlight, moisture and condensation.

Replace lithium batteries with the same brand or a brand recommended by the manufacturer.

Dispose of used lithium batteries as hazardous waste, individually, in accordance with the local regulations.

Repairs

Only authorized personnel are permitted to repair the device.

 WARNING
--

Unauthorized opening of and improper repairs to the device may result in substantial damage to equipment or risk of personal injury to the user.
--

1.2 General Information

Overview

NOTICE
The device must only be operated in closed rooms. Failure to comply nullifies the warranty.

Operate the device only in accordance with the ambient conditions specified in the technical specifications. Protect the device against dust, moisture and heat. Do not place the device in direct sunlight.

Transport

Unpack the device at its installation location. Transport the device only in the original packaging. Do not transport the device when it is mounted.

Note

Adhere to these stipulations each time the device is transported, otherwise the guarantee is void.

NOTICE
Condensation When transporting the device at low temperatures, ensure that no moisture gets on or into the device. This also applies if the device is subjected to extreme changes in temperature.
Commissioning Allow the device to slowly adjust to room temperature before commissioning the device. Do not place the device near heat radiation. If moisture condensation occurs, wait at least 12 hours before you switch on the device.
Vibration Optical drives are sensitive to vibration. Inadmissible vibration during operation may result in loss of data or damage to the drive or data medium. Before transporting the device, wait at least 20 seconds to allow the drive to stop completely.

Tools & downloads

Please check regularly if updates and hotfixes are available for download to your device.

Downloads are available on the Internet at "Support". <http://www.siemens.com/asis> (https://www.automation.siemens.com/Industrial-PC/html_76/support/asis.htm). Under "ASIS", click on "Drivers and Bios Updates" and select the device family. Alternatively, click on "Downloads" at "Tools & Downloads". You can use "Search terms" to search for the required download.

Optical drive

Note

An optical drive should only be operated in a mechanically undisturbed environment without vibrations and shock and at a temperature of < 40°C.

Safety-relevant applications

 WARNING
Maloperation
Do not perform safety-relevant functions of the user software with the touch screen.

Resistance to chemicals

NOTICE
Adhere to the information regarding chemical resistance of the panel front. For additional information, refer to the Internet at "Technical Support (http://www.siemens.de/automation/csi_en_WW)". Enter the article ID 22591016 in the "Search for product information". The available article is displayed.

Sources of light

Note

Position the screen so that it is not subject to direct sunlight or other strong sources of light.

Defective pixels in the display

At present, the manufacturing process of modern displays does not guarantee that all pixels of the display will be perfect. A small number of defective pixels in the display is therefore unavoidable. This does not present a functional problem as long as the defective pixels are not bunched in one location.

Further information is available in the section "General technical data" of the "Technical data" chapter.

Backlighting

The brightness of the backlighting decreases incrementally during its operational life. In order to not shorten the operational lifetime of the backlighting unnecessarily, activate the backlighting reduction.

Burn-in effect on TFT displays

An image may occasionally leave a burn-in effect in the background if it appears too long on the screen. This burn-in effect will automatically disappear after a certain amount of time if, for example, the screen saver is activated. The longer the same image is displayed on the screen, the longer it will take for the burn-in effect to disappear.

Screen saver

Generally, you should always activate the screen saver. If a screen saver is activated, please observe the following:

- The liquid crystals in screen savers which actuate active black when the backlighting is on renew themselves. Pay attention to the length of time the backlighting is activated.
- Screen savers that reduce the backlighting extend the life span of the backlighting.
- Screen savers that switch off the backlighting shorten the life span of the backlighting.

Consider the following carefully:

- Screen saver
- Switch off the backlighting regularly
- Permanent display of the customer application

1.3 ESD directives

What does ESD mean?

Almost all electronic modules are equipped with highly integrated components and elements in MOS technology. For technological reasons, these electronic components are very sensitive to overvoltages and, consequently, to electrostatic discharge. These components are therefore marked as follows:

- **ESD: Electrostatically Sensitive Devices**
- **ESD:** Internationally recognized marking for components and modules susceptible to electrostatic discharge

The following symbols on switch cabinets, module carriers or packaging indicate their susceptibility to electrostatic discharge:



ESD components are destroyed by voltage and energy far below the limits of human perception. Voltages of this kind occur as soon as a device or an assembly is touched by a person who is not electrostatically discharged. ESD components which were subject to such voltage are usually not recognized immediately as being defective, because the malfunction does not occur until after a longer period of operation.

Note

More information is located on the rating label. The rating label is described in the chapter "Planning use."

Precautions against electrostatic discharge

Most plastics can be charged easily. Therefore, keep plastics away from ESD components!

When working with electrostatically sensitive components, make sure that the person, the workstation and the packaging are properly grounded. Conduct the electrostatic charge away from your body by touching the mounting plate for the interfaces, for example.

Handling ESD modules

As a rule: Only touch ESD components if unavoidable due to necessary tasks.

Only touch the components when the following holds true:

- You are permanently grounded by means of an ESD armband.
- You are wearing ESD shoes or ESD shoes grounding protective strips in connection with ESD floors.

Before you touch an electronic assembly, your body must be discharged. Touch a conductive object immediately beforehand, e.g. a bare metal part of a switch cabinet or the water pipe.

Do not allow chargeable, highly insulated materials, e.g. plastic films, insulating tabletops, synthetic clothing fibers, to come into contact with ESD components.

Place ESD components only on conductive surfaces (work surfaces with ESD surface, conductive ESD foam, ESD packing bag, ESD transport container).

Do not expose ESD components to visual display units, monitors or televisions. Maintain a distance of at least 10 cm to screens.

Handle flat components only by their edges. Do not touch component connectors or conductors. This prevents charges from reaching and damaging sensitive components.

Measuring and modifying ESD components

Measure the ESD component under the following conditions only:

- The measuring device is grounded with a protective conductor, for example.
- The probe on the potential-free measuring device has been discharged, e.g. by touching the bare metal of a part of the switch cabinet.
- Your body is discharged. To do so, touch a grounded metallic object.

Solder only with grounded soldering irons.

Shipping ESD modules

Always store or ship ESD components in conductive packaging, e.g. metallized plastic boxes or metal cans. Leave the components and parts in their packaging until installation.

If the packaging is not conductive, wrap the ESD component in a conductive material, e.g. rubber foam, ESD bag, household aluminum foil, or paper, before packing. Do not wrap the ESD component in plastic bags or plastic film.

In ESD components containing installed batteries, make sure that the conductive packaging does not touch the battery connectors or short circuit. Insulate the connectors with suitable material.

Description

2.1 Design of IPC677C

Design

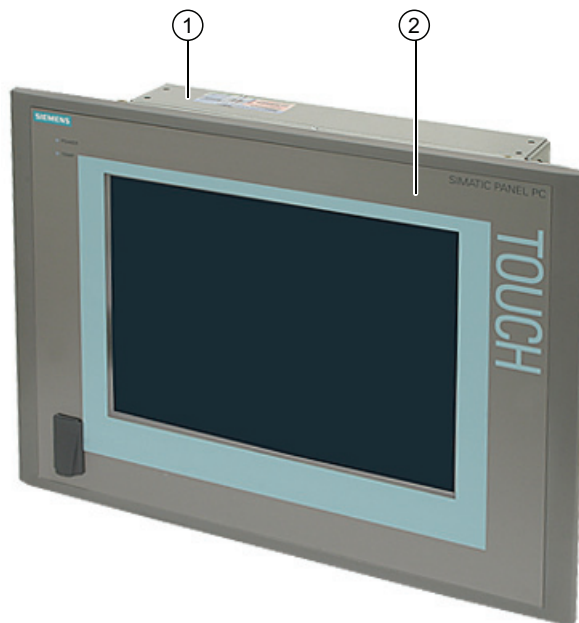

- (1) Computer unit
- (2) Control unit

Figure 2-1 IPC677C

Product Brief

The device is available with different control units which are distinguished by the size of the display and by the key or touch panel.

Key panel variants

- Color display with backlighting:
 - 12" TFT technology with 800 x 600 resolution
 - 15" TFT technology with 1024 x 768 resolution
- Membrane keyboard with alphanumeric keys, numeric keys, cursor keys and control keys
- Function keys and softkeys
- Integrated mouse
- LEDs for power supply, temperature, softkeys, <Shift> and <ACK> function keys and buttons
- Front-mounted USB 2.0 port for connecting external I/O devices. All fronts are also available without USB port accessible from the front

Key panel variants

- Color display with backlighting
 - 12" TFT technology; 800 x 600 resolution
 - 15" TFT technology; 1024 x 768 resolution
 - 15" TFT technology; resolution 1024 x 768 pixels, with stainless steel front INOX
 - 19" TFT technology; 1280 x 1024 resolution
- LEDs for power supply and temperature
- Front-mounted USB 2.0 port for connecting external I/O devices (except INOX). All fronts are also available without USB port accessible from the front.

Refer to the "Specifications" section for more information.

2.2 Features

Basic data	
Design	Panel mounting device, box
Processor	<ul style="list-style-type: none"> • Intel® Celeron™ P4505 mobile processor 1.86 GHz, 2 MB second-level cache, 2 cores / 2 threads, virtualization • Intel® Core™ i3-330E mobile processor 2.13 GHz, 3 MB second-level cache, 2 cores / 4 threads, hyperthreading, virtualization • Intel® Core™ i7-610E mobile processor 2.53 GHz, 4 MB second-level cache, 2 cores / 4 threads, hyperthreading, turbo boost, virtualization, AMT
Chipset	<ul style="list-style-type: none"> • Mobile Intel® QM57 Express Chipset
Main memory	<ul style="list-style-type: none"> • 1 GB SDRAM (DDR3) • Expandable to up to 8 GB SDRAM (DDR3) • ECC, optional
Slots for expansions	<ul style="list-style-type: none"> • 1x PCI 290 mm long and 1x PCI 185 mm long • 1x PCI 290 mm long and 1x PCI Express x16 185 mm long
Graphics	<ul style="list-style-type: none"> • Intel® HD graphics controller, chip set integrated 2-D and 3-D engine, Dynamic Video Memory Technology (uses up to 256 MB RAM) • CRT: Max. 1280x1024 at 100 Hz / 32-bit color depth Max. 1600x1200 at 60 Hz / 32-bit color depth Maximum resolution: 2038x1536 at 75 Hz / 16-bit color depth • LCD via DVI-I: 1600x1200 at 60 Hz / 32-bit color depth
Power supply	<ul style="list-style-type: none"> • 100 - 240 VAC, 190 W; wide range • 24 V DC, 210 W <p>Both with bridging of transient loss of voltage according to NAMUR: max. 20 ms.</p> <p>The 24V DC power supply is protected against reversed polarity.</p>
Drives and storage media	
Mass storage	<ul style="list-style-type: none"> • 1 x 3.5" hard disk or • 2 x 2.5" hard disk or RAID1 system <p>Capacity see order forms</p>
DVD drive	DVD burner
Flash memory	<ul style="list-style-type: none"> • Slot for Compact Flash card • 1 x solid-state drive

Basic data	
Interfaces	
Ethernet	2x 10/100/1000 Mbps (RJ45)
PROFIBUS/MPI	12 Mbps (isolated potential, compatible to CP 5611), optional
PROFINET	10/100 Mbps (CP 1616 onboard), three RJ45; optional
USB	<ul style="list-style-type: none"> External: 4 x USB 2.0 high current (max. 2 can be simultaneously operated as high current) Internal: 1 x USB 2.0 high current + 1x USB 2.0 low current on a 10-pin male connector, 1 x USB 2.0 low current for internal USB stick/dongle Front panel port: 1 x USB 1.1, 1 x USB 2.0, both high current
COM	Serial V.24 port
Monitor	1x DVI-I (VGA monitors can be connected with a DVI/VGA adapter that is available as an accessory)

Monitoring and safety functions	
Temperature	<ul style="list-style-type: none"> When permitted temperature range is exceeded Warning messages from application program that can be analyzed: local (DiagBase), via LAN (DiagMonitor, optionally available)
Fans	<ul style="list-style-type: none"> Failure of device and power supply fans Warning messages from application program that can be analyzed: local (DiagBase), via LAN (DiagMonitor, optionally available)
Watchdog	<ul style="list-style-type: none"> Monitoring function for program execution Restart can be parameterized in the event of a fault Warning messages from application program that can be analyzed: local (DiagBase), via LAN (DiagMonitor, optionally available)
LED display	2 LEDs for displaying system status that can be programmed by the user ¹
Transient voltage interruption	Up to 20 ms buffer time with full load
Buffer memory (optional)	2 MB battery-buffered SRAM ^{1) 2)}

¹⁾ The DMAPi programming interface is available to activate the LEDs and the SRAM ²⁾. You will find this in the folder "C:\Program Files\Siemens\DiagnosticManagement\DMAPI".

²⁾ only with devices with PROFIBUS or PROFINET interface

Optional accessories (Box PC only)	
Vertical mounting brackets	For space-saving installation of the Box PC in the control cabinet, ports facing up/down or forward
Graphics adapter	
<ul style="list-style-type: none"> • DVI-I to VGA adapter 	Used to connect a monitor with a VGA port to the Box PC
<ul style="list-style-type: none"> • DVI-I to VGA and DVI Y-adapter (dual display) 	Used to connect two monitors to the Box PC

Optional expansions	
SIMATIC PC DiagMonitor software ≥ V 4.2	Software tool for monitoring local and remote SIMATIC PCs: <ul style="list-style-type: none"> • Watchdog • Temperature • Fan speed • Hard disk monitoring (SMART) Communication: <ul style="list-style-type: none"> • Ethernet interface (SNMP protocol) • OPC for integration in SIMATIC software • Client server architecture • Layout of log files
SIMATIC IPC Image & Partition Creator	Software tool for local data backup and partitioning of hard disks

Software	
Operating systems	<ul style="list-style-type: none"> • Without • Preinstalled / activated / available on the Restore CD/DVD: <ul style="list-style-type: none"> – Windows Embedded Standard 2009 English on CompactFlash – Windows XP Professional MUI ¹⁾ – Windows 7 Ultimate MUI ¹⁾ 32/64-bit

¹⁾ MUI: Multilanguage User Interface; 6 languages (English, German, French, Spanish, Italian)

2.3 Accessories of IPC677C

Accessories	Comment	Order No.
Film for protecting the touch panel against dirt and scratches for the 12" touch panel version for the 15" touch panel version for the 19" touch panel version		6AV7671-2BA00-0AA0 6AV7671-4BA00-0AA0 6AV7672-1CE00-0AA0
Film for labeling the function keys (slide-in labels)	You can find print templates for the slide-in labels are available on the "Documentation and Drivers" CD.	6AV7672-0DA00-0AA0
Touch pen		6AV7672-1JB00-0AA0
Power supply cords for other countries: Europe Italy Switzerland United Kingdom USA	A power supply cord as per your order is included in the scope of delivery of the device.	6ES7900-1AA00-0XA0 6ES7900-1EA00-0XA0 6ES7900-1CA00-0XA0 6ES7900-1BA00-0XA0 6ES7900-1DA00-0XA0
DVI / VGA adapter		6ES7648-3AB00-0XA0
External USB disk drive	1 m connecting cable	6FC5235-0AA05-1AA1
PCI multi-I/O module	Provides one parallel and one serial port	6ES7648-2CA00-0AA0
SIMATIC PC Image Creator software	Software tool for saving data locally	6ES7648-6AA03-0YX0
Module for DDR2 RAM, DIMM expansion	512 MB 1 GB 2 GB	6ES7648-2AG30-0HA0 6ES7648-2AG40-0HA0 6ES7648-2AG50-0HA0
Module for DDR3 RAM, DIMM expansion	1 GB 2 GB 1 GB, ECC 2 GB, ECC	6ES7648-2AH40-0KA0 6ES7648-2AH50-0KA0 6ES7648-2AH40-1KA0 6ES7648-2AH50-1KA0
You can find additional accessories in the catalog or on the Internet at http://www.siemens.com/automation/mall (http://mall.automation.siemens.com).		

Planning the use

3.1 Overview

Introduction

This section describes the first steps after unpackaging, the permitted mounting positions and the fixation. This section describes the necessary considerations for EMC.

Field of application

The Panel PC is an industry-standard PC platform for demanding tasks in the field of PC-based automation. The Panel PC is designed for on-site use on the machine, installed for example in:

- Control cabinet installation
- Swivel arm mounting
- Rack mounting

Note

In the following, the term "switchgear cabinet" also refers to rack, mounting rack, switchboard, operator panel and console. The term "device" represents the Panel PC and its variants.

3.2 Unpacking and checking the delivery

Procedure

1. Please check the packaging material for transport damage upon delivery.
2. If any transport damage is present at the time of delivery, lodge a complaint at the shipping company in charge. Have the shipper confirm the transport damage immediately.
3. Unpack the device.

NOTICE
Do not lie the device on its back. This will avoid any damage to an optical drive which may be present. Lie the front side on a soft surface to avoid damaging the front panel USB port.

4. Keep the packaging material in case you have to transport the unit again.

Note

The packaging protects the device during transport and storage. Therefore, never dispose of the original packaging material!

5. Please keep the enclosed documentation in a safe place. You will need the documentation when you start up the device for the first time.
6. Check the package contents for completeness and any visible transport damage. Check for completeness using the enclosed scope of delivery list.
7. Should the contents of the package be incomplete or damaged, please inform the responsible supply service immediately and fax us the enclosed form "SIMATIC IPC/PG quality control report".

 WARNING
Make sure that a damaged device is not installed nor put into operation.

8. Note the identification information as described in the chapter "Identification data of the device".

3.3 Device identification data

The device can be clearly identified with the help of this identification data in case of repairs or theft.

Enter the following data in the table below:

- Serial number: The serial number (S VP...) is found on the rating plate.

Rating plate

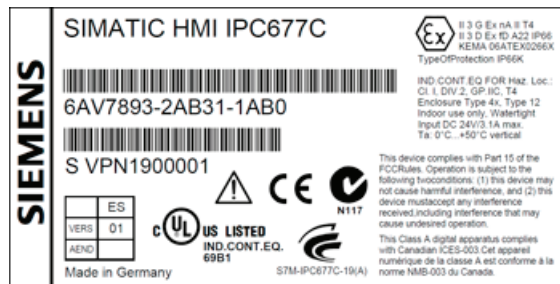

- Order number of the device
- Ethernet addresses: The Ethernet addresses of the device can be viewed in the BIOS Setup (F2) under "Main > Hardware Options > Onboard Ethernet Address".
- Microsoft Windows "Product Key" on the "Certificate of Authenticity" (COA). The COA label is bonded to the device. The Product Key is always required to reinstall the operating system.

COA label

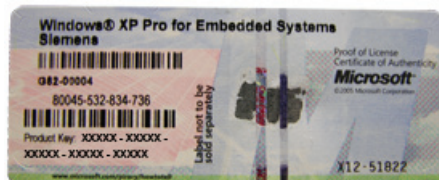

Serial number:	S VP ...
Order No.	6AV78.....
Microsoft Windows Product Key	
Ethernet address 1	
Ethernet address 2	

3.4 Mounting positions and fastening

3.4.1 Installation guidelines

Before installing the device, read the following general notes relating to installation.

 WARNING
Danger, high voltage Isolate the power supply to the switchgear cabinet before opening it. Ensure that the power to the switchgear cabinet cannot be turned on accidentally.

NOTICE
Operation only in closed rooms The device is approved for operation in closed rooms only.

- Ensure that the protective contact socket of the building installation is easily accessible and that there is a mains disconnect switch in switchgear cabinet installations.
- Position the screen in an ergonomic position favorable to the user. Choose a suitable installation height.
- Position the screen so that it is not subject to direct sunlight or other strong sources of light.
- Optical drives are susceptible to shock. Shocks during operation can lead to the loss of data or damage to the drive or data carrier. Optical drives are not only suitable for continuous operation.
- Applies to devices which are installed in swivel arm housings: Avoid rapid or jerky movements of the swivel arm during operation. The ensuing forces could lead to possible irreversible damage to the hard disk.
The stops of the swivel arm must be damped in order to avoid a harsh impact to the Panel PC generating a mechanical shock effect to the device.
- Applies to devices which are installed in cabinet doors: Prevent the doors being slammed shut. The ensuing forces could lead to possible irreversible damage of the hard disk.
- The device has to be installed in the mounting cutout of a housing that fulfills the requirements of IEC/EN/DIN EN 60950-1, Chapters 4.6 and 4.7.3.

- The computer unit with DC power supply does not fulfill the requirements according to IEC/EN/DIN EN 60950-1 in the power supply unit area. The device must therefore be installed in such a way that it is part of an operating area with restricted access (for example, a lockable control cabinet, control panel or server room).

Note

When using the device in the area of Industrial Control Equipment (UL 508), ensure that it is classified as "Open Type". A mandatory requirement for approval or operation according to UL 508 is therefore that the device be installed in the mounting cutout of a housing certified for UL 508.

- Provide adequate volume in the switchgear cabinet for air circulation and heat transport. Keep at least 10 cm distance between the device and switchgear cabinet.
- Make sure that the maximum air intake temperature is not exceeded (refer to the "Technical specifications" chapter). The maximum air intake temperature must be accounted for especially when sizing closed switchgear cabinets.
- The minimum distance between the device and the housing is 10 cm on the air output side at the fan.
- Position the device in such a way that the air vents of the housing are not covered up following mounting.
- Ensure there is enough free space in the switchgear cabinet to allow the sheet metal cover to be removed. You will otherwise have to remove the device from the switchgear cabinet or swivel arm when replacing memory or the battery.
- Equip the switchgear cabinet with struts for stabilizing the mounting cut-out. Install struts where necessary.
- Avoid extreme environmental operating conditions. Protect your device against dust, moisture and heat.
- The device is designed for use in normal industrial environments to IEC 60721-3-3 (pollutant class 3C2 for chemical influence, 3S2 for sand and dust). The device may not be operated in severe environments which are subject to caustic vapors or gases without taking additional protective measures (such as the provision of clean air).
- Install the device in such a way that it poses no danger, e.g. by falling over (see Chapter "Technical Specifications").
- During assembly, please comply with the approved installation positions.

Note

If you mount the device in an impermissible installation position or you do not observe the environmental conditions (see Chapter "Specifications"), you endanger the product safety provided by the UL-approval and compliance with the low-voltage directive (via EN 60950-1). In additional, the functionality of the device is no longer guaranteed.

Additional information is available in the chapter "Dimensional drawings (Page 191)".

3.4.2 Installation information stainless steel front

Before you install the device, read the additional installation guidelines below:

- Make sure that you can access the device from the rear.
- The mounting cut-out should be deburred.
- When operating the device in a switch cabinet, ensure compliance with permitted ambient conditions and, in particular, that permitted ambient temperatures are not exceeded. Make allowances for the fact that the thermal conductivity of control cabinets made of stainless steel is not as good as that of an aluminum cabinet, for example.
- Check the seal on the device. Always install the device with this seal.
- Always use the included clamping frame and clamps to mount the device.

3.4.3 Permitted mounting positions

Approval

Only certain mounting positions are approved for the device.

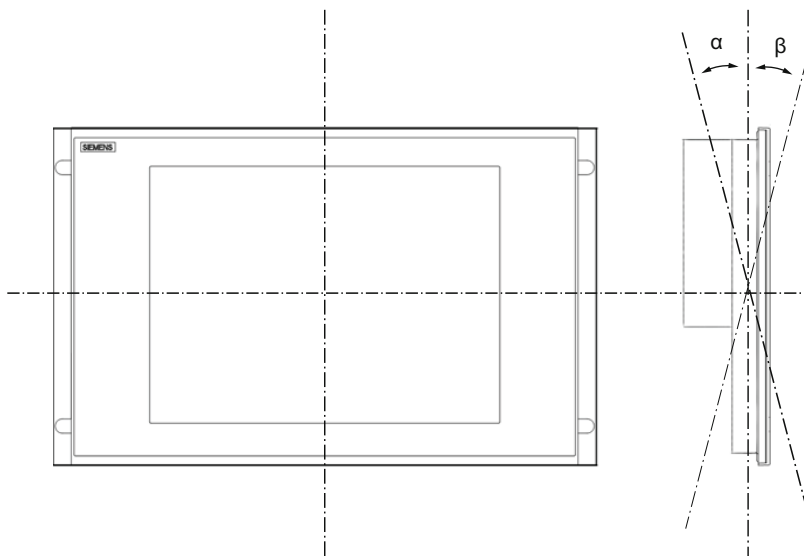

Figure 3-1 Mounting position

Table 3- 1 Permissible deviations from the vertical mounting position

TFT	Temperature	Angle A	Angle B
12"; 15"	up to 50 °C ¹⁾	20°	20°
19"	up to 45 °C	20°	20°

¹⁾ With a total loading of slots amounting to 15 W

Note

When mounting the device at an angle, note the following.

- Do not subject the device to mechanical stress.
 - Operation of a DVD drive is not permitted.
-

3.4.4 Type of fixation

The computer unit is secured in the mounting cut-out either with clamps or screws.

Note

Securing with screws is not possible with the 12" touch screen variant.

Select the type of fixation suitable to your requirements for the degree of protection (see section "Protection against dust and water") .

3.4.5 Stainless steel front type of fixation

Type of fixation

The device is fastened with the included clamps. Additional fastening bore holes or threaded bolts are not required for the control panel.

Degree of protection

NOTICE
Degree of protection IP66 is only ensured if the seal of the device is correctly positioned and evenly pressed on the control panel. Refer to the "Installation" section for more information.

3.4.6 Protection against dust and water

With the relevant installation, the device is protected on the front against the ingress of dust and water. The "degree of protection" is in accordance with IEC 60529: On the front, the device has degree of protection IP65, the rear of the operator section and the computer unit have degree of protection IP20.

NOTICE
Ensure that the material strength at the mounting cut-out is a minimum of 2 mm and a maximum of 6 mm. Please follow the specifications for the dimensions in the "Mounting cut-out" section.
The degrees of protection IP65, IP54 and Enclosure Type 4, are only guaranteed when the following conditions are met:
The surface plane deviation of the mounting cut-out in relation to the external dimensions of the control unit amounts to ≤ 0.5 mm when the control unit is mounted.

Degree of protection IP65 and Enclosure Type 4

The degrees of protection IP65 and Enclosure Type 4 are only provided for clamp mounting together with a ring seal.

IP54 degree of protection

The IP54 degree of protection is applicable for the following conditions:

	Key panel		Touch panel	
	12"	15"	15"	19"
Screw mounting	X	X	X	-

See also

Industry Mall (<http://mall.automation.siemens.com>)

3.5 Mounting cutout

3.5.1 Preparing the mounting cut-out

The following illustration shows the dimensions for the mounting cut-out.

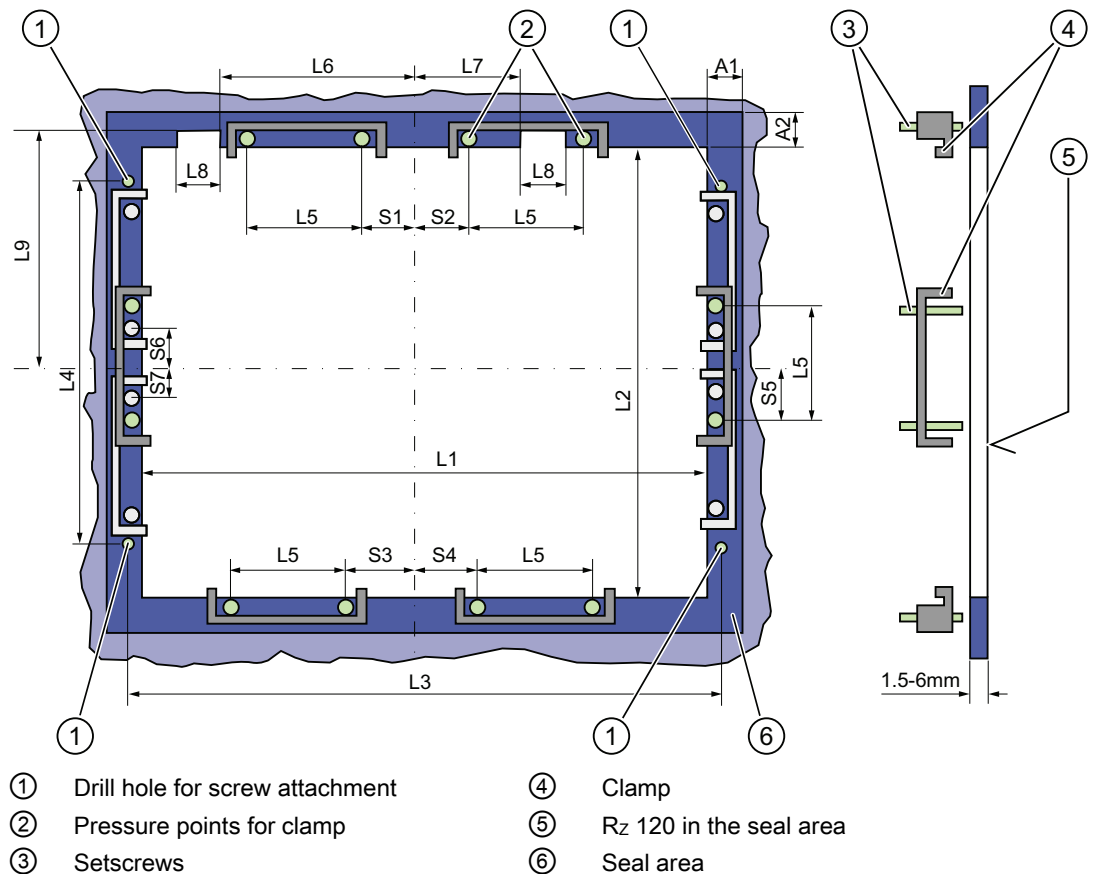

Figure 3-2 Drill holes for the screws and pressure points for the clamp screws

Note

Mounting dimensions can be read from the dimension overview or they can be transferred to the cabinet from the mounting template supplied.

Table 3-2 Dimensions for the mounting cut-out in mm

Control unit	L1	L2	L3 ¹⁾	L4 ¹⁾	L5	L6 ²⁾	L7 ²⁾	L8 ²⁾	L9 ²⁾	A1	A2	S1	S2 S3 S4	S5 ³⁾	S6 ³⁾ S7 ³⁾
Tolerance	±1	+1	±0.2	±0.2	±0.5	±0.5	±0.5	±0.5	+1	±1	±1	±1	±1	±1	±1
Key panel 12" TFT	450	290	465	235	112	—	—	—	—	16	10	78	78	56	—
Key panel 15" TFT	450	321	465	279	112	186	135	25	165	16	17	51	51	56	—
Touch panel 12" TFT	368	290	—	—	112	—	—	—	—	16	10	19	35	56	—
Touch panel 15" TFT	450	290	465	235	112	—	—	—	—	16	10	81	81	56	—
Touch panel 15" TFT INOX	450	290	465	235	112	—	—	—	—	16	10	—	—	—	—
Touch panel 19" TFT	450	380	465	235	112	—	—	—	—	16	10	46	46	—	46

- 1) M6 thread or drill holes with a diameter of 7 mm
- 2) Cut-outs for the shafts of the insert strips are only necessary for 15" key panels.
- 3) Two clamps necessary for vertically securing clamps only for 19" touch panel fronts.

Preparing the mounting cut-out

Steps for preparing the mounting cut-out	
1	Select a location suitable for mounting, taking into account the mounting position.
2	On the basis of the dimensions, check whether the required screw and pressure points on the rear and the seal area are easily accessible after the completion of the mounting cut-out. Otherwise the mounting cut-out is useless.
3	Complete the mounting cut-out in accordance with the dimensions.

3.5.2 Mounting depth of the device

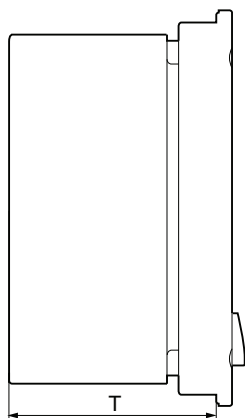

Panel PC with operator control units	Depth D
Key panel with 12" TFT	105 mm
Key panel with 15" TFT	124 mm
Touch panel with 12" TFT	123 mm
Touch panel with 15" TFT	121 mm
Touch panel with 15" TFT INOX	126 mm
Touch panel with 19" TFT	130 mm

Note

Additional mounting depth with optical drive

The installation depth increases by 21 mm when an optical drive is installed in the device.

Mounting

4.1 Securing the device with clamps

Requirement

Accessories	Display		
	12"	15"	19"
Clamp	6 x	6 x	8 x
	The clamps are provided with the control unit.		
Tool	2.5 mm hexagonal spanner		

Procedure



Figure 4-1 Clamp assembly

1. Disconnect the device from the power supply.
2. Working from the front, insert the device into the 19" rack on the swivel arm or in the mounting cut-out.
3. Fasten the control unit from the rear using the clamps.
4. Tighten the setscrews to a torque of 0.4 - 0.5 Nm.

IP65 degree of protection

The plant builder is responsible for the correct installation of the device.

The degree of protection IP65 is only guaranteed for the front of the device if the ring seal is properly applied with the correct size of cutout, the unit has been clamped in place, and the instructions below are observed.

Note

Control cabinet installation: Material strength at the mounting cut-out

Ensure that the material strength at the mounting cut-out is a minimum of 2 mm and a maximum of 6 mm. Please follow the specifications for the dimensions in the "Preparing the mounting cut-out" section.

The degrees of protection are only guaranteed when the following is observed:

- The surface plane deviation of the mounting cut-out in relation to the external dimensions of the control unit amounts to ≤ 0.5 mm when the control unit is mounted.

4.2 Securing with screws

Note

Securing with screws is not possible with the 12" touch panel variant.

Drill holes in the control unit

Steps for drilling holes	
1	Drill holes (\varnothing approx. 2.5 mm) from the rear in the four recesses of the control unit. 
2	Drill these holes with a diameter of \varnothing 5.5 mm for M5 and a \varnothing 6.5 mm for M6.
3	Deburr the holes from the front of the control unit.

Note

Risk of damage

Ensure that no metal cuttings enter the device when the holes are drilled. Cover the device with film or when drilling, use removal by suction.

Drill holes in the mounting unit

1. Drill the holes at the prepared mounting cut-out according to the information for L3 and L4. (see Chapter "Mounting cut-out")
2. Working from the front, insert the device into the 19" rack on the swivel arm or in the mounting cut-out of the control cabinet.
3. Secure the control unit by inserting suitable screws and nuts.

IP54 degree of protection

The IP54 degree of protection is guaranteed for mounting together with the ring seal.

 CAUTION
--

Observe the panel seal when mounting

Ensure you do not damage the panel seal when mounting the device.

Note

Control cabinet installation: Material strength at the mounting cut-out

Ensure that the material strength at the mounting cut-out is a minimum of 2 mm and a maximum of 6 mm. Please follow the specifications for the dimensions in the "Preparing the mounting cut-out" section.

The degrees of protection are only guaranteed when the following is observed:

- The surface plane deviation of the mounting cut-out in relation to the external dimensions of the control unit amounts to ≤ 0.5 mm when the control unit is mounted.

4.3 Fix the device with stainless steel front using clamps

Introduction

This section describes how to mount the device in a control panel.

NOTICE

Mount the device as intended. This will avoid damage to the device and loss of warranty. Follow the installation instructions.
--

Procedure

1. Ensure that the seal does not become twisted during mounting, otherwise the mounting cut-out may not be correctly sealed.
2. Working from the front, insert the device into the prepared and deburred mounting cut-out. Take the necessary precautions to ensure the device cannot drop out of the control panel before it has been secured in place.

4.3 Fix the device with stainless steel front using clamps

3. Place the clamping frame with the centering bore holes onto the device. Make sure that the flat side of the frame makes contact with the back of the control panel.



Figure 4-2 Clamping frame with seal

4. Insert the fastening hooks (1) of the clamps into the recesses (2) of the device. Make sure that the centering points (4) of the clamps are inserted into the corresponding centering bore holes (3) of the clamping frame.

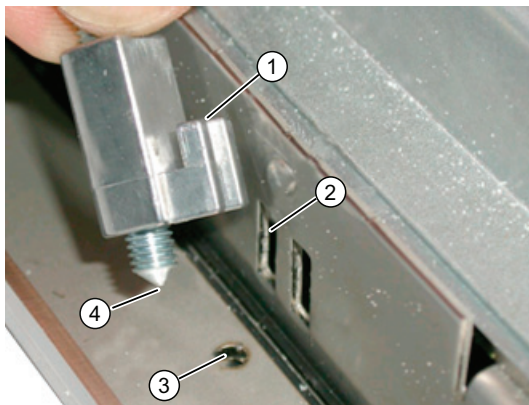

Figure 4-3 Inserting the clamps

5. Tighten the screws of the clamps. Use a hexagonal head torque wrench set to a maximum tightening torque of 0.6 N/m in order to achieve an optimal sealing effect.

NOTICE

Any higher torque may warp the control panel or the switchboard panel. The specified degree of protection is not ensured otherwise.

4.3 Fix the device with stainless steel front using clamps



Figure 4-4 Proper positioning of the clamp

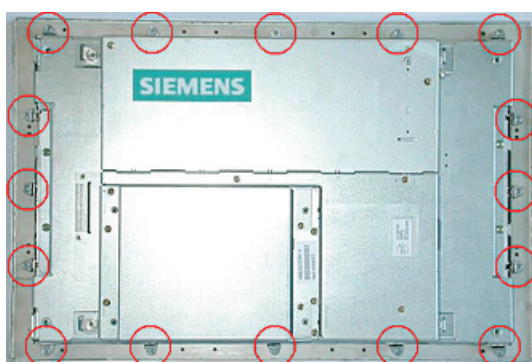

Figure 4-5 Position of the clamps

6. Check the proper seating of the seal on the front side. If it is not seated properly, repeat the installation.

Mounting

4.3 Fix the device with stainless steel front using clamps

Connecting

5.1 Connection elements

Ports

Arrangement of the ports on the front of the device		
Item	Description	Description
①	DVI/VGA	DVI/VGA connection for CRT or LCD monitor with DVI port, VGA via DVI/VGA adapter
②	Compact Flash card	Slot for Compact Flash card
③	COM	Serial V.24 port
④	USB 2.0	4 ports for USB devices (only 2 ports can be simultaneously used as high current)
⑤	ETHERNET	2x RJ 45 Ethernet connection for 10/100/1000 Mbps
⑥	PROFIBUS/MPI	MPI port (RS485, electrically isolated), optional 9-pin D-sub socket (optional product model)

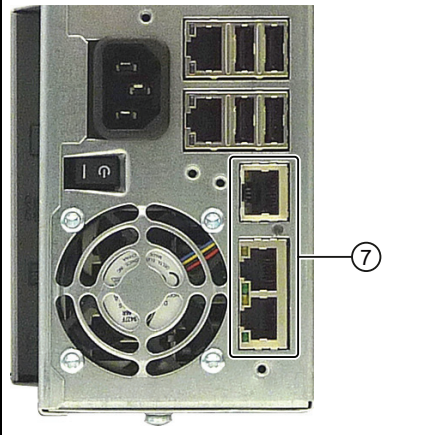
Arrangement of the ports on the front of the device		
	<p>⑦ PROFINET</p>	<p>CP 1616 onboard port, three RJ45 sockets (optional product models)</p>

The ports available on the device can be uniquely identified based on their numbering. This numbering may deviate, however, from the numbering performed by the operating system.

Ports for connecting operator panels / displays

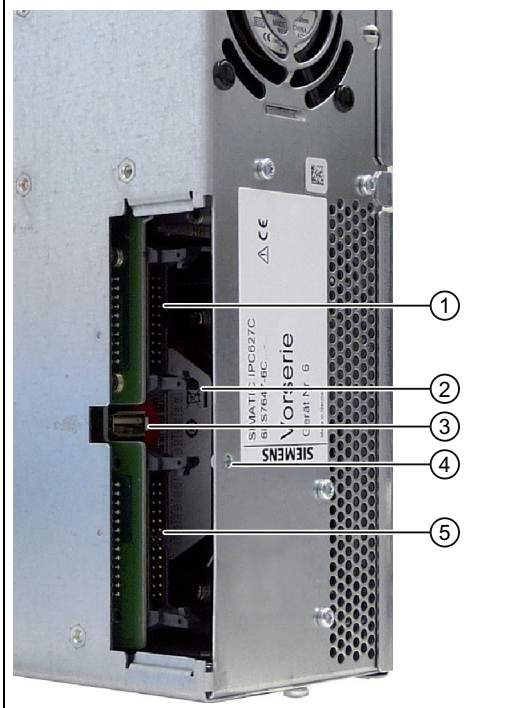
Arrangement of the ports	
	<p>① LVDS display ports for TFT displays up to 1024 x 768 pixels</p>
	<p>② Access to 2nd LVDS display port for TFT displays up to 1280 x 1024</p>
	<p>③ USB 2.0 for front</p>
	<p>④ Retaining screw for the steel cover plate that covers the ports described below.</p>
	<p>⑤ I/O port for connecting front components</p>

AC power supply

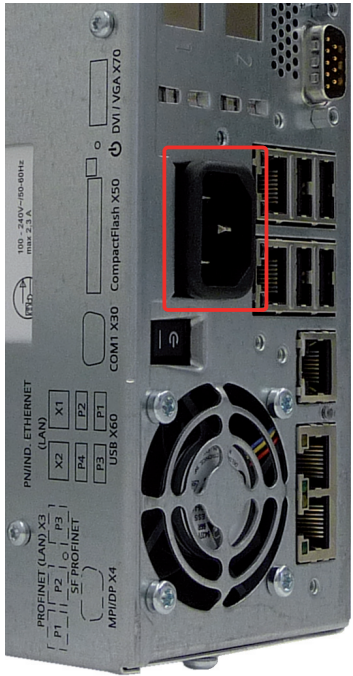
Position of the IEC power connector	Description
	<p>IEC power connector to AC power supply of the device. The maximum permitted power range is 100 V AC to 240 V AC.</p>

DC power supply

Position of the DC power connector	Description
	<p>Plug connector for DC power supply of the device</p> <ul style="list-style-type: none"> ① + (24 V DC) ② - (ground) ③ PE (ground terminal)

5.2 Connecting the 100 - 240 V AC Power Supply

Note before connecting the device

Note

The varying voltage power supply module is designed for operation on 120/230/240 V AC networks. The setting of the voltage range takes place automatically.

 **WARNING**

Thunderstorms

Do not connect or disconnect power and data cables during thunderstorms.

 **WARNING**

Operation only in TN networks

The device is designed for operation in grounded power supply networks (TN networks according to VDE 0100 Part 100, or IEC 60364-1).

Operation on ungrounded or impedance-grounded power networks (IT networks) is prohibited.

 **WARNING**

Rated voltage

The permitted nominal voltage of the device must conform with local mains voltage.

NOTICE

Notes on the power supply network

The mains connector must be disconnected to fully isolate the device from mains. Ensure easy access to this area.

A master mains disconnect switch must be installed if the device is mounted in a switch cabinet.

Make sure that the power outlet or the safety power outlet of the building installation is freely accessible and located as close as possible to the device.

Note

The power supply contains an active PFC (Power Factor Correction) circuit to conform to the EMC guidelines.

Uninterruptible AC power systems (UPS) must supply a sinusoidal output voltage in the normal and buffered mode when used with SIMATIC PCs with an active PFC.

UPS characteristics are described and classified in the standards EN 50091-3 and IEC 62040-3. Devices with sinusoidal output voltage in the normal and buffered mode are identified with the classification "VFI-SS-...." or "VI-SS-....".

Localized information**For countries other than the USA and Canada:****230 V supply voltage**

This device is equipped with a safety-tested power supply cord which may only be connected to a grounded safety power outlet. If you choose not to use this cable, you must use a flexible cable of the following type: Min 18 AWG conductor cross-section and 15-A / 250-V shockproof connector. The cable set must be compliant with the safety regulations and stipulated IDs of the country where the system is to be installed.

For the USA and Canada:

For the United States and Canada, a CSA or UL-listed power supply cord must be used.

The connector must be compliant with NEMA 5-15.

120 V supply voltage

A flexible cable with UL approval and with CSA label which has the following features is to be used: Type SJT with three leads, min. 18 AWG conductor cross-section, max. 4.5 m in length and parallel ground contact connector 15 A, min. 125 V.

240 V supply voltage

A flexible cable with UL approval and with CSA label which has the following features is to be used: Type SJT with three conductors, min. 18 AWG conductor cross-section, max. length 4.5 m, and tandem grounded connector 15 A, min. 250 V.

Connecting

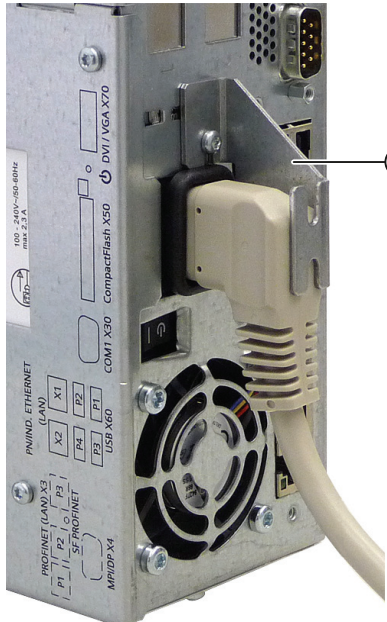
How to connect the device to the 120 V AC / 230 V AC power supply	
<p>1 Ensure that the ON/OFF switch is in "0" position (Off) when you plug in the power cord in order to avoid unintentional startup of the device.</p>	
<p>2 Connect the IEC connector</p>	
<p>3 Connecting the power cord to the power socket</p>	
<p>4 Fasten the cable with the supplied power plug latch ①, if necessary.</p>	

5.3 Connecting the (24 V) DC power supply

Note before connecting the device

⚠ WARNING
The device should only be connected to a 24 V DC power supply which meets the requirements of safe extra low voltage (SELV) according to IEC/EN/DIN EN/UL 60950-1. A protective conductor must also be used. The conductors must withstand the short-circuit current of the 24 V DC power source, so that a short-circuit will not damage the cable. Only connect cables with a minimum cross-section of 1.3 mm ² (AWG16) and a maximum cross-section of 3.3 mm ² (AWG12).

Note

The 24 V DC power source must be adapted to the input data of the device (see specifications).

Connecting

Steps for connecting the device to the 24 V DC power supply	
1	Ensure that the ON/OFF switch is in the '0' (OFF) position to prevent unintentional startup of the device when connecting it to the 24 V power supply.
2	Switch off the 24 V DC power source.
3	Insert the DC power plug. ① DC 24 V ② ground ③ protective conductor

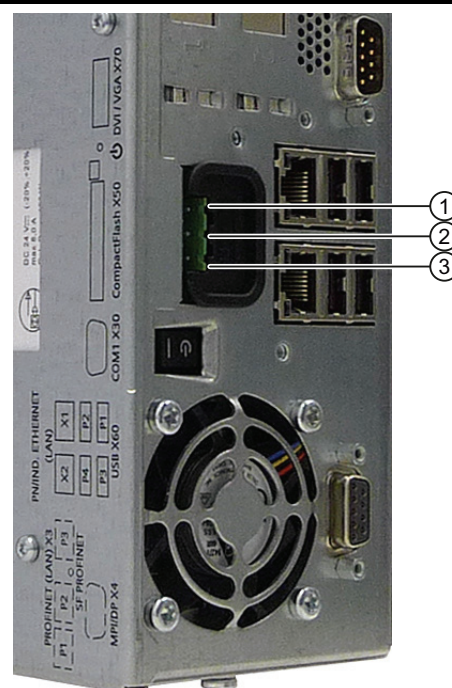

Steps for connecting the device to the 24 V DC power supply	
4	Fasten the cable with the supplied power plug latch, if necessary.

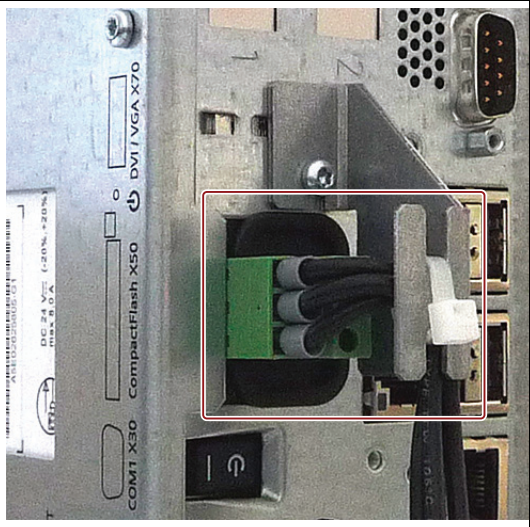

Note

Reverse-polarity protection

The DC power supply (24V) has a mechanism to protect against reverse polarity. In the event the 24 V DC lines are reversed (24 V DC nominal (-15% / +20%) and connected to ground, the device will not sustain any damage. The device will simply fail to turn on. After the power supply has been connected correctly, the device will again be ready to operate.

5.4 Connecting the Equipotential Bonding Circuit

A low-resistance ground connection ensures that interference signals generated by external power supply cables, signal cables or cables to the I/O modules are safely discharged to ground.

The equipotential bonding connection of the device is located underneath the device and is identified by the following symbol:

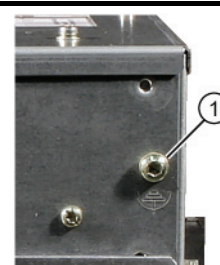

Figure 5-1 Equipotential Bonding

Connecting the Equipotential Bonding Circuit

You require a TORX T20 screwdriver to connect the equipotential bonding conductor.

Steps for connecting the equipotential bonding	
(1)	<p>Connect the equipotential bonding connection (M4 thread) (1) on the device (large surface, large-area contact) with the central grounding point of the control cabinet. The minimum permissible cross-section is 2.5 mm².</p>



5.5 Equipotential bonding with stainless steel front

Information on devices with stainless steel front

NOTICE
<p>Ensure proper electrical contact between the enclosure of the device and the switchboard. The conductive surfaces of the clamping frame and of the switchboard should have proper contact.</p>

5.6 Connecting Ethernet/USB strain relief

The Ethernet/USB strain relief supplied in the product package is used to prevent accidental removal of the Ethernet cable and Industrial Ethernet FastConnect connector from the device. You need two cable ties to use the strain relief. In addition to the Ethernet cables, you can also use this strain relief to protect the four USB cables from inadvertent removal.

To secure the Ethernet strain relief, you will need a TORX T10 screwdriver.

Steps for connecting the Ethernet/USB strain relief	
1	<p>Fasten the Ethernet/USB strain relief ① to the device enclosure with two oval-head screws (M3 thread).</p>
2	<p>Connect the network/USB cable and attach it to the strain relief using cable ties ②.</p>

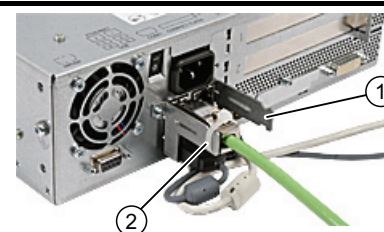

5.7 Connecting the PROFINET strain relief

The PROFINET strain relief supplied in the product package is used to prevent accidental removal of the Ethernet cable and Industrial Ethernet FastConnect connector from the device. You need two cable ties to use the strain relief.

To fix the PROFINET strain relief, you will need a TORX T10 screwdriver.

Steps for connecting the strain relief	
1	Fasten the PROFINET strain relief ① to the device enclosure with two oval-head screws (M3 thread).
2	Connect network cable and attach to the strain relief using cable ties ②

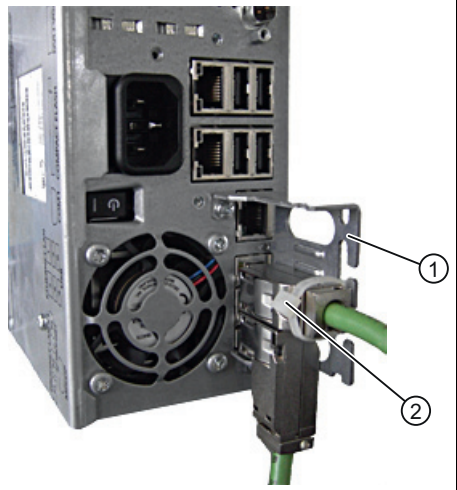

5.8 Connecting the power plug locking mechanism

The power plug locking mechanism is part of the scope of supply and prevents the power plug from being pulled out accidentally. The power plug locking mechanism is a metal bracket that is screwed onto the computer housing.

You require a TORX T20 screwdriver for attaching it to the housing.

The power plug locking mechanism is a safety-relevant part. Read the information in the chapter "Connecting the (120 V / 240 V AC) power supply".

Integration into an automation system

6.1 Overview

Introduction

The following options are available for integrating the device in existing or planned system environments and networks.

Ethernet

Remote booting is supported.

The integrated Ethernet interface can be used for communication and for data exchange with automation devices such as SIMATIC S7.

You require suitable software for this: STEP 7, WinCC, WinCC flexible, WinAC, SIMATIC NET.

PROFIBUS/MPI

The isolated PROFIBUS interface can be used to connect distributed field devices or to link with SIMATIC S7.

You require suitable software for this: STEP 7, WinCC, WinCC flexible, WinAC, SIMATIC NET.

PROFINET

The CP 1616 onboard enables Panel PCs to be connected to Industrial Ethernet. Only one CP 1616 can be installed in a PC. Detailed information can be found in the next section or in the chapter *Detailed descriptions > CP 1616 onboard communications processor*.

Device driver CP16xx.sys

The device driver enables the Windows network protocols to be connected to the Ethernet PROFINET controller "CP 1616 onboard" which is optional on the SIMATIC PCs. The PROFINET interface will act like a 100 Mbit Ethernet interface with a MAC address when you use this driver. The three RJ45 sockets are connected with each other via a switch.

The driver and the documentation can be found in the supplied Documentation and Drivers CD.

PROFINET IO application

You can create, run or configure PROFINET IO applications with the "Development Kit DK-16xx PN IO". It must be installed in addition to the device driver CP 16xx.sys. You can download this kit and the documentation free of charge at the following Internet address: (http://www.automation.siemens.com/net/html_76/produkte/040_cp_1616_developkit.htm)

SIMATIC NET

You can create, run and configure the SIMATIC installation with this software package. Information on this can be found on the SIMATIC NET Manual Collection CD. The software package and the documentation are not included in the package.

Additional information

You can find additional information in the catalog and in the Internet of Siemens A&D.

<http://www.siemens.com/automation/mall>

6.2 Device in SIMATIC S7 network

6.2.1 MPI/PROFIBUS-DP network

You can connect the device to a SIMATIC S7 automation system or a PROFIBUS DP network via the MPI/DP interface. You can connect up to 32 PC, PG, or AS devices to one network segment. The use of repeaters allows you to interconnect several MPI/PROFIBUS DP network segments. The complete MPI/PROFIBUS DP network consists of a maximum of 127 stations.

The device is physically connected to the MPI/PROFIBUS DP network via an electrically isolated RS485 interface on the PC motherboard. The potential is isolated within the safety low voltage circuit (SELV).

The transmission rate is limited to 187.5 Kbps with the 5-meter MPI cable for connecting to the SIMATIC S7-CPU. To achieve baud rates over 1.5 Mbps, you require a 12 Mbps PROFIBUS cable with the order number 6ES7901-4BD00-0XA0. In the PROFIBUS DP MPI network, you can achieve data transmission rates of 9.6 Kbps to 12 Mbps.

6.2.2 Connecting an S7 automation system

Coupling

The device is coupled via the MPI/DP interface as follows:

- With MPI networks S7-200, S7-300, and S7-400
- PROFIBUS DP networks with DP components

Hardware requirements

You can use the following components for coupling or networking with PROFIBUS:

- RS 485 interface, MPI/DP interface, onboard
- PROFIBUS cable

Note

Refer to the SIMATIC Net catalog IK PI for more information about SIMATIC Net expansion cards.

Procedure

1. Disconnect the device from the mains.

NOTICE
Risk of damage to the device!
Neutralize the static charge of your body, the device, and the connecting cables. You can do this by briefly touching the metal housing with the cable in your hand.

2. Insert the PROFIBUS cable in the MPI/DP socket.
3. Reconnect the device to the electrical power system.

6.3 Transferring authorizations

Note

The device has no floppy disk drive. Therefore, where necessary, transfer the authorizations for SIMATIC HMI software from a USB floppy disk drive.

The following devices have been tested:

SINUMERIK floppy disk drive, order number 6FC5235-0AA05-1AA2

NOTICE
The USB floppy disk drive is only suitable when mounted in a control cabinet.

6.4 Networking via Industrial Ethernet

You can establish a network between the device and other computers via Industrial Ethernet. The on-board LAN interface is a twisted-pair (TP) interface for data transfer rates of 10/100/1000 Mbps.

Note

A category 6 Ethernet cable is required for 1000 Mbps operation.

6.5 PROFINET

CP 1616 onboard

The basic characteristics of the CP 1616 onboard are:

- Optimized for PROFINET IO
- With Ethernet-Real-Time-ASIC ERTEC 400
- Three RJ45 sockets for connecting terminal devices or addition network components
- Integrated 3-port real-time switch
- Automatic hardware detection

NOTICE
Only one CP 1616 can be installed in a PC. If you want to use an additional CP 1616 module, the "CP 1616 onboard" option must be disabled in the BIOS Setup.

Additional documentation on PROFINET

Get an overview of the information available on the topic of PROFINET.

Document designation	What is contained in this document?
This documentation is not included in the product package:	
Getting Started PROFINET IO Getting Started: Manual Collection	The documents use concrete examples to provide step-by-step instructions on how to commission a fully functional application.
Manual PROFINET System Description	This gives you the basic knowledge about the PROFINET IO topics: Network components, data exchange and communication, PROFINET IO, Component Based Automation, application example of PROFINET IO and Component Based Automation.
Manual From PROFIBUS DP to PROFINET IO	Read this document if you want to convert an installed PROFIBUS system to a PROFINET system.
Readme file for CP 1616/CP 1604 and DK-16xx PN IO	This provides the latest information about the SIMATIC NET products CP 1616/CP 1604, CP 1616 onboard, the developer kit.
Configuration Manual Commissioning PC Stations	This provides you with all the information necessary for commissioning and configuring a PC as a PROFINET IO Controller or IO Device.
Manual SIMATIC NET Industrial Communication with PG/PC: Volume 1 - Basics SIMATIC NET Industrial Communication with PG/PC: Volume 2 - Interfaces	This manual introduces you to industrial communication and explains the available communication protocols. It also describes the OPC interface as an alternative to the IO-based user programming interface.
S7 CPs for Industrial Ethernet Configuring and Commissioning	This provides the following support: - For commissioning S7 stations - For establishing effective communication
Manual SIMATIC NET - Twisted Pair and Fiber-Optic Networks	Configure and build your Industrial Ethernet networks based on this document.
This documentation is part of the supplied Documentation and Drivers CD:	
Operating Instructions CP 1616/CP 1604/CP 1616 onboard	This provides you with all information required for operation.
Installation guide Device Driver CP16xx.sys	Read this guide if you want to install the NDIS device driver, CP16xx.sys.

Further information

You can find the information on specific products in the Internet at the address:
<http://www.siemens.com/simatic-net>

Commissioning

7.1 Requirements for commissioning

NOTICE
Risk of damage to the device!
Make sufficient allowances for the device to acquire room temperature before you put it into use. If condensation has developed on the device wait at least 12 hours before you switch it on.

Note

The device features an off/off switch and an on/off button.

By default, the BIOS Setup entry "After Power Failure" is set to "Power On". This means that the device is turned on using the on/off switch.

If the BIOS Setup entry is set to "Stay Off" or "Last state" and the on/off switch is set to "I" (ON), the device can only be turned on by pressing the on/off button.

-
- Connect the peripherals, such as the keyboard, mouse, monitor and the power supply, before putting the device into operation.
 - The operating system you ordered for your device is already installed on the hard disk.

7.2 Switching on the device

Note

Commission the device before you install additional hardware, such as a PCI interface card.

Procedure

1. Switch on the external AC or DC power supply.
2. Connect the external keyboard and mouse.
3. Switch on the equipment using the switch next to the power plug.

The "POWER" LED is illuminated when the device is commissioned and starts.

Self-test

The system carries out a self-test after it has been switched on. During the self-test, the message "Press <F2> to enter SETUP" appears briefly. Do not press the <F2> key for this first start-up.

When the self-test is finished, the operating system will be loaded. You will see this from the screen display.

See also

Windows XP and Windows Embedded Standard 2009 (Page 61)

7.3 Windows XP, Windows 7 Security Center

Warning from the Windows Security Center

A warning from the Windows Security Center appears the first time you switch on your device. The Security Center checks the status of the device in regard to the three important security aspects listed below. If a problem is detected (an outdated antivirus program, for example), the Security Center issues a warning and makes recommendations on how you can better protect the device.

- **Firewall:** The Windows Firewall adds protection to the device by blocking network or Internet access to the device by unauthorized users. Windows checks if the device is protected by a software firewall.
The firewall is enabled in the factory state.
- **Antivirus software:** Antivirus programs add protection to the device by searching for and eliminating viruses and other security threats. Windows checks if a full-range, up-to-date antivirus program is running on the device.
No antivirus software is installed in the factory state.
- **Automatic updates:** Using the Automatic Update feature allows Windows to regularly search for the latest critical updates for the device and to install them automatically. This feature is disabled in the factory state.
- **Realtime protection (Windows 7 only):** Windows Defender displays warnings if spyware or possibly unwanted software is installed or executed on the computer. You will also receive a warning if programs attempt to modify important Windows settings.

Configure the Security Center according to your requirements.

7.4 Setting up the Microsoft Windows operating system

Introduction

The setup wizard appears immediately following the startup of the device. The wizard is used to set the parameters of the operating system.

Note

The dialogs of the setup wizards differ slightly in some places for the Windows operating systems.

In order to change to the next dialog, click on the ">>" button. In order to change the entry in the previous dialog, click on the "<<" button.

Procedure

1. Accept the Microsoft licensing agreement.
2. Leave the regional settings of the operating system unchanged. If required, adjust the regional settings of the operating system only after commissioning.
3. Enter the company names and user names.
4. If this PC name is already in use as you attempt to connect the device to a network: Enter a new PC name for identification.

The operating system will restart automatically.

The system settings are updated. The desktop is set up. The setup of the operating system is complete.

7.5 Windows XP and Windows Embedded Standard 2009

First commissioning

- The "SIMATIC PC Wizard" program is automatically started once during the first commissioning.
- The wizard will automatically set the device-specific drivers and applications at the initial start of the operating system.
- The hardware is detected automatically.

Procedure

1. Start the device with unchanged factory settings.
2. Follow the instructions displayed on the screen.

Note

Malfunctions

Do not switch off the device during the software installation. Follow the instructions that appear on the screen right to the end of installation.

The dialogs can differ for different Windows operating systems.



7.5.1 Touch Panel set-up

Note

The configuration of the HMI device will be detected and set automatically. During the hardware recognition, the Touch Controller is detected again and entered.



1. Calibrate the touch screen by touching the selected points as shown in the illustration.

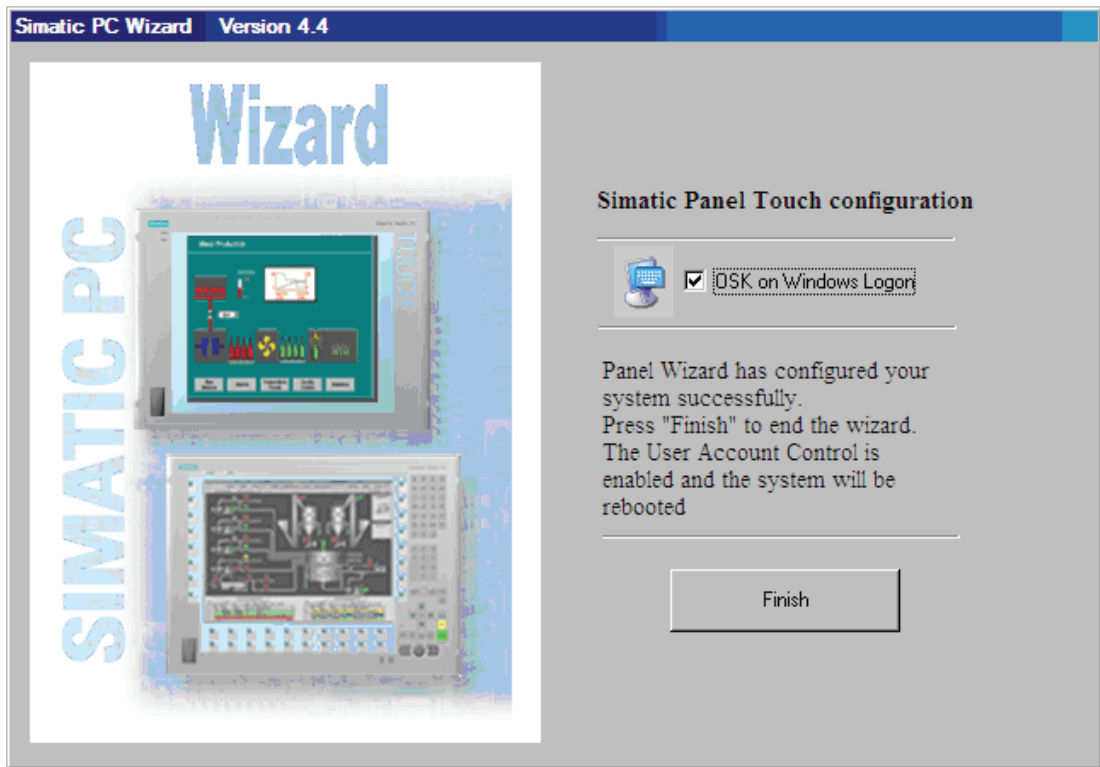

2. If "OSK on Windows Logon" is enabled, the Windows on-screen keyboard will be displayed every time you log on. You can use this keyboard to enter the password, for example. If you disable the "OSK on Windows Logon" option, then the Windows on-screen keyboard will not be displayed. An external keyboard will then be required to log on.

In Windows 7 the Windows on-screen keyboard will not appear until you have assigned a password for the user account.

3. Use the "Finish" button to terminate the wizard. The HMI device will be automatically restarted for the respective configuration.

7.5.2 Key Panel adjustment

Note

The configuration of the HMI device will be detected and set automatically.

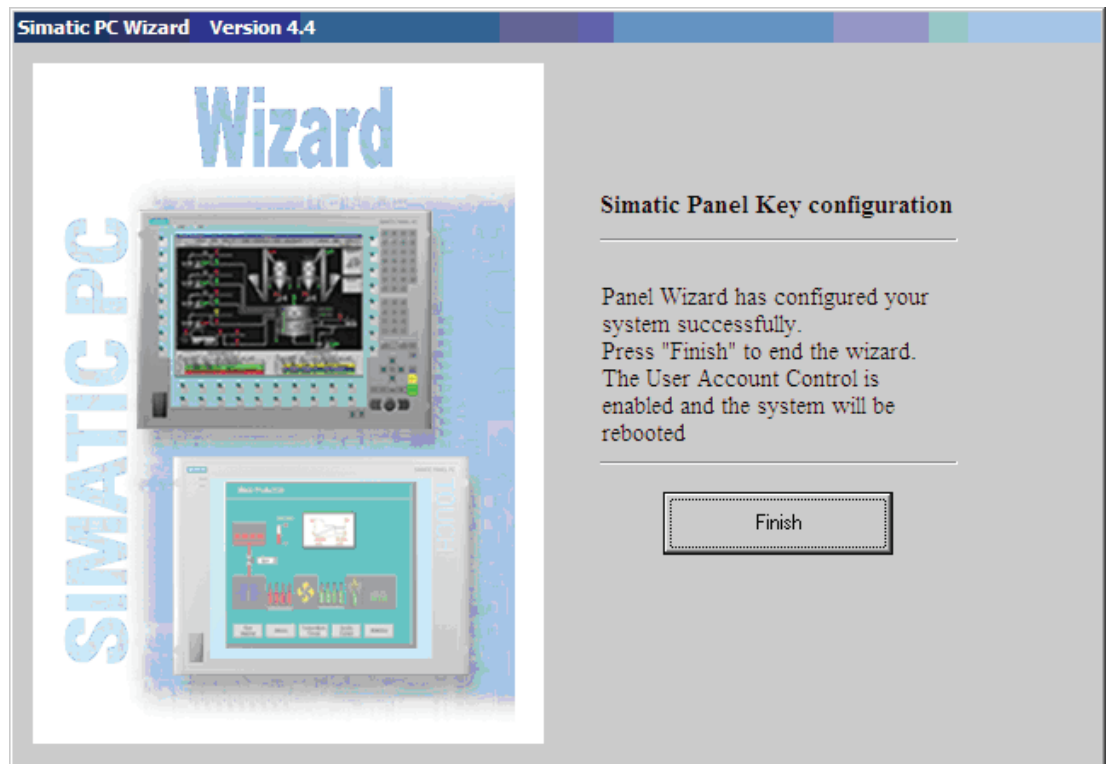

1. Use the "Finish" button to terminate the wizard. The HMI device will be automatically restarted for the respective configuration.

7.6 Windows 7 (32 and 64-bit)

7.6.1 Installation software

First commissioning

- The "SIMATIC IPC Wizard" program is automatically started once during the first commissioning.
- The wizard will automatically set the device-specific drivers and applications at the initial start of the operating system.
- The hardware is detected automatically.

Procedure

1. Start the device with unchanged factory settings.
2. Follow the instructions displayed on the screen.

Note

Malfunctions

Do not switch off the device during the software installation. Follow the instructions that appear on the screen right to the end of installation.

The dialogs can differ for different Windows operating systems.

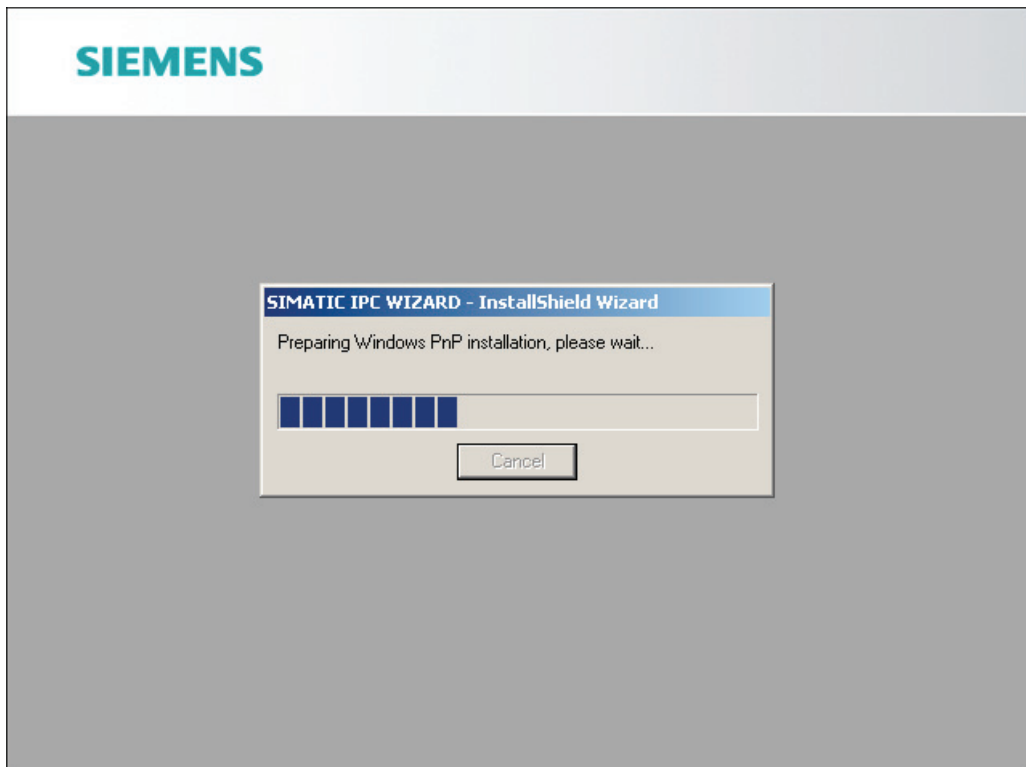

The PC will restart after installation is complete.

Additional information about the IPC wizard software can be found in the "SIMATIC IPC Wizard" operating manual on the included "Documentation and Drivers" DVD.

7.7 BIOS settings

The BIOS setting "USB legacy Support" is enabled by default. Thus, the complete functionality of a USB keyboard is available prior to starting up Windows. You can also adjust the BIOS settings with the USB keyboard.

Note

To edit the BIOS on an operator device equipped with a touch screen, connect a USB keyboard.

7.8 USB

Introduction

Commercially available USB peripherals can be easily and flexibly connected via the USB interface. For example, you can connect an external USB keyboard and a USB mouse. If the USB keyboard has a USB interface, you can connect other USB peripherals, such as a USB mouse, directly to the keyboard.

USB interface

There are several types of USB peripherals:

- Low power devices: maximum 100 mA power consumption, e.g. mouse and keyboard
- High power devices: maximum 500 mA power consumption, e.g. hard disk with a separate power supply and floppy drive

Note

The general USB specifications apply to the USB interfaces on the computer unit.

The USB interface on the control panel has been approved for a maximum of one additional USB hub.

Using USB peripherals

Note

When installing a USB device for the first time, make sure you have the required device driver.

Before removing an intelligent USB device, deactivate the device in the operating system using the dialog "Unplug or Eject Hardware". For additional information, refer to the documentation for the operating system.

7.9 Notes on operation

7.9.1 DVD burner

The DVD burner drive is an optional feature. Recording methods supported by the disk drive: Disc-at-once, Track-at-once, Session-at-once, Packet writing. You can write to CD-R, CD-RW, DVD+R, DVD-R, DVD-RW, DVD+RW, DVD-RAM and dual-layer media.

Burner software

In order to utilize full functionality of the DVD burner under Windows XP, you need to install additional software (burning software). This software is included on the CD supplied with the device. Insert the CD in the drive, run setup and follow the instructions on the screen.

Note

When first starting the burner software, no data carriers should be inserted in the drive. This is because data carriers with errors can interrupt the automatic hard drive recognition. This makes it impossible to correctly display the possible burner functions.

Notes on burning optical data carriers

NOTICE
Danger of data errors when burning data carriers!
Burning is permissible only in an undisturbed environment, i.e. shock and vibration stress must be avoided. Because of heavy fluctuation in the quality of CD-Rs, data may be corrupted in a burning session, even if no error message is initially displayed. The written data can only be verified by comparing these with the source. To be on the safe side, data should be verified after every burning session. When backing up an image, the data should be restored to the hard disk and the system should be rebooted from the hard disk.

7.9.2 2HDD system (optional)

The factory configuration of the two hard disks is as follows:

Hard disk 0	Hard disk 1
Partition C: System, NTFS, 25 GB	Not configured
Partition D: Data, NTFS, remaining capacity	

The two hard disks are connected to the SATA ports 0 and 2. The hard disk on SATA port 2 is not configured. This gives you the option of backing up your data to this hard disk. For information on hard disk capacities, refer to your order documentation.

Booting from the slave hard disk

The system boots by default from the hard disk on SATA port 0. You can also configure the system to boot from the disk on SATA port 2.

In order to allow booting from the second hard disk, you need to configure it as the primary boot device. Make the following settings in your BIOS Setup:

Select Boot > Legacy > Hard Disk Drive > <Hard disk name> e.g. P0- ST3500418AS, then press the "+" key to move it up in the boot order.

Note

The drive letters for the partitions on both drives are assigned by the operating system used. You can change these in the Control Panel as required.

7.9.3 RAID1 system (optional)

This is a RAID1 system configuration (mirroring with two hard disks). This configuration enhances system availability as the system is able to continue operation if a hard drive fails, or if there is a cable problem at a channel.

The two hard disks are configured as follows in the factory state of the device:

RAID1 system
Partition C: System, NTFS, 25 GB
Partition D: Data, NTFS, remaining capacity

Note

You can find information regarding Intel RAID controllers in the RAID documentation on the included "Documentation and Drivers" CD in the Drivers\RAID\Intel directory.

```
Intel(R) Rapid Storage Technology - Option ROM - 9.5.0.1021
Copyright(C) 2003-09 Intel Corporation. All Rights Reserved.

RAID Volumes:
  ID  Name          Level          Strip          Size Status      Bootable
  0   Volume0      RAID1(Mirror) N/A           298.1GB Normal      Yes

Physical Devices:
  Port Device Model      Serial #          Size Type/Status(Vol ID)
  0   FUJITSU MJA2320B K90AT9528AD3    298.0GB Member Disk(0)
  2   FUJITSU MJA2320B K90AT9528ACA    298.0GB Member Disk(0)

Press <CTRL-I> to enter Configuration Utility...
```

Figure 7-1 Example

RAID system management functions

The pre-installed RAID system software offers enhanced functionality for RAID system operation and management. Start the software by selecting the "Start > Programs > Intel Rapid Storage Technology" command.

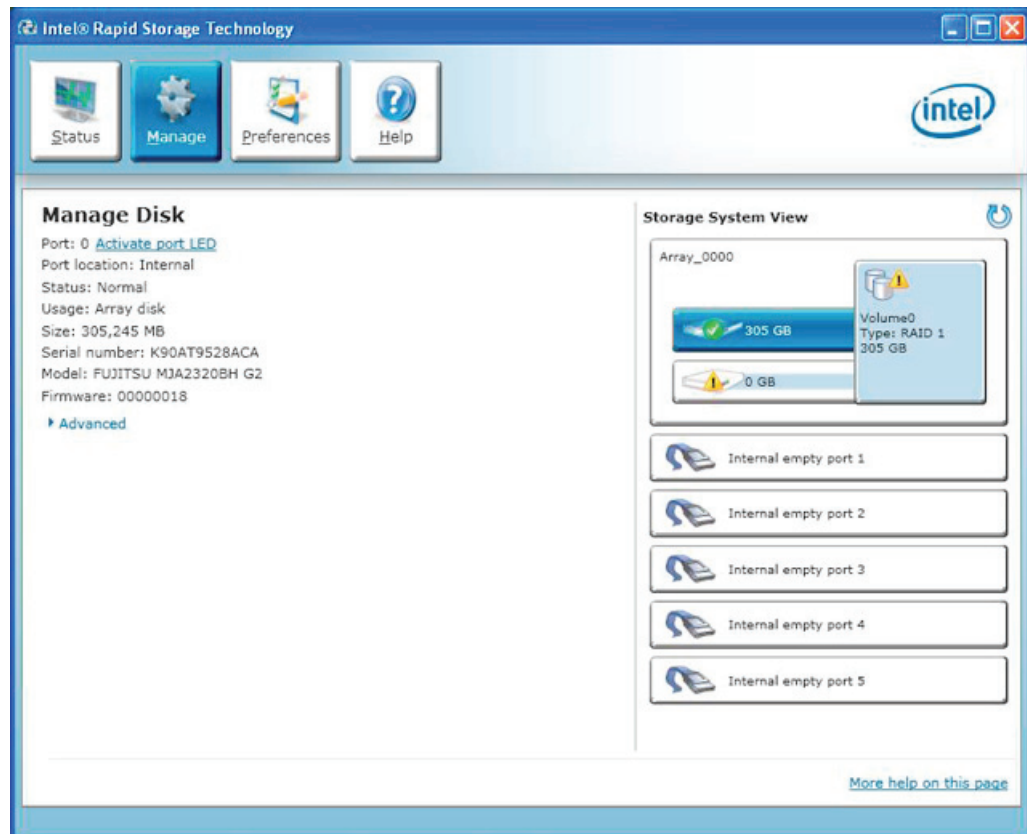

Figure 7-2 Example

The "Manage > Advanced" command returns details of the RAID volumes.

The command "Help > System Report > Save" can be used to create a report with details of the RAID volumes.

Note

The RAID status is always indicated in Windows.

A hard drive can be synchronized at operating system level if a fault is detected. It may take up to several hours to synchronize a new disk in the background, depending on the size of the hard disk and on the system load.

The redundant system state RAID 1 is reached again only after synchronization is completed.

Comments about faults

Note

Input delay

System load may briefly increase due to synchronization when a hard disk has failed, depending on processor load and current hard disk activity.

In extreme cases, input from the keyboard and touch screen may be delayed for a brief period.

Before you replace the defective hard disk, create a backup copy of the system.

7.9.4 Replacing a defective drive in the RAID system

A missing drive is reported via the RAID software.

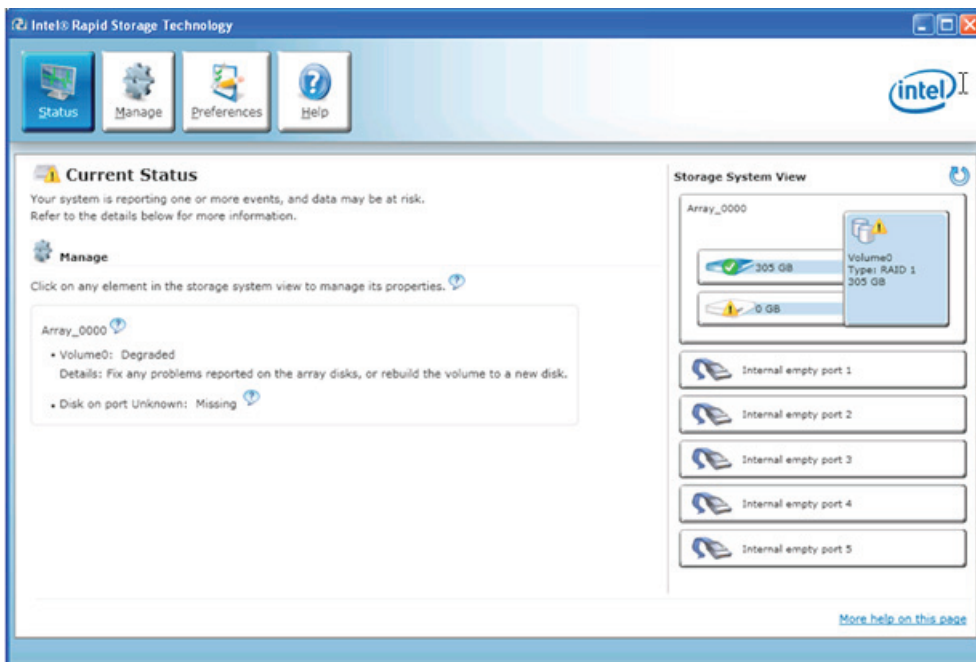

Figure 7-3 Degraded message of RAID software

Replace defective RAID drives with a new drive in order to recover secure RAID1 state. The RAID software reports the defective drive and returns details of the operable hard drive.

The functioning hard drive is indicated in BIOS by its port number, or by the RAID software by its port number:

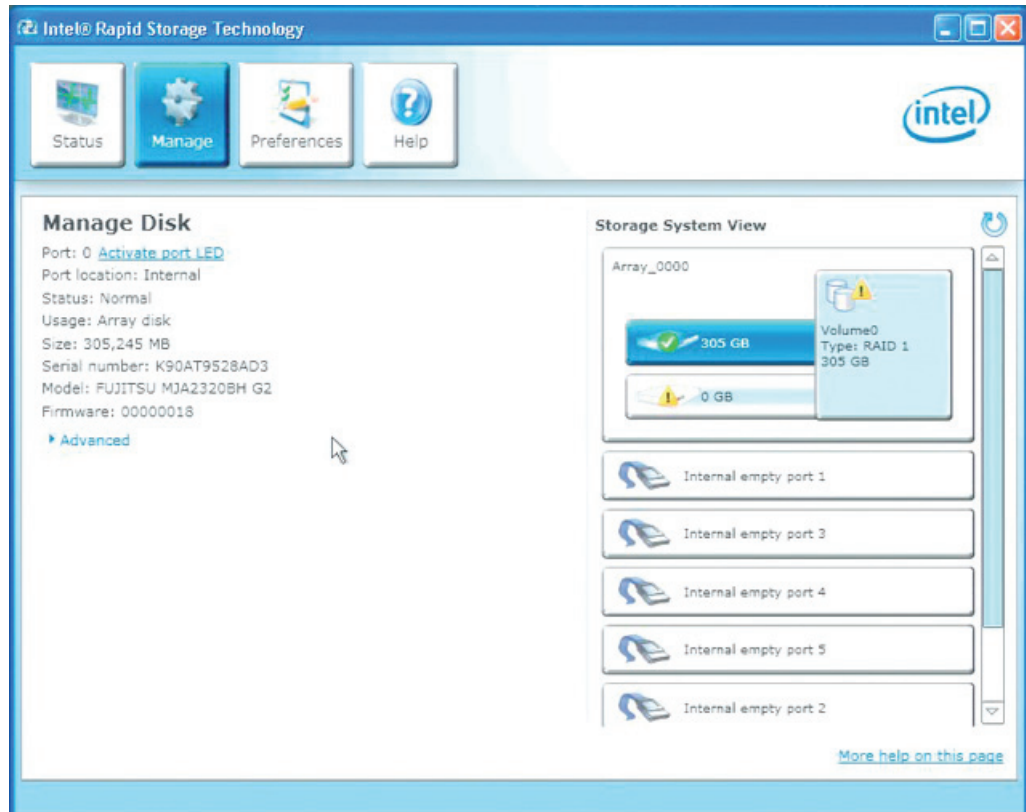

Figure 7-4 Information about the functioning hard drive

Always replace the defective drive with a new one of the same type and capacity.

To be able to boot from the RAID system, you must place this first in the list of bootable sources in the BIOS "Boot" setup menu. Otherwise the system will boot from the hard disk you have just installed and the message "Operating system not found" will be displayed.

Note

BIOS messages during startup

At the first restart / cold start following a hard disk failure or installation of a new hard disk (servicing), the RAID BIOS reports that the RAID functionality is no longer available and offers the appropriate operator options.

Note

The new HDD can be integrated into the RAID system at operating system level by means of the RAID software. Synchronization may take several hours, depending on system load.

The "Rebuild to another disk" command initiates synchronization of the RAID1 system:

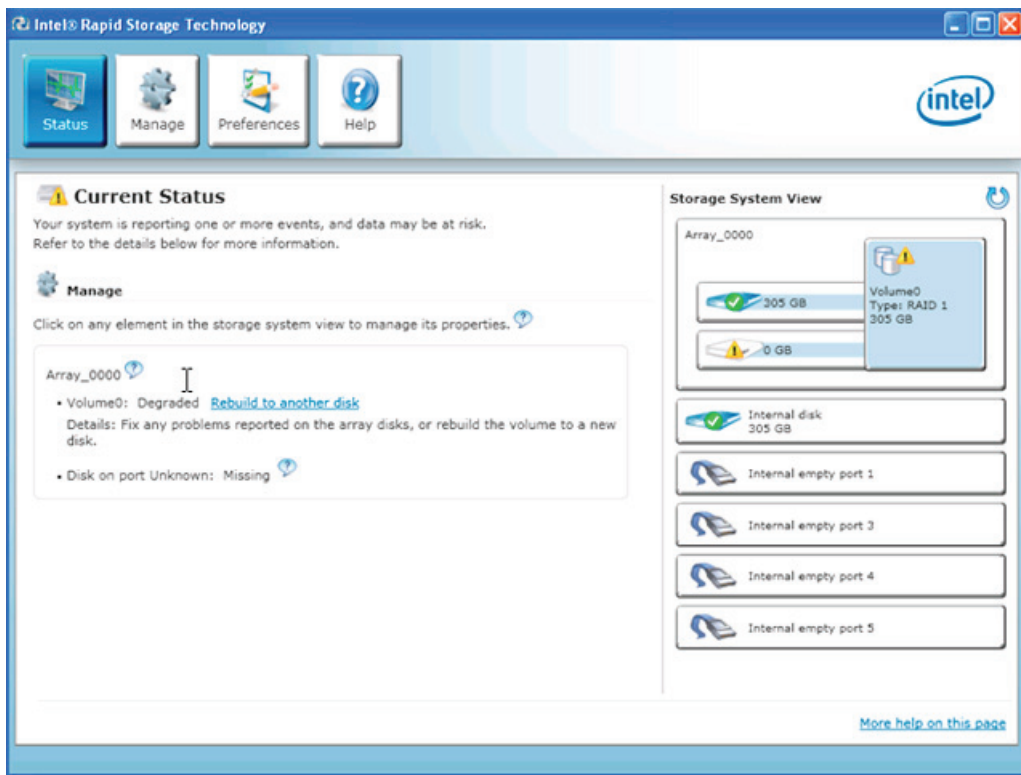

Figure 7-5 Restoring the RAID system

Note

The "SIMATIC PC DiagMonitor" diagnostics and alarm software also provides information about the RAID status. This software only needs to be installed once - logons are not required. The diagnostics and alarm software "SIMATIC DiagMonitor " is available as an accessory.

7.9.5 Compact Flash card (optional)

Note

We highly recommend that you use approved SIMATIC Compact Flash cards. Siemens disclaims any liability for impairment of functions caused by the use of third-party cards.

Design

A Compact Flash card can be used on-board and in an extra mount. This mount replaces the usual hard disk mount.

Characteristics

The Flash drive with Compact Flash card reacts just like any standard IDE hard disk preset as a master. No special driver software is required to operate the Flash drive.

Even though the Flash drive reacts like a hard disk on the outside, there are restrictions due to the limited number of write cycles on Flash memory. The service life of a Compact Flash card depends on the number of write access to the medium - read accesses have no effect.

To maximize the service life of Compact Flash cards, take care that the writing to the cards is kept to a minimum.

For example, you can do this by ensuring that:

- Swap files of the operating system and application are not located on the Compact Flash card.
- Cyclic writing is avoided.

Operating systems such as MS-DOS and Windows XP Embedded allow this, for example. The Enhanced Write Filter (EWF) can be used with Windows XP Embedded, for example. This minimizes the number of write accesses to the Flash drive or avoids it entirely.

Flash drive functions

A Flash drive or a Compact Flash card consists of Flash memory chips.

An intelligent controller integrated in the Flash drive manages the Flash memory. This optimizes the use of the Flash memory to achieve a maximum service life.

The service life of a Flash drive depends in part on the following factors:

- Type of file
Executable files (*.EXE) are usually only written once and stays at the same storage location.
- The number of writes within a given time (the less the better)

Comparison of Flash drive and hard disk drive service life

Examples of the service life for a Flash drive

With a "Data logger function", a 4 KB file is written to a 1 GB Compact Flash card every 5 seconds. The cluster size is 4 KB in this case. Due to the file segmentation, the file is always written to another location on the Compact Flash card.

With this example, the Compact Flash card has a theoretical service life of 79.3 years.

Example of the service life for a hard disk drive

The service life of a hard disk drive depends on the following factors:

- Temperature (operating & storage / transport)
- Shock (operating & storage / transport)
- Vibration (operating & storage / transport)
- Humidity (operating & storage / transport)
- Voltage supply
- Power on hours (POH)
- Duty cycle (% workload, i.e. write/read/positioning)

The service life for a hard disk is between 2.5 and 5 years, depending on the factors listed above.

Booting from the Flash drive

A operating system must be installed before you can boot from the Flash drive. You can read about the procedure required for installation of an operating system in the section Installing Windows (Page 150).

Operation and configuration

8.1 Operator Controls

On/Off switch

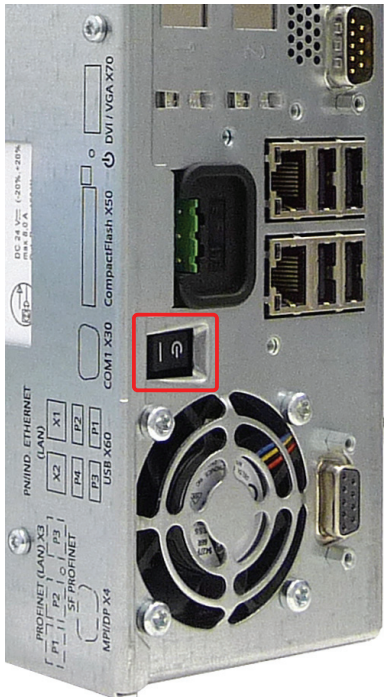
On/Off switch	Description
	<p>Switch the device on using the on/off switch. This requires that the BIOS Setup entry "After Power Failure" is set to "Power On".</p>

WARNING

The on/off switch does not isolate the device from the mains! When the switch is in 0 position (Off), the device is still supplied with mains voltage in order to generate the internal auxiliary voltage for the power supply.

Note

Terminate the operating system before shutting down the device with the on/off switch, otherwise data may be lost.

On/off button

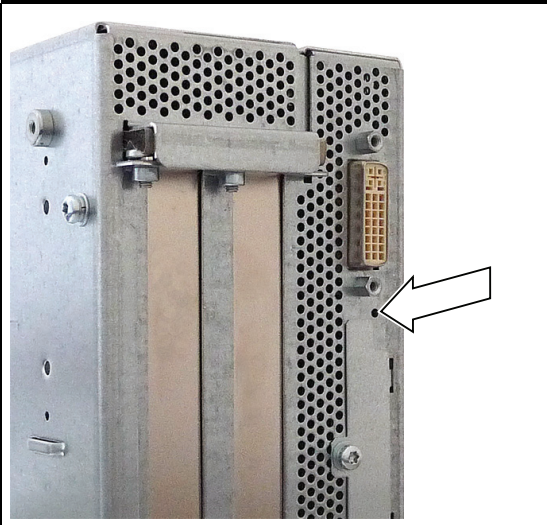
On/off button	Description
	<p>The on/off button has three functions:</p> <ul style="list-style-type: none">- Switch on the PC (press briefly 1x)- Shut down the operating system and PC (press briefly 1x)- Switch off the PC without shutting down the operating system (press and hold more than 4 seconds) = hardware reset.

NOTICE
Data may be lost when the PC performs a hardware reset.

 WARNING
The on/off button does not isolate the device from the mains!

Note

By default, the BIOS Setup entry "After Power Failure" is set to "Power On". This means the device is switched on with the on/off switch and you do not have to operate the on/off button.

8.2 Normal operation

8.2.1 Switching on the device

Requirement

- The peripheral devices are connected.

NOTICE
To comply with the EMC guideline of the device with I/O, ensure that the manufacturer or supplier of the components used guarantees compliance with the regulations. Connect the I/O devices via shielded cables with metal connectors. In doing so, the shield must be connected over a wide area with the metal connector and the connector must be firmly connected with the device housing.

- The operating system and the service packs have been installed and set up on the hard disk of the device. Refer to the "Commissioning" chapter for more information.
- The pre-installed drivers and applications have been set up appropriately. Further information is available in the "Operation and configuration" chapter in the section, "Additional drivers and applications."
- The proper ambient and environmental conditions according to the specifications for the device and the connected I/O modules have been observed.

Procedure

 **WARNING**

Danger of incorrect operations!

The following applies to external input devices or combinations of external input devices and control units with key panels: Ambiguous key codes can cause serious malfunctions of the application program.

Always activate the "Security features" of "KeyTools." Please note the applicable safety information in the "Operation and configuration" chapter in the section, "Additional drivers and applications."

NOTICE

The device must not be switched on if there is condensation. Switch it on only after it has been stored in a (heated) room for at least 12 hours for temperature adjustment.

1. Connect the AC device to a socket with protective conductor with a cable suitable for the application. You connect the DC device to your 24 V DC power supply using the supplied special connector.
2. Switch on the power switch of the device.

The "POWER" LED will light up. The device is now in operation and booting.

NOTICE

Risk of data loss!

Do not switch off the power supply when the device is in operation. Disconnect the power only after the device has been correctly shut down.

After switching on the power supply, the device performs a self-test. During the self-test, the message "Press <F2> to enter SETUP" appears briefly.

When the self-test is finished, the operating system will be loaded and the desktop will be displayed.

The booting process has been completed successfully.

8.2.2 Logging on to the operating system using the on-screen keyboard

The logon dialog is displayed when you have assigned an administrator password.

Note

An on-screen keyboard (OSK) appears for devices with touch screen panels. You can enter the administrator password directly on the touch screen using the screen keyboard or using the mouse. For additional information, refer to the Microsoft help on screen keyboards.

8.2.3 Switching off the device

Note

After shutting down the operating system, the power supply to the device is not switched off. The fans continue to turn, in order to cool the device sufficiently even when it is switched off.

Procedure

1. Shut down the operating system.

NOTICE
If you are using the Windows XP Professional operating system, wait for the display to go dark.

2. Switch the device off using the On/Off switch.
3. In order to isolate the power supply completely, turn off the power at the power supply switch and pull out the plug from the device.

 WARNING
Always pull out the plug to isolate the device from the mains.

8.3 Additional drivers and applications

The necessary drivers and applications are available on the supplied "Documentation and Drivers" CD.

Note

The supplied drivers and applications have been system-tested and are approved for this device. No warranty can be provided for other software.

Press the "Help" button to obtain information concerning the buttons of a dialog.

8.3.1 Standard calibration procedure

Procedure

1. Select "Start > Programs > UPDD > Settings".
The dialog box "UPDD Console" opens.

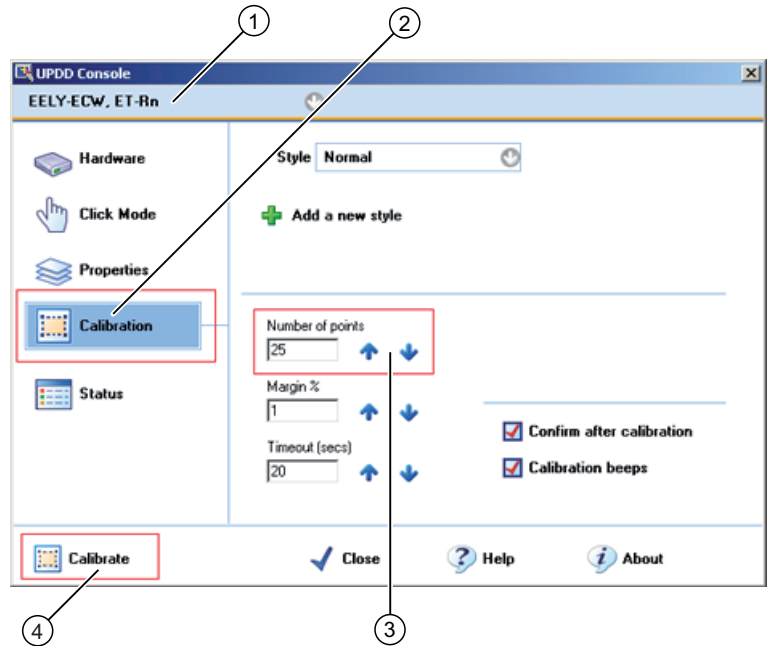

Figure 8-1 Standard calibration

2. Select the Controller ① you wish to calibrate.
3. Click on the "Calibration" tab ②.
4. Activate the option box "Number of points" with the 25 points calibration ③.
5. Click the button "Calibrate" ④.
The calibration screen is displayed in the selected display.
6. Touch the corresponding selections one after the other.
The entry is confirmed by a check mark, the next selection is displayed.
7. Confirm all input prompts (arrows, or crosses in the center) until the complete screen has been calibrated.
8. Finally, confirm the input prompt "Confirm".

8.3.2 Activate touch functionality

Procedure

1. Select "Start > Programs > UPDD > Settings".

The "UPDD Console" dialog box opens.

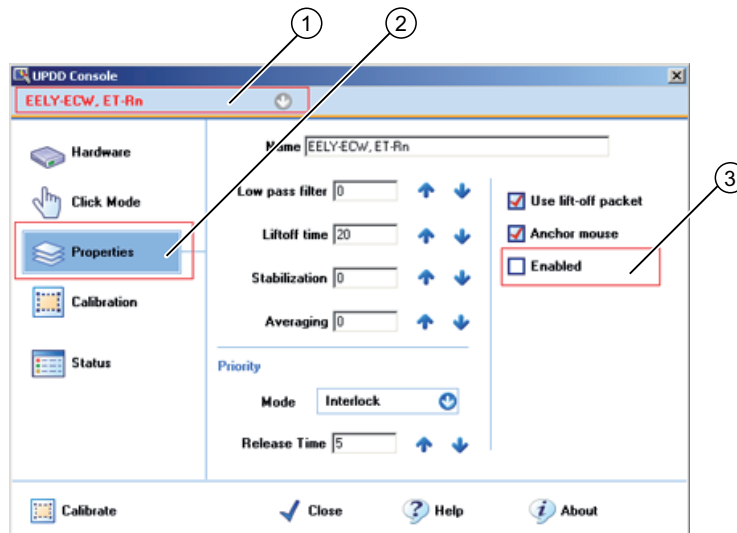

Figure 8-2 Activate touch functionality

2. Select the corresponding Controller ①.
3. Set a tick in the "Enabled" ③ option box in the "Properties" ② tab.
The Controller is activated.

8.3.3 Extended Touch touch functionality

Procedure

1. Select "Start > Programs > UPDD > Settings". The "UPDD Console" dialog box opens.

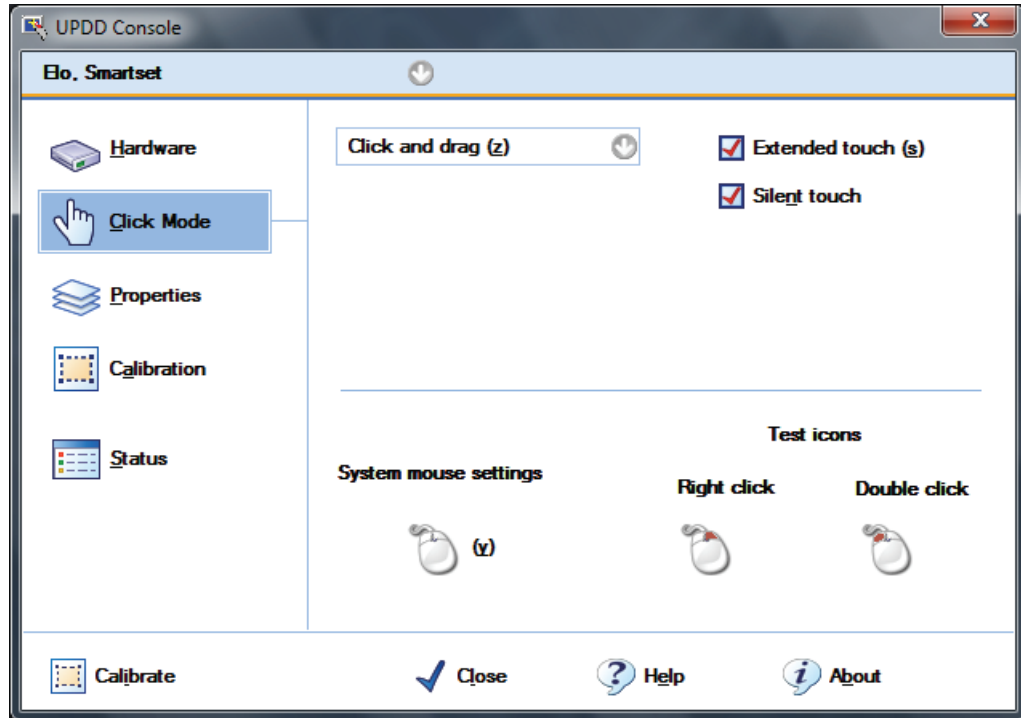

2. Select the corresponding controller.
The "Extended touch" option is preset.

Note

Extended touch applies only to the Windows 7 Ultimate operating system.

If "Extended touch" is selected, the extended touch functions of Windows 7 will be available, such as operating touch permanently, which corresponds to the right mouse button function.

8.3.4 Deactivate touch functionality

Procedure

1. Select "Start > Programs > UPDD > Settings".
The dialog box "UPDD Console" opens.

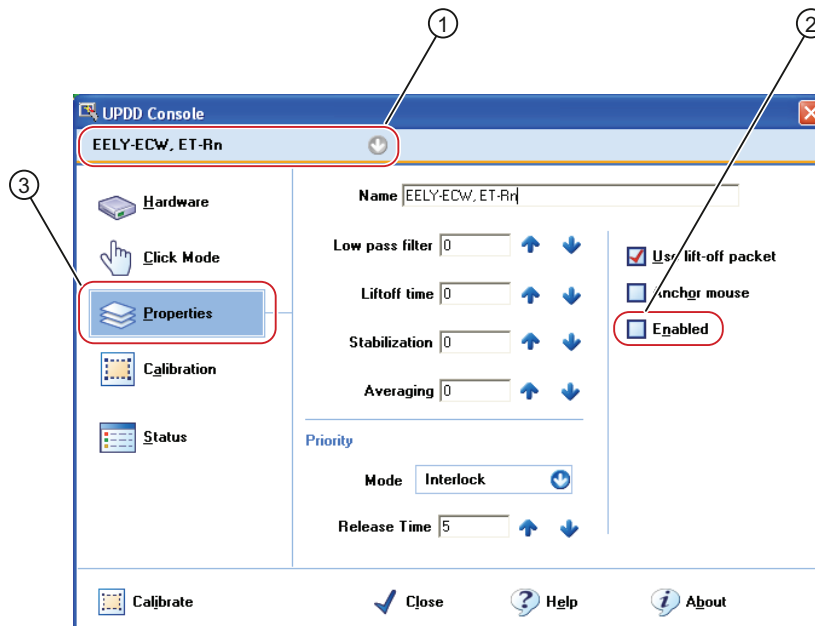

Figure 8-3 Deactivate touch functionality

2. Select the corresponding controller ①.
3. Remove the tick in the "Enabled" ② option box in the "Properties" ③ tab.

The controller is deactivated.

Note

If you close the dialog box using "Close", the touch functionality remains deactivated.

If not mouse is connected, you can also reactivate the Touch Panel by means of a key combination. Restart the "UPDD Console" via the start menu.

The keyboard entry <Alt+p> opens the tab "Properties" ③. Then the Touch Panel can be reactivated by entering <Alt+n>. (option box "Enabled" ②)

8.3.5 KeyTools (for key panel devices)

SIMATIC KeyTools is one selection of the applications for your Panel PC. These applications allow you to adapt key codes that are sent by the key panel of the control unit. SIMATIC KeyTools consists of the following applications:

- Key code table: Loading and editing of key code tables
- WinCC hotkey function: WinCC hotkey function activation and deactivation
- Security features: Lock function that prevents two function keys from being activated simultaneously. This prevents incorrect operations and undefined states of the user program.
- Control of the key LEDs
- Keypad lock with use of two control units on one PC

Note

For a detailed description of the SIMATIC KeyTools, refer to the help menu and the application description on the "Documentation and Drivers" CD.

Calling up KeyTools

1. Select "Start > Settings > Control Panel > SIMATIC KeyTools".
For Windows 7: Select "Start > Programs > Siemens Automation > SIMATIC > IPC Wizard > IPC KeyTools > IPC KeyTools".
2. Select the desired application and follow the instructions on the screen.

Note

Malfunctions of the user software

For security reasons always use the "Security features". If you deactivate it nevertheless, serious malfunctions of the user software may occur when the additional function keys and softkeys F11 to F20 and S1 to S16 are used or if own key code tables are used.

8.3.6 On-screen keyboard (for touch panel device)

You can operate the device by means of a virtual screen keyboard. You can use it to enter the characters directly on the touch panel or with an externally connected mouse.

Calling "Touch input" (not with Windows 7)

Start the "Touch input" application on the desktop. The screen keyboard is displayed.



(1) Button for language selection: German, English, Italian, Spanish, French

8.3.7 Panel PC Tools for Windows XP and Windows Embedded Standard 2009

The program installs two software applications:

Controlling backlighting

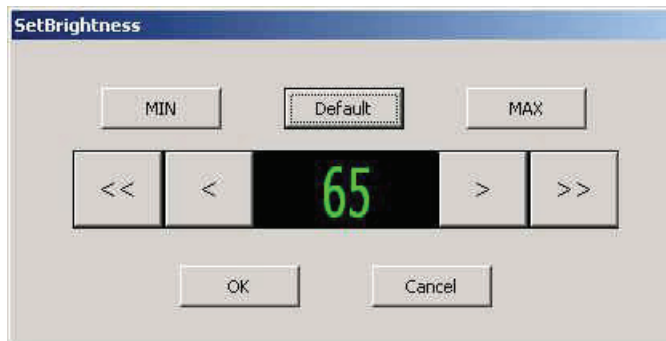

Set the brightness "Brightness" of the screen via the backlighting. The factory setting and the "default" value is 65. Call via an icon on the desktop.

You can use the "<" and ">" buttons to change the value in each case in increments of one, the "<<" and ">>" buttons to change the value in increments of ten. The "MIN" button set the brightness to the value 0, "MAX" to the value 100.

Controlling backlighting using the screen saver

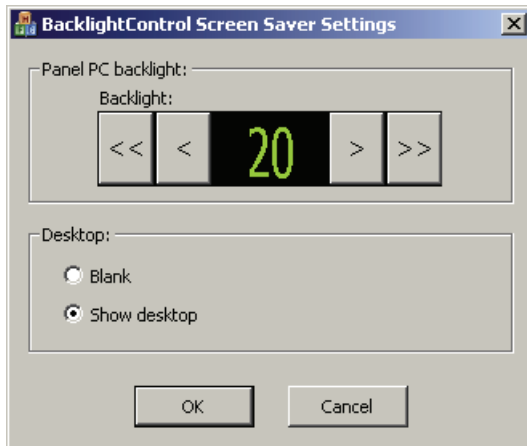

Sets the brightness "Brightness" of the screen while the screen saver is active. In the "Desktop" area, select whether the screen is black during this operation or whether the desktop shines through.

Batch jobs

Alternatively, you can control the brightness using a software program. To do this, call the following Windows batch job in the folder "C:\Program Files\Siemens\PPC Tools":

"BrightnessControl"

You use the command-line parameters to switch the backlighting on and off, set the brightness to a specific value, or change the brightness at each call in specific increments.

8.3.8 Panel PC Tools for Windows 7

8.3.8.1 SetBrightness

SetBrightness allows you to set the brightness of all identified SIMATIC devices.

Note

If an additional display device, such as a Flat Panel, is connected during operation, then restart the PC. After the restart, SetBrightness detects the additional display device.

The Windows 7 "Fast User Switch" for switching from multiple simultaneous users is not supported.

Procedure



1. Open the dialog box for setting the brightness by clicking the "SetBrightness" icon on the desktop. The following figure shows the dialog box using an example with two devices.

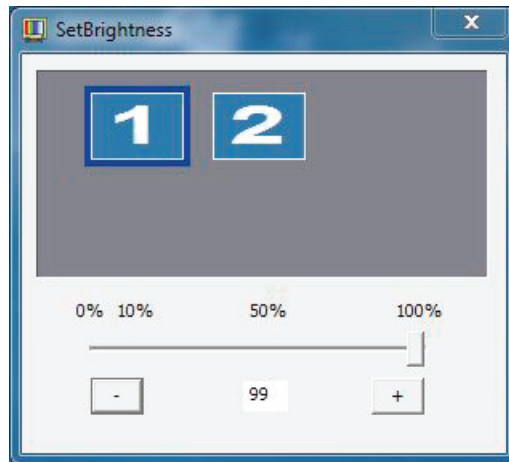

2. Select the device whose display brightness you want to change. In the example, device "1" is selected, all other devices are not selected.
3. Set the desired display brightness. You have the following setting options:
 - Using the slider. The set value is applied when you release the slider.
 - Using keyboard input in the text box
 - Using the "Increase brightness (+)" and "Decrease brightness (-)" buttons.

Note

The minimum value for the brightness setting is 10%. If you select a value of less than 10% using one of the setting options, the brightness value is automatically set to 10%.

Command line call

Call parameters

The "SetBrightness" program can be called in command line mode. The option "-?" (or incorrect parameters) displays a help text that explains the corresponding call parameters. If the "SetBrightness" program is started with the parameter "-experthelp", an extended help text is displayed. The "SetBrightness" program can be called in the command line with the following options:

SetBrightness.exe -ACTION [VALUE] [-device DEVICENUMBER]

Note

In contrast to the graphical interface, the minimum value is set to 0% in command line mode. In this case, the display is switched off. By pressing an input device, for example touch or keyboard, the display is switched on again and set to the most recent configured brightness level. The first input event, for example a mouse click, is discarded in this case to avoid the triggering an unintended action.

Parameter -ACTION [VALUE]

The "ACTION" parameter must be specified for each command line call of the "SetBrightness" program. The following options are available for selection:

Value	Explanation
-get	Returns the currently set brightness. There must not be any other value specified for VALUE.
-set	The brightness value specified by VALUE (0-100) is applied.
-getdevicecount	Supplies the number of connected displays. There must not be any other value specified for VALUE.

Option [-device DEVICENUMBER]

The "device" option can be specified for the command line call of the "SetBrightness" program. It specifies the number of the display for which the current brightness is to be read out or set. If the option is not used, the Display with the number 1 is always used. The following are examples of this:

SetBrightness -get	Returns the brightness of display "1".
SetBrightness -set 50 -device 2	Sets the brightness of display "2" to 50%.

Advanced options -plugin PLUGINNAME

To increase the execution speed, it can be specified explicitly for the command line call that not all available plugins are loaded, but rather only the plugin indicated by PLUGINNAME. Notice: The respective numbers of the operable displays are shifted accordingly. Example:

SetBrightness.exe -set 75 -device 2 -plugin FPPlugin.dll	Sets the brightness of display "2" to 75%. Only the "FPPlugin.dll" plugin is loaded.
--	--

Troubleshooting in graphic mode

If the "SetBrightness" program is started in graphic mode, any problems arising are displayed in a special area of the "Device selection window". The Display icons are displayed in gray. An input is then not possible.

Troubleshooting in command line mode

If the "SetBrightness" program is started in command line mode, any problems arising are displayed in corresponding return values.

Return value	Explanation
0x80000001	A device number was specified that could not be found.
0x80000002	No action was specified.
0x80000003	The "get" action was called. However, other values or invalid values were specified.
0x80000004	The "set" action was called. However, a valid value was not specified.
0x80000005	The "getdevicecount" action was called. However, other values were specified.
0x80000008	A required plugin could not be loaded.
0x80000009	A display could not be found
0x8000000A	A connection to the specified display could not be established.
0x8000000B	The current brightness value could not be determined.
0x8000000C	The brightness value could not be controlled.
0x8000000D	The "SetBrightness" program is already running.

8.3.8.2 BbcScreenSaver

Note

If an additional display device connected to the PC during operation, the PC must be rebooted. During the start of Windows, the additional device is recognized by the service of the screensaver and integrated.

Procedure

1. Open the "Screen Saver Settings" dialog with "Start > Settings > Control Panel > Display".

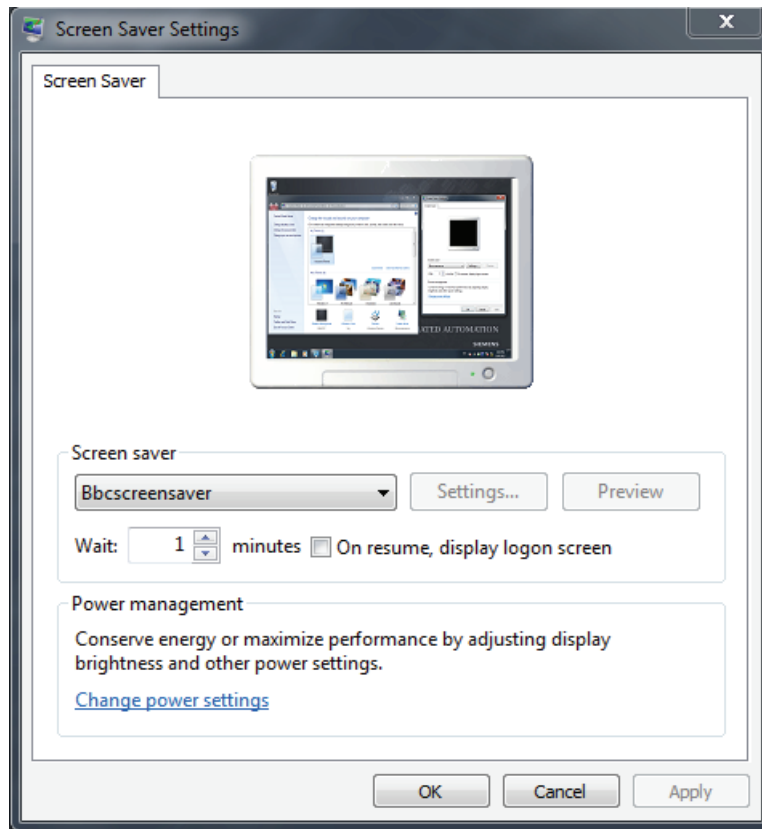

2. Select the "BbcScreenSaver" under "Screen Saver".

3. Click on the "Settings" button. The "BbcScreenSaver" dialog box opens.

The following figure shows the dialog box using an example with two devices. A secondary device is optional and is not supported by all devices.

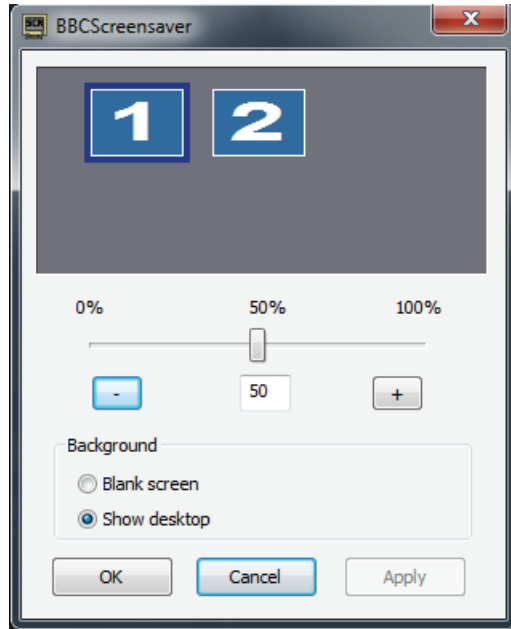

4. Set the desired brightness value for the activated display using the slider or the "-" and "+" buttons.

Note

The set value is retained following a restart and you can only change it in the "BBCScreenSaver" dialog box.

5. Under "Background" select from the following options:
 - "Blank screen": The desktop is shown with a black background.
 - "Show desktop": The desktop will be transparent.
6. Confirm the set values with "OK" or terminate the input with "Cancel" without saving the modified settings.

Note

If you set the value 0, the backlighting of all connected monitors is turned off.

8.3.9 CheckLanguageID

Scope

The following description applies for 32-bit Windows operating systems.

Call

"c:\drivers\checklang\checklangid.exe" or reinstallation from the "Documentation and Drivers" CD.

For Windows 7: Select Start > Programs > Siemens Automation > SIMATIC > IPC Wizard > CheckLangID

Function

"CheckLanguageID" displays the currently installed languages.

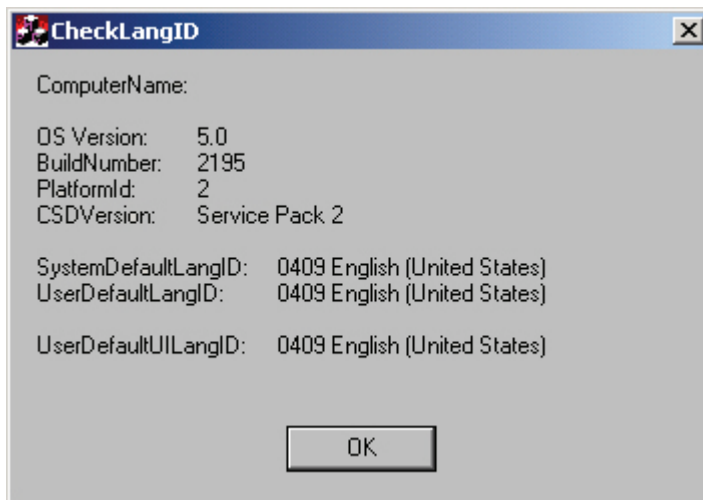

Figure 8-4 CheckLanguageID

- SystemDefaultLangID: System language
- UserDefaultLangID: Standard language
- UserDefaultUILangID: User interface language

Note

All three languages displayed should have the same ID assigned.

8.3.10 Multilingual settings for the operating system

Windows MultiLanguage MUI operating system enables users to set the language of the GUI to their individual preference. Some elements are not localized, however, and remain in the original language of the system - English.

You should therefore always install English language service packs. Further information about the language of the GUI, regional settings and inputs is available in the Internet at <http://support.microsoft.com>.

Setting up the language selection for Windows XP Professional

The Multilanguage User Interface (MUI) allows you to set up the Windows XP Professional menus and dialogs for additional languages.

The default setting on your device is Windows XP Professional MUI with English menus and dialog boxes and a US keyboard layout. You can change the language in the Control Panel.

"Start > Control Panel > Date, Time, Language, and Regional Options > Add other languages"
"Languages" tab, "Language used in menus and dialogs" field.

For the "Date, Time, Language, Regional Options" set the default as "non-Unicode programs" under "Advanced" in addition to the language for menus and dialogs.

Setting up the language selection in Windows 7

With the Windows 7 operating system the procedure for language selection is the same as with the Windows XP Professional.

8.3.11 USB keyboard controller

The USB keyboard controller must be installed before the following functions can be used:

- Keyboard programming with the "KeyTools" application
- Adjustment of the backlighting brightness with the application "SetBrightness."
- Control of the key LEDs

You can find details about the installation on the "Documentation and Drivers" CD.

Note on Windows 7: Installation is carried out via the IPC Wizard.

Operation

9.1 Status displays

PROFINET status display

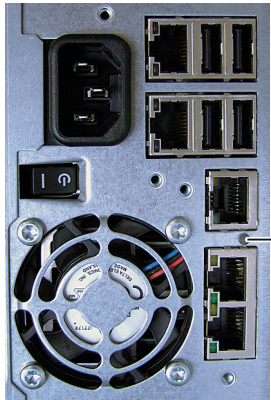
PROFINET status display			
			
Display	Meaning	LED	Description
SF PROFINET (optional)	Status display for CP 1616 onboard	OFF	<ul style="list-style-type: none"> CP not available CP disabled No error, communication established Download in progress
		Slow flashing	<ul style="list-style-type: none"> Link status error IO controller: IO device cannot be addressed IO controller: Duplicate IP address
		Fast flashing	Exception error: Diagnostics via Web or SNMP no longer possible
		AN	<ul style="list-style-type: none"> Diagnostic information available No communication established.

Virtual status displays			
The two "virtual" CP 1616 LEDs can only be seen in the SIMATIC software and can be scanned via SNMP.			
PROFINET	Virtual LEDs	RUN	CP is active
		STOP	CP is in the stop state
		Flashes	There are no "slow flashing" or "fast flashing" states.

9.2 Device with key panel

9.2.1 Safety

Note

Maloperation

If you activate several keys simultaneously, a malfunction on the device cannot be excluded. Activate function keys and softkeys only in sequence!

Malfunctions of the user software

For security reasons, always use "Security features" of the KeyTools. If you deactivate it nevertheless, serious malfunctions of the user software may occur when the additional function keys and softkeys F13 to S16 are used or if own key code tables are used.

Risk of damage

Activating a key using a hard or pointed object, for example a screwdriver, reduces the life of the key or can damage it.

9.2.2 Overview

Overview

The number of keys, their labeling and function is the same on all key panels. The various panel types differ in the arrangement of the keys and in the size and type of the display.

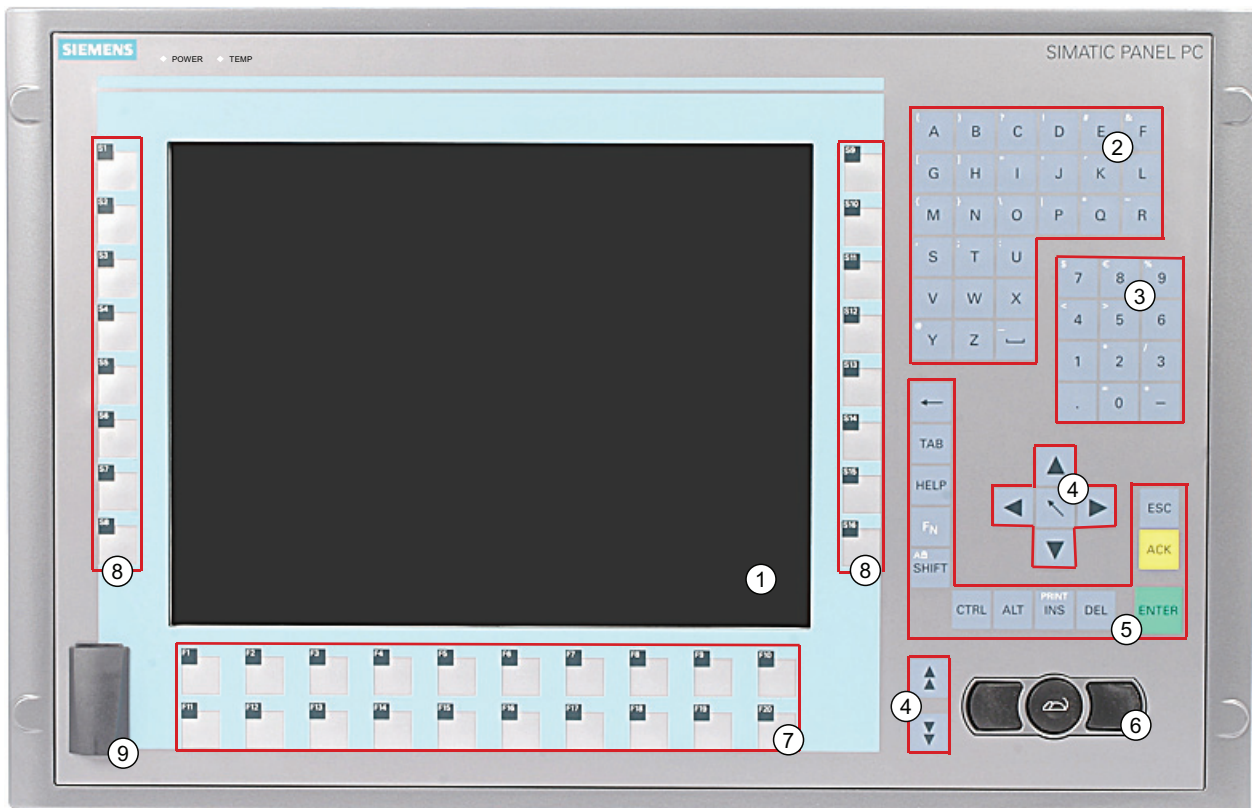

- (1) Display
- (2) Alphanumeric keys
- (3) Numeric keys
- (4) Control keys
- (5) Cursor keys
- (6) Integrated mouse
- (7) Function keys
- (8) Softkeys
- (9) USB ports (optional)

Figure 9-1 Example of a 12" key panel

9.2.3 Keys

9.2.3.1 Control keys

Control keys

The control keys activate editing functions and control functions in different applications:

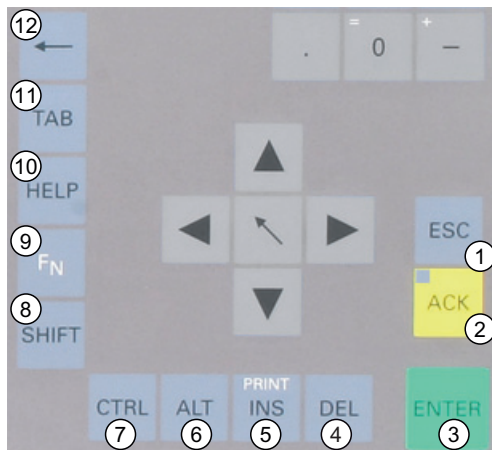

- (1) Cancel
- (2) Acknowledge
- (3) Enter
- (4) Delete
- (5) Insert/Print screen (in combination with FN)
- (6) Application-specific function key codes (see key code table in appendix)
- (7) Application-specific function key codes (see key code table in appendix)
- (8) Toggling between lower-case letters and upper-case letters
- (9) Function key
- (10) Call Help
- (11) Tabulator
- (12) Backspace

Figure 9-2 Control keys

9.2.3.2 Alphanumeric and numeric keys

Alphanumeric keys

Enter letters, special characters, blank spaces and underline using the alphanumeric keys.

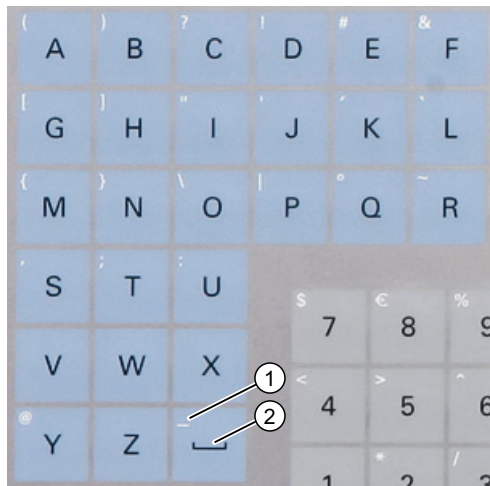

- (1) Underline
- (2) Space character

Figure 9-3 Alphanumeric keys 2

toggling between lower-case and upper-case letters

Enter the lower-case letters using the pre-defined assignment of the alphanumeric keys. To enter an upper-case letter, proceed as follows:

1. Hold down the <Shift> key.
2. Activate the desired alphanumeric key at the same time. The displayed upper case letter will be entered.
3. To enter lower case letters, release the <Shift> key.
4. You can, however, also activate the Caps Lock function using the <F_N> and <Shift> keys. The LED on the <Shift> key is then also lit.

Numeric keys

Enter the numerals "0" to "9" and special characters, e.g. the decimal point, using the pre-defined assignment of the numeric keys.

Enter special characters, arithmetic signs and signs

Special characters, arithmetic signs and signs are also assigned to most of the alphanumeric and numeric keys. These signs are indicated by white symbols on the top left of the keys. To enter such a sign, proceed as follows:

1. Hold down the <F_N> control key.
2. Activate the desired alphanumeric or numeric key at the same time. The displayed special character, arithmetic sign or signs will be entered.
3. To enter the signs of the pre-defined assignment again, release the <F_N> key.

9.2.3.3 Cursor keys

Navigate, scroll or move the writing mark using the cursor keys. The cursor keys correspond to the usual keys of the PC keyboard.



- (1) <Left> key
- (2) <Up> key
- (3) <Right> key
- (4) <Down> key
- (5) Position 1 key (Home)
- (6) <Page up> key
- (7) <Page down> key

Figure 9-4 Cursor keys

9.2.4 External keyboards

The keyboard layout has been set to "English/USA international." If you use a keyboard with a layout other than the "English/USA international" layout, the key codes of the internal and external keyboards might no longer correspond.

9.2.5 Labelling function keys and softkeys

Scope

This section applies only to control units with key panels.

Introduction

The control unit has two horizontal and two vertical keypads. Assign user specific functions to the keys as needed. Label the keys with labelling strips from the accessories.

Note

The device is supplied with a sheet of labeling strips.

 CAUTION
--

Labeling

Label the function keys and softkeys to conform with the project. Labeling without reference to a project leads to incorrect operations on the system to be observed.

Procedure

1. Label the DIN A4 film with a laser printer, for example, using the print format templates for MS Word on the "Documentation and Drivers" CD.
2. Cut the labeling strips along the pre-printed lines.

Note

Do not insert handwritten labeling strips until the ink has dried.

3. Insert the labeling strips into the slots provided from the rear side of the control unit.

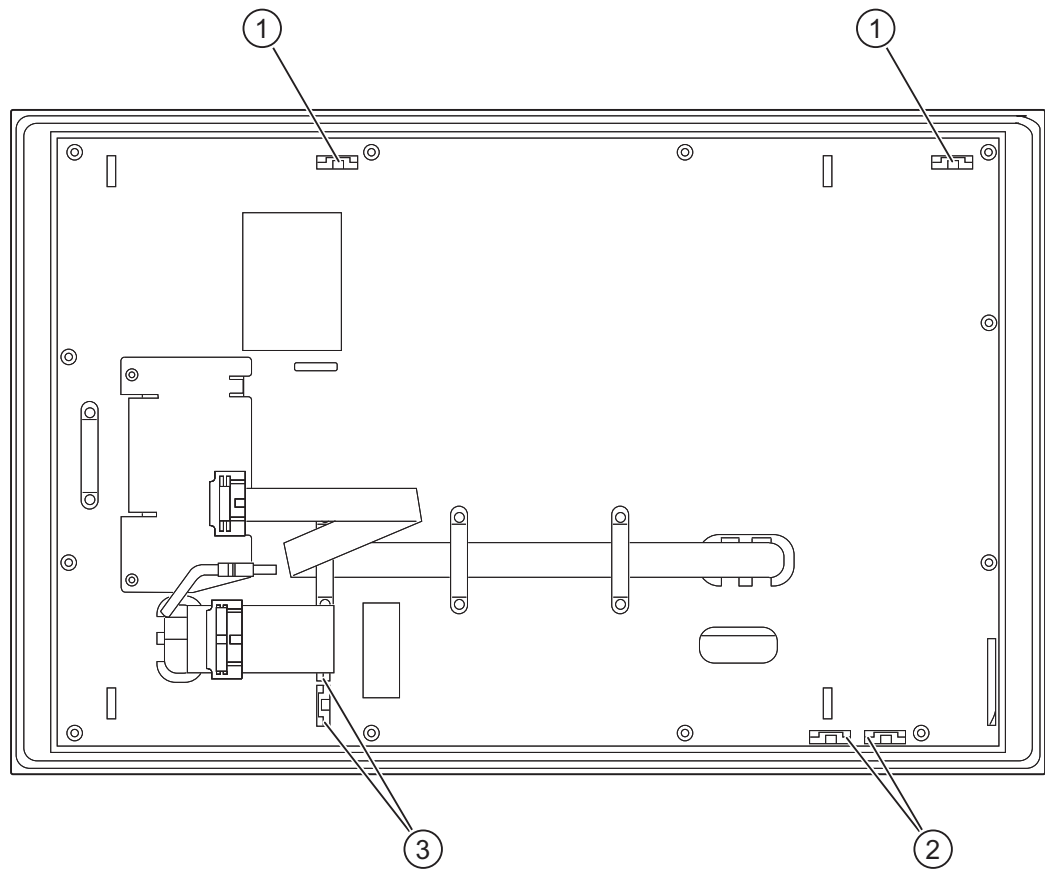

Figure 9-5 Rear of the control unit, using example of a 12" key panel.

Similar to illustration, can deviate from device

- (1) Slots for long labeling strips, vertical keypads
- (2) Slots for short labeling strips, horizontal keypads
- (3) Slots for labeling strips, horizontal keypads

9.2.6 Using the integrated mouse

The position on which you press the middle round button of the integrated mouse determines the direction in which the cursor moves. The amount of pressure determines the speed of the cursor.

Alternatively to using the integrated mouse you can also connect an external mouse to the front USB port.



Figure 9-6 Integrated mouse

9.3 Device with touch panel

The individual variants differ in their dimensions and size of the display.

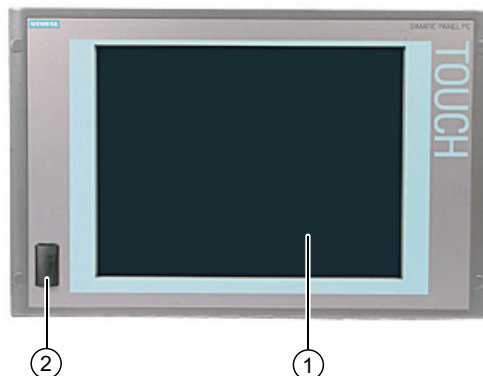

Figure 9-7 Example of a 15" touch panel

- (1) Display with touch panel
- (2) USB ports (optional)

9.3.1 Operating a touch panel

On the display that is touch-sensitive due to the touch sensor, application-specific user interface elements, for example buttons, are displayed. When you tap the command button with your finger, the function assigned to the button is activated.

The following types of pressure are permissible:

- Using a touch pen with a 1 mm radius at the point: 25 g.
- Using a silicone finger with a diameter of 1.6 cm: 50 g.

NOTICE
Only touch one point on the touch panel and not several points at one time. You may otherwise trigger unintended reactions.
Do not touch the screen in the following situations:
- During the booting process
- When plugging or unplugging USB components
- While Scandisk is running

NOTICE
Damage to device from incorrect operation
Operate the touch panel with a finger or an approved pen.
Never use hard or pointed objects.

Touch pen

A touch pen is available as an accessory.

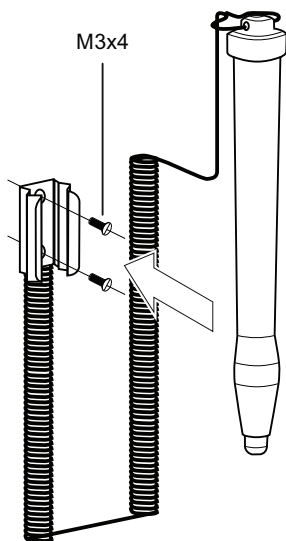

Figure 9-8 Touch pen

Dimensions	
Length	155 mm
Maximum diameter	20 mm

NOTICE
Damage to the keys
The touch pen is not appropriate for operating the keys.

Functions

10.1 Introduction

Functions

The basic version of the device already has the following display, monitoring and control functions:

- Temperature monitoring (over / under temperature)
- Watchdog (hardware or software reset of the computer)
- Monitoring of hard disks, CompactFlash cards and SSD drives with S.M.A.R.T. functionality
- Operating hours meter (information on the cumulative run time)
- Monitoring of the battery level
- AMT (Active Management Technology)

SIMATIC PC DiagBase software

With the SIMATIC PC DiagBase software (included in product package), you can use the display, monitoring and control functions. You use the "DiagBase Management Explorer" application for general monitoring and "DiagBase Alarm Manager" for notification of individual alarms.

the DMAPI programming interface for the DiagBase software is located on the DVCD "Documentation&Drivers" in the folder "\\Drivers\DiagBase\program files\Siemens\DiagnosticManagement".

You will find further information on the functions of the SIMATIC PC DiagBase software in the online help.

SIMATIC PC DiagMonitor software

The SIMATIC PC DiagMonitor software can be ordered on CD (does not ship with the product). It contains the networkable monitoring software, the software for the stations to be monitored and a library for creating custom applications.

AMT (Active Management Technology)

AMT is a technology from Intel for remote maintenance of computers. You turn an AMT PC on and off remotely and start the BIOS setup remotely. Different operating systems can be booted with ISO files.

10.2 Temperature monitoring

Temperature monitoring

The temperature is monitored at several locations of the device. Amongst others, one thermocouple monitors the processor temperature, another the temperature in the area near the power supply, and a third the air intake temperature next to the DVI port.

The following fault reactions are triggered if one of the temperature values exceeds the set temperature threshold:

Response	Option
Device and CPU fans are set to maximum speed.	None
The DiagBase or DiagMonitor software is enabled	None

Temperature errors do not occur under normal operation. If a temperature does occur, check for the following possible causes:

- Are the fan apertures covered?
- Is the fan functioning correctly?
- Is the ambient temperature within the specified range?
- Is the total output of the power supply within the specified limit?

The temperature error is retained in memory until temperatures have fallen below the thresholds and are reset by one of the following measures:

- Acknowledgment of the error message by the monitoring software
- Restart of the device

10.3 Watchdog (WD)

Function

The watchdog monitors IPC execution and reports a crash of the IPC to the user by means of various reactions.

The watchdog is idle when the PC is switched on or after a HW-RESET (cold restart), i.e., no reaction of the WD is triggered.

WD reactions

If the watchdog is not triggered again within the set time, the following reactions will be triggered:

Response	Option
WD acknowledgement	None
Trigger a PC reset	Selectable
The DiagBase or DiagMonitor software is enabled	None

WD monitoring times (TWD)

The monitoring times can be set in increments of one second within a range from 3 to 255 seconds.

Note

The watchdog is retriggered if the monitoring time is changed at the active watchdog (that is while the watchdog is running)!

10.4 Fan monitoring

The function monitors operation of the enclosure and power supply fans. When a fan fails, the following reactions are triggered:

Response	Option
The DiagBase or DiagMonitor software is enabled	None

The fan fault is retained in memory until the cause of the fan failure has been rectified and the error is reset by taking one of the following measures:

- Acknowledgment of the error message by the monitoring software
- Restart of the device

10.5 Status display

The status display consists of two 7-segment displays and two three-color LEDs.

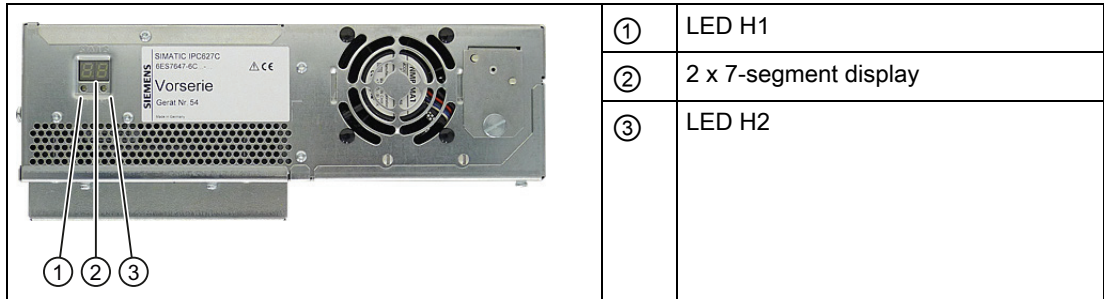

Function of the 7-segment displays

The POST codes of the respective test step are displayed during the startup of the BIOS. The POST code of the most recently started test step is displayed should an error occur. Code 00 is displayed when the startup is completed without error.

Application codes can also be displayed if required.

Function of the LED H1, H2

During the BIOS startup, the two LEDs light up in three colors (red, yellow and green) to test their operation. The two LEDs switch off when the startup is completed without errors.

Applications can trigger the two LEDs if required.

Note

You will find the programming interface and sample programs on the DVD "Documentation & Drivers" in the folder "Drivers\DiagBase\program files\Siemens\DiagnosticManagement".

10.6 SRAM buffer memory

In order for applications to store data following a power failure, the motherboard features battery-buffered SRAM. If the supply voltage fails for more than 20 ms for the AC power supply or more than 5 ms for the DC power supply, then you will be informed about this situation by the NAU signal.

At least 10 ms is available to copy the data to the buffered RAM. During this time, 128 Kb can be saved with a full load and even more with a smaller configuration, in other words, a lesser load. A maximum 2 MB memory window is displayed via a PCI address register. The base address is initialized by the BIOS.

A corresponding function is implemented there for using the SRAM under WinAC RTX.

Note

If replacement of the battery takes longer than 30 seconds, the data saved in the CMOS RAM and in the buffered SRAM is lost.

Note

The buffer memory SRAM is available only with devices with PROFIBUS or PROFINET interfaces.

10.7 Battery monitoring

The installed backup battery has a service life of 5 years. The status can be checked with two-tier battery monitoring. The information can be read from an I/O register and evaluated.

When the first warning level is reached, the remaining service life of the battery for buffering CMOS data amounts to at least 1 month.

10.8 Active Management Technology (AMT)

AMT (Active Management Technology) is technology for the remote maintenance of computers (simply called AMT-PC in the remainder of the document) and it includes the following functions:

- Keyboard–Video–Mouse (KVM) redirection: Using KVM that is integrated in the AMT hardware you access the AMT PC remotely. With KVM, you can also control AMT PCs that have no or a defective operating system. A KVM remote session is always possible with the KVM server integrated in the firmware. This means you can restart the PC and change the BIOS setup remotely.
- Remote power management: AMT PCs can be turned on and off and restarted from another PC.
- SOL (Serial over LAN): Redirection of the data of a serial interface to the network. The main use of the function is text-based remote control of an AMT PC using a console.
- IDE redirection: An ISO file on the help desk PC can be mounted on the AMT PC and used as a DVD drive.

An ISO file contains a memory image of the content of a CD or DVD structured in the ISO 9660 format.

- Remote reboot: An AMT PC can be booted from a bootable ISO file made available by another PC.

SIMATIC IPC Remote Manager

The "SIMATIC IPC Remote Manager" software is available for utilization of the AMT functions with SIMATIC IPCs. The software can be ordered from the Siemens online ordering system. For detailed information about "SIMATIC IPC Remote Manager", refer to the corresponding product documentation.

Typical areas of application and functions of the SIMATIC IPC Remote Manager:

- Remote maintenance of SIMATIC IPC with AMT, for example for service purposes in the case of a defective operating system or for adapting BIOS settings.
- Diagnostics without on-site use
- Convenient service: Access to AMT clients, such as headless systems, without additional hardware
- Resource management

Requirement

- A device with a Core i5 or Core i7 processor
- A functioning and configured management engine
- A functioning and configured Ethernet connection
- A help desk PC with a functioning and configured Ethernet connection for the full AMT functionality

Configuration of the AMT PC

You configure AMT using the BIOS setup and the MEBx (Management Engine BIOS Extension). MEBx is a BIOS extension for configuring AMT.

When the BIOS appears briefly during startup, press the <Ctrl+P> keyboard shortcut. The "MEBx" dialog opens.

Service and maintenance

11.1 Maintenance

Scope of maintenance

The device is largely maintenance-free. If the functioning of components, such as the backup battery, has been impaired after a limited period of operation, they must be replaced. Please see the relevant chapters of these operating instructions for detailed information.

When working in areas where there is dust that may be hazardous to functionality, the device must be operated in a control cabinet with a heat exchanger or with suitable supply air.

Note

Dust deposits must be removed at regular intervals.

Maximum dust content in the air circulating in the cabinet	
Suspended component	0.2 mg/m ³
Deposits	1.5 mg/m ³ /h

Repairs

Only authorized personnel are permitted to repair the device.

 WARNING
Unauthorized opening of and improper repairs to the device may result in substantial damage to equipment or risk of personal injury to the user.

Cleaning agents

Use dish soap or foaming screen cleaner only as cleaning agents for the front.

The rear side of the operator unit and the housing of the computer unit must only be dry-cleaned.

NOTICE
Do not clean the device with aggressive solvents or scrubbing agents or with pressurized air or steam cleaner.

Procedure for cleaning the device (front)

1. Switch off the device. This prevents the accidental triggering of functions when the front is touched.
2. Dampen the cleaning cloth.
3. Spray the cleaning agent on the cloth and not directly on the device.
4. Clean the device with the cleaning cloth.

Resistance to chemicals

NOTICE
Adhere to the information regarding chemical resistance of the panel front. Additional information can be found on the Internet (http://support.automation.siemens.com/WW/view/en/22591016).

11.2 Maintenance and care of devices with stainless steel front

Scope of maintenance

The device is designed for low-maintenance operation. You should nonetheless clean the screen and the control panel at regular intervals. These measures and proper handling of the device increase the useful life of the front membrane and of the stainless steel front.

General information on cleaning

NOTICE
Do not clean the device using aggressive cleaners or detergents, greasing or abrasive detergents, concentrated acids or caustic solutions, leather, scratching or rough rags or other objects. For further information, refer to the section "Resistance to chemicals." Do not clean the device with chlorine or chloride, for example, active chlorine, with laser or ultrasonic equipment, or with dry ice. You will damage the control panel if you clean it with high pressure equipment. If you thermally disinfect the device, for example, using hot steam equipment, you will damage the control panel and, in particular, the touch sensor.

The front panel is protected in accordance with the degree of protection against the ingress of water which is directed towards the device at a defined jet force.

Observe the permitted ambient temperatures. For additional information, refer to the chapters:

- Planning the use (Page 25), section "Mounting positions and fastening (Page 28)"
- Technical data (Page 175), section "General specifications (Page 175)"

Cleaning the front membrane

Clean the front membrane using the equipment described below:

- Soft, non-abrasive window wipers or a soft, clean rag
- Rubber window wipers
- Liquid glass cleaners
- Kitchen or household paper

Additional information is available in the section "Chemical resistance of stainless steel fronts (Page 116)".

Cleaning the stainless steel front

For information, refer to the section "Handling of stainless steel surfaces."

Procedure

⚠ WARNING

Always switch off the device before you clean the front panel, or set it to a defined state, for example, by activating a clean screen. This avoids the risk of triggering unwanted functions when you touch the screen or when a water jet contacts the screen.

NOTICE

Do not rub the front membrane when it is dry.
Make sure that foodstuff does not splash back into the production process.
Follow the general cleaning guidelines.

1. Switch off the device. When the system is in operation, you can also activate a clean screen on the touch screen.
2. Always dilute glass cleaners with water before you apply these. Use clean water.
3. Use a window wiper or a cloth to wipe off the front membrane. Work from top to bottom. Rinse off the dirt particles when doing so.
4. Rinse the window wiper or cloth several times.
5. Clean the edges with a cloth or household paper.
6. Moisten the front membrane once again.
7. Remove the moisture with the window wiper, working from top to bottom and without leaving any streaks. After each pass, wipe off the window wiper with soft household paper. Wipe off any water accumulating on the bottom edge of the front membrane using soft household paper.

11.3 Chemical resistance of stainless steel fronts

8. Wipe off the edges using household paper.
9. Clean the stainless steel surface with a neutral, alkaline cleaner or, if necessary, with a caustic cleaner which does not contain active chlorine. Additional information is available in the section "Handling of stainless steel surfaces (Page 116)".

11.3 Chemical resistance of stainless steel fronts

Front membrane

The resistance of the front membrane to various chemicals was tested to DIN 42 115, section 2. The front membrane is resistant to the chemicals listed below:

- Alcohol
- Diluted acids
- Diluted caustic solutions
- Ester
- Hydrocarbons
- Household cleaners

11.4 Handling of stainless steel surfaces

Resistance

Information on the resistance of stainless steel:

- The stainless steel surface is not fully resistant to the chemicals listed below:
 - Hydrochloric acid
 - Sulphuric acid
 - Caustic soda
 - Chlorine
 - Chloride

Do not clean the stainless steel surface with these chemicals or with similar acids or caustic solutions.

- Acid steam develops, for example, when tiles are cleaned with hydrochloric acid, and is also harmful to the stainless steel. If the stainless steel parts are unintentionally contaminated with hydrochloric acid, rinse these off immediately with plenty of water.
- Clean the stainless steel surface with a neutral, alkaline cleaner or, if necessary, with a caustic cleaner which does not contain active chlorine.

Cleaning guidelines

Further information on stainless steel surfaces:

- The surface should be properly ventilated.
- Keep the surface clean. Remove cleaners and food residue immediately. Make sure that foodstuff does not splash back into the production process.
- If mechanical cleaning is necessary, do not use cleaning equipment made of metal.
 - Use brushes made of plastic or natural materials, or a microfiber pad.
 - Use plenty of water to clean the surface.
 - Remove cleaners without leaving any residue, including corners and confined areas.
- Make sure surface is not damaged: Do not damage the device during operation, or by cleaning or repairing it using hard objects, in particular objects made of non-stainless steel material.
- Avoid contact of the surface with corrosive parts: Extraneous rust from water lines, file chips, residue of wire brushes or steel wool and rust films have a corrosive effect on parts made of stainless steel.
 - Remove any stains or extraneous rust immediately.
 - Remove new rust spots with a mild abrasive detergent in order to prevent any further corrosion.
 - Rinse the part thoroughly after you cleaned it.

11.5 Spare parts

Use only Siemens spare parts or spare parts released by Siemens, otherwise the warranty, CE declaration of conformity and UL approval will be invalidated.

Fronts

Front type	Description	Front USB	Order number
12" TFT, keys	PANEL 12K 677/877 ROHS	Yes	6AV7672-1AB01-0AA0
	PANEL 12K 677/877 W/O USB ROHS	No *)	6AV7672-1AB11-0AA0
12" TFT, touch	PANEL 12T 677B/C	Yes	6AV7672-1AA01-0AA2
	PANEL 12T 677B/C W/O USB	No *)	6AV7672-1AA11-0AA2
15" TFT, keys	PANEL 15K 677/877 ROHS	Yes	6AV7672-1AD01-0AA0
	PANEL 15K 677/877 W/O USB ROHS	No *)	6AV7672-1AD11-0AA0
15" TFT, touch	PANEL 15T 677 B INOX ROHS	Yes	6AV7672-1AC22-2AA0
	PANEL 15T 677B/C	Yes	6AV7672-1AC01-0AA2
	PANEL 15T 677B/C W/O USB	No *)	6AV7672-1AC11-0AA2
19" TFT, touch	PANEL 19T 677B/C	Yes	6AV7672-1AE01-0AA2
	PANEL 19T 677B/C W/O USB	No *)	6AV7672-1AE11-0AA2
	PANEL 19T 677B/C ATEX22 Hazloc	No	6AV7672-1AE01-1AA2

*) For more information, refer to the chapter "Description".

Miscellaneous spare parts

Replacement part	Order number
Set of clamps	6FC5248-0AF06-0AA0
Plastic cap USB port, set with 10 pieces	6AV7672-1JA00-0AA0
Lithium battery	A5E00331143

11.6 Separating the control unit from the computer unit

The control unit is separated from the computer unit to carry out repairs or to replace the control unit, for example.

Procedure

1. Disconnect the device from the mains.
2. Open the switchgear cabinet. The device is now accessible from the back.
3. To swing away the computer unit (1): Loosen the four knurled screws (2) which attach the computer unit to the rear of the control unit (3).

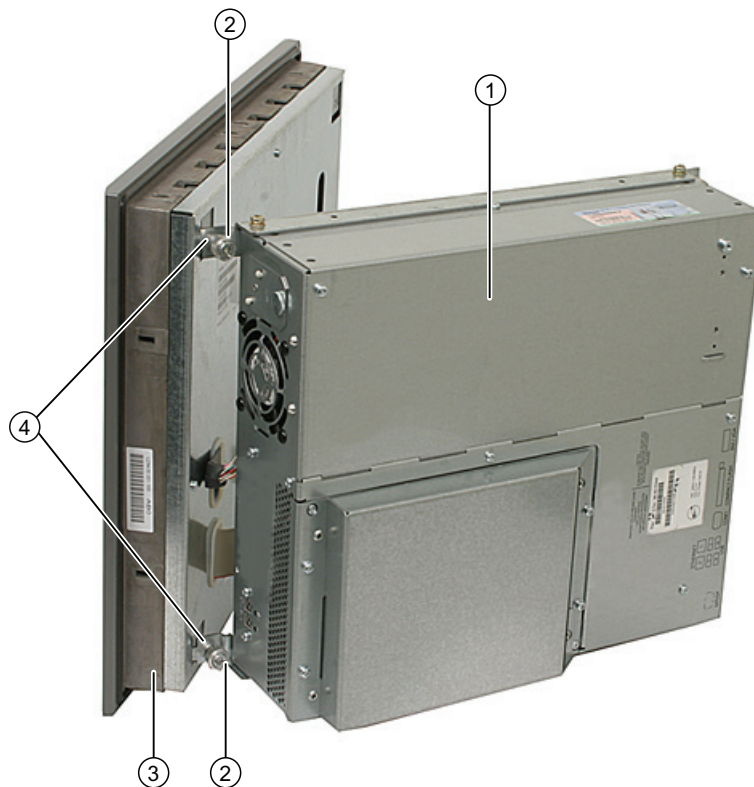

Figure 11-1 Separating the control unit from the computer unit

4. Swing the computer unit (1) away. The connectors on the back of the control unit (3) are now accessible.
5. Loosen cables and the USB cable between the computer unit and the control unit
6. Two mounting rails are screwed onto the computer unit whose angled clips (4) are located in the corresponding recesses in the computer unit. Lift the computer unit vertically out of these recesses

11.6 Separating the control unit from the computer unit

7. Put the computer unit down carefully.
8. If required, remove the control unit as follows:
 - Screw mounting: Secure the control unit against falling out and unscrew it.
 - Clamp fastening: Remove the clamps that secure the control unit to the mounting wall.

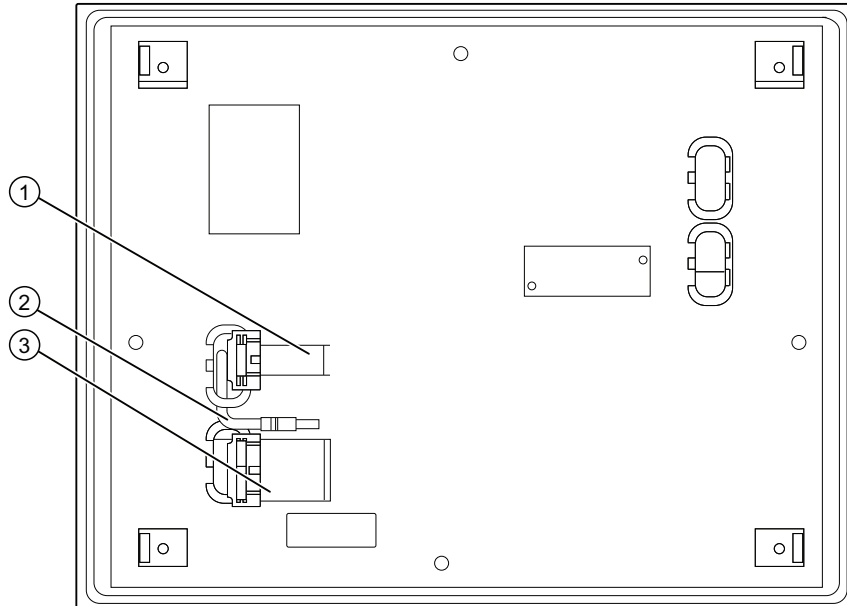

Figure 11-2 Other ports on the computer unit

Similar to illustration, can deviate from device

- (1) Display cable (for touch panels > 15", 2 pieces)
- (2) USB cable
- (3) IO USB cable

Separating the device in an uninstalled state

As an alternative, dismount the device completely and separate the control unit and computer unit from one another in an uninstalled state. So that the processing unit, which is swung away from the control unit, does not bend the lugs (4), place a surface under the processing unit.

Mounting operator control unit on computer unit

To mount the operator control unit on the computer unit, perform the steps in reverse:

NOTICE

When you swing the control unit and processing unit together, make sure that the flatband cables are correctly folded together and do not get squished.

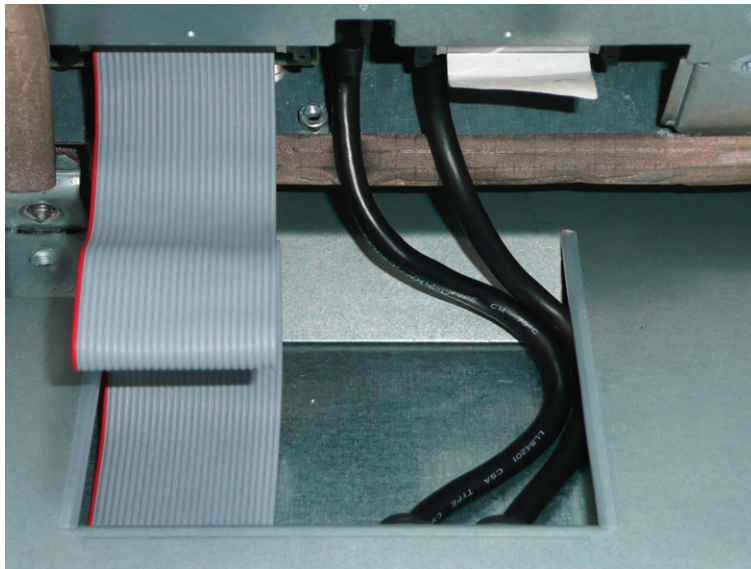

11.7 Expansion and parameter assignment

11.7.1 Opening the Device

NOTICE

Work on the open device may only be carried out by authorized and qualified personnel. Within the warranty time, you are only allowed to install expansions for memory and expansion card modules.

CAUTION

The device contains electronic components which may be destroyed by electrostatic charge.

You therefore need to take precautionary measures before you open the device. Refer to the ESD guidelines on handling electrostatically sensitive components (Page 260).

Tools

You can perform all installation tasks on the device using Torx T6, T10, T15 and T20 screwdrivers.

Preparation

Disconnect the device from the mains.

Disclaimer of liability

All technical data and approvals apply only to expansion units which are released by SIEMENS.

Siemens disclaims any liability for impairment of functions caused by the use of third-party devices or components.

Observe the installation instructions for the components. UL approval of the device only applies when the UL-approved components are used according to their "Conditions of Acceptability".

Procedure

Steps for opening the device	
1	Remove the screws ①.
2	Swing the cover up and remove it.

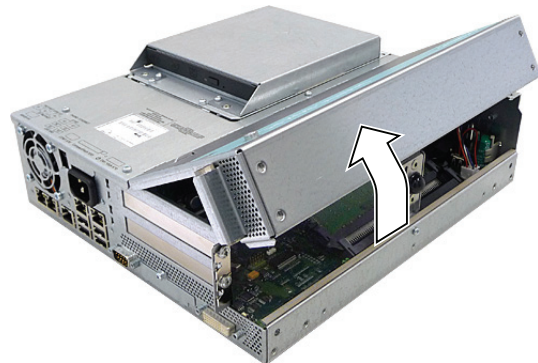
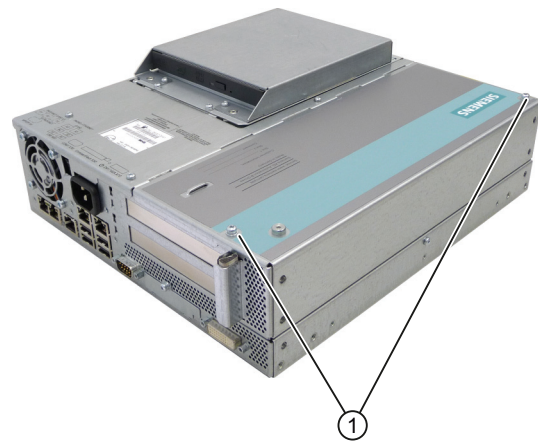

11.7.2 Memory expansion

11.7.2.1 Removing/Installing Memory Module

Memory expansion options

The motherboard is equipped with 2 slots for memory modules. For 184-pin DDR3 RAM chips, unbuffered, without/with ECC. This allows you to expand device memory up to 4 GB, of which you can use approx. 3.2 GB for the operating system and applications. You can install one or two modules.

Combination	Slot X19	Slot X20	Maximum expansion
1	1 GB / 2GB / 4 GB		4 GB
2	1 GB / 2GB / 4 GB	1 GB / 2GB / 4 GB	8 GB

Note

The modules can be installed in any slot.

Preparation

Disconnect the device from mains and unplug all cables.

NOTICE

The electronic components on the PCBs are highly sensitive to electrostatic discharge. Always take appropriate precautionary measures when handling these components. Refer to the ESD directives on handling electrostatic sensitive components.

Note

We highly recommend using memory modules approved by Siemens. Siemens disclaims any liability for impairment of functions caused by the use of third-party memory modules.

Installing a memory module

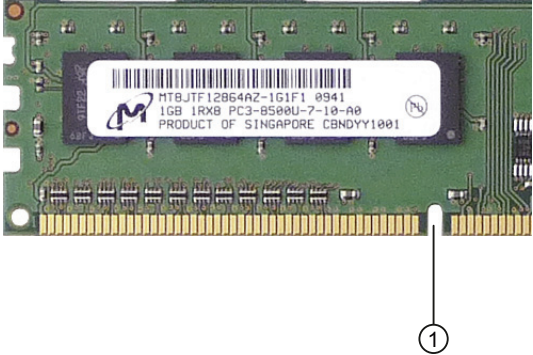
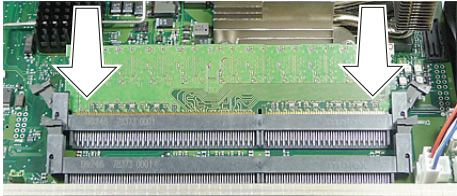
How to install a memory module	
1	Open the device (Page 121).
2	Note where the (polarized) cutout ① is located on the pin side of the RAM module before inserting it. 
3	Insert the module downwards, applying slight pressure and press it until the locking snaps into place. 
4	Close the device.

Removing a memory module

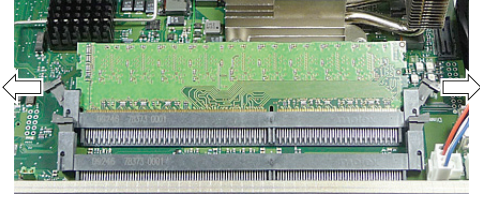
How to remove a memory module	
1	Open the device (Page 121).
2	Release the locking mechanism on the left and right. 
3	Pull the memory module out of the slot.
4	Close the device.

Display of the current memory configuration

A new memory module is automatically detected. When switching on the device and starting the BIOS Setup using <F2>, the current memory size is displayed under "Total Memory".

11.7.3 Installing PCI/PCIe cards

11.7.3.1 Notes on the modules

The device is designed for use with modules conforming to PCI specifications V 2.2. 5 V 32-bit PCI modules, universal (5 V & 3.3 V) 32-bit PCI modules and PCI Express x16 modules can be operated. The permitted module dimensions are specified in the section Dimensional drawings for the installation of expansion modules (Page 193).

11.7.3.2 Installing / removing expansion modules

Preparation

Disconnect the device from the mains.

Installing expansion modules

How to install an expansion module (PCI / PCI express card):	
1	Open the device (Page 121).
2	Loosen the fastening screw ④ and remove the module bracket ⑤.
3	Remove the slot cover ① from the intended slot.
4	Insert expansion module ② into the slot provided. Observe the guide rail ⑥ with long PCI modules.
5	Mount the module bracket and insert the slider ③.
6	Fasten the slot cover ① of the expansion module.
7	Close the device.

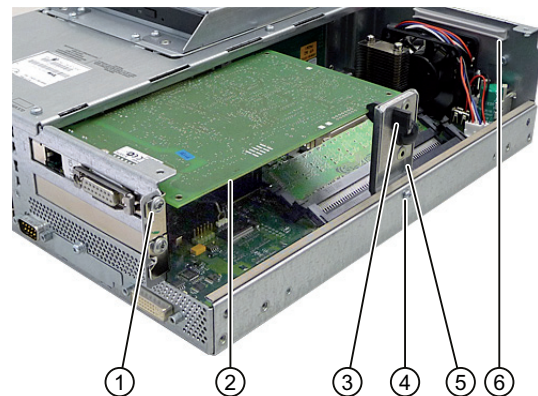

Inserting the slider

Proceed as follows when using the slider:

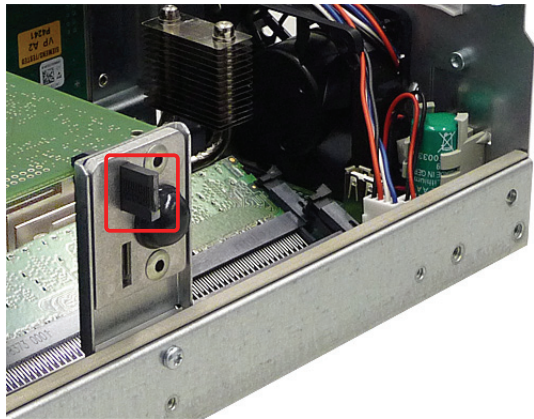
How to install a slider		
1	<p>Push the slider through the guide slot until it is seated firmly on the module. Insert the module into the slot.</p>	

NOTICE	
<p>Do not put pressure on the module! Do not apply excessive force on the slider when you push it onto the module.</p>	

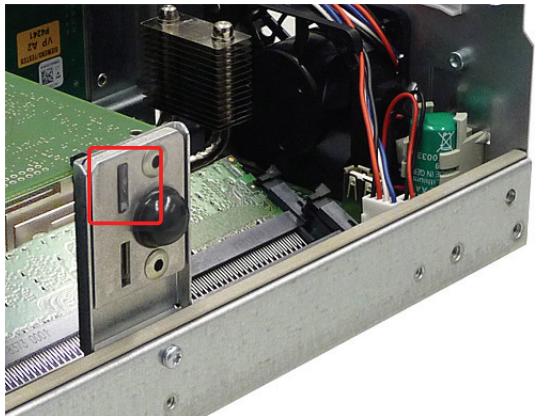
2	<p>Cut off the rest of the slider element: Use a knife to apply a cut on the slider at the upper edge of the bracket and then break this section off. Cut off the residual element using a side cutter.</p>	
---	---	--

Notes on the allocation of resources

The two slots for the PCI cards each have an exclusive interrupt. Information on the assignment of the PCI IRQ line to the PCI slot is available in the BIOS setup, "Advanced menu" section, and in the detailed descriptions of the "Bus board" section.

11.7.4 Installing drives

11.7.4.1 Options of installing disk drives

Drive bay module for hard disk drives and optical drives

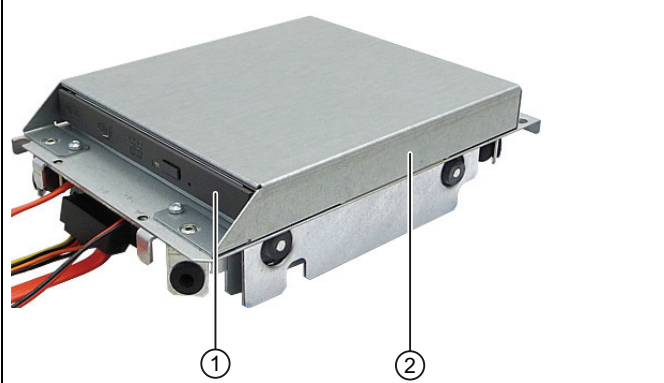
DVD burner drive bay mount	Item	Description
	①	Slot for DVD burner drive
	②	DVD burner drive bay mount

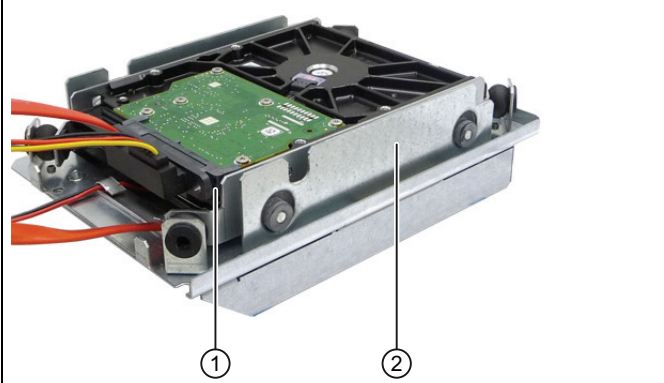
A 3.5" hard disk drive	Item	Description
	①	Slot for one 3.5" drive
	②	Hard disk drive bay for one 3.5" drive

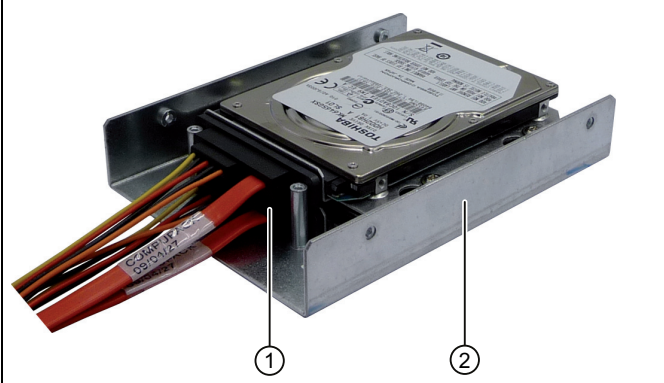
Two 2.5" hard disks	Item	Description
	①	Two slots for 2.5" hard disks
	②	Hard disk drive bay for 2.5" hard disks

11.7.4.2 Installing/removing a drive bay module

Preparations

Isolate the device from mains and disconnect all connection cables.

Removing a drive bay module for hard disks and optical drives

Steps for removing the drive bay	
1	Remove the four screws ①.
2	Lift out the drive bay module for hard disks and the optical drive.



11.7.4.3 Removing / installing an optical drive

Preparations

Isolate the device from mains and disconnect all connection cables.

Required tools

You need the following screwdrivers to remove the the DVD burner:

- Torx T10 to mount/remove the drive bay
- Torx T6 to install/remove the drive

Removing the DVD burner drive

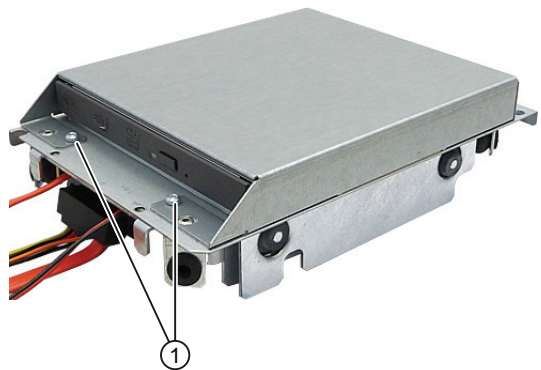
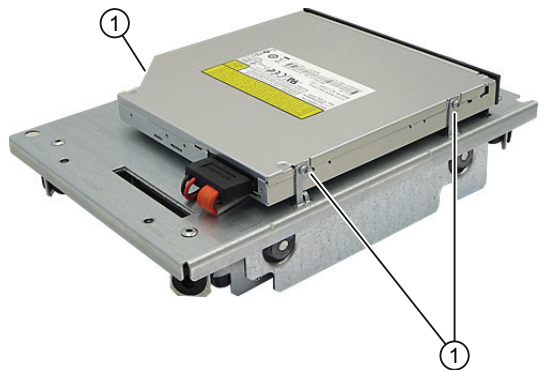
How to remove a DVD burner drive		
1	Remove the drive bay module.	
2	Loosen the screws ① on the DVD burner drive bay.	
3	Remove the retaining screws ① of the drive.	
4	Disconnect the power supply and the data cable from the drive.	
5	Lift the drive out.	

11.7.4.4 Installing / removing hard disks

Removing 2.5" drives

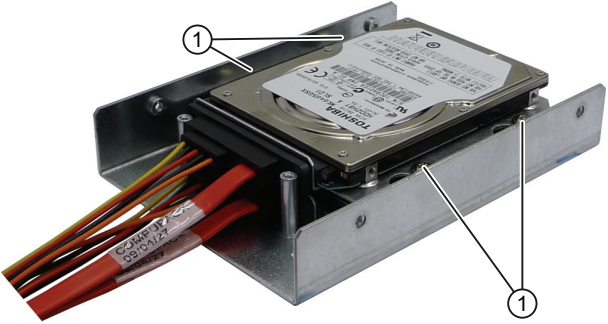
How to remove a 2.5" drive		
1	Remove the drive bay module.	
2	Unscrew ① the drive.	
3	Remove the hard disk drive and the steel mounting bracket from the bay.	
4	Disconnect the power supply and the data cable from the drive.	

Removing a 3.5" drive

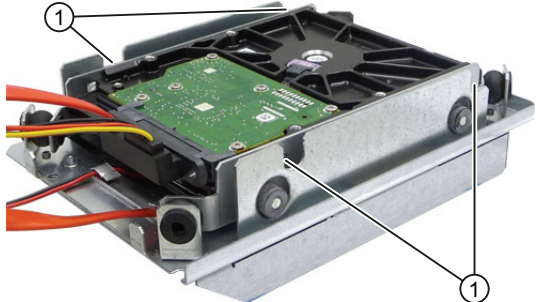
How to remove a 3.5" drive		
1	Remove the drive bay module.	
2	Disconnect the power supply and the data cable from the drive.	
3	Remove the screws ① of the drive.	
4	Remove the hard disk drive from the bay.	

Note

Note that special screws with inch threads (screw designation 6-32x3/16"-St-G3E) are used.

11.7.4.5 Removing/installing an SSD drive

Preparation

Disconnect the device from the mains.

Note

The use of the SSD drive excludes the simultaneous use of a hard disk.

Installing an SSD drive

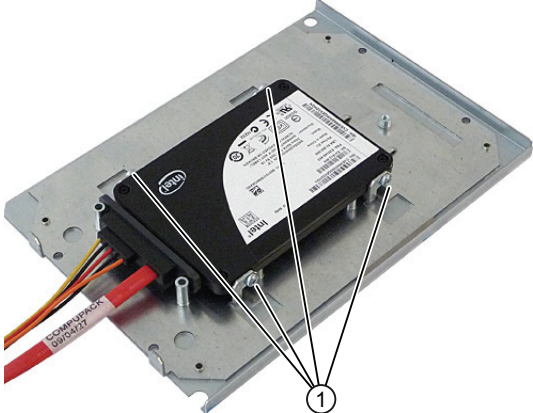
How to install the SSD drive	
<p>1 Remove the hard disk cover and place it on the device.</p>	
<p>2 Connect the power supply cable and the data cable to the SSD drive. Fasten the SSD drive with four (4) screws ①.</p>	
<p>4 Mount the hard disk cover.</p>	

11.7.5 Installing/removing an on-board Compact Flash card

Note

We highly recommend that use use approved SIMATIC Compact Flash cards. Siemens disclaims any liability for impairment of functions caused by the use of third-party cards.

Memory expansion options

The device features a slot for Compact Flash cards types I / II.

Note

This slot is not hot-plug capable. The Compact Flash card must be installed before the PC is switched on and should only be removed when the device is switched off.

Preparation

Disconnect the device from the mains.

 **CAUTION**

The electronic components on the PCBs are highly sensitive to electrostatic discharge. Always take appropriate precautionary measures when handling these components. Refer to the ESD directives on handling electrostatic sensitive components (Page 260).

Opening the board slot

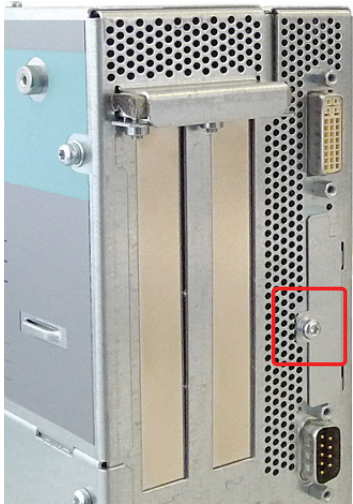
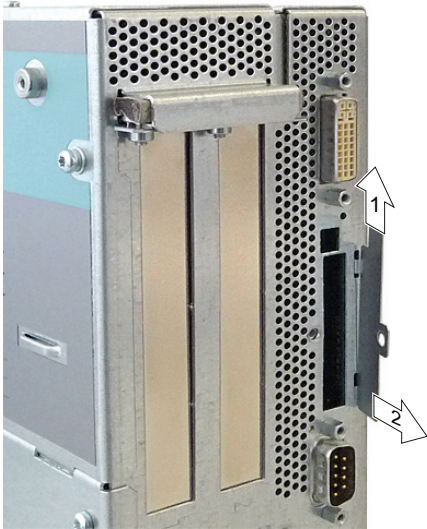
How to install a Compact Flash card	
1 Remove the screws.	
2 Slide the cover plate of the module slot towards the DVI connection and lift it out.	

Installing the Compact Flash card

How to install a Compact Flash card	
1	Open the board slot.
2	Insert the Compact Flash card in the slot with the connector facing in until it locks into place.
	
3	Open the module slot.

Note

The Compact Flash slot is coded against reversed insertion. Insert the Compact Flash card so that its label side is facing the front panel of the PC.

NOTICE

If the Compact Flash card meets resistance, flip it over. Never insert the Compact Flash card with force.

Removing the Compact Flash card

How to remove a Compact Flash card	
1	Open the board slot.
2	Press the eject button, for example with the cover of the module slot, and remove the Compact Flash card.
	
3	Open the module slot.

11.7.6 Installing/removing an additional Compact Flash card

Note

We highly recommend that use approved SIMATIC Compact Flash cards. Siemens disclaims any liability for impairment of functions caused by the use of third-party cards.

Preparation

Disconnect the device from the mains.

Note

The use of the Compact Flash adapter excludes the simultaneous use of a hard disk.

Installing the additional Compact Flash card

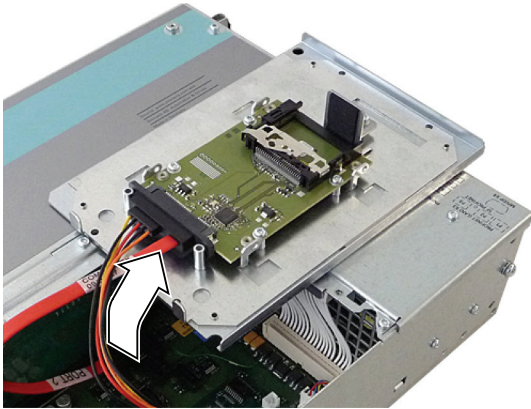
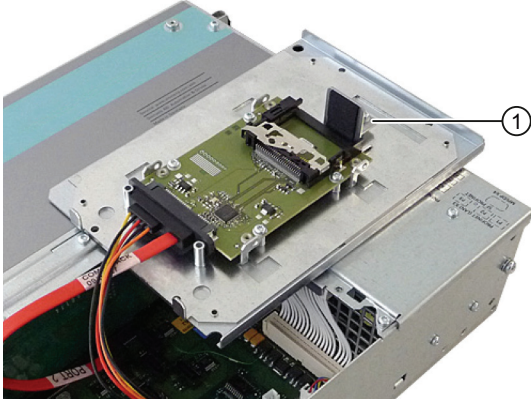
How to install the Compact Flash card in the Compact Flash adapter	
<p>1 Remove the hard disk cover.</p>	 <p>The image shows a Siemens industrial device with its hard disk cover removed. Three screws are indicated by lines pointing to a circled '1' at the bottom, which are the screws to be removed in the next step.</p>
<p>2 Lift out the Compact Flash adapter module and lay it on the device.</p>	 <p>The image shows the Compact Flash adapter module being lifted out of the device. A white arrow points to the module, indicating the direction of removal.</p>
<p>3 Remove the screws ① and remove the CompactFlash latch.</p>	 <p>The image shows the Compact Flash adapter module with two screws, labeled with a circled '1', being removed. A latch is also visible on the module.</p>

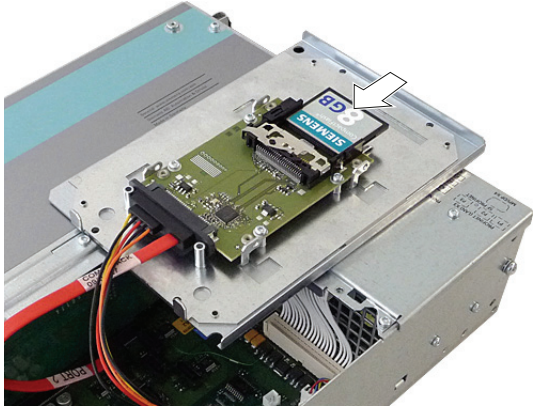
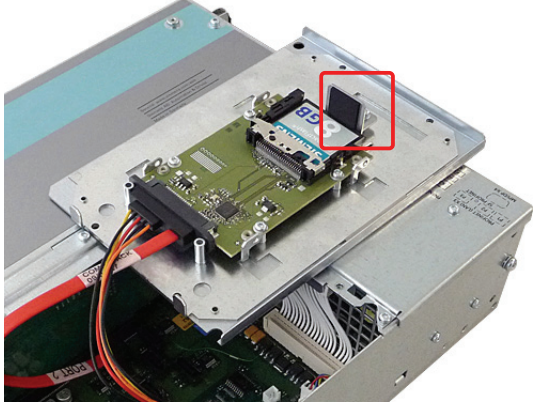
How to install the Compact Flash card in the Compact Flash adapter	
<p>4 Insert the Compact Flash card in the adapter with the connector facing in until it locks into place.</p>	
<p>5 Close the Compact Flash latch.</p>	
<p>6 Mount the hard disk cover.</p>	

11.8 Removing and installing hardware components

11.8.1 Repairs

Repairing components

Only authorized personnel are permitted to repair the device.

⚠ WARNING

Unauthorized opening and improper repairs may lead to material damage and hazards to users.

11.8 Removing and installing hardware components

- Always disconnect the power connector before you open the device.
- Install only system expansions which are designed for this computer. The installation of other expansions can damage the system and violate the radio-interference suppression regulations. Contact Technical Support or your local sales department to find out which system expansions are suitable for installation.

If you install or exchange system expansions and damage your device, the warranty becomes void.

Note

Observe the ESD instructions (Page 260).

Disclaimer of liability

All technical data and approvals apply only to expansion units which are released by SIEMENS.

Siemens disclaims any liability for impairment of functions caused by the use of third-party devices or components.

Tools

You can perform all installation tasks on the device using Torx T6, T10, T15 and T20 screwdrivers.

11.8.2 Preventive maintenance

To maintain high system availability, we recommend the preventative replacement of those PC components that are subject to wear. The table below indicates the intervals for this replacement.

Component	Replacement interval:
HDD	3 years
Fan	3 years
CMOS backup battery	5 years

11.8.3 Replacing the Backup Battery

Note

Batteries are wearing parts and should be replaced every 5 years to ensure proper functioning of the PC.

To be noted before you replace the battery**NOTICE**

Risk of damage!

The lithium battery may only be replaced with an identical battery or with a type recommended by the manufacturer (Order No.: A5E00331143).

 WARNING

Risk of explosion and release of harmful substances!

For this reason, do not burn lithium batteries, do not solder on the cell body, do not open, do not short circuit, do not reverse polarity, do not heat above 100°C, dispose of correctly, and protect against direct sunlight, dampness and dew.

Disposal**NOTICE**

Batteries must be disposed of in accordance with local regulations.

Preparation**Note**

For the BIOS setting "Profile: Standard" the configuration data of the device is deleted when the battery replacement takes more than 30 seconds.

For the BIOS setting "Profile: User" the configuration data of the device is retained; only the date and time has to be reconfigured.



The content of the SRAM is lost if the battery replacement takes more than 30 seconds.

1. Note down the current settings of the BIOS Setup.
A list in which you can note down this information is found in the BIOS manual.
2. Isolate the device from mains and disconnect all connection cables.

Note

You can also replace the battery while the device is running; do not touch anything with the device in this case. We recommend switching off the device beforehand.

Replacing the battery

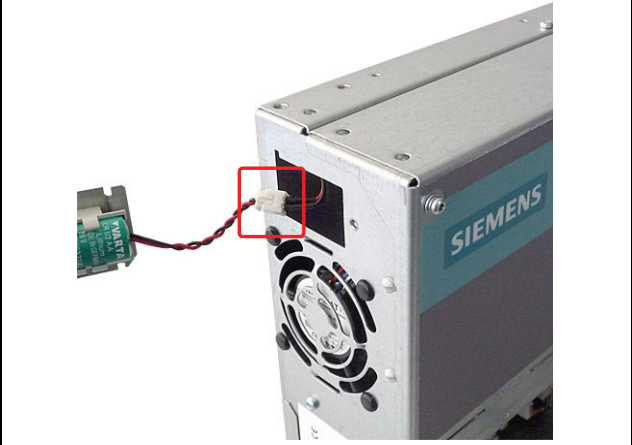
Steps for replacing the battery		
1	Open the battery compartment.	
2	Remove the battery holder.	
3	Detach the cable.	
4	Remove the old battery.	
5	Fasten the new battery and reinsert the battery holder.	
6	Close the battery compartment.	

Reconfiguring the BIOS setup

If the battery replacement took longer than 30 seconds, the CMOS configuration data of the device will have been deleted and you will need to reconfigure this in the BIOS Setup. If you use the BIOS profile "User", you do not need to make any new settings.

11.8.4 Removing/Installing the Power Supply

 WARNING
Only authorized trained personnel are allowed to replace the power supply unit.

Preparations

1. Isolate the device from mains and disconnect all connection cables.
2. Open the device (Page 121).

Removing the power supply unit

How to remove the power supply module	
1	Remove the drive bay module for the hard disk and DVD burner.
2	Loosen the screws ① and remove the power supply cover.
3	Remove the screws ① (Torx T10).

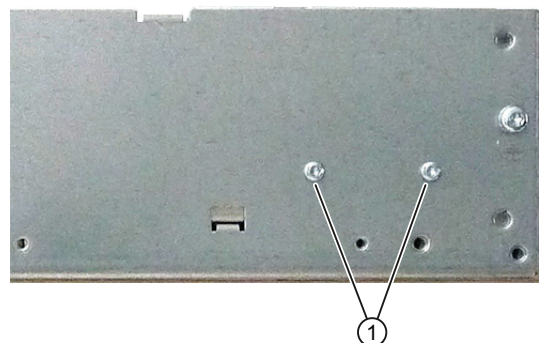
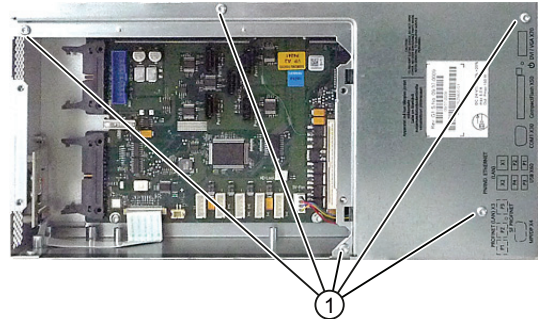

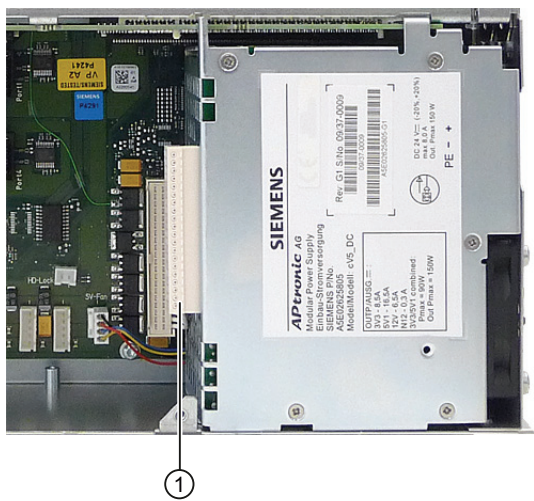
How to remove the power supply module	
4	Detach the power plug ① from the power supply module.
	
6	Lift out the power supply module.

11.8.5 Installing / removing the bus board

Preparation

1. Isolate the device from mains and disconnect all connection cables.
2. Open the device (Page 121).

Removing the bus board

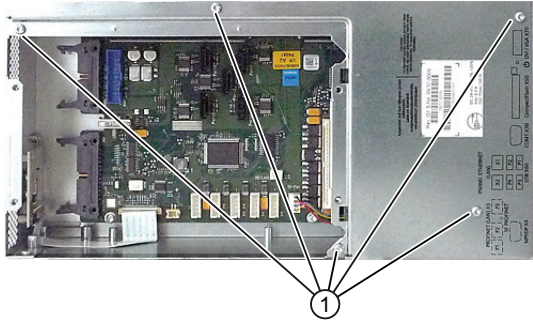
How to remove the bus board	
1	Remove all modules from the slots.
2	Lift out the drive bay module for hard disks and the DVD burner.
3	Loosen the screws ① and remove the power supply cover.
	
4	Remove the power supply.

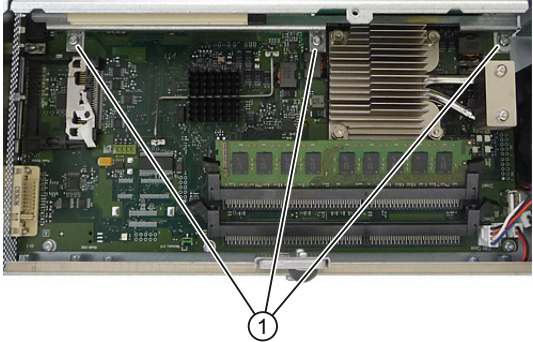
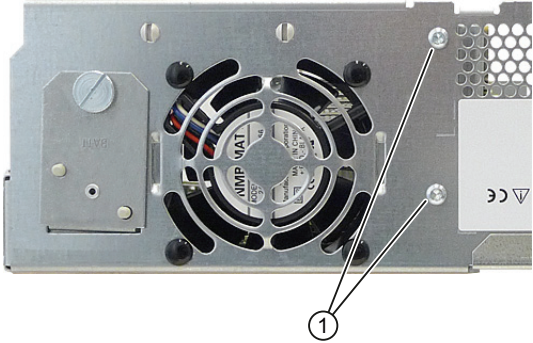
How to remove the bus board		
5	Remove the screws ① on the bus board.	
6	Loosen the screws on the enclosure.	
7	Pull the bus board from the motherboard.	

11.8.6 Installing / removing the motherboard

Preparation

1. Isolate the device from mains and disconnect all connection cables.
2. Open the device (Page 121).

Removing the motherboard

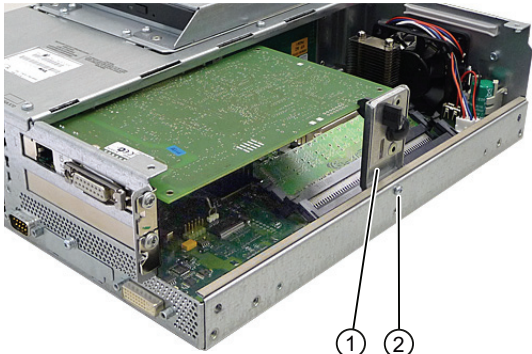
How to remove the motherboard		
1	Remove the drive bay module for the hard disk and DVD burner.	
2	Remove the screw ②. Remove the module bracket ①.	

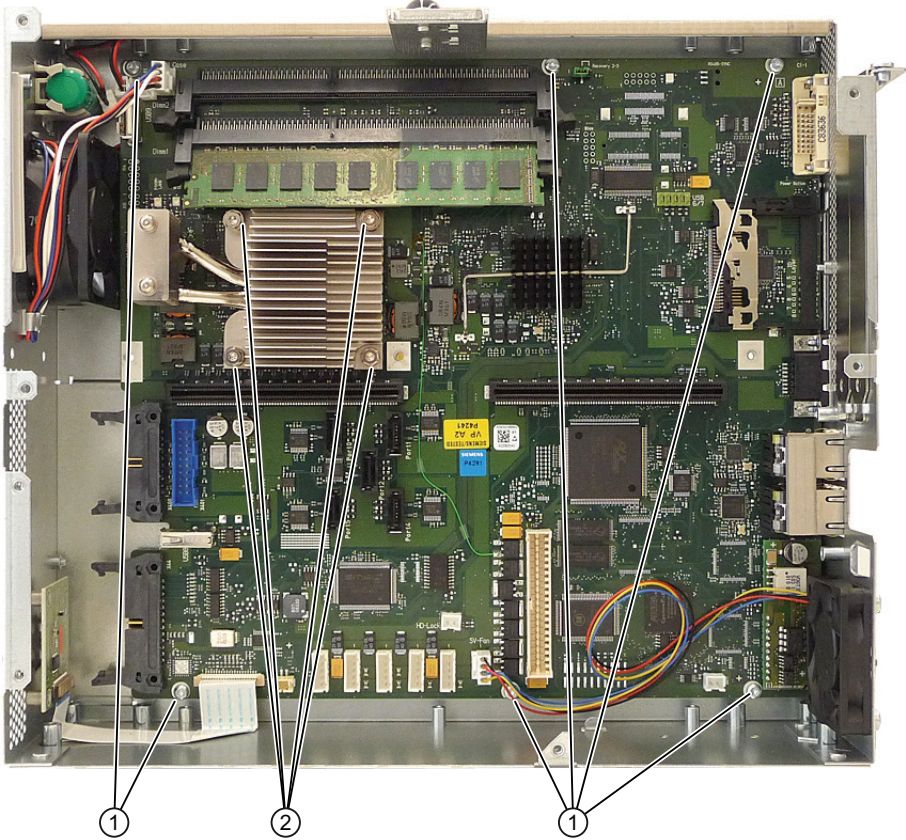
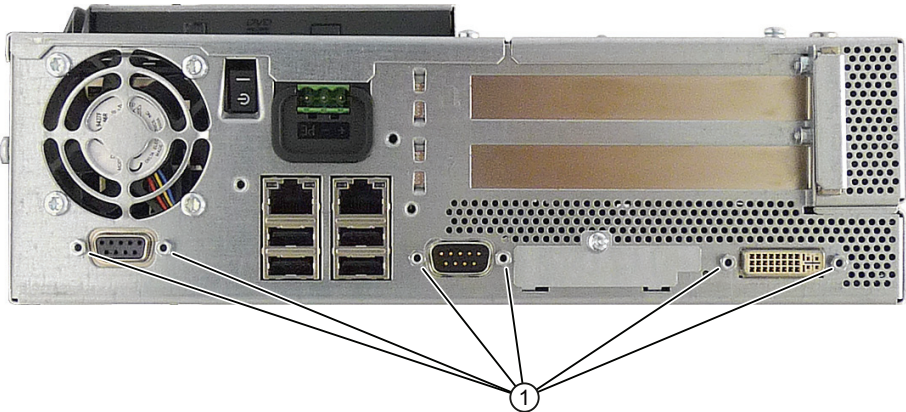
How to remove the motherboard	
3	Remove the power supply cover.
5	Remove the power supply.
4	Remove the bus board.
6	Disconnect all cables from the motherboard, noting down their positions while doing so.
7	Remove the screws ① (6 pieces) and then the screws ② (4 pieces). Remove the processor heat sink.
	
8	Remove the hexagon bolts (6 pieces) from the ports.
	
9	Remove the motherboard.

11.8.7 Installing / removing the equipment fan

Preparations

1. Disconnect the device from the mains.
2. Open the device (Page 121).

Removing the fan

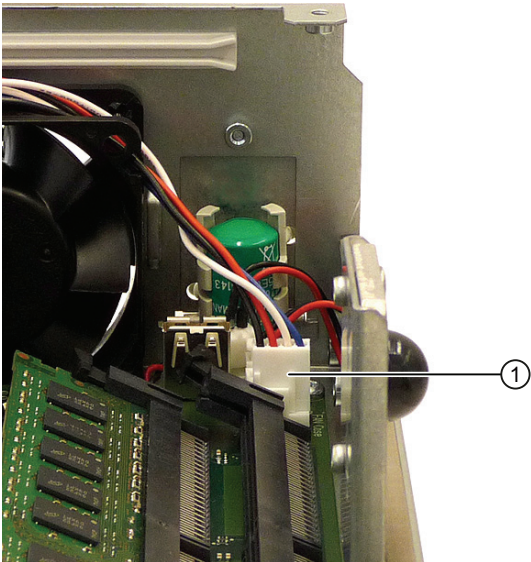
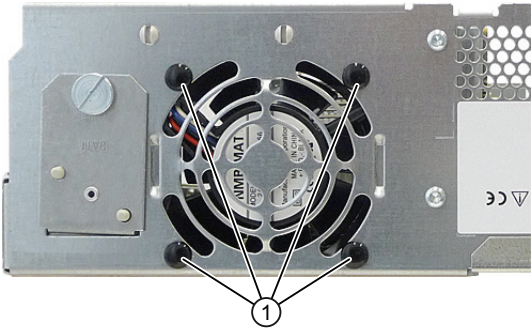
How to remove the fan	
1	<p>Pull the fan plug ① from the motherboard.</p> 
2	<p>Loosen the four plastic rivets ① on the enclosure.</p> 
3	<p>Take the fan out of the enclosure.</p>

Installing the fan

Note

Always install a fan of the same type!

Fan mounting position

The figure shows the correct fan mounting position.
Pay attention to the direction of the arrow on the fan enclosure!

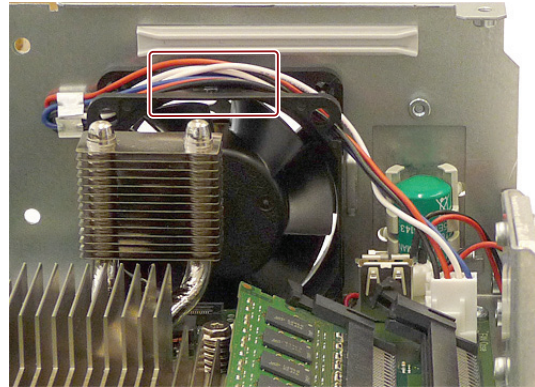

11.8.8 Installing / removing the power supply fan

Preparations

1. Disconnect the device from the mains.
2. Open the device (Page 121).
3. Remove the power supply.

Removing the fan

How to remove the fan

- 1 Pull out the fan connector ①.

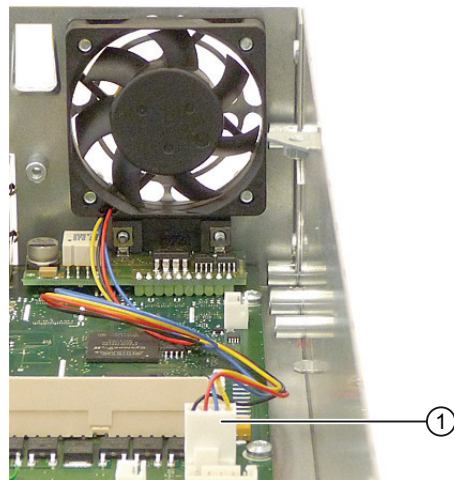

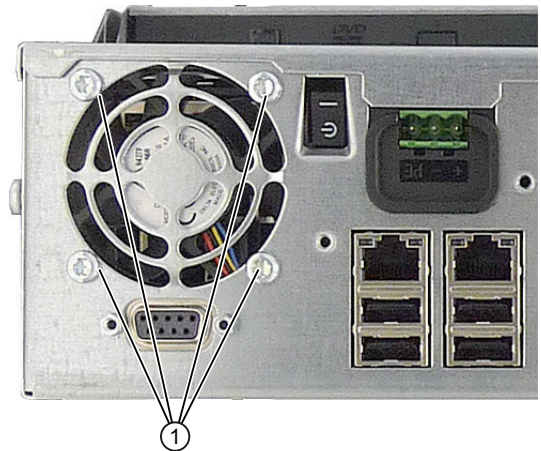
How to remove the fan	
2	Loosen the four screws ① on the enclosure.
	
3	Remove the fan from the enclosure.

Installing the fan

Note

Always install a fan of the same type!

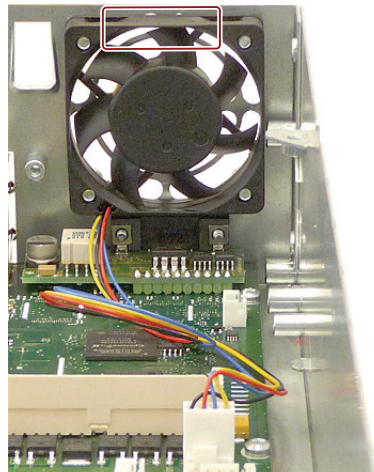
Fan mounting position	
<p>The diagram shows the correct mounting position of the fan. Pay attention to the direction of the arrow on the fan enclosure!</p>	

11.8.9 Processor replacement

Operation of the CPU is not possible.

As the processor is soldered on the motherboard, it has to be completely replaced. Please observe the information in Section Installing / removing the motherboard (Page 143).

11.9 Reinstalling the software

11.9.1 General installation procedure

If your software no longer functions correctly, you can reinstall it from either the Recovery DVD, the "Documentation and Drivers" CD/DVD or the Restore DVD.

Recovery DVD

The recovery DVD contains the installation program with tools for configuring the drives and installing the operating system and the supported languages (MUI package).

The basic language of the installed operating system is English. To add other languages, install these languages from the Recovery DVD at a later time.

"Documentation and Drivers" CD/DVD

The "Documentation and Drivers" CD/DVD contains the documentation and the hardware drivers.

Restore DVD

The Restore DVD is included in the scope of delivery when you have ordered a device with operating system. The DVD contains an image file with the original software package: Operating system with installed hardware drivers and monitoring software, e.g. DiagBase.

11.9.2 Restoring the delivery state

You can restore the original factory software using the Restore DVD. The DVD contains the necessary images and tools for transferring the factory software to the drive of your device. Restoration of the entire C drives: (system) and D: or only drive C: is possible. This allows you to retain any user data on drive D:.

Retrieving authorization or license

- Check whether you can retrieve your authorization or license key from the disk and perform this procedure if possible.
- If backup is not possible, please contact Customer Support. There you can obtain information necessary for software authorization.

NOTICE

If "Restore system partition only" is set all data on drive C: (system partition) will be deleted. All data, user settings and all authorizations or license keys on drive C: are lost! All data on drive C: will be completely deleted, reformatted and overwritten with the original factory software.

If "Restore entire hard disk" is set ALL data, user settings, authorizations or license keys will be lost on the entire drive.

Procedure

1. Connect a DVD drive to the USB interface.
2. Insert the Restore DVD into the DVD drive.
3. Reboot the device.
4. Press the <F12> key when the following BIOS message appears.

Press <F2> to go to Setup Utility

Press <F12> to go to Boot Manager

The "Boot Menu" is displayed when initialization is completed.

5. Select the optical drive with your cursor keys which is identified with a "P" in front of the SATA port number.

Example:

P3 - OPTIARC DVD-ROM DDU1681S.

6. Follow the on-screen instructions.

NOTICE

All existing data, programs, user settings, authorizations and license keys on the drives will be deleted and are thereby lost.

11.9.3 Installing Windows

11.9.3.1 Installing Windows

Use the Recovery DVD to install Windows to suit your particular requirements. You also need the supplied Documentation and Drivers DVD. Additional controllers unknown to the operating system must be made known to the recovery system and to the Windows operating system.

1. Press the F6 or the "Load Driver" icon key while booting and follow the on-screen instructions. During the rest of the installation, you will be asked several times for the missing driver of the controller.

Booting with the Recovery DVD

1. To boot the Recovery DVD press when BIOS outputs the message
Press <F2> to enter SETUP or <F12> to display the boot menu.
press the F12 key. The boot menu displayed after initialization indicates all boot devices.
2. Select the DVD drive.
Follow the instructions on the screen until the "Siemens SIMATIC Recovery" window is displayed.

When using the recovery function of Windows 7, confirm that you want to boot from DVD immediately at startup. Otherwise the system boots from hard disk if you have a bootable hard disk installed.

The following sections describe older Windows operating systems. The Recovery for Windows 7 is described in the section Recovery of Windows 7 (Page 154).

11.9.3.2 Installing Windows XP

Note

Specific information on the use of the Windows XP Professional operating system is available in the following manual (not included in the scope of delivery):

Microsoft Windows XP Professional, Technical Reference (MSPress No. 934)

Requirement

You need the recovery DVD for the Windows XP operating system. It is included in the scope of delivery.

Procedure

1. If necessary, connect a DVD drive to the USB interface.
2. Insert the Recovery DVD into the DVD drive.
3. Reboot the device.
4. Press the <F12> key when the following BIOS message appears.

Press F2 to go to Setup Utility

Press F12 to go to Boot Manager

After initialization, a boot menu is displayed.

5. In the boot menu, select the optical drive using the cursor keys. It is identified by a "P" in front of the SATA port number.

Example:

P3 - OPTIARC DVD-ROM DDU1681S

6. Confirm the selection by pressing ENTER.
7. **Immediately** press any key when you see the following prompt to install the operating system from the Recovery DVD.

Press any key to boot from CD ..

The Windows XP installation program (blue screen) appears after a few seconds.

8. Follow the instructions of the Windows XP installation program. You can find additional information on this in the section: Windows XP installation program

Windows XP installation program

The language of the installation program and the Windows XP Professional operating system is preset to English. You can change the language of Windows XP Professional once you have installed it. You can find information on this in section: Auto-Hotspot.

Partitions in the delivery state for Windows XP

The recommended minimum size of the partition on which you want to install Windows XP varies depending on how much work memory and which additional software you want to use. Information on partitioning of the data carrier in the delivery state is provided in the following table.

Partition	Name	Size	File system
First	SYSTEM	25 GB	NTFS not compressed
Second	DATA	Remainder	NTFS not compressed

11.9.3.3 Installation of Windows 7

Note

Specific information on the use of the Windows 7 operating system can be found in the following manual (not included in the scope of delivery):

- Windows 7 Technical Reference (MS Press No. 5913)
-

Requirement

You need the Windows 7 recovery DVD, which is included in the scope of delivery.

Procedure

1. If necessary, connect a DVD drive to the USB interface.
2. Insert the Recovery DVD into the DVD drive.
3. Reboot the device.
4. Press the <F12> key when the following BIOS message appears.

Press F2 to go to Setup Utility

Press F12 to go to Boot Manager

After initialization, a boot menu is displayed.

5. In the boot menu, select the optical drive using the cursor keys. It is identified by a "P" in front of the SATA port number.

Example:

P3 - OPTIARC DVD-ROM DDU1681S

6. Confirm the selection by pressing ENTER.
7. **Immediately** press any key when you see the following prompt to install the operating system from the Recovery DVD.

Press any key to boot from CD or DVD ..

After a few seconds, you will see the "Install Windows" installation program.

8. Now follow the instructions in the installation program. You can find additional information on this in the section: "Install Windows" installation program.

"Install Windows" installation program

The language of the installation program and the operating system you want to install has been preset to English. You can change the language of the operating system after the installation. You can find information on this in section: Auto-Hotspot.

Examples of partitions in the default factory setting

Table 11- 1 Windows 7 32-bit

Partition	Name	Size	File system
First	SYSTEM	25 GB	NTFS not compressed
Second	DATA	Remainder	NTFS not compressed

Table 11- 2 Windows 7 64-bit

Partition	Name	Size	File system
First	SYSTEM RESERVED	100 MB	Automatically set up by installation program
Second	SYSTEM	40 GB	NTFS not compressed
Third	DATA	Remainder	NTFS not compressed

11.9.4 Setting up the language selection by means of the Multilanguage User Interface (MUI)

You can set the display of menus, dialogs or other information, such as date and time, to a different language. For this purpose, you can either select one of the preinstalled languages or install a new language package.

The following command sequences are described in English. Depending on the default setting, they can be displayed in another language.

Setting up the language selection for Windows XP Professional

Note

Specific information for setting up the language for Windows XP Professional is available in the following manual (not included in the product package):

- "Microsoft Windows XP Professional, Technical Reference" (MSPress No 934)
-

Changing the settings for language, region and formats of a registered user account

1. Choose:

"Start > Control Panel > Regional and Language"

2. You can make the desired changes in the "Regional Settings", "Languages" and "Advanced" tabs.

Installing new language packages

1. Start the "MUISETUP.EXE" program in the "MUI" folder from the Recovery DVD.

All languages that can be installed are displayed.

Setting up the language selection in Windows 7

Note

Specific information for setting up the language selection for Windows 7 is available in the following manual (not included in the scope of delivery):

- Windows 7 Technical Reference (MS Press No. 5913)
-

Changing the settings for language, region and formats of a registered user account

1. Choose:
"Start > Control Panel > Clock, Language, and Region > Regional and Language Options"
2. You can make the desired changes in the "Formats" and "Location und Keyboards and Languages" tabs.

Changing the settings for language, region and formats of the system account and the standard user account

You can change the settings for language, region and formats of the system account (for example, the language in the user login dialog) and the settings of the standard user account (standard setting for new users). The settings of the registered user are copied to the system account and the standard user account for this purpose.

1. Choose:
"Start > Control Panel > Clock, Language, and Region > Regional and Language Options"
2. You can make the required changes in the "Administrative" tab. You copy the settings by clicking the respective button.

Installing new language packages

Some language packages are available on the Recovery DVD in the "Languagepacks" folder.

1. Choose:
"Start > Control Panel > Clock, Language, and Region > Regional and Language Options"
2. Select the "Keyboards and Languages" tab.
3. Click the "Install/uninstall languages" button and make the required changes.

11.9.5 Recovery of Windows 7

There is a full graphical user interface available for recovery of Windows 7. It may take several minutes before the first input window appears. In this window, you can set the time and currency formats and select the keyboard language.

English is the basic language and other languages can be installed later with the MUI. The MUI is on the recovery DVD.
Now follow the on-screen instructions. It may take several minutes before the next prompt for the product key is displayed.

Note

Due to the previous activation, you do not need to enter the product key (COA number). This is entered automatically during the installation.

Setting up and formatting partitions

Set up the hard disk partitions after having installed a new hard disk, or to repair faulty partitions, or to change the partitioning.

In the next dialog box, you can set up the hard disk according to your requirements and add controllers that are not yet known to the system.

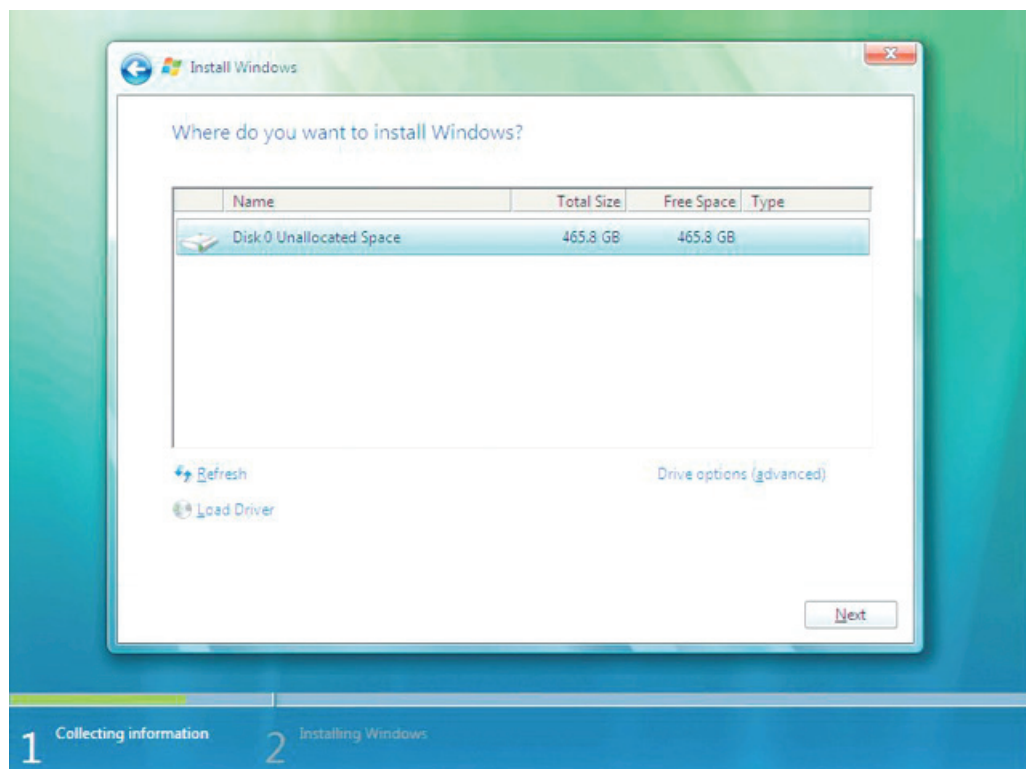

Options	Meaning
Drive options (advanced)	Further functions are displayed with which you can set up the hard disk.
Load Driver	To add new drivers, for example the driver for RAID.

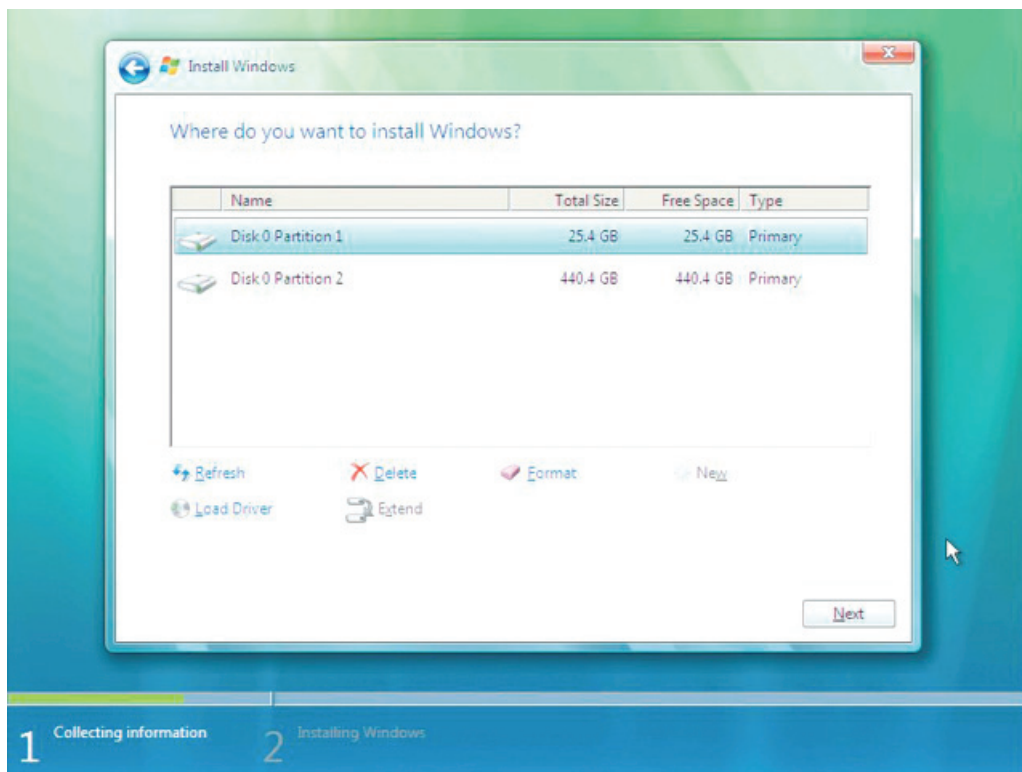

Options	Meaning
Refresh	Updating
Delete	Deleting a partition
Format	Formatting a partition
New	Creating new partitions
Load Driver	To add new drivers, for example the driver for RAID
Extend	Changing the partition size
	Any error messages that occur are displayed behind this icon, for example if the hard disk was not formatted in the required "NTFS" format.

The first partition should be at least 25 GB. The operating system must be installed on this partition. You can use the rest of the hard disk as a data partition. Both partitions must be installed as the NTFS file system.

When shipped, the partitions are set up as follows:

Partition	Operating system	Name	Size	File system
First	Windows 7	SYSTEM	25 GB	NTFS not compressed
Second	Windows 7	DATA	Remainder	NTFS not compressed

Following a required reboot, Windows will be installed on the hard disk. This process takes at least 20 minutes.

Now follow the instructions on the screen.

Note

If you want to reinstall drivers from a USB floppy disk drive, select Floppy Drive (A:).

Note

If you want to use Microsoft Windows as a professional user, you should have the following manuals available (not included in the scope of delivery):

- Windows 7 Technical Reference (MS Press No. 5913)

These manuals contain specific information for administrators who install, manage and integrate Windows in networks or multi-user environments.

Setting up the language selection in Windows 7

With the Multilanguage User Interface (MUI), you can set up the Windows menus and dialogs for additional languages. When shipped, Windows 7 is installed with English menus and dialogs. You can change this in the Control Panel with the "Regional and Language options" or "Time and Date" dialogs.

Here, you can change all system formats:

Start > Control Panel > Clock, Language, and Region > Change display language > Regional and Language options

Here, you can only change the date and time formats:

Start > Control Panel > Clock, Language, and Region > Change display language > Time and Date

If you want to install additional languages, you can install these later in the Control Panel, as follows. You will find the necessary files on the recovery DVD in the "Languagepacks" folder.

Start > Control Panel > Clock, Language, and Region > Change display language > Regional and Language options > Keyboards and Languages

Additional languages can be integrated through Windows Update.

11.9.6 Installing drivers and software

Introduction

Note

In the case of multilingual operating systems (MUI versions), you have to set the regional settings for menus and dialogs and the default language to English (US) before you install new drivers or operating system updates.

Procedure

To install the drivers and software from the supplied "Documentation and Drivers" CD/DVD, proceed as follows:

1. If your device has no CD/DVD drive, connect an external USB CD/DVD drive to a USB port.
2. Insert the DVD.
3. Start the "START" program.
4. Select "Drivers & Updates" from the index.
5. Select the device and operating system.
6. Select the desired driver.
7. Open the folder with the driver data by clicking on the link next to "Driverpath".
8. Start the setup program in this folder.

Note

For a new installation of Windows operating systems, the chipset driver must be installed before all other drivers, if required.

11.9.7 Installing the Intel RAID controller software

The software installation of the onboard RAID controller takes place with its driver installation. Additional information on this is available in the section "Installation of drivers and software".

11.9.8 Installing the optional burner or DVD software

Information about installation of the burner / DVD software is available on the supplied CD.

11.9.9 Update installation

11.9.9.1 Updating the operating system

Windows

The latest updates for the Windows operating system are available in the Internet at Microsoft (<http://www.microsoft.com>).

Note

Before you install new drivers or operating system updates for Windows MUI versions, set the default language to US English in the regional settings for menus and dialogs.

Other operating systems

Contact the corresponding manufacturer.

11.9.9.2 Installing or updating application programs and drivers

Install and connect an appropriate drive in order to install software from a CD and / or floppy disk in Windows.

The USB floppy disk and CD-ROM drivers are included in Windows and do not have to be installed from other sources.

For information about installation of SIMATIC software packages, refer to the corresponding manufacturer documentation.

Contact the manufacturer to obtain updates of drivers and application programs you purchased from third-party vendors.

Note

Before you install new drivers or operating system updates for Windows versions, set the default language to US English in the regional settings for menus and dialogs.

11.9.10 Data backup / subsequent modification of partitions

11.9.10.1 Hardware supported

Note

Older versions of the SIMATIC IPC Image Creators do not support the hardware of the device.

Support is available as of SIMATIC IPC Image & Partition Creator Version 3.2.

In the case of device equipment with hardware RAID, the device driver has to be reloaded. A new function is available in the SIMATIC IPC Image & Partition Creator to this purpose.

For information on SIMATIC IPC Image & Partition Creator, refer to the corresponding product documentation.

11.9.10.2 Creating an image

To backup your data under Windows, we recommend that you use the "SIMATIC IPC Image & Partition Creator" software tool. This tool allow easy backup and fast restoration of the full contents of Compact Flash cards, hard disks and individual partitions (images).

"SIMATIC IPC Image & Partition Creator" supports burning to DVD media.

The software can be ordered from the SIEMENS online ordering system. For detailed information about "SIMATIC IPC Image & Partition Creator", please refer to the corresponding product documentation.

11.9.10.3 Modifying the partitions

In order to modify partitions, we recommend using the software tool "SIMATIC IPC Image & Partition Creator". The software can be ordered from the SIEMENS online ordering system.

Detailed information about using this tool is available in the manufacturer documentation of the "SIMATIC IPC Image & Partition Creator".

11.9.11 CP 1616 onboard

NDIS device driver

Read the information in description provided by Device_Driver_CP16xx.pdf on the supplied "Documentation and Drivers" CD.

PROFINET IO

Read the information regarding the SIMATIC devices and SIMATIC NET documentation listed in the "Integration" section.

11.10 Installing the RAID Controller software

You find the procedure for installing the RAID controller software in the RAID user manual on the supplied "Documentation and Drivers" CD.

Note concerning Windows XP Professional

You need to select the Intel BD82QM57 Controller from the provided list when installing Windows XP Professional for the first time.

11.11 BIOS update

Writing down the BIOS Setup settings

Before you update your BIOS Setup settings, you should write down the values so that you can restore them after the BIOS update, if necessary.

Updating the BIOS default values

It is imperative that you update the BIOS default values after a BIOS update:

1. Keep the F2 key pressed during the device start until the setup menu is displayed on the screen.
2. Load the defaults using F9.
3. Adapt the BIOS Setup settings again, if necessary.

Reboots

Several reboots can be carried out after a BIOS update. These reboots are initiated by the Management Engine (ME). The reboots are required by the ME to adapt itself to the changes in the BIOS update.

11.12 BIOS Recovery

The "BIOS-Recovery" function is used to reinstall the device when a BIOS is unusable.

The recovery resets all the BIOS setup settings to the default values. After successful recovery, you will need to make these settings again if you require any customer-specific values.

Procedure

1. Switch off the device.
2. Remove the device cover.
3. Install a jumper at ① on the "Recovery" interface.

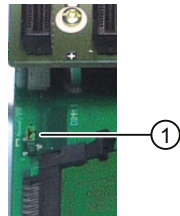

4. Close the device cover.
5. Place the Siemens BIOS Update USB stick into an USB slot of the device front.
6. Connect the power supply and switch on the device.

Recovery is executed automatically and cannot be interrupted or operated. The recovery progress will be displayed on the screen.

7. Complete the recovery:
 - Switch off the device.
 - Remove the device cover, plug the jumper ① to "Park position" and close the device cover.
 - Remove the USB stick.
 - Switch on the device.
 - Call up the BIOS Setup by pressing the F2 key. If necessary, reset the Setup values.

Alarm, error, and system messages

12.1 Boot error messages

BIOS first performs a **Power On Self Test (POST)** within the boot routine to verify proper operation of certain functional units of the PC. The boot sequence is interrupted immediately if fatal errors occur.

If the POST does not return an error, the BIOS initializes and tests further functional units. In this startup phase, the graphics controller is initialized and any error messages are output to the screen.

The error messages output by the system BIOS are listed below. For information on error messages output by the operating system or programs, refer to the corresponding manuals.

On-screen error messages

On-screen error message	Meaning / suggestions
Error - CMOS battery failed	The battery on the CPU module is defective or dead. Contact your technical support team.
Error - SMART failure detected on HDD	Hard disk error: An error bound suggested by the manufacturer has been exceeded. The operation of the hard disk is not secure. The hard disk must be replaced. Contact your technical support.
Error - Keyboard error	Check whether the keyboard is properly connected. Keyboard faults Contact your technical support.
No bootable device -- Please restart system	Possible causes: <ul style="list-style-type: none"> • No operating system present • Wrong drive addressed (disk in drive A/B) • Incorrect active boot partition • Wrong drive settings in SETUP • Hard disk is not connected / defective
Error - Realtime clock has lost power	Clock chip error. Contact your technical support team.

12.2 Introduction to the BIOS beep codes

The device performs a self-test when it is switched on. If an error is detected during the POST (Power On Self-Test), a series of beep signals are issued. The beep tones are a code for errors and are composed of 2 x 2 sequences.

Table 12- 1 Converting the beep codes in a Hex display

Beep tones		Hex code
B	B	0
B	BB	1
B	BBB	2
B	BBBB	3
BB	B	4
BB	BB	5
BB	BBB	6
BB	BBBB	7
BBB	B	8
BBB	BB	9
BBB	BBB	A
BBB	BBBB	B
BBBB	B	C
BBBB	BB	D
BBBB	BBB	E
BBBB	BBBB	F

Example

Tone sequence	B	BBB	BBB	B
Hex code	2		8	
Meaning	Determine RAM size			

12.3 BIOS beep codes

The following section lists the POST codes relevant to users in the sequence in which they occur: Contact Customer Support (<http://www.siemens.com/automation/service&support>) for information on all other POST codes.

Display (hex)	Meaning	Description		Remedy
4DH	DXE_MTC_INIT	MTC Initial	MonoTonicCounter initialization	Service case
4EH	DXE_CPU_INIT	CPU Middle Initial	CPU initialization	Replace basic module

Display (hex)	Meaning	Description		Remedy
4FH	DXE_MP_CPU_INIT	Multi-processor Middle Initial	Multiprocessor initialization	Replace basic module
50H	DXE_SMBUS_INIT	SMBUS Driver Initial	SMBUS driver initialization	Service case
51H	DXE_SMART_TIMER_INIT	8259 Initial	SMART Timer initialization	Service case
52H	DXE_PCRTC_INIT	RTC Initial	RTC initialization	Service case
53H	DXE_SATA_INIT	SATA Controller early initial	Advance initialization of the SATA Controller	Service case
54H	DXE_SMM_CONTROLLER_INIT	Setup SMM Control service, DXE_SMMController_INIT	SSM Control service	Service case
55H	DXE_LEGACY_INTERRUPT	Setup Legacy Interrupt service, DXE_LegacyInterrupt	Setup Legacy Interrupt service	Service case
01H	SEC_SYSTEM_POWER_ON	CPU power on and switch to Protected mode	Switch to Protected Mode	Service case
02H	SEC_BEFORE_MICROCODE_PATCH	Patching CPU microcode	Load CPU Microcode	Service case
03H	SEC_AFTER_MICROCODE_PATCH	Setup Cache as RAM	Set up cache as RAM	Service case
04H	SEC_ACCESS_CSR	PCIE MMIO Base Address initial	Initialize PCIE	Service case
05H	SEC_GENERIC_MSRIINIT	CPU Generic MSR initial	Initialize CPU MS (Machine Status) Register	Service case
06H	SEC_CPU_SPEEDCFG	Setup CPU speed	Specify CPU speed	Service case
07H	SEC_SETUP_CAR_OK	Cache as RAM test	Carry out RAM Test on cache	Replace basic module
08H	SEC_FORCE_MAX_RATIO	Tune CPU frequency ratio to maximum level	Setting CPU frequency	Service case
09H	SEC_GO_TO_SECSTARTUP	Setup BIOS ROM cache	Set up BIOS ROM cache	Service case
0AH	SEC_GO_TO_PEICORE	Enter Boot Firmware Volume	Calling up the boot firmware memory area	Service case
70H	PEI_SIO_INIT	Super I/O initial	Initialization of the Super I/O	Service case
71H	PEI_CPU_REG_INIT	CPU Early Initial	Initialize CPU Register	Service case
72H	PEI_CPU_AP_INIT	Multi-processor Early initial	Multi processor initialization	Service case

12.3 BIOS beep codes

Display (hex)	Meaning	Description		Remedy
73H	PEI_CPU_HT_RESET	HyperTransport initial	Initialize Hyper Transport functionality	Service case
74H	PEI_PCIE_MMIO_INIT	PCIE MMIO BAR Initial	Initialize PCIE Register	Service case
75H	PEI_NB_REG_INIT	North Bridge Early Initial	Initialization of the North bridge	Service case
76H	PEI_SB_REG_INIT	South Bridge Early Initial	Initialization of the South bridge	Service case
77H	PEI_PCIE_TRAINING	PCIE Training	Training phase of the PCIE device	Service case
79H	PEI_SMBUS_INIT	SMBUS Early Initial	Initialization of the SM Bus	Service case
41H	DXE_SB_SPI_INIT	South bridge SPI initial	Initialization of the Serial Peripheral Interface in the South Bridge	Service case
42H	DXE_CF9_RESET	Setup Reset service, DXE_CF9Reset	Setup Reset service	Service case
43H	DXE_SB_SERIAL_GPIO_INIT	South bridge Serial GPIO initial, DXE_SB_Serial GPIO_INIT	Initializations of the serial GPIO	Service case
44H	DXE_SMMACCESS	Setup SMM ACCESS service	Setup SMM access service	Service case
45H	DXE_NB_INIT	North bridge Middle initial	Initialization of the North Bridge	Service case
46H	DXE_SIO_INIT	Super I/O DXE initial	Initialization of the Super IO	Service case
47H	DXE_LEGACY_REGION	Setup Legacy Region service, DXE_LegacyRegion	Setup service Legacy region	Service case
48H	DXE_SB_INIT	South Bridge Middle Initial	Initialization of the South Bridge	Service case
49H	DXE_IDENTIFY_FLASH_DEVICE	Identify Flash device	Identify FLASH type	Service case
4AH	DXE_FTW_INIT	Fault Tolerant Write verification	Checking of the write fault tolerance	Service case
4BH	DXE_VARIABLE_INIT	Variable Service Initial	Initialization of the variable service	Service case
4CH	DXE_VARIABLE_INIT_FAIL	Fail to initial Variable Service	Failure to initialize the variable service	Service case
26H	BDS_CONNECT_LEGACY_ROM	Dispatch option ROMs	Callup of the Legacy Option ROMs	Service case

Display (hex)	Meaning	Description		Remedy
27H	BDS_ENUMERATE_ALL_BOOT_OPTION	Get boot device information	Determine the Boot Device information	Service case
28H	BDS_END_OF_BOOT_SELECTION	End of boot selection	Boot selection terminated	Service case
29H	BDS_ENTER_SETUP	Enter Setup Menu	Callup into SETUP	Service case
2AH	BDS_ENTER_BOOT_MANAGER	Enter Boot manager	Callup Boot Manager	Service case
2BH	BDS_BOOT_DEVICE_SELECT	Try to boot system to OS	Booting of the OS	Service case
2CH	BDS_EFI64_SHADOW_ALL_LEGACY_ROM	Shadow Misc Option ROM	Copying the Legacy Option ROMs into RAM	Service case
2DH	BDS_ACPI_S3SAVE	Save S3 resume required data in RAM	Make available for operating state S3 RAM	Service case
2EH	BDS_READY_TO_BOOT_EVENT	Last Chipset initial before boot to OS	Initialization of the last chipset before the OS Boot	Service case
2FH	BDS_GO_LEGACY_BOOT	Start to boot Legacy OS	Boot Legacy OS	Service case
30H	BDS_GO_UEFI_BOOT	Start to boot UEFI OS	Boot UEFI OS	Service case
31H	BDS_LEGACY16_PREPARE_TO_BOOT	Prepare to Boot to Legacy OS	Preparation for booting of Legacy OS	Service case
32H	BDS_EXIT_BOOT_SERVICES	Send END of POST Message to ME via HECI	Terminate Boot Service	Service case
33H	BDS_LEGACY_BOOT_EVENT	Last Chipset initial before boot to Legacy OS.	Initialization of the last chipset before the Legacy OS Boot	Service case
34H	BDS_ENTER_LEGACY_16_BOOT	Ready to Boot Legacy OS.	Callup to boot the Legacy OS	Service case
35H	BDS_RECOVERY_START_FLASH	Fast recovery start flash	Start the BIOS Recovery function	Service case
F9H	POST_BDS_NO_BOOT_DEVICE	No Boot Device, PostBDS_NO_BOOT_DEVICE	No BOOT device found	Service case
FBH	POST_BDS_START_IMAGE	UEFI Boot Start Image, PostBDS_START_IMAGE	Booting of an UEFI image	Service case
FDH	POST_BDS_ENTER_INT19	Legacy 16 boot entry	Start Legacy 16 boot	Service case
FEH	POST_BDS_JUMP_BOOT_SECTOR	Try to Boot with INT 19	Boot with INT 19	Service case
E5H	ASL_WAKEUP_S5	System wakeup from S5	Reboot from operating state S5	Service case

12.3 BIOS beep codes

Display (hex)	Meaning	Description		Remedy
10H	BDS_ENTER_BDS	Enter BDS entry	Phase Boot Device Selection	Service case
11H	BDS_INSTALL_HOTKEY	Install Hotkey service	Installation of the Hotkey service	Service case
12H	BDS_ASF_INIT	ASF Initial	Initialize Alert Standard Format	Service case
13H	BDS_PCI_ENUMERATION_START	PCI enumeration	Enumerate PCI bus	Service case
14H	BDS_BEFORE_PCIIO_INSTALL	PCI resource assign complete	Assign PCI resources	Run a test by disabling the hardware components in SETUP, or by removing the expansion modules installed on the bus module.
15H	BDS_PCI_ENUMERATION_END	PCI enumeration complete	PCI enumeration completed	Service case
16H	BDS_CONNECT_CONSOLE_IN	Keyboard Controller, Keyboard and Mouse initial	Initialization of keyboard and mouse	Run a test by replacing the keyboard/mouse
17H	BDS_CONNECT_CONSOLE_OUT	Video device initial	Initialize graphic connection	Service case
18H	BDS_CONNECT_STD_ERR	Error report device initial	Initialize default error output	Service case
19H	BDS_CONNECT_USB_HC	USB host controller initial	Initialize USB host controller	Service case
1AH	BDS_CONNECT_USB_BUS	USB BUS driver initial	Initialize USB bus driver	Service case
1BH	BDS_CONNECT_USB_DEVICE	USB device driver initial	Initialize USB device driver	Service case
1CH	BDS_NO_CONSOLE_ACTION	Console device initial fail	Initialization of the console faulty	Service case
1DH	BDS_DISPLAY_LOGO_SYSTEM_INFO	Display logo or system information	Display logo or system information	Service case
1EH	BDS_START_IDE_CONTROLLER	IDE controller initial	Initialization of the IDE controller	Service case
1FH	BDS_START_SATA_CONTROLLER	SATA controller initial	Initialization of the SATA controller	Service case
20H	BDS_START_ISA ACPI_CONTROLLER	SIO controller initial	Initialization of the Super IO	Service case
21H	BDS_START_ISA_BUS	ISA BUS driver initial	Initialization of the ISA bus driver	Service case

Display (hex)	Meaning	Description		Remedy
22H	BDS_START_ISA_FDD	Floppy device initial	Initialization of the floppy connection	Service case
23H	BDS_START_ISA_SERIAL	Serial device initial	Initialization of the serial connection	Service case
24H	BDS_START_IDE_BUS	IDE device initial	Initialization of the IDE connection	Service case
25H	BDS_START_AHCI_BUS	AHCI device initial	Initialization of the AHCI connection	Service case
56H	DXE_RELOCATE_SMBASE	Relocate SMM BASE	Reassign SMM base	Service case
57H	DXE_FIRST_SMI	SMI test	SMI test	Service case
58H	DXE_VTD_INIT	VTD Initial	Initialize I/O virtualization (VTD)	Service case
59H	DXE_BEFORE_CSM16_INIT	Legacy BIOS initial	Legacy BIOS initialization	Service case
5AH	DXE_AFTER_CSM16_INIT	Legacy interrupt function initial	Legacy interrupts initialization	Service case
5BH	DXE_LOAD_ACPI_TABLE	ACPI Table Initial	ACPI table initialization	Service case
5CH	DXE_SB_DISPATCH	Setup SB SMM Dispatcher service, DXE_SB_Dispatch	SMM dispatcher service	Service case
5DH	DXE_SB_IOTRAP_INIT	Setup SB IOTRAP Service	SouthBridge IOTRAP service	Service case
5EH	DXE_SUBCLASS_DRIVER	Build AMT Table	Initialization of the AMT (Active Management Technology) table	Service case
5FH	DXE_PPM_INIT	PPM Initial	Initialization of the Processor Power Management	Service case
60H	DXE_HECIDRV_INIT	HECIDRV Initial	Initialization of the Host Embedded Controller Interface	Service case
61H	DXE_VARIABLE_RECLAIM	Variable store garbage collection and reclaim operation	Loading of the variable memory	Service case
7AH	PEI_PROGRAM_CLOCK_GEN	Clock Generator Initial	Initializations of the clock generator	Service case
7BH	PEI_IGD_EARLY_INITIAL	Internal Graphic device early initial, PEI_IGDopRegion	First initialization of the graphic connection	Service case

12.3 BIOS beep codes

Display (hex)	Meaning	Description		Remedy
7CH	PEI_HECI_INIT	HECI Initial	Initialization of the Host Embedded Controller Interface	Service case
7DH	PEI_WATCHDOG_INIT	Watchdog timer initial	Initialization of the watchdog timer	Service case
7EH	PEI_MEMORY_INIT	Memory Initial for Normal boot	Memory initialization during the PEI phase	Replace the memory modules
7FH	PEI_MEMORY_INIT_FOR_CRISIS	Memory Initial for Crisis Recovery	Memory initialization for BIOS recovery	Replace the memory modules
80H	PEI_MEMORY_INSTALL	Simple Memory test	Memory test	Replace the memory modules
81H	PEI_TXTPEI	TXT function early initial	Initialization of the Trusted Execution Technology	Service case
82H	PEI_SWITCH_STACK	Start to use Memory	Start the memory use	Service case
83H	PEI_MEMORY_CALLBACK	Set cache for physical memory	Use cache as a physical memory	Service case
84H	PEI_ENTER_RECOVERY_MODE	Recovery device initial	Initialize the device for BIOS recovery	Service case
85H	PEI_RECOVERY_MEDIA_FOUND	Found Recovery image	BIOS Recovery image found	Service case
86H	PEI_RECOVERY_MEDIA_NOT_FOUND	Recovery image not found	BIOS Recovery image not found	Check whether the BIOS Recovery image exists on the recovery medium (e.g. USB stick).
87H	PEI_RECOVERY_LOAD_FILE_DONE	Load Recovery Image complete	Loading of BIOS Recovery image completed	Service case
88H	PEI_RECOVERY_START_FLASH	Start Flash BIOS with Recovery image	Starting of flashing of BIOS Recovery image	Service case
89H	PEI_ENTER_DXEIPL	Loading BIOS image to RAM	Copy BIOS image to the RAM	Service case
8AH	PEI_FINDING_DXE_CORE	Loading DXE core	Loading DXE (Driver Execution Environment) program	Service case
8BH	PEI_GO_TO_DXE_CORE	Enter DXE core	Start DXE program	Service case

Special codes

The BIOS does not generate any beep codes.

Troubleshooting/FAQs

13.1 General problems

This chapter provides you with tips on how to localize and troubleshoot frequently occurring problems.

Problem	Possible causes	Remedy
The device is not operational	There is no power supply to the device.	<ul style="list-style-type: none"> Check the power supply, the network cable and the power plug. Check if the On/Off switch is in the correct position.
	Device is being operated outside the specified ambient. conditions	<ul style="list-style-type: none"> Check the ambient conditions. After transport in cold weather, wait approximately 12 hours before switching on the device.
Windows no longer boots	Settings in the BIOS Setup are incorrect	<ul style="list-style-type: none"> Check the settings in the BIOS Setup "SATA Configuration" submenu Check the setting in the BIOS Setup Boot menu
The external monitor remains dark.	The monitor is switched off.	Switch on the monitor.
	The monitor is in "power save" mode.	Press any key on the keyboard.
	The brightness button has been set to dark.	Increase the screen brightness. For detailed information, refer to the monitor operating instructions.
	The power cord or the monitor cable is not connected.	<ul style="list-style-type: none"> Check whether the power cord has been properly connected to the monitor and to the system unit or to the grounded shockproof outlet. Check whether the monitor cable has been properly connected to the system unit and to the monitor.
		If the monitor screen still remains dark after you have performed these checks, please contact your technical support team.
The mouse pointer does not appear on the screen.	The mouse driver is not loaded.	Check if the mouse driver is correctly installed.
	The mouse is not connected.	Check whether the mouse lead is connected to the system unit. If you are using an adapter or extension for the mouse lead, check the connectors. Should the mouse cursor still not be visible on-screen after completing these checks and measures, contact technical support.

13.1 General problems

Problem	Possible causes	Remedy
Wrong time and/or date on the PC.		<ol style="list-style-type: none"> 1. Press <F2> during the boot sequence to open BIOS Setup. 2. Set the time and date in the setup menu.
Although the BIOS setting is OK, the time and data are still wrong.	The backup battery is dead.	Replace the backup battery.
USB device not responding.	The USB ports are disabled in your BIOS.	Use a different USB port or enable the port.
	Operating system does not support the USB port.	Enable USB Legacy Support for the mouse and keyboard. For other devices you need the USB drivers for the respective operating system.
DVD: The front loader does not open.	The device is switched off or the open/close button is disabled by a software application.	Emergency removal of the data medium: <ol style="list-style-type: none"> 1. Switch off the device 2. Insert a pointed object, a pin for example, or an opened paper clip into the emergency extraction opening of the drive. Apply slight pressure to the contact until the front loader opens. 3. Pull the loader further out.
The RAID software reports the following errors: <ul style="list-style-type: none"> • The RAID plug-in failed to load, because the drive is not installed. • The Serial ATA plug-in failed to load, because the driver is not installed correctly. • The Intel® Matrix Storage Console was unable to load a page for the following reason: <ul style="list-style-type: none"> – A plug-in did not provide a page for the selected device – A plug-in failed to load 	RAID is not activated RAID is activated	In this case, the messages have no negative influence on the device function and can be ignored. Acknowledge the messages. Re-install the software from the supplied Documentation and Drivers DVD.
After changing the hard disk, the system does not boot from the RAID array	RAID array does not have highest boot priority	Set the RAID array to be first in the boot order
After changing the hard disk, "unused" is indicated for the relevant SATA port	The system was booted without a functioning hard disk (the removable cartridge was possibly not turned on)	Reboot the system with a functioning hard disk
Computer does not boot or "Boot device not found" is displayed	The boot device is not first in the boot priority in the BIOS setup or is excluded as a boot device	Change the boot priority of the boot device in the Boot menu of the BIOS setup or permit boot device in the boot priority

13.2 Problems when Using Modules of Third-party Manufacturers

Problem	Possible cause	Remedy
The PC crashes during startup	<ul style="list-style-type: none"> • Double allocation of I/O addresses • Double allocation of hardware interrupts and/or DMA channels • Signal frequencies or signal levels are incorrect. • Different connector pin assignments 	Check your computer configuration: <ul style="list-style-type: none"> • If the computer configuration corresponds with factory state, please contact your technical support team. • If the computer configuration has changed, restore the original factory settings. Remove all third-party modules, then restart the PC. If the error no longer occurs, the third-party module was the cause of the fault. Replace this module with a Siemens module or contact the module supplier.
	<ul style="list-style-type: none"> • If the performance of the external 24 V power supply is insufficient 	Contact Technical Support if the PC still crashes. <ul style="list-style-type: none"> • use a larger power supply.

13.3 Display a temperature error by means of the DiagBase application

Cause

Temperature errors do not occur during the normal approved use of the device. If the monitoring software (DiagBase or DiagMonitor) indicates a temperature error and the symbol in the status display changes from green to red, check the following:

- Are the fan apertures covered?
- Has the fan has failed (check speed display in the monitoring software)?
- Is the ambient temperature higher than the allowed value (see technical data)?
- Is the total output of the power supply within the specified limit?
- Are the heatsinks inside the PC covered with dust?

Remedy

The temperature fault is stored until the temperature drops back below the temperature threshold and you acknowledge the error message in the monitoring software.

- Click on the button with the "small broom" icon.
When the error message has been acknowledged, the "TEMP" LED goes out, the title bar changes in the monitoring software and the symbol in the status bar changes from red to green.
- Restart the PC if you have not installed the monitoring software.

13.3 Display a temperature error by means of the DiagBase application

Technical data

14.1 General specifications

Electrical specifications	
Supply voltage AC	Nominal 100 - 240 V AC (-15% / +10%), autorange
Supply voltage DC ¹	Nominal 24 V DC (-20% / + 20%), SELV
AC device: Frequency	50 to 60 Hz, 47 to 63 Hz
Input current AC	Continuous current to 2.3 A (to 50 A for 1 ms at startup)
Input current DC	Continuous current to 8 A (to 14 A for 30 ms at startup)
Supply voltage frequency	50 to 60 Hz (47 to 63 Hz)
Transient voltage interruption Namur	Max. 20 ms (93 to 264 V) Max. 10 events per hour, minimum recovery time 1 s
Maximum power consumption AC and DC	Effective power 190 W / 210 W Apparent power 250 VA
Maximum current	16.5 A (peak 18.5 A) at +5 V 8.5 A at +3.3 V The total power of the +5 V and 3.3 V voltage is 90 W maximum. 6.5 A (peak 8 A) at +12 V 0.3 A at -12 V The total power of all voltages is 150 W maximum.

- ¹ The generation of the supply voltage by the upstream power supply must be realized as safety extra-low voltage with safe electrical isolation as SELV according to IEC/UL/EN/DIN EN 60950-1.

Motherboard	
Chipset	Mobile Intel® QM57 Express Chipset
Processor	Intel® Celeron™ P4505 mobile processor 1.86 GHz, 2 MB second-level cache, 2 cores/2 threads Intel® Core™ i3-330E mobile processor 2.13 GHz, 3 MB second-level cache, 2 cores/4 threads, hyperthreading, virtualization Intel® Core™ i7-610E mobile processor 2.53 GHz, 4 MB second-level cache, 2 cores/4 threads, hyperthreading, turboboost and virtualization
Main memory	2 sockets maximum 4 GB SDRAM DDR3 1066; see order documentation for memory expansion
Buffer memory	2 MB SRAM, 128 KB can be backed up in the buffer time
Free expansion slots	1 x PCI 290 mm long and 1 x PCI 185 mm long or 1 x PCI 290 mm long and 1 x PCI Express x16 185 mm long
Maximum permissible current consumption per PCI slot	5 V/2 A or 3.3 V/3 A, 12 V/1 A, -12 V/0.05 A The accumulated power consumption (all slots) may not exceed 30 W

14.1 General specifications

Disk drives	
Hard disks	2.5" or 3.5" Serial ATA, hard disk capacity see order documentation <ul style="list-style-type: none"> • 3 Gbps data transfer rate • Supports NCQ (Native Command Queuing) SATA II property
DVD burner	Serial ATA, See order documentation for features Oscillations, max.: 10 to 58 Hz: 0.019 mm / 58 to 500 Hz: 2.5 m/s2 Burner operation only permissible in interference-free environment

Display					
Graphics controller	Intel® HD Graphics Controller, 2-D and 3-D engine integrated in chipset				
Graphics memory	Dynamic Video Memory Technology (uses up to 256 MB of RAM)				
Resolutions, frequencies, color depth	CRT: Max. 1280x1024 at 100 Hz/32-bit color depth Max. 1600x1200 at 60 Hz/32-bit color depth Maximum resolution: 2038x1536 at 75 Hz/16-bit color depth LCD via DVI-I: 1600x1200 at 60 Hz / 32-bit color depth				
Color display ^{*)}	12" TFT Key panel	15" TFT Key panel	12" TFT Touch panel	15" TFT (INOX) Touch panel	19" TFT Touch panel
Resolution	800 x 600	1024 x 768	800 x 600	1024 x 768	1280 x 1024
Contrast ratio, typ.	600:1	450:1	450:1	450:1	700:1
Max. light density cd/m ² , typ.	350	250	350	250	300
Horizontal viewing angle right/left/typ./min.	70° / 60°	60° / 50°	70° / 60°	60° / 50°	typically 80°
Vertical viewing angle above / typ. / min.	45° / 35°	40° / 30°	45° / 35°	40° / 30°	typically 80°
Vertical viewing angle below / typ. / min.	55° / 45°	60° / 35°	55° / 45°	60° / 35°	typically 80°
^{*)} A small number of faults in the display is unavoidable. However, the displays do comply with the described quality standards of the ISO standard 13406-2, class 2.					
^{*)} Bad pixels <ul style="list-style-type: none"> • Permanently bright, dark pixels • Permanently bright, green pixels 		Permissible number <ul style="list-style-type: none"> • ≤ 12 • ≤ 5 			

Front					
	12" TFT Key panel	15" TFT Key panel	12" TFT Touch panel	15" TFT (INOX) Touch panel	19" TFT Touch panel
Service life of the screen backlighting	50,000 h for 24 h continuous operation, temperature dependent, remaining brightness 50%				
Membrane keyboard with alphanumeric and numeric keys	X		—		
Function keys	36 with LED		—		
Direct control key module	optional		—		
Actuating force (test pen with 3 mm radius)	Maximum 3 N		—		
Cycles (operation)	> 1 million		—		
Resistive analog touch screen	—		X		
Touch force (with test pen with 2 mm diameter)	—		5 N		
Slide-in labels for function keys	X		—		
Front-mounted integrated mouse	X		—		

Power loss *)					
	12" TFT Key panel	15" TFT Key panel	12" TFT Touch panel	15" TFT (INOX) Touch panel	19" TFT Touch panel
Efficiency of the power supply	86%				
Control unit	30 W	30 W	30 W	30 W	53 W
Computer unit	75 W	75 W	75 W	75 W	75 W
PCI cards (17.5 W each)	35 W	35 W	35 W	35 W	35 W
Panel PC 677B	105 W	105 W	105 W	105 W	128 W
Panel PC with 2 PCI plug-in cards	140 W	140 W	140 W	140 W	163 W
*) The specified values apply to the maximum configuration of the device.					

Weight	12" TFT Key panel	15" TFT Key panel	12" TFT Touch panel	15" TFT Touch panel	19" TFT' Touch panel	15" INOX Touch panel
Weight of complete unit	11.9 kg	16.0 kg	12.5 kg	14.4 kg	16.8 kg	15.0 kg
Control unit	4.9 kg	9.0 kg	5.5 kg	7.4 kg	9.8 kg	8.0 kg

Technical data

14.1 General specifications

Safety	12" TFT Key panel	15" TFT Key panel	12" TFT Touch panel	15" TFT Touch panel	19" TFT' Touch panel	15" INOX Touch panel
Degree of protection	<ul style="list-style-type: none"> IP65/Enclosure Type 4 with clamp mount, encircling seal and pressed-on plastic cap for USB port^{*)} IP54 with screw fastening 					IP66K, fastening with anchor clamps
Protection class	Protection class I according to IEC 61140					
Safety regulations	IEC/EN/DIN EN 60950-1					
Certifications	cULus in accordance with UL 508					
Conformity	CE					
Liability of product nonconformance	24 months					
Quality assurance	According to ISO 9001					
*) The front USB port cannot be used in some devices.						

Permissible temperature ranges depend on the type of installation

Temperature ranges			
Complete unit	Temperature in cabinet	Ambient temperature Cabinet	Comment
Installed in cabinet, different temperatures	50 °C	40 °C	<ul style="list-style-type: none"> Maximum PCI load 15 W Optical drives may not be operated with a temperature > 40° C.
Installed in cabinet, same temperature inside and outside	45 °C	45 °C	<ul style="list-style-type: none"> Complete configuration, maximum PCI load 30 W (2 slots)
These values are applicable for vertical installation and when air is flowing through the cabinet.			

Electromagnetic compatibility (EMC)	
Interference emission	EN 61000-6-4 Class A EN 61000-3-3, FCC Class A
Interference immunity: Conducted disturbance variables on supply lines	± 2 kV, according to IEC 61000-4-4, burst ± 1 kV, according to IEC 61000-4-5, surge sym. ± 2 kV, according to IEC 61000-4-5, surge asym.
Interference immunity on signal lines	± 1 kV, according to IEC 61000-4-4, burst, length < 30 m ± 2 kV, according to IEC 61000-4-4, burst, length > 30 m ± 2 kV, according to IEC 61000-4-5, surge, length > 30 m
Immunity to discharges of static electricity	± 6 kV contact discharge according to IEC 61000-4-2 ± 8 kV air discharge according to IEC 61000-4-2
Immunity to RF interference	± 2 kV, (according to IEC 61000-4-4; burst) ± 1 kV; (according to IEC 61000-4-5; surge sym.) ± 2 kV; (according to IEC 61000-4-5; surge asym.)
Magnetic field	100 A/m, 50 Hz according to IEC 61000-4-6

Climatic conditions	
Temperature <ul style="list-style-type: none"> • During operation^{1) 2)} • Installed in cabinet <ul style="list-style-type: none"> – With outside temperature of 40° C – With outside temperature of 45° C • Storage, transportation • Gradient 	Tested to IEC 60068-2-1, IEC 60068-2-2, IEC 60068-2-14 <ul style="list-style-type: none"> • +5° C to +45° C (with maximum configuration) • Inside temperature max. 50° C (with maximum total load of the slots of 15 W) • Inside temperature max. 45° C • -20° to +60° C • Maximum 10° C / h in operation, 20° C / h storage, no condensation
¹⁾ When DVD burner is in operation, an ambient temperature of +5° to +40° C is applicable.	
Relative humidity <ul style="list-style-type: none"> • During operation²⁾ • Storage, transportation • Gradient 	Tested to IEC 60068-2-78, IEC 60068-2-30 <ul style="list-style-type: none"> • 5 to 80% at 25° C (no condensation) • 5 to 95% at 25° C (no condensation) • Maximum 10° C / h, no condensation
²⁾ Under extreme environmental conditions such as high air humidity and temperature, bubbles can form on the touch surface in rare cases. This only affects the appearance and does not represent any functional restriction.	
Air pressure <ul style="list-style-type: none"> • Operation • Storage/transportation 	1080 to 795 hPa (corresponds to an altitude of -1000 to 2000 m) 1080 to 660 hPa (corresponds to an altitude of -1000 to 3500 m)

Mechanical environmental conditions	
Vibration <ul style="list-style-type: none"> • Operation • Storage, transportation 	Tested to DIN IEC 60068-2-6 <ul style="list-style-type: none"> • 10 to 58 Hz: 0.075 mm, 58 to 500 Hz: 9.8 m/s² = 1 g (10 cycles) • 5 to 9 Hz: 3.5 mm, 9 to 500 Hz: 9.8 m/s² = 1 g (10 cycles)
Shock resistance <ul style="list-style-type: none"> • Operation • Storage, transportation 	Tested to IEC 60068-2-27, IEC 60068-2-29 <ul style="list-style-type: none"> • 50 m/s² approx. 5 g, 30 ms (3 cycles per axis) • 250 m/s² approx. 25 g, 6 ms (3 cycles per axis)
Noise emission	< 55 dB(A) according to DIN 45635-1

14.2 Ports and status displays

Ports	
DVI-I	Port for external CRT / LCD monitor
USB	<ul style="list-style-type: none"> External: 4x USB 2.0 on the port side (max. 2 can be simultaneously operated as high current) There are 3 USBs available internally: 1 x USB 2.0 high current + 1x USB 2.0 low current on a 10-pin male connector, 1 x USB 2.0 low current for internal USB stick/dongle Front panel port: 1x USB 2.0 high current 1x USB 1.1 high current
PROFIBUS/MPI port Transmission rate Operating mode	9-pin sub-D socket 9.6 Kbps to 12 Mbps, configured per software Electrically isolated: <ul style="list-style-type: none"> Data lines A, B Control lines RTS AS, RTS_PG 5 V supply voltage (maximum 90 mA) grounded: Shielding of the DP12 connection line RS485, electrically isolated (within SELV) <ul style="list-style-type: none"> Configured automatically Configured automatically
<ul style="list-style-type: none"> Physical port <ul style="list-style-type: none"> Memory address area Interrupts 	
PROFINET ¹⁾	3x RJ45 connection, CP 1616 compatible onboard port based on ERTEC 400, 10/100 Mbps isolated
¹⁾ For unambiguous labeling, the LAN ports are numbered on the enclosure. The operating system numbering may deviate from this.	
Ethernet ²⁾	Wake on LAN and Remote Boot are supported Ethernet 1: Intel 82577 L, capable of teaming capable of AMT, supports jumbo frames up to 4088 bytes Ethernet 2: Intel 82574 L, capable of teaming supports jumbo frames up to 9014 bytes
COM1	Serial port, 9-pin Cannon plug
Compact Flash	Slot for Compact Flash card
Status displays	
Control unit	<ul style="list-style-type: none"> Power LED Temperature LED
Computer unit	<ul style="list-style-type: none"> Ethernet LEDs Optical drive LED DVD/CD access (to CD drive if installed) 2 x7 segment display (for BIOS post codes) 2x two-color alarm LEDs 1x LED for Profinet (optional)

*1 Electrical isolation within the safety extra-low voltage circuit (SELV)

*2 LAN interfaces are numbered on the enclosure to provide unique identification. The operating system numbering may deviate from this.

14.3 Current/power requirements of the device

Maximum current values

Component	Voltage			
	+5 V	+3.3 V	+12 V	-12 V
Base device ^{1) 2)}	8.5 A	2.3 A	0.7 A	0 A
Hard disk drive 1 x 3.5" ²⁾	0.6 A		0.5 A	
Hard disk drives 2 x 2.5" ²⁾	1.2 A			
DVD burner drive ²⁾	0.8 A			
USB ports ³⁾	1.2 A			
PCI/PCIexpress slots ³⁾	4 A	6 A	2 A	0.1 A
Internal front interfaces (on panel devices)	2.5 A	0.1 A	3.5 A	
Individual currents (max. permissible) ⁴⁾	16.5 A	8.5 A	6.5 A	0.3 A

¹⁾ Basis device contains motherboard, processor, memory, both fans, CF

²⁾ Depends on the selected device configuration

³⁾ The maximum permitted accumulated power for the PCI and USB extensions is max. 30 W.

⁴⁾ The max. permitted accumulated power of the + 5 V and + 3.3 V voltages is 90 W.

Typical power values

Component	Current consumption	Current consumption	Power consumption
	(AC-SV, U=230V)	(DC-SV, U=24V)	
Base device	0.2 A	1.9 A	45 W
Hard disk drive 1 x 3.5"	0.04 A	0.38 A	9 W
Hard disk drives 2 x 2.5"	0.03 A	0.25 A	6 W
DVD burner drive	0.02 A	0.17 A	4 W
USB expansion	0.03 A max.	0.29 A	Max. 7 W
PCI-/PCIexpress expansion	0.16 A max.	1.54 A max.	Max. 37 W
Internal front interface (on panel devices)	0.23 A max.	2.21 A max.	Max. 53 W

14.4 AC voltage supply

Technical data

Degree of protection	IP20 (in installed state)
Protection class	VDE 0106

Note

The power supply contains an active PFC (Power Factor Correction) circuit to conform to the EMC guidelines.

Uninterruptible AC power systems (UPS) must supply a sinusoidal output voltage in the normal and buffered mode when used with SIMATIC PCs with an active PFC.

UPS characteristics are described and classified in the standards EN 50091-3 and IEC 62040-3. Devices with sinusoidal output voltage in the normal and buffered mode are identified with the classification "VFI-SS-...." or "VI-SS-....".

Power supply characteristics	AC power supply
Input data	
Voltage	Nominal 100 - 240 V AC (-15% / +10%), widerange
Continuous current	Max. 2.3 A
Starting current (load-independent)	to 50 A for 1 ms
Active power	190 W
Apparent power	250 VA
Output data	
Voltages	+5 V / 16.5 A * (18.5 A peak) +3.3 V / 8.5 A * * total of 90 W permitted +12 V / 6.5 A (8 A peak) -12 V / 0.3 A
Secondary power output	Max. 150 W

Power Good signal of the AC power supply

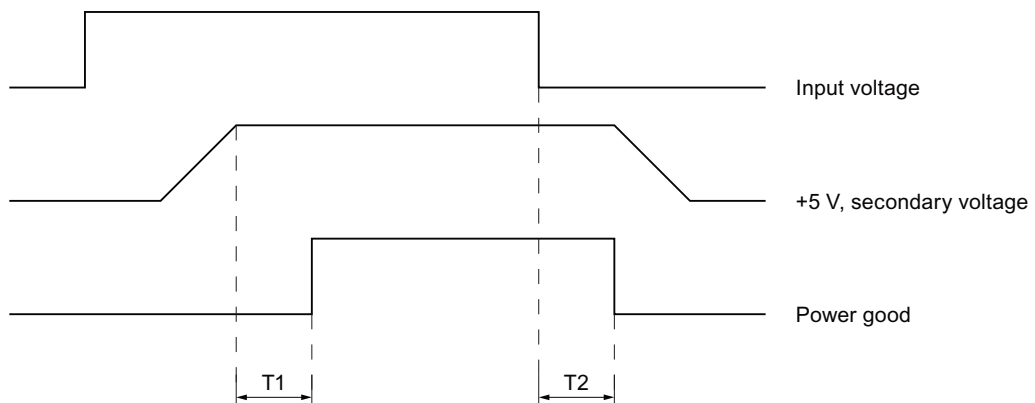

T1: preset time 50 ... 500 ms
T2: hold-up time 20 ms minimum

14.5 DC power supply

Technical data

Degree of protection	IP20 (in installed state)
Protection class	VDE 0106

1) 15 W per PCI slot included

Power supply characteristics	DC power supply
Input data	
Voltage	Nominal 24 V DC (-20% / +20%), SELV
Continuous current	Max. 8 A
Starting current (load-independent)	to 14 A for 30 ms
Active power	190 W
Output data	
Voltages	+5 V / 16.5 A * (18.5 A peak) +3.3 V / 8.5 A * * total of 90 W permitted +12 V / 6.5 A (8 A peak) -12 V / 0.3 A
Secondary power output	Max. 150 W

Power Good signal of the DC power supply

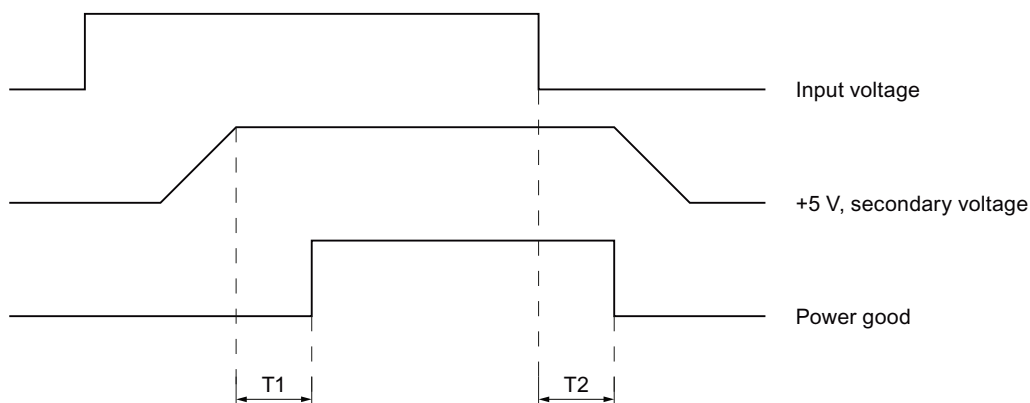

T1: preset time 50 ... 500 ms
T2: hold-up time 20 ms minimum

14.6 Keyboard table

Key codes

The following table applies only to control units with key panels. It contains all characters that can be entered in SIMATIC KeyTools in the "Key code table" area and under "User specific". The character that is triggered by pressing a specific key is listed in the "Display/function" column. Further information is available in the documentation for SIMATIC KeyTools on the "Documentation and Drivers" CD.

Name	Code (Hex) 0x	Check-box	Display/function
a A	4	—	a
		L Shift/R Shift	A
		R Alt	á
		R Alt+L Shift/R Shift	Á
b B	5	—	b
		L Shift/R Shift	B
c C	6	—	c
		L Shift/R Shift	C
		R Alt	©
		R Alt+L Shift/R Shift	¢
		L Ctrl/R Ctrl	Copy
d D	7	—	d
		L Shift/R Shift	D
		R Alt	ð
		R Alt+L Shift/R Shift	Ð
e E	8	—	e
		L Shift/R Shift	E
		R Alt	é
		L Shift/R Shift	É
		L Gui/R Gui	Start Windows Explorer
f F	9	—	f
		L Shift/R Shift	F
		L Gui/R Gui	Find folder and file
g G	0A	—	g
		L Shift/R Shift	G
h H	0B	—	h
		L Shift/R Shift	H
i I	0C	—	i
		L Shift/R Shift	I

Name	Code (Hex) 0x	Check-box	Display/function
		R Alt	í
		R Alt+L Shift/R Shift	Í
j J	0D	—	j
		L Shift/R Shift	J
k K	0E	—	k
		L Shift/R Shift	K
l L	0F	—	l
		L Shift/R Shift	L
		R Alt	ø
		R Alt+L Shift/R Shift	Ø
m M	10	—	m
		L Shift/R Shift	M
		R Alt	μ
		L Gui/R Gui	Minimize all windows
n N	11	—	n
		L Shift/R Shift	N
		R Alt	ñ
		R Alt+L Shift/R Shift	Ñ
o O	12	—	o
		L Shift/R Shift	O
		R Alt	ó
		R Alt+L Shift/R Shift	Ó
		L Ctrl/R Ctrl	Open
p P	13	—	p
		L Shift/R Shift	P
		R Alt	ö
		R Alt+L Shift/R Shift	Ö
		L Ctrl/R Ctrl	Printing
q Q	14	—	q
		L Shift/R Shift	Q
		R Alt	ä
		R Alt+L Shift/R Shift	Ä
r R	15	—	r
		L Shift/R Shift	R
		R Alt	®
		L Gui/R Gui	Display "Run" dialog
s S	16	—	s

14.6 Keyboard table

Name	Code (Hex) 0x	Check-box	Display/function
		L Shift/R Shift	S
		R Alt	ß
		R Alt+L Shift/R Shift	§
		L Ctrl/R Ctrl	Save
t T	17	—	t
		L Shift/R Shift	T
		R Alt	þ
		R Alt+L Shift/R Shift	þ
u U	18	—	u
		L Shift/R Shift	U
		R Alt	ú
		R Alt+L Shift/R Shift	Ú
v V	19	—	v
		L Shift/R Shift	V
		L Ctrl/R Ctrl	Paste
w W	1A	—	w
		L Shift/R Shift	W
		R Alt	å
		R Alt+L Shift/R Shift	Å
x X	1B	—	x
		L Shift/R Shift	X
		L Ctrl/R Ctrl	Cut
y Y	1C	—	y
		L Shift/R Shift	Y
		R Alt	ü
		R Alt+L Shift/R Shift	Ü
z Z	1D	—	z
		L Shift/R Shift	Z
		R Alt	æ
		R Alt+L Shift/R Shift	Æ
		L Ctrl/R Ctrl	
1 !	1E	—	1
		L Shift/R Shift	!
		R Alt	ı
		R Alt+L Shift/R Shift	ı
2 @	1F	—	2
		L Shift/R Shift	@

Name	Code (Hex) 0x	Check-box	Display/function
		R Alt	²
3 #	20	—	3
		L Shift/R Shift	#
		R Alt	³
4 \$	21	—	4
		L Shift/R Shift	\$
		R Alt	¤
		R Alt+L Shift/R Shift	£
5 %	22	—	5
		L Shift/R Shift	%
		R Alt	€
6 ^	23	—	6
		L Shift/R Shift	^
		R Alt	¼
7 &	24	—	7
		L Shift/R Shift	&
		R Alt	½
8 *	25	—	8
		L Shift/R Shift	*
		R Alt	¾
9 (26	—	9
		L Shift/R Shift	(
		R Alt	'
0)	27	—	0
		L Shift/R Shift)
		R Alt	'
Return	28	—	Return
Escape	29	—	Escape
Backspace	2A	—	Backspace
Tab	2B	—	Tab
Space	2C	—	Space
- _	2D	—	-
		L Shift/R Shift	_
		R Alt	¥
= +	2E	—	=
		L Shift/R Shift	+
		R Alt	×
		R Alt+L Shift/R Shift	÷
[{	2F	—	[
		L Shift/R Shift	{

14.6 Keyboard table

Name	Code (Hex) 0x	Check-box	Display/function
		R Alt	«
] }	30	—] }
		L Shift/R Shift	}
		R Alt	»
\	31	—	\
		L Shift/R Shift	
		R Alt	¬
		R Alt+L Shift/R Shift	¡
Europe 1	32	—	Europe 1
; :	33	—	;
		L Shift/R Shift	:
		R Alt	¶
		R Alt+L Shift/R Shift	°
' "	34	—	
		L Shift/R Shift	"
		R Alt	'
		R Alt+L Shift/R Shift	¨
' ~	35	—	'
		L Shift/R Shift	~
, <	36	—	,
		L Shift/R Shift	<
		R Alt	ç
		R Alt+L Shift/R Shift	Ç
. >	37	—	.
		L Shift/R Shift	>
/ ?	38	—	/
		L Shift/R Shift	?
		R Alt	¿
Caps Lock	39	—	Caps Lock
F1	3A	—	F1
		L Shift/R Shift	F13
		L Ctrl/R Ctrl	S5
F2	3B	—	F2
		L Shift/R Shift	F14
		L Ctrl/R Ctrl	S6
F3	3C	—	F3
		L Shift/R Shift	F15
		L Ctrl/R Ctrl	S7
F4	3D	—	F4

Name	Code (Hex) 0x	Check-box	Display/function
		L Shift/R Shift	F16
		L Ctrl/R Ctrl	S8
F5	3E	—	F5
		L Shift/R Shift	F17
		L Ctrl/R Ctrl	S9
F6	3F	—	F6
		L Shift/R Shift	F18
		L Ctrl/R Ctrl	S10
F7	40	—	F7
		L Shift/R Shift	F19
		L Ctrl/R Ctrl	S11
F8	41	—	F8
		L Shift/R Shift	F20
		L Ctrl/R Ctrl	S12
F9	42	—	F9
		L Shift/R Shift	S1
		L Ctrl/R Ctrl	S13
F10	43	—	F10
		L Shift/R Shift	S2
		L Ctrl/R Ctrl	S14
F11	44	—	F11
		L Shift/R Shift	S3
		L Ctrl/R Ctrl	S15
F12	45	—	F12
		L Shift/R Shift	S4
		L Ctrl/R Ctrl	S16
Print Screen, F _N +INS	46	—	Print Screen, F _N +INS
Scroll Lock	47	—	Scroll Lock
Break, Ctrl+Pause	48	—	Break, Ctrl+Pause
Pause	48	—	Pause
Insert	49	—	Insert
Home	4A	—	Home
Page Up	4B	—	Page Up
Delete	4C	—	Delete
End	4D	—	End
Page Down	4E	—	Page Down
Right Arrow	4F	—	Right Arrow
Left Arrow	50	—	Left Arrow
Down Arrow	51	—	Down Arrow
Up Arrow	52	—	Up Arrow
Num Lock	53	—	Num Lock
Keypad /	54	—	Keypad /

14.6 Keyboard table

Name	Code (Hex) 0x	Check-box	Display/function
Keypad *	55	—	Keypad *
Keypad -	56	—	Keypad -
Keypad +	57	—	Keypad +
Keypad Enter	58	—	Keypad Enter
Keypad 1 End	59	—	Keypad 1 End
Keypad 2 Down	5A	—	Keypad 2 Down
Keypad 3 PageDn	5B	—	Keypad 3 PageDn
Keypad 4 Left	5C	—	Keypad 4 Left
Keypad 5	5D	—	Keypad 5
Keypad 6 Right	5E	—	Keypad 6 Right
Keypad 7 Home	5F	—	Keypad 7 Home
Keypad 8 Up	60	—	Keypad 8 Up
Keypad 9 PageDn	61	—	Keypad 9 PageDn
Keypad 0 Insert	62	—	Keypad 0 Insert
Keypad . Delete	63	—	Keypad . Delete
Europe 2	64	—	Europe 2
App	65	—	App
Keyboard Power	66	—	Keyboard Power
Keypad =	67	—	Keypad =
F13	68	—	F13
F14	69	—	F14
F15	6A	—	F15
F16	6B	—	F16
F17	6C	—	F17
F18	6D	—	F18
F19	6E	—	F19
F20	6F	—	F20
F21	70	—	F21
F22	71	—	F22
F23	72	—	F23
F24	73	—	F24
Left Control	E0	—	Left Control
Left Shift	E1	—	Left Shift
Left Alt	E2	—	Left Alt
Left GUI	E3	—	Left GUI
Right Control	E4	—	Right Control
Right Shift	E5	—	Right Shift
Right Alt	E6	—	Right Alt
Right GUI	E7	—	Right GUI

Dimensional drawings

15.1 Dimension drawing IPC

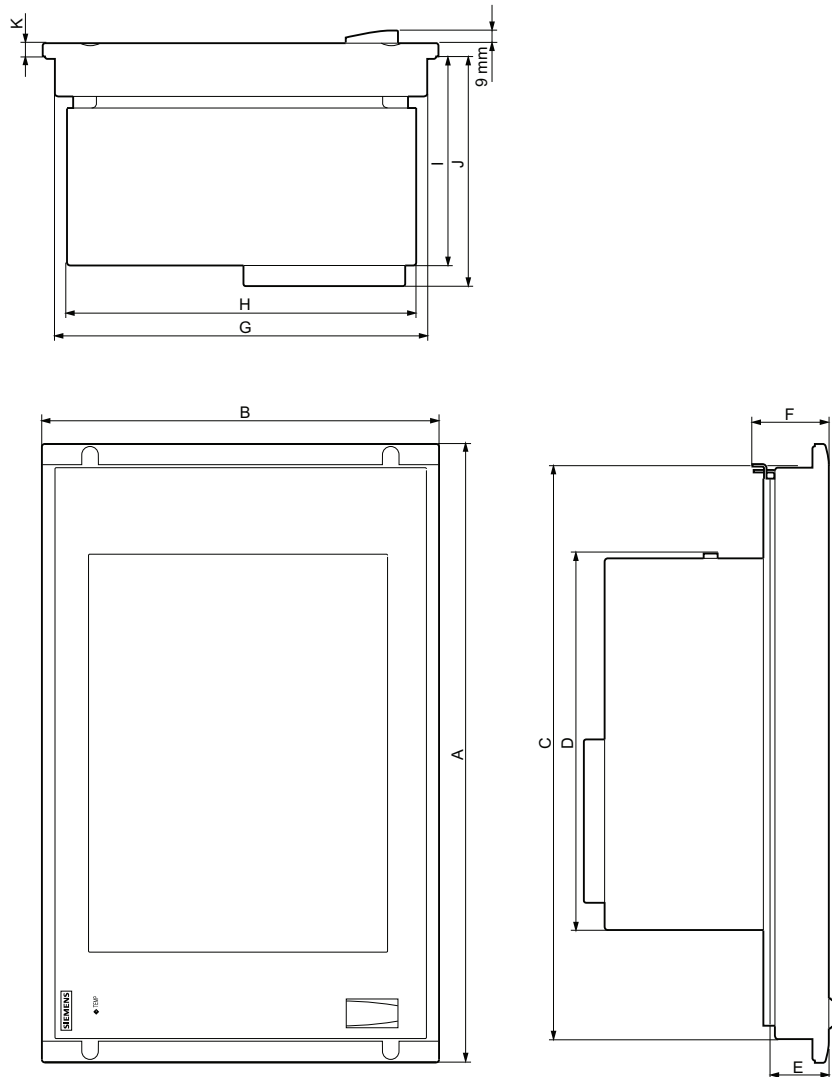

Figure 15-1 Dimension drawing IPC

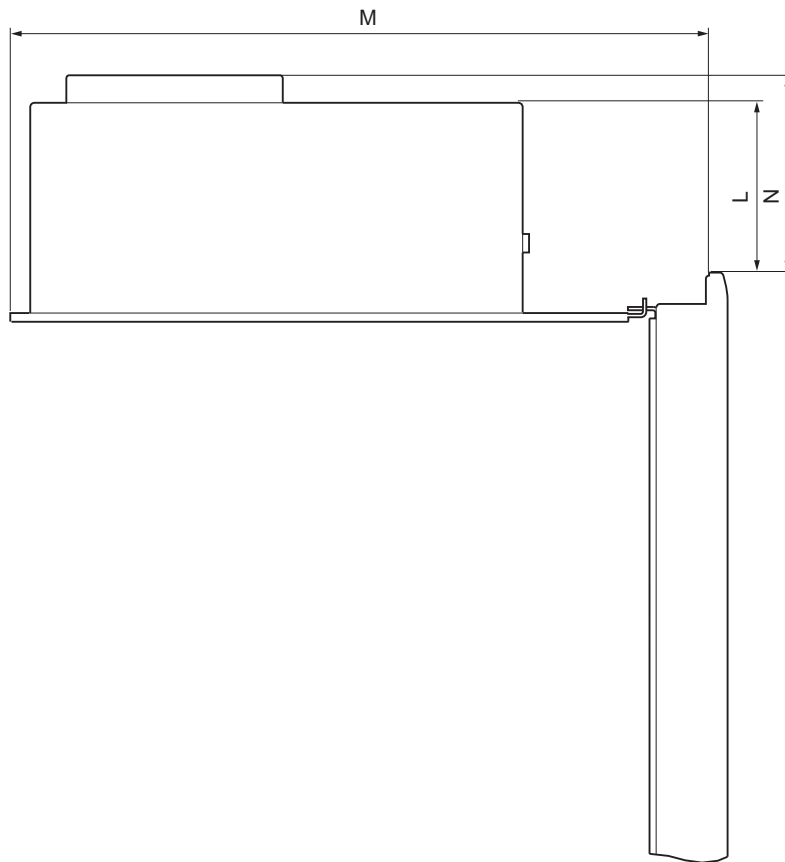

Figure 15-2 Dimension drawing IPC, computer unit swung away from control unit

Table 15- 1 Dimensions of IPC677C in mm

Control unit	Key panel		Touch panel			
	12" TFT	15" TFT	12" TFT	15" TFT	15" TFT INOX	19" TFT
A	482.6	482.6	400.0	482.6	482.6	482.6
B	310.3	354.8	310.3	310.3	310.3	400.0
C	447.2	447.2	366.0	450.0	450.0	450.0
D	314.9	314.9	314.9	314.9	314.9	314.9
E	30.8	49.8	37.8	46.6	46	56.1
F	39.8	59.8	48.3	58.6	60	68.1
G	288.3	324.4	288.3	288.3	288.3	378.0
H	270.4	270.4	270.4	270.4	270.4	270.4
I	104.5	123.5	123.0	120.3	126	129.5
J	121.9	140.9	141	138	135	147
K	10.5	10.5	10.5	10.5	6	10.8
L	41.9	30.0	53.4	24.4	20	18.4
M	350.6	369.0	369.1	366.5	371	375.6
N	59.3	48.1	70.8	41.8	38.1	35.8

15.2 Dimensional drawings for the installation of expansion modules

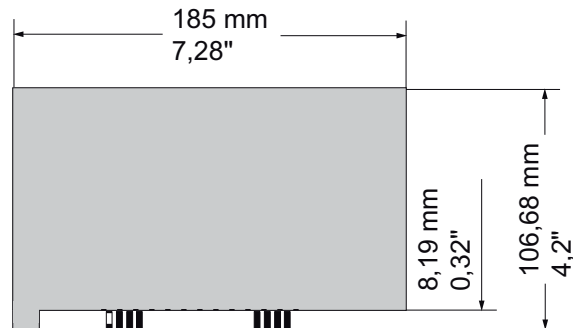

Figure 15-3 Short PCI or PCI Express modules

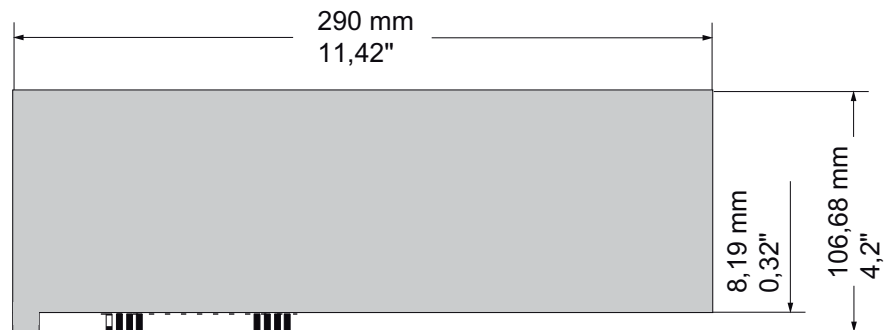

Figure 15-4 Maximum size of PCI module

Detailed descriptions

16.1 Motherboard

16.1.1 Structure and functions of the motherboard

The essential components of the motherboard are the processor and the chip set, two slots for memory modules, internal and external interfaces and the Flash BIOS.

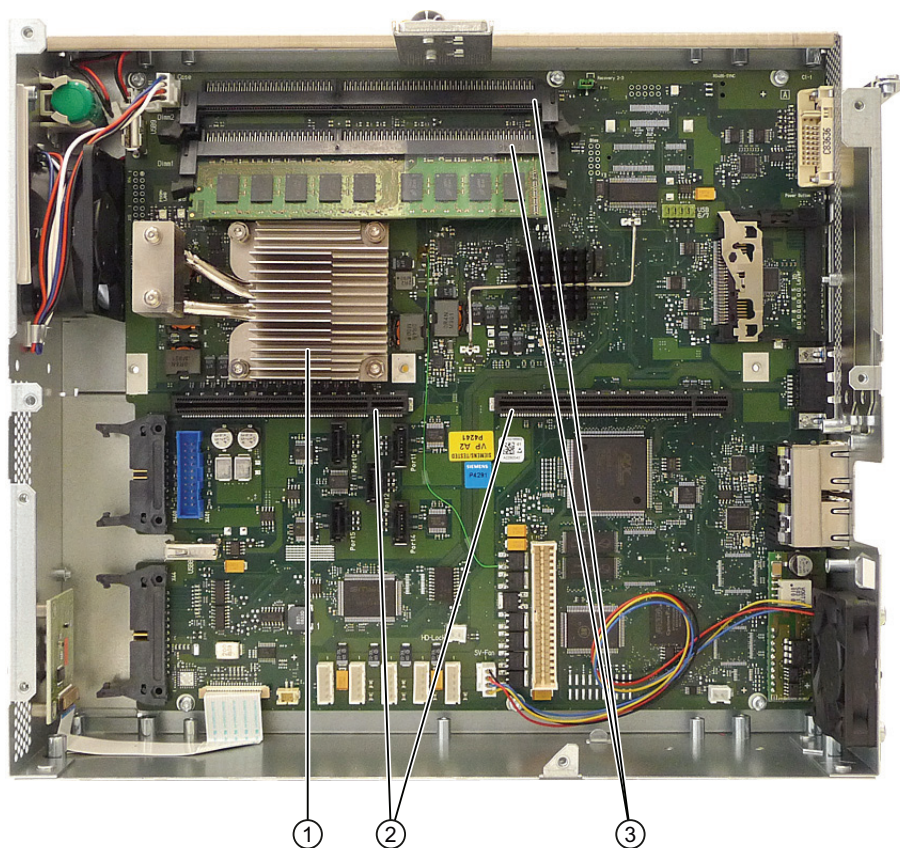

①	Processor heat sink
②	Slot for the bus board
③	Two memory module slots

16.1.2 Technical features of the motherboard

Component / interface	Description	Characteristics
Chip set	Single chip set	<ul style="list-style-type: none"> Mobile Intel® QM57 Express Chipset
BIOS	Update by means of software	<ul style="list-style-type: none"> InsideH20 Setup Utility Rev. 3.x
CPU	<ul style="list-style-type: none"> Intel® Celeron P4505 1.86 GHz Intel® Core i3-330E 2.13 GHz Intel® Core i7-610E 2.53 GHz 	<ul style="list-style-type: none"> 2 MB second-level cache, 2 cores / 2 threads, virtualization 3 MByte second level cache, 2 cores /4 threads, hyperthreading, virtualization 4 MB second-level cache, 2 cores /4 threads, hyper-threading, turbo boost, virtualization, AMT
Memory	2 sockets maximum 4 GB SDRAM DDR3	<ul style="list-style-type: none"> 64-bit/72-bit data bus width (without ECC / with ECC) 3.3 V SDRAM DDR3 in accordance with PC3-8500 specifications
Graphics	integrated in chip set	<ul style="list-style-type: none"> Onboard Intel® Graphics Media Accelerator HD Graphics Controller 2-D and 3-D engine integrated in chipset Dynamic Video Memory Technology (uses up to 256 MB of RAM) CRT: <ul style="list-style-type: none"> Max. 1280x1024 at 100 Hz / 32-bit color depth Max. 1600x1200 at 60 Hz / 32-bit color depth Maximum resolution: 2038x1536 at 75 Hz / 16-bit color depth LCD via DVI-I: 1600x1200 at 60 Hz / 32-bit color depth
Hard disk	2 channels, Serial ATA	<p>3.5" / 2.5" serial ATA, see ordering documentation for the hard disk capacity</p> <ul style="list-style-type: none"> - 3 Gbps data transmission rate - supports NCQ (Native Command Queuing; SATA II property)
Flash memory	CompactFlash card	
	Solid-state drive	
RAID	Onboard Serial ATA	<ul style="list-style-type: none"> Intel BD82QM57 RAID 0, 1, 0+1
DVD Burner ³	connection, Serial ATA	<ul style="list-style-type: none"> UDMA-capable, ATA33

Component / interface	Description	Characteristics
PROFIBUS/MPI ²	Communication port SIMATIC S7	<ul style="list-style-type: none"> • Potential isolated ¹ CP 5611 compatible • 12 Mbps
PROFINET ²	Communication interface for PROFINET IO applications and SIMATIC installations	<ul style="list-style-type: none"> • 10/100 Mbps, electrically isolated ¹ • CP 1616 compatible 3 port interface
USB	Universal Serial Bus	<ul style="list-style-type: none"> • External: 4 x USB 2.0 on the port side (max. 2 can be simultaneously operated as high current) • There are 3 USBs available internally: 2x for connecting a cover with USB ports as an extension - 1x for UFDs • Front panel ports: 1 x USB 2.0 high current, 1x USB 1.1 high current
Ethernet	2x 10BaseT/100Base-TX	<ul style="list-style-type: none"> • 10/100/1000 Mbps, electrically isolated¹ • Ethernet 1: Intel 82577 L, capable of AMT, supports jumbo frames up to 4088 bytes • Ethernet 2: Intel 82574 L, supports jumbo frames up to 9014 bytes

¹ Electrically isolated within the safety extra-low voltage circuit (SELV)

² Optional product variant

³ Depends on the selected device configuration

16.1.3 Position of the interfaces on the motherboard

Ports

The motherboard of the device features the following interfaces:

- Interfaces for the connection of external devices
- Interfaces for internal components (drives, bus boards etc.)

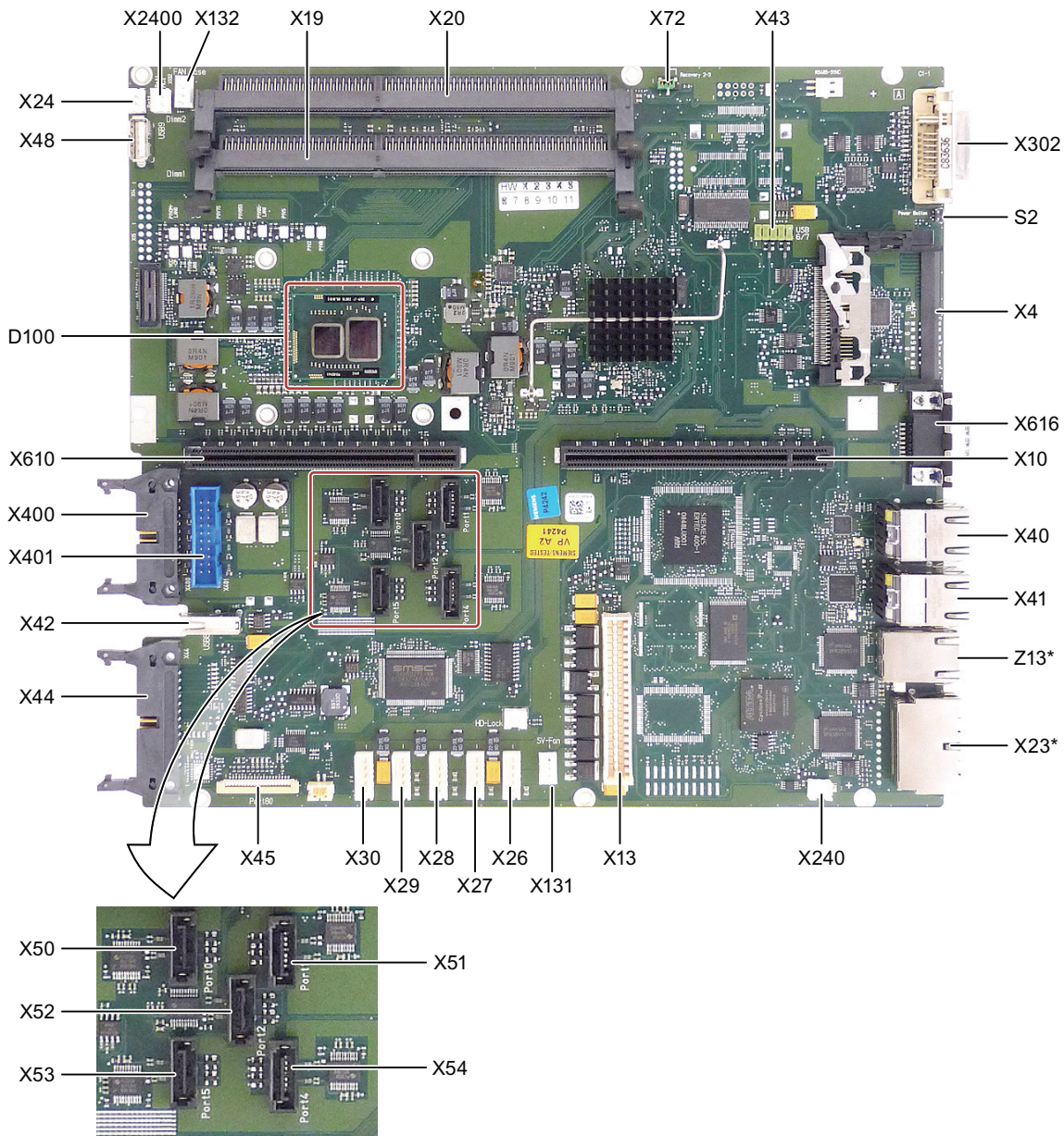

Figure 16-1 Interfaces on the motherboard

* Optional product variant

16.1.4 External ports

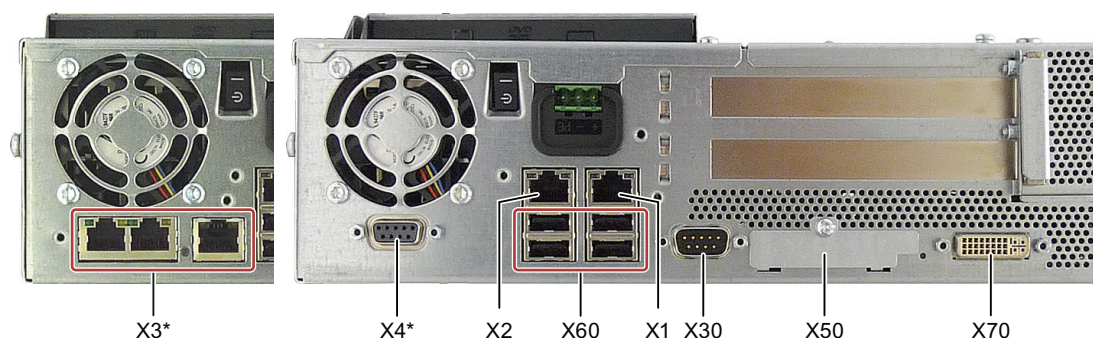

Figure 16-2 Connector pin assignment on the port

* Optional product variant

Table 16- 1

Interface	Position	Connector	Description
USB 2.0	external	X60	Lower USB channel 0, upper USB channel 1 Lower USB channel 2, upper USB channel 3
PROFIBUS/MPI	external	X4	9-pin, standard socket, electrically isolated interface
PROFINET	external	X3	Three RJ45 ports
Ethernet	external	X1 X2	First RJ45 port Second RJ45 port
DVI-I	external	X70	26-pin socket
Compact Flash	external	X50	50-pin CF socket, types I / II
COM1	external	X30	Serial port

USB ports, X60

The Universal Serial Bus interfaces have the following pinout:

USB interface			
Pin no.	Short description	Meaning	Input / Output
1	VCC	+ 5 V (fused)	Output
2	- Data	Data channel	Input / Output
3	+ Data	Data channel	Input / Output
4	GND	Ground	-

The connectors are of type A.

All ports are designed as high current USB (500 mA), you can only use a maximum of 2 simultaneously as high current, however.

NOTICE
No USB devices can be connected which feed back voltage to the Box PC.

PROFIBUS/MPI interface X4

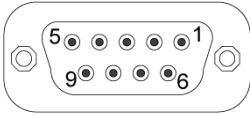
PROFIBUS/MPI interface ¹			
			
Pin no.	Short description	Meaning	Input / Output
1	–	Unassigned	–
2	–	Unassigned	–
3	LTG_B	Signal line B of MPI module	Input/output
4	RTS_AS	RTSAS, control signal for received data stream. The signal is "1" when the directly connected AS is sending.	Input
5	M5EXT	M5EXT return line (GND) of 5 V supply. The current load of an external consumer connected between P5EXT and M5EXT may not exceed the 90 mA.	Output
6	P5 EXT	P5EXT power supply (+5 V) of the 5 V power supply. The current load of an external consumer connected between P5EXT and M5EXT may not exceed the 90 mA.	Output
7	–	Unassigned	–
8	LTG_A	Signal line A of the MPI module	Input/output
9	RTS_PG	RTS output signal of the MPI module. The control signal is "1" when the programming device is sending.	Output
Shield		on connector casing	

¹ Optional product variant

PROFINET LAN X3 Port P1, P2, P3

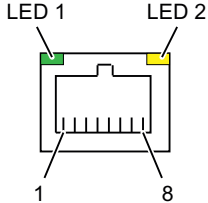
PROFINET interface ¹			
			
Pin no.	Short description	Meaning	Input / Output
1	RD+	Receive data *	Input
2	RD-	Receive data *	Input
3	TD+	Transmit data *	Output
4, 5 ¹⁾	SYMR	Internal with 75 Ohm terminating resistor	_
6	TD-	Receive data *	Output
7, 8 ¹⁾	SYMT-	Internal with 75 Ohm terminating resistor	_
S		Shield	
	LED 1	Lit green: link	
	LED 2	Lights up yellow: activity	
* Auto negotiation and auto crossover supported			

¹ Optional product variant

Ethernet RJ45 connection, X1, X2

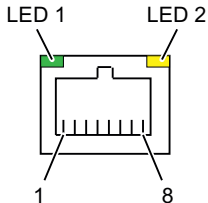
Ethernet RJ45 connection			
			
Pin no.	Short description	Meaning	Input / Output
1	BI_DA+	Bi-directional data A+	Input / Output
2	BI_DA-	Bi-directional data A-	Input / Output
3	BI_DB+	Bi-directional data B+	Input / Output
4	BI_DC+	Bi-directional data C+	Input / Output
5	BI_DC-	Bi-directional data C-	Input / Output
6	BI_DB-	Bi-directional data B-	Input / Output
7	BI_DD+	Bi-directional data D+	Input / Output
8	BI_DD-	Bi-directional data D-	Input / Output
S		Shield	-

Ethernet RJ45 connection			
	LED 1	Off: 10 Mbps Lit in green color: 100 Mbps Lit in orange color: 1000 Mbps	–
	LED 2	Lit: Active connection (to a hub, for example) Flashing: Activity	–

Note

The interfaces available on the device have been numbered so they can be clearly distinguished. This numbering may deviate from the numbering provided by the respective operating system.

DVI-I port, X70

DVI-I port			
Pin no.	Short description	Meaning	Input / Output
S	GND	Ground	–
S1	GND	Ground	–
C1	R	Red	Output
C2	G	Green	Output
C3	B	Blue	Output
C4	HSYNC	Horizontal synchronizing pulse	Output
C5	GND	Ground	–
CSA	GND	Ground	–
1	TX2N	TDMS data 2-	Output
2	TX2P	TDMS data 2+	Output
3	GND	Ground	–
4	NC	Unassigned	–
5	NC	Unassigned	–
6	DDC CLK	DDC clock	Input / Output
7	DDC CLK	DDC data	Input / Output
8	VSYNC	Vertical synchronizing pulse	Output
9	TX1N	TDMS data 1-	Output
10	TX1P	TDMS data 1+	Output
11	GND	Ground	–
12	NC	Unassigned	–
13	NC	Unassigned	–

DVI-I port			
14	+5 V	+5 V	Output
15	GND	Ground	–
16	MONDET	Hotplug detect	Input
17	TX0N	TDMS data 0-	Output
18	TX0P	TDMS data 0+	Output
19	GND	Ground	–
20	NC	Unassigned	–
21	NC	Unassigned	–
22	GND	Ground	–
23	TXCP	TDMS clock +	Output
24	TXCN	TDMS clock -	Output

Compact Flash card, X50

Compact Flash card port		
Pin no.	Short description	Meaning
41	RESET#	Reset (output)
7	CS0#	Chip select 0(output)
32	CS1#	Chip select 1(output)
34	IORD#	I/O read (output)
35	IOWR#	I/O write (output)
20, 19, 18,	A0-A2	Address bit 0-2 (output)
17, 16, 15, 14, 12, 11, 10, 8	A3-A10	Address bit 3-10 (output) to ground
21, 22, 23, 2, 3, 4, 5, 6, 47, 48, 49, 27, 28, 29, 30, 31	D0-D15	Data bits 0-15 (in/out)
37	INTRQ	Interrupt request (input)
9	OE# /ATA SEL#	Enables True IDE mode
24	IOCS16#	I/O-chip select 16 (input)
39	CSEL#	Cable select (output)
42	IORDY	I/O ready (input)
46	PDIAG#	Passed diagnostic
45	DASP#	Drive active/slave present (not connected)
26, 25	CD1#, CD2#	Card detect (not connected)
33, 40	VS1#, VS2#	Voltage sense (not connected)
43	DMARQ	DMA request (input)
44	DMACK#	DMA acknowledge (output)
36	WE#	Write enable
1, 50	GND	Ground
13, 38	VCC	+ 3.3V power

Serial interface COM 1, X30

The COM1 serial port has the following pin assignment:

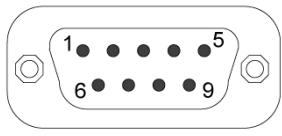
Serial interface COM1			
			
Pin no.	Short description	Meaning	Input / Output
1	DCD (M5)	Receive signal (carrier)	Input
2	RxD (D2)	Receive data	Input
3	TxD (D1)	Transmit data	Output
4	DTR (S1)	Data terminal ready	Output
5	GND (E2)	Functional ground (reference potential)	–
6	DSR (M1)	Ready for operation	Input
7	RTS (S2)	Request to send	Output
8	CTS (M2)	Clear to send	Input
9	RI (M3)	Incoming call	Input

16.1.5 Internal interfaces

Pin assignment of the internal ports

Interface	Position	Connector	Description
Memory	Internal	X19, X20	2 DIMM sockets, 64-bit
Bus expansion	Internal	X10, X610	Socket for bus expansion, assigned PCI bus signals
Power supply	Internal	X13	20-pin connector plug for power supply
BIOS Recovery	Internal	X72	
Serial ATA	Internal	X50, X51, X52, X53, X54	Serial ATA, max. 3 drives operable
Connection for PS serial ATA	Internal	X26, X27, X28, X29, X30	Voltage supply for serial ATA
Connection for PS fan	Internal	X131	Voltage supply for CPU fan, 4-pin male connector
Connection for equipment fan	Internal	X132	Voltage supply for equipment fan, 4-pin male connector
Backup battery	Internal	X24, X240	Voltage supply for backup battery, 2-pin male connector
Tap for backup battery	Internal	X2400	Voltage tap (= 3V) of the backup battery, 2-pin, male connector
USB interface	Internal	X43	USB channel 6 and 7, 10-pole male connector
USB interface	Internal	X48	USB channel 9, upright USB socket

Pin assignment of the equipment fan, X132

Pin no.	Short description	Meaning	Input / Output
1	GND	Ground	-
2	+12 V	Switched voltage supply	Output
3	CPU FAN_CLK	Clock signal	Input

Pin assignment of the supply for the power supply fan, X131

Pin no.	Short description	Meaning	Input / Output
1	GND	Ground	-
2	+12 V	Switched voltage supply	Output
3	PG1 FAN_CLK	Clock signal	Input

Connection for backup battery, X24, X240 (BATT)

A battery for buffering the CMOS RAM is connected to this connector. This is a 3 V Lithium battery with a capacity of 750 mAh.

Pin no.	Short description	Meaning	Input / Output
1	+	Plus pole	Input
2	-	Minus pole	-

Tap of the backup battery, X2400 (OUT)

This connection is intended for expansion modules with on-board CMOS-RAM. The voltage of the backup battery can be tapped here to backup the CMOS RAM data of the expansion module.

Pin no.	Short description	Meaning	Input / Output
1	+	Plus pole	Output
2	-	Minus pole	-

Note

No battery should be connected to this connection.

Pin assignment of the supply for the serial ATA drives X26, X27, X28, X29, X30

Pin no.	Short description	Meaning	Input / Output
1	+12 V	Voltage supply	Output
2	GND	Ground	-
3	GND	Ground	-
4	+5 V	Voltage supply	Output
5	+3.3 V	Voltage supply	Output

Pin assignment of the internal USB interface connector, X43

Pin no.	Short description	Meaning	Input / Output
1	VCC 5V	+ 5 V, fused	Output
2	VCC 5V	+ 5 V, fused	Output
3	USB3	USB3_M	Input / Output
4	USB5	USB5_M	Input / Output
5	USB3	USB3_P	Input / Output
6	USB5	USB5_P	Input / Output
7	GND	Ground	–
8	GND	Ground	–
9	GND	Ground	–
10	GND	Ground	–

16.1.6 Front ports**Overview**

Interface	Position	Connector	Description
Display (LVDS)	Internal	X400	Connection of LCD displays with LVDS interface (channel 1)
Display (LVDS)	Internal	X401	Connection of LCD displays with LVDS interface (channel 2)
I/O front	Internal	X44	Ports for front I/O, including USB channel 10
USB	Internal	X42	Internal USB 2.0 interface (USB channel 8)

Display interfaces

TFT displays with an LVDS interface can be connected to this interface. You can connect 18-bit displays with a resolution up to 1024 x 768 pixels on X400 only (single-channel LVDS), and of 1280 x 1024 pixels on X400 and X401 (dual-channel LVDS). On the X401, there is also +12 V as supply voltage for the backlight inverter (max. 4.2 A) for 19" / Dual Channel LVDS displays. The permitted display clock rate is 20 MHz to 66 MHz. The display is selected automatically based on the code of the display select inputs.

The display power supply voltages 3.3 V and 5 V are switched via the graphic controller depending on the requirements of the connected display units. The maximum cable length is 50 cm at a transmission rate of 455 MHz. Special cable properties are required for the differential cable pairs specified by the LVDS specification.

Display interface (1st LVDS channel), X400

Pin no.	Short description	Meaning	Input / Output
1	P5V_D_fused	+5V (fused) display VCC	Output
2	P5V_D_fused	+5V (fused) display VCC	Output
3	RXIN0-	LVDS output signal bit 0 (-)	Output
4	RXIN0+	LVDS output signal bit 0 (+)	Output
5	P3V3_D_fused	+3.3V (fused) display VCC	Output
6	P3V3_D_fused	+3.3V (fused) display VCC	Output
7	RXIN1-	LVDS output signal bit 1 (-)	Output
8	RXIN1+	LVDS output signal bit 1 (+)	Output
9	GND	Ground	-
10	GND	Ground	-
11	RXIN2-	LVDS output signal bit 2 (-)	Output
12	RXIN2+	LVDS output signal bit 2 (+)	Output
13	GND	Ground	-
14	GND	Ground	-
15	RXCLKIN-	LVDS clock signal (-)	Output
16	RXCLKIN+	LVDS clock signal (+)	Output
17	GND	Ground	-
18	GND	Ground	-
19	NC	Unassigned	-
20	NC	Unassigned	-

Display interface (2nd LVDS channel), X401

Pin no.	Short description	Meaning	Input / Output
1	GND	Ground	-
2	GND	Ground	-
3	RXIN10-	LVDS input signal bit 0 (-)	Output
4	RXIN10+	LVDS input signal bit 0 (+)	Output
5	GND	Ground	Output
6	GND	Ground	Output
7	RXIN11-	LVDS input signal bit 1 (-)	Output
8	RXIN11+	LVDS input signal bit 1 (+)	Output
9	GND	Ground	-
10	GND	Ground	-
11	RXIN12-	LVDS input signal bit 2 (-)	Output
12	RXIN12+	LVDS input signal bit 2 (+)	Output
13	GND	Ground	-
14	GND	Ground	-
15	RXCLKIN1-	LVDS clock signal (-)	Output
16	RXCLKIN1+	LVDS clock signal (+)	Output
17	GND	Ground	-

Pin no.	Short description	Meaning	Input / Output
18	P12VF	+12 V fused	Output
19	P12VF	+12 V fused	Output
20	P12VF	+12 V fused	Output

Assignment of the display to the display select pins

One of the 15 available displays is configured automatically via the display select inputs. The display select inputs are connected to pull-up resistors, i.e. if these inputs are not interconnected, they are high level. The input must be connected to ground to generate a low level.

Pin no.	LCD_SEL3	LCD_SEL2	LCD_SEL1	LCD_SEL0	Display type
0	low	low	low	low	reserved
1	low	low	low	high	1280 x 1024 (SXGA), TFT, 2 x 18-bit, LVDS channel 1 and 2
2	low	low	high	low	DVI LCD 640 x 480
3	low	low	high	high	DVI LCD 800 x 600
4	low	high	low	low	640 x 480 (VGA), TFT, 18 bits, LVDS channel 1
5	low	high	low	high	reserved
6	low	high	high	low	1024 x 768 (XGA), TFT, 18 bits, LVDS channel 1
7	low	high	high	high	800 x 600 (SVGA), TFT, 18 bits, LVDS channel 1
8	high	low	low	low	reserved
9	high	low	low	high	reserved
10	high	low	high	low	reserved
11	high	low	high	high	reserved
12	high	high	low	low	1024 x 768 (XGA), TFT, 2 x 18-bit, LVDS channel 1 and 2
13	high	high	low	high	DVI LCD 1024 x 768
14	high	high	high	low	DVI LCD 1280 x 1024
15	high	high	high	high	No LVDS display or DVI LCD with automatic DDC ID

I/O front port for operator panels, X44

This port carries all signals required for connecting operator panels in addition to the display interface. The maximum cable length is 50 cm at a USB data rate of 12 Mbps.

Pin no.	Short description	Meaning	Input / Output
1	GND	Ground	-
2	P12V	Inverter voltage supply	Output
3	BL_ON	Backlight on (5 V = On)	Output
4	P5V_fused	+5 V (fused)	Output
5	GND	Ground	-
6	P3V3_fused	+3.3 V VCC (fused)	Output

Pin no.	Short description	Meaning	Input / Output
7	Reserved	Reserved	-
8	Reserved	Reserved	-
9	Reserved	Reserved	-
10	Reserved	Reserved	-
11	P5V_fused	+5 V (fused)	Output
12	USB_D1M	USB data channel 10	Input / Output
13	USB_D1P	USB data+, channel 10	Input / Output
14	GND	Ground	-
15	LCD_SEL0	Display Type-Select Signal 0	Input
16	LCD_SEL1	Display Type-Select Signal 1	Input
17	LCD_SEL2	Display Type-Select Signal 2	Input
18	LCD_SEL3	Display Type-Select Signal 3	Input
19	RESET_N	Reset signal (active low)	Input
20	reserved	Reserved	-
21	HD_LED	HD LED, anode with 1 kOhm in series on the motherboard	Output
22	DP_LED	MPI/DP LED, anode via 1 kOhm in series on the motherboard	Output
23	Ethernet_LED	Ethernet LED, anode with 1 kOhm in series on the motherboard	Output
24	TEMP_ERR	Temperature error LED, anode with 1 kOhm in series on the motherboard	Output
25	RUN_R	Watchdog error LED, anode with 1 kOhm in series on the motherboard	Output
26	RUN_G	Watchdog OK LED, anode with 1 kOhm in series on the motherboard	Output

Pin Assignment of the USB 2.0 interface, X42

Pin no.	Short description	Meaning	Input / Output
1	VCC	+ 5 V, fused	Output
2	USB5	USB5_M	Input / Output
3	USB5	USB5_P	Input / Output
4	GND	Ground	-
S1	S	Shield	-
S2	S1	Shield	-

Note

For detailed information on the pin assignments of the interfaces, please contact Customer Support (<http://www.siemens.com/automation/service&support>) or the Repair Center.

16.2 Bus board

16.2.1 Layout and principle of operation

The bus board is designed as a link between the motherboard and the expansion modules. It is secured with five screws.

Two models of the bus board are available:

Variante 1 has two PCI slots (1x short, 1x long). It can host expansion modules conforming to PCI specification (Rev. 2.2) for 5 V and 3.3 V modules. All PCI slots are master compatible. The expansion modules are supplied with power via the bus board to motherboard connection.

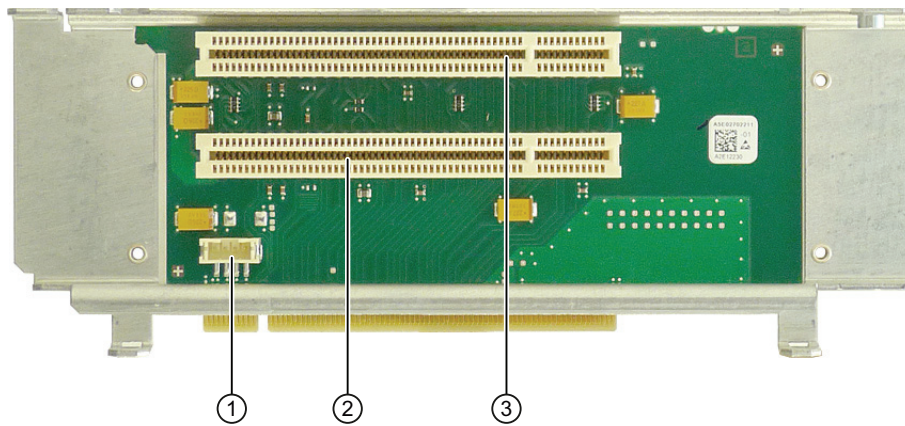

①	12V power supply connection for WinAC module
②	Slot 2
③	Slot 1

Variante 2 has one PCI and one PCI Express slot.

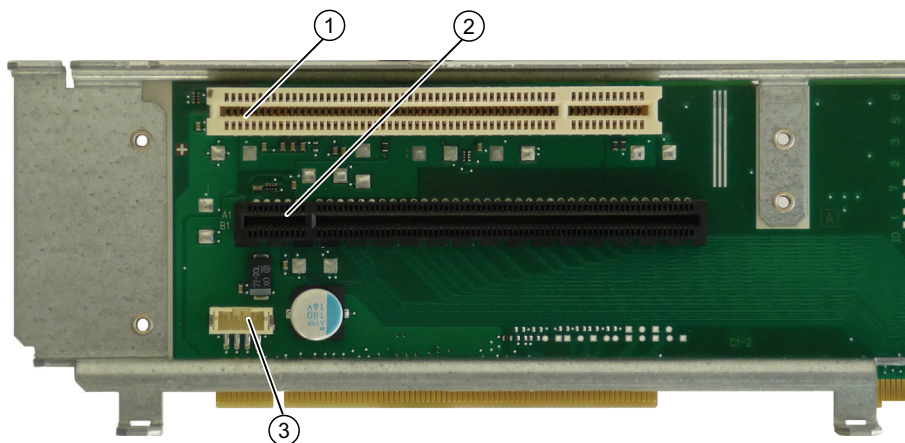

①	Slot 1 PCI
②	Slot 2 PCI Express x16
③	12V power supply connection for WinAC module

16.2.2 PCI slot pin assignment

	5V System Environment	
	Side B	Side A
1	-12V	TRST#
2	TCK	+12V
3	Ground	TMS
4	TDO	TDI
5	+5V	+5V
6	+5V	INTA#
7	INTB#	INTC#
8	INTD#	+5V
9	PRSNT1#	Reserved
10	Reserved	+5 V (I/O)
11	PRSNT2#	Reserved
12	Ground	Ground
13	Ground	Ground
14	Reserved	Reserved
15	Ground	RST#
16	CLK	+5 V (I/O)
17	Ground	GNT#
18	REQ#	Ground
19	+5 V (I/O)	Reserved
20	AD[31]	AD[30]
21	AD[29]	+3.3V
22	Ground	AD[28]
23	AD[27]	AD[26]
24	AD[25]	Ground
25	+3.3V	AD[24]
26	C/BE[3]#	IDSEL
27	AD[23]	+3.3V
28	Ground	AD[22]
29	AD[21]	AD[20]
30	AD[19]	Ground
31	+3.3V	AD[18]
32	AD[17]	AD[16]
33	C/BE[2]#	+3.3V
34	Ground	FRAME#
35	IRDY#	Ground
36	+3.3V	TRDY#
37	DEVSEL#	Ground
38	Ground	STOP#
39	LOCK#	+3.3V

	5V System Environment	
	Side B	Side A
40	PERR#	SDONE
41	+3.3V	SBO#
42	SERR#	Ground
43	+3.3V	PAR
44	C/BE[1]#	AD[15]
45	AD[14]	+3.3V
46	Ground	AD[13]
47	AD[12]	AD[11]
48	AD[10]	Ground
49	Ground	AD[09]
50	CONNECTOR KEY	
51	CONNECTOR KEY	
52	AD[08]	C/BE[0]#
53	AD[07]	+3.3V
54	+3.3V	AD[06]
55	AD[05]	AD[04]
56	AD[03]	Ground
57	Ground	AD[02]
58	AD[01]	AD[00]
59	+5 V (I/O)	+5 V (I/O)
60	ACK64#	REQ64#
61	+5V	+5V
62	+5V	+5V

16.2.3 Pin assignment 12 V power supply connection for WinAC module

Pin	Short description	Meaning	Input /Output
1	+12 V ¹	12 V voltage	Output
2	GND	Ground	-
3	GND	Ground	-
4	+5 V ¹	5 V voltage	Output

1) max. permissible current: 1 A; with this power demand the total power demand for the PCI slots are not allowed to be exceeded.

16.2.4 PCI Express slot x16 pin assignment

Signal	Pin no.	Pin no.	Signal
P12V	B1	A1	P12V
P12V	B2	A2	P12V
P12V	B3	A3	P12V
GND	B4	A4	GND
SMB_CLK2	B5	A5	n.c.
SMB_DATA2	B6	A6	n.c.
GND	B7	A7	n.c.
P3V3	B8	A8	n.c.
n.c.	B9	A9	P3V3
AUX_3V	B10	A10	P3V3
WAKE2	B11	A11	PCIE_RESET_L
n.c.	B12	A12	GND
GND	B13	A13	PCIE0_ECLK
PCIEX16_TX_P(15)	B14	A14	PCIE0_ECLK_N
PCIEX16_TX_N(15)	B15	A15	GND
GND	B16	A16	PCIEX16_RX_P(15)
SDVO_CTRLCLK	B17	A17	PCIEX16_RX_N(15)
GND	B18	A18	GND
PCIEX16_TX_P(14)	B19	A19	n.c.
PCIEX16_TX_N(14)	B20	A20	GND
GND	B21	O21	PCIEX16_RX_P(14)
GND	B22	A22	PCIEX16_RX_N(14)
PCIEX16_TX_P(13)	B23	A23	GND
PCIEX16_TX_N(13)	B24	A24	GND
GND	B25	A25	PCIEX16_RX_P(13)
GND	B26	A26	PCIEX16_RX_N(13)
PCIEX16_TX_P(12)	B27	A27	GND
PCIEX16_TX_N(12)	B28	A28	GND
GND	B29	A29	PCIEX16_RX_P(12)
n.c.	B30	A30	PCIEX16_RX_N(12)
SDVO_CTRLDATA	B31	A31	GND
GND	B32	A32	n.c.
PCIEX16_TX_P(11)	B33	A33	n.c.
PCIEX16_TX_N(11)	B34	A34	GND
GND	B35	A35	PCIEX16_RX_P(11)
GND	B36	A36	PCIEX16_RX_N(11)
PCIEX16_TX_P(10)	B37	A37	GND
PCIEX16_TX_N(10)	B38	A38	GND
GND	B39	A39	PCIEX16_RX_P(10)
GND	B40	A40	PCIEX16_RX_N(10)

Signal	Pin no.	Pin no.	Signal
PCIEX16_TX_P(9)	B41	A41	GND
PCIEX16_TX_N(9)	B42	A42	GND
GND	B43	A43	PCIEX16_RX_P(9)
GND	B44	A44	PCIEX16_RX_N(9)
PCIEX16_TX_P(8)	B45	A45	GND
PCIEX16_TX_N(8)	B46	A46	GND
GND	B47	A47	PCIEX16_RX_P(8)
MCH_CFG_20	B48	A48	PCIEX16_RX_N(8)
GND	B49	A49	GND
PCIEX16_TX_P(7)	B50	A50	n.c.
PCIEX16_TX_N(7)	B51	A51	GND
GND	B52	A52	PCIEX16_RX_P(7)
GND	B53	A53	PCIEX16_RX_N(7)
PCIEX16_TX_P(6)	B54	A54	GND
PCIEX16_TX_N(6)	B55	A55	GND
GND	B56	A56	PCIEX16_RX_P(6)
GND	B57	A57	PCIEX16_RX_N(6)
PCIEX16_TX_P(5)	B58	A58	GND
PCIEX16_TX_N(5)	B59	A59	GND
GND	B60	A60	PCIEX16_RX_P(5)
GND	B61	A61	PCIEX16_RX_N(5)
PCIEX16_TX_P(4)	B62	A62	GND
PCIEX16_TX_N(4)	B63	A63	GND
GND	B64	A64	PCIEX16_RX_P(4)
GND	B65	A65	PCIEX16_RX_N(4)
PCIEX16_TX_P(3)	B66	A66	GND
PCIEX16_TX_N(3)	B67	A67	GND
GND	B68	A68	PCIEX16_RX_P(3)
GND	B69	A69	PCIEX16_RX_N(3)
PCIEX16_TX_P(2)	B70	A70	GND
PCIEX16_TX_N(2)	B71	A71	GND
GND	B72	A72	PCIEX16_RX_P(2)
GND	B73	A73	PCIEX16_RX_N(2)
PCIEX16_TX_P(1)	B74	A74	GND
PCIEX16_TX_N(1)	B75	A75	GND
GND	B76	A76	PCIEX16_RX_P(1)
GND	B77	A77	PCIEX16_RX_N(1)
PCIEX16_TX_P(0)	B78	A78	GND
PCIEX16_TX_N(0)	B79	A79	GND
GND	B80	A80	PCIEX16_RX_P(0)
n.c.	B81	A81	PCIEX16_RX_N(0)
n.c.	B82	A82	GND

Note

This slot can also be used for PCIe x6, x4 and x1 modules.

16.3 System resources

16.3.1 Currently allocated system resources

All system resources (hardware addresses, memory configuration, allocation of interrupts, DMA channels) are assigned dynamically by the Windows OS, depending on the hardware configuration, drivers and connected external devices. You can view the current configuration of system resources or possible conflicts with the following operating systems:

Windows XP	Start > Run : In the Open dialog, enter <i>msinfo32</i> and confirm with OK
Windows 7 Ultimate	Start > Enter "cmd" in the search function, then enter "msinfo32" in the input box

16.3.2 System resources used by the BIOS/DOS

The following table describes the system resources for the factory state of the device.

16.3.2.1 I/O address allocation

I/O address (hex)		Size (bytes)	Description of the basic function	Possible alternative function
from	to			
0000	000F	16	DMA controller	
0010	001F	16	Motherboard resources	
0020	0021	2	Programmable interrupt controller	
0022	003F	30	Motherboard resources	
0040	0043	4	System timer	
0044	005F	28	Motherboard resources	
0060	0060	1	Keyboard controller	
0061	0061	1	System loudspeaker	
0062	0063	2	Motherboard resources	
0064	0064	1	Keyboard controller	
0067	006F	9	Motherboard resources	
0070	0075	6	System CMOS/real-time clock	
0076	0080	11	Motherboard resources	
0081	008F	15	DMA controller	
0090	009F	16	Motherboard resources	
00A0	00A1	2	Programmable interrupt controller	
00A2	00BF	30	Motherboard resources	
00C0	00DF	32	DMA controller	
00E0	00EF	16	Motherboard resources	
00F0	00FE	15	Numeric data processor	
0110	016F	96	Not used	
0170	0177	8	Secondary EIDE channel	
0178	01EF	120	Not used	
01F0	01F7	8	Primary EIDE channel	Switchable in Setup, then free
01F8	01FF	8	Not used	
0200	0207	8	Reserved for game port	
0208	02E7	224	Not used	
02E8	02EF	8	Reserved	
02F8	02FF	8	COM2	Switchable in Setup, then free
0300	031F	32	Not used	
0320	032F	16	Not used	
0330	033F	16	Not used	
0340	035F	32	Not used	
0360	0367	8	Not used	
0370	0371	2	SOM	
0372	0375	4	Not used	
0376	0376	1	Secondary EIDE channel	

I/O address (hex)				
0378	037F	8	LPT 1	Switchable in Setup, then free
0380	03AF	48	Not used	
03B0	03BB	12	Graphics	
03BC	03BF	4	Reserved	
03C0	03DF	16	Graphics	
03E0	03E7	8	Not used	
03E8	03EF	6	Reserved	
03F0	03F5	6	Standard floppy disk controller	
03F6	03F6	1	Primary EIDE channel	
03F7	03F7	1	Standard floppy disk controller	
03F8	03FF	8	COM1	Switchable in Setup, then free
Dynamic range; resources are managed by means of Plug and Play functionality				
0400	0777	888	Not used	
0778	077F	8	ECP LPT 1	
0780	07FF	128	Not used	
0800	080F	16	ACPI communications range	Fixed
0810	0CFB	1260	PCI configuration index	Fixed
0CFC	0CFF	4	PCI configuration data	Fixed
0D00	0EFF	512	Not used	
0F00	0F4F	80	Super IO	
0F50	0FFF	176	Not used	
1000	10FF	256	Used internally	
1180	11FF	128	Used internally	
1800	187F	128	Used internally	
8800	8BFF	1023	SATA RAID Controller	
8C00	FEFF	29288	Not used for SATA RAID	
8870	8897	39	PATA RAID Controller	
8898	FEFF	30311	Not used for PATA RAID	
1880	886F	28655	Not used	
FF00	FF0F	16	EIDE bus master register	

16.3.2.2 Interrupt Assignments

The functions are assigned different interrupts, depending on the operating system. A distinction is made between the PIC and APIC modes.

Function	IRQ Number																							Comment	
	0	1	2	3	4	5	6	7	8	9	10	11	12	13	14	15	16	17	18	19	20	21	22		23
IRQ (APIC Mode)	0	1	2	3	4	5	6	7	8	9	10	11	12	13	14	15	16	17	18	19	20	21	22	23	
IRQ (PIC Mode)	0	1	2	3	4	5	6	7	8	9	10	11	12	13	14	15	16	17	18	19	20	21	22	23	
Host PCI IRQ Line																	A	B	C	D	E	F	G	H	1)
Function																	(1)	(2)	(3)	(4)	(5)	(6)	(7)	(8)	
System Timer / HPET	X	-	-	-	-	-	-	-	-	-	-	-	-	-	-	-	-	-	-	-	-	-	-	-	ISA exclusive
PS/2-Keyboard-Controller-Emulation	-	X	-	-	-	-	-	-	-	-	-	-	-	-	-	-	-	-	-	-	-	-	-	-	ISA exclusive
Cascaded Interrupt-Controller 2	-	-	X	-	-	-	-	-	-	-	-	-	-	-	-	-	-	-	-	-	-	-	-	-	ISA exclusive
Com Port 2 (COM2)	-	-	-	X	-	-	-	-	-	-	-	-	-	-	-	-	-	-	-	-	-	-	-	-	can also be used for COM 1
Com Port 1 (COM1)	-	-	-	-	X	-	-	-	-	-	-	-	-	-	-	-	-	-	-	-	-	-	-	-	can also be used for COM 2
FD-Controller	-	-	-	-	-	-	X	-	-	-	-	-	-	-	-	-	-	-	-	-	-	-	-	-	only free in ACPI-PIC mode
Paralle port 1	-	-	-	-	-	-	-	-	-	-	-	-	-	-	-	-	-	-	-	-	-	-	-	-	Free
Real time clock (RTC)	-	-	-	-	-	-	-	X	-	-	-	-	-	-	-	-	-	-	-	-	-	-	-	-	Fixed
PS/2-Maus-Controller-Emulation	-	-	-	-	-	-	-	-	-	-	X	-	-	-	-	-	-	-	-	-	-	-	-	-	ISA exclusive
Numeric processor	-	-	-	-	-	-	-	-	-	-	-	X	-	-	-	-	-	-	-	-	-	-	-	-	Fixed
HD-Controller 1 (primary)	-	-	-	-	-	-	-	-	-	-	-	-	X	-	-	-	-	-	-	-	-	-	-	-	can be switched off, fixed in Enhanced Mode
HD-Controller 2 (secondary)	-	-	-	-	-	-	-	-	-	-	-	-	-	X	-	-	-	-	-	-	-	-	-	-	can be switched off, fixed in Enhanced Mode
SATA	-	-	-	-	-	-	-	-	Z	-	-	-	-	-	-	-	-	-	-	-	-	-	-	Y	Can be switched off
USB port 0/1	-	-	-	-	-	-	-	-	Z	-	-	-	-	-	-	-	-	-	-	-	-	-	-	Y	Cannot be disabled
USB port 2/3	-	-	-	-	-	-	-	-	Z	-	-	-	-	-	-	-	-	-	-	-	-	-	-	Y	Cannot be disabled
USB port 4/5	-	-	-	-	-	-	-	-	-	Z	-	-	-	-	-	-	-	-	-	-	-	-	Y	-	Cannot be disabled
USB 2.0 Controller	-	-	-	-	-	-	-	-	-	Z	-	-	-	-	-	-	-	-	-	-	-	-	Y	-	Cannot be disabled
Ethernet 1	-	-	-	Z	-	-	-	-	-	-	-	-	-	-	-	-	Y	-	-	-	-	-	-	-	Can be switched off
Ethernet 2	-	-	-	-	-	-	-	-	-	Z	-	-	-	-	-	-	Y	-	-	-	-	-	-	-	Can be switched off
VGA	-	-	-	-	-	-	-	-	-	Z	-	-	-	-	-	-	Y	-	-	-	-	-	-	-	Can be switched off
PROFIBUS oder PROFINET	-	-	-	-	-	Z	-	-	-	-	-	-	-	-	-	-	-	-	-	-	Y	-	-	-	Can be switched off, exclusive

1) Host PCI-IRQ A to H will be assigned IRQ 16 to 23 permanently in ACPI mode. Host PCI-IRQ A to H will be automatically assigned IRQ 0 to 15 in PIC mode. A specific assignment can not be enforced.

- X Interrupt in PIC and APIC mode
- Y Interrupt in APIC mode
- Z BIOS Default Interrupt in PIC mode (e.g. DOS)

Figure 16-3 Interrupt assignment in PIC mode

Exclusive interrupt in PIC mode

The interrupts are automatically assigned to the slots at system startup due to the default settings in system BIOS.

Several slots may share the same interrupt, depending on the system configuration. This functionality is known as interrupt sharing. Exclusive interrupts are not available in PIC mode. Disable specific system resources in order to obtain exclusive interrupts. BIOS assigns the PIC interrupts at random during restart of the system.

16.3.2.4 Memory address assignments

PCI VGA modules can be operated with expansion ROM up to 48K.

Address		Size	Description of the basic function	Possible alternative function
from	to			
0000 0000	0007 FFFF	512K	Conventional system memory	
0008 0000	0009 F7FF	127K	Conventional system memory extended	
0009 F800	0009 FFFF	2K	XBDA, extended Bios Data Area	
000A 0000	000A FFFF	64K	VGA graphics refresh memory	Shared SMM for power management
000B 0000	000B 7FFF	32K	Software graphics / text refresh memory	Not used
000B 8000	000B FFFF	32K	VGA graphics/text refresh memory	
000C 0000	000C BFFF	48K	VGA BIOS expansion	
000C 0000	000C FFFF	64K	VGA BIOS	Always occupied or reserved
000E 0000	000FFFFF	2 x 64K	DMI data, System BIOS, Options ROMs: PXE, RAID	
0010 0000	CFFF FFFF	3.2GB	System memory 4 GB memory configuration	Depends on memory configuration
D460 0000	D460 0FFF	4K	Motherboard resources	
F000 0000	F3FF FFFF	64M	Motherboard resources	
FED0 0000	FED0 03FF	1K	High Precision Event Timer	
FED1 0000	FED1 3FFF	16K	Motherboard resources	
FED1 8000	FED1 8FFF	4K	Motherboard resources	
FED1 9000	FED1 9FFF	4K	Motherboard resources	
FED1 C000	FED1 FFFF	16K	Motherboard resources	
FED2 0000	FED3 FFFF	128K	Motherboard resources	
FED9 0000	FED9 3FFF	16K	Motherboard resources	
FEE0 0000	FEEF FFFF	1M	Motherboard resources	
FF00 0000	FFFF FFFF	16M	Motherboard resources	

16.3.2.5 Addresses used by SRAM

The battery-buffered SRAM uses a 2 MB memory address area that can be read via the PCI register.

The address area is dynamic and is set by the BIOS during the enumeration. The base address of the SRAM can be obtained either using the resource information of the Device Manager (device name: Standard RAM Controller) or in the PCI configuration address area from the device with device ID "110Ah, VendorID 4040h" and Offset "10h"

16.3.2.6 Accessing addresses of LEDs, watchdog and battery status

These addresses cannot be accessed directly.

SIMATIC PC DiagBase software provides the DMAPi programming interface for this purpose. It can be found:

- On the "Documentation & Drivers" DVD in the folder "Drivers\DiagBase\program files\Siemens\DiagnosticManagement"
- In the installation directory under "%ProgramFiles%\Siemens\DiagnosticManagement\DMAPI"

16.4 BIOS-Setup

16.4.1 Overview

BIOS Setup program

BIOS SETUP allows you to set the hardware configuration, and system properties. SETUP is also used to set the time and date of the realtime clock.

Changing the device configuration

Your device configuration is preset for operating with the included software. You should only change the default values if you have modified the technical configuration your device, or if a fault occurs when the unit is powered up.

16.4.2 Starting BIOS Setup

Starting BIOS Setup

Start the setup program as follows:

1. Reset the device (warm or cold restart).

In the figures shown, the default settings differ based on the device versions. With the default setting of the Box PC, the display shown below appears following power-on, for example:

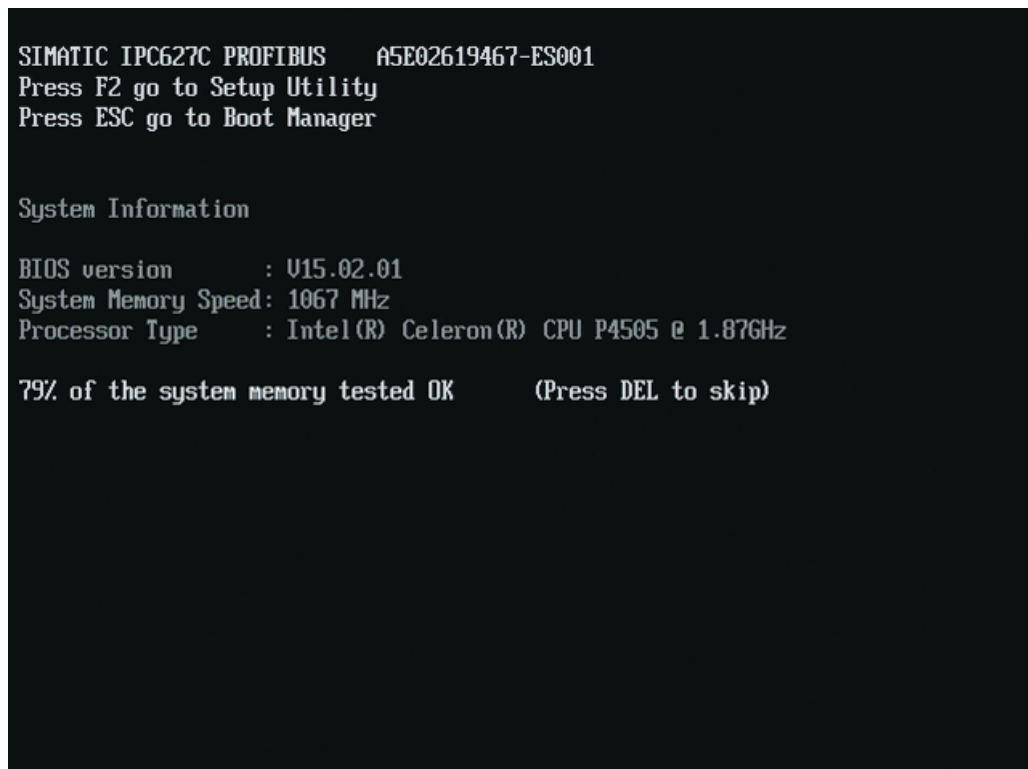

```
SIMATIC IPC627C PROFIBUS   A5E02619467-ES001
Press F2 go to Setup Utility
Press ESC go to Boot Manager

System Information

BIOS version       : U15.02.01
System Memory Speed: 1067 MHz
Processor Type     : Intel(R) Celeron(R) CPU P4505 @ 1.87GHz

79% of the system memory tested OK      (Press DEL to skip)
```

On completion of the POST, the BIOS gives you the opportunity of starting the SETUP program. The following message appears on the screen:

- Press F2 go to Setup Utility
- Press F12 go to Boot Manager

2. Press the F2 key while the BIOS prompt appears on the screen.

16.4.3 BIOS Setup menus

The various menus and submenus are listed on the next pages. You can obtain information on the selected SETUP item from the "item-specific help" part of the respective menu.

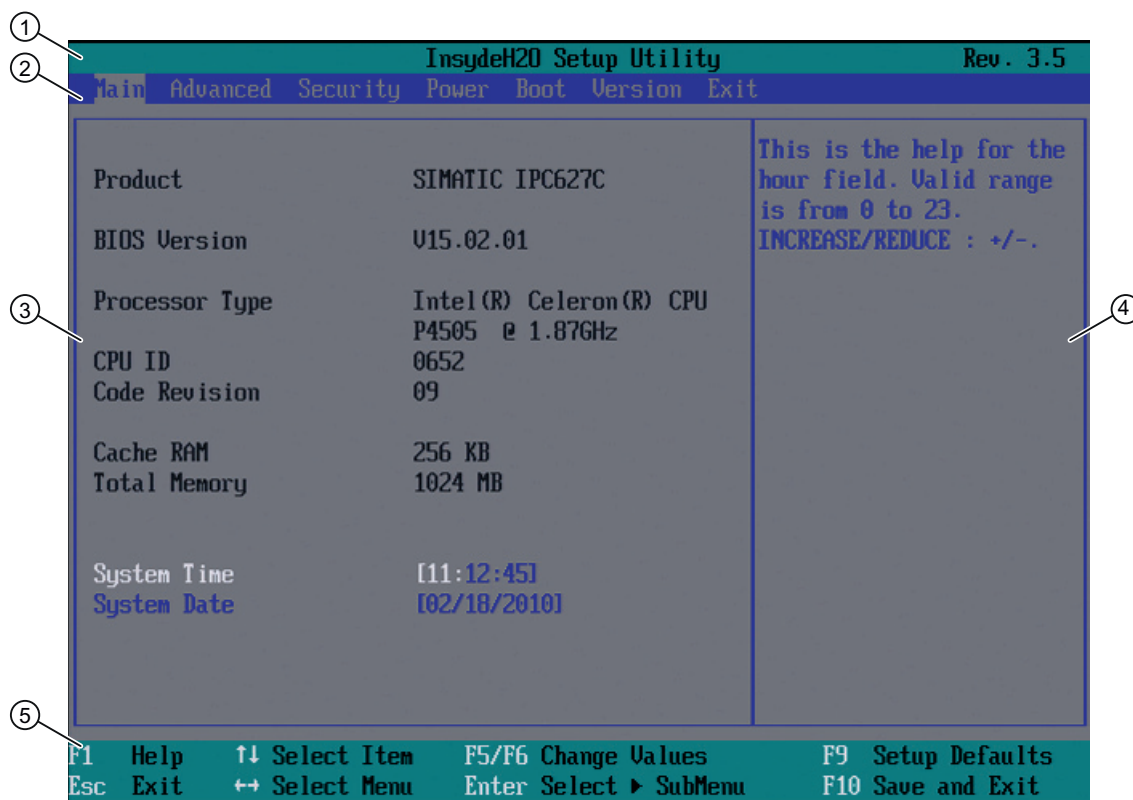

Figure 16-5 SETUP Main menu (example)

① Header	④ Help window
② Menu bar	⑤ Command line
③ System information	

Menu layout

The screen is divided into four sections. In the top section ②, you can select the submenus [Main], [Advanced], [Security], [Power], [Boot], [Version], [Exit]. You can select various settings or submenus in the left middle section ③. Short help texts are displayed on the right ④ for currently selected menu entries; the bottom section contains information for operator input.

The following figures represent examples of specific device configurations. The screen content may deviate slightly depending on the equipment actually supplied.

You can move between the menu forms using the cursor keys [←] left and [→] right.

Menu	Meaning
Main	System functions are set here
Advanced	An extended system configuration can be set here
Security	This is where setting security functions such as the password are set.
Power	The behavior of the device after a power failure and after wake events is specified here.
Boot	This is where the boot priority is specified.
Version	This shows device-specific information (such as the release version).
Exit	Used for terminating and saving.

16.4.4 Main menu

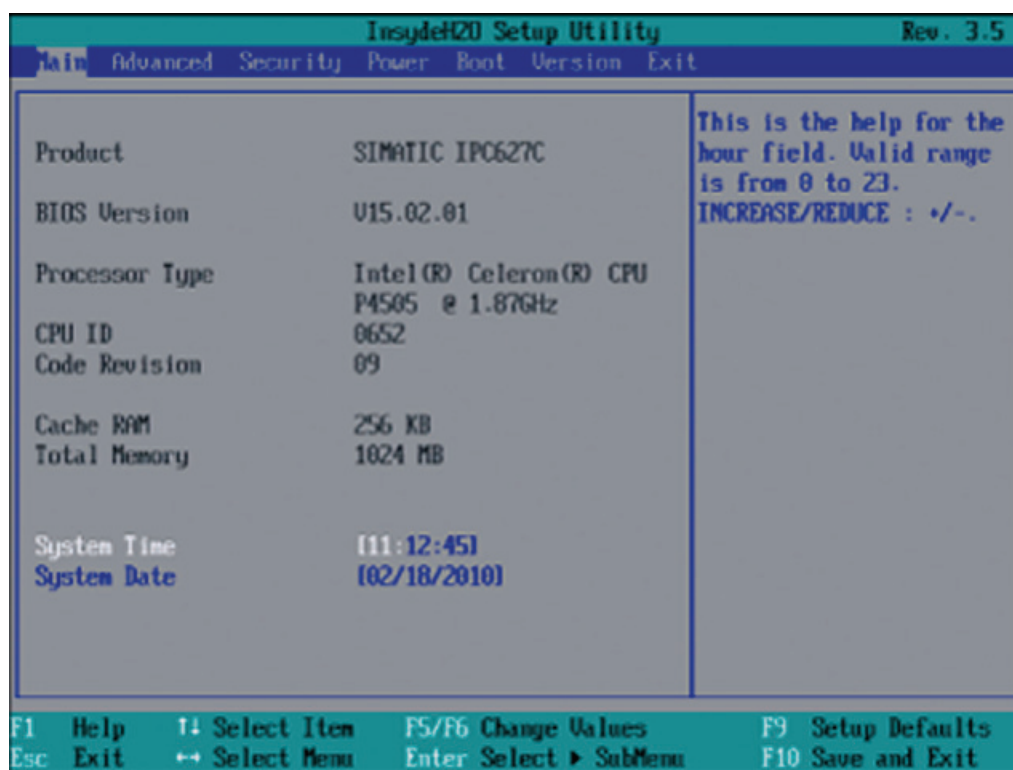

Figure 16-6 Main menu (example)

Settings in the main menu

In the main menu, you can move up and down to select the following system configuration boxes by means of the [↑] up and [↓] down cursor keys:

Field	Meaning
System Time	For viewing and setting the current time
System Date	For viewing and setting the current date

System time and date

System Time and System Date indicate the current values. Once you have selected the appropriate option, you can use the [+] and [-] keys to modify the time setting

Hour: Minute: Second

and for the date.

Month/Day/Year

You can navigate between the entries in the date and time fields (for example, from hour to minute) using the ENTER key.

16.4.5 Advanced menu

Menu layout

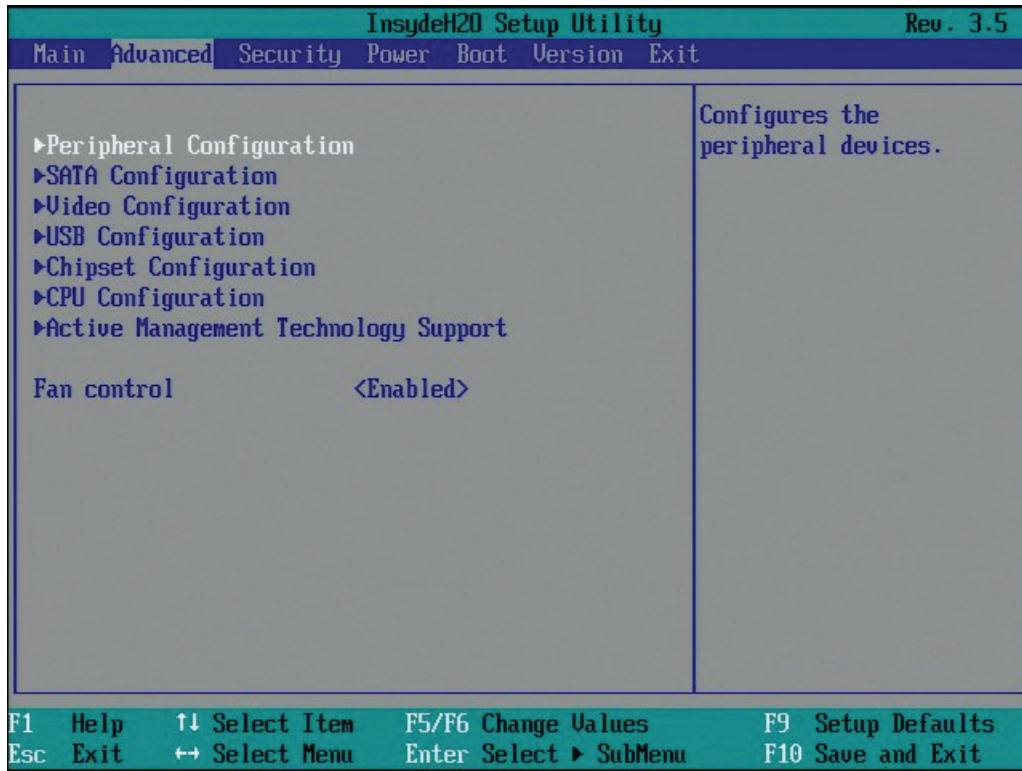

Settings in the Advanced Menu

Entry	Meaning
Peripheral Configuration	Configuration of components on the motherboard.
SATA Configuration	Configuration of the SATA interface.
Video Configuration	Configuration of the graphics interface
USB Configuration	Configuration of the USB ports
Chipset Configuration	Extended chipset configuration.
CPU Configuration	Configuration of CPU parameters
Active Management Technology Support	Configuration of the AMT functionality
Fan control	Activate/deactivate fan control. If deactivated, the fans always run at full speed.

Advanced menu > "Peripheral Configuration"

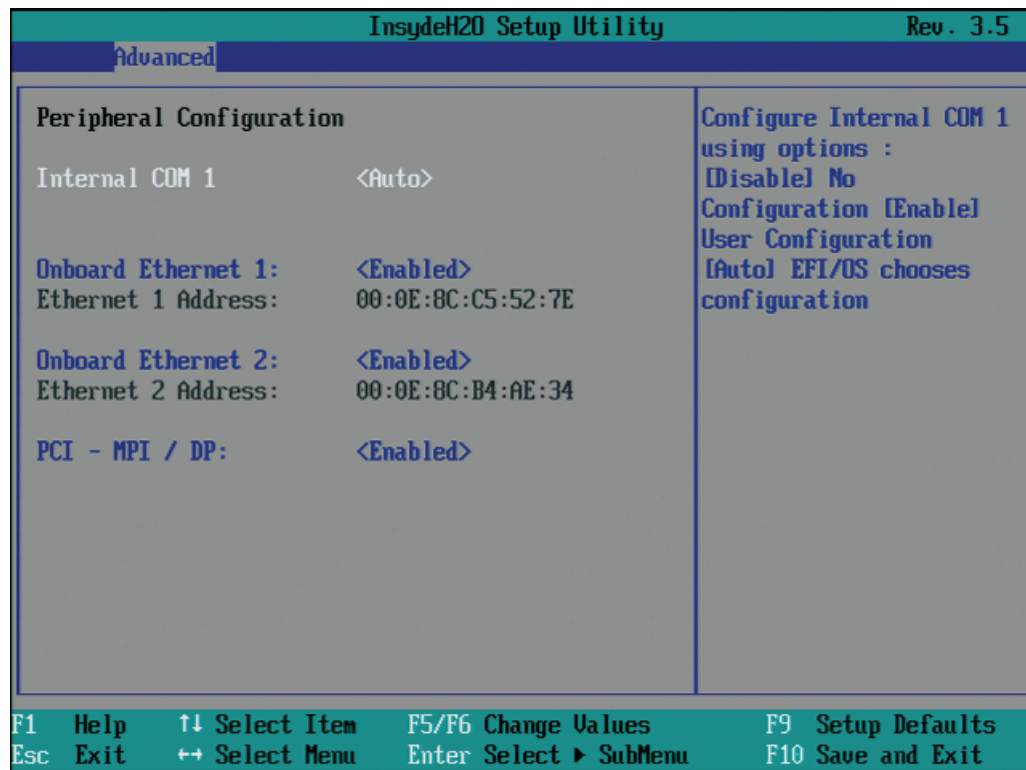

Figure 16-7 "Peripheral Configuration" submenu

Entry	Meaning
Internal COM 1	Enable (Enabled) or disable (Disabled) the serial port or configure it automatically (Auto) With Enabled, it is possible to specify the I/O base address and the interrupt. AUTO: BIOS switches on the COM. Resources are assigned in the OS per reconfiguration.
Onboard Ethernet 1:	Enable or disable the onboard Ethernet 1 interface.
Ethernet 1 Address:	Display the MAC address of Ethernet 1
Onboard Ethernet 2:	Enable or disable the onboard Ethernet 2 interface.
Ethernet 2 Address:	Display the MAC address of Ethernet 2
PCI - MPI / DP / PROFINET:	Enable or disable the onboard MPI/DP or PROFINET interface.

Advanced menu > SATA/PATA Configuration

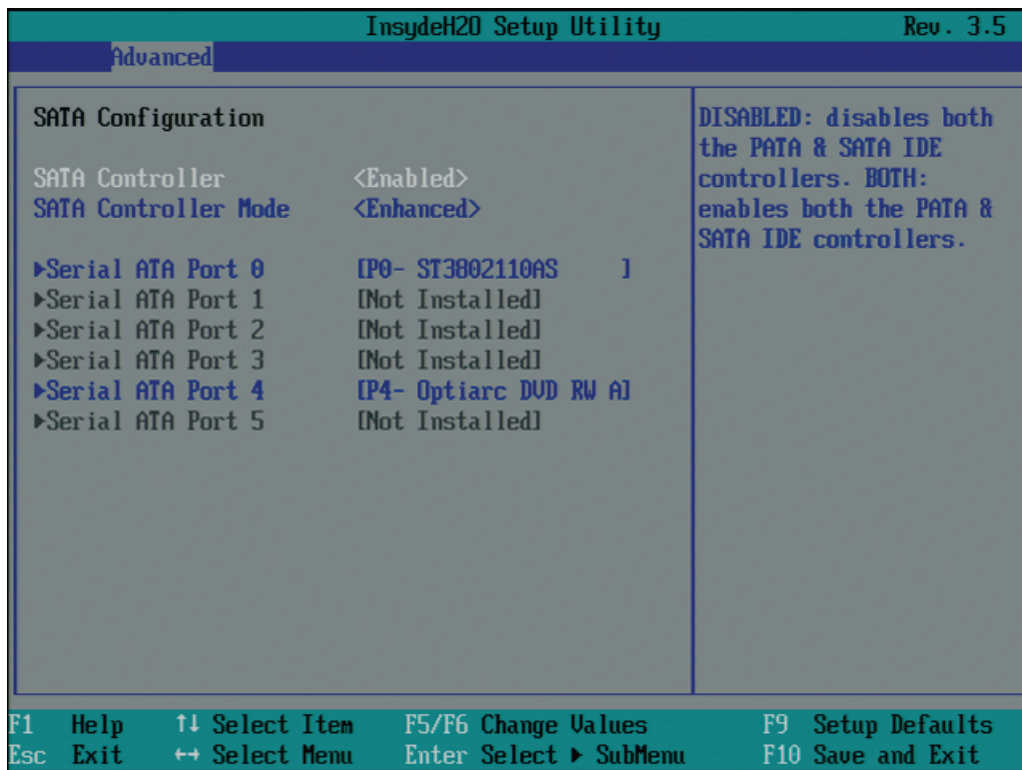

Figure 16-8 "SATA/PATA Configuration" submenu

Entry	Meaning
SATA Controller	Enable or disable the SATA and PATA controllers.
SATA Controller mode	Set operating mode of the SATA controller: <ul style="list-style-type: none"> Enhanced: SATA Ports 0-3 operate in Legacy mode, SATA Ports 4-5 in native IDE mode AHCI : Disable or enable the AHCI support RAID: Disables or enables RAID support
Serial ATA Port 0	Submenu for SATA Port 0 configuration
Serial ATA Port 1	Submenu for SATA Port 1 configuration
Serial ATA Port 2	Submenu for SATA Port 2 configuration
Serial ATA Port 3	Submenu for SATA Port 3 configuration
Serial ATA Port 4	Submenu for SATA Port 4 configuration
Serial ATA Port 5	Submenu for SATA Port 5 configuration

Advanced menu > Video Configuration

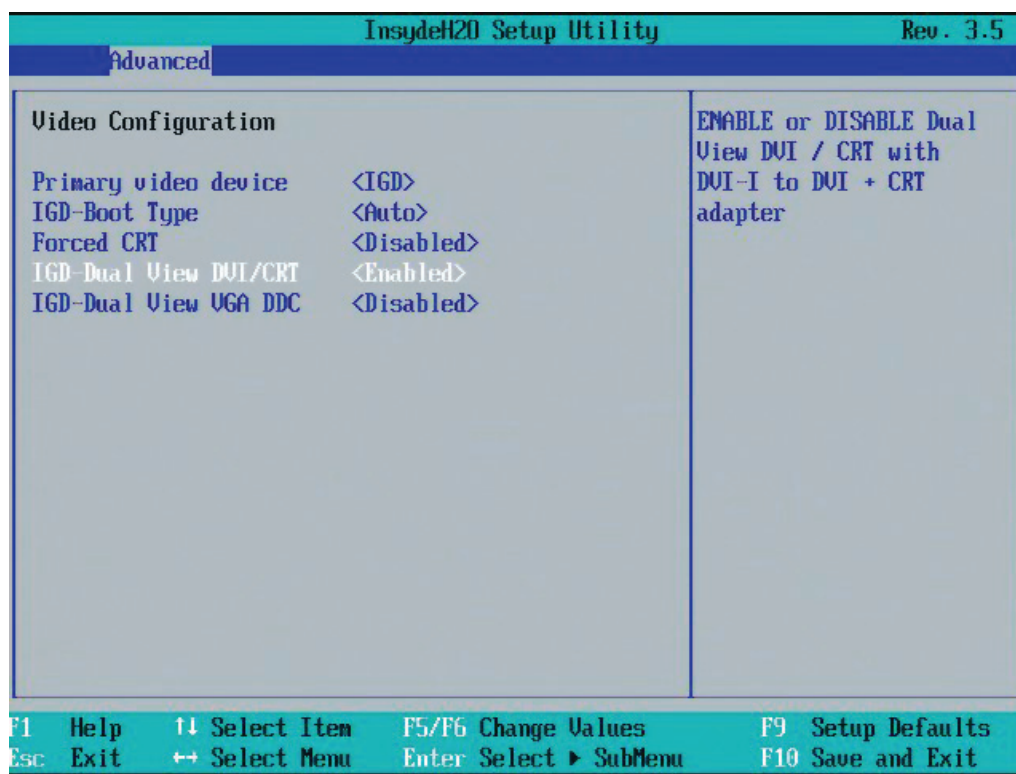

Figure 16-9 Submenu Advanced menu > Video Configuration

Entry	Meaning
Primary video device	Selection of the primary video interface to which the boot messages are to be output: <ul style="list-style-type: none"> • IGD: Internal onboard graphics • PEG: PCIExpress graphics (internal graphics is deactivated) • PCI: PCI graphics (internal graphics is deactivated)
IGD boot type	Selection of the video device that is used during booting. <ul style="list-style-type: none"> • Auto: The graphics specified by the VIDEO BIOS is used. • CRT: VGA screen • LFP: Local Flat Panel • CRT+LFP: VGA screen and local display
Forced CRT	Enabled: The CRT/VGA interface is active even when no monitor is connected, e.g. for AMT headless mode. Disabled: The CRT/VGA interface is only active when a monitor is connected.

Entry	Meaning
IGD Dual View DVI/CRT	Activate/deactivate the dual view mode: Simultaneous operation of 2 monitors (CRT and DVI) by means of adapter (splitter) at the DVI output of the device.
IGD Dual View VGA DDC	Enabled: When a DVI monitor and a CRT monitor are operated via a Y cable, the DDC signal of the DVI monitor is also used for the CRT monitor. This prevents the CRT monitor screen briefly going black when you right-click. The CRT monitor resolution should be the same or higher than that of the DVI monitor.

Advanced menu > USB Configuration

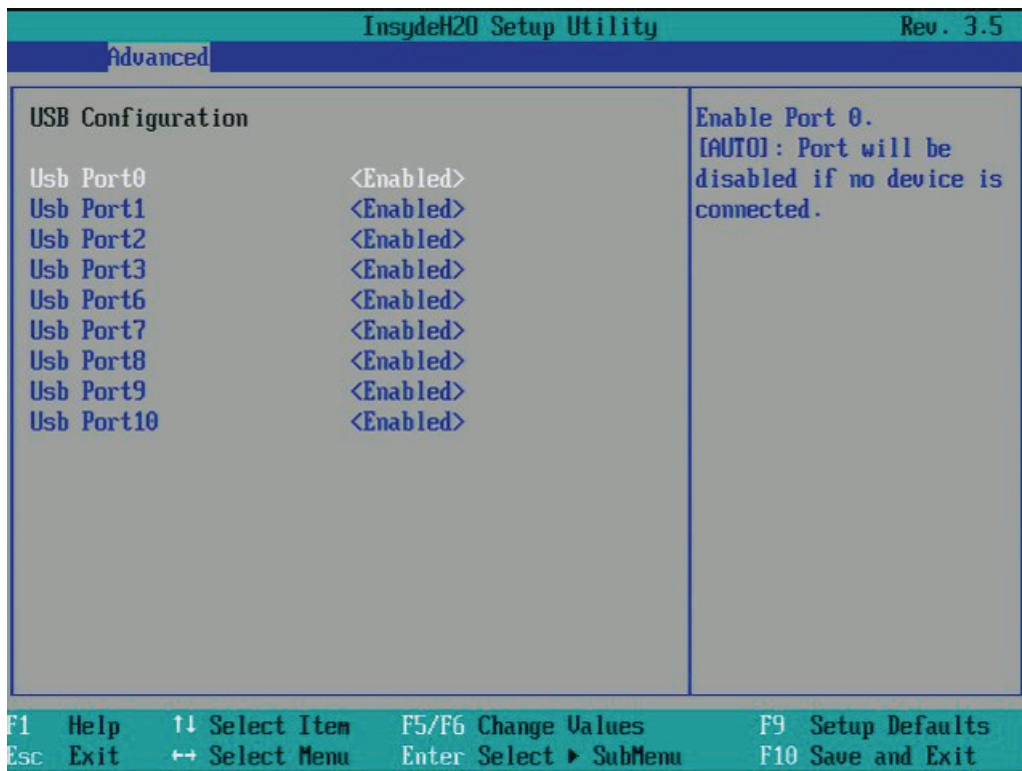

Figure 16-10 Submenu Advanced menu > USB Configuration

Entry	Meaning
USB Port0 -10	<ul style="list-style-type: none"> • Enable: USB port is activated. • Auto: USB port is deactivated when no device is plugged. • Disable: USB port is deactivated.

The following table lists the assignment of the USB ports to the USB interfaces:

USB port	USB interface
0	Ext. interface X60 P1
1	Ext. interface X60 P2
2	Ext. interface X60 P3
3	Ext. interface X60 P4
6	Int. interface X43 Pin 1 - 5
7	Int. interface X43 Pin 6 - 10
8	Front-end interface of the panel fronts X42
9	Int. interface X48
10	Keyboard / Touch controller interface of the panel fronts X44

Advanced menu > Chipset Configuration

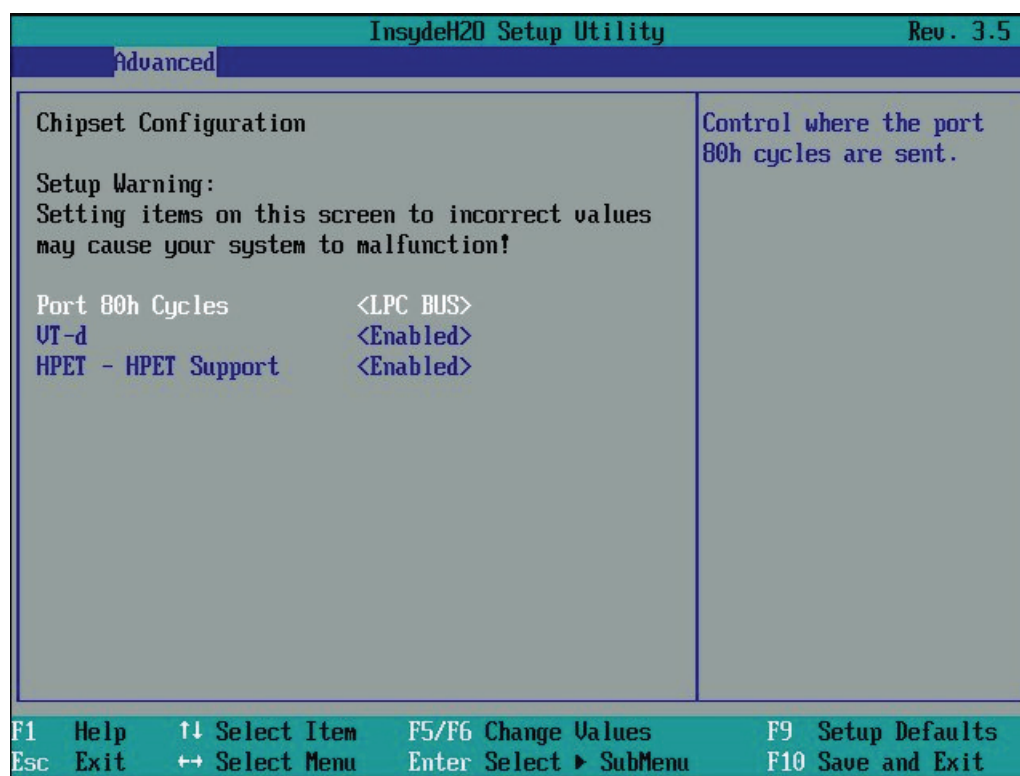

Figure 16-11 Submenu Advanced menu > Chipset Configuration

Entry	Meaning
Port 80h Cycles	Output Port 80 status display to PCI bus or LPC BUS (status display at the device).
VT-d	Enable or disable advanced support for virtualization technology "DIRECT I/O"
HPET	Enable High Precision Event Timer

Advanced menu > CPU Configuration

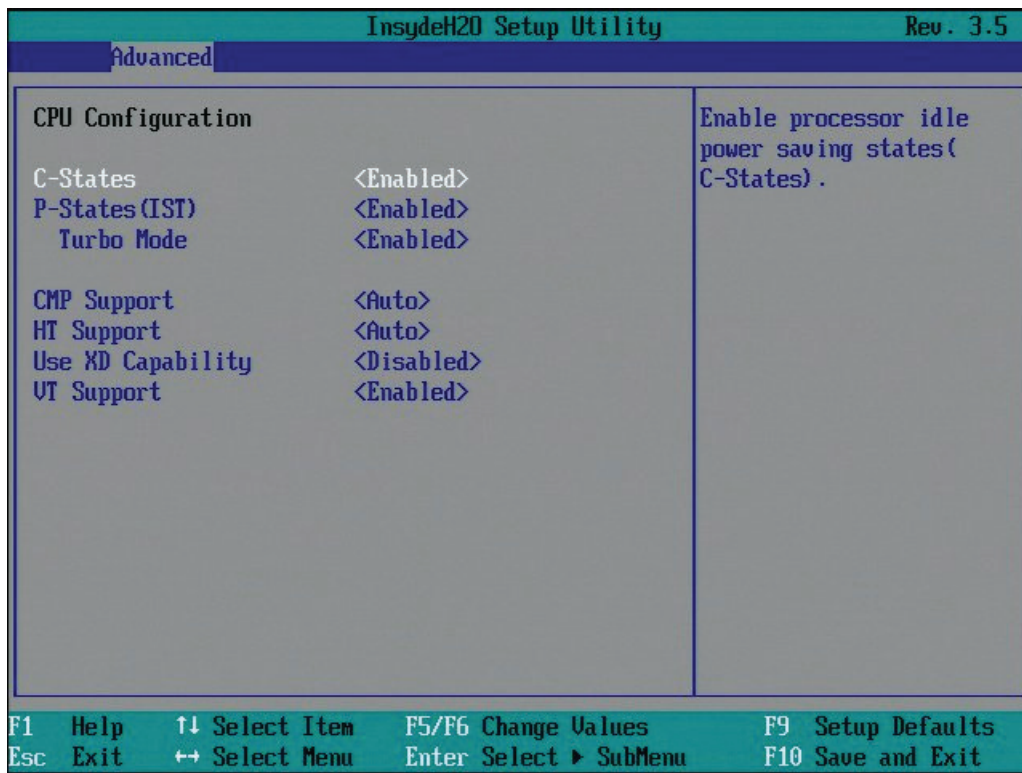

Figure 16-12 Submenu Advanced menu > CPU Configuration

Entry	Meaning
C-States	Enable the power saving modes of the processor.
P-States (IST)	Enable the performance modes of the processor.
Turbo Mode	Enable or disable Turbo Modes.
CMP support	<ul style="list-style-type: none"> • Auto: Multi Core operation, if available • Disabled: Single Core operation
HT Support	<ul style="list-style-type: none"> • Auto: Use hyperthreading, if available. • Disabled: Hyperthreading disabled.
Use XD Capability	Enable or disable XD (Execute Disable) Capability.
VT Support	Enable or disable virtualization functionality "Vanderpool Technology".

16.4.6 "Advanced, Active Management Technology Support" menu

Settings in the BIOS

The following figure shows the BIOS submenu "Advanced Menu > Active Management Technology Support", in which you configure part of AMT in the BIOS. You will find further configuration options for AMT in the MEBx (see "Settings in the MEBx").

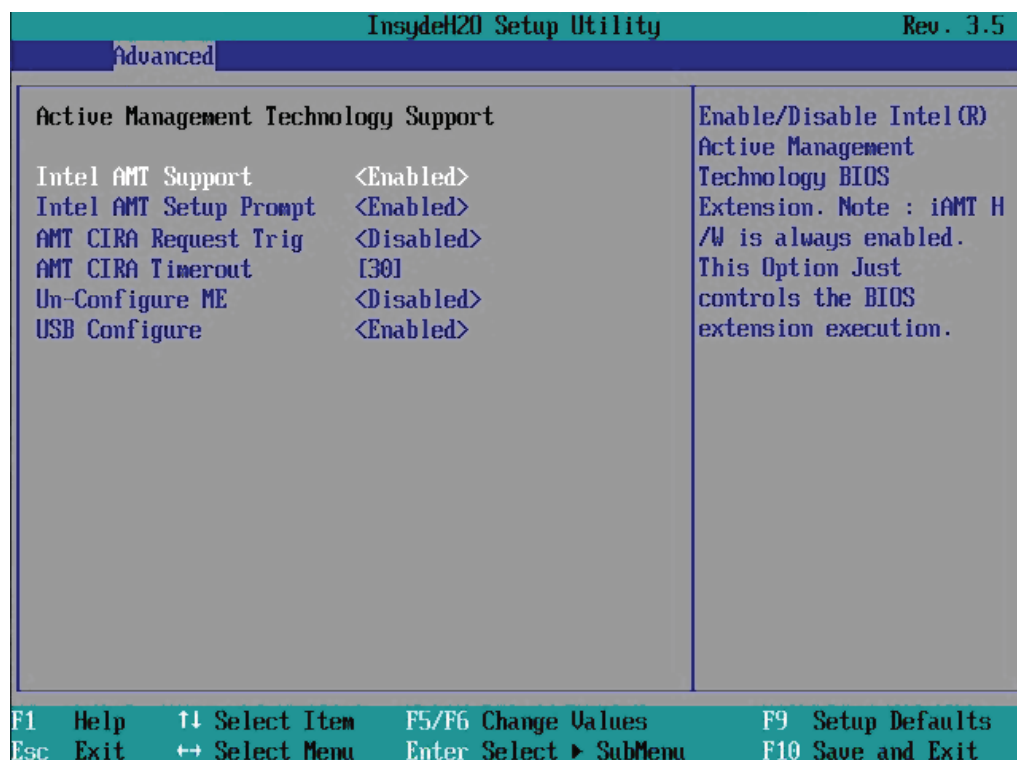

Entry	Meaning
Intel AMT Support	Enable and disable BIOS support for Intel Active Management Technology (AMT)
Intel AMT Setup Prompt	Enable and disable the boot interruption <Ctrl+P> to call up the MEBx configuration page.
AMT CIRA Request Trig	Enable CIRA (Client Initiated Remote Access, "Fast Call For Help"). CIRA allows AMT maintenance event if the AMT PC is not in the intranet.
AMT CIRA Timeout	CIRA timeout for connection establishment with MPS (Manageability Presence Server / "vPro Enabled Gateway").
Un-Configure ME	Resets all the values of the MEBx to their defaults (see section "Reset with Un-Configure").
USB Configure	Enable and disable the USB configuration (provisioning).

Settings in the MEBx

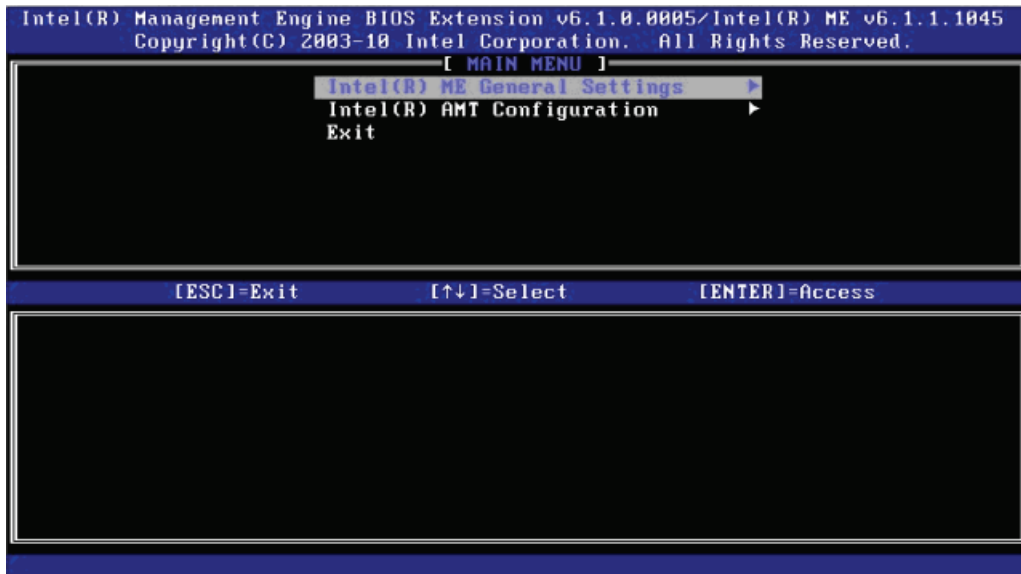

Entry	Meaning
Intel(R) ME General Settings	Opens the submenu with the general ME settings (see "ME General Settings").
Intel(R) AMT Configuration	Opens the submenu for the AMT settings (see "ME General Settings").
Exit	Exits the MEBx.

ME general settings

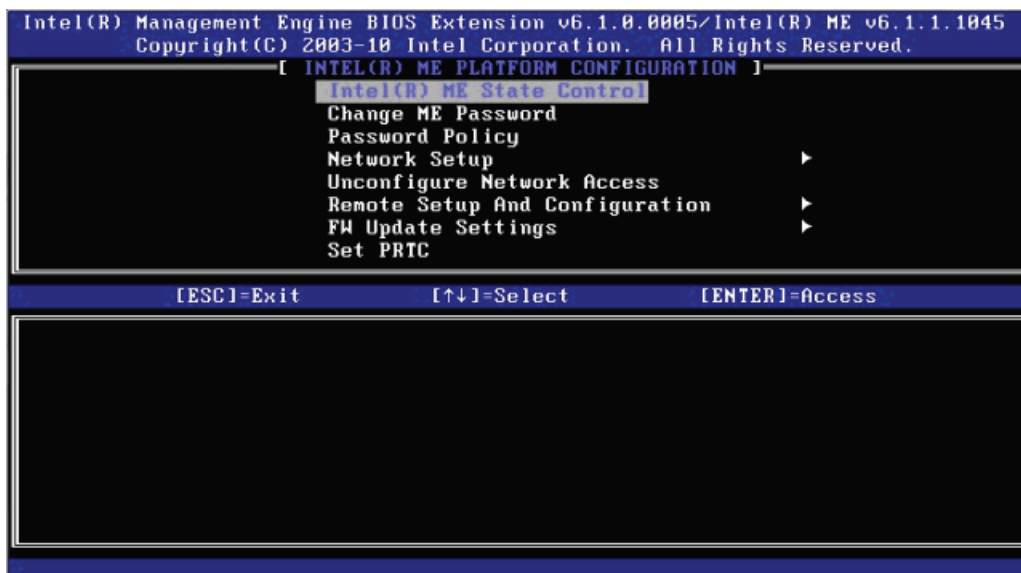

You cannot see all the switches in the menu at the same time. Use the arrow buttons to display the hidden switches.

Entry	Meaning
Intel(R) ME State Control	Enable ME: Normal operation Disable ME: Stops ME at a very early boot stage to search for errors. <ul style="list-style-type: none"> • When searching for errors, ME can then be excluded as a possible source of error. • No ME activities on a BUS.
Change ME Password	Used to change the password
Password Policy	Password policy that specifies the conditions under which the password can be modified remotely.
Network Setup	Network settings, for example DHCP, IP address, host name, domain name.
Activate Network Access	Activates the network interface. This menu entry only exists if the network is not activated.
Unconfigure Network Access	Deactivates the network interface and resets the network settings to their default values.
Remote Setup And Configuration	Displays the current provisioning settings.
FW Update Settings	Sets the user rights and the conditions under which ME firmware updates can be transferred.
Set PRTC	PRTC (protected real time clock) is an internal ME clock, that is required in the ME, for example for comparing times with TLS & Kerberos, time stamps of events. Period of validity: 1.1.2004 – 4.1.2021.
Power Control	Specifies the power states S0, S3, S4 of the computer in which the ME is activated.
Previous Menu	Return to the main menu.

AMT configuration

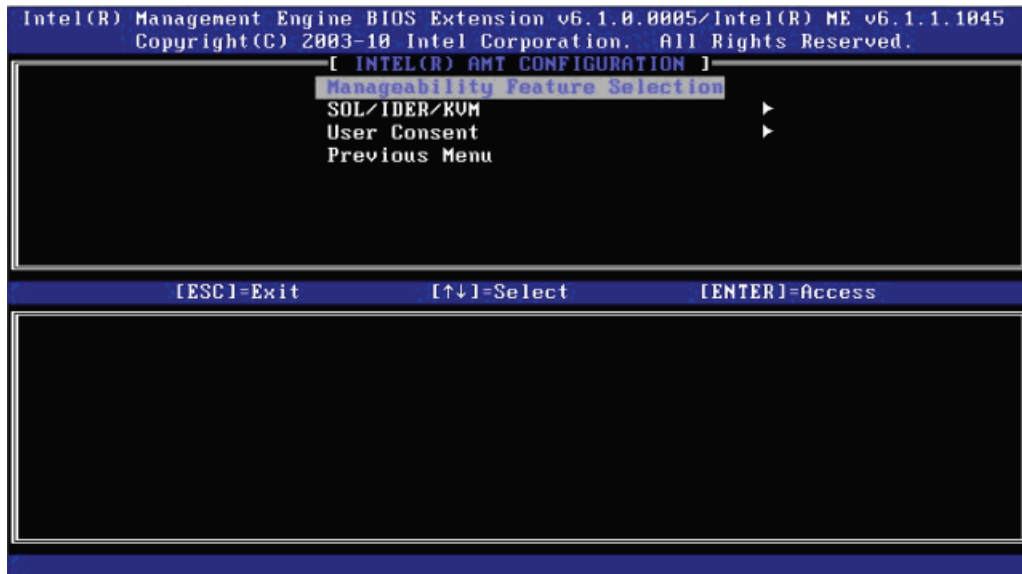

Entry	Meaning
Manageability Feature Selection	Enable and disable all AMT features.
SOL/IDER/KVM	Enable and disable the features SOL, IDE redirection, KVM.
User Consent	User consent settings. Forces the following additional security behavior: When a user attempts to establish a KVM connection remotely, a six-figure number is displayed on the AMT PC. The remote user must enter this number on the help desk PC before the KVM connection can be opened.
Previous Menu	Return to the main menu.

See also

Resetting with Un-configure (Page 250)

16.4.7 Security menu

In this menu access to the IPC can be limited or prevented by assigning passwords (Supervisor / User password).

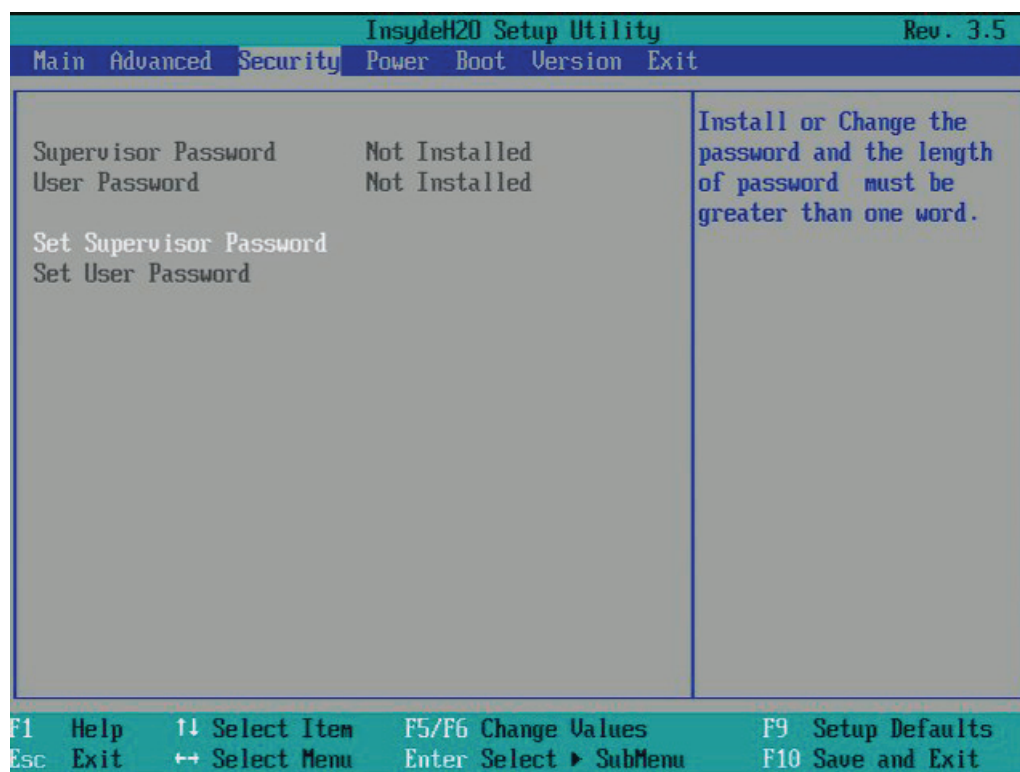

Figure 16-13 Security menu

Entry	Meaning
Supervisor Password	<ul style="list-style-type: none"> Installed: A Supervisor password is set up Not installed: No Supervisor password is set up
User password	<ul style="list-style-type: none"> Installed: A User password is set up Not installed: No User password is set up
Set Supervisor Password	Set a Supervisor password for full access to the SETUP. This field opens the password input dialog. After entering the Supervisor password correctly, the user can change the password, or clear and thus deactivate it by pressing "ENTER".
Set User Password	Set a User password for limited access to the SETUP. This field opens the password input dialog. Logged on users can change the password, or clear and thus deactivate it by pressing "RETURN".

16.4.8 Power menu

The behavior of the device after a power failure and after wake events is specified in this menu.

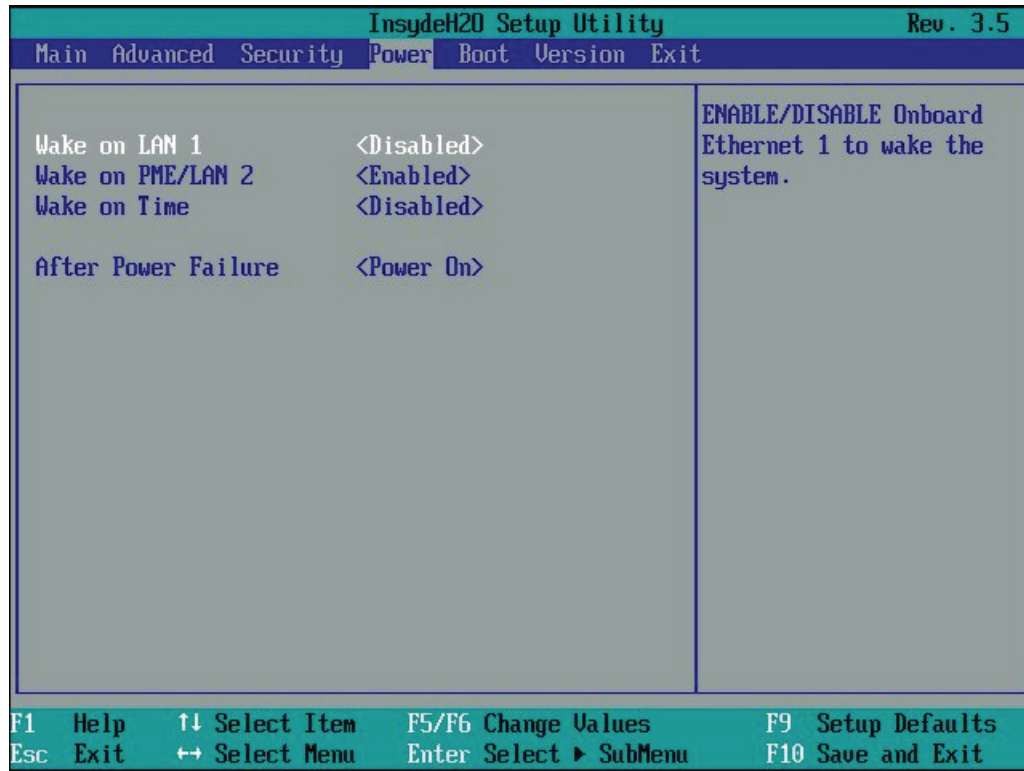

Figure 16-14 Power menu

Entry	Meaning
Wake on LAN 1	Device can be activated by an event via LAN.
Wake on PME/LAN 2	The device switches on when a Power Management Event occurs.
Wake on Time	The device switches on at a moment to be specified when it is in the operating state S5.
After Power Failure	Specification of the device behavior after a voltage failure and voltage recovery. <ul style="list-style-type: none"> • [Power On]: After voltage failure and subsequent voltage restoration, the device switches on automatically. • [Stay Off]: After voltage failure and subsequent voltage restoration, the device remains switched off. • [Last State]: If the device was switched on when the power failure occurred, the device switches on when the voltage is restored. Otherwise, the device remains switched off when the voltage is restored.

16.4.9 Boot Menu

In this menu this booting behavior of the device is specified and the boot medium or sequence of the boot media is determined.

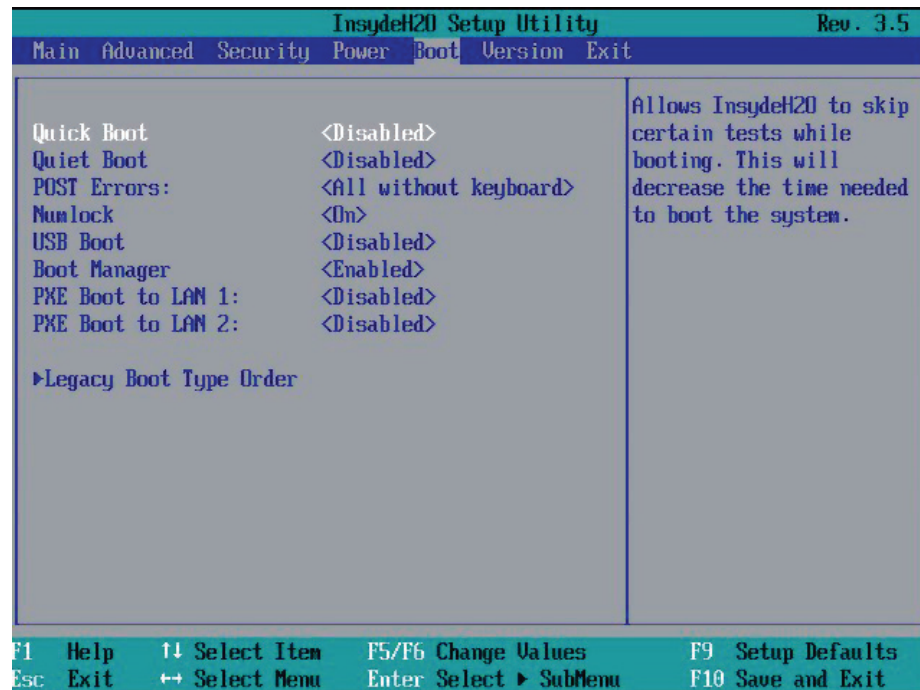

Figure 16-15 Boot Menu

Entry	Meaning
Quick Boot	Enable or disable If enabled, the programming device starts faster because various hardware function tests are skipped.
Quiet Boot	Booting is carried out in text mode.
POST errors	Specification of the booting behavior if errors are recognized. <ul style="list-style-type: none"> • Never halt on errors: Continue the booting process when errors occur. • Halt on all errors: Interrupt the booting process when errors occur. • All without keyboard: Interrupt the booting process when errors occur, except for keyboard errors. • All without kb/smart: Interrupt the booting process when errors occur, except for keyboard and S.M.A.R.T errors. (SMART: Self-Monitoring, Analysis and Reporting Technology)
Numlock	On = Enable numeric keypad on right Off = Disable numeric keypad on right (= navigation)
USB Boot	Allow/Do not allow booting of inserted USB devices.
PXE Boot to LAN 1	Enable or disable booting of the LAN1.
PXE Boot to LAN 2	Enable or disable booting of the LAN2.
EFI>	Set order of the EFI boot media
Legacy>	Set traditional boot order (Normal, Advanced, Advanced Placeholder).

Boot menu > Legacy: Standard

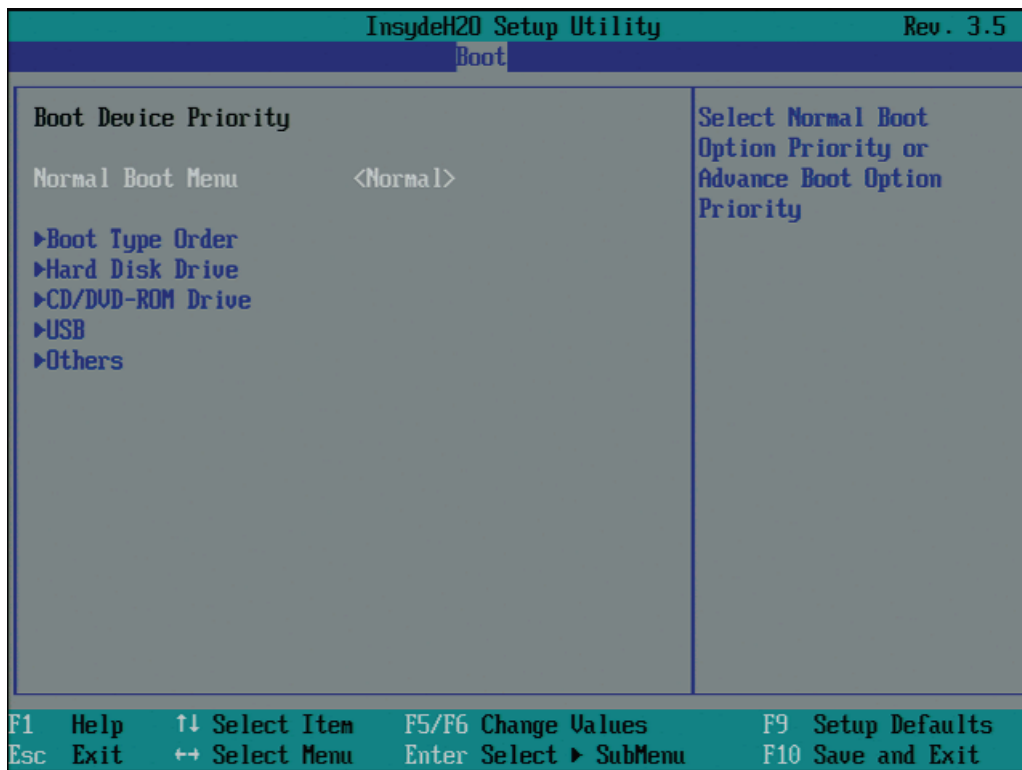

Figure 16-16 Submenu "Boot / Legacy / Normal Boot Menu <Normal>"

Entry	Meaning
Entry	Meaning
Normal Boot Menu	<ul style="list-style-type: none"> • Normal = Boot order based on component type • Advanced = Customized boot order of all components • Advanced Placeholder = Individual, fixed booting sequence that is not changed automatically
Boot Type Order	Submenu for setting the boot order of component groups relative to one another
Hard Disk Drive	Submenu for setting the boot order within the hard disk group
CD/DVD ROM Drive	Submenu for setting the boot order within the group of optical drives.
USB	Submenu for setting the boot order within the group of USB drives.
Others	Submenu for setting the boot order within the others group (for example Remote Boot Device)

Boot menu / Legacy / Normal Boot Menu (Advanced)

In this menu all the connected bootable components and their booting position are displayed. The booting position of the component can be moved freely.

During booting the component at the first position (highest booting priority) is used. If the component is not available, booting is carried out from the next component in the list.

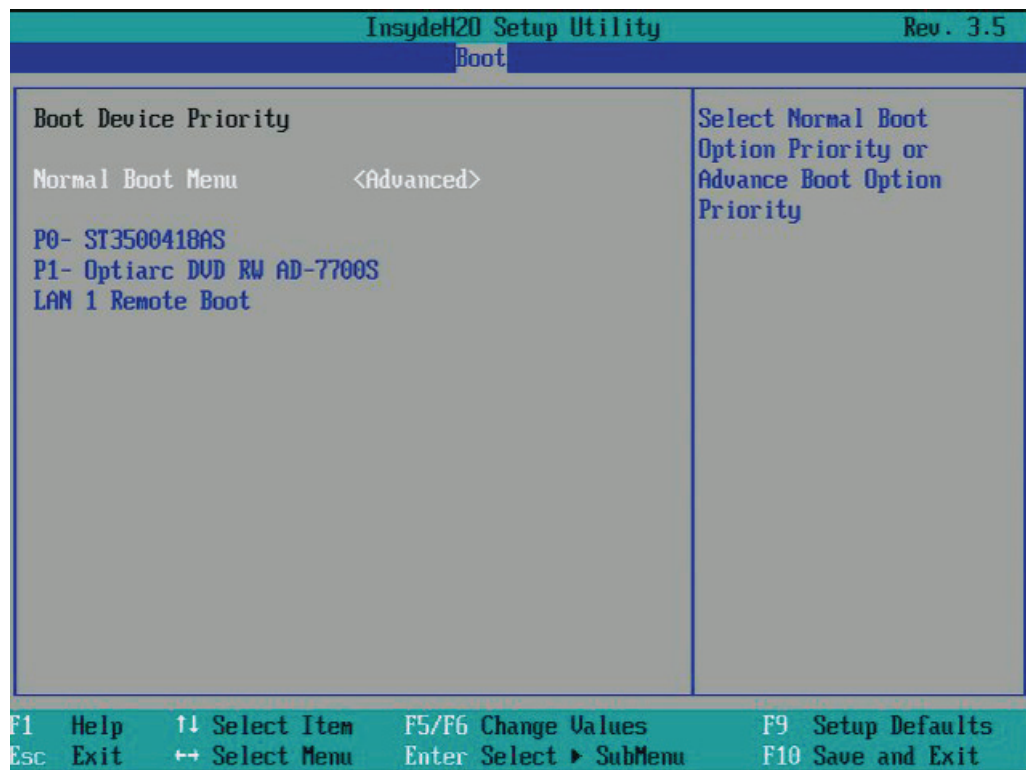

Figure 16-17 Submenu "Boot / Legacy / Normal Boot Menu <Advanced>"

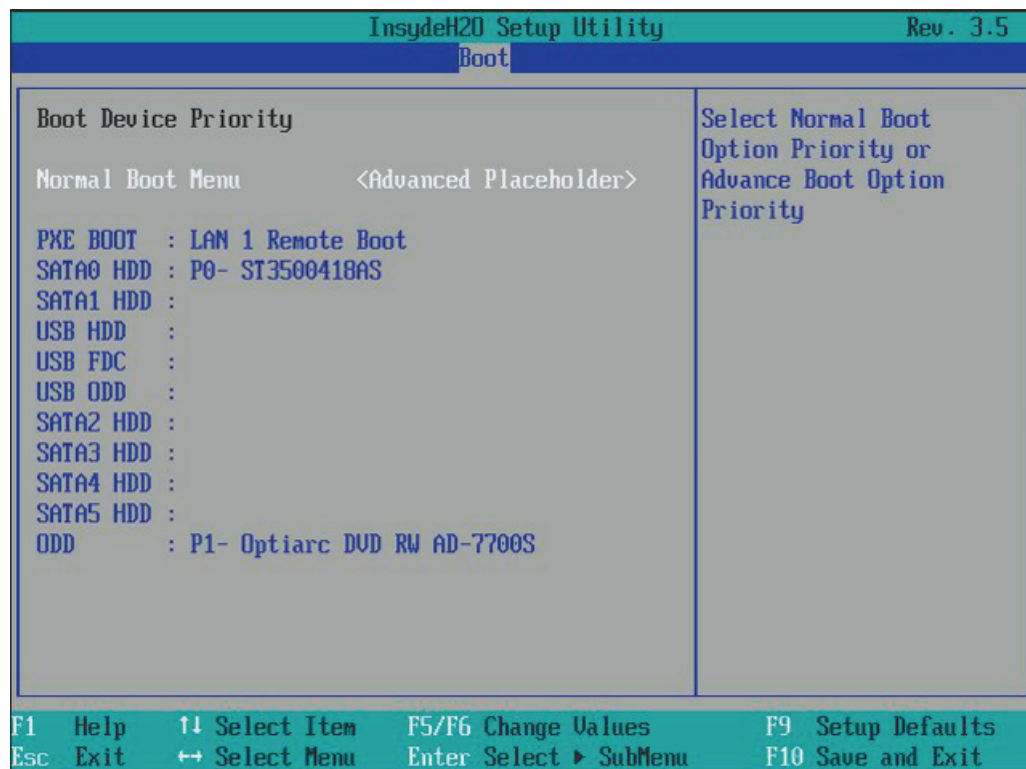

Figure 16-18 Advanced Placeholder

Bootable components that are disconnected from and then reconnected to the PC between booting processes are set by the BIOS to the first position in the case of the "Advanced" setting, and relocated back to their original booting position (Advanced Placeholder Boot) in the case of the "Advanced Placeholder" setting.

The boot sequence is changed as follows:

Select the boot component with the ↑ ↓ keys, move to the desired position with + or -.

Note

During the booting process the boot manager can be started by using the F12 key. The boot manager displays all the available boot components and boots the device selected by the user.

16.4.10 Version Menu

This menu contains system information which should be made available to Technical Support.

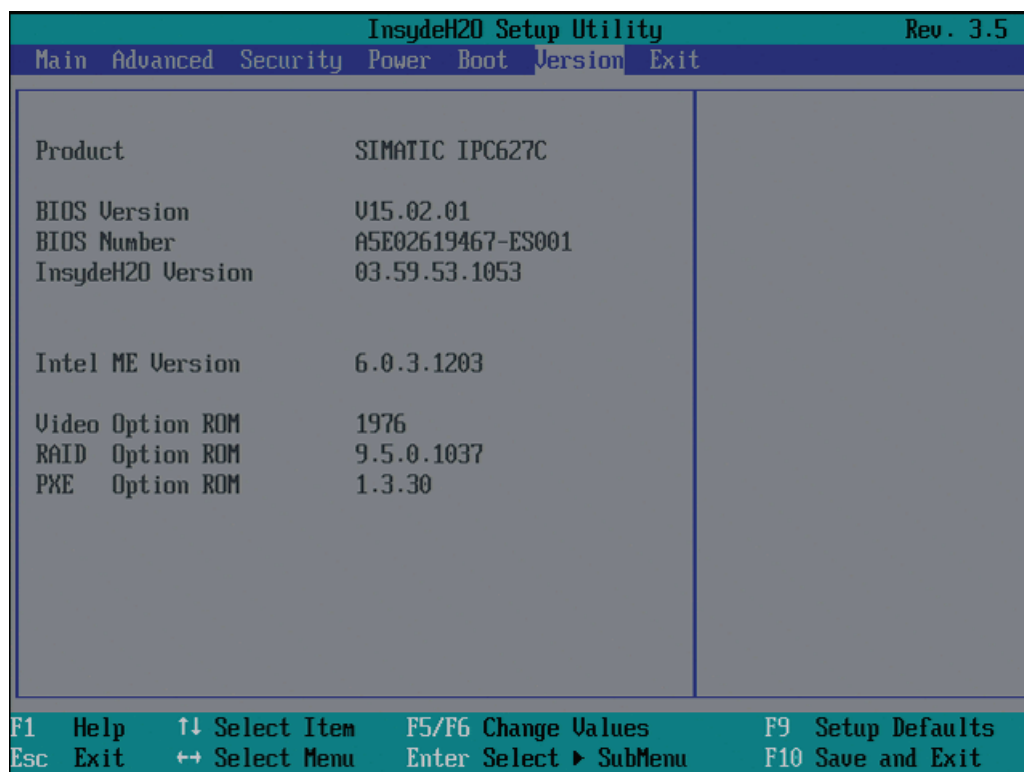

Figure 16-19 Version menu

16.4.11 Exit menu

You always exit BIOS Setup in this menu.

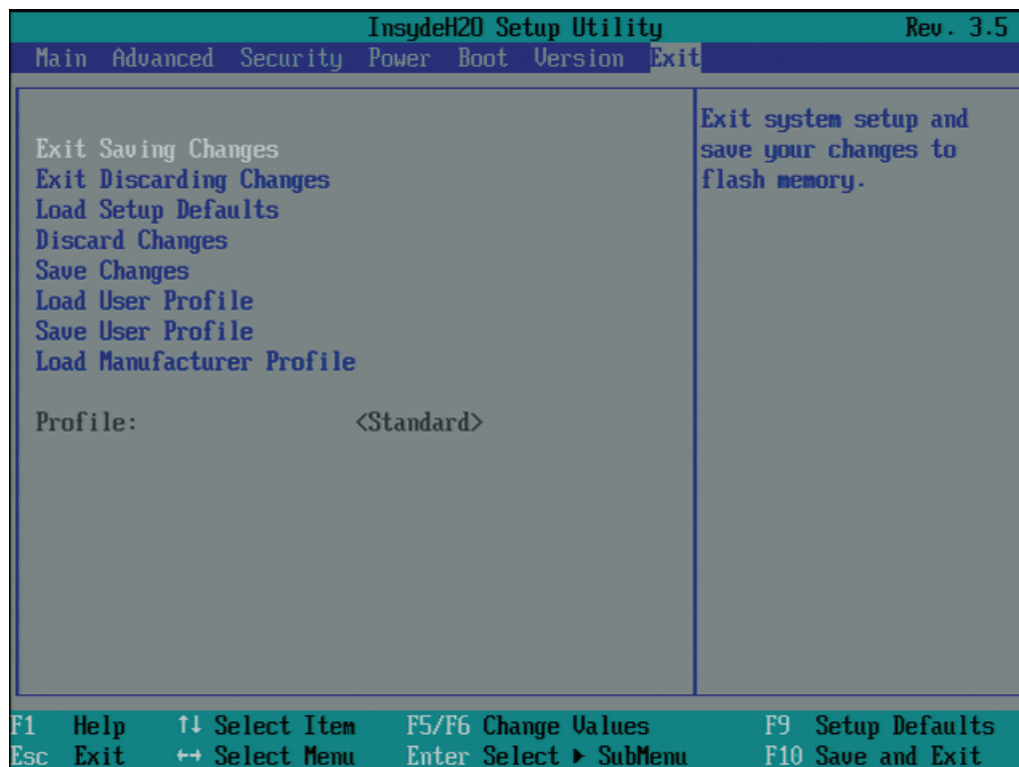

Figure 16-20 The "Exit" menu (example)

Entry	Meaning
Exit Saving Changes	All the parameter changes are saved. Afterwards a system restart is carried out with the new parameters.
Exit Discarding Changes	All the parameter changes are discarded and the system is restarted with the old parameters.
Load Setup Defaults	All parameters are set to safe values.
Discard Changes	All the parameter changes are rejected.
Save Changes	All the parameter changes are saved.
Load User Profile	All the user-defined settings are loaded. (The user settings must have been saved beforehand with the Save User Profile function.)
Save User Profile	The set parameters are saved as a USER profile.
Load Manufacturer Profile	The manufacturer parameters are downloaded to the SETUP device.
Profiles	Display field: Displays the active profile (Standard, User, Manufacturer) with which the device is currently operating ...

16.4.12 BIOS Setup default settings

Documenting your device configuration

If you have changed any default settings in Setup, you can enter them in the following table. You can then refer to these entries for any future hardware modifications.

Note

Print out the table below and keep the pages in a safe place once you made your entries.

Note

The default setup settings vary depending on the ordered device configuration.

If you have changed any default settings in Setup, you can enter them in the following table. You can then refer to these entries for any future hardware modifications.

BIOS Setup default settings

System parameters	Default settings	Local settings
Main		
System Time	hh:mm:ss	
System Date	MM/DD/YYYY	

System parameters	Default settings	Local settings
Advanced>Peripheral Configuration		
Internal COM 1	Auto	
Onboard Ethernet 1	Enabled	
Onboard Ethernet 2	Enabled	
PCI – MPI / DP	Enabled	

System parameters	Default settings	Local settings
Advanced>SATA Configuration		
SATA Controller	Enabled	
SATA Controller mode	AHCI	

System parameters	Default settings	Local settings
Advanced>Video Configuration		
Primary video device	PEG	
IGD boot type	VBIOS default	
Forced VGA	Disabled	
IGD Dual View DVI/CRT	Disabled	
IGD Dual View VGA DDC	Disabled	

System parameters	Default settings	Local settings
Advanced > USB Configuration		
USB Port0	Enabled	
USB Port1	Enabled	
USB Port2	Enabled	
USB Port3	Enabled	
USB Port6	Enabled	
USB Port7	Enabled	
USB Port8	Enabled	
USB Port9	Enabled	
USB Port10	Enabled	

System parameters	Default settings	Local settings
Advanced>Chipset Configuration		
Port 80h Cycles	LPC Bus	
VT-d	Enabled	
HPET	Enabled	

System parameters	Default settings	Local settings
Advanced>CPU Configuration		
P-States (IST)	Enabled	
Turbo Mode	Enabled	
CMP support	Auto	
HT Support	Auto	
Use XD Capability	Disabled	
VT Support	Enabled	
Turbo Mode	Enabled	
C-States	Enabled	

System parameters	Default settings	Local settings
Advanced>Active Management Technology Support		
Intel AMT Support	Disabled	
Intel AMT Setup Prompt	Disabled	
AMT CIRA Request Trig	Disabled	
AMT CIRA Timerout	30	
Un-Configure ME	Disabled	
USB Configure	Disabled	

System parameters	Default settings	Local settings
Advanced		
Fan control	Enabled	

System parameters	Default settings	Local settings
Security		
Supervisor Password	Not installed	
User password	Not installed	
Set Supervisor Password	Inactive (no password assigned)	
Set User Password	Inactive (no password assigned)	

System parameters	Default settings	Local settings
Power		
Wake on LAN 1	Disabled	
Wake on PME/LAN 2	Enabled	
Wake on Time	Disabled	
After Power Failure	Power On	

System parameters	Default settings	Local settings
Boot		
Quick Boot	Disabled	
Quiet Boot	Disabled	
POST errors	All without keyboard	
NumLOCK	On	
USB Boot	Disabled	
PXE Boot to LAN 1	Disabled	
PXE Boot to LAN 2	Disabled	

System parameters	Default settings	Local settings
Boot > EFI		

System parameters	Default settings	Local settings
Boot > Legacy		
Normal Boot Menu	Standard	

System parameters	Default settings	Local settings
Exit		
Profile:	Standard	

16.5 Active Management Technology (AMT)

16.5.1 AMT basics

The processors Intel Core i5 and Core i7 support Intel® vPro™ and Intel Active Management Technology at the hardware end.

An administrator at the Help Desk PC accesses the AMT PCs. Only the AMT PCs must have an integrated Intel AMT.

The following figure shows the possible structure of a network for remote management on the basis of SIMATIC AMT-PCs.

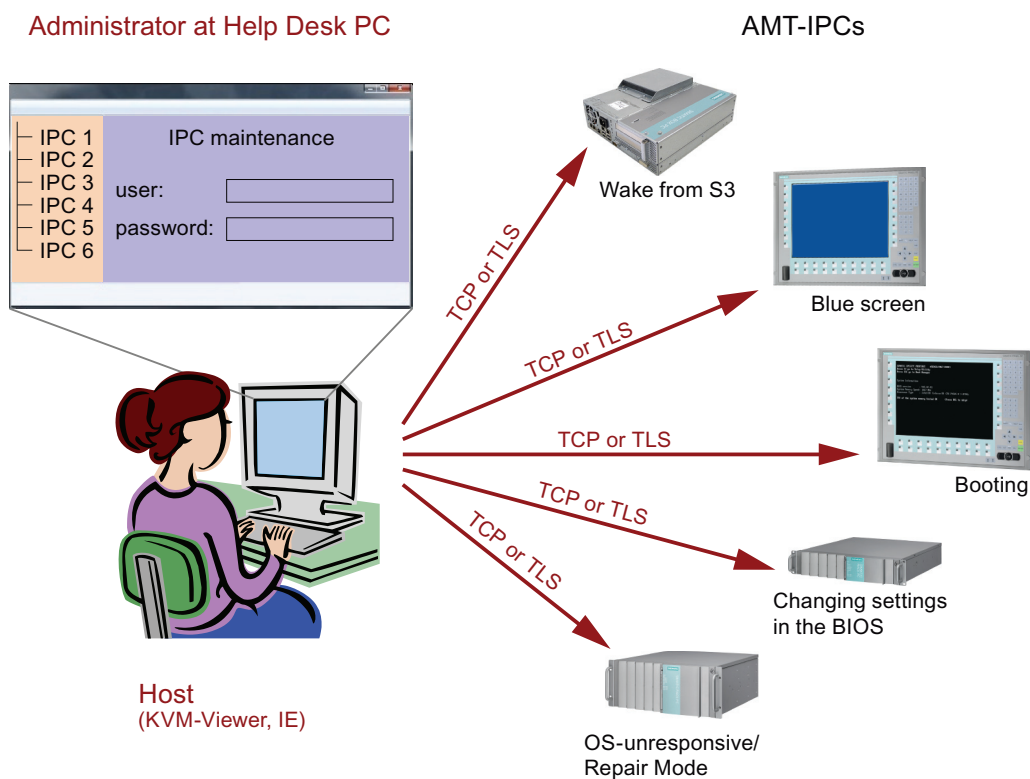

From a SIMATIC IPC which does not have Intel AMT functions, you can access networked SIMATIC IPCs with Intel AMT using the SIMATIC IPC Remote Manager and/or a web browser.

SIMATIC IPCs that support AMT feature two onboard Ethernet interfaces, each with a separate controller. You can configure the controller integrated in the chipset for use with Intel AMT. Further details about the controller can be found in the technical specification.

For security reasons, AMT is disabled when you receive a SIMATIC IPC. Enable AMT in the BIOS setup. Afterwards the Intel® Management Engine (Intel® ME) has to be activated and set for AMT. You make additional settings in the Management Engine:

- Configuring the network for access via AMT
- Creating a password

This section describes the required measures and settings on the local IPC so that the IPC can be controlled and maintained remotely from a management station known below as the help desk PC.

The local IPC is known below as the "AMT PC".

The sections contain the following information:

- AMT settings in the MEBx and in the BIOS setup
- Basic configuration of AMT
- Further useful notes

16.5.2 Enabling AMT, basic configuration

Procedure

For security reasons, AMT is not enabled on new devices.

To enable AMT, follow these steps:

1. Connect the AMT PC with the LAN.
2. If necessary, first reset AMT to the default status (see section "Unconfigure").
3. To access the BIOS, press the <F2> key while the device is booting.
4. In the Advanced menu, enable "Intel AMT Support", and "Intel AMT Setup Prompt".
5. Exit the BIOS with the <F10> key "Save and Exit". The AMT PC restarts.
6. To access the MEBx, press the <Ctrl+P> keyboard shortcut
7. In the login dialog, enter the standard password "admin".
8. Change the default password. The new password must include the following characters:
 - In total at least eight characters
 - One upper case letter
 - One lower case letter
 - One number
 - One of the special characters ! @ # \$ % ^ & * @ # \$ % ^ & *

Note

The underscore _ and the space characters are valid password characters, however they do not increase password complexity.

9. Enable "Intel (R) AMT Configuration > Manageability Feature Selection".
10. Enable "Intel (R) ME General Settings > Activate Network Access".

16.5.3 Advanced settings

The BIOS and the MEBx contain the most important basic settings for AMT. Additional tools are necessary if you want to make more advanced settings. If required, these must be downloaded from the relevant manufacturer's site. For information on the options and use of these tools, refer to the relevant documentation of the manufacturer.

- Manageability Commander and other tools of the Intel DTK (Manageability Developer Tool Kit): Programs from the Intel DTK that you can download from the Internet at "<http://software.intel.com/en-us/manageability>".
- AMT Web interface: For encrypted connections, the URL of the Web interface is "https://<Fully qualified domain name>:16993" and for unencrypted connections "http://<IP address>:16992".
- WinRM: A command line program that is part of Windows as of Windows Vista. This tool can be downloaded for older Windows versions.

16.5.4 Resetting with Un-configure

Note

If the AMT PC still has its factory settings, for example has just been purchased, you can skip this section.

If you have already configured AMT previously, it is best to discard all the previous AMT settings made in the MEBx.

Note

All previous settings in the management engine are deleted.

Correct operation in the plant may be at risk.

Note down all the settings in the MEBx. Make the settings again as necessary following Unconfigure.

To reset the AMT settings, follow these steps:

1. Enable the "Un-configure ME" entry in "Advanced > Active Management Technology Support" in the BIOS.
2. Exit the BIOS with the <F10> key "Save and Exit". The AMT PC restarts.
3. After the restart, a user prompt appears asking whether you really want to discard all the settings in the management engine:

```
Intel(R) Management Engine BIOS Extension v6.1.0.0005
Copyright(C) 2003-10 Intel Corporation. All Rights Reserved.

Found unconfigure of Intel(R) ME
Continue with unconfiguration (Y/N)
```

4. Confirm with "Y". On a German keyboard, this means pressing the <Z> key.

The device continues to boot with the factory settings of the management engine.

16.5.5 Determining the network address

To connect the AMT PC with the AMT server, the network address that uniquely localizes the AMT server on the AMT PC must be entered.

If DHCP is set for the automatic assignment of the network address in "Network Setup" in the MEBx of the AMT PC, the network address is not fixed.

Procedure

If the AMT server uses the same network address as the operating system of the AMT PC (most common situation):

1. You can obtain the address of the AMT server in the command line in Windows using "ipconfig" and in UNIX using "ifconfig".

If the AMT server and operating system do not use the same network address, ask your network administrator for the address you have been assigned.

16.5.6 Forcing user consent

When establishing a connection to the AMT PC, the KVM viewer may prompt the user to enter a six-figure code. This code is displayed on the screen of the AMT PC. The user of the AMT PC must inform the user of the KVM viewer of this code.

Procedure

To set up this code query on the KVM viewer, follow these steps:

1. Select "Intel(R) AMT Configuration > User Consent" in the MEBx.
2. Select the value "KVM" for "User Consent".

To allow a user with administrator privileges to avoid this code query, follow these steps:

1. Select "Intel(R) AMT Configuration > User Consent" in the MEBx.
2. Enable "Opt-in configurable from remote IT".

16.6 Communications processor CP 1616 onboard

16.6.1 Introduction

16.6.1.1 Properties

The CP 1616 onboard allows the connection of industrial PCs to Industrial Ethernet.

The basic characteristics of the PCS 1616 onboard are:

- Optimized for PROFINET IO
- Enhanced Real Time Ethernet Controller 400 = ERTEC 400
- Three RJ45 sockets for connecting terminal devices or addition network components
- Integrated 3-port real-time switch
- Automatic hardware detection

16.6.1.2 Network connections

Ethernet

The CP 1616 is designed for operation in Ethernet networks. Additional features are:

- The connectors are designed for 10BaseT and 100BaseTX.
- Data transfer rates of 10 and 100 Mbps in full/half duplex mode are supported.
- The handshake is performed automatically (auto negotiation).
- A 3-port realtime switch is located in the module.
- Autocrossing

Three RJ45 connectors

The CP 1616 is connected to the LAN (Local Area Network) via one of the three RJ45 sockets of the PC.

These three sockets lead to the integrated realtime switch.

16.6.1.3 Typical Communication Partners

CP 1616 onboard as an IO controller

The following diagram shows a typical application: CP 1616 onboard as PROFINET IO controller on the IO controller layer.

The IO base controller user program runs on the PC. This program accesses the functions of the IO base user program interface.

Data traffic is routed via the communication processor to several SIMATIC S7 PROFINET IO devices, ET 200S over Industrial Ethernet.

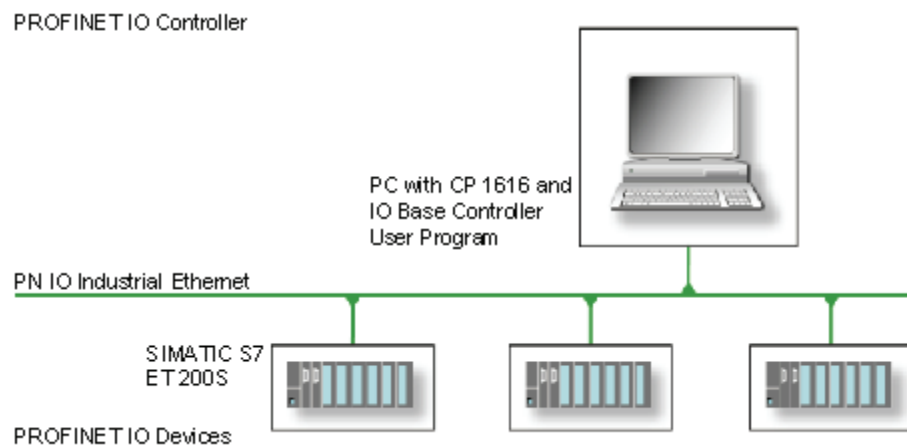

CP 1616 onboard as IO device

The following diagram shows a typical application: Two PCs each with a CP as a PROFINET IO device on the IO device layer.

A PC with a CP as PROFINET IO controller, a SIMATIC S7-400 with a CP 443-1 as PROFINET IO controller and two SIMATIC S7 ET 200S PROFINET IO devices are also connected in the network.

The IO base device user program runs on the IO device PC. This program accesses the functions of the IO base user program interface. Data traffic is routed via the CP 1616 onboard communication processor to a PC as PROFINET IO controller, or to an S7-400 automation system with CP 443-1 over Industrial Ethernet.

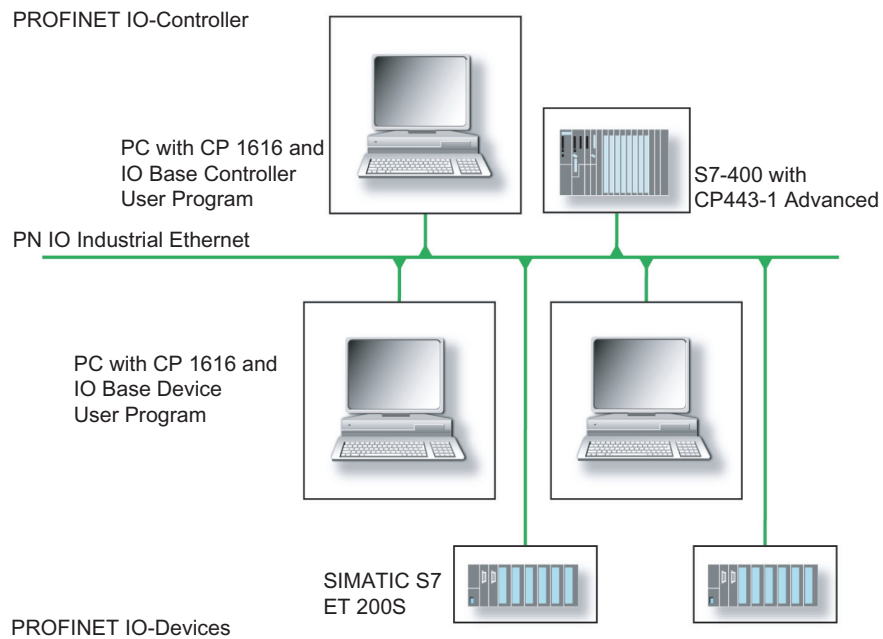

16.6.2 Firmware loader

Scenario for using the firmware loader

The CP 1616 onboard is supplied with the latest version of the firmware. If new functions become available due to product development, you can make them available by performing a firmware download.

Description

This section will familiarize you with the application area and use of the firmware loader. You can find additional, detailed information about the individual loader variants in the integrated help of the program.

Firmware

This refers to the system program in the SIMATIC NET modules.

Application area for the firmware loader

The firmware loader enables you to reload new firmware releases to SIMATIC NET modules. It is used for:

- PROFIBUS modules
- Industrial Ethernet modules
- Modules for gateways, for example IE/PB link

Installation

The firmware loader is available on your PG/PC under Windows following the installation of STEP 7/NCM PC.

Loader files

The firmware loader supports the following file types:

- <file>.FWL
A file form that contains further information, which is displayed by the firmware loader. The firmware loader can use this information to check if the firmware is compatible to the device.

Read the information provided along with the loader file, for example, in the readme file. This information is also displayed in the firmware loader when the FWL file is loaded.

16.6.2.1 Loading firmware

Start downloading procedure

1. In the Windows Start menu, select the menu command SIMATIC > STEP 7 > NCM S7 > Firmware Loader.

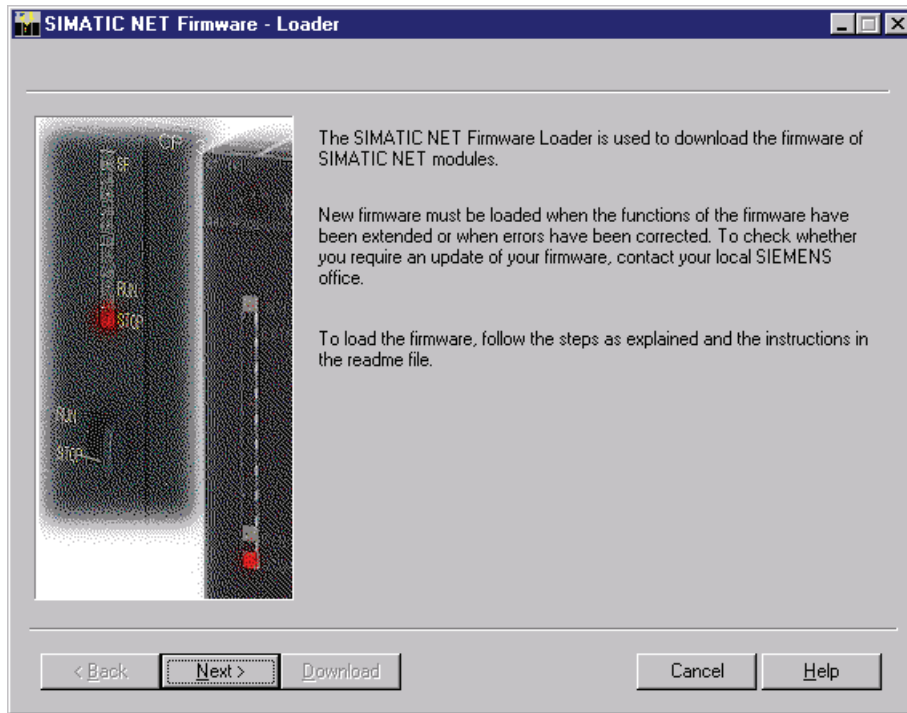

2. Click "Next" and follow the instructions in the dialog fields that follow. A help function is integrated in the software as support.

NOTICE

Ensure that the loader file you are using for the update is suitable for the version of firmware on your module. If you have any doubts, contact your local Siemens consultant.

NOTICE

Be aware that aborting the loading process may result in an inconsistent state in your module.

You can find additional, detailed information about the individual loader variants in the integrated help.

Note

When loading the firmware or commissioning the module, be aware that the CP 1616 onboard takes five MAC addresses (always in direct sequence). The first two are shown in the BIOS.

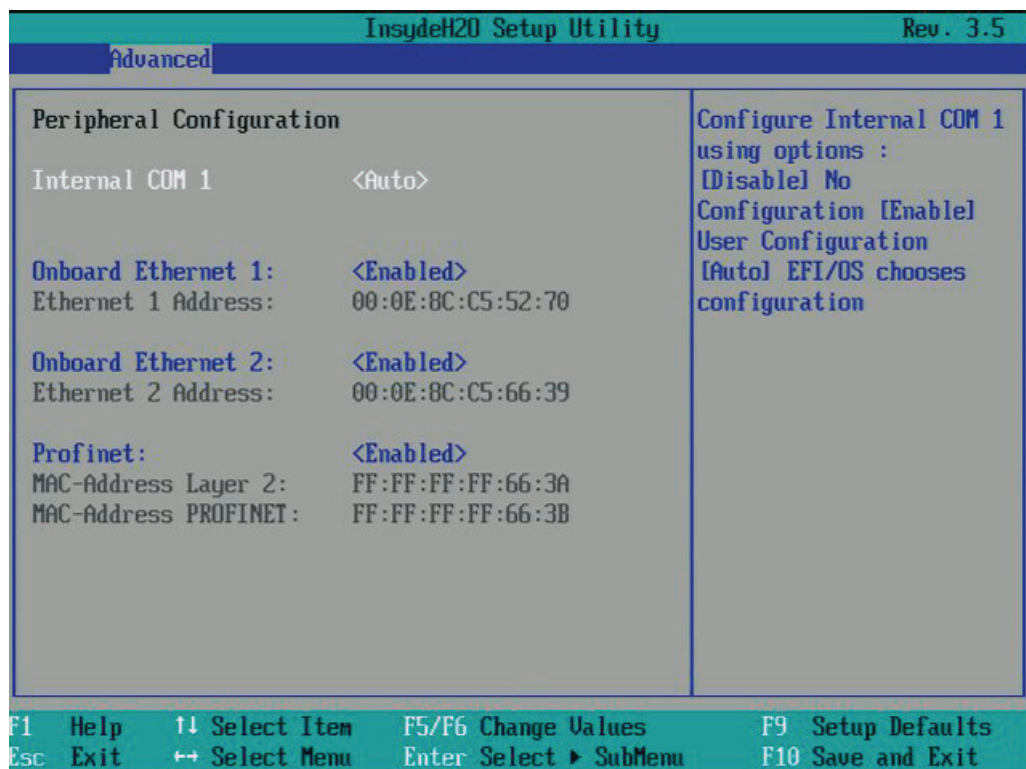

Figure 16-21 Advanced menu Peripheral Configuration

Example

The lower MAC address at "Profinet" is provided for Layer 2 communication, while the second one is used for Ethernet/PROFINET communication.

16.6.3 Further actions in STEP 7/NCM PC

Configuring

Your PC is now ready, although you still have to configure the SIMATIC NET communication software. The rest of the procedure is described in the "Commissioning PC Stations" manual (on the Windows PC that also contains STEP 7/NCM PC: Start > Simatic > Documentation > English > Commissioning PC Stations).

Appendix

A.1 Guidelines and declarations

Notes on the CE marking

 The following applies to the SIMATIC product described in this documentation:

EMC directive

AC voltage supply

The devices with AC voltage supply fulfill the requirements of the EC directive "2004/108/EC Electromagnetic Compatibility" and are intended for the following fields of application in accordance with the CE marking:

Area of application	Requirement for	
	Interference emission	Interference immunity
Industry	EN 61000-6-4: 2007	EN 61000-6-2: 2005

The device is also compliant with EN 61000-3-2:2006, harmonic currents and EN 61000-3-3:2008, voltage fluctuation and flicker.

DC voltage supply

These devices with DC voltage supply fulfill the requirements of the EC directive "2004/108/EC Electromagnetic Compatibility" and are intended for the following fields of application in accordance with the CE marking:

Area of application	Requirement for	
	Interference emission	Interference immunity
Industry	EN 61000-6-4: 2007	EN 61000-6-2: 2005

NOTICE

Radio interference is possible

This is a system of Class A. The equipment may cause RF interference in residential areas. In this case, the operating company may be held liable for taking appropriate measures.

Low-voltage directive

The device with AC power pack complies with the requirements of EC low voltage directive 2006/95/EC (Low Voltage Directive). Compliance with this standard has been verified according to: EN 60950-1:2006 +A11:2009 +A1:2010 +A12:2011

The device with DC power pack also complies with this standard but does not fall within the area of validity of the EU low-voltage directive.

Declaration of conformity

The EC declaration of conformity and the corresponding documentation are made available to authorities in accordance with the EC directives stated above. Your sales representative can provide these on request.

Design guidelines

Adhere to the installation guidelines and safety instructions given in this documentation during commissioning and operation.

Connecting peripherals

Interference immunity requirements are met if connected peripherals are suitable for industrial applications in accordance with EN 61000-6-2. Always use shielded cables to connect peripherals.

A.2 Standards, certificates and approvals

Information on the type plate

Note

The currently valid approvals are to be found on the device's rating plate.

ISO 9001 certificate

The Siemens quality management system for all production processes (development, production and sales) meets DIN ISO 9001:2000 requirements.

This has been certified by DQS (the German society for the certification of quality management systems).

Q-Net certificate no.: DE-000656 QM08

Software License Agreement

The device can be supplied with or without preinstalled software. For devices with preinstalled software, please note the relevant license agreements.

Approvals for the USA, Canada and Australia

Product safety

The following approval is available for the device:	
	Underwriters Laboratories (UL) in accordance with UL 508 and C22.2 No. 142 (IND.CONT.EQ)

EMC

USA	
Federal Communications Commission Radio Frequency Interference Statement	This equipment has been tested and found to comply with the limits for a Class A digital device, pursuant to Part 15 of the FCC Rules. These limits are designed to provide reasonable protection against harmful interference when the equipment is operated in a commercial environment. This equipment generates, uses, and can radiate radio frequency energy and, if not installed and used in accordance with the instruction manual, may cause harmful interference to radio communications. Operation of this equipment in a residential area is likely to cause harmful interference in which case the user will be required to correct the interference at his own expense.
Shielded Cables	Shielded cables must be used with this equipment to maintain compliance with FCC regulations.
Modifications	Changes or modifications not expressly approved by the manufacturer could void the user's authority to operate the equipment.
Conditions of operations	This device complies with Part 15 of the FCC Rules. Operation is subject to the following two conditions: (1) this device may not cause harmful interference, and (2) this device must accept any interference received, including interference that may cause undesired operation.

CANADA	
Canadian Notice	This Class A digital apparatus complies with Canadian ICES-003.
Avis Canadian	Cet appareil numérique de la classe A est conforme à la norme NMB-003 du Canada.

AUSTRALIA	
	This product meets the requirements of the standard EN 61000-6-4:2007 Generic standards - Emission standard for industrial environments.

cULus approval, Hazardous Location



CULUS Listed 7RA9 IND. CONT. EQ. FOR HAZ. LOC.

Underwriters Laboratories Inc., complying with

- UL 508 (Industrial Control Equipment)
- CSA C22.2 No. 142 (Process Control Equipment)
- ANSI/ISA 12.12.01 (Hazardous Location)
- CSA-213 (Hazardous Location)

APPROVED for Use in

- Cl. 1, Div. 2, GP. A, B, C, D T4A
- Cl. 1, Zone 2, GP. IIC T4

Note the following information

Note

This product must be installed according to the NEC (National Electric Code) stipulations.

When used in environments according to class I, division 2 (see above), the device must be mounted in an enclosure that corresponds to at least IP54 according to EN 60529.

Definition of ESD

All electronic modules are equipped with large-scale integrated ICs or components. Due to their design, these electronic elements are highly sensitive to overvoltage, and thus to any electrostatic discharge.

The electrostatic sensitive components/modules are commonly referred to as ESD devices. This is also the international abbreviation for such devices.

ESD modules are identified by the following symbol:



NOTICE

ESD devices can be destroyed by voltages well below the threshold of human perception. These static voltages develop when you touch a component or electrical connection of a device without having drained the static charges present on your body. The electrostatic discharge current may lead to latent failure of a module, that is, this damage may not be significant immediately, but in operation may cause malfunction.

Electrostatic charging

Anyone who is not connected to the electrical potential of their surroundings can be electrostatically charged.

The figure below shows the maximum electrostatic voltage which may build up on a person coming into contact with the materials indicated. These values correspond to IEC 801-2 specifications.

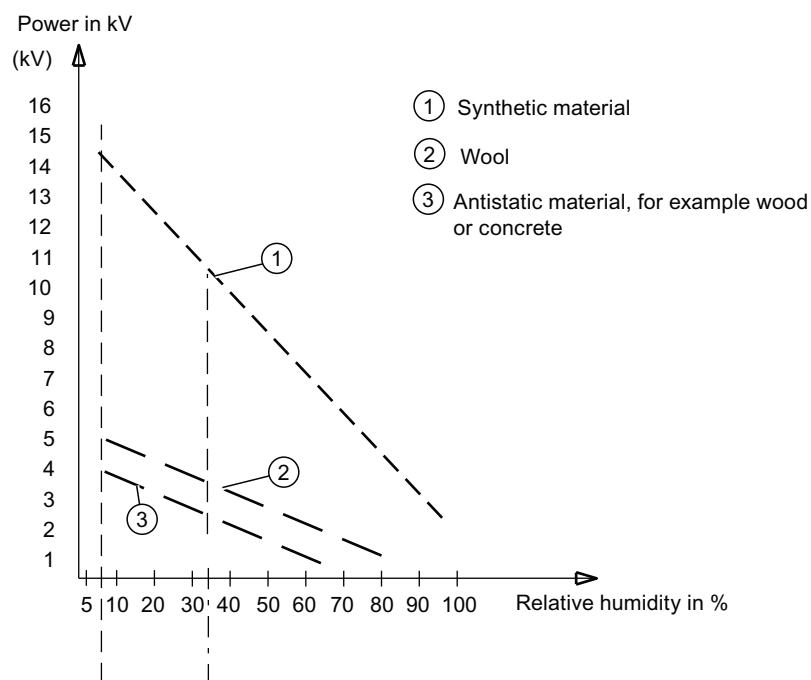

Figure A-1 Electrostatic voltages on an operator

Basic protective measures against electrostatic discharge

- Ensure good equipotential bonding:
When handling electrostatic sensitive devices, ensure that your body, the workplace and packaging are grounded. This prevents electrostatic charge.
- Avoid direct contact:
As a general rule, only touch electrostatic sensitive devices when this is unavoidable (e.g. during maintenance work). Handle the modules without touching any chip pins or PCB traces. In this way, the discharged energy can not affect the sensitive devices.

Discharge your body before you start taking any measurements on a module. Do so by touching grounded metallic parts. Always use grounded measuring instruments.

A.3 Service and support

You can find additional information and support for the products described on the Internet at the following addresses:

- Technical support (<http://www.siemens.com/automation/service&support>)
- Support request form (<http://www.siemens.com/automation/support-request>)
- After-sales information system for SIMATIC PC / PG (<http://www.siemens.com/asis>)
- SIMATIC Documentation Collection (<http://www.siemens.com/simatic-tech-doku-portal>)
- Your local representative (<http://www.siemens.com/automation/partner>)
- Training center (<http://www.sitrain.com>)
- Industry Mall (<http://mall.automation.siemens.com>)

When contacting your local representative or Technical Support, please have the following information at hand:

- Order number of the device (MLFB)
- BIOS version (industry PC) or image version (HMI device)
- Installed additional hardware
- Installed additional software

Tools & downloads

Please check regularly if updates and hotfixes are available for download to your device. The downloads are available on the Internet under "After Sales Information System SIMATIC PC/PG" (see above).

List of abbreviations

B.1 Abbreviations

Abbreviation	Term	Meaning
AC	Alternating current	Alternating current
ACPI	Advanced Configuration and Power Interface	
PLC	Programmable controller	
AGP	Accelerated Graphics Port	High speed bus system
AHCI	Advanced Host Controller Interface	Standardized controller interface for SATA devices. This is supported in Microsoft Windows XP as of SP1 and IAA driver.
AMT	Active Management Technology	Remote maintenance technology from Intel
APIC	Advanced Programmable Interrupt Controller	Extended programmable interrupt controller
APM	Advanced Power Management	Tool for monitoring and reducing power consumption of the PC
AS	Automation system	
ASIS	After Sales Information System	
AT	Advanced Technology	
ATA	Advanced Technology Attachment	
ATX	AT-Bus-Extended	
AWG	American Wire Gauge	US standard for the cable diameter
BIOS	Basic Input Output System	Basic Input Output System
CAN	Controller Area Network	
CD-ROM	Compact Disc – Read Only Memory	Removable storage medium for large data volumes
CD-RW	Compact Disc – Rewritable	Rewritable CD
CE	Communauté Européenne (CE symbol)	The product is in conformance with all applicable EC directives
CF	Compact Flash	
CGA	Color Graphics Adapter	Standard monitor interface
CIRA	Client Initiated Remote Access	Administration of AMT PCs not in the intranet
CLK	Clock pulse	Clock signal for controllers
CMOS	Complementary Metal Oxide Semiconductors	Complementary metal oxide semiconductors
COA	Certificate of authentication	Microsoft Windows Product Key
CoL	Certificate of License	License authorization
COM	Communications Port	Term for the serial interface
CP	Communication Processor	Communication computer
CPU	Central Processing Unit	CPU

List of abbreviations

B.1 Abbreviations

Abbreviation	Term	Meaning
CRT	Cathode Ray Tube	
CSA	Canadian Standards Association	Canadian organization for tests and certifications according to own or binational standards (with UL / USA) standards
CTS	Clear To Send	Clear to send
DRAM	Dynamic Random Access Memory	
DC	Direct Current	DC current
DCD	Data Carrier Detect	Data carrier signal detection
DDRAM	Double Data Random Access Memory	Memory chip with high-speed interface
DHCP	Dynamic Host Configuration Protocol	Protocol for configuring IP networks
DMA	Direct Memory Access	Direct memory access
DOS	Disk Operating System	Operating system without GUI
DP	Display Port	New powerful digital monitor port
DQS	Deutsche Gesellschaft zur Zertifizierung von Qualitätsmanagement mBH	
DSR	Data Set Ready	Ready for operation
DTK	Developer Tool Kit	Tools for software development, testing, configuration etc.
DTR	Data Terminal Ready	Data terminal is ready
DVD	Digital Versatile Disk	Digital versatile disk
DVI	Digital Visual Interface	Digital display interface
DVI-I	Digital Visual Interface	Digital display interface with digital and VGA signals
ECC	Error checking and correction	Error correction code
ECP	Extended capability port	Extended parallel port
EFI	Extensible Firmware Interface	
EGA	Enhanced Graphics Adapter	PC to monitor interface
ESD	Components sensitive to electrostatic charge	
DM	Electronic Manual	
EIDE	Enhanced Integrated Drive Electronics	An enhancement of the IDE standard
EISA	Extended Industry Standard Architecture	Extended ISA standard
EMM	Expanded Memory Manager	Manages memory expansions
EM64T	Extended Memory 64 technology	
EN	European standard	
EPROM / EEPROM	Erasable Programmable Read-Only Memory / Electrically Erasable Programmable Read-Only Memory	Plug-in submodules with EPROM/EEPROM chips
EPP	Enhanced Parallel Port	Bi-directional Centronics interface
ESC	Escape character	Control character
EWf	Enhanced Write Filter	
FAQ	Frequently Asked Questions	FAQs
FAT 32	File Allocation Table 32-bit	32-bit file allocation table
FBWF	File-Based Write Filter	

Abbreviation	Term	Meaning
FD	Floppy disk	Disk drive, 3.5"
FQDN	Fully qualified domain name	Full name of a domain
FSB	Front Side Bus	
GND	Ground	Chassis ground
GPT	Globally Unique Identifier Partition Table	
HD	Hard disk	Hard disk
HDA	High Definition Audio	
HDD	Hard Disk Drive	Hard disk drive
HU	Height unit	
HMI	Human Machine Interface	User interface
HORM	Hibernate Once - Resume Many	
HT	Hyper-Threading	
HTML	Hyper Text Markup Language	Script language for creating Internet pages.
HTTP	Hypertext Transfer Protocol	Protocol for data transfer on the Internet
Hardware	Hardware	
I/O	Input/Output	Data input/output on computers
IAA	Intel Application Accelerator	
IAMT	Intel Active Management Technology	Diagnostics, management and remote control of PCs
IDE	Integrated Device Electronics	
IDER	IDE Redirection	Remotely mounting an ISO file as a drive
IEC	International Electrical Commission	
IGD	Integrated Graphics Device	
IP	Ingress Protection	Degree of protection
IR	Infrared	Infrared
IRDA	Infrared Data Association	Standard for data transfer via IR module
IRQ	Interrupt Request	Interrupt request
ISA	Industry Standard Architecture	Bus for expansion modules
ITE	Information Technology Equipment	
KVM	Keyboard, Video, Mouse	
L2C	Level 2 cache	
LAN	Local Area Network	Computer network that is limited to a local area.
LCD	Liquid Crystal Display	Liquid crystal display
LEDs	Light Emitting Diode	Light emitting diode
LPT	Line Printer	Printer port
LVDS	Low Voltage Differential Signaling	
LW	Drive	
MAC	Media access control	Media access control
MC	Memory Card	Memory card in credit card format
ME	Management engine	Unit implemented by AMT
MEBx	Management Engine BIOS Extension	User interface for basic configuration of AMT
MLFB	Machine-readable product designation	

List of abbreviations

B.1 Abbreviations

Abbreviation	Term	Meaning
MMC	Micro Memory Card	Memory card of the format 32 mm x 24.5 mm
MPI	Multipoint-capable interface for programming devices	
MPS	Manageability Presence Server	Proxy for AMT
MS-DOS	Microsoft Disc Operating System	
MTBF	Mean Time Between Failures	
MUI	Multilanguage User Interface	Language localization in Windows
NA	Not Applicable	
NAMUR	Normenarbeitsgemeinschaft for Mess- und Regelungstechnik in der chemischen Industrie (standardization body for instrumentation and control technology in the chemicals industry)	
NC	Not Connected	Not connected
NCQ	Native Command Queuing	Automatic re-sorting of the file and disk access, for increased performance
NEMA	National Electrical Manufacturers Association	Syndicate of manufacturers of electrical components in the USA
NMI	Non Maskable Interrupt	Interrupt the processor can not reject
NTFS	New Techniques File System	Secure file system for Windows versions (2000, XP, 7)
ODD	Optical Disk Drive	
OPC	OLE for Process Control	Standardized interface for industrial processes
PATA	Parallel ATA	
PC	Personal computer	
PCI	Peripheral Component Interconnect	High-speed expansion bus
PCIe	Peripheral Component Interconnect express	High-speed serial, differential full-duplex PtP interface with high data rate.
PCMCIA	Personal Computer Memory Card International Association	
PE	Protective Earth	Protective conductor
PEG	PCI Express Graphics	
PG	Programming device	
PIC	Programmable Interrupt Controller	Programmable interrupt controller
POST	Power On Self Test	
PRTC	Protected Real Time Clock	Clock in the management engine MEBx
PXE	Preboot Execution Environment	Software for running new PCs without hard disk data via the network
RAID	Redundant Array of Independent Disks	Redundant hard disk array
RAL	Restricted Access Location	Installation of device in operating facilities with restricted access - for example, a locked switchgear cabinet
RAM	Random Access Memory	
RI	Ring Input	Incoming call
ROM	Read-Only Memory	

Abbreviation	Term	Meaning
RS 485	Reconciliation Sublayer 485	Bi-directional bus system designed for up to 32 nodes.
RTC	Real Time Clock	Real-time clock
RTS	Reliable Transfer Service	Request to send
RxD	Receive Data	Data transfer signal
SAS	Serial attached SCSI	
SATA	Serial Advanced Technology Attachment	
SCSI	Small Computer System Interface	
SDRAM	Synchronous DRAM	
SELV	Safety Extra Low Voltage	Safety extra low voltage
SLC	Second Level Cache	
SMART	Self Monitoring Analysis and Reporting Technology	Hard disk error diagnostics program
SMS	Short Message Service	Short message via telecommunication network
SNMP	Simple Network Management Protocol	Network protocol
SO-DIMM	Small Outline Dual Inline Memory Module	
SOL	Serial over LAN	Text-based remote control
SOM	SafeCard on Motherboard (SOM)	
SPP	Standard Parallel Port	Synonym for parallel port
SRAM	Static Random Access Memory	Static RAM
SSD	Solid State Drive	
SVGA	Super Video Graphics Array	Enhanced VGA standard with at least 256 colors
SVP	Serial number of the device	
SW	Software	
TCO	Total Cost of Ownership	
TFT	Thin-Film-Transistor	Type of LCD flat-screen
TTY	Tele Type	Asynchronous data transfer
TxD	Transmit Data	Data transfer signal
TXT	Trusted Execution Technology	Hardware implementation
TWD	Watchdog Time	Watchdog monitoring time
UEFI	Unified Extensible Firmware Interface	
UL	Underwriters Laboratories Inc.	US organization for tests and certifications according to own or binational standards (with CSA / Canada) standards.
UMA	Unified Memory Architecture	Video memory
URL	Uniform Resource Locator	Designation of the full address of an Internet page
USB	Universal Serial Bus	
UXGA	Ultra Extended Graphics Array	Graphic standard, maximum resolution 1600x1200 pixels.
V.24		ITU-T standardized recommendation for data transfer via serial ports.
VCC		Positive supply voltage of integrated circuits

List of abbreviations

B.1 Abbreviations

Abbreviation	Term	Meaning
VDE	Verein deutscher Elektrotechniker (Union of German Electrical Engineers)	
VGA	Video Graphics Array	Video adapter which meets industrial standard
VRM	Voltage Regulator Module	
VT	Virtualization Technology	Intel technology with which a virtually closed environment can be made available.
VT-D	Virtualization Technology for Directed I/O	Enables the direct assignment of a device (e.g. network adapter) to a virtual device.
W2k	Windows 2000	
WAN	Wide Area Network	
WAV	Wave Length Encoding	Loss-free file format for audio data.
WD	Watchdog	Program monitoring with error detection and alarming.
WLAN	Wireless LAN	LWireless local area network
WoL	Wake on Local Area Network	
WWW	World Wide Web	
XD	Execute Disable Capability	Hardware implementation
XGA	Extended Graphics Array	Graphic standard, maximum resolution 1024x768 pixels.
ZMM	Zero Maintenance Cache Protection Module	Maintenance-free cache unit for saving cache contents

Glossary

Automation system (AS)

The programmable logical controllers (PLC) of the SIMATIC S7 system consist of a central controller, one or more CPUs, and various I/O modules.

Backup

Duplicate of a program, data carrier or database, used either for archiving purposes or for the protection of vital and non-replaceable data against loss when the working copy is corrupted. Some applications automatically generate backup copies of data files, and manage both the current and the previous versions on the hard disk.

BEEP code

If the BIOS detects a boot error, it outputs an audible warning based on the current test result

Booting

Start or restart of the computer. During booting the operating system is transferred from the system data carrier to the work memory.

Cache

High-speed access buffer for interim storage (buffering) of requested data.

CE marking

Communauté Européene The CE marking confirms compliance of the product with corresponding EC Directives, for example, with the EMC Directive.

Chipset

Located on the motherboard, connects the processor with the RAM, the graphic controller, the PCI bus, and the external interfaces.

Cold start

A start sequence, starting when the computer is switched on. The system usually performs some basic hardware checks within the cold start sequence, and then loads the operating system from the hard disk to work memory -> boot

COM interface

The COM interface is a serial V.24 interface. The interface is suitable for asynchronous data transfer.

Configuration files

These are files containing data which define the configuration after restart. Examples of such files are CONFIG.SYS, AUTOEXEC.BAT and the registry files .

Configuration software

The configuration software updates the device configuration when new modules are installed . This is done either by copying the configuration files supplied with the module or by manual configuration using the configuration utility.

Controller

Integrated hardware and software controllers that control the functions of certain internal or peripheral devices (for example, the keyboard controller).

Device configuration

The configuration of a PC or programming device contains information on hardware and device options, such as memory configuration, drive types, monitor, network address, etc. The data are stored in a configuration file and enable the operating system to load the correct device drivers and configure the correct device parameters. . If changes are made to the hardware configuration, the user can change entries in the configuration file using the SETUP program. .

Drivers

Program parts of the operating system. They adapt user program data to the specific formats required by I/O devices such as hard disk, printers, and monitors.

EMC directive

Directive concerning **Electromagnetic Compatibility**. Compliance is confirmed by the CE marking and the EC certificate of conformity.

Energy management

The energy management functions of a modern PC allow individual control over the current consumption of vital computer components (e.g. of the monitor, hard disk and CPU), by restricting their activity based on the current system or component load. Energy management is of particular importance for mobile PCs.

Energy options

The energy options can be used to reduce energy consumption of the computer, while keeping it ready for immediate use. This can be configured in Windows by selecting Settings > Control Panel > Energy options.

ESD guidelines

Directive for using electrostatic sensitive components.

Ethernet

Local network (bus structure) for text and data communication with a transfer rate of 10/100 Mbps.

Formatting

Basic partitioning of memory space on a magnetic data carrier into tracks and segments. Formatting deletes all data on a data carrier. All data carriers must be formatted prior to their first use.

Hard disks

Hard disks represent a form of magnetic disk storage medium (Winchester drives, hard disks) with integrated magnetic disks.

Hub

A term in network technology. In a network, a device joining communication lines at a central location, providing a common connection to all devices on the network.

Image

This refers to the image, for example, of hard disk partitions saved to a file in order to restore them when necessary.

LAN

Local Area Network: LAN is a local network that consists of a group of computers and other devices that are distributed across a relatively restricted range and are linked with communication cables. The devices connected to a LAN are called nodes. The purpose of networks is the mutual use of files, printers or other resources.

Legacy USB support

Support of USB devices (e.g. mouse, keyboard) on the USB ports without driver.

License key

The license key represents the electronic license stamp of a license. Siemens provides the license keys for protected software.

License key diskette

The license key diskette contains the authorizations or license keys required to enable protected SIMATIC software.

Low-voltage directive

EC directive for product safety of products operated with low voltage (50 VAC to 1000 VAC, 70V to 1500 VDC) that are not governed by other directives. Compliance is confirmed by the CE marking and the EC certificate of conformity.

Module

Modules are plug-in units for PLCs, programming devices or PCs. They are available as central modules, interfaces, expansion modules or mass storage (mass storage modules), for example.

Module bracket

The module bracket is used to fasten modules and ensure safe contact and transport. Shocks and vibrations especially affect large, heavy modules. It is therefore recommended to use the module bracket for this type of module. There are also short, compact and light modules on the market. The module bracket was not designed for these modules because the standard fastening is sufficient for them.

Motherboard

The motherboard is the core of the computer. Here, data are processed and stored, and interfaces and device I/Os are controlled and managed.

PATA

An interface for hard disk drives and optical drives with parallel data transfer of up to 100 Mbps.

Plug&Play

Generally, a reference to the ability of a computer to automatically configure the system for communication with peripheral devices (for example monitors, modems or printers). The user can plug in a peripheral and "play" it at once without manually configuring the system. A Plug&Play PC requires both a BIOS that supports Plug&Play and a Plug&Play expansion card.

POST

Self-test performed by the BIOS after the computer is switched on. Performs a RAM test and a graphic controller test, for example. The system outputs audible signals (beep codes) if the BIOS detects any errors; the relevant message indicating cause of error is output on the screen.

PROFIBUS/MPI

Process Field Bus (standard bus system for process applications)

PROFINET

PROFINET is the name of the standard for Industrial Ethernet developed and maintained by the PROFIBUS user organization. PROFINET unites protocols and specifications with which Industrial Ethernet meets the requirements of industrial automation technology.

Programmable controller (PLC)

The programmable logical controllers (PLC) of the SIMATIC S5 system consist of a central controller, one or more CPUs, and various other modules (e.g. I/O modules).

PXE server

A **Preboot Execution Environment** server is part of a network environment and can provide software to connected computers even before they boot. This can involve operating system installations or servicing tools, for example.

RAID

Redundant Array of Independent Disks: Data storage system which is used to store data along with the error correction codes (e.g. parity bits) on at least two hard disks, in order to increase system reliability and performance. The hard disk array is controlled by management programs and a hard disk controller for error correction. The RAID system is usually implemented in network servers.

Recovery DVD

Contains the tools for setting up the hard disks and the Windows operating system.

Reset

Hardware reset: Reset/restart of the PC using a button/switch.

Restart

Warm start of a computer in operating state without switching off the power supply (Ctrl + Alt + Del)

Restore DVD

The Restore DVD is used to restore the system partition or the entire hard disk to factory state if the system has crashed. The bootable DVD contains all the necessary image files. You can also create a boot disk allowing restoration via the network.

SETUP (BIOS Setup)

A program in which information about the device configuration (that is, the configuration of the hardware on the PC/PG) is defined. The device configuration of the PC/PG is preset with defaults. Changes must therefore be entered in the SETUP if a memory extension, new modules or a new drive are added to the hardware configuration.

Troubleshooting

Error cause, cause analysis, remedy

V.24 interface

The V.24 interface is a standardized interface for data transmission. Printers, modems, and other hardware modules can be connected to a V.24 interface

Warm restart

The restart of a computer after a program was aborted. The operating system is loaded and restarted again. The hot key CTRL+ ALT+ DEL can be used to perform a warm start.

Index

"

"Peripheral Configuration" submenu, 227

2

24 V DC power supply,
Connecting, 49

A

Abbreviations, 265
AC power supply, 181
AC voltage supply, 259
Accessories, 23
Allocation of resources, 126
Antivirus software, 60
Approval, 3
Assignment
I/O addresses,
Authorization, 149

B

Backlighting, 20
Backup battery, 205
Battery monitoring, 111
Battery replacement, 139
Beep codes, 164
BEEP codes, 164
BIOS, 196
Beep codes, 164
BIOS settings, 67
BIOS Setup, 221
Default settings, 244
Menu layout, 224
Menus, 223
Starting, 222
BIOS Setup menus
Advanced, 226
Boot, 239
Main, 225
Security, 237
Version, 242

Boot sequence
Error messages, 163

Booting
Error messages, 163

Burner software, 68

Bus board
Design, 210
Removing, 142

C

Care, 114
CE marking, 260
Certificates, 260
Certifications, 260
Characteristics, 21
CheckLanguageID, 94
Chip set, 196
Clamping frame
Seal, 40
Cleaning,
Front membrane, 115
Stainless steel front, 115
Cleaning agents, 113
Cleaning guidelines, 117
COA label, 27
Commissioning, 13
Compact Flash card, 132
installing, 134
Removing, 135
Computer unit
Separating from the control unit, 119
Condensation, 13
Connecting, 260
24 V DC power supply, 49
Device, 54
Electrical connection, 11
Peripherals, 260
Power supply 120/230 V AC, 46
S7 automation system, 54
Connection components, 43
Connector pin assignment
PCI slot, 211
Control elements,
Control unit, 20
Separating from the computer unit, 119
couple, 55
Device, 55

- Couple
 - Couple device via MPI/PROFIBUS, 54
 - Device, 54
- Coupling with SIMATIC S7, 53
- CPU, 196

D

- Data backup, 160
- Data exchange, 53
- DC voltage supply, 259
- Degree of protection, 32
 - IP65 degree of protection, 32
- Design
 - Bus board, 210
 - Motherboard, 195
- Design guidelines, 260
- Device, 79
 - Connecting, 54
 - Connecting an S7 automation system, 54
 - couple, 55
 - Couple, 54
 - Couple via MPI/PROFIBUS, 54
 - Open, 122
 - Separating, 120
 - Switching on, 79
- Device configuration, 244
- Device driver CP16xx.sys, 53
- Device fan, 146
- Device fan supply, 205
- Device with stainless steel front
 - Installation, 39
- DiagBase software, 107
- DiagMonitor
 - Expansion, 23
 - Temperature monitoring, 108
- DiagMonitor software, 107
- Diagnostics
 - BIOS beep codes, 164
 - DiagBase software, 107
 - DiagMonitor software, 107
 - Troubleshooting, 171
- Dimension drawing, 192
- Dimensional drawings
 - Expansion modules, 193
- Dimensions, 192
 - IPC677C, 192
- Directives
 - ESD directives, 262

- Display, 20
 - Backlighting, 15
 - Pixel, 15
 - Ports, 206
 - Screen saver, 15
 - TFT-LC display, 15
- Display ports, 44
- Distributed, 53
- Documentation and Drivers CD/DVD, 148
- Download, 14
- Drive bay module, 127
 - Removing, 128
- DVD burner, 196
- DVD burner drive
 - Removing, 129
- DVD ROM
 - Installing burner or DVD software, 158
- DVI/VGA port, 43

E

- Electrical potential difference, 51
- Electrostatic charge, 16
 - Precautions, 16
- Electrostatic sensitive devices, 262
- EMC directive, 261
 - AC voltage supply, 259
 - DC voltage supply, 259
- Equipotential bonding, 51
- Equipotential Bonding, 51
- Error messages
 - BIOS beep codes, 164
 - Booting, 163
- ESD, 17
 - Directive, 16
 - Handling, 17
 - Measuring, 17
 - modify., 17
 - Shipping, 17
- ESD directives, 262
- Ethernet, 53
- ETHERNET port, 43
- Ethernet RJ45 port, 22
- Ethernet strain relief, 51
- Expansion, 23
 - Memory, 123
- Expansion modules
 - installing, 125
- Expansion slots, 21
- External interfaces, 199

F

- Fan
 - Removing, 146
- Fan monitoring, 109
- Fault diagnostics, 164
- Field devices, 53
- Field of application, 25
- Firewall, 60
- First commissioning, 65
- Flash drive
 - Booting, 76
 - Functionality, 75
- Front membrane, 116
 - Cleaning, 115
- Front ports, 208
- Function key, 103
 - labeling, 103

G

- Graphics, 196

H

- Hard disk drive
 - Removing, 130
- Hard disk drives
 - Partitions, 70
- Hard disks, 21
 - Partitions, 69
- Hotfix, 14

I

- I/O addresses
 - Assignment, 216
 - Assignment, 216
- I/O front ports, 208
- Identification data, 27
- IEC power connector, 45
- Image
 - creating, 160
- Installation
 - Burner / DVD software, 158
- Installation information, 28
 - Stainless steel front, 30
- Installation of operating system
 - Windows 7, 152
 - Windows XP, 150

Installing

- Memory modules, 124
- Modules, 125
- Installing language package, 153
- Installing Windows, 150
- Integrated mouse, 105

Integration

- Ethernet, 53
- PROFIBUS, 53
- PROFINET, 53

Interface, 54

- MPI/DP interface, 54
- USB, 67

Interfaces

- Ethernet, 201
- PROFIBUS/MPI, 197
- RJ45 Ethernet, 22
- USB, 197
- VGA, 22

Interfaces assignment on the motherboard

- COM2 (X31), 204

Internal interfaces, 204

- Interrupt reaction time, 219
- IPC Wizard, 66
- IT communication, 53

K

- Key code, 184
- Key panel, 99
- Keyboard table, 184

L

- labeling, 103
 - Function key, 103
 - Softkey, 103
- Labeling, 103
- Labeling strips, 104
 - Handwritten strips, 104
- Language selection
 - Windows Vista Ultimate, 95
 - Windows XP, 95
- Laser printer, 103
- LED,
 - Operating status,
- License key, 149
- Lithium battery, 139
- Localized information, 47
- Low-voltage directive, 260
- LVDS
 - Ports, 207

M

- Main memory, 21
- Maintaining, 114
- Maintenance, 113
- Measuring, 17
 - ESD, 17
- Membrane keyboard, 20
- Memory, 196
- Memory configuration, 124
- Memory expansion, 123
- Memory modules
 - installing, 124
 - Removing, 124
- Messages
 - BIOS beep codes, 164
- modify., 17
 - ESD, 17
- Modules
 - Module bracket, 125
- Monitoring
 - Status displays,
 - Temperature, 108
 - Watchdog, 108
- Motherboard
 - Characteristics, 196
 - Design, 195
 - External interfaces, 199
 - Internal interfaces, 204
 - Location of the interfaces, 198
 - Removing, 143
- Mounting clamps, 40
- Mouse, 20
- MPI network, 54
- MUI, 153

N

- Note, 28
 - General information, 13
 - Installation guidelines, 28
 - Safety information, 11
- Numeric keys, 101

O

- On/off button, 78
- On/Off switch, 77
- Open
 - Device, 122
- Operating, 105
 - Touch panel, 105

- Operating status,
- Operating system
 - Updates, 159
 - Windows 7, 155
- Operating systems, 23
- Operator panels, 44

P

- Package contents, 26
 - Checking, 26
- Packaging, 26
 - Checking, 26
 - Removing, 26
- Partition, 153
 - in the default factory setting, 153
 - Windows XP as-delivered condition, 151
- Partitions
 - Hard disk drives, 70
 - Hard disks, 69
- PC Wizard, 62
- PCI Express
 - Pin assignment, 213
- PCI hardware interrupt, 219
- PCI slot
 - Connector pin assignment, 211
- Peripheral, 67
- Peripherals, 260
 - Connecting, 260
- Pin assignment
 - PCI Express slot, 213
- Pixel, 15
 - Defective pixel, 15
- Port pin assignments
 - CF card, 203
 - COM1, 204
 - DVI, 202
 - Ethernet, 201
 - PROFIBUS/MPI, 200
 - USB, 199
- Ports, 198
 - COM, 43
 - Display, 206
 - ETHERNET, 43
 - LVDS, 207
 - Operator panels, 44
 - PROFIBUS/MPI, 43
 - USB, 43
 - VGA, 43
- POST codes
 - BIOS beep codes, 164
- Power factor correction, 182

Power Good signal, 182
 Power requirements, 181
 Power supply, 46
 AC voltage supply, 181
 DC voltage supply, 183
 IEC power connector, 45
 Removing, 141
 WinAC module, 212
 Processor, 21
 Removing, 147
 PROFIBUS, 53
 Integration, 53
 PROFIBUS/MPI interface, 22
 PROFIBUS/MPI port, 43
 PROFIBUS-DP network, 54
 PROFINET, 257
 PROFINET IO application, 54
 Protective foil, 24

R

Radiation, 12
 High frequency radiation, 12
 RAID controller software, 161
 RAID Level 1, 71
 RAID system
 Management functions, 71
 Rating plate, 260
 Recovery
 Windows 7, 154
 Recovery DVD, 148
 Remote boot, 53
 Removing
 Bus board, 142
 Drive bay module, 128
 DVD burner drive, 129
 Fan, 146
 Hard disk drive, 130
 Memory modules, 124
 Motherboard, 143
 Power supply, 141
 Processor, 147
 Repairs, 12
 Tools, 137
 Replacing
 Battery, 139
 Resistance, 116
 Resistance to chemicals, 116
 Restore DVD, 148
 Restoring the as-delivered condition, 149
 RJ45 Ethernet,

S

Safety information, 11
 SATA/PATA Configuration, 228
 Scope, 3
 Scope of maintenance, 114
 Screen saver, 92
 Seal, 39
 Self-test, 80
 Separating
 Device, 120
 Serial port, 43
 SetBrightness, 89
 Setting up the language selection, 153
 Shipping, 17
 ESD, 17
 SIMATIC IPC Wizard, 66
 Start screen, 66
 SIMATIC NET, 54
 SIMATIC PC Wizard, 62
 Start screen, 62
 starting, 65
 SIMATIC S7, 53
 Integration, 53
 Slide-in labels, 24
 Slot cover, 125
 Softkey, 103
 labeling, 103
 Softkey row, 103
 Software, 148
 Spare parts, 118
 Stainless steel front, 115
 Cleaning, 115
 Degree of protection, 31
 Installation information, 30
 Type of fixation, 31
 Stainless steel surface, 116
 Standard, 3
 Start screen, 66
 SIMATIC IPC Wizard, 66
 SIMATIC PC Wizard, 62
 Status display, 110
 Status displays,
 Strain relief
 Ethernet cable, 51
 PROFINET cable, 52
 Supply voltage,
 Switching on, 79
 Device, 79
 System partition, 149
 System resources, 215
 I/O address allocation, 216

T

- Temperature
 - Fan monitoring, 109
 - Monitoring, 108
- Temperature error, 173
- TFT technology, 20
- Third-party modules, 173
- Tools
 - Repairs, 138
- Touch controller, 63
- Touch panel, 105
 - Operating, 105
- Trademark, 4
- Transport, 13
- Troubleshooting/FAQs, 171
- Type of fixation, 31

- Windows XP
 - Installation, 150
 - Language selection, 95
- Wizard, 66

U

- Update, 159
- Updates
 - Operating system, 159
 - User programs and drives, 159
- USB,
- USB interface, 22
- USB peripheral, 67
- USB port, 43

V

- VGA port, 43

W

- Warranty, 12
- Watchdog
 - Monitoring function, 108
 - Monitoring times, 109
- WinAC module
 - Power supply connection, 212
- Windows 7
 - Installation, 152
 - Recovery, 154
- Windows 7 32-bit, 153
- Windows 7 64-bit, 153
- Windows Security Center, 60
- Windows Vista Ultimate
 - Language selection, 95