

Ultra-compact CompoBus/S Transistor I/O Terminal Blocks

- SRT2 models support both high-speed communications (750 kbps) and long-distance communications (500 m) systems, switch selected
- SRT1 models support only high-speed communications systems
- Two independent power supplies can be used because the I/O terminals are isolated from the internal circuits
- DIN track and screw mounting



Ordering Information

I/O points	Communications type	I/O classification	Internal I/O circuit common	Rated voltage	I/O rated voltage	Part number
4	High-speed	Input	NPN (+ common)	24 VDC	24 VDC	SRT1-ID04
			PNP (- common)			SRT1-ID04-1
		Output	NPN (- common)			SRT1-OD04
			PNP (+ common)			SRT1-OD04-1
	High-speed and long-distance	Input	NPN (+ common)			SRT2-ID04
			PNP (- common)			SRT2-ID04-1
		Output	NPN (- common)			SRT2-OD04
			PNP (+ common)			SRT2-OD04-1
8	High-speed	Input	NPN (+ common)	24 VDC	24 VDC	SRT1-ID08
			PNP (- common)			SRT1-ID08-1
		Output	NPN (- common)			SRT1-OD08
			PNP (+ common)			SRT1-OD08-1
	High-speed and long-distance	Input	NPN (+ common)			SRT2-ID08
			PNP (- common)			SRT2-ID08-1
		Output	NPN (- common)			SRT2-OD08
			PNP (+ common)			SRT2-OD08-1
16	High-speed	Input	NPN (+ common)	24 VDC	24 VDC	SRT1-ID16
			PNP (- common)			SRT1-ID16-1
		Output	NPN (- common)			SRT1-OD16
			PNP (+ common)			SRT1-OD16-1
	High-speed and long-distance	Input	NPN (+ common)			SRT2-ID16
			PNP (- common)			SRT2-ID16-1
		Output	NPN (- common)			SRT2-OD16
			PNP (+ common)			SRT2-OD16-1

Specifications

■ RATINGS

Inputs

Input current	6 mA max./point
ON delay time	1.5 ms max.
OFF delay time	1.5 ms max.
ON voltage	15 VDC min. between each input terminal and V
OFF voltage	5 VDC max. between each input terminal and V
OFF current	1 mA max.
Insulation method	Photocoupler
Input indicators	LED (yellow)

Outputs

Rated output current	0.3 A/point
Residual voltage	0.6 V max.
Leakage current	0.1 mA max.
Insulation method	Photocoupler
Output indicators	LED (yellow)

■ CHARACTERISTICS

Communications power supply voltage	14 to 26.4 VDC
I/O power supply voltage	24 VDC $+10\%$ / -15%
I/O power supply current	1 A max.
Current consumption (See Note)	50 mA max. at 24 VDC
Connection method	Multi-drop method and T-branch method Secondary branches cannot be connected to T-branch lines.
Connecting Units	4-point and 8-point Terminals: 16 Input Terminals and 16 Output Terminals per Master 16-point Terminals: 8 Input Terminals and 8 Output Terminals per Master
Dielectric strength	500 VAC for 1 minute (1 mA sensing current between insulated circuits)
Noise immunity	Power supply normal: ± 600 V for 10 minutes with a pulse width of 100 ns to 1 μ s Power supply common: $\pm 1,500$ V for 10 minutes with a pulse width of 100 ns to 1 μ s
Vibration resistance	10 to 55 Hz, 1.5-mm double amplitude
Shock resistance	Malfunction: 200 m/s ² Destruction: 300 m/s ²
Mounting strength	No damage when 50 N pull load was applied for 10 s in all directions
Terminal strength	No damage when 50 N pull load was applied for 10 s
Screw tightening torque	0.6 to 1.18 N • m
Ambient temperature	Operating: 0°C to 55°C (32°F to 131°F) with no icing or condensation Storage: -20°C to 65°C (-4°F to 149°F) with no icing or condensation
Ambient humidity	Operating: 35% to 85% RH
Weight	4-point and 8-point Terminals: 80 g max. 16-point Terminals: 110 g max.
Approved standards (4/8 points)	UL 508, CSA C22.2 No. 14

Note: The above current consumption is the value with all 4 and 8 and 16 points turned ON excluding the current consumption of the external sensor connected to the input Remote Terminal and the current consumption of the load connected to the output Remote Terminal.

Nomenclature

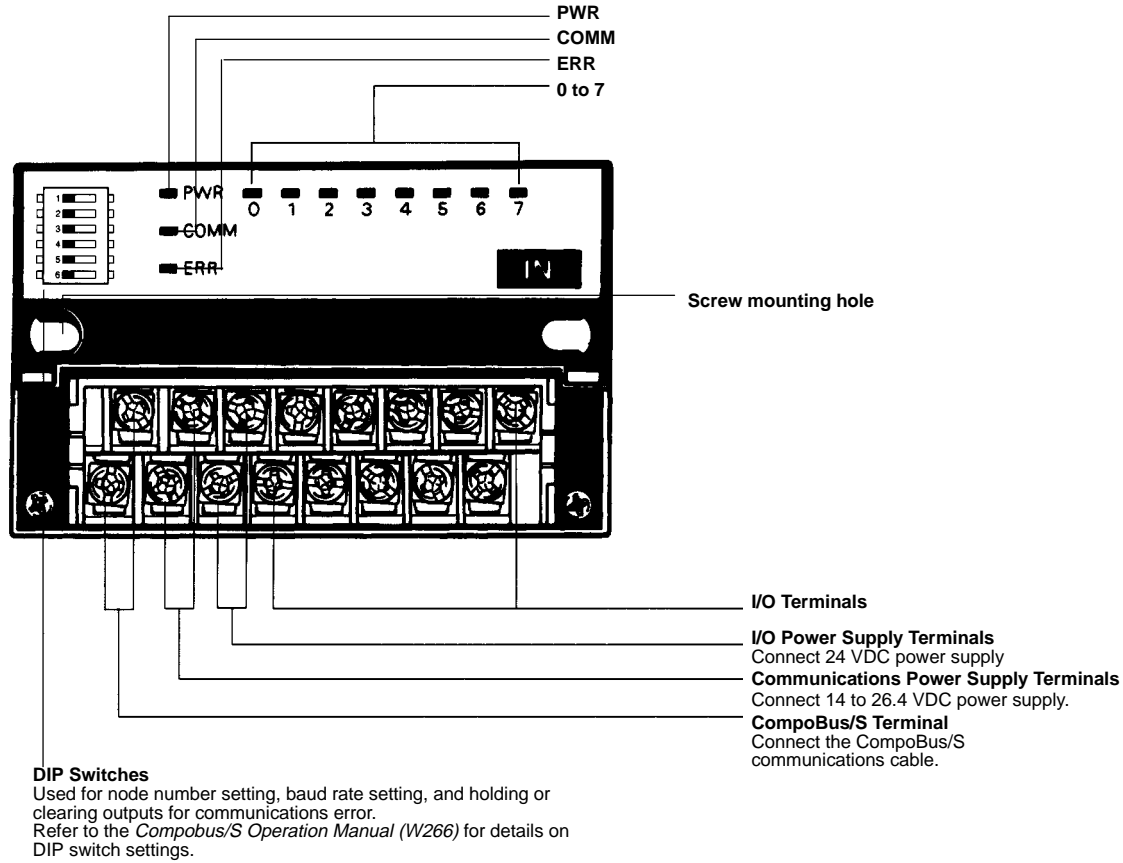

INDICATORS

Indicator	Display	Color	Meaning
PWR	Lit	Green	The communications power supply is ON.
	Not lit		The communications power supply is OFF.
COMM	Lit	Yellow	Normal communications
	Not lit		A communications error has occurred or the Unit is in standby status.
ERR	Lit	Red	A communications error has occurred.
	Not lit		Normal communications or the Unit is in standby status.
0 to 7	Lit	Yellow	The corresponding I/O signal is ON.
	Not lit		The corresponding I/O signal is OFF.

■ DIP SWITCH SETTINGS

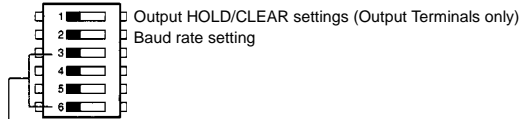

Node Number Settings

Output HOLD/CLEAR Mode

Mode	Pin 1	Setting
HOLD	ON	Output status is maintained.
CLEAR	OFF (default)	Output status is cleared when a communications error occurs.

Baud Rate Setting

Mode	Pin 2	Setting
Long distance	ON	Sets the I/O block to communicate in a long distance (500 m) CompoBus/S system.
High speed	OFF (default)	Sets the I/O block to communicate in a high speed (750 kbps) CompoBus/S system.

Note: SRT1 models will not operate properly if Pin 2 is set to "ON."

Node Number Settings

Node number	Pin 3	Pin 4	Pin 5	Pin 6
	8	4	2	1
0	OFF	OFF	OFF	OFF
1	OFF	OFF	OFF	ON
2	OFF	OFF	ON	OFF
3	OFF	OFF	ON	ON
4	OFF	ON	OFF	OFF
5	OFF	ON	OFF	ON
6	OFF	ON	ON	OFF
7	OFF	ON	ON	ON
8	ON	OFF	OFF	OFF
9	ON	OFF	OFF	ON
10	ON	OFF	ON	OFF
11	ON	OFF	ON	ON
12	ON	ON	OFF	OFF
13	ON	ON	OFF	ON
14	ON	ON	ON	OFF
15	ON	ON	ON	ON

Note: 1. The node number is factory-set to 0.

2. For node number settings, refer to the *CompoBus/S Operation Manual (W266)*.

Dimensions

Unit: mm (inch)

SRT1-ID04 (-1), SRT1-OD04 (-1)
 SRT2-ID04 (-1), SRT2-OD04 (-1)
 SRT1-ID08 (-1), SRT1-OD08 (-1)
 SRT2-ID08 (-1), SRT2-OD08 (-1)

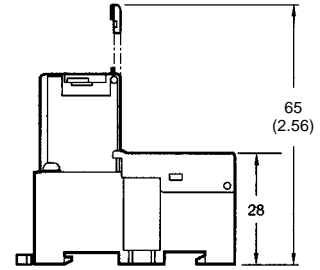
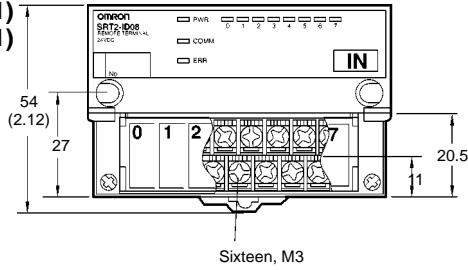
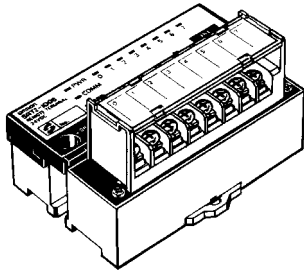

Mounting Holes

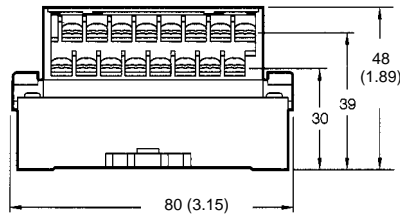
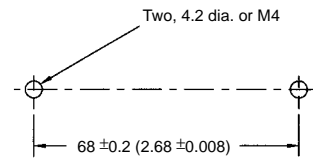

SRT1-ID16 (-1), SRT1-OD16 (-1)
 SRT2-ID16 (-1), SRT2-OD16 (-1)

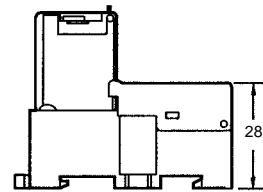
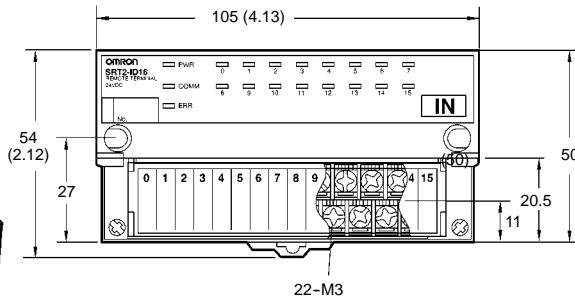
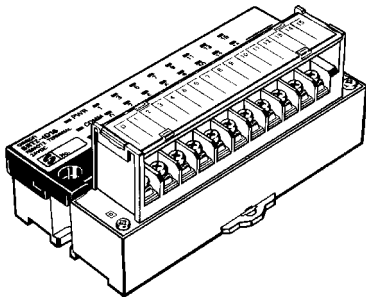

Mounting Holes

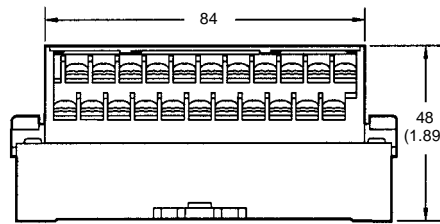
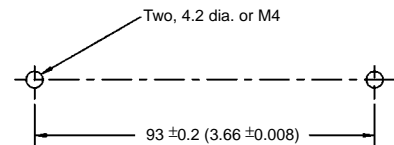

Installation

INTERNAL CIRCUIT CONFIGURATION

SRT1-ID04, SRT2-ID04

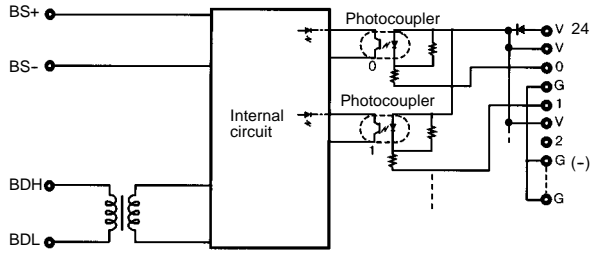

SRT1-ID04-1, SRT2-ID04-1

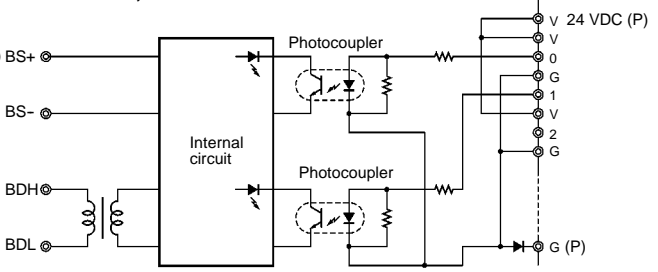

SRT1-OD04, SRT2-OD04

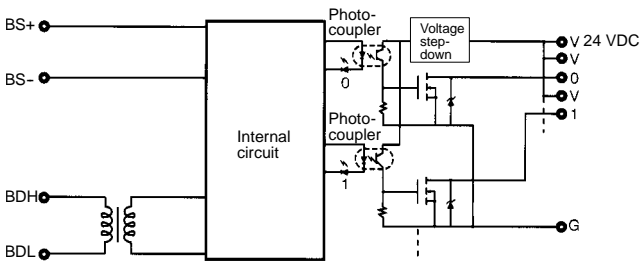

SRT1-OD04-1, SRT2-OD04-1

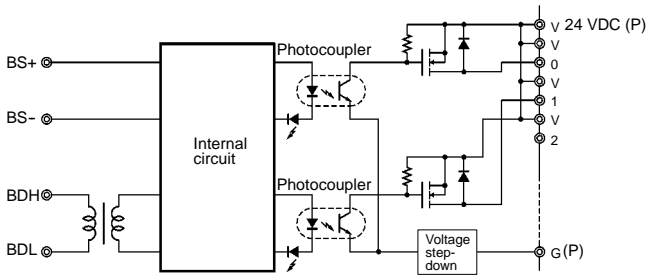

SRT1-ID08 ,SRT2-ID08

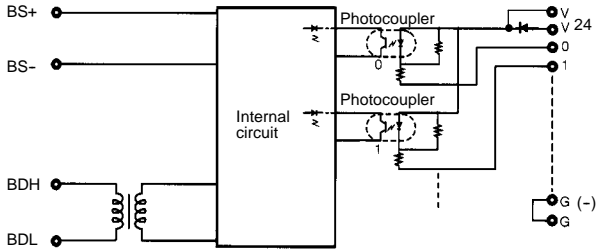

SRT1-ID08-1, SRT2-ID08-1

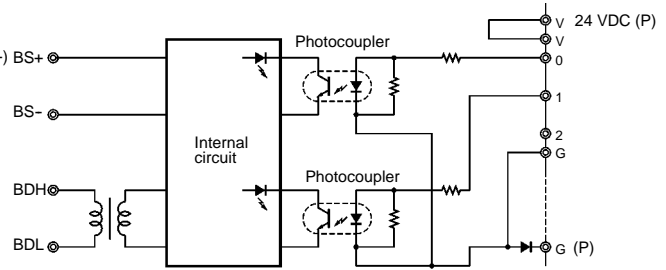

SRT1-OD08, SRT2-OD08

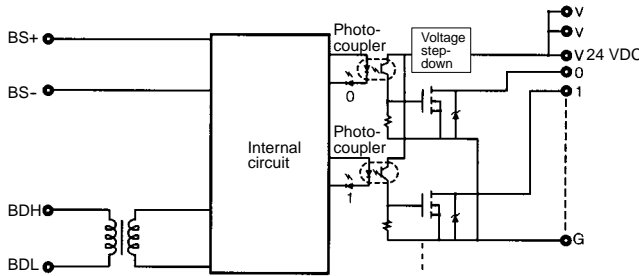

SRT1-OD08-1, SRT2-OD08-1

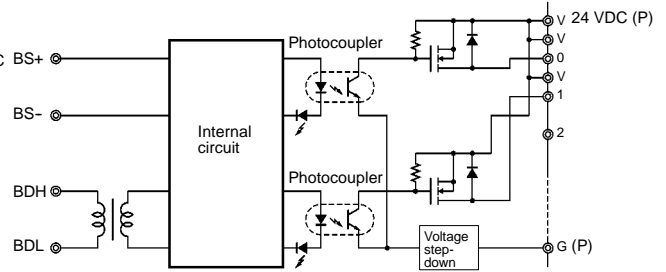

SRT1-ID16, SRT2-ID16

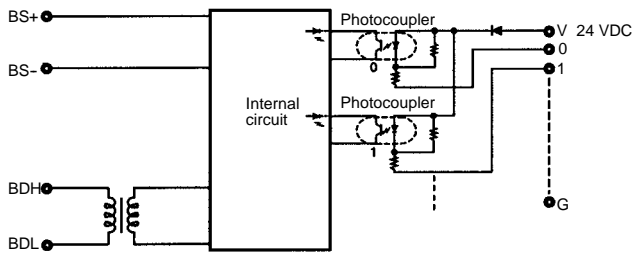

SRT1-ID16-1, SRT2-ID16-1

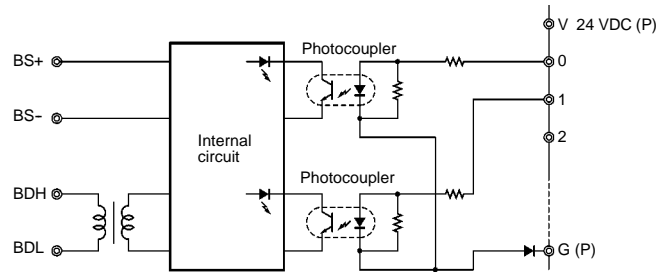

SRT1-OD16, SRT2-OD16

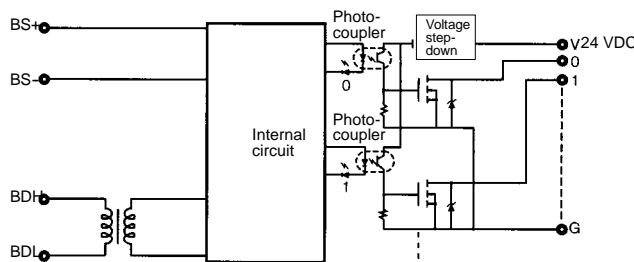

SRT1-OD16-1, SRT2-OD16-1

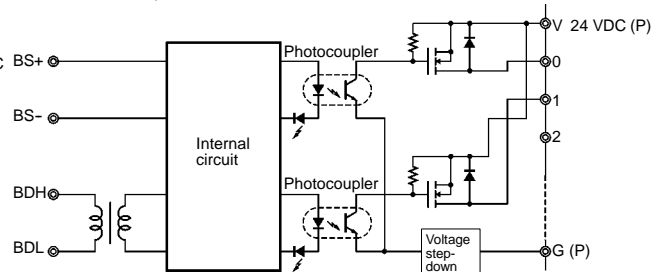

EXTERNAL CONNECTIONS (NPN MODELS)

Input

Three-wired Sensors

SRT1-ID04, SRT2-ID04 with NPN Output

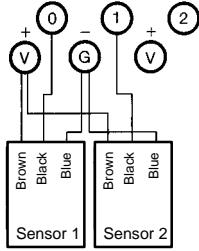

SRT1-ID08, SRT2-ID08, SRT1-ID16 and SRT2-ID16 with NPN Output

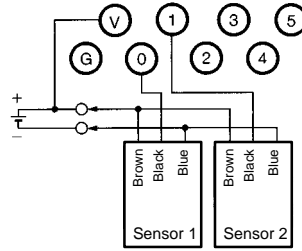

Two-wired Sensors

SRT1-ID04, SRT2-ID04

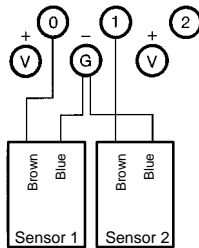

SRT1-ID08, SRT2-ID08, SRT1-ID16 and SRT2-ID16

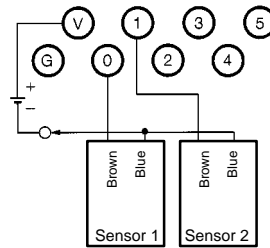

Output

SRT1-OD04, SRT2-OD04

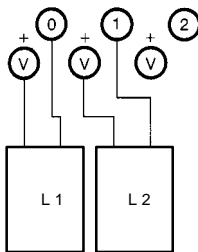

SRT1-OD08, SRT2-OD08, SRT1-OD16 and SRT2-OD16

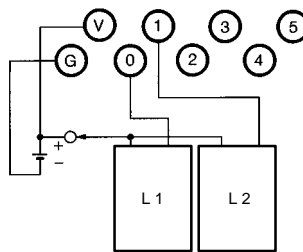

Output

SRT1-OD04-1, SRT2-OD04-1

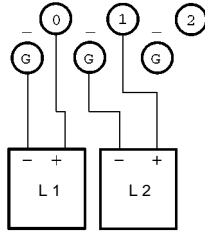

SRT1-OD08-1, SRT2-OD08-1, SRT1-ID16-1 and SRT2-ID16-1

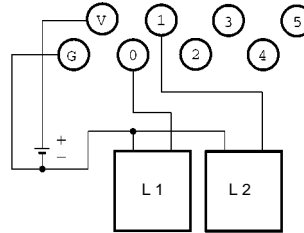

■ TERMINAL ARRANGEMENT AND I/O DEVICE CONNECTION EXAMPLE (PNP MODELS)

Note: The connections examples shown are for NPN models.

Input

SRT1-ID04-1, SRT2-ID04-1

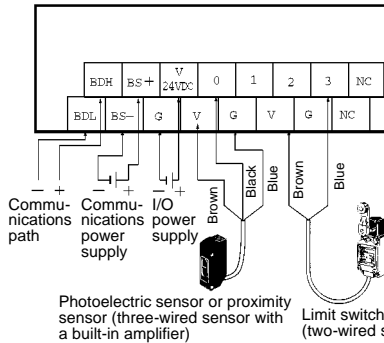

SRT1-ID08-1, SRT2-ID08-1

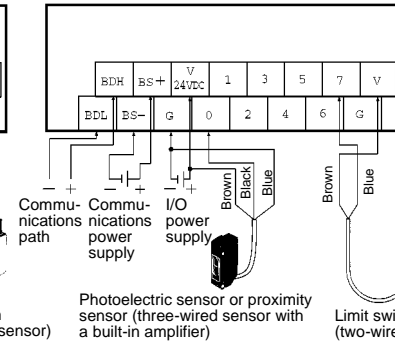

SRT1-ID16-1, SRT2-ID16-1

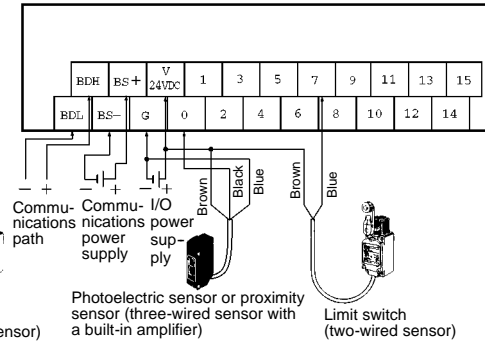

Output

SRT1-OD04-1, SRT2-OD04-1

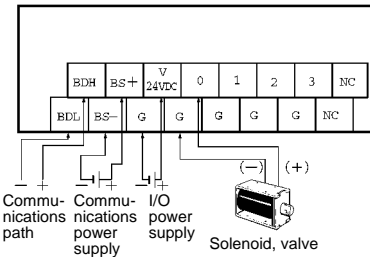

SRT1-OD08-1, SRT2-OD08-1

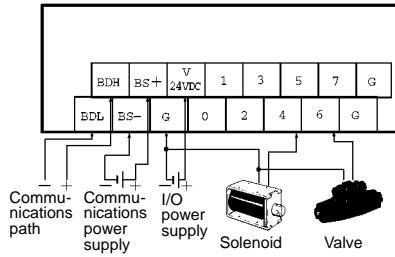

SRT1-OD16-1, SRT2-OD16-1

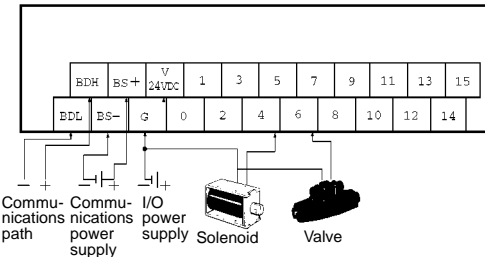

Precautions

Refer to the *CompoBus/S Operation Manual (W266)* before using the Unit.

NOTE: DIMENSIONS SHOWN ARE IN MILLIMETERS. To convert millimeters to inches divide by 25.4.



OMRON ELECTRONICS, INC.
One East Commerce Drive
Schaumburg, IL 60173
1-800-55-OMRON

OMRON CANADA, INC.
885 Milner Avenue
Scarborough, Ontario M1B 5V8
416-286-6465

Mouser Electronics

Authorized Distributor

Click to View Pricing, Inventory, Delivery & Lifecycle Information:

Omron:

[SRT2-ID04-1](#) [SRT2-ID08](#) [SRT2-ID16-1](#) [SRT2-OD08-1](#) [SRT2-OD16](#) [SRT2-ID04](#) [SRT2-OD16-1](#) [SRT2-OD04](#)