

SINAMICS S110 / S120

Synchronous motors 1FK7, Generation 2

Configuration Manual · 10/2011

SINAMICS

SIEMENS

SINAMICS S110 / S120

Synchronous motors 1FK7, Generation 2

Configuration Manual

Foreword

Description of the motors

1

Configuration

2

Mechanical properties of the
motors

3

Technical data and
characteristics

4

Motor components

5

Connection system

6

Information about using the
motors

7

Appendix

A

Legal information

Warning notice system

This manual contains notices you have to observe in order to ensure your personal safety, as well as to prevent damage to property. The notices referring to your personal safety are highlighted in the manual by a safety alert symbol, notices referring only to property damage have no safety alert symbol. These notices shown below are graded according to the degree of danger.

⚠ DANGER
indicates that death or severe personal injury will result if proper precautions are not taken.
⚠ WARNING
indicates that death or severe personal injury may result if proper precautions are not taken.
⚠ CAUTION
with a safety alert symbol, indicates that minor personal injury can result if proper precautions are not taken.
CAUTION
without a safety alert symbol, indicates that property damage can result if proper precautions are not taken.
NOTICE
indicates that an unintended result or situation can occur if the relevant information is not taken into account.

If more than one degree of danger is present, the warning notice representing the highest degree of danger will be used. A notice warning of injury to persons with a safety alert symbol may also include a warning relating to property damage.

Qualified Personnel

The product/system described in this documentation may be operated only by **personnel qualified** for the specific task in accordance with the relevant documentation, in particular its warning notices and safety instructions. Qualified personnel are those who, based on their training and experience, are capable of identifying risks and avoiding potential hazards when working with these products/systems.

Proper use of Siemens products

Note the following:

⚠ WARNING
Siemens products may only be used for the applications described in the catalog and in the relevant technical documentation. If products and components from other manufacturers are used, these must be recommended or approved by Siemens. Proper transport, storage, installation, assembly, commissioning, operation and maintenance are required to ensure that the products operate safely and without any problems. The permissible ambient conditions must be complied with. The information in the relevant documentation must be observed.

Trademarks

All names identified by © are registered trademarks of Siemens AG. The remaining trademarks in this publication may be trademarks whose use by third parties for their own purposes could violate the rights of the owner.

Disclaimer of Liability

We have reviewed the contents of this publication to ensure consistency with the hardware and software described. Since variance cannot be precluded entirely, we cannot guarantee full consistency. However, the information in this publication is reviewed regularly and any necessary corrections are included in subsequent editions.

Foreword

Motor documentation

The motor documentation is organized in the following categories:

- General documentation e.g. catalogs
- Manufacturer/service documentation e.g. Operating Instructions and Configuration Manuals

More information

Information on the following topics is available under the link:

- Ordering documentation/overview of documentation
- Additional links to download documents
- Using documentation online (find and search in manuals/information)

<http://www.siemens.com/motioncontrol/docu>

Please send any questions about the technical documentation (e.g. suggestions for improvement, corrections) to the following e-mail address:

docu.motioncontrol@siemens.com

My Documentation Manager

The following link provides information on how to create your own individual documentation based on Siemens content, and adapt it for your own machine documentation:

<http://www.siemens.com/mdm>

Training

The following link provides information on SITRAIN - training from Siemens for products, systems and automation engineering solutions:

<http://siemens.com/sitrain>

Internet addresses for drive technology

Internet address for motors: <http://www.siemens.com/motors>

Internet address for products: <http://www.siemens.com/motioncontrol>

Internet address for SINAMICS: <http://www.siemens.com/sinamics>

Target group

This documentation addresses project planners and project engineers as well as machine manufacturers and commissioning engineers.

Benefits

The Configuration Manual supports you when selecting motors, calculating the drive components, selecting the required accessories as well as when selecting line and motor-side power options.

Standard scope

The scope of the functionality described in this document can differ from the scope of the functionality of the drive that is actually supplied.

- Other functions not described in this documentation might be able to be executed in the drive. However, no claim can be made regarding the availability of these functions when the equipment is first supplied or in the event of servicing.
- The documentation can also contain descriptions of functions that are not available in a particular product version of the drive. The functionalities of the supplied drive should only be taken from the ordering documentation.
- Extensions or changes made by the machine manufacturer are documented by the machine manufacturer.

For reasons of clarity, this documentation does not contain all of the detailed information on all of the product types. This documentation cannot take into consideration every conceivable type of installation, operation and service/maintenance.

Technical Support

For technical support telephone numbers for different countries, go to:

<http://www.siemens.com/automation/service&support>

EC Declaration of Conformity

The EC Declaration of Conformity for the Low Voltage Directive can be found in the appendix to this documentation or on the Internet at: <http://support.automation.siemens.com>

There, as search term, enter the number **32732072** or contact your local Siemens office.

Danger and warning information

DANGER

Commissioning is absolutely prohibited until it has been completely ensured that the machine, in which the components described here are to be installed, is in full compliance with the provisions of the EC Machinery Directive.

Only appropriately qualified personnel may commission the SINAMICS units and the motors.

These personnel must carefully observe the technical customer documentation associated with this product and be have knowledge of and carefully observe the danger and warning notices.

Operational electrical equipment and motors have parts and components which are at hazardous voltage levels. All of the work carried out on the electrical machine or system must be carried out with it in a no-voltage condition.

When the machine or system is operated, hazardous axis movements can occur.

SINAMICS drive units with motors can only be connected to the line supply via residual-current operated circuit breakers if it has been verified (in accordance with EN 61800-5-1) that the units are compatible with the particular residual-current operated circuit breaker.

In combination with the drive system, the motors are generally approved for operation on TN and TT systems with **grounded neutral** and on IT systems.

In operation on IT systems, the occurrence of a first fault between an active part and ground must be signaled by a monitoring device. In accordance with IEC 60364-4-41, it is recommended that the first fault be eliminated as quickly as is practically possible.

In systems with a **grounded external conductor**, an isolating transformer with grounded neutral (secondary side) must be connected between the supply and the drive system to protect the motor insulation from excessive stress. The majority of TT systems have a grounded phase conductor, so in this case an isolating transformer must be used.

WARNING

The successful and safe operation of this equipment and motors is dependent on professional transport, storage, installation and mounting as well as careful operator control, service and maintenance.

For special versions of the drive units and motors, information and data in the catalogs and quotations additionally apply.

In addition to the danger and warning information/instructions in the technical customer documentation supplied, the applicable domestic, local and plant-specific regulations and requirements must be carefully taken into account.

 **CAUTION**

The motors can have surface temperatures of over +100 °C.

This is the reason that temperature-sensitive components, e.g. cables or electronic components may neither be in contact nor be attached to the motor.

When connecting up cables, please observe that they

- are not damaged
- are not subject to tensile stress
- cannot be touched by rotating components.

CAUTION

Motors should be connected in accordance with the operating instructions. They must not be connected directly to the three-phase supply because this will damage them.

SINAMICS units and motors are subjected to a voltage test during routine testing. It is not permitted to perform an additional high-voltage test on the motor; such a test can destroy electronic components such as the temperature sensor or encoder.

CAUTION

Motors with a DRIVE-CLiQ interface have an electronic rating plate containing motor and encoder-specific data. For this reason, encoder modules with a DRIVE-CLiQ interface or mounted Sensor Modules may only be operated on the original motor - and may not be mounted onto other motors or replaced by Sensor Modules from other motors.

The DRIVE-CLiQ interface has direct contact to components that can be damaged/destroyed by electrostatic discharge (ESDS). Neither hands nor tools that could be electrostatically charged should come into contact with the connections.

Note

When operational and in dry operating rooms, SINAMICS units with motors fulfill the Low-Voltage Directive.

In the configurations specified in the associated EC Declaration of Conformity, SINAMICS units with motors fulfill the EMC Directive.

ESDS instructions and electromagnetic fields

CAUTION

An electrostatic-sensitive device (ESDS) is an individual component, integrated circuit, or module that can be damaged by electrostatic fields or discharges.

ESDS regulations for handling boards and equipment:

When handling components that can be destroyed by electrostatic discharge, it must be ensured that personnel, the workstation and packaging are well grounded!

Personnel in ESD zones with conductive floors may only touch electronic components if they are

- grounded through an ESDS bracelet and
- wearing ESDS shoes or ESDS shoe grounding strips.

Electronic boards may only be touched when absolutely necessary.

Electronic boards may not be brought into contact with plastics and articles of clothing manufactured from man-made fibers.

Electronic boards may only be placed on conductive surfaces (table with ESDS surface, conductive ESDS foam rubber, ESDS packing bag, ESDS transport containers).

Electronic boards may not be brought close to data terminals, monitors or television sets. Minimum clearance to screens > 10 cm).

Measurements may only be carried-out on electronic boards and modules if

- the measuring instrument is grounded (e.g. via a protective conductor) or
- before making measurements with a potential-free measuring device, the measuring head is briefly discharged

(e.g. by touching an unpainted blank piece of metal on the control cabinet).

DANGER

It may be dangerous for people to remain in the immediate proximity of the product – especially for those with pacemakers, implants or similar – due to electric, magnetic and electromagnetic fields (EMF) occurring as a consequence of operation.

The machine/system operator and the people present near the product must observe the relevant guidelines and standards! These are, for example, in the European Economic Area (EEA) the Electromagnetic Fields Directive 2004/40/EC and the standards EN 12198-1 to 12198-3 and in the Federal Republic of Germany the Employer's Liability Insurance Association Regulations for the Prevention of Industrial Accidents BGV 11, with the relevant rule BGR 11 "Electromagnetic Fields".

Then a risk assessment must be carried out for every workplace, activities for reducing dangers and exposure for people decided upon and implemented, as well as determining and observing exposure and danger areas.

Information regarding third-party products

NOTICE
<p>This document contains recommendations relating to third-party products. This involves third-party products whose fundamental suitability is familiar to us. It goes without saying that equivalent products from other manufacturers may be used. Our recommendations are to be seen as helpful information, not as requirements or regulations. We cannot accept any liability for the quality and properties/features of third-party products.</p>

Environmental compatibility

- Environmental aspects during development

When selecting supplier parts, environmental compatibility was an essential criteria.

Special emphasis was placed on reducing the envelope dimensions, mass and type variety of metal and plastic parts.

Effects of paint-wetting impairment substances can be excluded (PWIS test)

- Environmental aspects during production

Supplier parts and the products are predominantly transported in re-usable packing. Transport for hazardous materials is not required.

The packing materials themselves essentially comprises paperboard containers that are in compliance with the Packaging Directive 94/62/EC.

Energy consumption during production was optimized.

Production has low emission levels.

- Environmental aspects for disposal

Motors must be disposed of carefully taking into account domestic and local regulations in the normal recycling process or by returning to the manufacturer.

The following must be taken into account when disposing of the motor:

Oil according to the regulations for disposing of old oil (e.g. gear oil when a gearbox is mounted)

Not mixed with solvents, cold cleaning agents or remains of paint

Components that are to be recycled should be separated according to:

- Electronics scrap (e.g. encoder electronics, sensor modules)
- Iron to be recycled
- Aluminum
- Non-ferrous metal (gearwheels, motor windings)

Residual risks of power drive systems

When carrying out a risk assessment of the machine in accordance with the EU Machinery Directive, the machine manufacturer must consider the following residual risks associated with the control and drive components of a power drive system (PDS).

1. Unintentional movements of driven machine components during commissioning, operation, maintenance, and repairs caused by, for example:
 - Hardware defects and/or software errors in the sensors, controllers, actuators, and connection technology
 - Response times of the controller and drive
 - Operating and/or ambient conditions not within the scope of the specification
 - Parameterization, programming, cabling, and installation errors
 - Use of radio devices / cellular phones in the immediate vicinity of the controller
 - External influences / damage
2. Exceptional temperatures as well as emissions of light, noise, particles, or gas caused by, for example:
 - Component malfunctions
 - Software errors
 - Operating and/or ambient conditions not within the scope of the specification
 - External influences / damage
3. Hazardous shock voltages caused by, for example:
 - Component malfunctions
 - Influence of electrostatic charging
 - Induction of voltages in moving motors
 - Operating and/or ambient conditions not within the scope of the specification
 - Condensation / conductive contamination
 - External influences / damage
4. Electrical, magnetic and electromagnetic fields generated in operation that can pose a risk to people with a pacemaker, implants or metal replacement joints, etc. if they are too close.
5. Release of environmental pollutants or emissions as a result of improper operation of the system and/or failure to dispose of components safely and correctly.

More extensive information concerning the residual risks associated with the PDS is provided in the relevant chapters of the technical user documentation.

Table of contents

	Foreword	3
1	Description of the motors	15
1.1	Features	15
1.2	Torque overview	17
1.3	Technical features.....	18
1.4	Selection and ordering data, 1FK7 for DC link voltages 510 V to 720 V DC (line supply 380 V - 480 V 3 AC).....	20
1.4.1	1FK701/1FK702 Compact	20
1.4.2	1FK703 - 1FK710 Compact	21
1.4.3	1FK7 High Dynamic/1FK7 High Inertia.....	23
1.5	Selection and ordering data, 1FK7 for DC link voltages 270 V to 330 V DC (line supply 200 V - 240 V 1 AC).....	24
1.5.1	1FK701/1FK702 Compact	24
1.5.2	1FK703/1FK704 Compact and 1FK703/1FK704 High Dynamic	25
1.6	Rating plate data	26
1.7	Motor overview/Assignment of Motor Module.....	27
2	Configuration	35
2.1	Configuring software	35
2.1.1	Configuration tool SIZER for SIEMENS Drives	35
2.1.2	STARTER drive/commissioning software.....	37
2.1.3	SinuCom commissioning tool.....	38
2.2	Configuring procedure	38
2.2.1	1. Clarification of the type of drive	39
2.2.2	2. Defining the supplementary conditions and integration into an automation system.....	40
2.2.3	3. Definition of the load, calculation of max. load torque and definition of the motor	40
3	Mechanical properties of the motors	47
3.1	Cooling	47
3.2	Degree of protection	47
3.3	Bearing version	50
3.4	Radial and axial forces.....	50
3.4.1	Calculating the belt pre-tension	50
3.4.2	Radial force loading	51
3.4.3	Radial force diagrams.....	51
3.4.4	Axial force stressing.....	55
3.5	Smooth running, concentricity and axial eccentricity.....	56
3.6	Shaft end.....	58
3.7	Balancing	58

3.8	Vibration severity grade	58
3.9	Noise emission	59
3.10	Paint finish.....	59
4	Technical data and characteristics.....	61
4.1	Operating range and characteristics	61
4.2	Torque-speed characteristic.....	70
4.2.1	1FK7 motors connected to SINAMICS S110 / S120 with a line voltage of 3-ph. 380 V to 480 V AC	70
4.2.1.1	1FK7 Compact	70
4.2.1.2	1FK7 High Dynamic	142
4.2.1.3	1FK7 High Inertia	170
4.2.2	1FK7 motors on SINAMICS S110 / S120 POWER MODULE with a line voltage of 1-ph. 200 V to 240 V AC	182
4.2.2.1	1FK7 Compact and 1FK7 High Dynamic	182
4.3	Dimension drawings	198
4.3.1	1FK7 motors.....	200
5	Motor components	209
5.1	Thermal motor protection	209
5.2	Encoder (option).....	210
5.2.1	Encoder selection.....	210
5.2.2	Encoder connection for motors with a DRIVE-CLiQ interface	212
5.2.3	Encoder connection for motors without DRIVE-CLiQ interface	212
5.2.4	Incremental encoders.....	212
5.2.5	Absolute value encoder.....	214
5.2.6	Resolver	216
5.3	Holding brake (option).....	218
5.3.1	Properties	218
5.3.2	Permanent-magnet brake	218
5.3.3	Motor-side connection of the holding brake	219
5.3.4	Protective circuitry for the brake	219
5.3.5	Technical data of the holding brake	220
5.4	Brake resistances (armature short-circuit braking)	222
5.4.1	Dimensioning of braking resistors	224
5.5	Gearbox.....	228
5.5.1	Dimensioning the gearbox	228
5.5.2	Motors with planetary gears	231
5.5.2.1	Characteristics of SP+ series	231
5.5.2.2	Selection and ordering data, series SP+	233
5.5.2.3	Characteristics of the LP+ series	238
5.5.2.4	Selection and ordering data, series LP+	240
5.6	Drive coupling	241
6	Connection system	243
6.1	SINAMICS drive I/O	243
6.2	Power connection.....	244

6.3	Signal connection.....	246
6.4	Quick-release lock	251
6.5	Rotating the connector at the motor	251
7	Information about using the motors	255
7.1	Transport / storage before use.....	255
7.2	Environmental conditions.....	255
7.3	Routing cables in a damp environment	256
7.4	Types of construction.....	257
7.5	Mounting conditions	258
7.6	Vibratory load.....	259
7.7	Permissible line system configurations.....	260
A	Appendix.....	261
A.1	Description of terms	261
A.2	Declaration of conformity	266
	Index.....	267

Description of the motors

1.1 Features

Overview

1FK7 motors are compact permanent-magnet synchronous motors. The available options, gear units and encoders, together with the expanded product range, mean that the 1FK7 motors can be optimally adapted to any application. They therefore also satisfy the permanently increasing demands of state-of-the-art machine generations.

1FK7 motors can be combined with the SINAMICS S110 / S120 drive system to create a powerful system with high functionality. The integrated encoder systems for speed and position control can be selected depending on the application.

The motors are designed for operation without external cooling and the heat is dissipated through the motor surface. 1FK7 motors have a high overload capability.



Figure 1-1 1FK7 motors

1.1 Features

Benefits

1FK7 Compact motors offer:

- Space-saving installation thanks to extremely high power/weight ratio
- Can be universally used for many applications
- Wide range of motors

1FK7 High Dynamic motors offer:

- Extremely high dynamic response thanks to low rotor moment of inertia

1FK7 High Inertia motors offer:

- Rugged closed-loop control properties for high or variable load moments of inertia
- Low optimization and commissioning overhead to compensate disturbances

Area of application

- Machine tools
- Robots and handling systems
- Wood, glass, ceramics and stone working
- Packaging, plastics and textile machines
- Auxiliary axes

1.2 Torque overview

1FK7 Compact

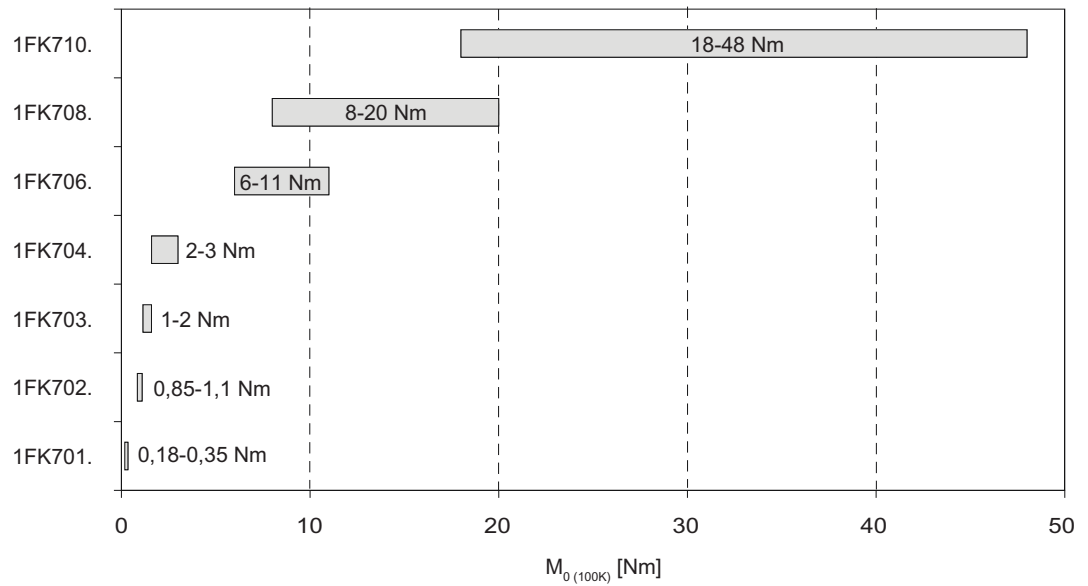

Figure 1-2 Static torques 1FK7 Compact

1FK7 High Dynamic

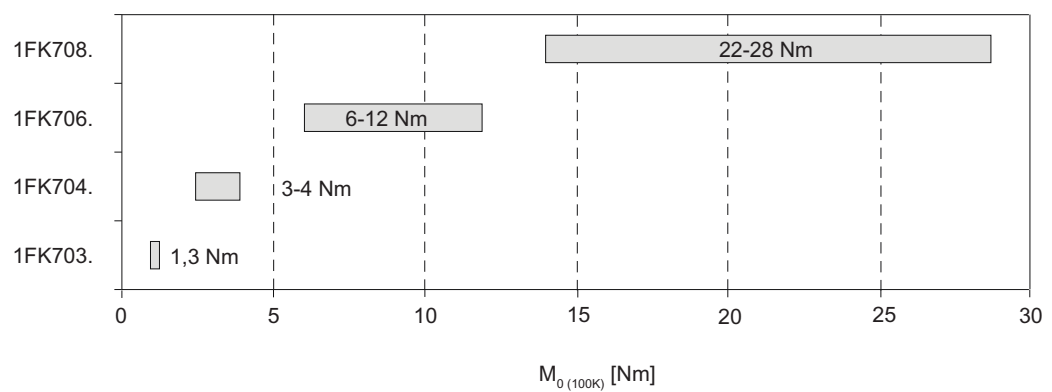

Figure 1-3 Static torques 1FK7 High Dynamic

1FK7 High Inertia

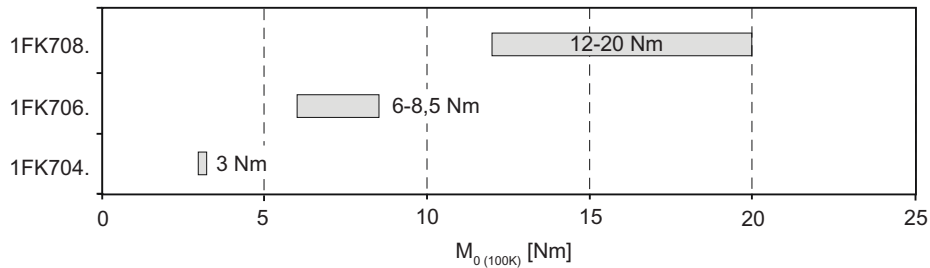

Figure 1-4 Static torques 1FK7 High Inertia

1.3 Technical features

Table 1- 1 Technical features

Type of motor	Permanent-magnet synchronous motor
Magnet material	Rare-earth magnetic material
Cooling	Natural cooling
Insulation of the stator winding according to EN 60034-1 (IEC 60034-1)	Temperature class 155 (F) for a winding temperature of $\Delta T = 100$ K at an ambient temperature of $+40^\circ$ C
Installation altitude (in accordance with EN 60034-1 and IEC 60034-1)	≤ 1000 m above sea level, otherwise power derating
Type of construction in accordance with EN 60034-7 (IEC 60034-7)	IM B5 (IM V1, IM V3)
Degree of protection in accordance with EN 60034-5 (IEC 60034-5) ¹⁾	IP64; optional IP65 or IP65 + IP67 at the shaft gland
Temperature monitoring	KTY 84 temperature sensor in the stator winding
Paint finish	Anthracite (RAL 7016)
Drive shaft end acc. to DIN 748-3 (IEC 60072-1)	Plain shaft, optional shaft with fitted key and keyway (half-key balancing)
Radial eccentricity, concentricity and axial eccentricity acc. to DIN 42955 (IEC 60072-1) ²⁾	Tolerance N (normal)
Vibration severity grade according to EN 60034-14 (IEC 60034-14)	Grade A is maintained up to rated speed
Sound pressure level L_{pA} (1 m) in accordance with DIN EN ISO 1680, max. tolerance + 3 dB(A)	<ul style="list-style-type: none"> • 1FK701□ to 1FK704□: 55 dB(A) • 1FK706□: 65 dB(A) • 1FK708□ to 1FK710□: 70 dB(A)

Built-in encoder systems for motors without DRIVE-CLiQ interface	<ul style="list-style-type: none"> • IC2048S/R incremental encoder, sin/cos 1 Vpp, 2048 S/R³⁾ with C and D tracks for SH 20 to SH 100 • AM2048S/R absolute encoder 2048 S/R³⁾, 4096 revolutions Multiturn, with EnDat interface for SH 36 to SH 100 • AM512S/R absolute encoder 512 S/R³⁾, 4096 revolutions Multiturn, with EnDat interface, for SH 28 • AM16S/R absolute encoder 16 S/R³⁾, 4096 revolutions Multiturn, with EnDat interface, for SH 20 and SH 28 • Resolver, multipole (number of pole pairs corresponds to number of pole pairs of the motor) • 2-pole resolver
Integrated encoder systems for motors with DRIVE-CLiQ interface	<ul style="list-style-type: none"> • AS24DQI absolute encoder single-turn 24 bit , for SH 36 to SH 100 • AM24DQI absolute encoder 24 bit + 12 bit multiturn, for SH 36 to SH 100 • AS20DQI absolute encoder single-turn 20 bit, for SH 36 to SH 100 • AM20DQI absolute encoder 20 bit + 12 bit multiturn, for SH 36 to SH 100 • IC22DQ incremental encoder, 22-bit + commutation position, 11 bit, for SH 28 • AM20DQ absolute encoder 20 bit + 12 bit multiturn, for SH 28 • AM15DQ absolute encoder 15 bit + 12 bit multiturn, for SH 28 • R15DQ resolver 15 bit, not for SH 20 • R14DQ resolver 14 bit, not for SH 20
Connection	Connectors for signals and power, can be rotated
Holding brake	Optional integrated holding brake (free of backlash, 24 V)

1) 1FK701 only available in degree of protection IP54 with paint finish, planetary gearbox not possible

2) Radial eccentricity of the shaft extension, concentricity of centering edge and axial eccentricity of the mounting flange to the axis of the shaft extension.

3) P/R = Pulses/Revolution

1.4 Selection and ordering data, 1FK7 for DC link voltages 510 V to 720 V DC (line supply 380 V - 480 V 3 AC)

1.4.1 1FK701/1FK702 Compact

Rated speed n_N rpm	Shaft height SH	Rated power at $\Delta T=100$ K P_N kW	Static torque at $\Delta T=100$ K M_0 Nm	Rated torque at $\Delta T=100$ K M_N Nm	Rated current at $\Delta T=100$ K I_N A	Synchronous motor 1FK7 Compact Order No.	Number of pole pairs	Moment of rotor inertia (without brake) J kgcm ²	Weight (motor without brake) m kg	Efficiency ¹⁾ η %	Static current at $\Delta T=100$ K I_0 A	Calculated power $P_{calc} = M_0 \times n_N / 9550$ P_{calc} kW	Power connector size	Cable cross-section ²⁾ mm ²
1FK7 Compact for DC-Link 510 V to 720 V (line voltage 380-480 V 3 AC)														
6000	20	0.05	0.18	0.08	0.85	1FK7011-5AK71-1□□□	4	0.064	0.9	62	1.5	0.1	0.5	4x1.5
	28	0.1	0.35	0.16	0.85	1FK7015-5AK71-1□□□	4	0.083	1.1	68	1.5	0.2	0.5	4x1.5
		0.38	0.85	0.6	1.4	1FK7022-5AK71-1□□□	3	0.28	1.8	86	1.8	0.5	1	4x1.5

Encoder systems for motors without DRIVE-CLiQ interface:

1FK7...-...-...-A	Incremental encoder sin/cos 1 Vpp 2048 S/R	IC2048S/R
1FK7...-...-...-H	Absolute encoder EnDat 514 S/R (1FK702 only)	AM512S/R
1FK7...-...-...-J	Absolute encoder EnDat 16 S/R	AM16S/R
1FK7...-...-...-S	Resolver multipole	Resolver p=x
1FK7...-...-...-T	Resolver 2-pole	Resolver p=1

Encoder systems for motors with DRIVE-CLiQ interface: (1FK702 only)

1FK7...-...-...-D	Incremental encoder 22 bit	IC22DQ
1FK7...-...-...-L	Absolute encoder 20 bit + 12 bit	AM20DQ
1FK7...-...-...-V	Incremental encoder 22 bit	IC22DQ
1FK7...-...-...-U	Resolver 15 bit multipole	R15DQ
1FK7...-...-...-P	Resolver 14 bit 2-pole	R14DQ

	Brake:	Shaft:
1FK7...-...-...-A	without	Fitted key and keyway
1FK7...-...-...-B	with	Fitted key and keyway
1FK7...-...-...-G	without	Plain shaft
1FK7...-...-...-H	with	Plain shaft

	Degree of protection:	Coating:
1FK7...-...-...-0	IP64 (1FK702 only)	without paint finish
1FK7...-...-...-2	IP65 and DE-Flange IP67 (1FK702 only)	without paint finish
1FK7...-...-...-3	IP54 for 1FK701 / IP64 for 1FK702	with paint finish
1FK7...-...-...-5	IP65 and DE-Flange IP67 (1FK702 only)	with paint finish

¹⁾ Optimum efficiency at continuous load

²⁾ The current carrying capacity of the power cables complies with IEC 60204-1 for installation type C under continuous operating conditions at an ambient air temperature of 40 °C (104 °F), designed for IO (100 K), PVC/PUR-insulated cable.

1.4 Selection and ordering data, 1FK7 for DC link voltages 510 V to 720 V DC (line supply 380 V - 480 V 3 AC)

1.4.2 1FK703 - 1FK710 Compact

Rated speed n_N rpm	Shaft height SH	Rated power at $\Delta T=100$ K P_N kW	Static torque at $\Delta T=100$ K M_0 Nm	Rated torque at $\Delta T=100$ K M_N Nm	Rated current at $\Delta T=100$ K I_N A	Synchronous motor 1FK7 Compact Order No.	Number of pole pairs J	Moment of rotor inertia (without brake) m	Weight (motor without brake) η	Efficiency ¹⁾ η %	Static current at $\Delta T=100$ K I_0 A	Calculated power $P_{calc} = M_0 \times n_N / 9550$ kW	Power connector size	Cable cross-section ²⁾ mm ²
1FK7 Compact for DC-Link 510 V to 720 V (line voltage 380-480 V 3 AC)														
2000	48	0.6	3.0	2.8	1.55	1FK7042-2AC71-1□□□	4	2.9	4.6	88	1.6	0.6	1	4x1.5
	63	1.1	6.0	5.3	2.95	1FK7060-2AC71-1□□□	4	7.7	7.1	90	3.15	1.3	1	4x1.5
		1.5	8.5	7.0	2.65	1FK7062-2AC71-1□□□	4	11.2	9.1	90	3.0	1.8	1	4x1.5
		1.9	11.0	8.9	4.4	1FK7063-2AC71-1□□□	4	14.7	11.1	91	5.3	2.3	1	4x1.5
	80	2.1	12.0	10.0	4.4	1FK7081-2AC71-1□□□	4	20	12.9	93	5.0	2.5	1	4x1.5
		2.6	16.0	12.5	6.3	1FK7083-2AC71-1□□□	4	26	15.6	93	7.5	3.4	1	4x1.5
		3.1	20.0	15.0	6.7	1FK7084-2AC71-1□□□	4	32.5	18.3	93	8.5	4.2	1	4x1.5
	100	3	18.0	14.5	7.1	1FK7100-2AC71-1□□□	4	54	17.6	92	8.4	3.8	1	4x1.5
		4.3	27.0	20.5	9.7	1FK7101-2AC71-1□□□	4	79	23.0	93	12.3	5.7	1.5	4x1.5
		5.2	36.0	25.0	11.0	1FK7103-2AC71-1□□□	4	104	28.5	93	14.4	7.5	1.5	4x1.5
		7.7	48.0	37.0	16.0	1FK7105-2AC71-1□□□	4	154	39.0	93	20.0	10.1	1.5	4x2.5
	3000	48	0.8	3.0	2.6	2.0	1FK7042-2AF71-1□□□	4	2.9	4.6	89	2.2	0.9	1
63		1.5	6.0	4.7	3.7	1FK7060-2AF71-1□□□	4	7.7	7.1	90	4.45	1.9	1	4x1.5
		1.9	8.5	6.0	4.0	1FK7062-2AF71-1□□□	4	11.2	9.1	91	5.3	2.7	1	4x1.5
		2.3	11.0	7.3	5.6	1FK7063-2AF71-1□□□	4	14.7	11.1	91	8.0	3.5	1	4x1.5
80		2.1	8.0	6.8	4.4	1FK7080-2AF71-1□□□	4	14.2	10.3	92	4.9	2.5	1	4x1.5
		2.7	12.0	8.7	6.8	1FK7081-2AF71-1□□□	4	20	12.9	93	8.7	3.8	1	4x1.5
		3.3	16.0	10.5	7.2	1FK7083-2AF71-1□□□	4	26	15.6	93	10.1	5	1	4x1.5
100		3.1	20.0	10.0	6.5	1FK7084-2AF71-1□□□	4	32.5	18.3	93	12.1	6.3	1	4x1.5
		3.8	18.0	12.0	8.0	1FK7100-2AF71-1□□□	4	54	17.6	92	11.1	5.7	1	4x1.5
		4.9	27.0	15.5	11.6	1FK7101-2AF71-1□□□	4	79	23.0	93	18.8	8.5	1.5	4x2.5
		4.4	36.0	14.0	11.5	1FK7103-2AF71-1□□□	4	104	28.5	93	26.0	11.3	1.5	4x4
8.2		48.0	26.0	18.0	1FK7105-2AF71-1□□□	4	154	39.0	94	31.0	15.1	1.5	4x6	

Encoder systems for motors without DRIVE-CLiQ interface:

1FK7.....-A	Incremental encoder sin/cos 1 Vpp 2048 S/R	IC2048S/R
1FK7.....-E	Absolute encoder EnDat 2048 S/R	AM2048S/R
1FK7.....-S	Resolver multipole	Resolver p=x
1FK7.....-T	Resolver 2-pole	Resolver p=1

Encoder systems for motors with DRIVE-CLiQ interface:

1FK7.....-B	Absolute encoder singleturn 24 bit	AS24DQI
1FK7.....-C	Absolute encoder 24 bit + 12 bit multiturn	AM24DQI
1FK7.....-Q	Absolute encoder singleturn 20 bit	AS20DQI
1FK7.....-R	Absolute encoder 20 bit + 12 bit multiturn	AM20DQI
1FK7.....-U	Resolver 15 bit, multipole	R15DQ
1FK7.....-P	Resolver 14 bit, 2-pole	R14DQ

	Brake:	Shaft:
1FK7.....-A	without	Fitted key and keyway
1FK7.....-B	with	Fitted key and keyway
1FK7.....-G	without	Plain shaft
1FK7.....-H	with	Plain shaft

Degree of protection:

1FK7.....-0	IP64
1FK7.....-1	IP65
1FK7.....-2	IP65 and DE-Flange IP67

¹⁾ Optimum efficiency at continuous load

²⁾ The current carrying capacity of the power cables complies with IEC 60204-1 for installation type C under continuous operating conditions at an ambient air temperature of 40 °C (104 °F), designed for I0 (100 K), PVC/PUR-insulated cable.

Description of the motors

1.4 Selection and ordering data, 1FK7 for DC link voltages 510 V to 720 V DC (line supply 380 V - 480 V 3 AC)

Rated speed n_N rpm	Shaft height SH	Rated power at $\Delta T=100$ K P_N kW	Static torque at $\Delta T=100$ K M_0 Nm	Rated torque at $\Delta T=100$ K M_N Nm	Rated current at $\Delta T=100$ K I_N A	Synchronous motor 1FK7 Compact Order No.	Number of pole pairs	Moment of rotor inertia (without brake) J	Weight (motor without brake) m	Efficiency ¹⁾ η %	Static current at $\Delta T=100$ K I_0 A	Calculated power $P_{calc} = M_0 \times n_N / 9550$ kW	Power connector size	Cable cross-section ²⁾ mm ²
1FK7 Compact for DC-Link 510 V to 720 V (line voltage 380-480 V 3 AC)														
4500	63	1.7	6.0	3.7	4.3	1FK7060-2AH71-1□□□	4	7.7	7.1	90	6.3	2.8	1	4x1.5
		1.4	8.5	3.0	3.3	1FK7062-2AH71-1□□□	4	11.2	9.1	91	8.0	4	1	4x1.5
		1.4	11.0	3.0	3.8	1FK7063-2AH71-1□□□	4	14.7	11.1	90	12.0	5.2	1	4x1.5
	80	2.1	8.0	4.5	4.8	1FK7080-2AH71-1□□□	4	14.2	10.3	92	7.4	3.8	1	4x1.5
		1.8	12.0	3.8	4.9	1FK7081-2AH71-1□□□	4	20	12.9	93	13.1	5.7	1	4x1.5
		1.4	16.0	3.0	3.6	1FK7083-2AH71-1□□□	4	26	15.6	93	15.0	7.5	1	4x1.5
6000	36	0.5	1.15	0.8	1.3	1FK7032-2AK71-1□□□	3	0.65	2.7	88	1.7	0.7	1	4x1.5
		0.6	1.6	1.0	1.3	1FK7034-2AK71-1□□□	3	0.9	3.5	88	1.9	1	1	4x1.5
	48	0.7	1.6	1.1	1.85	1FK7040-2AK71-1□□□	4	1.6	3.2	88	2.35	1	1	4x1.5
		0.9	3.0	1.5	2.5	1FK7042-2AK71-1□□□	4	2.9	4.6	89	4.4	1.9	1	4x1.5

Encoder systems for motors without DRIVE-CLiQ interface:

1FK7.....-A	Incremental encoder sin/cos 1 Vpp 2048 S/R	IC2048S/R
1FK7.....-E	Absolute encoder EnDat 2048 S/R	AM2048S/R
1FK7.....-S	Resolver multipole	Resolver p=x
1FK7.....-T	Resolver 2-pole	Resolver p=1

Encoder systems for motors with DRIVE-CLiQ interface:

1FK7.....-B	Absolute encoder singleturn 24 bit	AS24DQI
1FK7.....-C	Absolute encoder 24 bit + 12 bit multiturn	AM24DQI
1FK7.....-Q	Absolute encoder singleturn 20 bit	AS20DQI
1FK7.....-R	Absolute encoder 20 bit + 12 bit multiturn	AM20DQI
1FK7.....-U	Resolver 15 bit, multipole	R15DQ
1FK7.....-P	Resolver 14 bit, 2-pole	R14DQ

	Brake:	Shaft:
1FK7.....-A	without	Fitted key and keyway
1FK7.....-B	with	Fitted key and keyway
1FK7.....-G	without	Plain shaft
1FK7.....-H	with	Plain shaft

Degree of protection:

1FK7.....-0	IP64
1FK7.....-1	IP65
1FK7.....-2	IP65 and DE-Flange IP67

¹⁾ Optimum efficiency at continuous load

²⁾ The current carrying capacity of the power cables complies with IEC 60204-1 for installation type C under continuous operating conditions at an ambient air temperature of 40 °C (104 °F), designed for I0 (100 K), PVC/PUR-insulated cable.

1.4 Selection and ordering data, 1FK7 for DC link voltages 510 V to 720 V DC (line supply 380 V - 480 V 3 AC)

1.4.3 1FK7 High Dynamic/1FK7 High Inertia

Rated speed n_N rpm	Shaft height SH	Rated power at $\Delta T=100$ K P_N kW	Static torque at $\Delta T=100$ K M_0 Nm	Rated torque at $\Delta T=100$ K M_N Nm	Rated current at $\Delta T=100$ K I_N A	Synchronous motor 1FK7 High Dynamic / 1FK7 High Inertia Order No.	Number of pole pairs	Moment of rotor inertia (without brake) J kgcm ²	Weight (motor without brake) m kg	Efficiency ¹⁾ η %	Static current at $\Delta T=100$ K I_0 A	Calculated power $P_{calc} = M_0 \times n_N / 9550$ kW	Power connector size	Cable cross-section ²⁾ mm ²
-----------------------------	--------------------	---	---	--	--	--	----------------------	--	--	---	---	--	----------------------	--

1FK7 High Dynamic for DC-Link 510 V to 720 V (line voltage 380-480 V 3 AC)

2000	63	2.1	12.0	10.0	7.1	1FK7064-4CC71-1□□□	3	7.5	15.4	93	8.1	2.5	1	4x1.5
	80	3.1	22.0	15.0	10.0	1FK7085-4CC71-1□□□	4	22	23.0	92	13.5	4.6	1	4x1.5
		3.8	28.0	18.0	9.0	1FK7086-4CC71-1□□□	4	22	23.0	93	13.2	5.9	1	4x1.5
3000	48	1.2	4.5	3.7	3.45	1FK7044-4CF71-1□□□	3	1.26	7.4	91	4.0	1.4	1	4x1.5
	63	1.7	6.4	5.4	5.3	1FK7061-4CF71-1□□□	3	4.1	9.5	93	6.1	2	1	4x1.5
		2.5	12.0	8.0	7.6	1FK7064-4CF71-1□□□	3	7.5	15.4	93	10.8	3.8	1	4x1.5
	80	2	22.0	6.5	7.0	1FK7085-4CF71-1□□□	4	22	23.0	92	22.0	6.9	1.5	4x4
		2	28.0	6.5	5.7	1FK7086-4CF71-1□□□	4	22	23.0	93	21.5	8.8	1.5	4x4
4500	48	1.2	3.5	2.6	3.3	1FK7043-4CH71-1□□□	3	1	6.0	90	4.1	1.6	1	4x1.5
		1.4	4.5	3.0	3.9	1FK7044-4CH71-1□□□	3	1.26	7.4	91	5.4	2.1	1	4x1.5
	63	2	6.4	4.3	6.2	1FK7061-4CH71-1□□□	3	4.1	9.5	93	8.7	3	1	4x1.5
		2.4	12.0	5.0	7.0	1FK7064-4CH71-1□□□	3	7.5	15.4	93	15.0	5.7	1	4x1.5
6000	36	0.6	1.3	0.9	1.6	1FK7033-4CK71-1□□□	3	0.25	3.0	88	2.1	0.8	1	4x1.5
	48	1.3	3.5	2.0	3.5	1FK7043-4CK71-1□□□	3	1	6.0	90	5.6	2.2	1	4x1.5

1FK7 High Inertia for DC-Link 510 V to 720 V (line voltage 380-480 V 3 AC)

2000	80	3.1	20.0	15.0	6.7	1FK7084-3BC71-1□□□	4	99	23.0	93	8.5	4.2	1	4x1.5
3000	63	1.5	6.0	4.7	3.7	1FK7060-3BF71-1□□□	4	12.5	7.9	90	4.45	1.9	1	4x1.5
		1.9	8.5	6.0	4.0	1FK7062-3BF71-1□□□	4	23.5	10.7	91	5.3	2.7	1	4x1.5
	80	2.7	12.0	8.7	6.8	1FK7081-3BF71-1□□□	4	49	15.2	93	8.7	3.8	1	4x1.5
6000	48	3.1	20.0	10.0	6.5	1FK7084-3BF71-1□□□	4	99	23.0	93	12.1	6.3	1	4x1.5
		0.9	3.0	1.5	2.5	1FK7042-3BK71-1□□□	4	5.1	5.1	89	4.4	1.9	1	4x1.5

Encoder systems for motors without DRIVE-CLiQ interface:

1FK7...-...-...-A	Incremental encoder sin/cos 1 Vpp 2048 S/R	IC2048S/R
1FK7...-...-...-E	Absolute encoder EnDat 2048 S/R	AM2048S/R
1FK7...-...-...-S	Resolver multipole (not for High Inertia)	Resolver p=x
1FK7...-...-...-T	Resolver 2-pole (not for High Inertia)	Resolver p=1

Encoder systems for motors with DRIVE-CLiQ interface:

1FK7...-...-...-B	Absolute encoder singleturn 24 bit	AS24DQI
1FK7...-...-...-C	Absolute encoder 24 bit + 12 bit multiturn	AM24DQI
1FK7...-...-...-Q	Absolute encoder singleturn 20 bit	AS20DQI
1FK7...-...-...-R	Absolute encoder 20 bit + 12 bit multiturn	AM20DQI
1FK7...-...-...-U	Resolver 15 bit, multipole (not for High Inertia)	R15DQ
1FK7...-...-...-P	Resolver 14 bit, 2-pole (not for High Inertia)	R14DQ

Brake: Shaft:

1FK7...-...-...-A	without	Fitted key and keyway
1FK7...-...-...-B	with	Fitted key and keyway
1FK7...-...-...-G	without	Plain shaft
1FK7...-...-...-H	with	Plain shaft

Degree of protection:

1FK7...-...-...-0	IP64
1FK7...-...-...-1	IP65
1FK7...-...-...-2	IP65 and DE-Flange IP67

1) Optimum efficiency at continuous load

2) The current carrying capacity of the power cables complies with IEC 60204-1 for installation type C under continuous operating conditions at an ambient air temperature of 40 °C (104 °F), designed for I0 (100 K), PVC/PUR-insulated cable.

1.5 Selection and ordering data, 1FK7 for DC link voltages 270 V to 330 V DC (line supply 200 V - 240 V 1 AC)

1.5.1 1FK701/1FK702 Compact

Rated speed n_N rpm	Shaft height SH	Rated power at $\Delta T=100$ K P_N kW	Static torque at $\Delta T=100$ K M_0 Nm	Rated torque at $\Delta T=100$ K M_N Nm	Rated current at $\Delta T=100$ K I_N A	Synchronous motor 1FK7 Compact Order No.	Number of pole pairs J	Moment of rotor inertia (without brake) kgcm ²	Weight (motor without brake) m	Efficiency ¹⁾ η %	Static current at $\Delta T=100$ K I_0 A	Calculated power $P_{calc} = M_0 \times n_N / 9550$ kW	Power connector size	Cable cross-section ²⁾ mm ²
1FK7 Compact for DC-Link 270 V to 330 V (line voltage 200-240 V 1 AC)														
6000	20	0.05	0.18	0.08	0.5	1FK7011-5AK21-1□□□	4	0.0064	0.9	62	0.85	0.1	0.5	4x1.5
		0.1	0.35	0.16	0.5	1FK7015-5AK21-1□□□	4	0.083	1.1	68	0.85	0.2	0.5	4x1.5
	28	0.38	0.85	0.6	1.4	1FK7022-5AK21-1□□□	3	0.28	1.8	85	1.8	0.5	1	4x1.5

Encoder systems for motors without DRIVE-CLiQ interface:

1FK7 A	Incremental encoder sin/cos 1 Vpp 2048 S/R	IC2048S/R
1FK7 H	Absolute encoder EnDat 512 S/R (1FK702 only)	AM512S/R
1FK7 J	Absolute encoder EnDat 16 S/R	AM16S/R
1FK7 S	Resolver multipole	Resolver p=x
1FK7 T	Resolver 2-pole	Resolver p=1

Encoder systems for motors with DRIVE-CLiQ interface: (1FK702 only)

1FK7 D	Incremental encoder 22 bit	IC22DQ
1FK7 L	Absolute encoder 20 bit + 12 bit	AM20DQ
1FK7 V	Incremental encoder 22 bit	IC22DQ
1FK7 U	Resolver 15 bit multipole	R15DQ
1FK7 P	Resolver 14 bit 2-pole	R14DQ

Brake:

1FK7 A	without	Fitted key and keyway
1FK7 B	with	Fitted key and keyway
1FK7 G	without	Plain shaft
1FK7 H	with	Plain shaft

Shaft:

Degree of protection:

1FK7 0	IP64 (1FK702 only)	without paint finish
1FK7 2	IP65 and DE-Flange IP67 (1FK702 only)	without paint finish
1FK7 3	IP54 for 1FK701 / IP64 for 1FK702	with paint finish
1FK7 5	IP65 and DE-Flange IP67 (1FK702 only)	with paint finish

Coating:

¹⁾ Optimum efficiency at continuous load

²⁾ The current carrying capacity of the power cables complies with IEC 60204-1 for installation type C under continuous operating conditions at an ambient air temperature of 40 °C (104 °F), designed for I0 (100 K), PVC/PUR-insulated cable.

1.5 Selection and ordering data, 1FK7 for DC link voltages 270 V to 330 V DC (line supply 200 V - 240 V 1 AC)

1.5.2 1FK703/1FK704 Compact and 1FK703/1FK704 High Dynamic

Rated speed n_N rpm	Shaft height SH	Rated power at $\Delta T=100$ K P_N kW	Static torque at $\Delta T=100$ K M_0 Nm	Rated torque at $\Delta T=100$ K M_N Nm	Rated current at $\Delta T=100$ K I_N A	Synchronous motor 1FK7 Compact / 1FK7 High Dynamic Order No.	Number of pole pairs	Moment of rotor inertia (without brake) J kgcm ²	Weight (motor without brake) m kg	Efficiency ¹⁾ η %	Static current at $\Delta T=100$ K I_0 A	Calculated power $P_{calc} = M_0 \times n_N / 9550$ kW	Power connector size	Cable cross-section ²⁾ mm ²
1FK7 Compact for DC-Link 270 V to 330 V (line voltage 200-240 V 1 AC)														
3000	36	0.3	1.15	1.0	1.6	1FK7032-2AF21-1□□□	3	0.65	2.7	85	1.7	0.4	1	4x1.5
		0.5	1.6	1.45	1.8	1FK7034-2AF21-1□□□	3	0.9	3.5	85	1.9	0.5	1	4x1.5
	48	0.8	3.0	2.6	3.5	1FK7042-2AF21-1□□□	4	2.9	4.6	88	3.95	0.9	1	4x1.5
1FK7 High Dynamic for DC-Link 270 V to 330 V (line voltage 200-240 V 1 AC)														
3000	36	0.4	1.3	1.2	2.05	1FK7033-4CF21-1□□□	3	0.25	3.0	86	2.1	0.4	1	4x1.5
	48	0.9	3.3	3.0	3.7	1FK7043-4CF21-1□□□	3	1	6.0	88	3.9	1	1	4x1.5

Encoder systems for motors without DRIVE-CLiQ interface:

1FK7 A	Incremental encoder sin/cos 1 Vpp 2048 S/R	IC2048S/R
1FK7 E	Absolute encoder EnDat 2048 S/R	AM2048S/R
1FK7 S	Resolver multipole	Resolver p=x
1FK7 T	Resolver 2-pole	Resolver p=1

Encoder systems for motors with DRIVE-CLiQ interface:

1FK7 B	Absolute encoder singleturn 24 bit	AS24DQI
1FK7 C	Absolute encoder 24 bit + 12 bit multeturn	AM24DQI
1FK7 Q	Absolute encoder singleturn 20 bit	AS20DQI
1FK7 R	Absolute encoder 20 bit + 12 bit multeturn	AM20DQI
1FK7 U	Resolver 15 bit, multipole	R15DQ
1FK7 P	Resolver 14 bit, 2-pole	R14DQ

Brake: Shaft:

1FK7 A	without	Fitted key and keyway
1FK7 B	with	Fitted key and keyway
1FK7 G	without	Plain shaft
1FK7 H	with	Plain shaft

Degree of protection:

1FK7 0	IP64
1FK7 1	IP65
1FK7 2	IP65 and DE-Flange IP67

¹⁾ Optimum efficiency at continuous load

²⁾ The current carrying capacity of the power cables complies with IEC 60204-1 for installation type C under continuous operating conditions at an ambient air temperature of 40 °C (104 °F), designed for I0 (100 K), PVC/PUR-insulated cable.

1.6 Rating plate data

The rating plate (type plate) contains the technical data relevant for the motor. A second rating plate is provided with the motor, and can be used for documentation purposes.

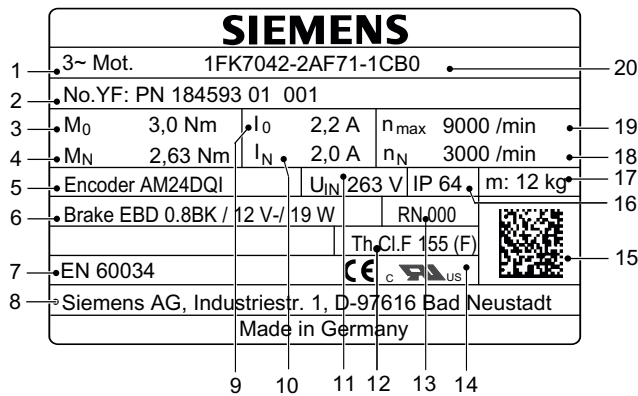

Figure 1-5 Schematic layout of rating plate

Table 1-2 Description of the rating plate data

Position	Description / technical data
1	Motor type: Synchronous motors
2	ID no., serial number
3	Static torque M_0 [Nm]
4	Rated torque M_N [Nm]
5	Designation of the encoder type
6	Holding brake data: Typical, voltage, power consumption
7	Standard for all rotating electrical machines
8	Production address
9	Stall current I_0 [A]
10	Rated current I_N [A]
11	Induced voltage at rated speed U_{IN} [V]
12	Temperature class
13	Motor version
14	Standards and specifications
15	2D code
16	Degree of protection
17	Motor weight m [kg]
18	Rated speed n_N [rpm]
19	Maximum speed n_{max} [rpm]
20	SIEMENS motor type/order number

1.7 Motor overview/Assignment of Motor Module

1FK7 for SINAMICS S120 Booksize, DC link voltage 510 V to 720 V DC, (line voltage 380 V to 480 V, 3 AC)

Table 1- 3 1FK7 Compact

Motor			Converter: SINAMICS S120 Booksize			Power cable
Order no.	M ₀ (100k) [Nm]	Connector size / Cable cross- section	Order no.	I _N [A]	M _{max} (100k) [Nm]	Order no.
1FK7011-5AK7	0.18	0.5 / 4x1.5	6SL312□-□TE13-0AA3	3	0.5	6FX5002-5DN20-□□□□
1FK7015-5AK7	0.35	0.5 / 4x1.5	6SL312□-□TE13-0AA3	3	1.0	6FX5002-5DN20-□□□□
1FK7022-5AK7	0.85	1 / 4x1.5	6SL312□-□TE13-0AA3	3	2.8	6FX□002-5□N01-□□□□
1FK7032-2AK7	1.15	1 / 4x1.5	6SL312□-□TE13-0AA3	3	4.2	6FX□002-5□N01-□□□□
1FK7034-2AK7	1.6	1 / 4x1.5	6SL312□-□TE13-0AA3	3	5.0	6FX□002-5□N01-□□□□
1FK7040-2AK7	1.6	1 / 4x1.5	6SL312□-□TE13-0AA3	3	4.0	6FX□002-5□N01-□□□□
1FK7042-2AC7	3.0	1 / 4x1.5	6SL312□-□TE13-0AA3	3	10.5	6FX□002-5□N01-□□□□
1FK7042-2AF7	3.0	1 / 4x1.5	6SL312□-□TE13-0AA3	3	8.2	6FX□002-5□N01-□□□□
1FK7042-2AK7	3.0	1 / 4x1.5	6SL312□-□TE15-0AA3	5	6.8	6FX□002-5□N01-□□□□
1FK7060-2AC7	6.0	1 / 4x1.5	6SL312□-□TE13-0AA3	3	11.4	6FX□002-5□N01-□□□□
1FK7060-2AF7	6.0	1 / 4x1.5	6SL312□-□TE15-0AA3	5	13.2	6FX□002-5□N01-□□□□
1FK7060-2AH7	6.0	1 - 4x1.5	6SL312□-□TE21-0AA3	9	15.8	6FX□002-5□N01-□□□□
1FK7062-2AC7	8.5	1 / 4x1.5	6SL312□-□TE13-0AA3	3	17.0	6FX□002-5□N01-□□□□
1FK7062-2AF7	8.5	1 / 4x1.5	6SL312□-□TE15-0AA3	5	16.0	6FX□002-5□N01-□□□□
1FK7062-2AH7	8.5	1 / 4x1.5	6SL312□-□TE21-0AA3	9	18.5	6FX□002-5□N01-□□□□
1FK7063-2AC7	11.0	1 / 4x1.5	6SL312□-□TE15-0AA3	5	20.8	6FX□002-5□N01-□□□□
1FK7063-2AF7	11.0	1 / 4x1.5	6SL312□-□TE21-0AA3	9	24.3	6FX□002-5□N01-□□□□
1FK7063-2AH7	11.0	1 / 4x1.5	6SL312□-□TE21-8AA3	18	30.9	6FX□002-5□N01-□□□□
1FK7080-2AF7	8.0	1 / 4x1.5	6SL312□-□TE15-0AA3	5	16.5	6FX□002-5□N01-□□□□
1FK7080-2AH7	8.0	1 / 4x1.5	6SL312□-□TE21-0AA3	9	18.5	6FX□002-5□N01-□□□□
1FK7081-2AC7	12.0	1 / 4x1.5	6SL312□-□TE15-0AA3	5	24.0	6FX□002-5□N01-□□□□
1FK7081-2AF7	12.0	1 / 4x1.5	6SL312□-□TE21-0AA3	9	24.7	6FX□002-5□N01-□□□□
1FK7081-2AH7	12.0	1 / 4x1.5	6SL312□-□TE21-8AA3	18	31.2	6FX□002-5□N01-□□□□
1FK7083-2AC7	16.0	1 / 4x1.5	6SL312□-□TE21-0AA3	9	36.7	6FX□002-5□N01-□□□□
1FK7083-2AF7	16.0	1 / 4x1.5	6SL312□-□TE21-8AA3	9	28.5	6FX□002-5□N01-□□□□
1FK7083-2AH7	16.0	1 / 4x1.5	6SL312□-□TE21-8AA3	18	36.7	6FX□002-5□N01-□□□□
1FK7084-2AC7	20.0	1 / 4x1.5	6SL312□-□TE21-0AA3	9	41.9	6FX□002-5□N01-□□□□
1FK7084-2AF7	20.0	1 / 4x1.5	6SL312□-□TE21-8AA3	18	55.0	6FX□002-5□N01-□□□□
1FK7100-2AC7	18.0	1 / 4x1.5	6SL312□-□TE21-0AA3	9	38.1	6FX□002-5□N01-□□□□
1FK7100-2AF7	18.0	1 / 4x1.5	6SL312□-□TE21-8AA3	18	54.0	6FX□002-5□N01-□□□□
1FK7101-2AC7	27.0	1.5 / 4x1.5	6SL312□-□TE21-8AA3	18	73.0	6FX□002-5□N21-□□□□
1FK7101-2AF7	27.0	1.5 / 4x2.5	6SL312□-□TE21-8AA3	18	52.0	6FX□002-5□N31-□□□□
1FK7103-2AC7	36.0	1.5 / 4x1.5	6SL312□-□TE21-8AA3	18	87.0	6FX□002-5□N21-□□□□
1FK7103-2AF7	36.0	1.5 / 4x4	6SL312□-□TE23-0AA3	30	77.0	6FX□002-5□N41-□□□□
1FK7105-2AC7	48.0	1.5 / 4x2.5	6SL312□-□TE23-0AA3	30	126.0	6FX□002-5□N31-□□□□
1FK7105-2AF7	48.0	1.5 / 4x6	6SL312□-□TE23-0AA3	30	87.0	6FX□002-5□N51-□□□□

Table 1- 4 1FK7 High Inertia

Motor			Converter: SINAMICS S120 Booksize			Power cable
Order no.	M ₀ (100K) [Nm]	Connector size / Cable cross-section	Order no.	I _N [A]	M _{max} (100K) [Nm]	Order no.
1FK7042-3BK7	3.0	1 / 4x1.5	6SL312□-□TE15-0AA3	5	6.8	6FX□002-5□N01-□□□□
1FK7060-3BF7	6.0	1 / 4x1.5	6SL312□-□TE15-0AA3	5	13.2	6FX□002-5□N01-□□□□
1FK7062-3BF7	8.5	1 / 4x1.5	6SL312□-□TE15-0AA3	5	16.0	6FX□002-5□N01-□□□□
1FK7081-3BF7	12.0	1 / 4x1.5	6SL312□-□TE21-0AA3	9	24.7	6FX□002-5□N01-□□□□
1FK7084-3BC7	20.0	1 / 4x1.5	6SL312□-□TE21-0AA3	9	41.9	6FX□002-5□N01-□□□□
1FK7084-3BF7	20.0	1 / 4x1.5	6SL312□-□TE21-8AA3	18	55.0	6FX□002-5□N01-□□□□

Table 1- 5 1FK7 High Dynamic

Motor			Converter: SINAMICS S120 Booksize			Power cable
Order no.	M ₀ (100K) [Nm]	Connector size / Cable cross-section	Order no.	I _N [A]	M _{max} (100K) [Nm]	Order no.
1FK7033-4CK7	1.3	1 / 4x1.5	6SL312□-□TE13-0AA3	3	3.5	6FX□002-5□N01-□□□□
1FK7043-4CH7	3.5	1 / 4x1.5	6SL312□-□TE15-0AA3	5	8.3	6FX□002-5□N01-□□□□
1FK7043-4CK7	3.5	1 / 4x1.5	6SL312□-□TE21-0AA3	9	10.0	6FX□002-5□N01-□□□□
1FK7044-4CF7	4.5	1 / 4x1.5	6SL312□-□TE15-0AA3	5	11.0	6FX□002-5□N01-□□□□
1FK7044-4CH7	4.5	1 / 4x1.5	6SL312□-□TE21-0AA3	9	13.0	6FX□002-5□N01-□□□□
1FK7061-4CF7	6.4	1 / 4x1.5	6SL312□-□TE21-0AA3	9	17.0	6FX□002-5□N01-□□□□
1FK7061-4CH7	6.4	1 / 4x1.5	6SL312□-□TE21-0AA3	9	13.1	6FX□002-5□N01-□□□□
1FK7064-4CC7	12.0	1 / 4x1.5	6SL312□-□TE21-0AA3	9	26.0	6FX□002-5□N01-□□□□
1FK7064-4CF7	12.0	1 / 4x1.5	6SL312□-□TE21-8AA3	18	32.0	6FX□002-5□N01-□□□□
1FK7064-4CH7	12.0	1 / 4x1.5	6SL312□-□TE21-8AA3	18	27.5	6FX□002-5□N01-□□□□
1FK7085-4CC7	22.0	1 / 4x1.5	6SL312□-□TE21-8AA3	18	53.0	6FX□002-5□N01-□□□□
1FK7085-4CF7	22.0	1.5 / 4x4	6SL312□-□TE23-0AA3	30	51.0	6FX□002-5□N41-□□□□
1FK7086-4CC7	28.0	1 / 4x1.5	6SL312□-□TE21-8AA3	18	69.0	6FX□002-5□N01-□□□□
1FK7086-4CF7	28.0	1.5 / 4x4	6SL312□-□TE23-0AA3	30	66.0	6FX□002-5□N41-□□□□

1FK7 for SINAMICS S120 Booksize Compact, DC link voltage 510 V to 720 V DC, (line voltage 380 V to 480 V, 3 AC)

Table 1- 6 1FK7 Compact

Motor			Converter: SINAMICS S120 Booksize Compact			Power cable
Order no.	M ₀ (100K) [Nm]	Connector size / Cable cross- section	Order no.	I _N [A]	M _{max} (100K) [Nm]	Order no.
1FK7011-5AK7	0.18	0.5 / 4x1.5	6SL3420-QTE13-0AA0	3	0.5	6FX5002-5DN30-Q000
1FK7015-5AK7	0.35	0.5 / 4x1.5	6SL3420-QTE13-0AA0	3	1.0	6FX5002-5DN30-Q000
1FK7022-5AK7	0.85	1 / 4x1.5	6SL3420-QTE13-0AA0	3	3.4	6FX0002-5QG10-Q000
1FK7032-2AK7	1.15	1 / 4x1.5	6SL3420-QTE13-0AA0	3	4.5	6FX0002-5QG10-Q000
1FK7034-2AK7	1.6	1 / 4x1.5	6SL3420-QTE13-0AA0	3	6.5	6FX0002-5QG10-Q000
1FK7040-2AK7	1.6	1 / 4x1.5	6SL3420-QTE13-0AA0	3	5.1	6FX0002-5QG10-Q000
1FK7042-2AC7	3.0	1 / 4x1.5	6SL3420-QTE13-0AA0	3	10.5	6FX0002-5QG10-Q000
1FK7042-2AF7	3.0	1 / 4x1.5	6SL3420-QTE13-0AA0	3	10.5	6FX0002-5QG10-Q000
1FK7042-2AK7	3.0	1 / 4x1.5	6SL3420-QTE15-0AA0	5	10.3	6FX0002-5QG10-Q000
1FK7060-2AC7	6.0	1 / 4x1.5	6SL3420-QTE13-0AA0	3	15.6	6FX0002-5QG10-Q000
1FK7060-2AF7	6.0	1 / 4x1.5	6SL3420-QTE15-0AA0	5	18.0	6FX0002-5QG10-Q000
1FK7060-2AH7	6.0	1 / 4x1.5	6SL3420-1TE21-0AA0	9	18.0	6FX0002-5QG10-Q000
1FK7062-2AC7	8.5	1 / 4x1.5	6SL3420-QTE13-0AA0	3	22.4	6FX0002-5QG10-Q000
1FK7062-2AF7	8.5	1 / 4x1.5	6SL3420-QTE15-0AA0	5	21.4	6FX0002-5QG10-Q000
1FK7062-2AH7	8.5	1 / 4x1.5	6SL3420-1TE21-0AA0	9	24.6	6FX0002-5QG10-Q000
1FK7063-2AC7	11.0	1 / 4x1.5	6SL3420-QTE15-0AA0	5	29.1	6FX0002-5QG10-Q000
1FK7063-2AF7	11.0	1 / 4x1.5	6SL3420-1TE21-0AA0	9	33.9	6FX0002-5QG10-Q000
1FK7063-2AH7	11.0	1 / 4x1.5	6SL3420-1TE21-8AA0	18	35.0	6FX0002-5QG10-Q000
1FK7080-2AF7	8.0	1 / 4x1.5	6SL3420-QTE15-0AA0	5	21.7	6FX0002-5QG10-Q000
1FK7080-2AH7	8.0	1 / 4x1.5	6SL3420-1TE21-0AA0	9	24.7	6FX0002-5QG10-Q000
1FK7081-2AC7	12.0	1 / 4x1.5	6SL3420-QTE15-0AA0	5	32.9	6FX0002-5QG10-Q000
1FK7081-2AF7	12.0	1 / 4x1.5	6SL3420-1TE21-0AA0	9	33.9	6FX0002-5QG10-Q000
1FK7081-2AH7	12.0	1 / 4x1.5	6SL3420-1TE21-8AA0	18	37.0	6FX0002-5QG10-Q000
1FK7083-2AC7	16.0	1 / 4x1.5	6SL3420-1TE21-0AA0	9	49.3	6FX0002-5QG10-Q000
1FK7083-2AF7	16.0	1 / 4x1.5	6SL3420-1TE21-8AA0	18	50.0	6FX0002-5QG10-Q000
1FK7083-2AH7	16.0	1 / 4x1.5	6SL3420-1TE21-8AA0	18	49.3	6FX0002-5QG10-Q000
1FK7084-2AC7	20.0	1 / 4x1.5	6SL3420-1TE21-0AA0	9	58.2	6FX0002-5QG10-Q000
1FK7084-2AF7	20.0	1 / 4x1.5	6SL3420-1TE21-8AA0	18	61.0	6FX0002-5QG10-Q000
1FK7100-2AC7	18.0	1 / 4x1.5	6SL3420-1TE21-0AA0	9	53.3	6FX0002-5QG10-Q000
1FK7100-2AF7	18.0	1 / 4x1.5	6SL3420-1TE21-8AA0	18	55.0	6FX0002-5QG10-Q000
1FK7101-2AC7	27.0	1.5 / 4x1.5	6SL3420-1TE21-8AA0	18	80.0	6FX0002-5QG22-Q000
1FK7101-2AF7	27.0	1.5 / 4x2.5	6SL3420-1TE21-8AA0	18	70.4	6FX0002-5QG32-Q000
1FK7103-2AC7	36.0	1.5 / 4x1.5	6SL3420-1TE21-8AA0	18	108.0	6FX0002-5QG22-Q000

Table 1-7 1FK7 High Inertia

Motor			Converter: SINAMICS S120 Booksize Compact			Power cable
Order no.	M ₀ (100K) [Nm]	Connector size / Cable cross- section	Order no.	I _N [A]	M _{max} (100K) [Nm]	Order no.
1FK7042-3BK7	3.0	1 / 4x1.5	6SL3420-QTE15-0AA0	5	10.3	6FX□002-5QG10-□□□□
1FK7060-3BF7	6.0	1 / 4x1.5	6SL3420-QTE15-0AA0	5	18.0	6FX□002-5QG10-□□□□
1FK7062-3BF7	8.5	1 / 4x1.5	6SL3420-QTE15-0AA0	5	21.4	6FX□002-5QG10-□□□□
1FK7081-3BF7	12.0	1 / 4x1.5	6SL3420-1TE21-0AA0	9	33.9	6FX□002-5QG10-□□□□
1FK7084-3BC7	20.0	1 / 4x1.5	6SL3420-1TE21-0AA0	9	58.2	6FX□002-5QG10-□□□□
1FK7084-3BF7	20.0	1 / 4x1.5	6SL3420-1TE21-8AA0	18	61.0	6FX□002-5QG10-□□□□

Table 1-8 1FK7 High Dynamic

Motor			Converter: SINAMICS S120 Booksize Compact			Power cable
Order no.	M ₀ (100K) [Nm]	Connector size / Cable cross- section	Order no.	I _N [A]	M _{max} (100K) [Nm]	Order no.
1FK7033-4CK7	1.3	1 / 4x1.5	6SL3420-QTE13-0AA0	3	4.3	6FX□002-5QG10-□□□□
1FK7043-4CH7	3.5	1 / 4x1.5	6SL3420-QTE15-0AA0	5	10.0	6FX□002-5QG10-□□□□
1FK7043-4CK7	3.5	1 / 4x1.5	6SL3420-1TE21-0AA0	9	10.0	6FX□002-5QG10-□□□□
1FK7044-4CF7	4.5	1 / 4x1.5	6SL3420-QTE15-0AA0	5	13.0	6FX□002-5QG10-□□□□
1FK7044-4CH7	4.5	1 / 4x1.5	6SL3420-1TE21-0AA0	9	13.0	6FX□002-5QG10-□□□□
1FK7061-4CF7	6.4	1 / 4x1.5	6SL3420-1TE21-0AA0	9	17.3	6FX□002-5QG10-□□□□
1FK7061-4CH7	6.4	1 / 4x1.5	6SL3420-1TE21-0AA0	9	17.3	6FX□002-5QG10-□□□□
1FK7064-4CC7	12.0	1 / 4x1.5	6SL3420-1TE21-0AA0	9	32.0	6FX□002-5QG10-□□□□
1FK7064-4CF7	12.0	1 / 4x1.5	6SL3420-1TE21-8AA0	18	32.0	6FX□002-5QG10-□□□□
1FK7064-4CH7	12.0	1 / 4x1.5	6SL3420-1TE21-8AA0	18	32.0	6FX□002-5QG10-□□□□
1FK7085-4CC7	22.0	1 / 4x1.5	6SL3420-1TE21-8AA0	18	65.0	6FX□002-5QG10-□□□□
1FK7086-4CC7	28.0	1 / 4x1.5	6SL3420-1TE21-8AA0	18	90.1	6FX□002-5QG10-□□□□

1FK7 for SINAMICS S110/S120 Power Modules PM340, DC link voltage 510 V to 720 V DC, (line voltage 380 V to 480 V, 3AC)

Table 1-9 1FK7 Compact

Motor			Converter: SINAMICS S110 / S120 Power Module PM340			Power cable
Order no.	M ₀ (100K) [Nm]	Connector size / Cable cross- section	Order no.	I _N [A]	M _{max} (100K) [Nm]	Order no.
1FK7011-5AK7	0.18	0.5 / 4x1.5	6SL3210-1SE11-7UA0	1.7	0.4	6FX5002-5DN30-□□□□
1FK7015-5AK7	0.35	0.5 / 4x1.5	6SL3210-1SE11-7UA0	1.7	0.8	6FX5002-5DN30-□□□□
1FK7022-5AK7	0.85	1 / 4x1.5	6SL3210-1SE12-2UA0	2.2	2.0	6FX□002-5QG10-□□□□

Motor			Converter: SINAMICS S110 / S120 Power Module PM340			Power cable
Order no.	M ₀ (100K) [Nm]	Connector size / Cable cross- section	Order no.	I _N [A]	M _{max} (100K) [Nm]	Order no.
1FK7032-2AK7	1.15	1 / 4x1.5	6SL3210-1SE11-7UA0	1.7	2.3	6FX0002-5CG10-0000
1FK7034-2AK7	1.6	1 / 4x1.5	6SL3210-1SE12-2UA0	2.2	3.7	6FX0002-5CG10-0000
1FK7040-2AK7	1.6	1 / 4x1.5	6SL3210-1SE13-1UA0	3.1	4.1	6FX0002-5CG10-0000
1FK7042-2AC7	3.0	1 / 4x1.5	6SL3210-1SE11-7UA0	1.7	6.4	6FX0002-5CG10-0000
1FK7042-2AF7	3.0	1 / 4x1.5	6SL3210-1SE12-2UA0	2.2	6.0	6FX0002-5CG10-0000
1FK7042-2AK7	3.0	1 / 4x1.5	6SL3210-1SE16-0QA0	5.9	8.1	6FX0002-5CG10-0000
1FK7060-2AC7	6.0	1 / 4x1.5	6SL3210-1SE13-1UA0	3.1	11.1	6FX0002-5CG10-0000
1FK7060-2AF7	6.0	1 / 4x1.5	6SL3210-1SE16-0QA0	5.9	14.7	6FX0002-5CG10-0000
1FK7060-2AH7	6.0	1 / 4x1.5	6SL3210-1SE17-7QA0	7.7	13.6	6FX0002-5CG10-0000
1FK7062-2AC7	8.5	1 / 4x1.5	6SL3210-1SE13-1UA0	3.1	16.2	6FX0002-5CG10-0000
1FK7062-2AF7	8.5	1 / 4x1.5	6SL3210-1SE16-0QA0	5.9	17.5	6FX0002-5CG10-0000
1FK7062-2AH7	8.5	1 / 4x1.5	6SL3210-1SE21-0QA0	10.2	19.7	6FX0002-5CG10-0000
1FK7063-2AC7	11.0	1 / 4x1.5	6SL3210-1SE16-0QA0	5.9	23.4	6FX0002-5CG10-0000
1FK7063-2AF7	11.0	1 / 4x1.5	6SL3210-1SE21-0QA0	10.2	26.5	6FX0002-5CG10-0000
1FK7063-2AH7	11.0	1 / 4x1.5	6SL3210-1SE21-8QA0	18	23.1	6FX0002-5CG10-0000
1FK7080-2AF7	8.0	1 / 4x1.5	6SL3210-1SE16-0QA0	5.9	17.8	6FX0002-5CG10-0000
1FK7080-2AH7	8.0	1 / 4x1.5	6SL3210-1SE17-7QA0	7.7	15.6	6FX0002-5CG10-0000
1FK7081-2AC7	12.0	1 / 4x1.5	6SL3210-1SE16-0QA0	5.9	26.7	6FX0002-5CG10-0000
1FK7081-2AF7	12.0	1 / 4x1.5	6SL3210-1SE21-0QA0	10.2	26.5	6FX0002-5CG10-0000
1FK7081-2AH7	12.0	1 / 4x1.5	6SL3210-1SE21-8QA0	18	23.2	6FX0002-5CG10-0000
1FK7083-2AC7	16.0	1 / 4x1.5	6SL3210-1SE17-7QA0	7.7	30.9	6FX0002-5CG10-0000
1FK7083-2AF7	16.0	1 / 4x1.5	6SL3210-1SE21-0QA0	10.2	30.5	6FX0002-5CG10-0000
1FK7083-2AH7	16.0	1 / 4x1.5	6SL3210-1SE21-8QA0	18	27.0	6FX0002-5CG10-0000
1FK7084-2AC7	20.0	1 / 4x1.5	6SL3210-1SE21-0QA0	10.2	45.4	6FX0002-5CG10-0000
1FK7084-2AF7	20.0	1 / 4x1.5	6SL3210-1SE21-8QA0	18	41.5	6FX0002-5CG10-0000
1FK7100-2AC7	18.0	1 / 4x1.5	6SL3210-1SE21-0QA0	10.2	41.5	6FX0002-5CG10-0000
1FK7100-2AF7	18.0	1 / 4x1.5	6SL3210-1SE21-8QA0	18	40.7	6FX0002-5CG10-0000
1FK7101-2AC7	27.0	1.5 / 4x1.5	6SL3210-1SE21-8QA0	18	55.0	6FX0002-5CG22-0000
1FK7101-2AF7	27.0	1.5 / 4x2.5	6SL3210-1SE22-5QA0	25	51.8	6FX0002-5CG32-0000
1FK7103-2AC7	36.0	1.5 / 4x1.5	6SL3210-1SE21-8QA0	18	64.2	6FX0002-5CG22-0000
1FK7103-2AF7	36.0	1.5 / 4x4	6SL3210-1SE23-2QA0	32	69.7	6FX0002-5CG42-0000
1FK7105-2AC7	48.0	1.5 / 4x2.5	6SL3210-1SE22-5QA0	25	87.3	6FX0002-5CG32-0000
1FK7105-2AF7	48.0	1.5 / 4x6	6SL3210-1SE23-2QA0	32	78.1	6FX0002-5CG52-0000

1.7 Motor overview/Assignment of Motor Module

Table 1- 10 1FK7 High Inertia

Motor			Converter: SINAMICS S110 / S120 Power Module PM340			Power cable
Order no.	M ₀ (100K) [Nm]	Connector size / Cable cross- section	Order no.	I _N [A]	M _{max} (100K) [Nm]	Order no.
1FK7042-3BK7	3.0	1 / 4x1.5	6SL3210-1SE16-0QA0	5.9	8.1	6FX0002-5QG10-0000
1FK7060-3BF7	6.0	1 / 4x1.5	6SL3210-1SE16-0QA0	5.9	14.7	6FX0002-5QG10-0000
1FK7062-3BF7	8.5	1 / 4x1.5	6SL3210-1SE16-0QA0	5.9	17.5	6FX0002-5QG10-0000
1FK7081-3BF7	12.0	1 / 4x1.5	6SL3210-1SE21-0QA0	10.2	26.5	6FX0002-5QG10-0000
1FK7084-3BC7	20.0	1 / 4x1.5	6SL3210-1SE21-0QA0	10.2	45.4	6FX0002-5QG10-0000
1FK7084-3BF7	20.0	1 / 4x1.5	6SL3210-1SE21-8QA0	18	41.5	6FX0002-5QG10-0000

Table 1- 11 1FK7 High Dynamic

Motor			Converter: SINAMICS S110 / S120 Power Module PM340			Power cable
Order no.	M ₀ (100K) [Nm]	Connector size / Cable cross- section	Order no.	I _N [A]	M _{max} (100K) [Nm]	Order no.
1FK7033-4CK7	1.3	1 / 4x1.5	6SL3210-1SE12-2UA0	2.2	2.6	6FX0002-5QG10-0000
1FK7043-4CH7	3.5	1 / 4x1.5	6SL3210-1SE14-1UA0	4.1	6.8	6FX0002-5QG10-0000
1FK7043-4CK7	3.5	1 / 4x1.5	6SL3210-1SE16-0QA0	5.9	7.1	6FX0002-5QG10-0000
1FK7044-4CF7	4.5	1 / 4x1.5	6SL3210-1SE14-1UA0	4.1	9.0	6FX0002-5QG10-0000
1FK7044-4CH7	4.5	1 / 4x1.5	6SL3210-1SE16-0QA0	5.9	9.6	6FX0002-5QG10-0000
1FK7061-4CF7	6.4	1 / 4x1.5	6SL3210-1SE17-7QA0	7.7	14.8	6FX0002-5QG10-0000
1FK7061-4CH7	6.4	1 / 4x1.5	6SL3210-1SE21-0QA0	10.2	13.9	6FX0002-5QG10-0000
1FK7064-4CC7	12.0	1 / 4x1.5	6SL3210-1SE21-0QA0	10.2	27.2	6FX0002-5QG10-0000
1FK7064-4CF7	12.0	1 / 4x1.5	6SL3210-1SE21-8QA0	18	26.7	6FX0002-5QG10-0000
1FK7064-4CH7	12.0	1 / 4x1.5	6SL3210-1SE21-8QA0	18	20.1	6FX0002-5QG10-0000
1FK7085-4CC7	22.0	1 / 4x1.5	6SL3210-1SE21-8QA0	18	39.8	6FX0002-5QG10-0000
1FK7085-4CF7	22.0	1.5 / 4x4	6SL3210-1SE22-5QA0	25	35.8	6FX0002-5QG42-0000
1FK7086-4CC7	28.0	1 / 4x1.5	6SL3210-1SE21-8QA0	18	52.1	6FX0002-5QG10-0000
1FK7086-4CF7	28.0	1.5 / 4x4	6SL3210-1SE22-5QA0	25	46.9	6FX0002-5QG42-0000

**1FK7 for SINAMICS S110/S120 Power Modules PM340,
DC link voltage 270 V to 330 V DC, (line voltage 200 V to 240 V, 1AC)**

Table 1- 12 1FK7 Compact

Motor			Converter: SINAMICS S110 / S120 Power Module PM340			Power cable
Order no.	M ₀ (100K) [Nm]	Connector size / Cable cross- section	Order no.	I _N [A]	M _{max} (100K) [Nm]	Order no.
1FK7011-5AK2	0.18	0.5 / 4x1.5	6SL3210-1SB11-0□A0	0.9	0.4	6FX5002-5DN30-□□□□
1FK7015-5AK2	0.35	0.5 / 4x1.5	6SL3210-1SB11-0□A0	0.9	0.8	6FX5002-5DN30-□□□□
1FK7022-5AK2	0.85	1 / 4x1.5	6SL3210-1SB12-3□A0	2.3	2.1	6FX□002-5□G10-□□□□
1FK7032-2AF2	1.15	1 / 4x1.5	6SL3210-1SB12-3□A0	2.3	3.2	6FX□002-5□G10-□□□□
1FK7034-2AF2	1.6	1 / 4x1.5	6SL3210-1SB12-3□A0	2.3	3.8	6FX□002-5□G10-□□□□
1FK7042-2AF2	3.0	1 / 4x1.5	6SL3210-1SB14-0□A0	3.9	5.9	6FX□002-5□G10-□□□□

Table 1- 13 1FK7 High Dynamic

Motor			Converter: SINAMICS S110 / S120 Power Module PM340			Power cable
Order no.	M ₀ (100K) [Nm]	Connector size / Cable cross- section	Order no.	I _N [A]	M _{max} (100K) [Nm]	Order no.
1FK7033-4CF2	1.3	1 / 4x1.5	6SL3210-1SB12-3□A0	2.3	2.7	6FX□002-5□G10-□□□□
1FK7043-4CF2	3.3	1 / 4x1.5	6SL3210-1SB14-0□A0	3.9	6.4	6FX□002-5□G10-□□□□

Configuration

2.1 Configuring software

2.1.1 Configuration tool SIZER for SIEMENS Drives

Overview

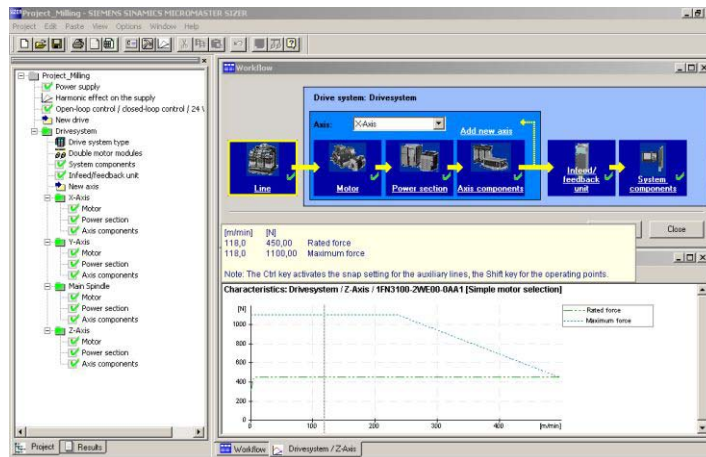

Figure 2-1 SIZER for SIEMENS Drives

The user-friendly configuration of the SINAMICS drive family is carried out using the configuration tool SIZER for SIEMENS Drives. It provides support for the technical planning of the hardware and firmware components required for a drive task. SIZER for SIEMENS Drives covers the full range of operations required to configure a complete drive system, from simple single drives to complex multi-axis applications.

SIZER for SIEMENS Drives supports all the configuration steps in a single workflow:

- Configuring the power supply
- Designing the motor and gearbox, including calculation of mechanical transmission elements
- Configuring the drive components
- Compiling the required accessories
- Selection of the line-side and motor-side power options

When SIZER for SIEMENS Drives was being designed, particular importance was placed on a high degree of usability and a holistic, function-based approach to the drive application. The extensive user navigation makes it easy to use the tool. Status information keeps you continually informed about how engineering is progressing.

The SIZER for SIEMENS Drives user interface is available in German and English. The drive configuration is saved in a project. In the project, the components and functions used are displayed in a hierarchical tree structure. The project view permits the configuration of drive systems and the copying/inserting/modifying of drives already configured.

The configuration process produces the following results:

- Parts list of components required (Export to Excel)
- Technical specifications of the system
- Characteristics
- Comments on system reactions
- Location diagram of drive and control components and dimension drawings

These results are displayed in a results tree and can be reused for documentation purposes. User support is provided by technological online help, which provides the following information:

- Detailed technical data
- Information about the drive systems and their components
- Decision-making criteria for the selection of components.

Table 2- 1 Order number for SIZER for SIEMENS Drives

Configuration tool	Order number (MLFB) of the DVD
SIZER for SIEMENS Drives German/English	6SL3070-0AA00-0AG0

Minimum system requirements

- PC or PG with Pentium™ III 800 MHz (recommended > 1 GHz)
- 512 MB RAM (1 GB recommended)
- At least 4.1 GB free hard disk space
- In addition, 100 MB free hard disk space on the Windows system drive
- Screen resolution 1024 × 768 pixels (1280 x 1024 pixels recommended)
- Windows™ 7 Professional (32 bit), 7 Ultimate (32 bit), XP Prof SP2, XP Home SP2, XP 64 bit SP2, Vista Business
- Microsoft Internet Explorer 5.5 SP2

2.1.2 STARTER drive/commissioning software

The STARTER commissioning tool provides

- Commissioning
- Optimization
- Diagnostics

Table 2- 2 Order number for STARTER

Commissioning tool	Order number (MLFB) of the DVD
STARTER German, English, French, Italian, Spanish	6SL3072-0AA00-0AG0

Minimum system requirements

- Hardware
 - PG or PC with Pentium III min. 800 MHz (recommended > 1 GHz)
 - 512 MB RAM (1 GB recommended)
 - Screen resolution 1024 × 768 pixels, 16-bit color depth
 - Free hard disk memory: min. 2 GB;
- Software
 - Microsoft Windows 2000 SP4
 - Microsoft Windows Server 2003 SP1 and SP2 (PCS7)
 - Microsoft Windows XP Professional SP2 and SP3
 - Microsoft Windows VISTA Business SP1 *)
 - Microsoft Windows VISTA Ultimate SP1 *)
 - Microsoft Internet Explorer V6.0 or higher

*) DCC cannot be used.

STARTER can be used on these operating systems only if it does not include the DCC option.

2.1.3 SinuCom commissioning tool

The simple-to-use commissioning software SinuCom is used for the commissioning of SINUMERIK controls in combination with the SINAMICS S120 drives and SIMODRIVE 611 digital.

Table 2- 3 Order number for SinuCom

Commissioning tool	Order number (MLFB) of the DVD
SinuCom German, English, French, Italian, Spanish	6FC5862-2YC00-0YA0

2.2 Configuring procedure

Motion control

Drives are optimized for motion control applications. They execute linear or rotary movements within a defined movement cycle. All movements should be optimized in terms of time.

As a result, drives must meet the following requirements:

- High dynamic response, i.e. short rise times
- Capable of overload, i.e. a high reserve for accelerating
- Wide control range, i.e. high resolution for precise positioning.

The following table "Configuring procedure" is valid for synchronous and induction motors.

General configuring procedure

The function description of the machine provides the basis when configuring the drive application. The definition of the components is based on physical interdependencies and is usually carried out as follows:

Table 2- 4 Configuring procedure

step	Description of the configuring activity	
1.	Clarification of the type of drive	Refer to the next chapter
2.	Definition of supplementary conditions and integration into an automation system	
3.	Definition of the load, calculation of the maximum load torque and selection of the motor	
4.	Selection of the SINAMICS Motor Module	Refer to catalog
5.	Steps 3 and 4 are repeated for additional axes	
6.	Calculation of the required DC link power and selection of the SINAMICS Line Module	
7.	Selection of the line-side options (main switch, fuses, line filters, etc.)	
8.	Specification of the required control performance and selection of the Control Unit, definition of component cabling	
9.	Definition of other system components (e.g. braking resistors)	
10.	Calculation of the current demand of the 24 V DC supply for the components and specification of the power supplies (SITOP devices, Control Supply Modules)	
11.	Selection of the components for the connection system	
12.	Configuration of the drive line-up components	
13.	Calculation of the required cable cross sections for power supply and motor connections	
14.	Inclusion of mandatory installation clearances	

2.2.1 1. Clarification of the type of drive

The motor is selected on the basis of the required torque, which is defined by the application, e.g. traveling drives, hoisting drives, test stands, centrifuges, paper and rolling mill drives, feed drives or main spindle drives. Gearboxes to convert motion or to adapt the motor speed and motor torque to the load conditions must also be considered.

As well as the load torque, which is determined by the application, the following mechanical data is among those required to calculate the torque to be provided by the motor:

- Masses to be moved
- Diameter of the drive wheel
- Leadscrew pitch, gear ratios
- Frictional resistance
- Mechanical efficiency
- Traversing paths

- Maximum velocity
- Maximum acceleration and maximum deceleration
- Cycle time

2.2.2 2. Defining the supplementary conditions and integration into an automation system

You must decide whether synchronous or induction motors are to be used.

Synchronous motors are the best choice if it is important to have low envelope dimensions, low rotor moment of inertia and therefore maximum dynamic response ("Servo" control type).

Induction motors can be used to increase maximum speeds in the field weakening range. Induction motors for higher power ratings are also available.

The following factors are especially important when engineering a drive application:

- The line system configuration, when using specific types of motor and/or line filters on IT systems (non-grounded systems)
- The utilization of the motor in accordance with rated values for winding temperature rise 60 K or 100 K (for synchronous motors).
- The ambient temperatures and the installation altitude of the motors and drive components.
- Heat dissipation from the motors through natural ventilation, forced ventilation or water cooling

Other constraints apply when integrating the drives into an automation environment such as SINUMERIK or SIMOTION.

For motion control and technology functions (e.g. positioning), as well as for synchronous operation functions, the corresponding automation system, e.g. SIMOTION D, is used.

2.2.3 3. Definition of the load, calculation of max. load torque and definition of the motor

The motor-specific limiting characteristics provide the basis for defining the motors.

These define the torque or power characteristic versus the speed and take into account the motor limits based on the DC link voltage. The DC link voltage is dependent on the line voltage. In the case of torque drive the DC link voltage is dependent on the type of Line Module and the type of infeed module or infeed/regenerative feedback module.

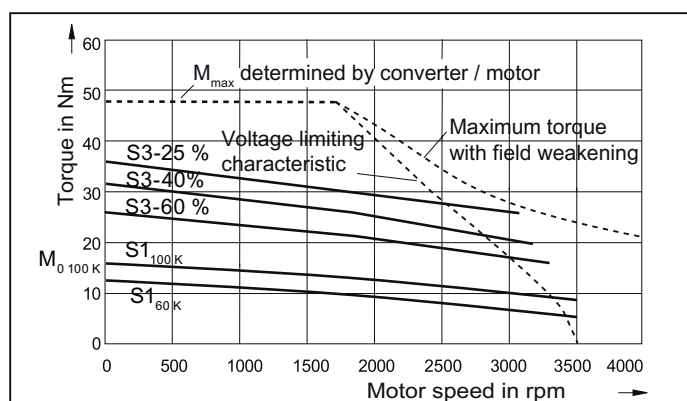

Figure 2-2 Limit characteristics for synchronous motors

The motor is selected based on the load which is specified by the application. Different characteristic curves must be used for different load events.

The following operating scenarios have been defined:

- Load duty cycle with constant ON period
- Load duty cycles with varying ON period
- Free duty cycle

The objective is to identify characteristic torque and speed operating points, on the basis of which the motor can be selected depending on the particular load.

Once the operating scenario has been defined and specified, the maximum motor torque is calculated. Generally, the maximum motor torque is required when accelerating. The load torque and the torque required to accelerate the motor are added.

The maximum motor torque is then verified with the limiting characteristic curves of the motors.

The following criteria must be taken into account when selecting the motor:

- The dynamic limits must be adhered to, i.e., all speed-torque points of the relevant load event must lie below the relevant limiting characteristic curve.
- The thermal limits must be adhered to, i.e. the RMS motor torque at the average motor speed resulting from the duty cycle must lie below the S1 characteristic curve (continuous duty).

Load duty cycles with constant on period

For duty cycles with constant ON period, there are specific requirements for the torque characteristic curve as a function of the speed, for example:

$M = \text{constant}$, $M \sim n^2$, $M \sim n$ or $P = \text{constant}$.

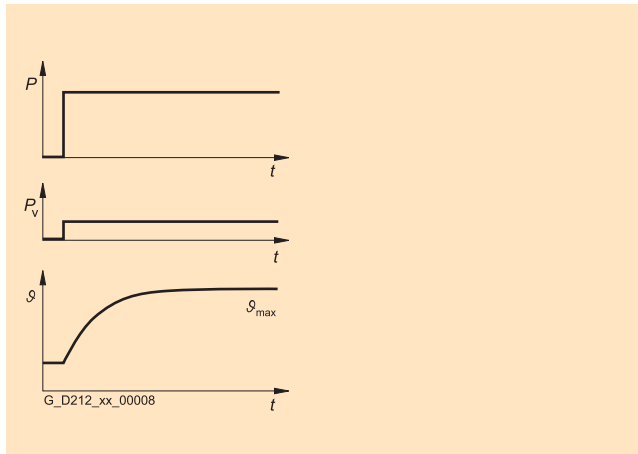

Figure 2-3 S1 duty (continuous operation)

These drives typically operate at a specific operating point. Drives such as these are dimensioned for a base load. The base load torque must lie below the S1 characteristic curve. In the event of transient overloads (e.g. when accelerating) an overload has to be taken into consideration. The overload current must be calculated relative to the required overload torque. The peak torque must lie below the voltage limiting characteristic.

In summary, the motor is selected as follows:

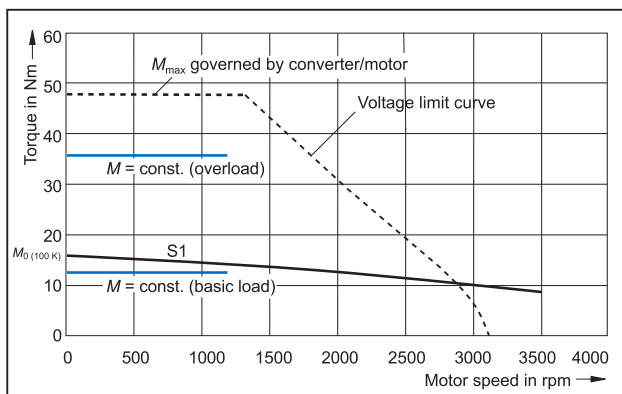

Figure 2-4 Selection of motors for load duty cycles with constant on period (examples)

Load duty cycles with varying on period

As well as continuous duty (S1), standard intermittent duty types (S3) are also defined for load duty cycles with varying on periods. This involves operation that comprises a sequence of similar load cycles, each of which comprises a time with constant load and an off period.

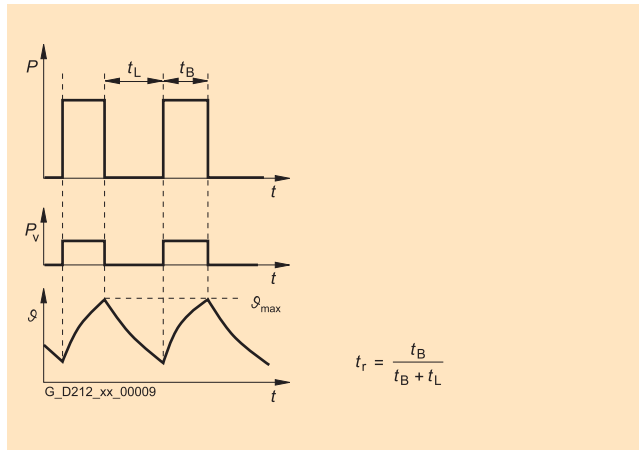

Figure 2-5 S3 duty (intermittent operation without influencing starting)

Fixed variables are usually used for the relative on period:

- S3 – 60%
- S3 – 40%
- S3 – 25%

The corresponding motor characteristics are provided for these specifications. The load torque must lie below the corresponding thermal limiting characteristic curve of the motor. An overload must be taken into consideration for load duty cycles with varying on periods.

Free duty cycle

A load duty cycle defines the characteristics of the motor speed and the torque with respect to time.

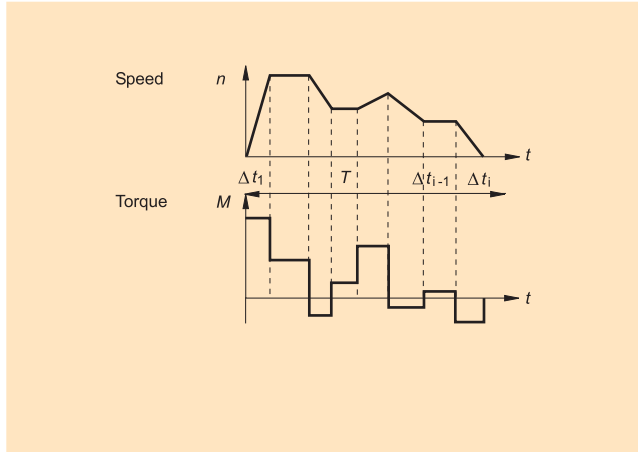

Figure 2-6 Example of a load duty cycle

A load torque is specified for each time period. In addition to the load torque, the average load moment of inertia and motor moment of inertia must be taken into account for acceleration. It may be necessary to take into account a frictional torque that opposes the direction of motion.

When a gearbox is mounted:

The gear ratio and gear efficiency must be taken into account when calculating the load and/or accelerating torque to be provided by the motor. A higher gear ratio increases positioning accuracy in terms of encoder resolution. For any given motor encoder resolution, as the gear ratio increases, so does the resolution of the machine position to be detected.

Note

The following formulas can be used for duty cycles outside the field weakening range. For duty cycles in the field weakening range, the drive system must be engineered using the SIZER engineering tool.

For the motor torque in a time slice Δt_i the following applies:

$$M_{Mot, i} = (J_M + J_G) \cdot \frac{2\pi}{60} \cdot \frac{\Delta n_{Last, i}}{\Delta t_i} \cdot i + \left(J_{Last} \cdot \frac{2\pi}{60} \cdot \frac{\Delta n_{Last, i}}{\Delta t_i} + M_{Last, i} + M_R \right) \cdot \frac{1}{i \cdot \eta_G}$$

The motor speed is:

$$n_{Mot, i} = n_{Last, i} \cdot i$$

The RMS torque is obtained as follows:

$$M_{\text{Mot, eff}} = \sqrt{\frac{\sum M_{\text{Mot, } i}^2 \cdot \Delta t_i}{T}}$$

The average motor speed is calculated as follows:

$$n_{\text{Mot, mittel}} = \frac{\sum \frac{n_{\text{Mot, k, A}} + n_{\text{Mot, k, E}}}{2} \cdot \Delta t_i}{T}$$

- J_M Motor moment of inertia
- J_G Gearbox moment of inertia
- J_{load} Load moment of inertia
- n_{Load} Load speed
- i Gear ratio
- η_G Gearbox efficiency
- M_{load} Load torque
- M_R Frictional torque
- T Cycle time, clock cycle time
- $A; E$ Initial value, final value in time slice Δt_i
- t_e ON period
- Δt_i Time interval

The RMS torque M_{rms} must lie below the S1 curve.

The maximum torque M_{max} is produced during the acceleration operation. M_{max} must lie below the voltage limiting characteristic curve. In summary, the motor is selected as follows:

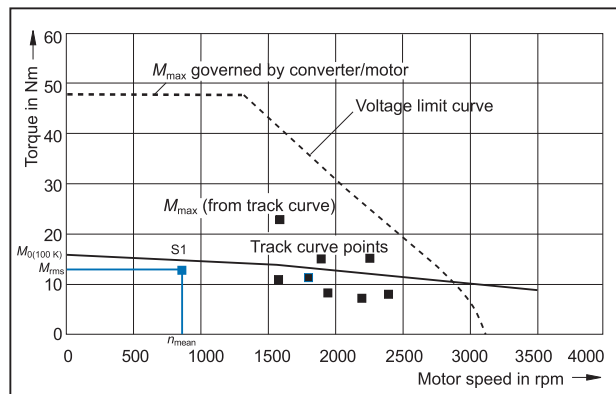

Figure 2-7 Selecting motors depending on the load duty cycle (example)

Specification of the motor

Through variation, it is now possible to identify a motor which meets the requirements of the application (duty cycle).

In a second step, a check is made as to whether the thermal limits are maintained. To do this, the motor current at the base load must be calculated. The calculation depends on the type of motor used (synchronous motor, induction motor) and the particular application (duty cycle). When configuring according to duty cycle with constant ON period with overload, the overload current must be calculated relative to the required overload torque.

Finally, the other motor features must be defined by configuring the motor options.

Mechanical properties of the motors

3.1 Cooling

For naturally-cooled motors, the heat loss is dissipated through thermal conduction, radiation and natural convection. As a consequence, adequate heat dissipation must be guaranteed by suitably mounting the motor.

To ensure sufficient cooling, a minimum clearance of 100 mm to adjacent components must be observed on 3 sides.

The rated data only applies when the ambient temperature does not exceed 40 °C (104 °F) as a result of the installation conditions.

3.2 Degree of protection

The degree of protection designation in accordance with EN 60034-5 and IEC 60034-5 is made using the letters "IP" and two digits (e.g. IP64).

IP = International Protection

1. digit = protection against the ingress of foreign bodies
2. digit = protection against water

Since most cooling lubricants used in machine tools and transfer machines are oily, creep-capable, and/or corrosive, protection against water alone is insufficient. The servo motors must be protected by suitable covers.

Attention must be paid to providing suitable sealing of the motor shaft for the selected degree of protection for the motor.

Sealing of the motor shaft

Table 3- 1 Sealing of the motor shaft

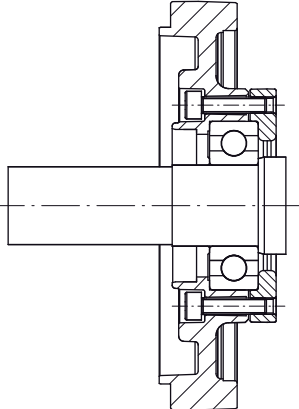
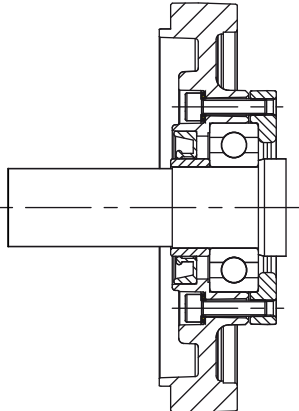
Degree of protection acc. to EN 60034-5)	Shaft sealing using	Area of application
IP64	Labyrinth seal 	It is not permissible that there is any moisture in the area around the shaft and the flange. Note: For IP 64 degree of protection it is not permissible that liquid collects in the flange. Shaft outlet is not dust-tight
IP65	Radial shaft sealing ring without annular spring 	Shaft outlet seal to protect against spray water and cooling-lubricating medium. It is permissible that the radial shaft sealing ring runs dry. Lifetime approx. 25000 h (nominal value). For IP65 degree of protection it is not permissible that liquid collects in the flange.

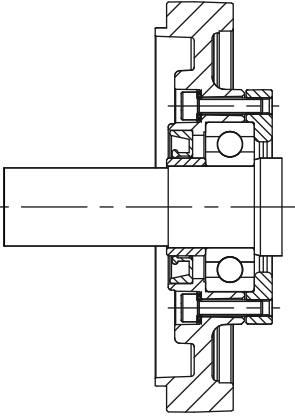
Degree of protection acc. to EN 60034-5)	Shaft sealing using	Area of application
IP65, shaft outlet IP67	Radial shaft sealing ring 	<p>For this version, the shaft gland + flange has a degree of protection IP67. The rest of the motor has degree of protection IP65.</p> <p>For gearbox mounting (for gearboxes that are not sealed) to seal against oil.</p> <p>The sealing lip must be adequately cooled and lubricated by the gearbox oil in order to guarantee reliable function.</p> <p>Lifetime approx. 10000 h (nominal value).</p> <p>If a radial shaft sealing ring runs dry, then this has a negative impact on its functionality and the lifetime.</p>

3.3 Bearing version

3.3 Bearing version

The 1FK7 motors are equipped with permanently lubricated deep-groove ball bearings. The location bearing is at the DE.

3.4 Radial and axial forces

3.4.1 Calculating the belt pre-tension

$$F_V [N] = 2 \cdot M_0 \cdot c / d_R \qquad F_V \leq F_{R, perm}$$

Table 3-2 Explanation of the formula abbreviations

Formula abbreviations	Unit	Description
F_V	N	Belt pre-tension
M_0	Nm	Motor static torque
c	—	Pre-tensioning factor: this factor is an empirical value provided by the belt manufacturer. It can be assumed to be as follows: for toothed belts: $c = 1.5$ to 2.2 for flat belts $c = 2.2$ to 3.0
d_R	m	Effective diameter of the belt pulley
$F_{R, perm}$	N	Permissible radial force

When using other configurations, the actual forces, generated from the torque being transferred, must be taken into account.

3.4.2 Radial force loading

Point of application of radial forces F_R at the shaft end

- for average operating speeds
- for a nominal bearing service life (L_{10h}) of 25 000 h

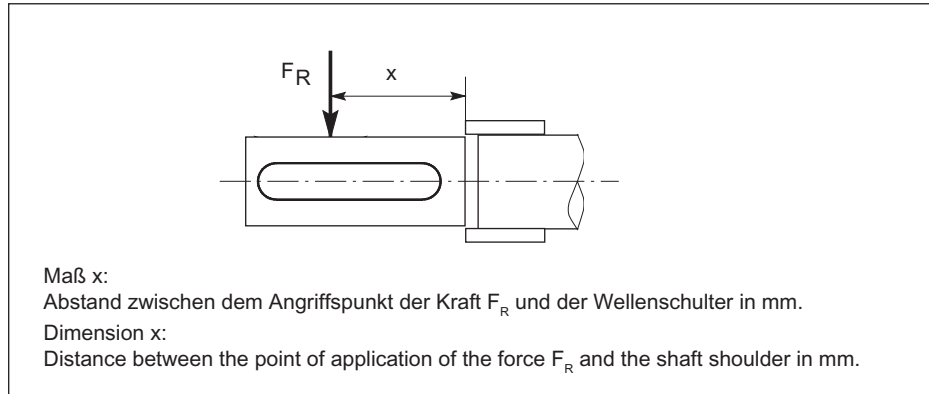

Figure 3-1 Force application point at the DE

3.4.3 Radial force diagrams

Radial force, 1FK7011

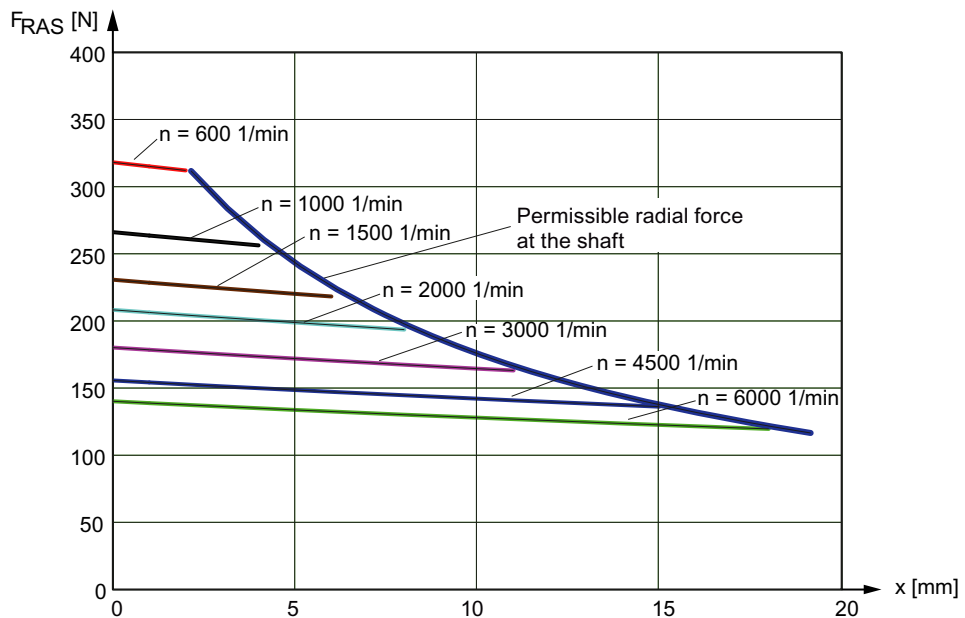

Figure 3-2 Radial force F_R at a distance x from the shaft shoulder for a nominal bearing lifetime of 25000 h

Radial force, 1FK7015

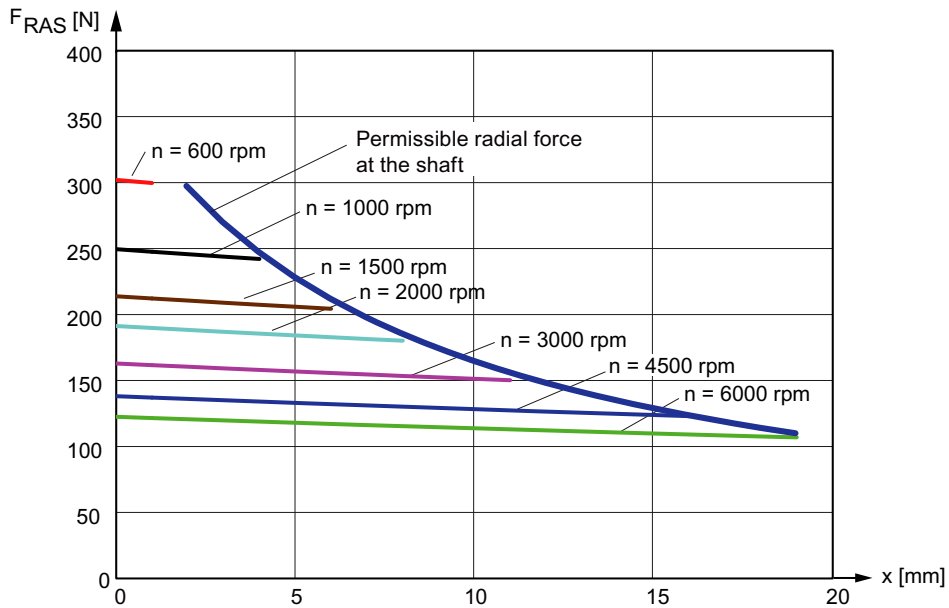

Figure 3-3 Radial force F_R at a distance x from the shaft shoulder for a nominal bearing lifetime of 25000 h

Radial force, 1FK702

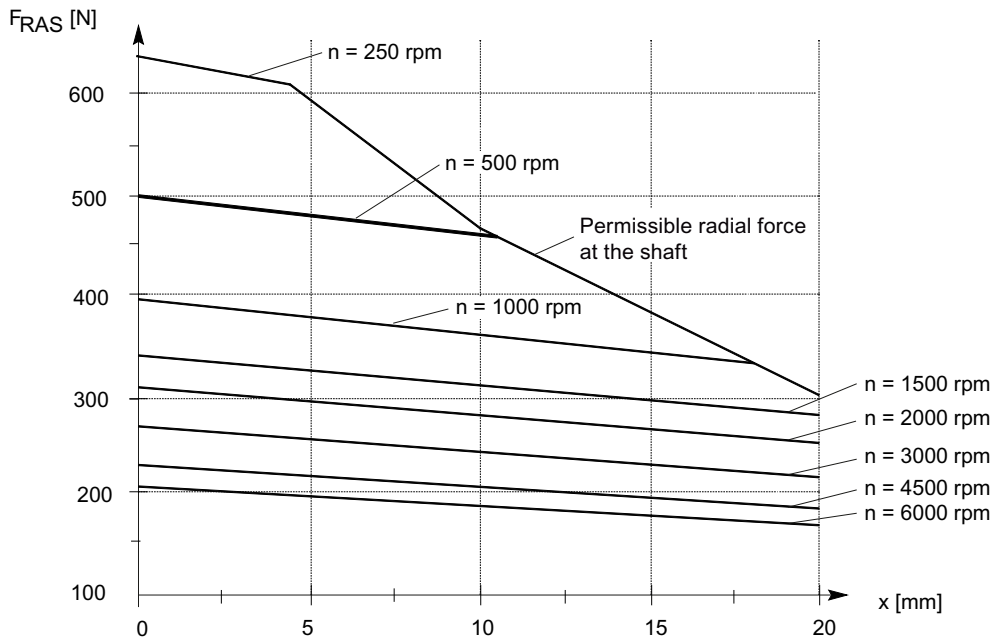

Figure 3-4 Radial force F_R at a distance x from the shaft shoulder for a nominal bearing lifetime of 25000 h

Radial force, 1FK703

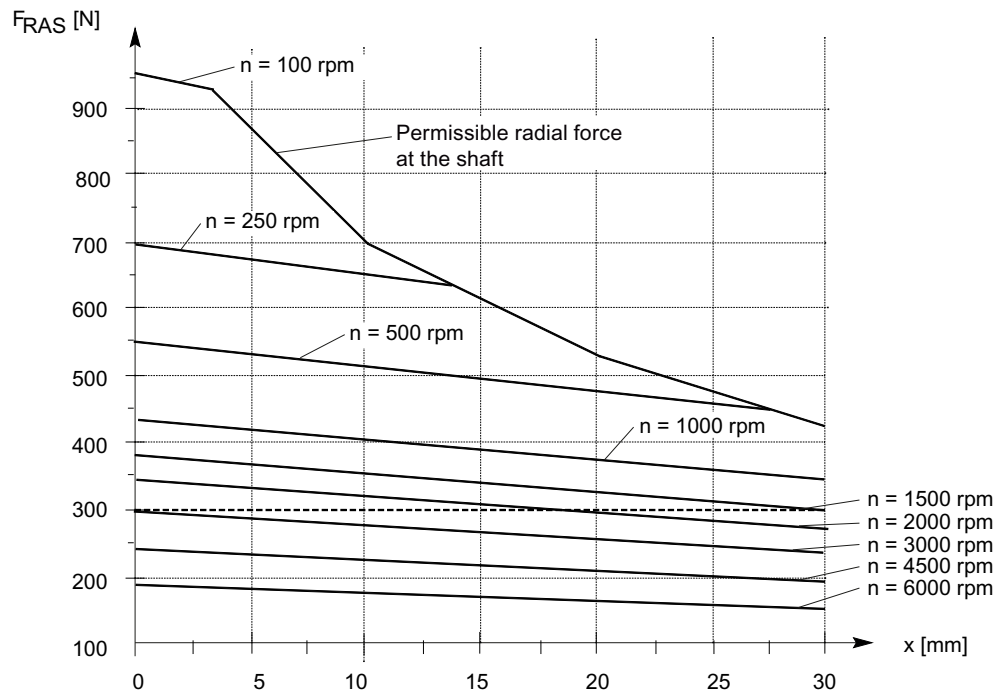

Figure 3-5 Radial force F_R at a distance x from the shaft shoulder for a nominal bearing lifetime of 25000 h

Radial force, 1FK704

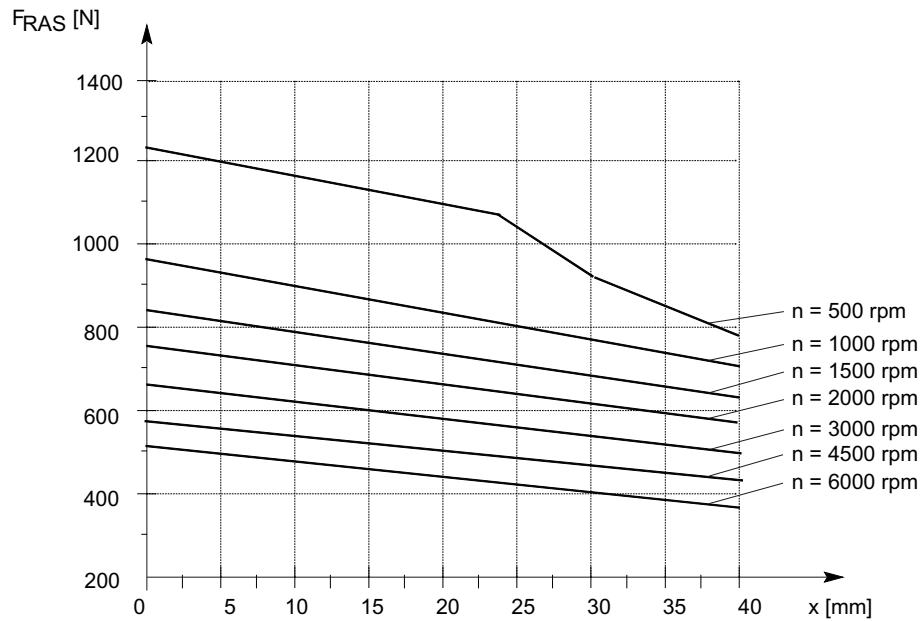

Figure 3-6 Radial force F_R at a distance x from the shaft shoulder for a nominal bearing lifetime of 25000 h

Radial force, 1FK706

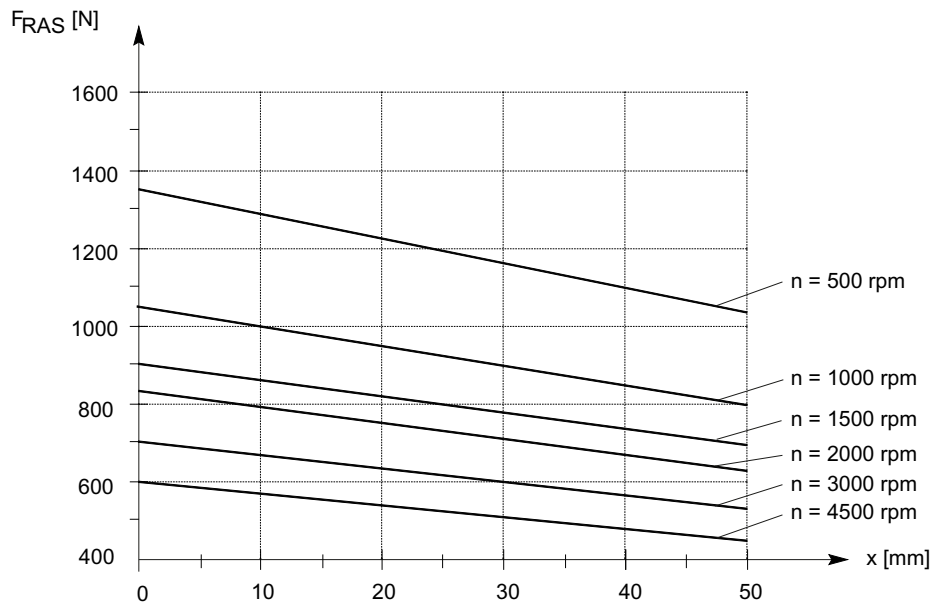

Figure 3-7 Radial force F_R at a distance x from the shaft shoulder for a nominal bearing lifetime of 25000 h

Radial force, 1FK708

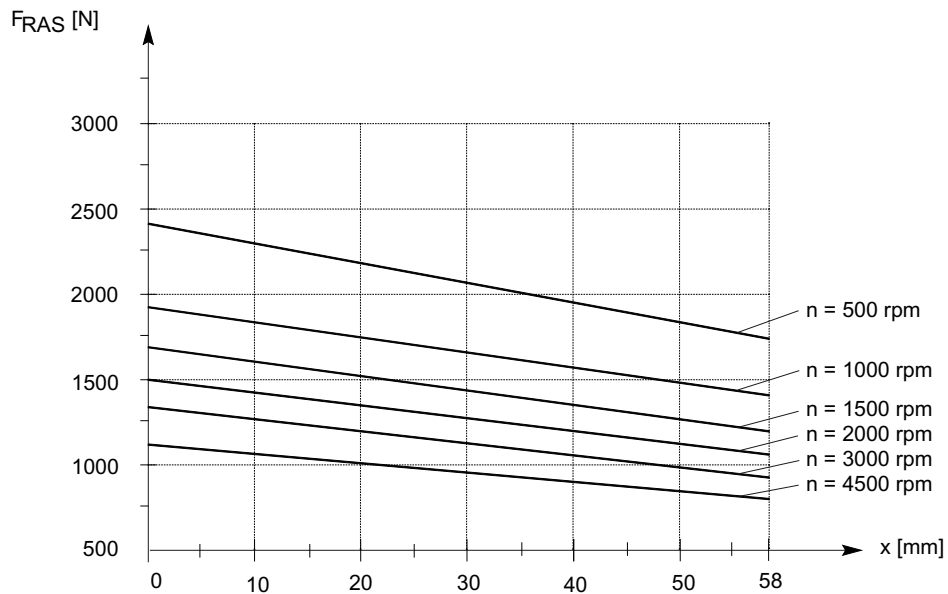

Figure 3-8 Radial force F_R at a distance x from the shaft shoulder for a nominal bearing lifetime of 25000 h

Radial force, 1FK710

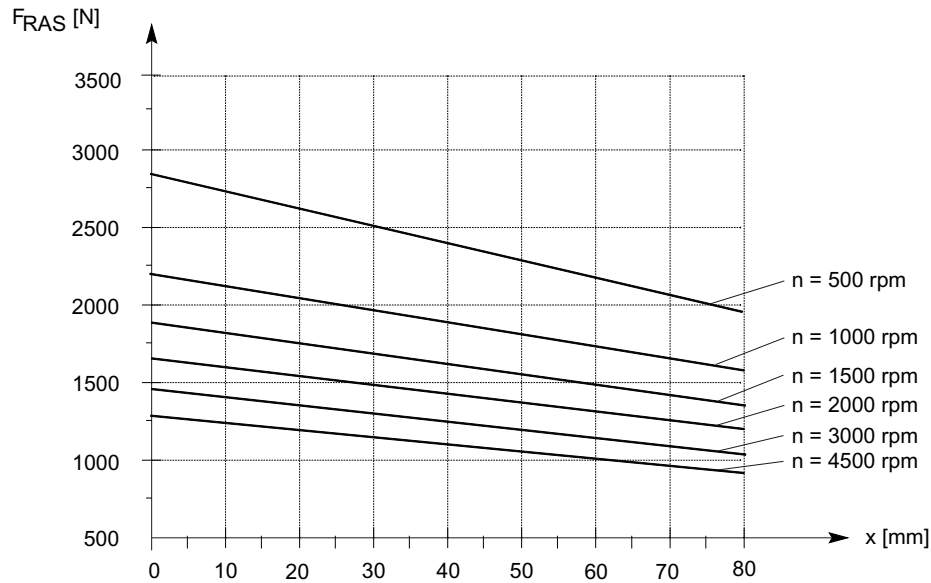

Figure 3-9 Radial force F_R at a distance x from the shaft shoulder for a nominal bearing lifetime of 25000 h

3.4.4 Axial force stressing

When using, for example, helical toothed wheels as drive element, in addition to the radial force, there is also an axial force on the motor bearings. For axial forces, the spring-loading of the bearings can be overcome so that the rotor is displaced corresponding to the axial bearing play present.

Shaft height	Displacement
36 and 48	approx. 0.2 mm
63 to 100	approx. 0.35 mm

An axial force as large as the spring-loading is not permitted (100 ... 500 N). Premature failure is the result when the bearing is not pre-tensioned.

Calculating the permissible axial force: $F_A = F_R \cdot 0.35$

⚠ WARNING
Motors with integrated holding brake
Motors with integrated holding brake cannot be subject to axial forces!

3.5 Smooth running, concentricity and axial eccentricity

The shaft and flange accuracies are checked according to DIN 42955, IEC 60072-1. Any specifications deviating from these values are stated on the dimension drawings.

Table 3- 3 Radial eccentricity tolerance of the shaft to the frame axis (referred to cylindrical shaft ends)

Shaft height	Motor	Standard N
20	1FK701	0.03 mm
28	1FK702	0.03 mm
36	1FK703	0.035 mm
48, 63	1FK704/1FK706	0.04 mm
80, 100	1FK708/1FK710	0.05 mm

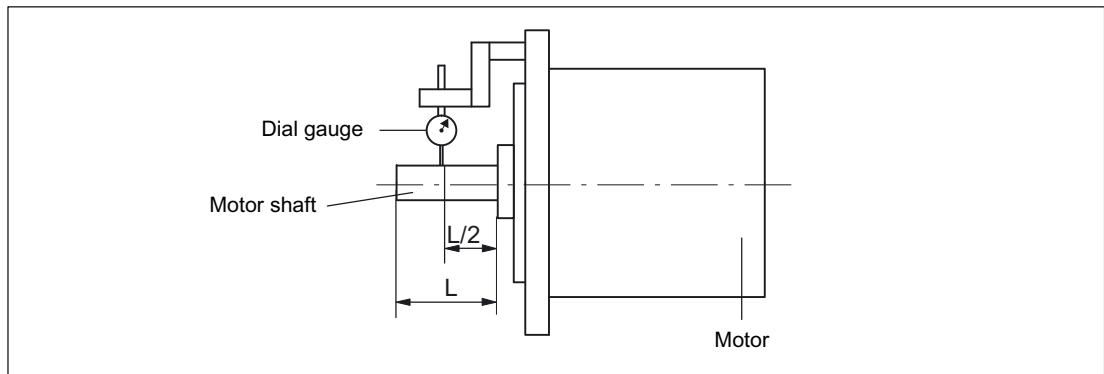

Figure 3-10 Checking the radial eccentricity

Table 3- 4 Concentricity and axial eccentricity tolerance of the flange surface to the shaft axis (referred to the centering diameter of the mounting flange)

Shaft height	Motor	Standard N
20	1FK701	0.06 mm
28	1FK702	0.08 mm
36, 48	1FK703/1FK704	0.08 mm
63, 80, 100	1FK706/1FK708/1FK710	0.1 mm

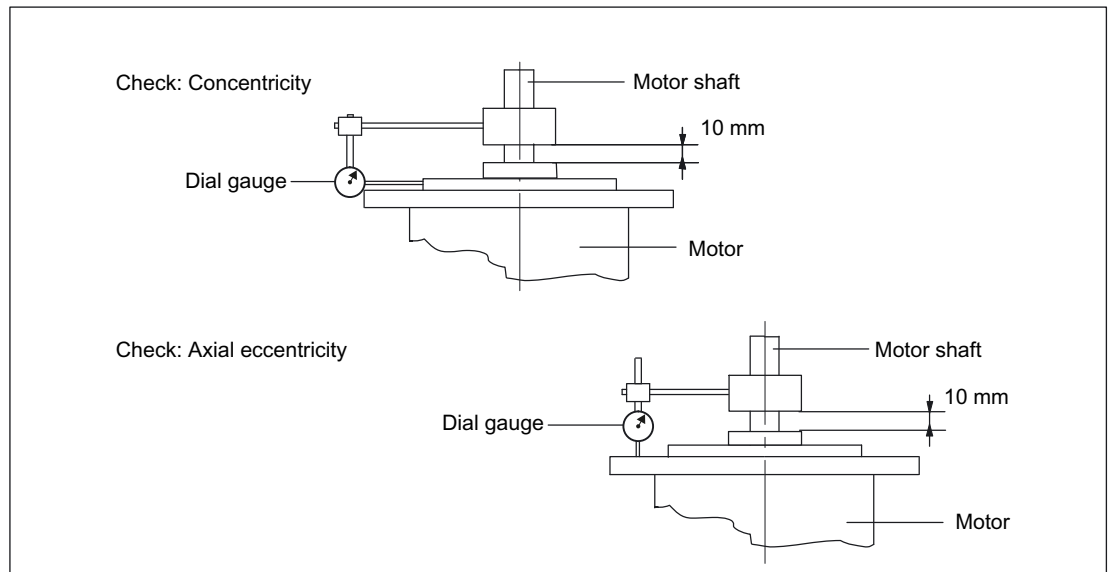

Figure 3-11 Checking the concentricity and axial eccentricity

3.6 Shaft end

The drive shaft end is cylindrical in accordance with DIN 748 Part 3, IEC 60072-1. The force-locked shaft-hub coupling is preferred for fast acceleration and reversing operation of the drives.

Standard: plain shaft

Option: keyway and key (half-key balancing)

3.7 Balancing

The motors are balanced according to DIN ISO 8821.

Motors with featherkey in the shaft are half-key balanced. The mass equalization for the protruding half key must be taken into account for the output elements.

3.8 Vibration severity grade

Motors with a keyway are balanced with a half fitted key by the manufacturer. The vibration response of the system at the installation location is influenced by transmission elements, any mounted parts, the alignment, the installation, and external vibrations. As a result, the motor's vibration values may change.

The motors conform to vibration severity grade A in accordance with EN 60034-14 (IEC 60034-14).

The specified values refer only to the motor. These values can be increased at the motor due to the overall vibration response of the complete system after the drive has been mounted.

The vibration severity level is maintained up to the rated speed (n_N).

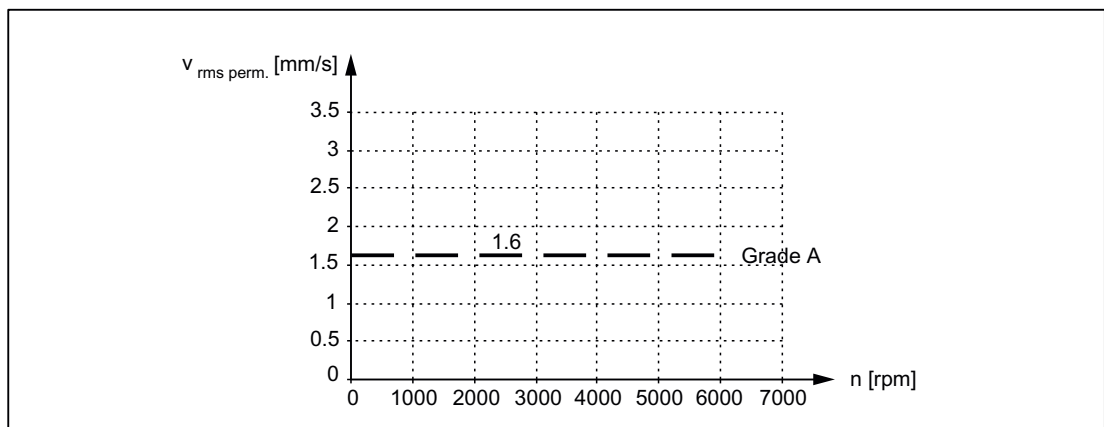

Figure 3-12 Vibration severity levels

3.9 Noise emission

When operated in the speed range 0 to rated speed, 1FK7 motors can reach the following measuring-surface sound pressure level $L_p(A)$:

Table 3- 5 Sound pressure level

Shaft height	Measuring-surface sound pressure level $L_p(A)$
1FK701 to 1FK704	55 dB(A) + 3 dB tolerance
1FK706	65 dB(A) + 3 dB tolerance
1FK708 to 1FK710	70 dB(A) + 3 dB tolerance

The motors are certified for a wide range of installation and operating conditions. These conditions such as rigid or vibration-isolated foundation design influence noise emission, sometimes significantly.

3.10 Paint finish

If no special color is selected, 1FK7 motors are painted in the standard anthracite color (RAL 7016).

Table 3- 6 Order codes of special colors (option)

Designation	Order code
RAL 9005, jet black ¹⁾	X01
RAL 9001, cream white ¹⁾	X02
RAL 6011, reseda green ¹⁾	X03
RAL 7032, gray ¹⁾	X04
RAL 5015, sky blue ¹⁾	X05
RAL 1015, light ivory ¹⁾	X06
RAL 9006, white aluminum (paint suitable for foodstuff environments) ¹⁾	X08
RAL 9023, dark pearl gray ¹⁾	X27
Special paint finish for climate group Worldwide: Primer and paint finish in anthracite, RAL 7016 ¹⁾	K23
Special paint finish for climate group Worldwide: Primer and other paint finish may be selected from X01 to X27 ²⁾	K23+X...
Primed (unpainted)	K24

1) For the paint finish, 1FK701 and 1FK702 motors must be ordered with 3 or 5 at the 16th position of the order number.

2) For the primer, 1FK702 motors must be ordered with 0 or 2 at the 16th position of the order number.

Technical data and characteristics

4.1 Operating range and characteristics

Permissible operating range

The permissible operating range is limited by thermal, mechanical, and electromagnetic boundaries. The data in this documentation is valid for self-cooled motors up to an ambient temperature of 40 °C.

The temperature rise of the motor is caused by the losses generated in the motor (current-dependent losses, no-load losses, friction losses). The utilization of the motor depends on the cooling method (naturally cooled, forced ventilation, liquid-cooled). To adhere to the temperature limits, the permissible torque decreases with increasing speed, starting from static torque M_0 .

Permissible temperature range, characteristics S1_(100 K) and S1_(60 K)

1FK7 motors can be operated up to an average winding temperature of 145 °C.

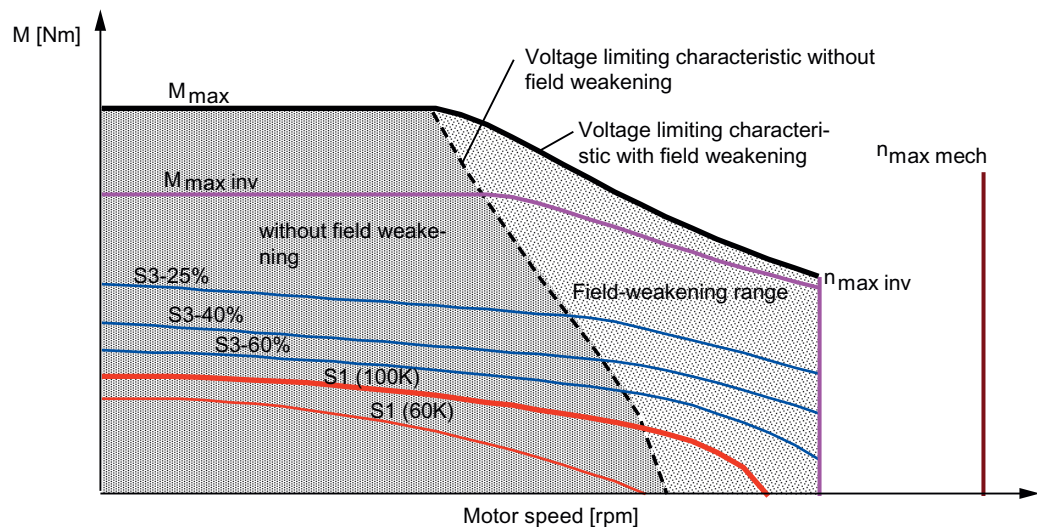

Figure 4-1 Torque characteristics of synchronous motors

For continuous operation, the limits of this permissible temperature range are represented by the S1 characteristic designated as 100 K. This corresponds to utilization according to temperature class 155 (F).

4.1 Operating range and characteristics

If a lower temperature class is necessary, for example

- If the temperature of the enclosure/housing must lie below 90° C for safety reasons
- If the motor temperature rise would have a negative impact on the machine

the S1 characteristic designated as 60 K can be selected. In this case the motor maintains temperature class 130 (B).

 CAUTION

Continuous duty in the area above the S1 characteristic curve is not thermally permitted for the motor.

Periodic intermittent operation, characteristics S3_{25%/40%/60%} and M_{max}

In periodic intermittent operation the motor can be subjected to higher loading as a function of the ON period (see also chapter headed "Engineering"). The S3 characteristics identified with the respective ON period (25%, 40% and 60%) apply.

As a general rule the cycle time is 10 minutes. The overtemperature is 100 K.

As an exception, for small motors a cycle time of 1 minute is specified and noted in the characteristic curves. A transient, high overload capacity up to the characteristic M_{max} is provided over the complete speed setting range.

Recommended Motor Module

In the chapter titled "Motor overview/Assignment of Motor Module" a Motor Module is recommended for each motor in accordance with its stall current. The maximum achievable torque is shown in the characteristic M_{max Inv}.

When configuring intermittent or overload operation, you must check whether a larger Motor Module may be required in order to provide the necessary peak current.

Speed limits n_{max mech} and n_{max Inv}

The speed range is limited by the mechanical limit speed n_{max mech} (centrifugal forces at the rotor, bearing service life) or the electrical limit speed n_{max Inv} (withstand voltage of the converter or max. frequency of the converter).

The maximum permissible speed n_{max} is therefore the minimum of n_{max mech} and n_{max Inv}.

 CAUTION

The maximum permissible speed (mechanical) n_{max mech} must not be exceeded.

CAUTION

When the machine is running (with shaft operated by motor or separately driven) at speeds higher than $n_{\max \text{ Inv}}$, a voltage in excess of the maximum permissible converter voltage might be induced in the winding. This can cause irreparable damage to the converter. No operation is therefore permissible above the speed $n_{\max \text{ Inv}}$ without protective measures or other additional measures. Siemens AG accepts no liability for any damage occurring as a result of failure to pay heed to this danger warning.

Torque limit when operating on a SINAMICS S110 / S120 with field weakening

The field weakening function is active as standard for the SINAMICS S110 / S120 drive system. A field-weakening current is injected in such a way as to enable operation to the right of or above the voltage limiting characteristic. The shape of the voltage limiting characteristic for field weakening is determined by the winding version (armature circuit) and the magnitude of the converter output voltage.

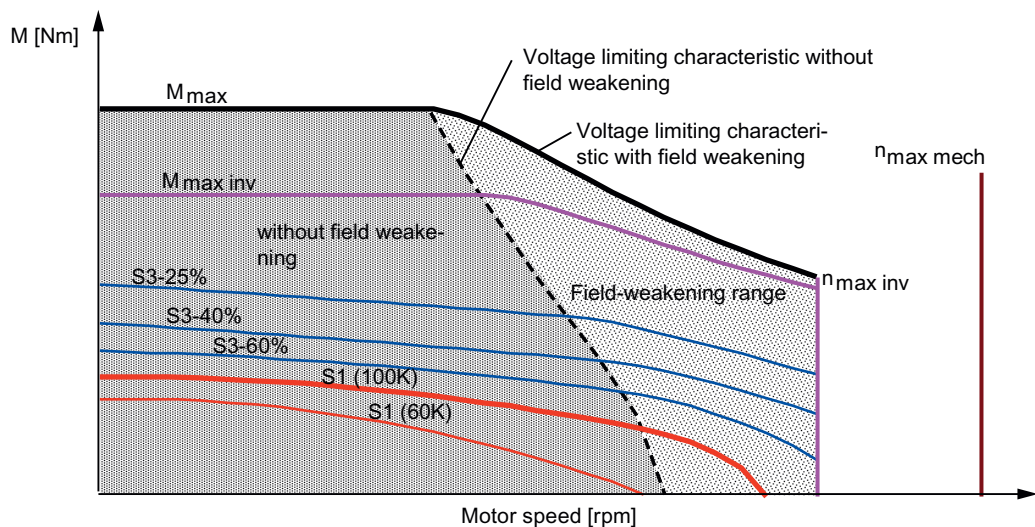

Figure 4-2 Shape of the voltage limiting characteristic with/without field weakening

4.1 Operating range and characteristics

The characteristic curve is shown for each winding version in a separate data sheet. The torque-speed diagrams for different converter output voltages are assigned to each data sheet:

Table 4- 1 Converter output voltages

Drive system	Infeed module	Line supply voltage	DC link voltage	Output voltage
		U_{line}	$U_{DC\ link}$	U_{mot}
SINAMICS S110 / S120 3 AC 380 - 480 V	ALM	400 V	600 V	425 V
	ALM	480 V	720 V	510 V
	SLM	400 V	540 V	380 V
	SLM	480 V	650 V	460 V
SINAMICS S110 / S120 1 AC 230 V	AC/AC device	230 V	300 V	180 V

Torque limit when operating on a SINAMICS S110 / S120 without field weakening

It is possible to deactivate the field weakening function with the SINAMICS S110 / S120 drive system. This therefore reduces the operating range that is available.

The shape of the voltage limiting characteristic is determined by the winding version (armature circuit) and the magnitude of the converter output voltage.

The voltage induced in the motor winding increases as the speed increases. The difference between the DC link voltage of the converter and the induced motor voltage can be used to apply the current.

This limits the magnitude of the current that can be impressed. This causes the torque to drop off quickly at high speeds. All operating points that can be achieved with the motor lie to the left of the voltage limiting characteristic curve shown as a dashed line.

The characteristic curve is shown for each winding version in a separate data sheet. The torque-speed diagrams for different converter output voltages are assigned to each data sheet:

Table 4- 2 Converter output voltages

Drive system	Infeed module	Line supply voltage	DC link voltage	Output voltage
		U_{line}	$U_{DC\ link}$	U_{mot}
SINAMICS S110 / S120 3 AC 380 - 480 V	ALM	400 V	600 V	425 V
	ALM	480 V	720 V	510 V
	SLM	400 V	540 V	380 V
	SLM	480 V	650 V	460 V
SINAMICS S110 / S120 1 AC 230 V	AC/AC device	230 V	300 V	180 V

For different converter output voltages the voltage limiting characteristic curve must be shifted (offset) accordingly. See "Offset of the voltage limit characteristic"

Winding versions

Several winding versions (armature circuits) for different rated speeds n_N are possible within a motor frame size.

Table 4-3 Code letter, winding version

Rated speed n_N [RPM]	Winding version (10. position of the Order No.)
2000	C
3000	F
4500	H
6000	K

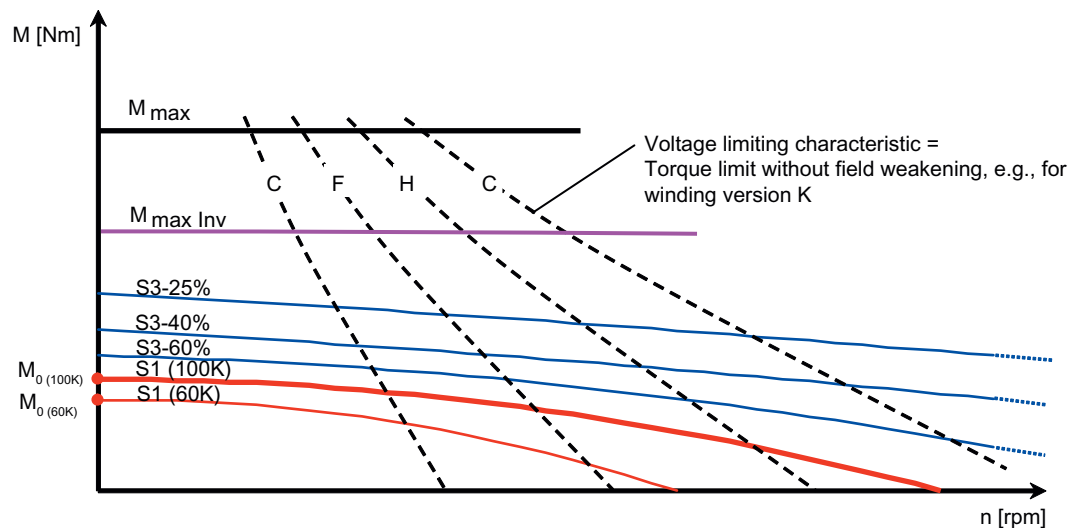

Figure 4-3 Speed-torque diagram

Note

The voltage limit characteristic of a motor with 6000 RPM rated speed lies far above that of the same motor type with 2000 RPM. However, for the same torque, this motor requires a significantly higher current.

For this reason, you should select the rated speed such that it does not lie too far above the maximum speed required for the application.

The size (rating) of the Motor Module (output current) can be minimized in this fashion

Shifting the voltage limiting characteristic curve (only relevant when field weakening is deactivated)

NOTICE

A offset of the voltage limiting characteristic can only be used in the case of approximately linear limiting characteristic curves. The voltage limiting characteristic can be offset only if the condition $U_{mot, new} > U_{IN}$ is fulfilled.

The induced voltage U_{IN} can be taken from the motor rating plate or calculated according to the following formula: $U_{IN} = k_E \cdot n_N / 1000$

In order to identify the limits of the motor for a converter output voltage (U_{mot}) other than 380 V, 425 V, 460 V or 510 V, the relevant voltage limiting characteristic curve must be shifted (offset) for the particular new output voltage ($U_{mot, new}$).

The degree of offset is obtained as follows:

For an output voltage of $U_{mot, new}$, an offset is obtained along the X axis (speed) by a factor of:

$$\frac{U_{mot, new}}{U_{mot}} \cdot U_{mot, new} = \text{new converter output voltage}$$

$$U_{mot} = \text{drive converter output voltage from the characteristic curve for 380 V, 425 V, 460 V or 510 V}$$

Calculating the new torque limit with the new limiting characteristic

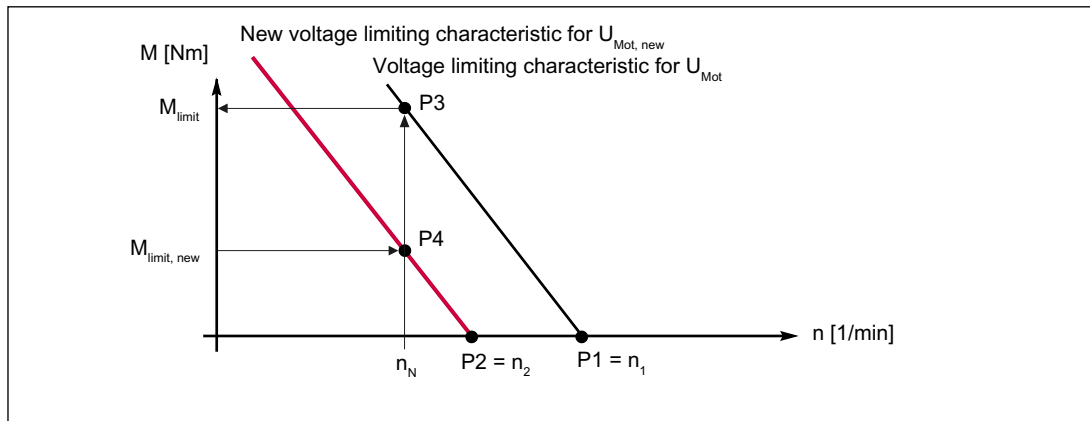

P1 Intersection of the voltage limiting characteristic on the x axis: calculate speed n_1

$$n_1 \text{ [rpm]} = \frac{U_{Mot}}{k_E \cdot 0,95} \cdot 1000$$

P2 Intersection of the new voltage limiting characteristic on the x axis; calculate speed n_2

$$n_2 \text{ [rpm]} = n_1 \cdot \frac{U_{\text{mot, new}}}{U_{\text{Mot}}}$$

P3 At n_N draw a line vertically upwards up to the voltage limiting characteristic. This point of intersection is P3. On the left-hand side, read off M_{limit} .

P4 In order to determine P4, $M_{\text{limit, new}}$ must be calculated.

$$M_{\text{limit, new}} = \frac{U_{\text{Mot, new}} - U_{\text{iN}}}{U_{\text{Mot}} - U_{\text{iN}}} \cdot M_{\text{limit}}$$

P4 is the intersection of $M_{\text{limit, new}}$ and n_N . The new voltage limiting characteristic is obtained by connecting P2 and P4.

Example of offset of voltage limiting characteristic curve without field weakening

Motor 1FK7032-5AK71; $n_N = 6000 \text{ rpm}$; $k_E = 45 \text{ V/1000 rpm}$

$U_{\text{mot, new}} = 290 \text{ V}$; calculated with $U_{\text{mot}} = 425 \text{ V}$

$U_{\text{iN}} = k_E \cdot n_N/1000$; $U_{\text{iN}} = 45 \cdot 6000/1000 = 270 \text{ V}$

Condition: $U_{\text{mot, new}} > U_{\text{iN}}$ is fulfilled.

Calculation P1: $n_1 = \frac{425}{45 \cdot 0,95} \cdot 1000 \text{ rpm} = 9941.5 \text{ rpm}$

Calculation P2: $n_2 = \frac{290}{425} \cdot 9941.5 \text{ rpm} = 6783.6 \text{ rpm}$

Calculation P3: M_{limit} read-off for $n_N = 6000 \text{ rpm}$ and 425 V : approx. 4.9 Nm

Calculation P4: $M_{\text{limit, new}} = \frac{290 - 270}{425 - 270} \cdot 4.9 \text{ Nm} = 0.63 \text{ Nm}$

Enter and connect points P2 and P4. This line is the new voltage limiting characteristic for $U_{\text{mot, new}} = 290 \text{ V}$.

Typical M/I characteristic

Because of saturation effects, the achievable torque cannot be calculated linearly from the current (particularly at high currents).



Figure 4-4 Torque-current characteristic curve for self-cooled motors

From M_0 (or I_0), the following formula can be used to determine the torque or the torque constant as a function of the current:

$$k_T(I) = \frac{M}{I} (I) = \frac{M_0}{I_0} + \frac{I - I_0}{I_{max} - I_0} \cdot \left(\frac{M_{max}}{I_{max}} - \frac{M_0}{I_0} \right)$$

Tolerance data

The data shown in the data sheets are nominal values that are subject to natural scatter. The following tolerances apply:

Table 4-4 Tolerance data in the motor list data

Motor list data		Typ. value	Max. value
Stall current	I_0	± 3 %	± 7,5 %
Electrical time constant	T_{el}	± 5 %	± 10 %
Torque constant	k_T	± 3 %	± 7,5 %
Voltage constant	k_E	± 3 %	± 7,5 %
Winding resistance	R_{ph}	± 5 %	± 10 %
Moment of inertia	J_{mot}	± 2 %	± 10 %

Effects of the temperature influence and parameter scatter on the characteristic

The torque-speed characteristics specified in the following chapter relate to the nominal values at operating temperature (shown as characteristic 3 in the chart below).

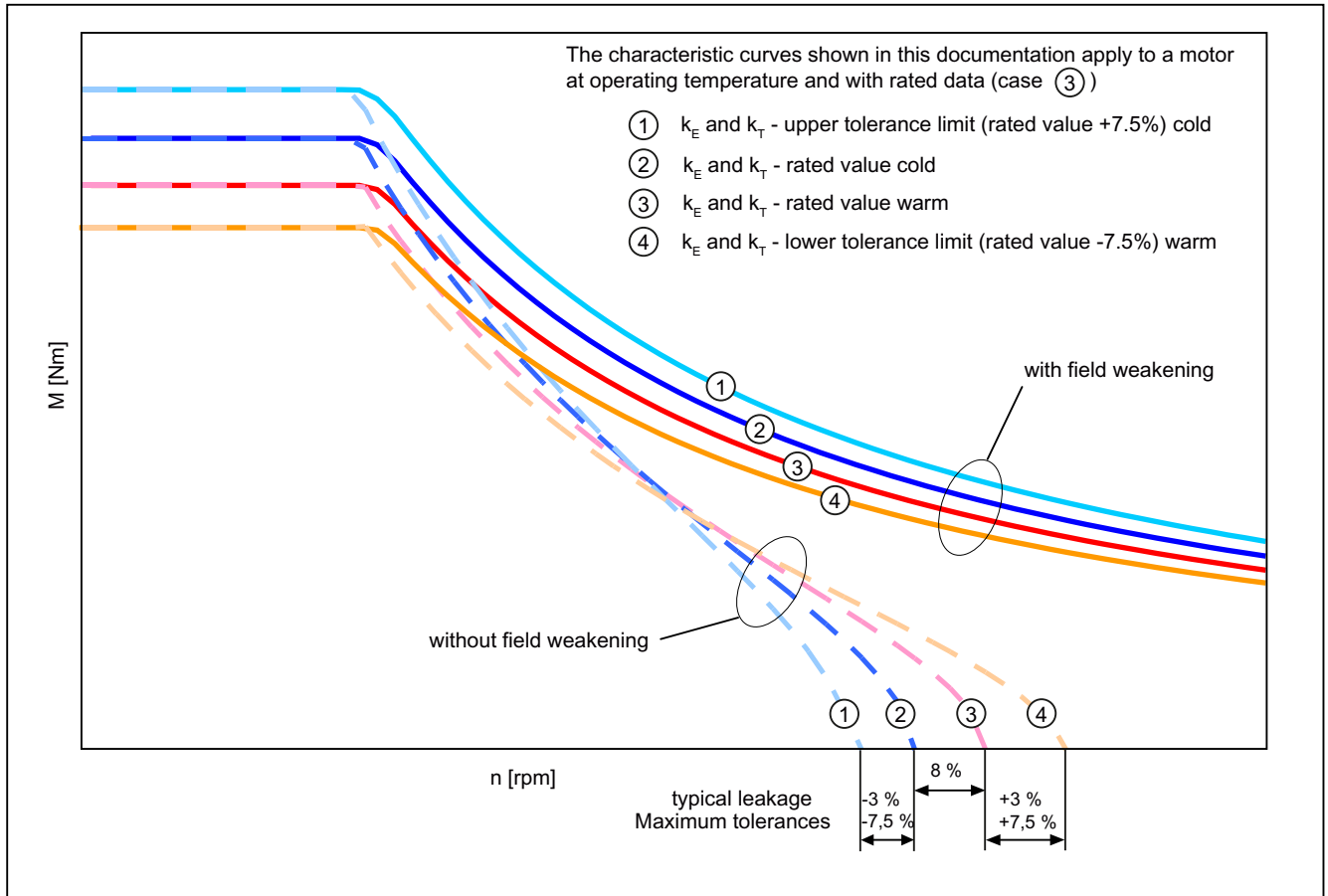

Figure 4-5 Effect of scatter

NOTICE

The motor temperature results in a clear displacement of the voltage limiting characteristic in the upper speed range. This must be taken into consideration during engineering (especially for applications in which the cold motor has to produce maximum speeds) with converter systems without field weakening.

4.2 Torque-speed characteristic

4.2 Torque-speed characteristic

The technical data of the relevant motor version are defined by rated operating points in the tables.

These rated operating points also correspond to the data stamped on the rating plate of the motor and to the data listed in the selection and ordering data sections of catalog PM 21 or NC 61.

4.2.1 1FK7 motors connected to SINAMICS S110 / S120 with a line voltage of 3-ph. 380 V to 480 V AC

4.2.1.1 1FK7 Compact

Table 4- 5 1FK7011 Compact

Technical data	Code	Unit	-5AK71
Configuration data			
Rated speed	n_N	rpm	6000
Rated torque (100 K)	$M_N (100 K)$	Nm	0.08
Rated current (100 K)	$I_N (100 K)$	A	0.85
Static torque (100 K)	$M_0 (100 K)$	Nm	0.18
Stall current (100 K)	$I_0 (100 K)$	A	1.5
Static torque (60 K)	$M_0 (60 K)$	Nm	0.15
Stall current (60 K)	$I_0 (60 K)$	A	1.2
Optimum operating point			
Optimum speed	n_{opt}	RPM	5000
Optimum power	P_{opt}	kW	0.06
Limit data			
Max. permissible speed (mech.)	$n_{max mech}$	rpm	8000
Maximum torque	M_{max}	Nm	0.5
Maximum current	I_{max}	A	4.2
Motor data			
Pole number	2p		8
Torque constant (100 K)	k_T	Nm/A	0.12
Voltage constant (at 20 °C)	k_E	V/1000 rpm	8.0
Winding resistance (at 20 °C)	R_{ph}	Ω	3.0
Rotating field inductance	L_D	mH	4.2
Electrical time constant	T_{el}	ms	1.4
Mechanical time constant	T_{mech}	ms	4
Thermal time constant	T_{th}	min	14
Moment of inertia	J_{Mot}	kgm ²	0.0064·10 ⁻³
Shaft torsional stiffness	C_t	Nm/rad	1400
Weight without brake	m_{Mot}	kg	0.9
Motor data with integrated brake			
Moment of inertia with brake	$J_{Mot Br}$	kgm ²	0.0083·10 ⁻³
Shaft torsional stiffness with brake	$C_t Br$	Nm/rad	1400
Weight with brake	$m_{Mot Br}$	kg	1.0

Technical data	Code	Unit	-5AK71
Recommended Motor Module 6SL312□-□TE13-0AA□			
Rated converter current	$I_{N Inv}$	A	3
Maximum converter current	$I_{max Inv}$	A	6
Max. torque at $I_{max Inv}$	$M_{max Inv}$	Nm	0.5
Maximum permissible speed (converter)	$n_{max Inv}$	rpm	8000

The rated data are valid for a 600 V DC link voltage.

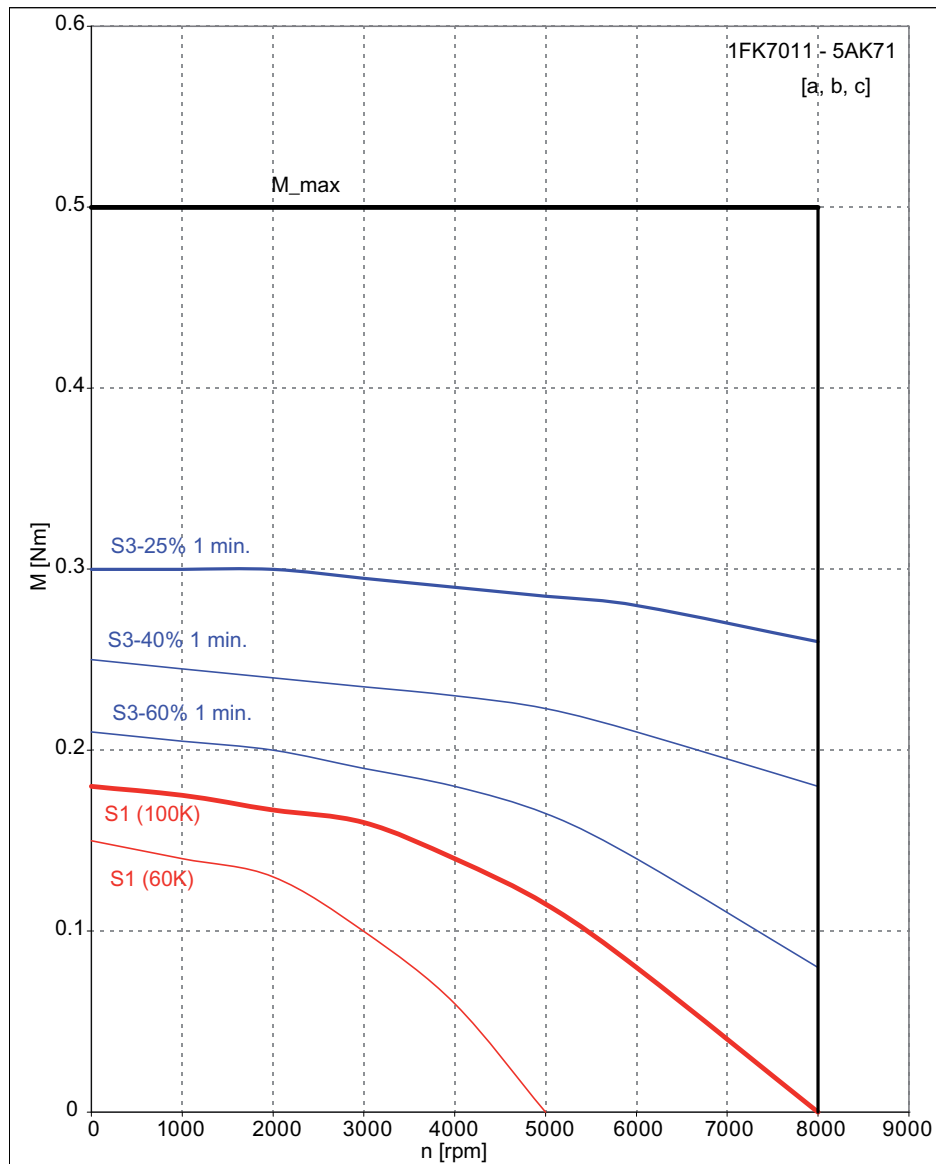

- [a] SINAMICS SLM 400 V
- [b] SINAMICS ALM 400 V
- [c] SINAMICS SLM 480 V

Figure 4-6 1FK7011-5AK71

4.2 Torque-speed characteristic

Table 4- 6 1FK7015 Compact

Technical data	Code	Unit	-5AK71
Configuration data			
Rated speed	n_N	rpm	6000
Rated torque (100 K)	$M_N (100\text{ K})$	Nm	0.16
Rated current (100 K)	$I_N (100\text{ K})$	A	0.85
Static torque (100 K)	$M_0 (100\text{ K})$	Nm	0.35
Stall current (100 K)	$I_0 (100\text{ K})$	A	1.5
Static torque (60 K)	$M_0 (60\text{ K})$	Nm	0.29
Stall current (60 K)	$I_0 (60\text{ K})$	A	1.2
Optimum operating point			
Optimum speed	n_{opt}	rpm	5000
Optimum power	P_{opt}	kW	0.12
Limit data			
Max. permissible speed (mech.)	$n_{max\ mech}$	rpm	8000
Maximum torque	M_{max}	Nm	1.0
Maximum current	I_{max}	A	4.2
Motor data			
Pole number	2p		8
Torque constant (100 K)	k_T	Nm/A	0.24
Voltage constant (at 20 °C)	k_E	V/1000 rpm	16.0
Winding resistance (at 20 °C)	R_{ph}	Ω	4.3
Rotating field inductance	L_D	mH	8.4
Electrical time constant	T_{el}	ms	2
Mechanical time constant	T_{mech}	ms	1.9
Thermal time constant	T_{th}	min	16
Moment of inertia	J_{Mot}	kgm ²	0.0083·10 ⁻³
Shaft torsional stiffness	C_t	Nm/rad	1300
Weight without brake	m_{Mot}	kg	1.1
Motor data with integrated brake			
Moment of inertia with brake	$J_{Mot\ Br}$	kgm ²	0.0102·10 ⁻³
Shaft torsional stiffness with brake	$C_t\ Br$	Nm/rad	1300
Weight with brake	$m_{Mot\ Br}$	kg	1.2
Recommended Motor Module 6SL312□-□TE13-0AA□			
Rated converter current	$I_{N\ Inv}$	A	3
Maximum converter current	$I_{max\ Inv}$	A	6
Max. torque at $I_{max\ Inv}$	$M_{max\ Inv}$	Nm	1.0
Maximum permissible speed (converter)	$n_{max\ Inv}$	rpm	8000

The rated data are valid for a 600 V DC link voltage.

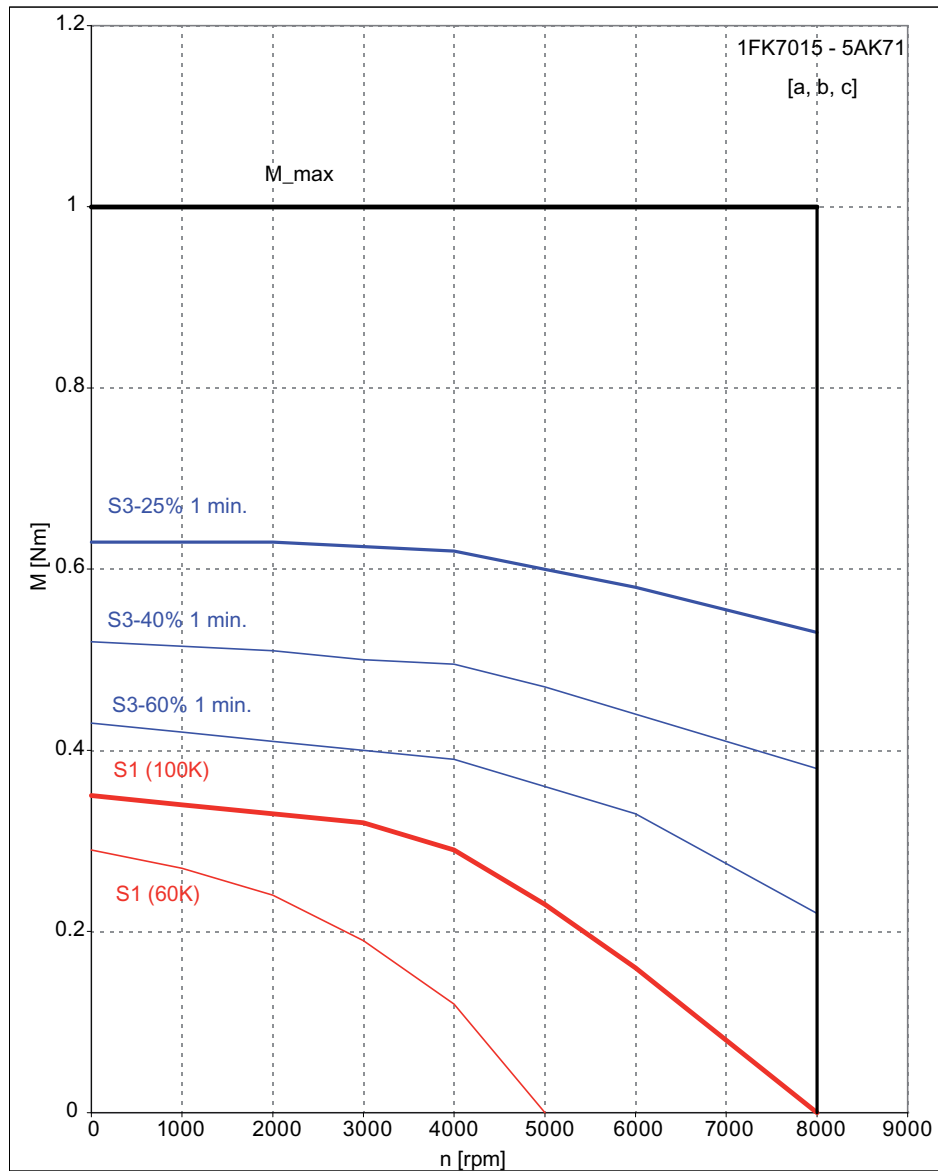

[a] SINAMICS SLM 400 V

[b] SINAMICS ALM 400 V

[c] SINAMICS SLM 480 V

Figure 4-7 1FK7015-5AK71

4.2 Torque-speed characteristic

Table 4- 7 1FK7022 Compact

Technical data	Code	Unit	-5AK71
Configuration data			
Rated speed	n_N	rpm	6000
Rated torque (100 K)	$M_N (100\text{ K})$	Nm	0.60
Rated current (100 K)	$I_N (100\text{ K})$	A	1.4
Static torque (100 K)	$M_0 (100\text{ K})$	Nm	0.85
Stall current (100 K)	$I_0 (100\text{ K})$	A	1.8
Static torque (60 K)	$M_0 (60\text{ K})$	Nm	0.70
Stall current (60 K)	$I_0 (60\text{ K})$	A	1.5
Optimum operating point			
Optimum speed	n_{opt}	rpm	6000
Optimum power	P_{opt}	kW	0.38
Limit data			
Max. permissible speed (mech.)	$n_{max\ mech}$	rpm	10000
Maximum torque	M_{max}	Nm	3.4
Maximum current	I_{max}	A	8.0
Motor data			
Pole number	2p		6
Torque constant (100 K)	k_T	Nm/A	0.46
Voltage constant (at 20 °C)	k_E	V/1000 rpm	29.0
Winding resistance (at 20 °C)	R_{ph}	Ω	4.2
Rotating field inductance	L_D	mH	9.1
Electrical time constant	T_{el}	ms	2.2
Mechanical time constant	T_{mech}	ms	1.7
Thermal time constant	T_{th}	min	18
Moment of inertia	J_{Mot}	kgm ²	0.028·10 ⁻³
Shaft torsional stiffness	C_t	Nm/rad	3000
Weight without brake	m_{Mot}	kg	1.8
Motor data with integrated brake			
Moment of inertia with brake	$J_{Mot\ Br}$	kgm ²	0.035·10 ⁻³
Shaft torsional stiffness with brake	$C_t\ Br$	Nm/rad	3000
Weight with brake	$m_{Mot\ Br}$	kg	2.0
Recommended Motor Module 6SL312□-□TE13-0AA□			
Rated converter current	$I_{N\ Inv}$	A	3
Maximum converter current	$I_{max\ Inv}$	A	6
Max. torque at $I_{max\ Inv}$	$M_{max\ Inv}$	Nm	2.65
Maximum permissible speed (converter)	$n_{max\ Inv}$	rpm	10000

The rated data are valid for a 600 V DC link voltage.

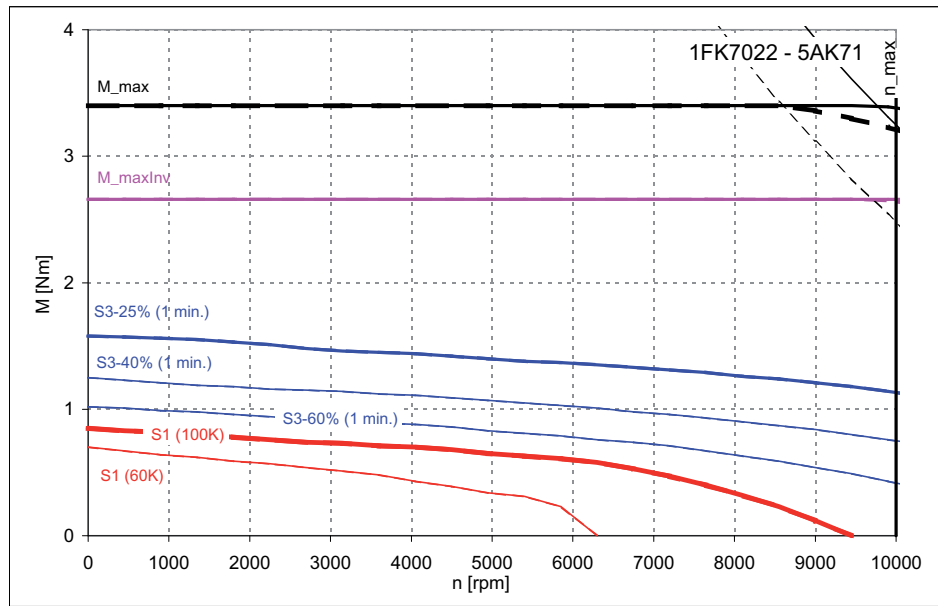

[—————] SINAMICS ALM 400 V-Netz (Zwischenkreisspannung 600 V DC) (DC-link voltage 600 V)
 [- - - - -] SINAMICS BLM/SLM 400 V-Netz (Zwischenkreisspannung 540 V DC) (DC-link voltage 540 V)

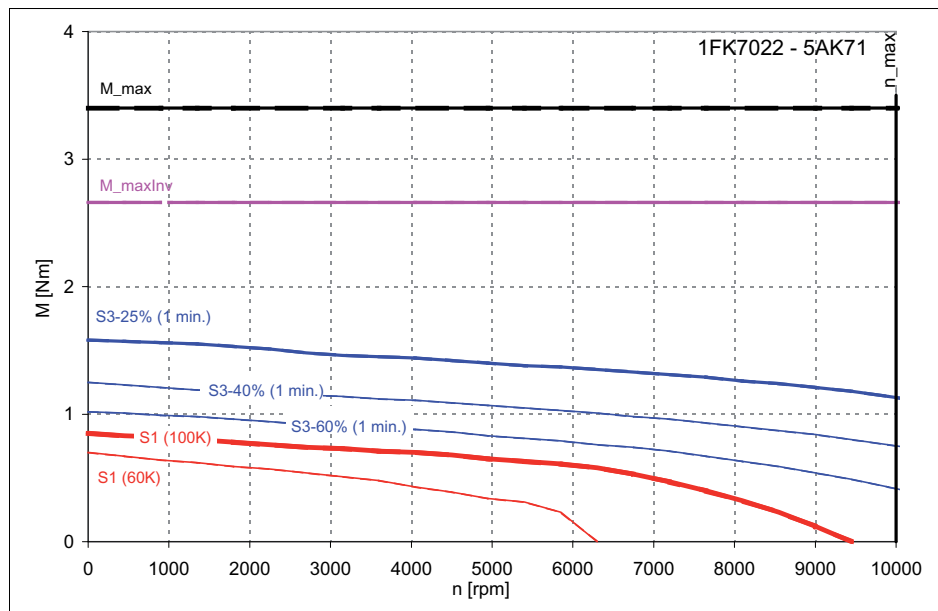

[—————] SINAMICS ALM 480 V-Netz (Zwischenkreisspannung 720 V DC) (DC-link voltage 720 V)
 [- - - - -] SINAMICS BLM/SLM 480 V-Netz (Zwischenkreisspannung 650 V DC) (DC-link voltage 650 V)

Figure 4-8 1FK7022-5AK71

4.2 Torque-speed characteristic

Table 4- 8 1FK7032 Compact

Technical data	Code	Unit	-2AK71
Configuration data			
Rated speed	n_N	rpm	6000
Rated torque (100 K)	$M_N (100\text{ K})$	Nm	0.8
Rated current (100 K)	$I_N (100\text{ K})$	A	1.3
Static torque (100 K)	$M_0 (100\text{ K})$	Nm	1.15
Stall current (100 K)	$I_0 (100\text{ K})$	A	1.7
Static torque (60 K)	$M_0 (60\text{ K})$	Nm	0.95
Stall current (60 K)	$I_0 (60\text{ K})$	A	1.4
Optimum operating point			
Optimum speed	n_{opt}	rpm	6000
Optimum power	P_{opt}	kW	0.5
Limit data			
Max. permissible speed (mech.)	$n_{max\ mech}$	rpm	10000
Maximum torque	M_{max}	Nm	4.5
Maximum current	I_{max}	A	7.0
Motor data			
Pole number	2p		6
Torque constant (100 K)	k_T	Nm/A	0.67
Voltage constant (at 20 °C)	k_E	V/1000 rpm	45.0
Winding resistance (at 20 °C)	R_{ph}	Ω	5.05
Rotating field inductance	L_D	mH	17.3
Electrical time constant	T_{el}	ms	3.45
Mechanical time constant	T_{mech}	ms	2.20
Thermal time constant	T_{th}	min	25
Moment of inertia	J_{Mot}	kgm ²	0.065·10 ⁻³
Shaft torsional stiffness	C_t	Nm/rad	6000
Weight without brake	m_{Mot}	kg	2.7
Motor data with integrated brake			
Moment of inertia with brake	$J_{Mot\ Br}$	kgm ²	0.075·10 ⁻³
Shaft torsional stiffness with brake	$C_t\ Br$	Nm/rad	4100
Weight with brake	$m_{Mot\ Br}$	kg	3.1
Recommended Motor Module 6SL312□-□TE13-0AA□			
Rated converter current	$I_{N\ Inv}$	A	3
Maximum converter current	$I_{max\ Inv}$	A	6
Max. torque at $I_{max\ Inv}$	$M_{max\ Inv}$	Nm	4.15
Maximum permissible speed (converter)	$n_{max\ Inv}$	rpm	10000

The rated data are valid for a 600 V DC link voltage.

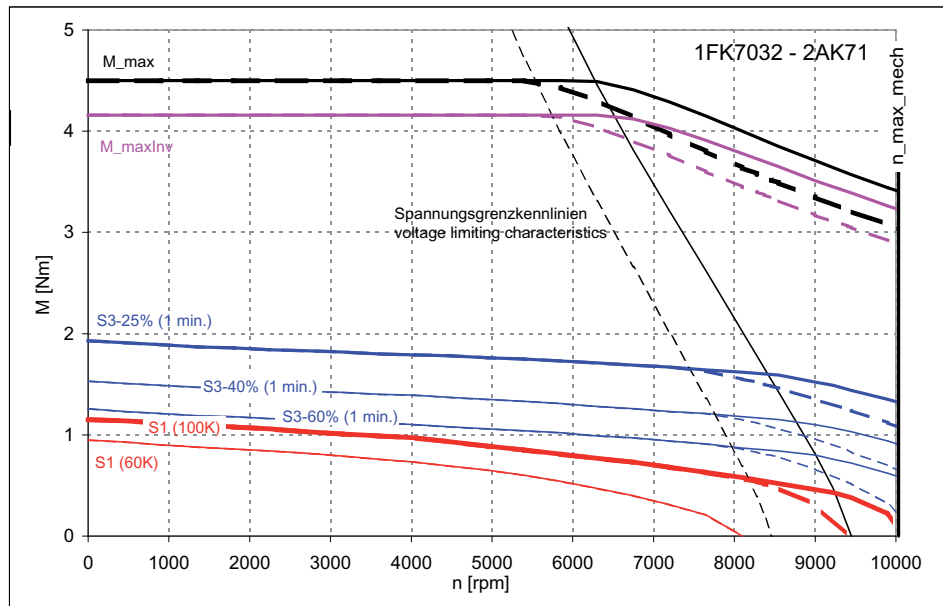

[————] SINAMICS ALM 400 V-Netz (Zwischenkreisspannung 600 V DC) (DC-link voltage 600 V)

[-----] SINAMICS BLM/SLM 400 V-Netz (Zwischenkreisspannung 540 V DC) (DC-link voltage 540 V)

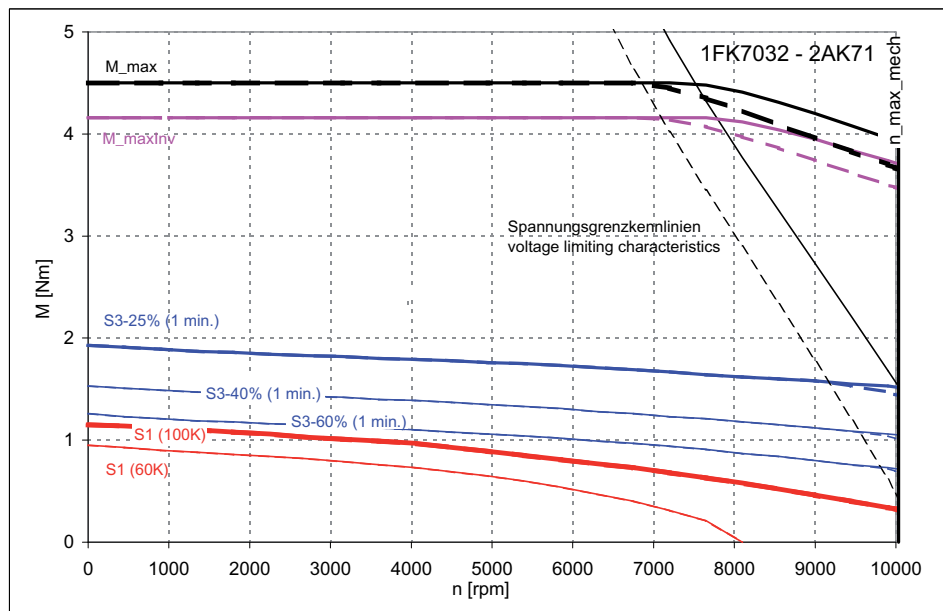

[————] SINAMICS ALM 480 V-Netz (Zwischenkreisspannung 720 V DC) (DC-link voltage 720 V)

[-----] SINAMICS BLM/SLM 480 V-Netz (Zwischenkreisspannung 650 V DC) (DC-link voltage 650 V)

Figure 4-9 1FK7032-2AK71

4.2 Torque-speed characteristic

Table 4- 9 1FK7034 Compact

Technical data	Code	Unit	-2AK71
Configuration data			
Rated speed	n_N	rpm	6000
Rated torque (100 K)	$M_N (100\text{ K})$	Nm	1.0
Rated current (100 K)	$I_N (100\text{ K})$	A	1.3
Static torque (100 K)	$M_0 (100\text{ K})$	Nm	1.6
Stall current (100 K)	$I_0 (100\text{ K})$	A	1.9
Static torque (60 K)	$M_0 (60\text{ K})$	Nm	1.35
Stall current (60 K)	$I_0 (60\text{ K})$	A	1.55
Optimum operating point			
Optimum speed	n_{opt}	rpm	6000
Optimum power	P_{opt}	kW	0.63
Limit data			
Max. permissible speed (mech.)	$n_{max\ mech}$	rpm	10000
Maximum torque	M_{max}	Nm	6.5
Maximum current	I_{max}	A	8.0
Motor data			
Pole number	2p		6
Torque constant (100 K)	k_T	Nm/A	0.84
Voltage constant (at 20 °C)	k_E	V/1000 rpm	55.0
Winding resistance (at 20 °C)	R_{ph}	Ω	4.46
Rotating field inductance	L_D	mH	17.2
Electrical time constant	T_{el}	ms	3.85
Mechanical time constant	T_{mech}	ms	1.71
Thermal time constant	T_{th}	min	30
Moment of inertia	J_{Mot}	kgm ²	$0.09 \cdot 10^{-3}$
Shaft torsional stiffness	C_t	Nm/rad	5300
Weight without brake	m_{Mot}	kg	3.5
Motor data with integrated brake			
Moment of inertia with brake	$J_{Mot\ Br}$	kgm ²	$0.10 \cdot 10^{-3}$
Shaft torsional stiffness with brake	$C_t\ Br$	Nm/rad	3750
Weight with brake	$m_{Mot\ Br}$	kg	3.9
Recommended Motor Module 6SL312□-□TE13-0AA□			
Rated converter current	$I_{N\ Inv}$	A	3
Maximum converter current	$I_{max\ Inv}$	A	6
Max. torque at $I_{max\ Inv}$	$M_{max\ Inv}$	Nm	4.95
Maximum permissible speed (converter)	$n_{max\ Inv}$	rpm	10000

The rated data are valid for a 600 V DC link voltage.

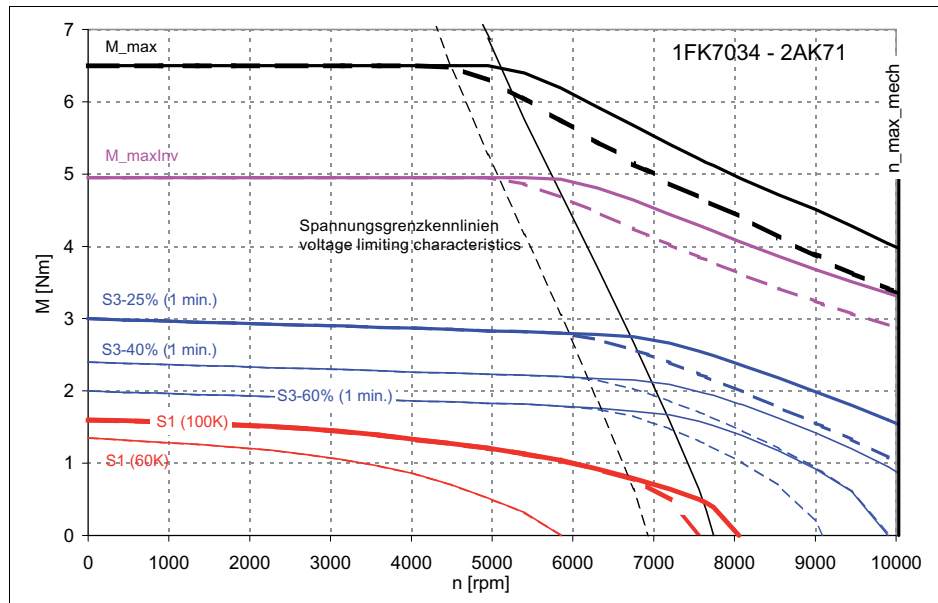

[————] SINAMICS ALM 400 V-Netz (Zwischenkreisspannung 600 V DC) (DC-link voltage 600 V)

[-----] SINAMICS BLM/SLM 400 V-Netz (Zwischenkreisspannung 540 V DC) (DC-link voltage 540 V)

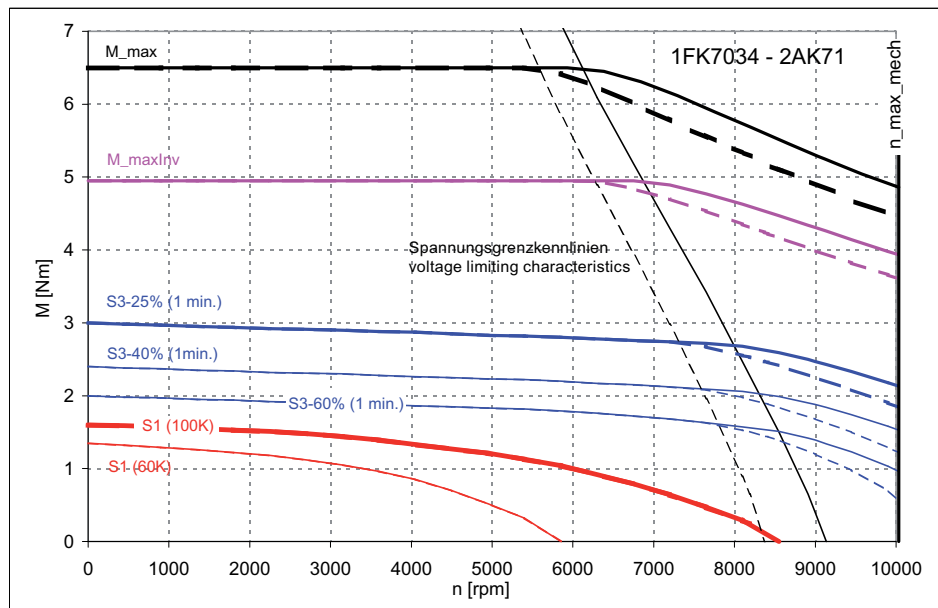

[————] SINAMICS ALM 480 V-Netz (Zwischenkreisspannung 720 V DC) (DC-link voltage 720 V)

[-----] SINAMICS BLM/SLM 480 V-Netz (Zwischenkreisspannung 650 V DC) (DC-link voltage 650 V)

Figure 4-10 1FK7034-2AK71

4.2 Torque-speed characteristic

Table 4- 10 1FK7040 Compact

Technical data	Code	Unit	-2AK71
Configuration data			
Rated speed	n_N	rpm	6000
Rated torque (100 K)	$M_N (100\text{ K})$	Nm	1.1
Rated current (100 K)	$I_N (100\text{ K})$	A	1.85
Static torque (100 K)	$M_0 (100\text{ K})$	Nm	1.6
Stall current (100 K)	$I_0 (100\text{ K})$	A	2.35
Static torque (60 K)	$M_0 (60\text{ K})$	Nm	1.3
Stall current (60 K)	$I_0 (60\text{ K})$	A	1.9
Optimum operating point			
Optimum speed	n_{opt}	rpm	6000
Optimum power	P_{opt}	kW	0.69
Limit data			
Max. permissible speed (mech.)	$n_{max\ mech}$	rpm	9000
Maximum torque	M_{max}	Nm	5.1
Maximum current	I_{max}	A	7.7
Motor data			
Pole number	2p		8
Torque constant (100 K)	k_T	Nm/A	0.68
Voltage constant (at 20 °C)	k_E	V/1000 rpm	43.4
Winding resistance (at 20 °C)	R_{ph}	Ω	2.87
Rotating field inductance	L_D	mH	16.5
Electrical time constant	T_{el}	ms	5.7
Mechanical time constant	T_{mech}	ms	3.0
Thermal time constant	T_{th}	min	25
Moment of inertia	J_{Mot}	kgm ²	$0.16 \cdot 10^{-3}$
Shaft torsional stiffness	C_t	Nm/rad	18700
Weight without brake	m_{Mot}	kg	3.2
Motor data with integrated brake			
Moment of inertia with brake	$J_{Mot\ Br}$	kgm ²	$0.192 \cdot 10^{-3}$
Shaft torsional stiffness with brake	$C_t\ Br$	Nm/rad	13000
Weight with brake	$m_{Mot\ Br}$	kg	3.9
Recommended Motor Module 6SL312□-□TE13-0AA□			
Rated converter current	$I_{N\ Inv}$	A	3
Maximum converter current	$I_{max\ Inv}$	A	6
Max. torque at $I_{max\ Inv}$	$M_{max\ Inv}$	Nm	4.0
Maximum permissible speed (converter)	$n_{max\ Inv}$	rpm	9000

The rated data are valid for a 600 V DC link voltage.

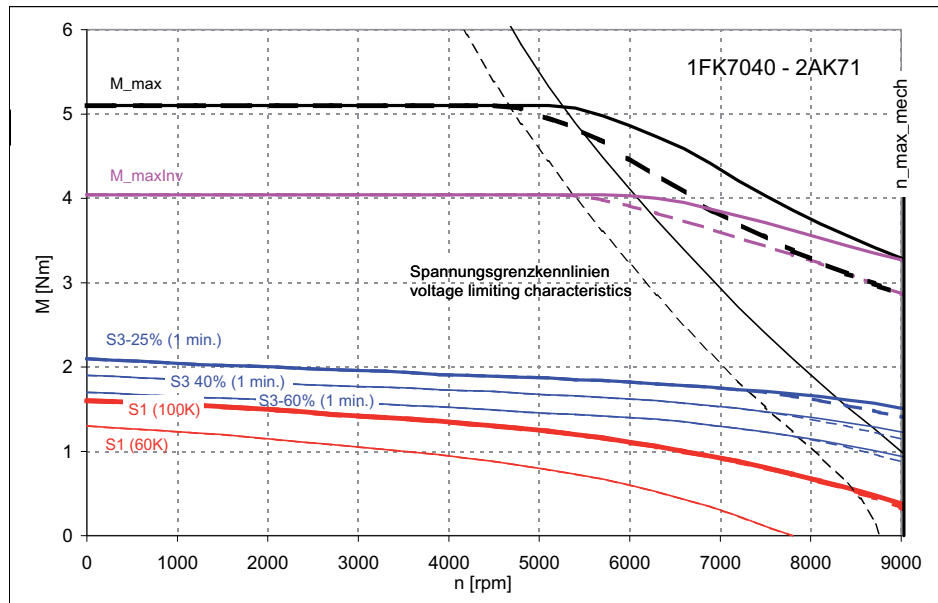

[—————] SINAMICS ALM 400 V-Netz (Zwischenkreisspannung 600 V DC) (DC-link voltage 600 V)

[- - - - -] SINAMICS BLM/SLM 400 V-Netz (Zwischenkreisspannung 540 V DC) (DC-link voltage 540 V)

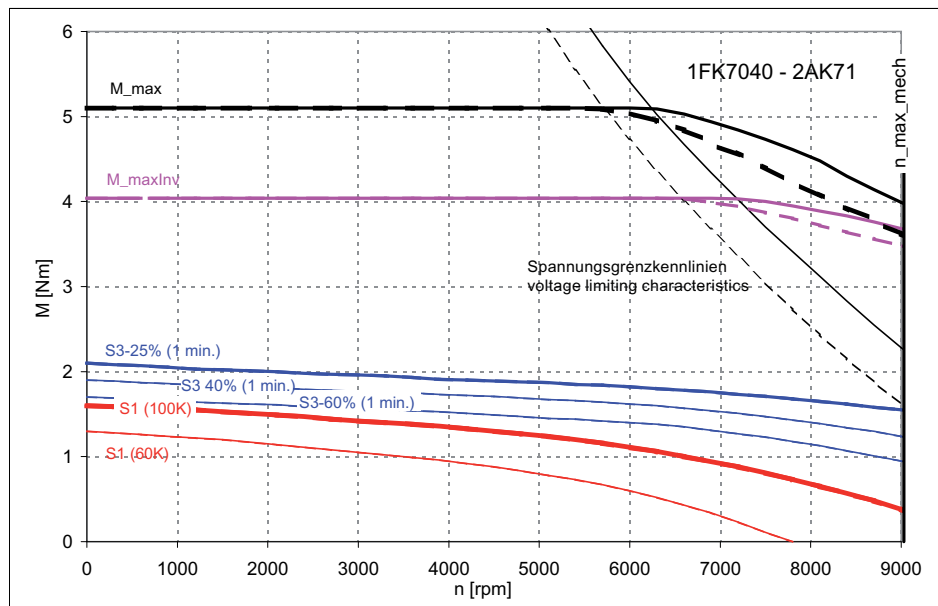

[—————] SINAMICS ALM 480 V-Netz (Zwischenkreisspannung 720 V DC) (DC-link voltage 720 V)

[- - - - -] SINAMICS BLM/SLM 480 V-Netz (Zwischenkreisspannung 650 V DC) (DC-link voltage 650 V)

Figure 4-11 1FK7040-2AK71

4.2 Torque-speed characteristic

Table 4- 11 1FK7042 Compact

Technical data	Code	Unit	-2AC71
Configuration data			
Rated speed	n_N	rpm	2000
Rated torque (100 K)	$M_N (100\text{ K})$	Nm	2.8
Rated current (100 K)	$I_N (100\text{ K})$	A	1.55
Static torque (100 K)	$M_0 (100\text{ K})$	Nm	3.0
Stall current (100 K)	$I_0 (100\text{ K})$	A	1.6
Static torque (60 K)	$M_0 (60\text{ K})$	Nm	2.5
Stall current (60 K)	$I_0 (60\text{ K})$	A	1.3
Optimum operating point			
Optimum speed	n_{opt}	rpm	2000
Optimum power	P_{opt}	kW	0.59
Limit data			
Max. permissible speed (mech.)	$n_{max\ mech}$	rpm	9000
Maximum torque	M_{max}	Nm	10.5
Maximum current	I_{max}	A	5.6
Motor data			
Pole number	2p		8
Torque constant (100 K)	k_T	Nm/A	1.865
Voltage constant (at 20 °C)	k_E	V/1000 rpm	122.0
Winding resistance (at 20 °C)	R_{ph}	Ω	8.6
Rotating field inductance	L_D	mH	64
Electrical time constant	T_{el}	ms	7.4
Mechanical time constant	T_{mech}	ms	2.15
Thermal time constant	T_{th}	min	30
Moment of inertia	J_{Mot}	kgm ²	$0.29 \cdot 10^{-3}$
Shaft torsional stiffness	C_t	Nm/rad	15500
Weight without brake	m_{Mot}	kg	4.6
Motor data with integrated brake			
Moment of inertia with brake	$J_{Mot\ Br}$	kgm ²	$0.32 \cdot 10^{-3}$
Shaft torsional stiffness with brake	$C_t\ Br$	Nm/rad	11400
Weight with brake	$m_{Mot\ Br}$	kg	5.3
Recommended Motor Module 6SL312□-□TE13-0AA□			
Rated converter current	$I_{N\ Inv}$	A	3
Maximum converter current	$I_{max\ Inv}$	A	6
Max. torque at $I_{max\ Inv}$	$M_{max\ Inv}$	Nm	10.5
Maximum permissible speed (converter)	$n_{max\ Inv}$	rpm	4750

The rated data are valid for a 600 V DC link voltage.

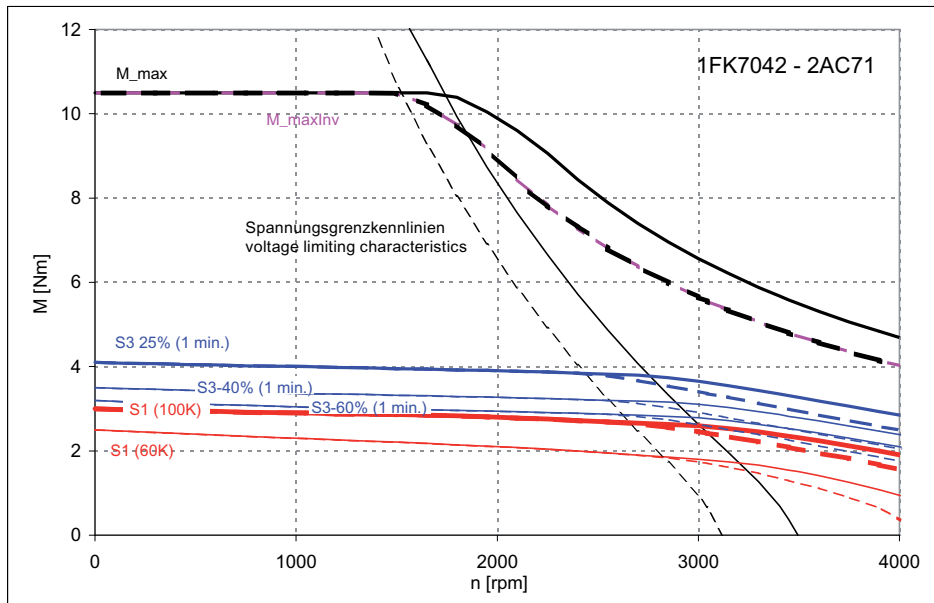

[—————] SINAMICS ALM 400 V-Netz (Zwischenkreisspannung 600 V DC) (DC-link voltage 600 V)

[- - - - -] SINAMICS BLM/SLM 400 V-Netz (Zwischenkreisspannung 540 V DC) (DC-link voltage 540 V)

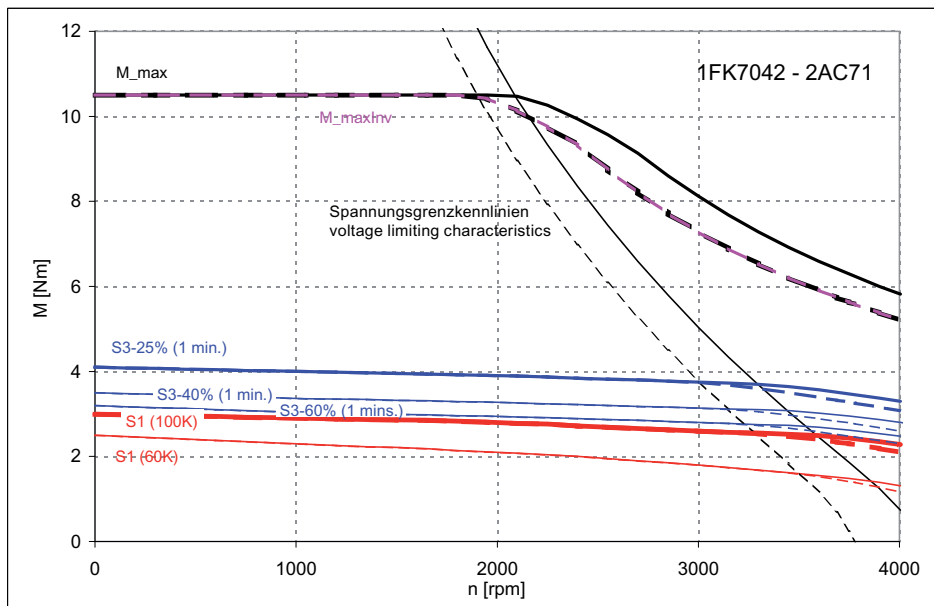

[—————] SINAMICS ALM 480 V-Netz (Zwischenkreisspannung 720 V DC) (DC-link voltage 720 V)

[- - - - -] SINAMICS BLM/SLM 480 V-Netz (Zwischenkreisspannung 650 V DC) (DC-link voltage 650 V)

Figure 4-12 1FK7042-2AC71

4.2 Torque-speed characteristic

Table 4- 12 1FK7042 Compact

Technical data	Code	Unit	-2AF71
Configuration data			
Rated speed	n_N	rpm	3000
Rated torque (100 K)	$M_N (100\text{ K})$	Nm	2.6
Rated current (100 K)	$I_N (100\text{ K})$	A	2.0
Static torque (100 K)	$M_0 (100\text{ K})$	Nm	3.0
Stall current (100 K)	$I_0 (100\text{ K})$	A	2.2
Static torque (60 K)	$M_0 (60\text{ K})$	Nm	2.5
Stall current (60 K)	$I_0 (60\text{ K})$	A	1.8
Optimum operating point			
Optimum speed	n_{opt}	rpm	3000
Optimum power	P_{opt}	kW	0.82
Limit data			
Max. permissible speed (mech.)	$n_{max\ mech}$	rpm	9000
Maximum torque	M_{max}	Nm	10.5
Maximum current	I_{max}	A	7.6
Motor data			
Pole number	2p		8
Torque constant (100 K)	k_T	Nm/A	1.375
Voltage constant (at 20 °C)	k_E	V/1000 rpm	90.0
Winding resistance (at 20 °C)	R_{ph}	Ω	4.67
Rotating field inductance	L_D	mH	35.0
Electrical time constant	T_{el}	ms	7.5
Mechanical time constant	T_{mech}	ms	2.15
Thermal time constant	T_{th}	min	30
Moment of inertia	J_{Mot}	kgm ²	$0.29 \cdot 10^{-3}$
Shaft torsional stiffness	C_t	Nm/rad	15500
Weight without brake	m_{Mot}	kg	4.6
Motor data with integrated brake			
Moment of inertia with brake	$J_{Mot\ Br}$	kgm ²	$0.32 \cdot 10^{-3}$
Shaft torsional stiffness	C_t	Nm/rad	11400
Weight with brake	$m_{Mot\ Br}$	kg	5.3
Recommended Motor Module 6SL312□-□TE13-0AA□			
Rated converter current	$I_{N\ Inv}$	A	3
Maximum converter current	$I_{max\ Inv}$	A	6
Max. torque at $I_{max\ Inv}$	$M_{max\ Inv}$	Nm	8.2
Maximum permissible speed (converter)	$n_{max\ Inv}$	rpm	6400

The rated data are valid for a 600 V DC link voltage.

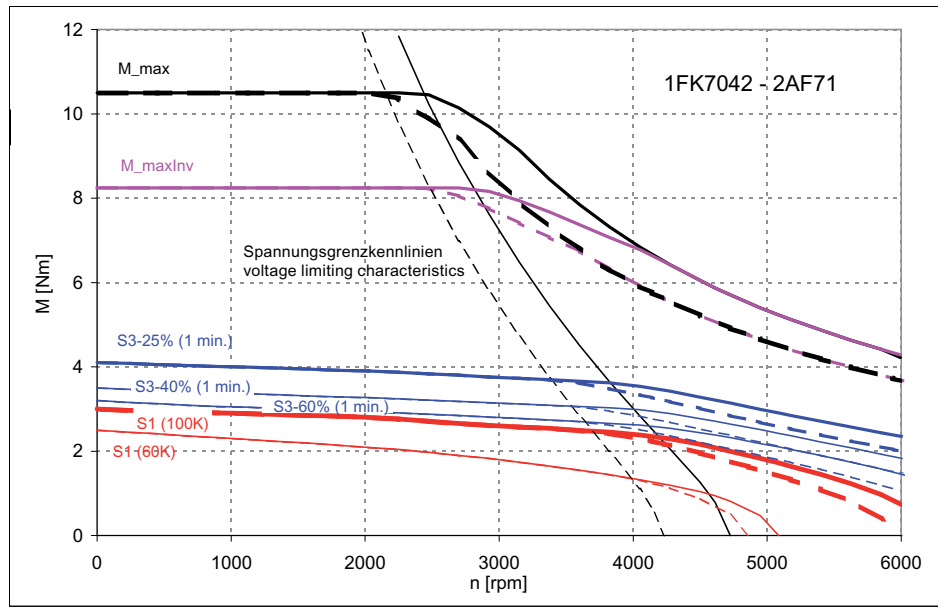

[—————] SINAMICS ALM 400 V-Netz (Zwischenkreisspannung 600 V DC) (DC-link voltage 600 V)
 [- - - - -] SINAMICS BLM/SLM 400 V-Netz (Zwischenkreisspannung 540 V DC) (DC-link voltage 540 V)

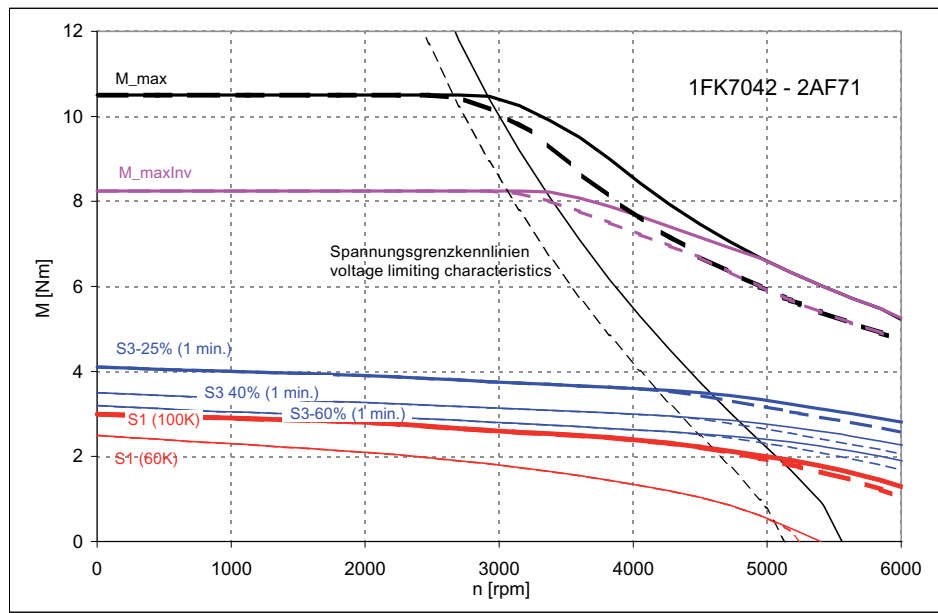

[—————] SINAMICS ALM 480 V-Netz (Zwischenkreisspannung 720 V DC) (DC-link voltage 720 V)
 [- - - - -] SINAMICS BLM/SLM 480 V-Netz (Zwischenkreisspannung 650 V DC) (DC-link voltage 650 V)

Figure 4-13 1FK7042-2AF71

4.2 Torque-speed characteristic

Table 4- 13 1FK7042 Compact

Technical data	Code	Unit	-2AK71
Configuration data			
Rated speed	n_N	rpm	6000
Rated torque (100 K)	$M_N (100\text{ K})$	Nm	1.5
Rated current (100 K)	$I_N (100\text{ K})$	A	2.5
Static torque (100 K)	$M_0 (100\text{ K})$	Nm	3.0
Stall current (100 K)	$I_0 (100\text{ K})$	A	4.4
Static torque (60 K)	$M_0 (60\text{ K})$	Nm	2.5
Stall current (60 K)	$I_0 (60\text{ K})$	A	3.55
Optimum operating point			
Optimum speed	n_{opt}	rpm	5000
Optimum power	P_{opt}	kW	1.02
Limit data			
Max. permissible speed (mech.)	$n_{max\ mech}$	rpm	9000
Maximum torque	M_{max}	Nm	10.5
Maximum current	I_{max}	A	15.3
Motor data			
Pole number	2p		8
Torque constant (100 K)	k_T	Nm/A	0.68
Voltage constant (at 20 °C)	k_E	V/1000 rpm	44.5
Winding resistance (at 20 °C)	R_{ph}	Ω	1.145
Rotating field inductance	L_D	mH	8.6
Electrical time constant	T_{el}	ms	7.5
Mechanical time constant	T_{mech}	ms	2.15
Thermal time constant	T_{th}	min	30
Moment of inertia	J_{Mot}	kgm ²	$0.29 \cdot 10^{-3}$
Shaft torsional stiffness	C_t	Nm/rad	15500
Weight without brake	m_{Mot}	kg	4.6
Motor data with integrated brake			
Moment of inertia with brake	$J_{Mot\ Br}$	kgm ²	$0.32 \cdot 10^{-3}$
Shaft torsional stiffness with brake	$C_t\ Br$	Nm/rad	11400
Weight with brake	$m_{Mot\ Br}$	kg	5.3
Recommended Motor Module 6SL312□-□TE13-0AA□			
Rated converter current	$I_{N\ Inv}$	A	5
Maximum converter current	$I_{max\ Inv}$	A	10
Max. torque at $I_{max\ Inv}$	$M_{max\ Inv}$	Nm	6.8
Maximum permissible speed (converter)	$n_{max\ Inv}$	rpm	9000

The rated data are valid for a 600 V DC link voltage.

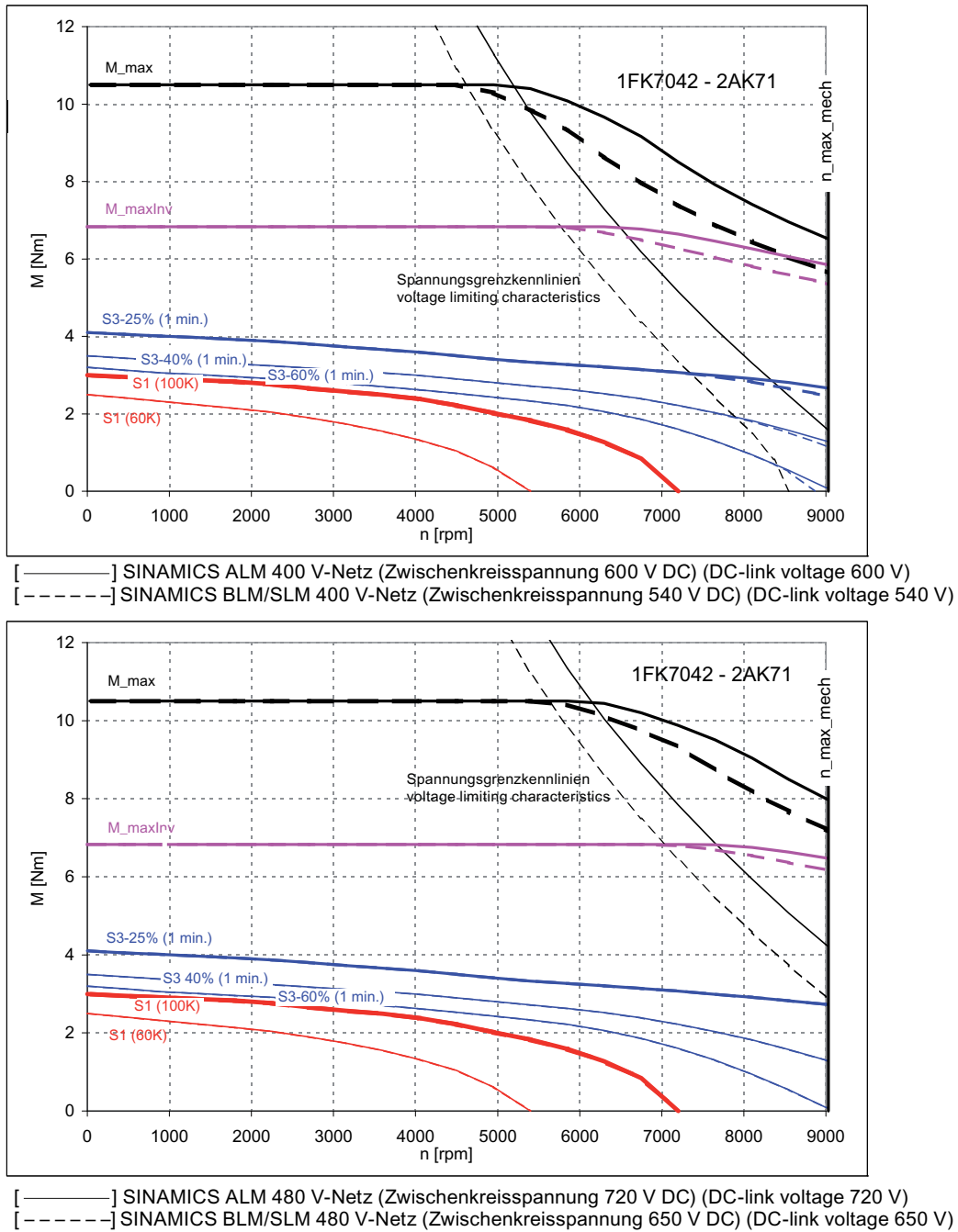

Figure 4-14 1FK7042-2AK71

4.2 Torque-speed characteristic

Table 4- 14 1FK7060 Compact

Technical data	Code	Unit	-2AC71
Configuration data			
Rated speed	n_N	rpm	2000
Rated torque (100 K)	$M_N (100\text{ K})$	Nm	5.3
Rated current (100 K)	$I_N (100\text{ K})$	A	2.95
Static torque (100 K)	$M_0 (100\text{ K})$	Nm	6.0
Stall current (100 K)	$I_0 (100\text{ K})$	A	3.15
Static torque (60 K)	$M_0 (60\text{ K})$	Nm	5.0
Stall current (60 K)	$I_0 (60\text{ K})$	A	2.55
Optimum operating point			
Optimum speed	n_{opt}	rpm	2000
Optimum power	P_{opt}	kW	1.11
Limit data			
Max. permissible speed (mech.)	$n_{max\ mech}$	rpm	7200
Maximum torque	M_{max}	Nm	18.0
Maximum current	I_{max}	A	10.7
Motor data			
Pole number	2p		8
Torque constant (100 K)	k_T	Nm/A	1.905
Voltage constant (at 20 °C)	k_E	V/1000 rpm	121.0
Winding resistance (at 20 °C)	R_{ph}	Ω	2.75
Rotating field inductance	L_D	mH	30.5
Electrical time constant	T_{el}	ms	11.1
Mechanical time constant	T_{mech}	ms	1.75
Thermal time constant	T_{th}	min	30
Moment of inertia	J_{Mot}	kgm ²	$0.77 \cdot 10^{-3}$
Shaft torsional stiffness	C_t	Nm/rad	40500
Weight without brake	m_{Mot}	kg	7.1
Motor data with integrated brake			
Moment of inertia with brake	$J_{Mot\ Br}$	kgm ²	$0.87 \cdot 10^{-3}$
Shaft torsional stiffness with brake	$C_t\ Br$	Nm/rad	28500
Weight with brake	$m_{Mot\ Br}$	kg	8.5
Recommended Motor Module 6SL312□-□TE13-0AA□			
Rated converter current	$I_{N\ Inv}$	A	3
Maximum converter current	$I_{max\ Inv}$	A	6
Max. torque at $I_{max\ Inv}$	$M_{max\ Inv}$	Nm	11.4
Maximum permissible speed (converter)	$n_{max\ Inv}$	rpm	4750

The rated data are valid for a 600 V DC link voltage.

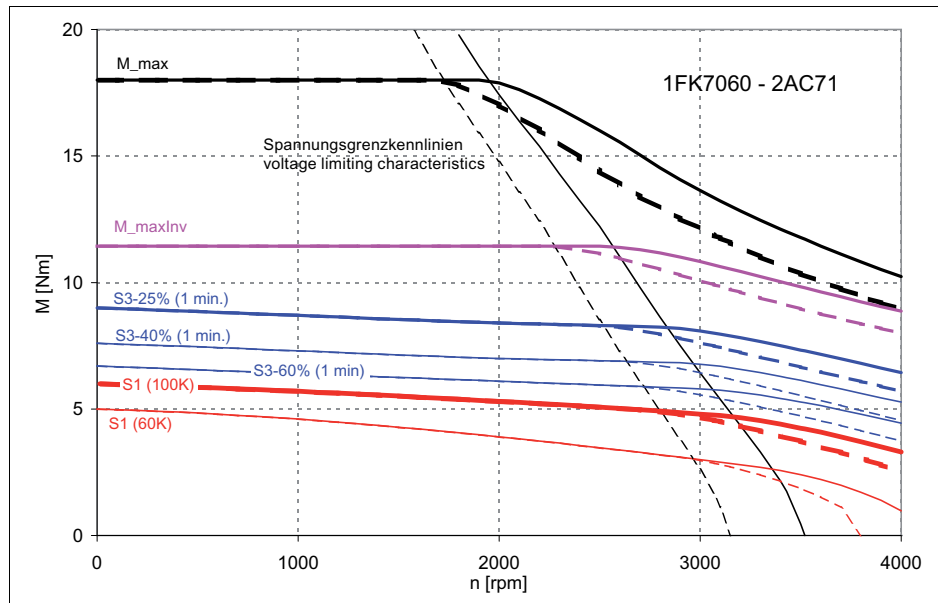

[—————] SINAMICS ALM 400 V-Netz (Zwischenkreisspannung 600 V DC) (DC-link voltage 600 V)
 [- - - - -] SINAMICS BLM/SLM 400 V-Netz (Zwischenkreisspannung 540 V DC) (DC-link voltage 540 V)

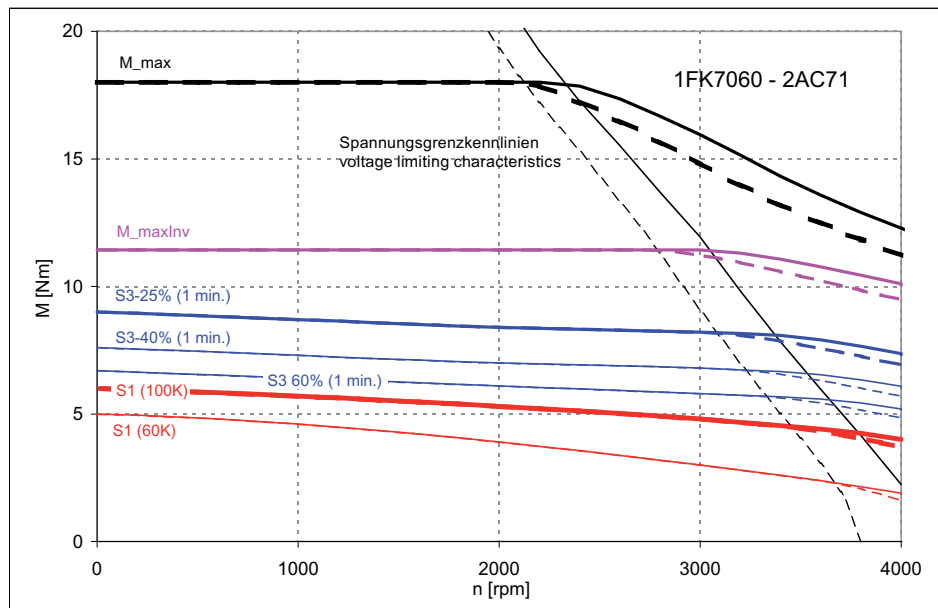

[—————] SINAMICS ALM 480 V-Netz (Zwischenkreisspannung 720 V DC) (DC-link voltage 720 V)
 [- - - - -] SINAMICS BLM/SLM 480 V-Netz (Zwischenkreisspannung 650 V DC) (DC-link voltage 650 V)

Figure 4-15 1FK7060-2AC71

4.2 Torque-speed characteristic

Table 4- 15 1FK7060 Compact

Technical data	Code	Unit	-2AF71
Configuration data			
Rated speed	n_N	rpm	3000
Rated torque (100 K)	$M_N (100\text{ K})$	Nm	4.7
Rated current (100 K)	$I_N (100\text{ K})$	A	3.7
Static torque (100 K)	$M_0 (100\text{ K})$	Nm	6.0
Stall current (100 K)	$I_0 (100\text{ K})$	A	4.45
Static torque (60 K)	$M_0 (60\text{ K})$	Nm	5.0
Stall current (60 K)	$I_0 (60\text{ K})$	A	3.6
Optimum operating point			
Optimum speed	n_{opt}	rpm	3000
Optimum power	P_{opt}	kW	1.48
Limit data			
Max. permissible speed (mech.)	$n_{max\ mech}$	rpm	7200
Maximum torque	M_{max}	Nm	18.0
Maximum current	I_{max}	A	15.0
Motor data			
Pole number	2p		8
Torque constant (100 K)	k_T	Nm/A	1.33
Voltage constant (at 20 °C)	k_E	V/1000 rpm	85.5
Winding resistance (at 20 °C)	R_{ph}	Ω	1.35
Rotating field inductance	L_D	mH	15.2
Electrical time constant	T_{el}	ms	11.3
Mechanical time constant	T_{mech}	ms	1.71
Thermal time constant	T_{th}	min	30
Moment of inertia	J_{Mot}	kgm ²	$0.77 \cdot 10^{-3}$
Shaft torsional stiffness	C_t	Nm/rad	40500
Weight without brake	m_{Mot}	kg	7.1
Motor data with integrated brake			
Moment of inertia with brake	$J_{Mot\ Br}$	kgm ²	$0.87 \cdot 10^{-3}$
Shaft torsional stiffness with brake	$C_t\ Br$	Nm/rad	28500
Weight with brake	$m_{Mot\ Br}$	kg	8.5
Recommended Motor Module 6SL312□-□TE15-0AA□			
Rated converter current	$I_{N\ Inv}$	A	5
Maximum converter current	$I_{max\ Inv}$	A	10
Max. torque at $I_{max\ Inv}$	$M_{max\ Inv}$	Nm	13.2
Maximum permissible speed (converter)	$n_{max\ Inv}$	rpm	6700

The rated data are valid for a 600 V DC link voltage.

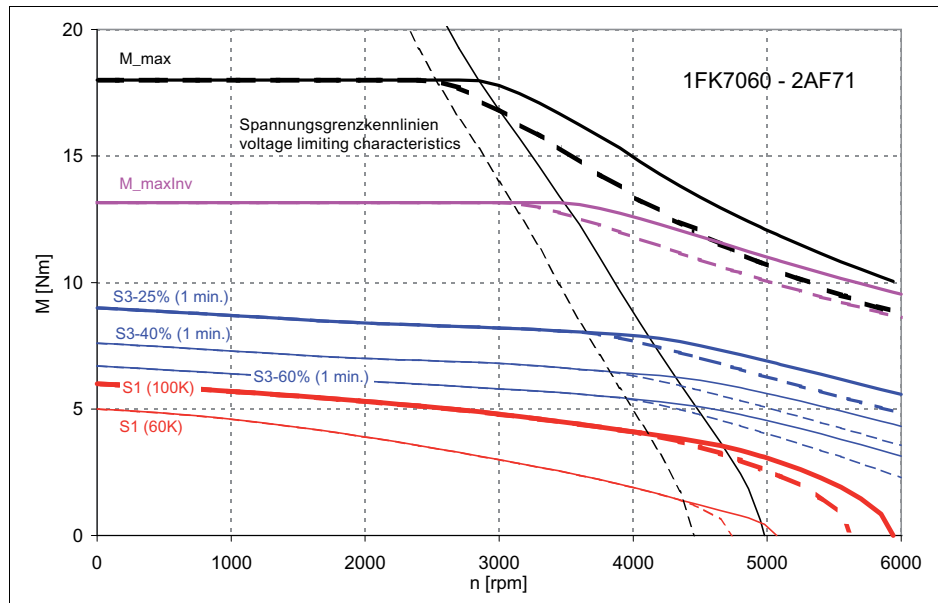

[—————] SINAMICS ALM 400 V-Netz (Zwischenkreisspannung 600 V DC) (DC-link voltage 600 V)

[- - - - -] SINAMICS BLM/SLM 400 V-Netz (Zwischenkreisspannung 540 V DC) (DC-link voltage 540 V)

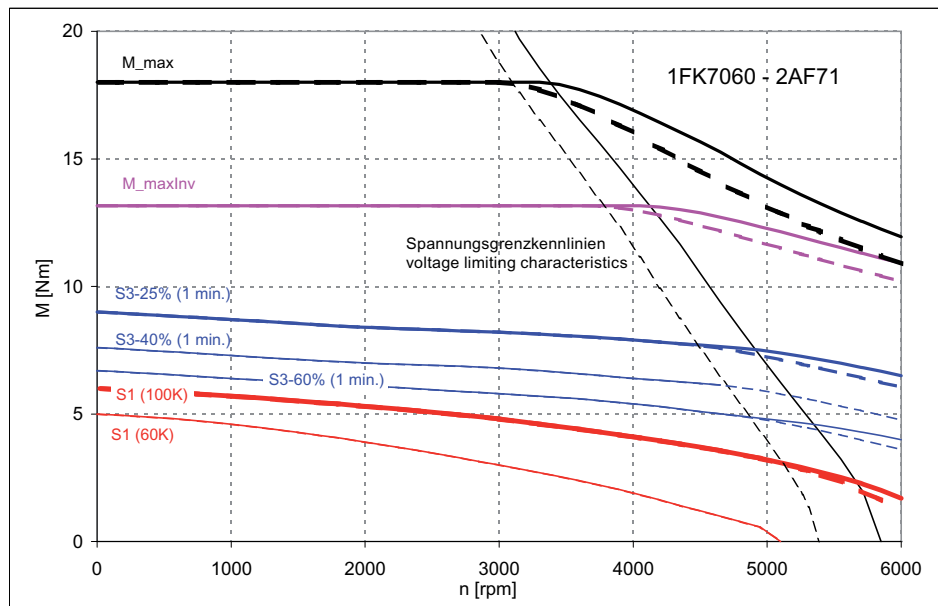

[—————] SINAMICS ALM 480 V-Netz (Zwischenkreisspannung 720 V DC) (DC-link voltage 720 V)

[- - - - -] SINAMICS BLM/SLM 480 V-Netz (Zwischenkreisspannung 650 V DC) (DC-link voltage 650 V)

Figure 4-16 1FK7060-2AF71

4.2 Torque-speed characteristic

Table 4- 16 1FK7060 Compact

Technical data	Code	Unit	-2AH71
Configuration data			
Rated speed	n_N	rpm	4500
Rated torque (100 K)	$M_N (100\text{ K})$	Nm	3.7
Rated current (100 K)	$I_N (100\text{ K})$	A	4.3
Static torque (100 K)	$M_0 (100\text{ K})$	Nm	6.0
Stall current (100 K)	$I_0 (100\text{ K})$	A	6.3
Static torque (60 K)	$M_0 (60\text{ K})$	Nm	5.0
Stall current (60 K)	$I_0 (60\text{ K})$	A	5.1
Optimum operating point			
Optimum speed	n_{opt}	rpm	4500
Optimum power	P_{opt}	kW	1.74
Limit data			
Max. permissible speed (mech.)	$n_{max\ mech}$	rpm	7200
Maximum torque	M_{max}	Nm	18.0
Maximum current	I_{max}	A	21.5
Motor data			
Pole number	2p		8
Torque constant (100 K)	k_T	Nm/A	0.95
Voltage constant (at 20 °C)	k_E	V/1000 rpm	60.5
Winding resistance (at 20 °C)	R_{ph}	Ω	0.695
Rotating field inductance	L_D	mH	7.6
Electrical time constant	T_{el}	ms	10.9
Mechanical time constant	T_{mech}	ms	1.78
Thermal time constant	T_{th}	min	30
Moment of inertia	J_{Mot}	kgm ²	$0.77 \cdot 10^{-3}$
Shaft torsional stiffness	C_t	Nm/rad	40500
Weight without brake	m_{Mot}	kg	7.1
Motor data with integrated brake			
Moment of inertia with brake	$J_{Mot\ Br}$	kgm ²	$0.87 \cdot 10^{-3}$
Shaft torsional stiffness with brake	$C_t\ Br$	Nm/rad	28500
Weight with brake	$m_{Mot\ Br}$	kg	8.5
Recommended Motor Module 6SL312□-□TE13-0AA□			
Rated converter current	$I_{N\ Inv}$	A	9
Maximum converter current	$I_{max\ Inv}$	A	18
Max. torque at $I_{max\ Inv}$	$M_{max\ Inv}$	Nm	15.8
Maximum permissible speed (converter)	$n_{max\ Inv}$	rpm	7200

The rated data are valid for a 600 V DC link voltage.

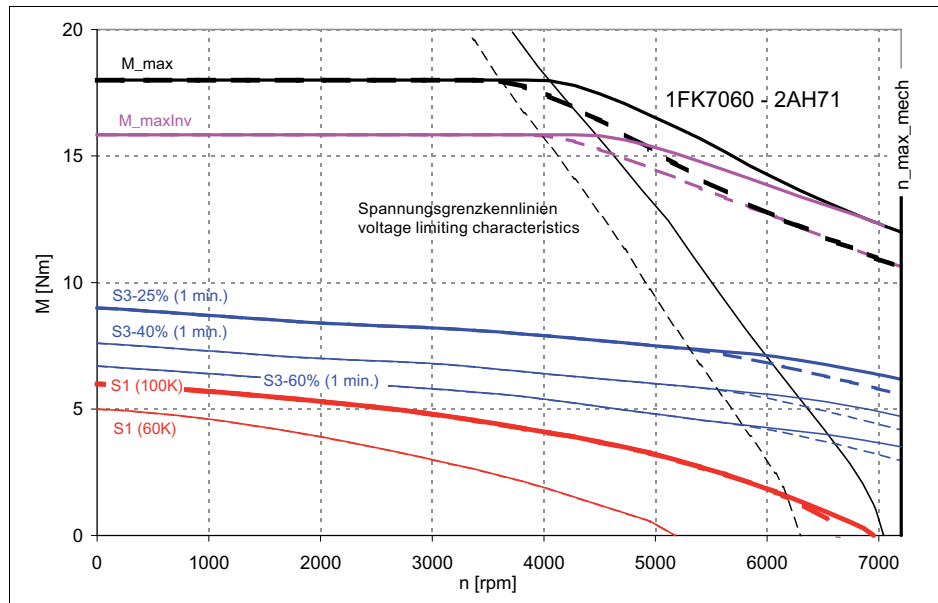

[—————] SINAMICS ALM 400 V-Netz (Zwischenkreisspannung 600 V DC) (DC-link voltage 600 V)

[- - - - -] SINAMICS BLM/SLM 400 V-Netz (Zwischenkreisspannung 540 V DC) (DC-link voltage 540 V)

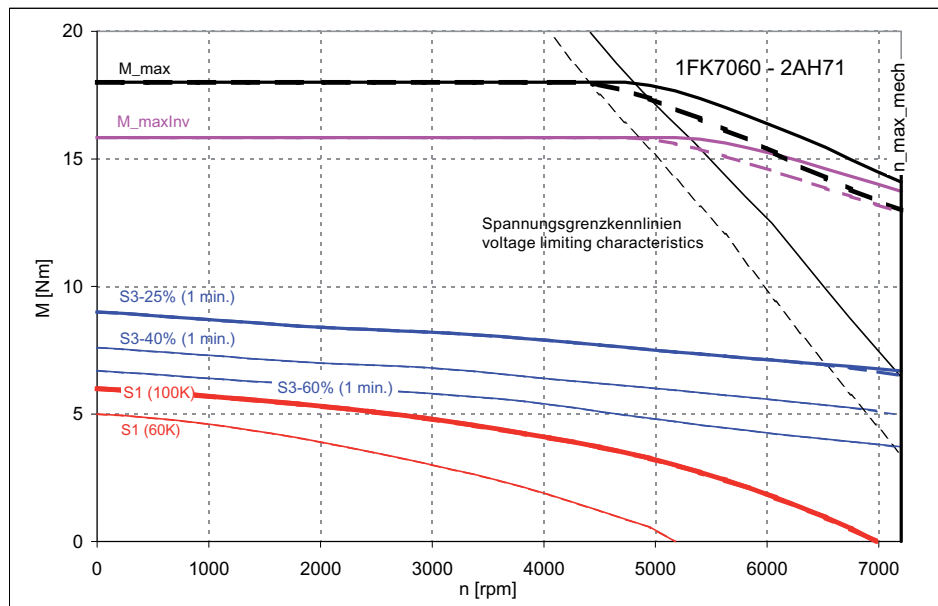

[—————] SINAMICS ALM 480 V-Netz (Zwischenkreisspannung 720 V DC) (DC-link voltage 720 V)

[- - - - -] SINAMICS BLM/SLM 480 V-Netz (Zwischenkreisspannung 650 V DC) (DC-link voltage 650 V)

Figure 4-17 1FK7060-2AH71

4.2 Torque-speed characteristic

Table 4- 17 1FK7062 Compact

Technical data	Code	Unit	-2AC71
Configuration data			
Rated speed	n_N	rpm	2000
Rated torque (100 K)	$M_N (100\text{ K})$	Nm	7.0
Rated current (100 K)	$I_N (100\text{ K})$	A	2.65
Static torque (100 K)	$M_0 (100\text{ K})$	Nm	8.5
Stall current (100 K)	$I_0 (100\text{ K})$	A	3.0
Static torque (60 K)	$M_0 (60\text{ K})$	Nm	7.1
Stall current (60 K)	$I_0 (60\text{ K})$	A	2.45
Optimum operating point			
Optimum speed	n_{opt}	rpm	2000
Optimum power	P_{opt}	kW	1.34
Limit data			
Max. permissible speed (mech.)	$n_{max\ mech}$	rpm	7200
Maximum torque	M_{max}	Nm	26.0
Maximum current	I_{max}	A	10.9
Motor data			
Pole number	2p		8
Torque constant (100 K)	k_T	Nm/A	2.83
Voltage constant (at 20 °C)	k_E	V/1000 rpm	180.5
Winding resistance (at 20 °C)	R_{ph}	Ω	3.59
Rotating field inductance	L_D	mH	45.5
Electrical time constant	T_{el}	ms	12.7
Mechanical time constant	T_{mech}	ms	1.51
Thermal time constant	T_{th}	min	35
Moment of inertia	J_{Mot}	kgm ²	$1.12 \cdot 10^{-3}$
Shaft torsional stiffness	C_t	Nm/rad	37000
Weight without brake	m_{Mot}	kg	9.1
Motor data with integrated brake			
Moment of inertia with brake	$J_{Mot\ Br}$	kgm ²	$122 \cdot 10^{-3}$
Shaft torsional stiffness with brake	$C_t\ Br$	Nm/rad	26500
Weight with brake	$m_{Mot\ Br}$	kg	10.5
Recommended Motor Module 6SL312□-□TE13-0AA□			
Rated converter current	$I_{N\ Inv}$	A	3
Maximum converter current	$I_{max\ Inv}$	A	6
Max. torque at $I_{max\ Inv}$	$M_{max\ Inv}$	Nm	17.0
Maximum permissible speed (converter)	$n_{max\ Inv}$	rpm	3200

The rated data are valid for a 600 V DC link voltage.

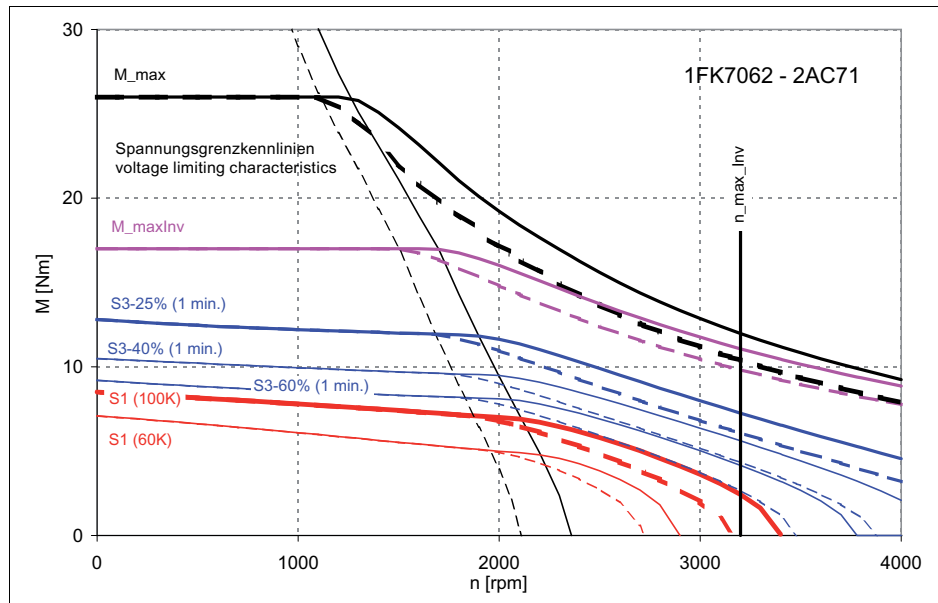

[—————] SINAMICS ALM 400 V-Netz (Zwischenkreisspannung 600 V DC) (DC-link voltage 600 V)
 [- - - - -] SINAMICS BLM/SLM 400 V-Netz (Zwischenkreisspannung 540 V DC) (DC-link voltage 540 V)

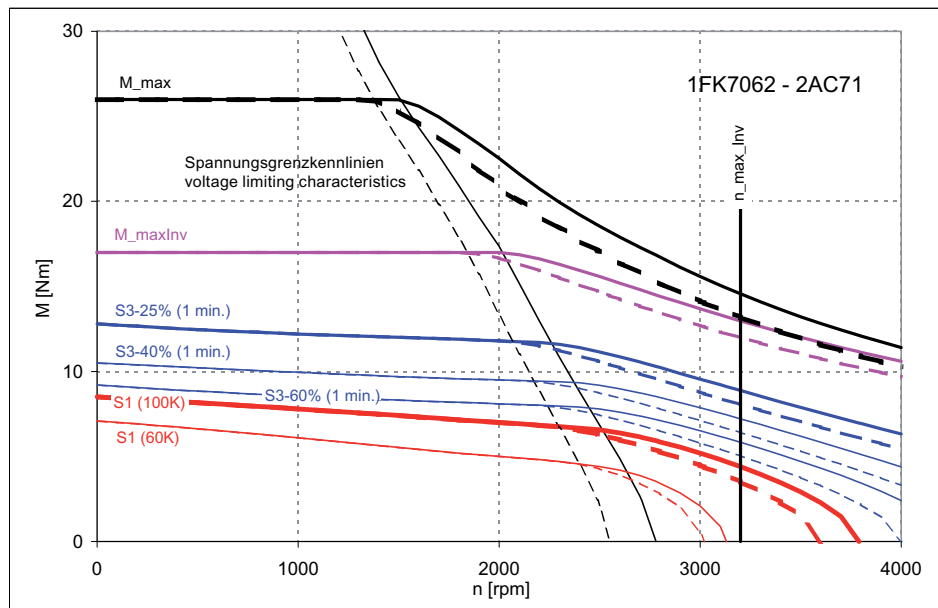

[—————] SINAMICS ALM 480 V-Netz (Zwischenkreisspannung 720 V DC) (DC-link voltage 720 V)
 [- - - - -] SINAMICS BLM/SLM 480 V-Netz (Zwischenkreisspannung 650 V DC) (DC-link voltage 650 V)

Figure 4-18 1FK7062-2AC71

4.2 Torque-speed characteristic

Table 4- 18 1FK7062 Compact

Technical data	Code	Unit	-2AF71
Configuration data			
Rated speed	n_N	rpm	3000
Rated torque (100 K)	$M_N (100\text{ K})$	Nm	6.0
Rated current (100 K)	$I_N (100\text{ K})$	A	4.0
Static torque (100 K)	$M_0 (100\text{ K})$	Nm	8.5
Stall current (100 K)	$I_0 (100\text{ K})$	A	5.3
Static torque (60 K)	$M_0 (60\text{ K})$	Nm	7.1
Stall current (60 K)	$I_0 (60\text{ K})$	A	4.3
Optimum operating point			
Optimum speed	n_{opt}	rpm	3000
Optimum power	P_{opt}	kW	1.6
Limit data			
Max. permissible speed (mech.)	$n_{max\ mech}$	rpm	7200
Maximum torque	M_{max}	Nm	26.0
Maximum current	I_{max}	A	19.2
Motor data			
Pole number	2p		8
Torque constant (100 K)	k_T	Nm/A	1.605
Voltage constant (at 20 °C)	k_E	V/1000 rpm	102.5
Winding resistance (at 20 °C)	R_{ph}	Ω	1.145
Rotating field inductance	L_D	mH	14.6
Electrical time constant	T_{el}	ms	12.8
Mechanical time constant	T_{mech}	ms	1.49
Thermal time constant	T_{th}	min	35
Moment of inertia	J_{Mot}	kgm ²	$1.12 \cdot 10^{-3}$
Shaft torsional stiffness	C_t	Nm/rad	37000
Weight without brake	m_{Mot}	kg	9.1
Motor data with integrated brake			
Moment of inertia with brake	$J_{Mot\ Br}$	kgm ²	$1.22 \cdot 10^{-3}$
Shaft torsional stiffness with brake	$C_t\ Br$	Nm/rad	26500
Weight with brake	$m_{Mot\ Br}$	kg	10.5
Recommended Motor Module 6SL312□-□TE15-0AA□			
Rated converter current	$I_{N\ Inv}$	A	5
Maximum converter current	$I_{max\ Inv}$	A	10
Max. torque at $I_{max\ Inv}$	$M_{max\ Inv}$	Nm	16.0
Maximum permissible speed (converter)	$n_{max\ Inv}$	rpm	5600

The rated data are valid for a 600 V DC link voltage.

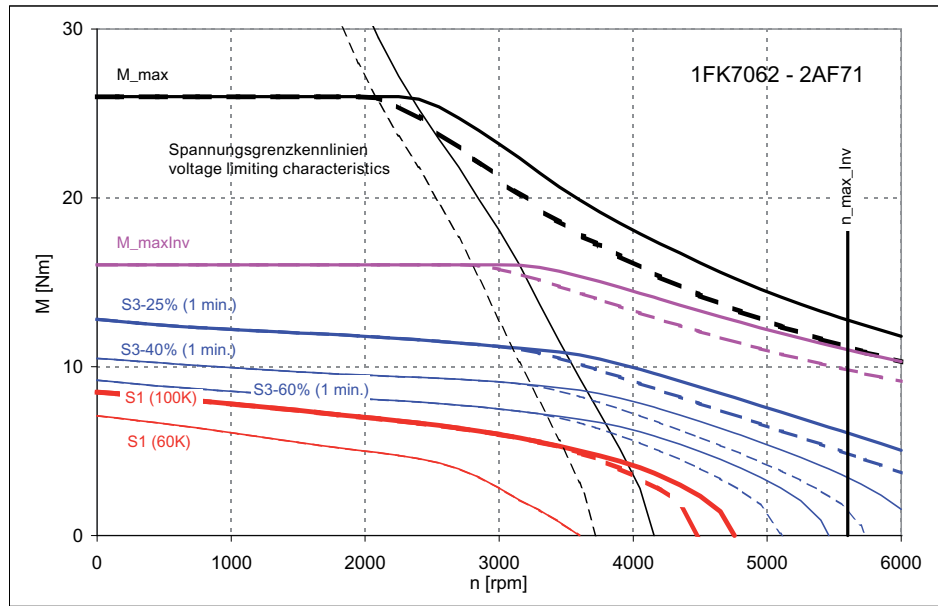

[—————] SINAMICS ALM 400 V-Netz (Zwischenkreisspannung 600 V DC) (DC-link voltage 600 V)

[-----] SINAMICS BLM/SLM 400 V-Netz (Zwischenkreisspannung 540 V DC) (DC-link voltage 540 V)

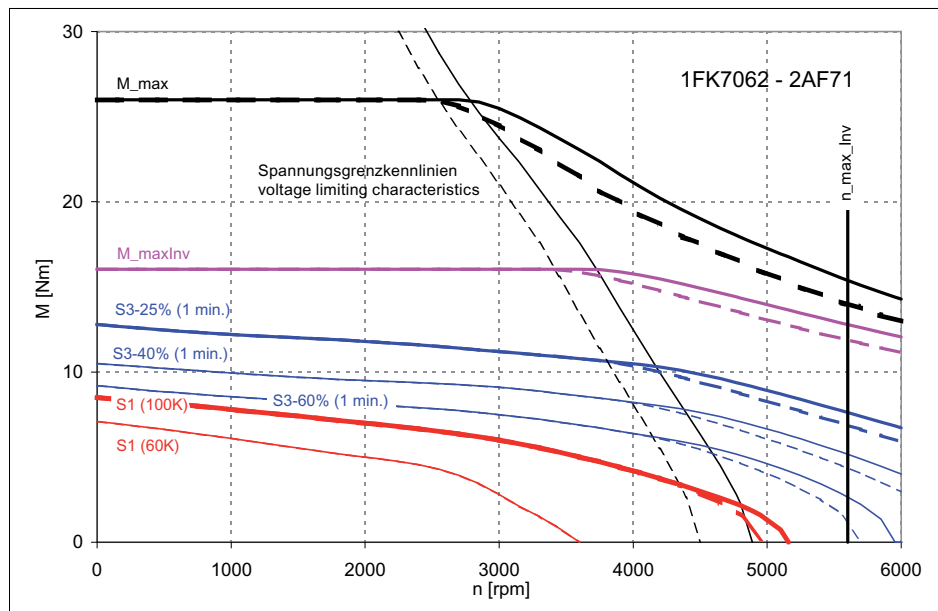

[—————] SINAMICS ALM 480 V-Netz (Zwischenkreisspannung 720 V DC) (DC-link voltage 720 V)

[-----] SINAMICS BLM/SLM 480 V-Netz (Zwischenkreisspannung 650 V DC) (DC-link voltage 650 V)

Figure 4-19 1FK7062-2AF71

4.2 Torque-speed characteristic

Table 4- 19 1FK7062 Compact

Technical data	Code	Unit	-2AH71
Configuration data			
Rated speed	n_N	rpm	4500
Rated torque (100 K)	$M_N (100\text{ K})$	Nm	3.0
Rated current (100 K)	$I_N (100\text{ K})$	A	3.3
Static torque (100 K)	$M_0 (100\text{ K})$	Nm	8.5
Stall current (100 K)	$I_0 (100\text{ K})$	A	8.0
Static torque (60 K)	$M_0 (60\text{ K})$	Nm	7.1
Stall current (60 K)	$I_0 (60\text{ K})$	A	6.5
Optimum operating point			
Optimum speed	n_{opt}	rpm	3500
Optimum power	P_{opt}	kW	1.95
Limit data			
Max. permissible speed (mech.)	$n_{max\ mech}$	rpm	7200
Maximum torque	M_{max}	Nm	26.0
Maximum current	I_{max}	A	29.0
Motor data			
Pole number	2p		8
Torque constant (100 K)	k_T	Nm/A	1.065
Voltage constant (at 20 °C)	k_E	V/1000 rpm	67.5
Winding resistance (at 20 °C)	R_{ph}	Ω	0.485
Rotating field inductance	L_D	mH	6.4
Electrical time constant	T_{el}	ms	13.2
Mechanical time constant	T_{mech}	ms	1.44
Thermal time constant	T_{th}	min	35
Moment of inertia	J_{Mot}	kgm ²	$1.12 \cdot 10^{-3}$
Shaft torsional stiffness	C_t	Nm/rad	37000
Weight without brake	m_{Mot}	kg	9.1
Motor data with integrated brake			
Moment of inertia with brake	$J_{Mot\ Br}$	kgm ²	$1.22 \cdot 10^{-3}$
Shaft torsional stiffness with brake	$C_t\ Br$	Nm/rad	26500
Weight with brake	$m_{Mot\ Br}$	kg	10.5
Recommended Motor Module 6SL312□-□TE21-0AA□			
Rated converter current	$I_{N\ Inv}$	A	9
Maximum converter current	$I_{max\ Inv}$	A	18
Max. torque at $I_{max\ Inv}$	$M_{max\ Inv}$	Nm	18.5
Maximum permissible speed (converter)	$n_{max\ Inv}$	rpm	7200

The rated data are valid for a 600 V DC link voltage.

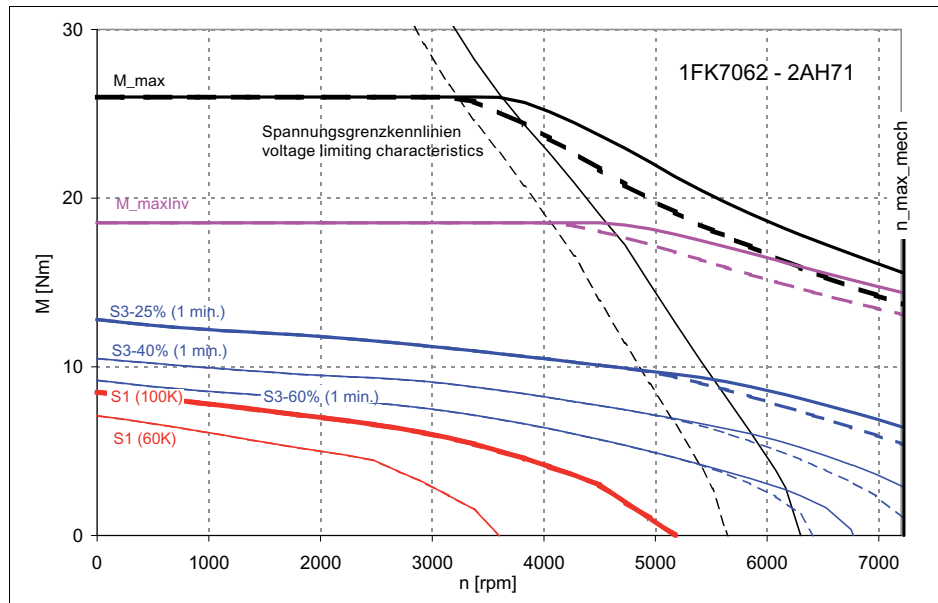

[—————] SINAMICS ALM 400 V-Netz (Zwischenkreisspannung 600 V DC) (DC-link voltage 600 V)
 [- - - - -] SINAMICS BLM/SLM 400 V-Netz (Zwischenkreisspannung 540 V DC) (DC-link voltage 540 V)

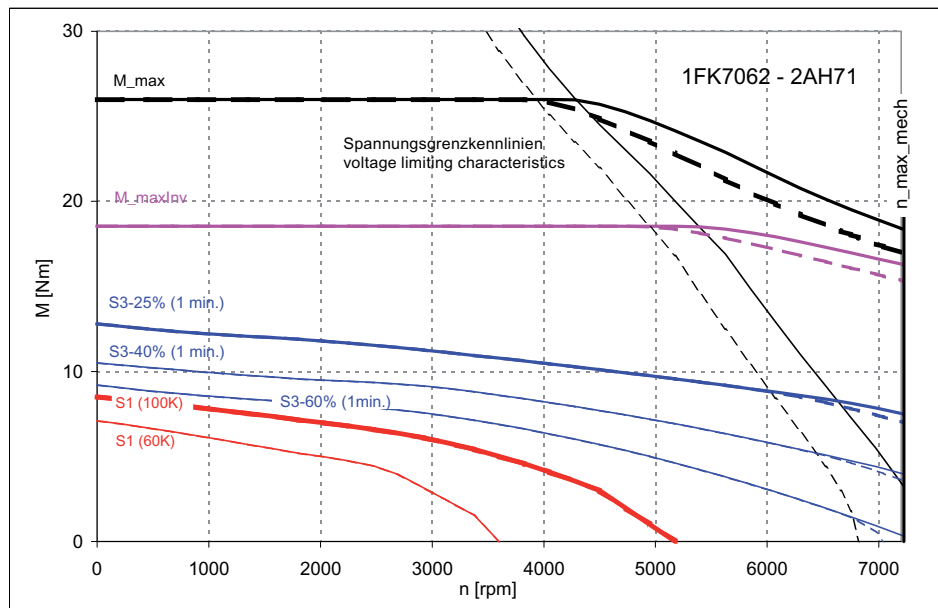

[—————] SINAMICS ALM 480 V-Netz (Zwischenkreisspannung 720 V DC) (DC-link voltage 720 V)
 [- - - - -] SINAMICS BLM/SLM 480 V-Netz (Zwischenkreisspannung 650 V DC) (DC-link voltage 650 V)

Figure 4-20 1FK7062-2AH71

4.2 Torque-speed characteristic

Table 4- 20 1FK7063 Compact

Technical data	Code	Unit	-2AC71
Configuration data			
Rated speed	n_N	rpm	2000
Rated torque (100 K)	$M_N (100\text{ K})$	Nm	8.9
Rated current (100 K)	$I_N (100\text{ K})$	A	4.4
Static torque (100 K)	$M_0 (100\text{ K})$	Nm	11.0
Stall current (100 K)	$I_0 (100\text{ K})$	A	5.3
Static torque (60 K)	$M_0 (60\text{ K})$	Nm	9.1
Stall current (60 K)	$I_0 (60\text{ K})$	A	4.3
Optimum operating point			
Optimum speed	n_{opt}	rpm	2000
Optimum power	P_{opt}	kW	1.86
Limit data			
Max. permissible speed (mech.)	$n_{max\ mech}$	rpm	7200
Maximum torque	M_{max}	Nm	35.0
Maximum current	I_{max}	A	18.5
Motor data			
Pole number	2p		8
Torque constant (100 K)	k_T	Nm/A	2.08
Voltage constant (at 20 °C)	k_E	V/1000 rpm	136.5
Winding resistance (at 20 °C)	R_{ph}	Ω	1.445
Rotating field inductance	L_D	mH	19.4
Electrical time constant	T_{el}	ms	13.4
Mechanical time constant	T_{mech}	ms	1.47
Thermal time constant	T_{th}	min	40
Moment of inertia	J_{Mot}	kgm ²	$1.47 \cdot 10^{-3}$
Shaft torsional stiffness	C_t	Nm/rad	34000
Weight without brake	m_{Mot}	kg	11.1
Motor data with integrated brake			
Moment of inertia with brake	$J_{Mot\ Br}$	kgm ²	$1.57 \cdot 10^{-3}$
Shaft torsional stiffness with brake	$C_t\ Br$	Nm/rad	25000
Weight with brake	$m_{Mot\ Br}$	kg	12.5
Recommended Motor Module 6SL312□-□TE15-0AA□			
Rated converter current	$I_{N\ Inv}$	A	5
Maximum converter current	$I_{max\ Inv}$	A	10
Max. torque at $I_{max\ Inv}$	$M_{max\ Inv}$	Nm	20.8
Maximum permissible speed (converter)	$n_{max\ Inv}$	rpm	4200

The rated data are valid for a 600 V DC link voltage.

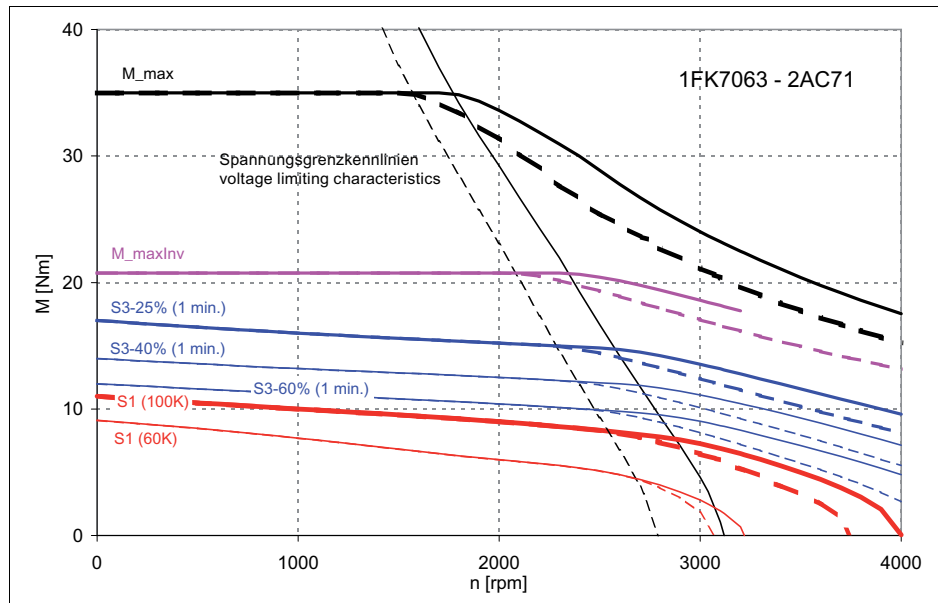

[—————] SINAMICS ALM 400 V-Netz (Zwischenkreisspannung 600 V DC) (DC-link voltage 600 V)

[- - - - -] SINAMICS BLM/SLM 400 V-Netz (Zwischenkreisspannung 540 V DC) (DC-link voltage 540 V)

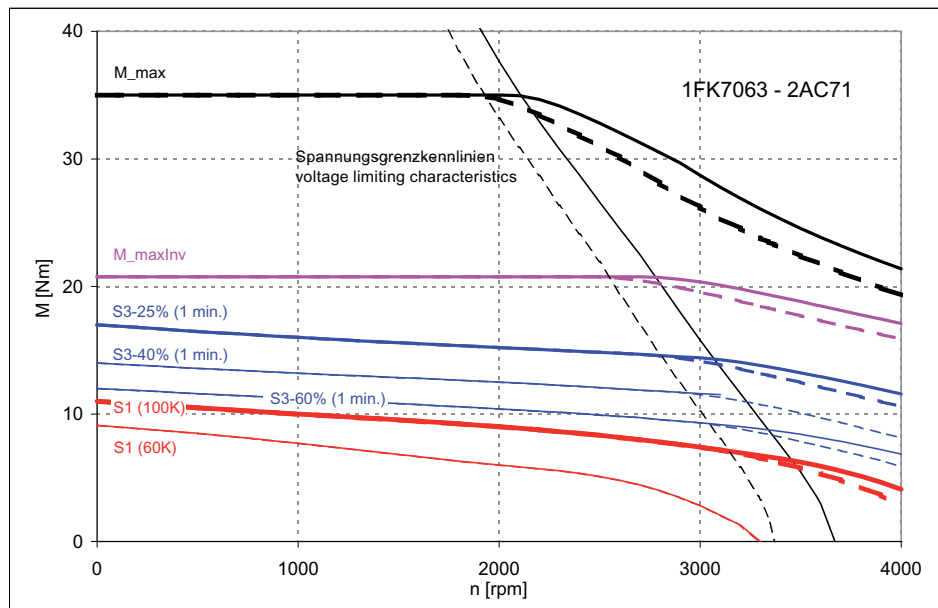

[—————] SINAMICS ALM 480 V-Netz (Zwischenkreisspannung 720 V DC) (DC-link voltage 720 V)

[- - - - -] SINAMICS BLM/SLM 480 V-Netz (Zwischenkreisspannung 650 V DC) (DC-link voltage 650 V)

Figure 4-21 1FK7063-2AC71

4.2 Torque-speed characteristic

Table 4- 21 1FK7063 Compact

Technical data	Code	Unit	-2AF71
Configuration data			
Rated speed	n_N	rpm	3000
Rated torque (100 K)	$M_N (100\text{ K})$	Nm	7.3
Rated current (100 K)	$I_N (100\text{ K})$	A	5.6
Static torque (100 K)	$M_0 (100\text{ K})$	Nm	11.0
Stall current (100 K)	$I_0 (100\text{ K})$	A	8.0
Static torque (60 K)	$M_0 (60\text{ K})$	Nm	9.1
Stall current (60 K)	$I_0 (60\text{ K})$	A	6.5
Optimum operating point			
Optimum speed	n_{opt}	rpm	3000
Optimum power	P_{opt}	kW	2.3
Limit data			
Max. permissible speed (mech.)	$n_{max\ mech}$	rpm	7200
Maximum torque	M_{max}	Nm	35.0
Maximum current	I_{max}	A	28.0
Motor data			
Pole number	2p		8
Torque constant (100 K)	k_T	Nm/A	1.37
Voltage constant (at 20 °C)	k_E	V/1000 rpm	90.5
Winding resistance (at 20 °C)	R_{ph}	Ω	0.635
Rotating field inductance	L_D	mH	8.5
Electrical time constant	T_{el}	ms	13.4
Mechanical time constant	T_{mech}	ms	1.48
Thermal time constant	T_{th}	min	40
Moment of inertia	J_{Mot}	kgm ²	$1.47 \cdot 10^{-3}$
Shaft torsional stiffness	C_t	Nm/rad	34000
Weight without brake	m_{Mot}	kg	11.1
Motor data with integrated brake			
Moment of inertia with brake	$J_{Mot\ Br}$	kgm ²	$1.57 \cdot 10^{-3}$
Shaft torsional stiffness with brake	$C_t\ Br$	Nm/rad	25000
Weight with brake	$m_{Mot\ Br}$	kg	12.5
Recommended Motor Module 6SL312□-□TE21-0AA□			
Rated converter current	$I_{N\ Inv}$	A	9
Maximum converter current	$I_{max\ Inv}$	A	18
Max. torque at $I_{max\ Inv}$	$M_{max\ Inv}$	Nm	24.3
Maximum permissible speed (converter)	$n_{max\ Inv}$	rpm	6400

The rated data are valid for a 600 V DC link voltage.

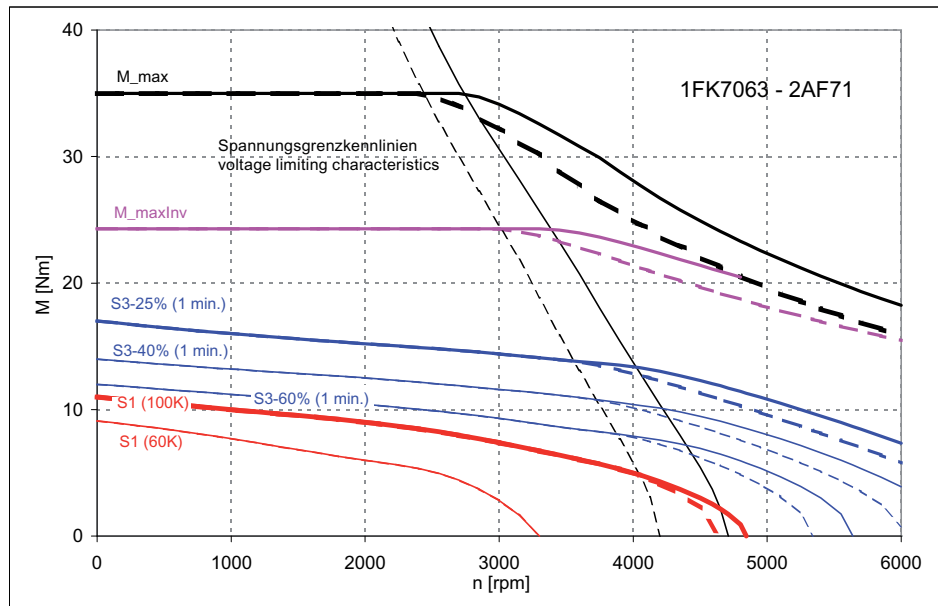

[—————] SINAMICS ALM 400 V-Netz (Zwischenkreisspannung 600 V DC) (DC-link voltage 600 V)

[- - - - -] SINAMICS BLM/SLM 400 V-Netz (Zwischenkreisspannung 540 V DC) (DC-link voltage 540 V)

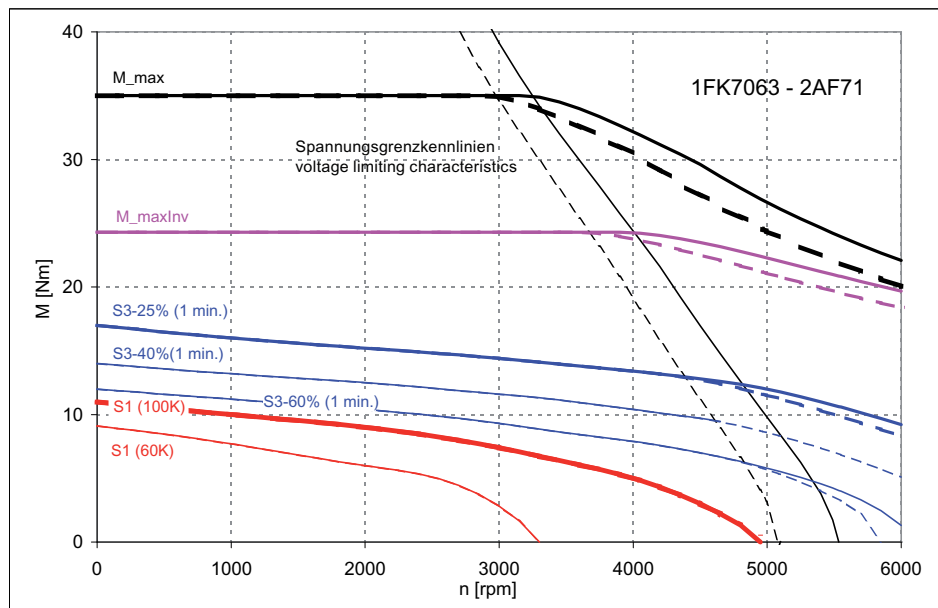

[—————] SINAMICS ALM 480 V-Netz (Zwischenkreisspannung 720 V DC) (DC-link voltage 720 V)

[- - - - -] SINAMICS BLM/SLM 480 V-Netz (Zwischenkreisspannung 650 V DC) (DC-link voltage 650 V)

Figure 4-22 1FK7063-2AF71

4.2 Torque-speed characteristic

Table 4- 22 1FK7063 Compact

Technical data	Code	Unit	-2AH71
Configuration data			
Rated speed	n_N	rpm	4500
Rated torque (100 K)	$M_N (100\text{ K})$	Nm	3.0
Rated current (100 K)	$I_N (100\text{ K})$	A	3.8
Static torque (100 K)	$M_0 (100\text{ K})$	Nm	11.0
Stall current (100 K)	$I_0 (100\text{ K})$	A	12.0
Static torque (60 K)	$M_0 (60\text{ K})$	Nm	9.1
Stall current (60 K)	$I_0 (60\text{ K})$	A	9.7
Optimum operating point			
Optimum speed	n_{opt}	rpm	3300
Optimum power	P_{opt}	kW	2.3
Limit data			
Max. permissible speed (mech.)	$n_{max\ mech}$	rpm	7200
Maximum torque	M_{max}	Nm	35.0
Maximum current	I_{max}	A	42.0
Motor data			
Pole number	2p		8
Torque constant (100 K)	k_T	Nm/A	0.915
Voltage constant (at 20 °C)	k_E	V/1000 rpm	60.0
Winding resistance (at 20 °C)	R_{ph}	Ω	0.287
Rotating field inductance	L_D	mH	3.8
Electrical time constant	T_{el}	ms	13.2
Mechanical time constant	T_{mech}	ms	1.51
Thermal time constant	T_{th}	min	40
Moment of inertia	J_{Mot}	kgm ²	$1.47 \cdot 10^{-3}$
Shaft torsional stiffness	C_t	Nm/rad	34000
Weight without brake	m_{Mot}	kg	11.1
Motor data with integrated brake			
Moment of inertia with brake	$J_{Mot\ Br}$	kgm ²	$1.57 \cdot 10^{-3}$
Shaft torsional stiffness with brake	$C_t\ Br$	Nm/rad	25000
Weight with brake	$m_{Mot\ Br}$	kg	12.5
Recommended Motor Module 6SL312□-□TE13-0AA□			
Rated converter current	$I_{N\ Inv}$	A	18
Maximum converter current	$I_{max\ Inv}$	A	36
Max. torque at $I_{max\ Inv}$	$M_{max\ Inv}$	Nm	30.9
Maximum permissible speed (converter)	$n_{max\ Inv}$	rpm	7200

The rated data are valid for a 600 V DC link voltage.

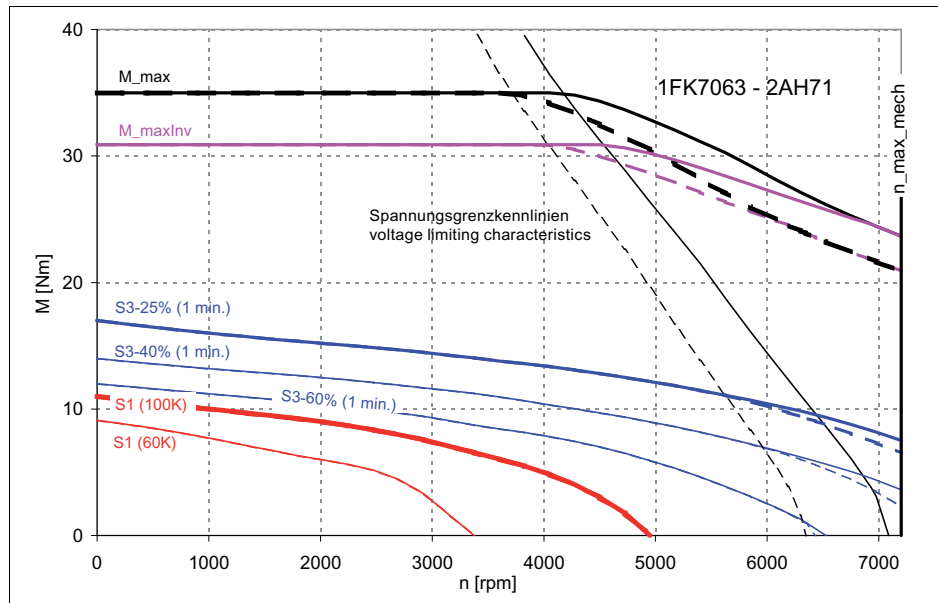

[—————] SINAMICS ALM 400 V-Netz (Zwischenkreisspannung 600 V DC) (DC-link voltage 600 V)

[- - - - -] SINAMICS BLM/SLM 400 V-Netz (Zwischenkreisspannung 540 V DC) (DC-link voltage 540 V)

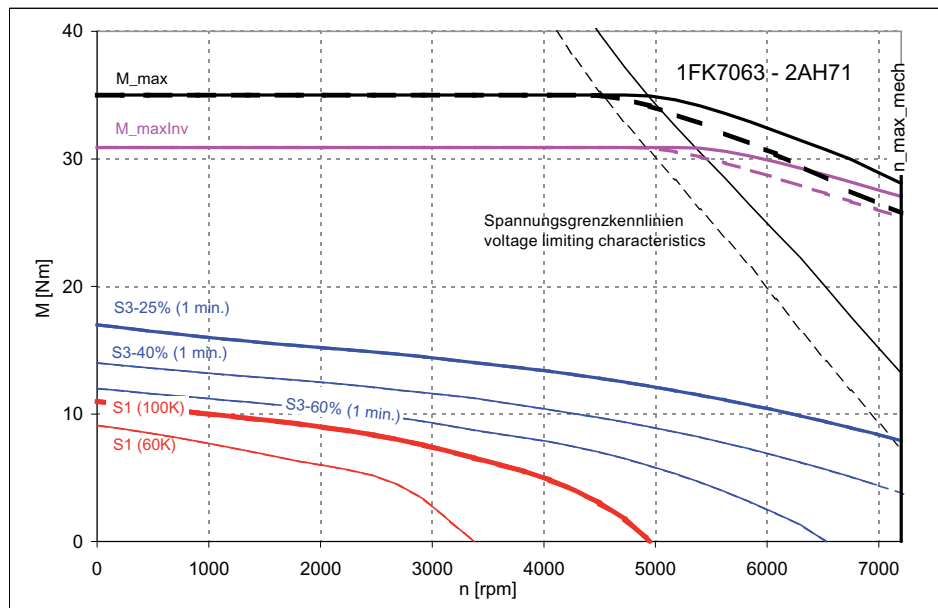

[—————] SINAMICS ALM 480 V-Netz (Zwischenkreisspannung 720 V DC) (DC-link voltage 720 V)

[- - - - -] SINAMICS BLM/SLM 480 V-Netz (Zwischenkreisspannung 650 V DC) (DC-link voltage 650 V)

Figure 4-23 1FK7063-2AH71

4.2 Torque-speed characteristic

Table 4- 23 1FK7080 Compact

Technical data	Code	Unit	-2AF71
Configuration data			
Rated speed	n_N	rpm	3000
Rated torque (100 K)	$M_N (100\text{ K})$	Nm	6.8
Rated current (100 K)	$I_N (100\text{ K})$	A	4.4
Static torque (100 K)	$M_0 (100\text{ K})$	Nm	8.0
Stall current (100 K)	$I_0 (100\text{ K})$	A	4.9
Static torque (60 K)	$M_0 (60\text{ K})$	Nm	6.6
Stall current (60 K)	$I_0 (60\text{ K})$	A	4.0
Optimum operating point			
Optimum speed	n_{opt}	RPM	3000
Optimum power	P_{opt}	kW	2.15
Limit data			
Max. permissible speed (mech.)	$n_{max\ mech}$	rpm	6000
Maximum torque	M_{max}	Nm	25.0
Maximum current	I_{max}	A	18.0
Motor data			
Pole number	2p		8
Torque constant (100 K)	k_T	Nm/A	1.61
Voltage constant (at 20 °C)	k_E	V/1000 rpm	105.0
Winding resistance (at 20 °C)	R_{ph}	Ω	0.985
Rotating field inductance	L_D	mH	17.2
Electrical time constant	T_{el}	ms	17.5
Mechanical time constant	T_{mech}	ms	1.52
Thermal time constant	T_{th}	min	40
Moment of inertia	J_{Mot}	kgm ²	$1.42 \cdot 10^{-3}$
Shaft torsional stiffness	C_t	Nm/rad	120000
Weight without brake	m_{Mot}	kg	10.3
Motor data with integrated brake			
Moment of inertia with brake	$J_{Mot\ Br}$	kgm ²	$1.75 \cdot 10^{-3}$
Shaft torsional stiffness with brake	$C_t\ Br$	Nm/rad	81000
Weight with brake	$m_{Mot\ Br}$	kg	13.3
Recommended Motor Module 6SL312□-□TE15-0AA□			
Rated converter current	$I_{N\ Inv}$	A	5
Maximum converter current	$I_{max\ Inv}$	A	10
Max. torque at $I_{max\ Inv}$	$M_{max\ Inv}$	Nm	16.5
Maximum permissible speed (converter)	$n_{max\ Inv}$	rpm	5500

The rated data are valid for a 600 V DC link voltage.

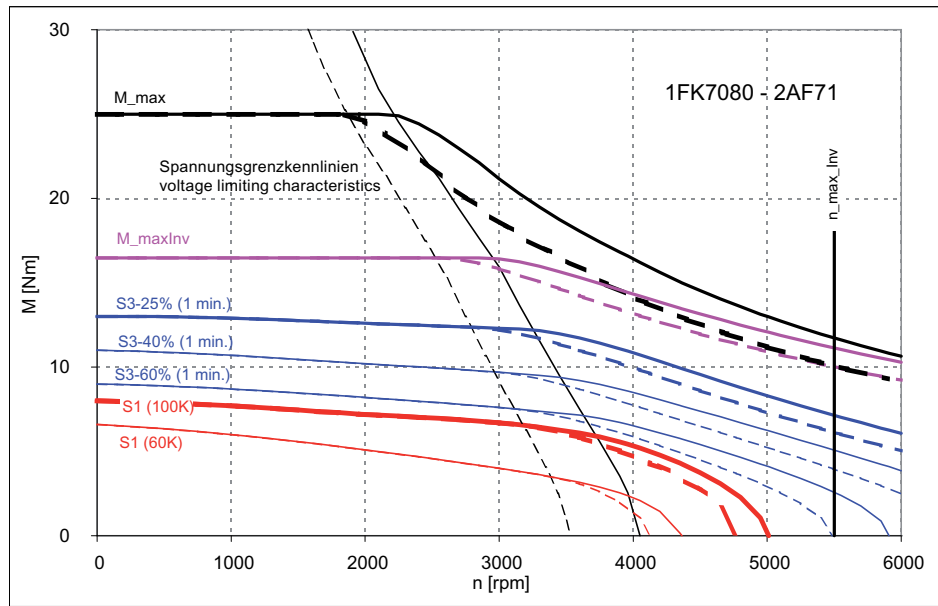

[—————] SINAMICS ALM 400 V-Netz (Zwischenkreisspannung 600 V DC) (DC-link voltage 600 V)

[- - - - -] SINAMICS BLM/SLM 400 V-Netz (Zwischenkreisspannung 540 V DC) (DC-link voltage 540 V)

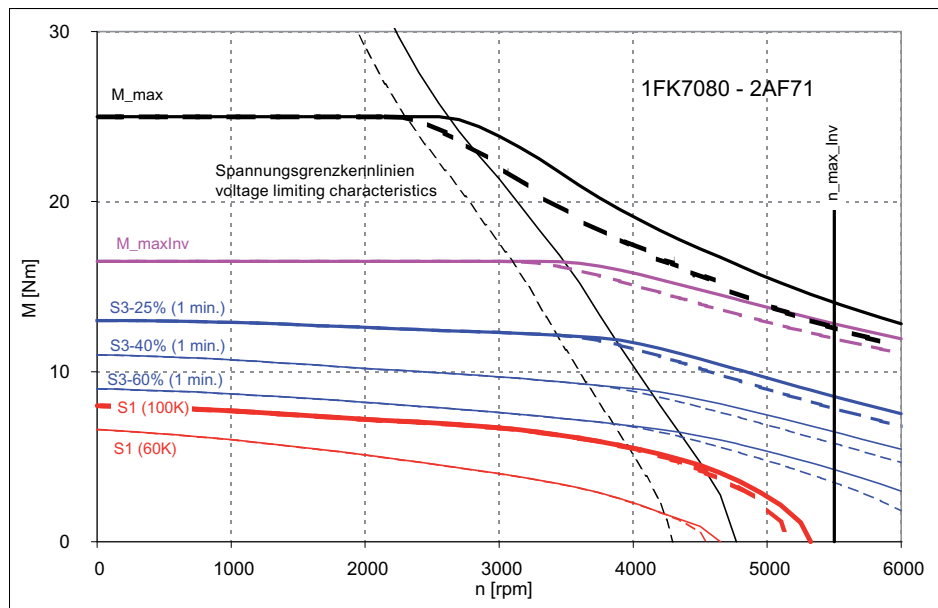

[—————] SINAMICS ALM 480 V-Netz (Zwischenkreisspannung 720 V DC) (DC-link voltage 720 V)

[- - - - -] SINAMICS BLM/SLM 480 V-Netz (Zwischenkreisspannung 650 V DC) (DC-link voltage 650 V)

Figure 4-24 1FK7080-2AF71

4.2 Torque-speed characteristic

Table 4- 24 1FK7080 Compact

Technical data	Code	Unit	-2AH71
Configuration data			
Rated speed	n_N	rpm	4500
Rated torque (100 K)	$M_N (100\text{ K})$	Nm	4.5
Rated current (100 K)	$I_N (100\text{ K})$	A	4.8
Static torque (100 K)	$M_0 (100\text{ K})$	Nm	8.0
Stall current (100 K)	$I_0 (100\text{ K})$	A	7.4
Static torque (60 K)	$M_0 (60\text{ K})$	Nm	6.6
Stall current (60 K)	$I_0 (60\text{ K})$	A	6.0
Optimum operating point			
Optimum speed	n_{opt}	rpm	4000
Optimum power	P_{opt}	kW	2.4
Limit data			
Max. permissible speed (mech.)	$n_{max\ mech}$	rpm	6000
Maximum torque	M_{max}	Nm	25.0
Maximum current	I_{max}	A	27.5
Motor data			
Pole number	2p		8
Torque constant (100 K)	k_T	Nm/A	1.08
Voltage constant (at 20 °C)	k_E	V/1000 rpm	68.5
Winding resistance (at 20 °C)	R_{ph}	Ω	0.421
Rotating field inductance	L_D	mH	7.3
Electrical time constant	T_{el}	ms	17.3
Mechanical time constant	T_{mech}	ms	1.54
Thermal time constant	T_{th}	min	40
Moment of inertia	J_{Mot}	kgm ²	$1.42 \cdot 10^{-3}$
Shaft torsional stiffness	C_t	Nm/rad	120000
Weight without brake	m_{Mot}	kg	10.3
Motor data with integrated brake			
Moment of inertia with brake	$J_{Mot\ Br}$	kgm ²	$1.75 \cdot 10^{-3}$
Shaft torsional stiffness with brake	$C_t\ Br$	Nm/rad	81000
Weight with brake	$m_{Mot\ Br}$	kg	13.3
Recommended Motor Module 6SL312□-□TE21-0AA□			
Rated converter current	$I_{N\ Inv}$	A	9
Maximum converter current	$I_{max\ Inv}$	A	18
Max. torque at $I_{max\ Inv}$	$M_{max\ Inv}$	Nm	18.5
Maximum permissible speed (converter)	$n_{max\ Inv}$	rpm	6000

The rated data are valid for a 600 V DC link voltage.

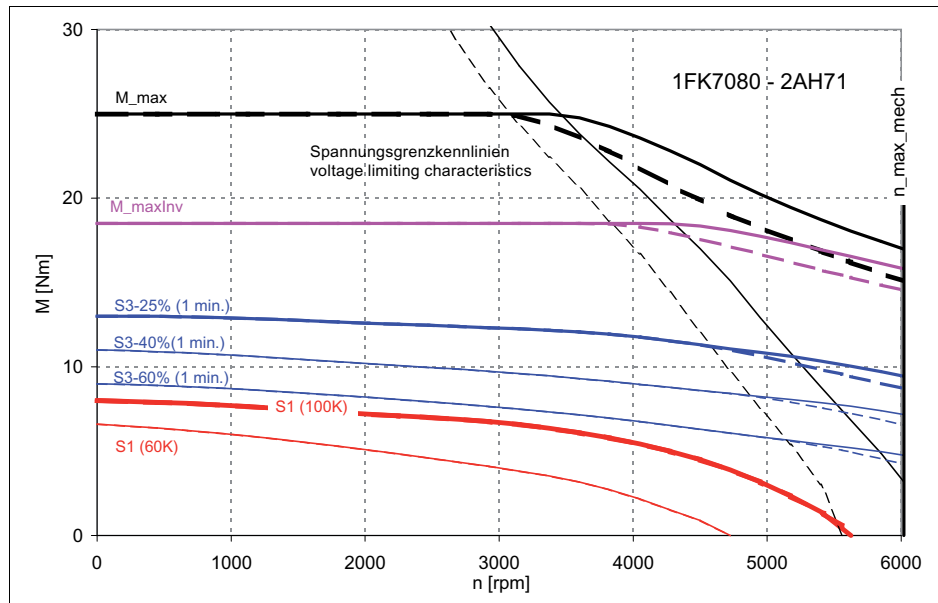

[—————] SINAMICS ALM 400 V-Netz (Zwischenkreisspannung 600 V DC) (DC-link voltage 600 V)

[- - - - -] SINAMICS BLM/SLM 400 V-Netz (Zwischenkreisspannung 540 V DC) (DC-link voltage 540 V)

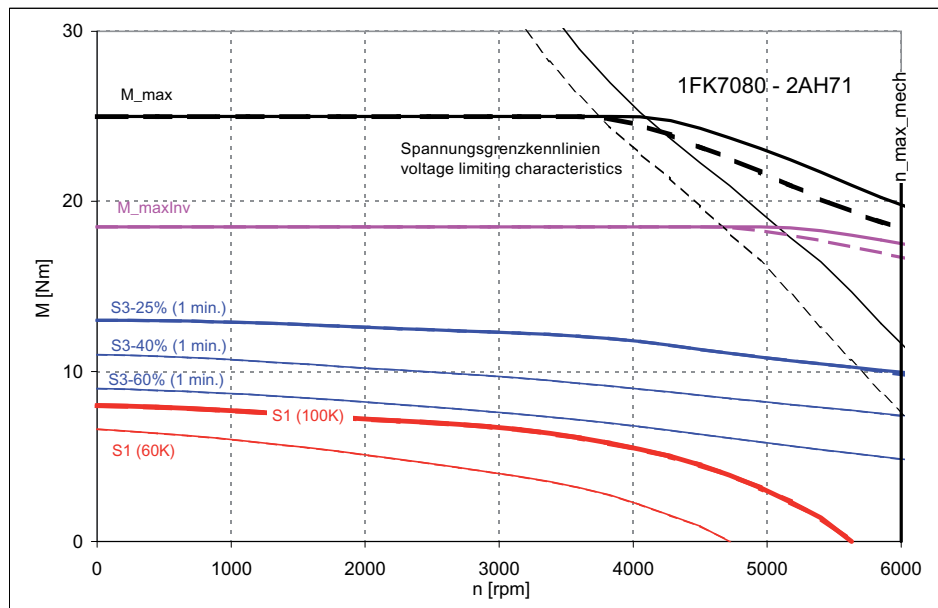

[—————] SINAMICS ALM 480 V-Netz (Zwischenkreisspannung 720 V DC) (DC-link voltage 720 V)

[- - - - -] SINAMICS BLM/SLM 480 V-Netz (Zwischenkreisspannung 650 V DC) (DC-link voltage 650 V)

Figure 4-25 1FK7080-2AH71

4.2 Torque-speed characteristic

Table 4- 25 1FK7081 Compact

Technical data	Code	Unit	-2AC71
Configuration data			
Rated speed	n_N	rpm	2000
Rated torque (100 K)	$M_N (100\text{ K})$	Nm	10.0
Rated current (100 K)	$I_N (100\text{ K})$	A	4.4
Static torque (100 K)	$M_0 (100\text{ K})$	Nm	12.0
Stall current (100 K)	$I_0 (100\text{ K})$	A	5.0
Static torque (60 K)	$M_0 (60\text{ K})$	Nm	10.0
Stall current (60 K)	$I_0 (60\text{ K})$	A	4.05
Optimum operating point			
Optimum speed	n_{opt}	rpm	2000
Optimum power	P_{opt}	kW	2.1
Limit data			
Max. permissible speed (mech.)	$n_{max\ mech}$	rpm	6000
Maximum torque	M_{max}	Nm	37.0
Maximum current	I_{max}	A	17.2
Motor data			
Pole number	2p		8
Torque constant (100 K)	k_T	Nm/A	2.4
Voltage constant (at 20 °C)	k_E	V/1000 rpm	154.5
Winding resistance (at 20 °C)	R_{ph}	Ω	1.275
Rotating field inductance	L_D	mH	23.5
Electrical time constant	T_{el}	ms	18.4
Mechanical time constant	T_{mech}	ms	1.33
Thermal time constant	T_{th}	min	45
Moment of inertia	J_{Mot}	kgm ²	$2.00 \cdot 10^{-3}$
Shaft torsional stiffness	C_t	Nm/rad	109000
Weight without brake	m_{Mot}	kg	12.9
Motor data with integrated brake			
Moment of inertia with brake	$J_{Mot\ Br}$	kgm ²	$2.35 \cdot 10^{-3}$
Shaft torsional stiffness with brake	$C_t\ Br$	Nm/rad	76000
Weight with brake	$m_{Mot\ Br}$	kg	15.9
Recommended Motor Module 6SL312□-□TE15-0AA□			
Rated converter current	$I_{N\ Inv}$	A	5
Maximum converter current	$I_{max\ Inv}$	A	10
Max. torque at $I_{max\ Inv}$	$M_{max\ Inv}$	Nm	24.0
Maximum permissible speed (converter)	$n_{max\ Inv}$	rpm	3750

The rated data are valid for a 600 V DC link voltage.

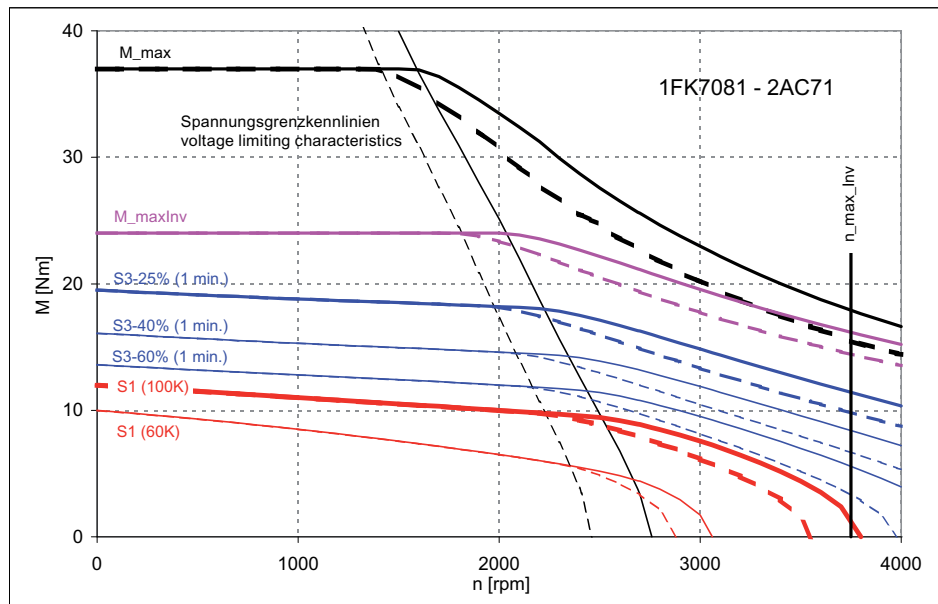

[—————] SINAMICS ALM 400 V-Netz (Zwischenkreisspannung 600 V DC) (DC-link voltage 600 V)

[- - - - -] SINAMICS BLM/SLM 400 V-Netz (Zwischenkreisspannung 540 V DC) (DC-link voltage 540 V)

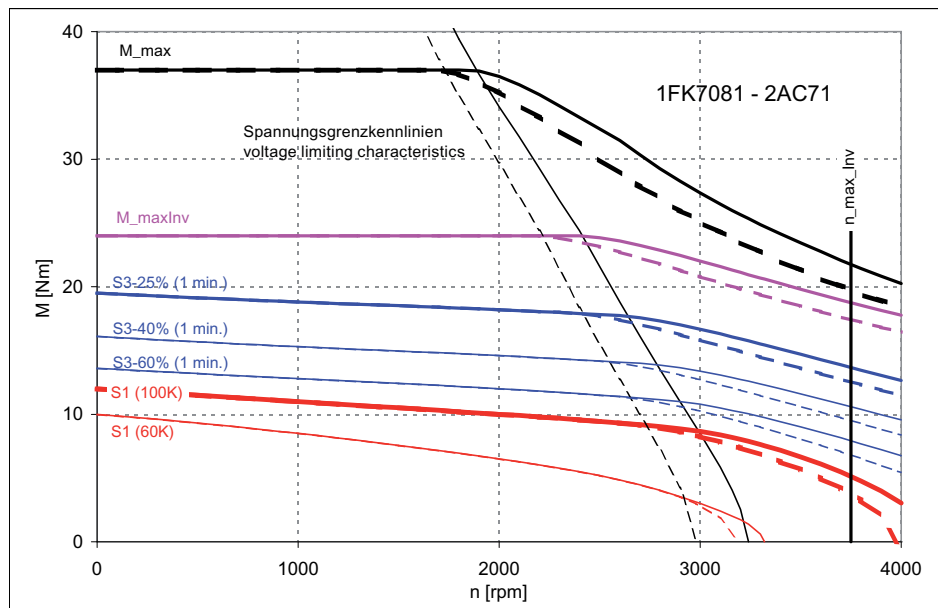

[—————] SINAMICS ALM 480 V-Netz (Zwischenkreisspannung 720 V DC) (DC-link voltage 720 V)

[- - - - -] SINAMICS BLM/SLM 480 V-Netz (Zwischenkreisspannung 650 V DC) (DC-link voltage 650 V)

Figure 4-26 1FK7081-2AC71

4.2 Torque-speed characteristic

Table 4- 26 1FK7081 Compact

Technical data	Code	Unit	-2AF71
Configuration data			
Rated speed	n_N	rpm	3000
Rated torque (100 K)	$M_N (100\text{ K})$	Nm	8.7
Rated current (100 K)	$I_N (100\text{ K})$	A	6.8
Static torque (100 K)	$M_0 (100\text{ K})$	Nm	12.0
Stall current (100 K)	$I_0 (100\text{ K})$	A	8.7
Static torque (60 K)	$M_0 (60\text{ K})$	Nm	10.0
Stall current (60 K)	$I_0 (60\text{ K})$	A	7.1
Optimum operating point			
Optimum speed	n_{opt}	rpm	3000
Optimum power	P_{opt}	kW	2.75
Limit data			
Max. permissible speed (mech.)	$n_{max\ mech}$	rpm	6000
Maximum torque	M_{max}	Nm	37.0
Maximum current	I_{max}	A	30.0
Motor data			
Pole number	2p		8
Torque constant (100 K)	k_T	Nm/A	1.375
Voltage constant (at 20 °C)	k_E	V/1000 rpm	88.5
Winding resistance (at 20 °C)	R_{ph}	Ω	0.424
Rotating field inductance	L_D	mH	7.7
Electrical time constant	T_{el}	ms	18.2
Mechanical time constant	T_{mech}	ms	1.35
Thermal time constant	T_{th}	min	45
Moment of inertia	J_{Mot}	kgm ²	$2.00 \cdot 10^{-3}$
Shaft torsional stiffness	C_t	Nm/rad	109000
Weight without brake	m_{Mot}	kg	12.9
Motor data with integrated brake			
Moment of inertia with brake	$J_{Mot\ Br}$	kgm ²	$2.35 \cdot 10^{-3}$
Shaft torsional stiffness with brake	C_t	Nm/rad	76000
Weight with brake	$m_{Mot\ Br}$	kg	15.9
Recommended Motor Module 6SL312□-□TE21-0AA□			
Rated converter current	$I_{N\ Inv}$	A	9
Maximum converter current	$I_{max\ Inv}$	A	18
Max. torque at $I_{max\ Inv}$	$M_{max\ Inv}$	Nm	24.7
Maximum permissible speed (converter)	$n_{max\ Inv}$	rpm	6000

The rated data are valid for a 600 V DC link voltage.

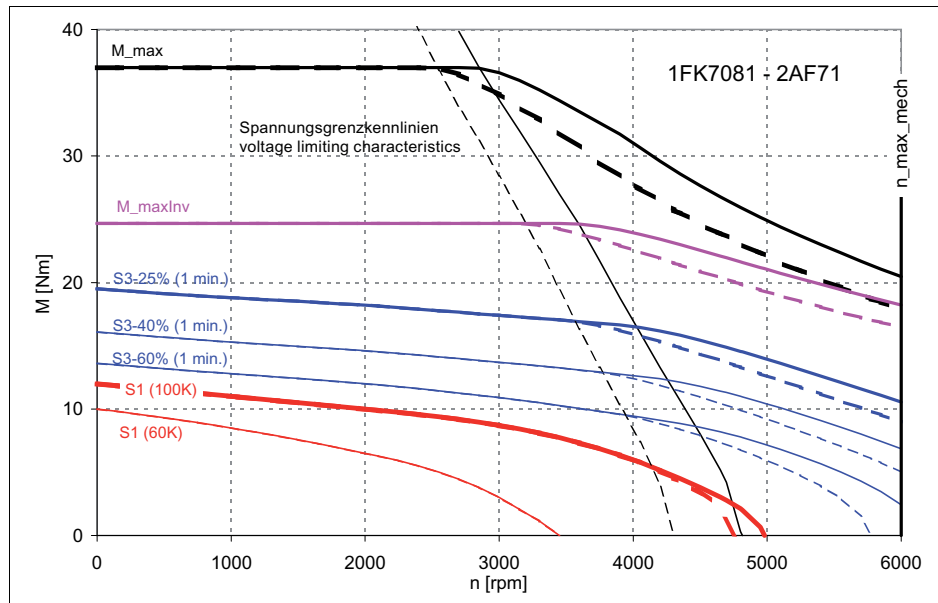

[—————] SINAMICS ALM 400 V-Netz (Zwischenkreisspannung 600 V DC) (DC-link voltage 600 V)

[- - - - -] SINAMICS BLM/SLM 400 V-Netz (Zwischenkreisspannung 540 V DC) (DC-link voltage 540 V)

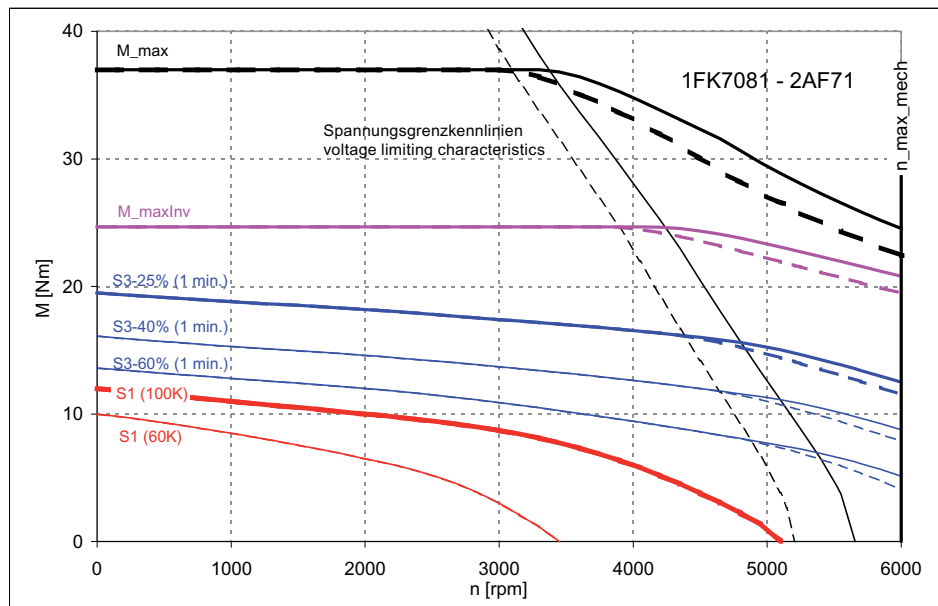

[—————] SINAMICS ALM 480 V-Netz (Zwischenkreisspannung 720 V DC) (DC-link voltage 720 V)

[- - - - -] SINAMICS BLM/SLM 480 V-Netz (Zwischenkreisspannung 650 V DC) (DC-link voltage 650 V)

Figure 4-27 1FK7081-2AF71

4.2 Torque-speed characteristic

Table 4- 27 1FK7081 Compact

Technical data	Code	Unit	-2AH71
Configuration data			
Rated speed	n_N	rpm	4500
Rated torque (100 K)	$M_N (100\text{ K})$	Nm	3.8
Rated current (100 K)	$I_N (100\text{ K})$	A	4.9
Static torque (100 K)	$M_0 (100\text{ K})$	Nm	12.0
Stall current (100 K)	$I_0 (100\text{ K})$	A	13.1
Static torque (60 K)	$M_0 (60\text{ K})$	Nm	10.0
Stall current (60 K)	$I_0 (60\text{ K})$	A	10.6
Optimum operating point			
Optimum speed	n_{opt}	rpm	3000
Optimum power	P_{opt}	kW	2.75
Limit data			
Max. permissible speed (mech.)	$n_{max\ mech}$	rpm	6000
Maximum torque	M_{max}	Nm	37.0
Maximum current	I_{max}	A	45.0
Motor data			
Pole number	2p		8
Torque constant (100 K)	k_T	Nm/A	0.915
Voltage constant (at 20 °C)	k_E	V/1000 rpm	59.0
Winding resistance (at 20 °C)	R_{ph}	Ω	0.1895
Rotating field inductance	L_D	mH	3.4
Electrical time constant	T_{el}	ms	17.9
Mechanical time constant	T_{mech}	ms	1.36
Thermal time constant	T_{th}	min	45
Moment of inertia	J_{Mot}	kgm ²	$2.00 \cdot 10^{-3}$
Shaft torsional stiffness	C_t	Nm/rad	109000
Weight without brake	m_{Mot}	kg	12.9
Motor data with integrated brake			
Moment of inertia with brake	$J_{Mot\ Br}$	kgm ²	$2.35 \cdot 10^{-3}$
Shaft torsional stiffness with brake	$C_t\ Br$	Nm/rad	76000
Weight with brake	$m_{Mot\ Br}$	kg	15.9
Recommended Motor Module 6SL312□-□TE21-8AA□			
Rated converter current	$I_{N\ Inv}$	A	18
Maximum converter current	$I_{max\ Inv}$	A	36
Max. torque at $I_{max\ Inv}$	$M_{max\ Inv}$	Nm	31.2
Maximum permissible speed (converter)	$n_{max\ Inv}$	rpm	6000

The rated data are valid for a 600 V DC link voltage.

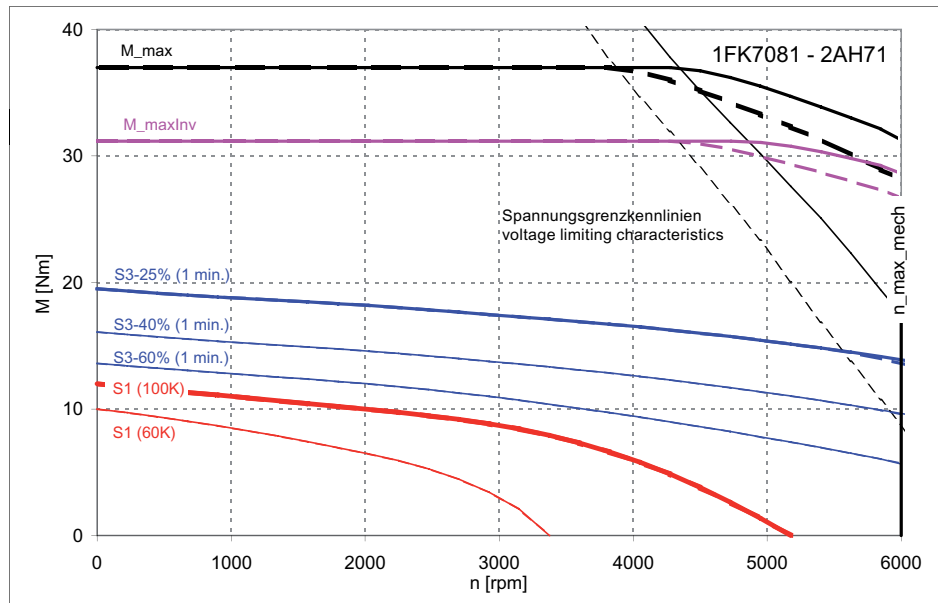

[—————] SINAMICS ALM 400 V-Netz (Zwischenkreisspannung 600 V DC) (DC-link voltage 600 V)
 [- - - - -] SINAMICS BLM/SLM 400 V-Netz (Zwischenkreisspannung 540 V DC) (DC-link voltage 540 V)

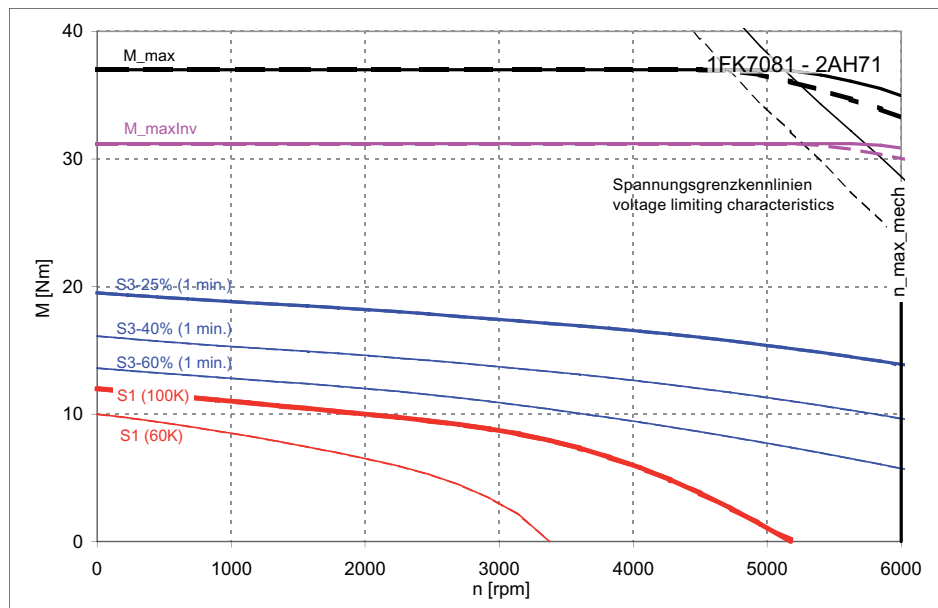

[—————] SINAMICS ALM 480 V-Netz (Zwischenkreisspannung 720 V DC) (DC-link voltage 720 V)
 [- - - - -] SINAMICS BLM/SLM 480 V-Netz (Zwischenkreisspannung 650 V DC) (DC-link voltage 650 V)

Figure 4-28 1FK7081-2AH71

4.2 Torque-speed characteristic

Table 4- 28 1FK7083 Compact

Technical data	Code	Unit	-2AC71
Configuration data			
Rated speed	n_N	rpm	2000
Rated torque (100 K)	$M_N (100\text{ K})$	Nm	12.5
Rated current (100 K)	$I_N (100\text{ K})$	A	6.3
Static torque (100 K)	$M_0 (100\text{ K})$	Nm	16.0
Stall current (100 K)	$I_0 (100\text{ K})$	A	7.5
Static torque (60 K)	$M_0 (60\text{ K})$	Nm	13.3
Stall current (60 K)	$I_0 (60\text{ K})$	A	6.1
Optimum operating point			
Optimum speed	n_{opt}	rpm	2000
Optimum power	P_{opt}	kW	2.6
Limit data			
Max. permissible speed (mech.)	$n_{max\ mech}$	rpm	6000
Maximum torque	M_{max}	Nm	50
Maximum current	I_{max}	A	27.5
Motor data			
Pole number	2p		8
Torque constant (100 K)	k_T	Nm/A	2.13
Voltage constant (at 20 °C)	k_E	V/1000 rpm	138.5
Winding resistance (at 20 °C)	R_{ph}	Ω	0.66
Rotating field inductance	L_D	mH	12.8
Electrical time constant	T_{el}	ms	19.4
Mechanical time constant	T_{mech}	ms	1.13
Thermal time constant	T_{th}	min	50
Moment of inertia	J_{Mot}	kgm ²	$2.60 \cdot 10^{-3}$
Shaft torsional stiffness	C_t	Nm/rad	101000
Weight without brake	m_{Mot}	kg	15.6
Motor data with integrated brake			
Moment of inertia with brake	$J_{Mot\ Br}$	kgm ²	$2.95 \cdot 10^{-3}$
Shaft torsional stiffness with brake	C_t	Nm/rad	72000
Weight with brake	$m_{Mot\ Br}$	kg	18.6
Recommended Motor Module 6SL312□-□TE21-0AA□			
Rated converter current	$I_{N\ Inv}$	A	9
Maximum converter current	$I_{max\ Inv}$	A	18
Max. torque at $I_{max\ Inv}$	$M_{max\ Inv}$	Nm	36.7
Maximum permissible speed (converter)	$n_{max\ Inv}$	rpm	4150

The rated data are valid for a 600 V DC link voltage.

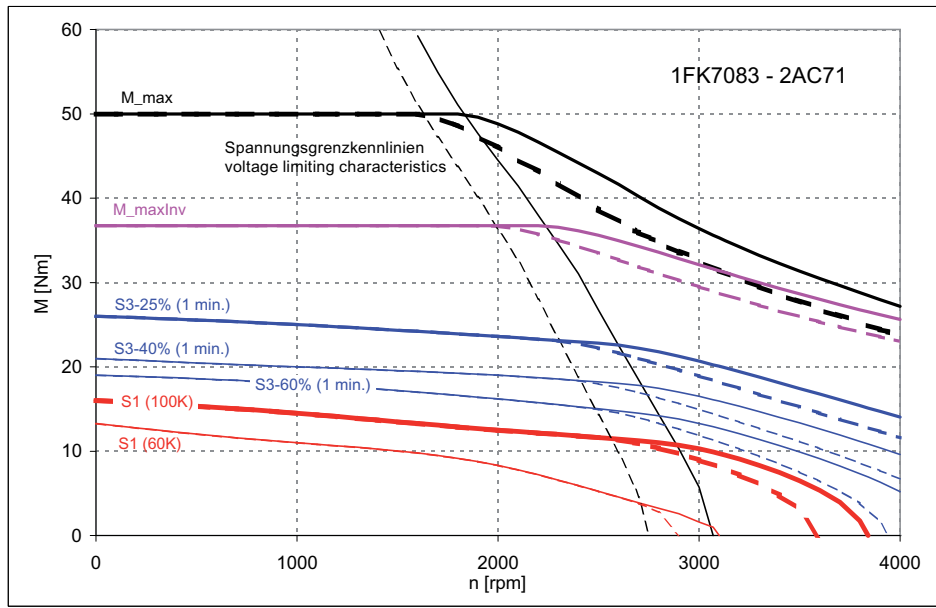

[—————] SINAMICS ALM 400 V-Netz (Zwischenkreisspannung 600 V DC) (DC-link voltage 600 V)

[- - - - -] SINAMICS BLM/SLM 400 V-Netz (Zwischenkreisspannung 540 V DC) (DC-link voltage 540 V)

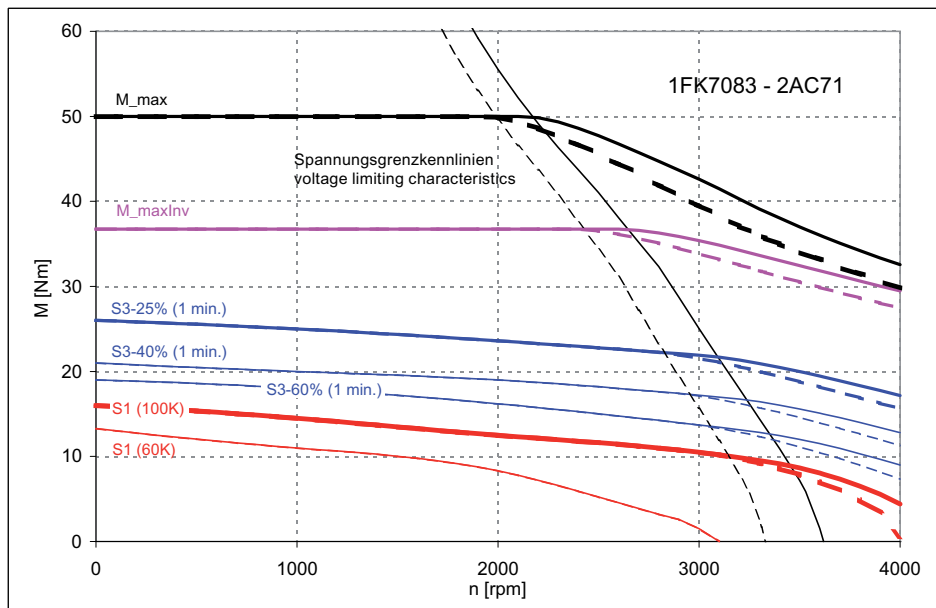

[—————] SINAMICS ALM 480 V-Netz (Zwischenkreisspannung 720 V DC) (DC-link voltage 720 V)

[- - - - -] SINAMICS BLM/SLM 480 V-Netz (Zwischenkreisspannung 650 V DC) (DC-link voltage 650 V)

Figure 4-29 1FK7083-2AC71

4.2 Torque-speed characteristic

Table 4- 29 1FK7083 Compact

Technical data	Code	Unit	-2AC71
Configuration data			
Rated speed	n_N	rpm	3000
Rated torque (100 K)	$M_N (100\text{ K})$	Nm	10.5
Rated current (100 K)	$I_N (100\text{ K})$	A	7.2
Static torque (100 K)	$M_0 (100\text{ K})$	Nm	16.0
Stall current (100 K)	$I_0 (100\text{ K})$	A	10.1
Static torque (60 K)	$M_0 (60\text{ K})$	Nm	13.3
Stall current (60 K)	$I_0 (60\text{ K})$	A	8.2
Optimum operating point			
Optimum speed	n_{opt}	rpm	3000
Optimum power	P_{opt}	kW	3.3
Limit data			
Max. permissible speed (mech.)	$n_{max\ mech}$	rpm	6000
Maximum torque	M_{max}	Nm	50
Maximum current	I_{max}	A	37.0
Motor data			
Pole number	2p		8
Torque constant (100 K)	k_T	Nm/A	1.58
Voltage constant (at 20 °C)	k_E	V/1000 rpm	102.5
Winding resistance (at 20 °C)	R_{ph}	Ω	0.377
Rotating field inductance	L_D	mH	7.0
Electrical time constant	T_{el}	ms	18.6
Mechanical time constant	T_{mech}	ms	1.18
Thermal time constant	T_{th}	min	50
Moment of inertia	J_{Mot}	kgm ²	$2.60 \cdot 10^{-3}$
Shaft torsional stiffness	C_t	Nm/rad	101000
Weight without brake	m_{Mot}	kg	15.6
Motor data with integrated brake			
Moment of inertia with brake	$J_{Mot\ Br}$	kgm ²	$2.95 \cdot 10^{-3}$
Shaft torsional stiffness with brake	$C_t\ Br$	Nm/rad	72000
Weight with brake	$m_{Mot\ Br}$	kg	18.6
Recommended Motor Module 6SL312□-□TE15-0AA□			
Rated converter current	$I_{N\ Inv}$	A	9
Maximum converter current	$I_{max\ Inv}$	A	18
Max. torque at $I_{max\ Inv}$	$M_{max\ Inv}$	Nm	28.5
Maximum permissible speed (converter)	$n_{max\ Inv}$	rpm	5600

The rated data are valid for a 600 V DC link voltage.

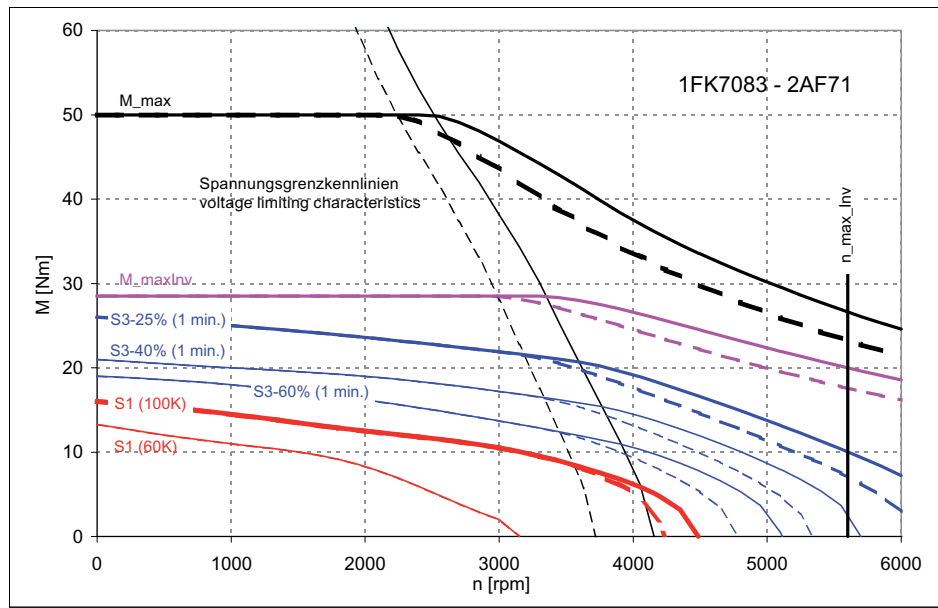

[—————] SINAMICS ALM 400 V-Netz (Zwischenkreisspannung 600 V DC) (DC-link voltage 600 V)

[- - - - -] SINAMICS BLM/SLM 400 V-Netz (Zwischenkreisspannung 540 V DC) (DC-link voltage 540 V)

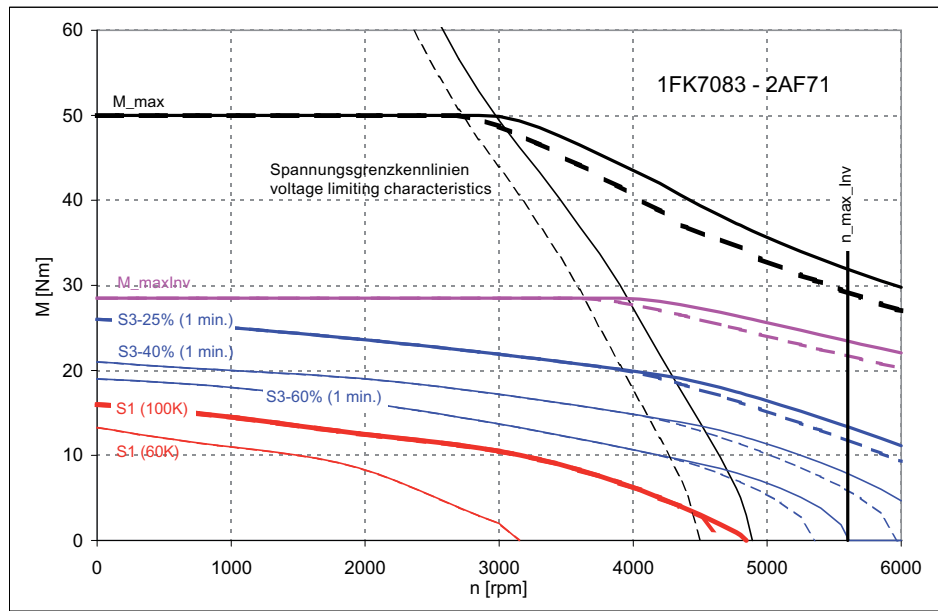

[—————] SINAMICS ALM 480 V-Netz (Zwischenkreisspannung 720 V DC) (DC-link voltage 720 V)

[- - - - -] SINAMICS BLM/SLM 480 V-Netz (Zwischenkreisspannung 650 V DC) (DC-link voltage 650 V)

Figure 4-30 1FK7083-2AF71

4.2 Torque-speed characteristic

Table 4- 30 1FK7083 Compact

Technical data	Code	Unit	-2AH71
Configuration data			
Rated speed	n_N	rpm	4500
Rated torque (100 K)	$M_N (100\text{ K})$	Nm	3.0
Rated current (100 K)	$I_N (100\text{ K})$	A	3.6
Static torque (100 K)	$M_0 (100\text{ K})$	Nm	16.0
Stall current (100 K)	$I_0 (100\text{ K})$	A	15.0
Static torque (60 K)	$M_0 (60\text{ K})$	Nm	13.3
Stall current (60 K)	$I_0 (60\text{ K})$	A	12.2
Optimum operating point			
Optimum speed	n_{opt}	rpm	3000
Optimum power	P_{opt}	kW	3.3
Limit data			
Max. permissible speed (mech.)	$n_{max\ mech}$	rpm	6000
Maximum torque	M_{max}	Nm	50
Maximum current	I_{max}	A	55
Motor data			
Pole number	2p		8
Torque constant (100 K)	k_T	Nm/A	1.065
Voltage constant (at 20 °C)	k_E	V/1000 rpm	69.0
Winding resistance (at 20 °C)	R_{ph}	Ω	0.1655
Rotating field inductance	L_D	mH	3.2
Electrical time constant	T_{el}	ms	19.3
Mechanical time constant	T_{mech}	ms	1.14
Thermal time constant	T_{th}	min	50
Moment of inertia	J_{Mot}	kgm ²	$2.60 \cdot 10^{-3}$
Shaft torsional stiffness	C_t	Nm/rad	101000
Weight without brake	m_{Mot}	kg	15.6
Motor data with integrated brake			
Moment of inertia with brake	$J_{Mot\ Br}$	kgm ²	$2.95 \cdot 10^{-3}$
Shaft torsional stiffness with brake	$C_t\ Br$	Nm/rad	72000
Weight with brake	$m_{Mot\ Br}$	kg	18.6
Recommended Motor Module 6SL312□-□TE21-8AA□			
Rated converter current	$I_{N\ Inv}$	A	18
Maximum converter current	$I_{max\ Inv}$	A	36
Max. torque at $I_{max\ Inv}$	$M_{max\ Inv}$	Nm	36.7
Maximum permissible speed (converter)	$n_{max\ Inv}$	rpm	6000

The rated data are valid for a 600 V DC link voltage.

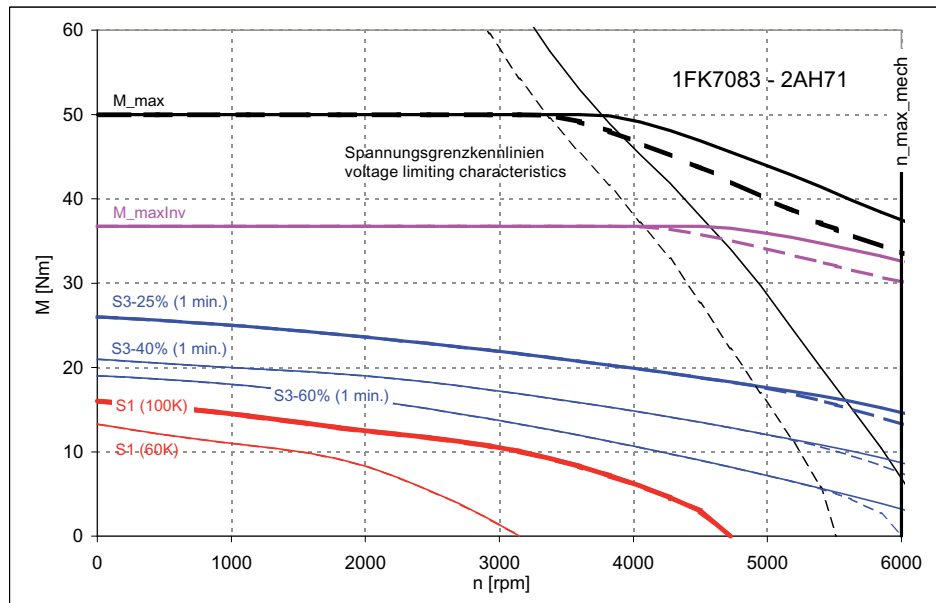

[—————] SINAMICS ALM 400 V-Netz (Zwischenkreisspannung 600 V DC) (DC-link voltage 600 V)

[- - - - -] SINAMICS BLM/SLM 400 V-Netz (Zwischenkreisspannung 540 V DC) (DC-link voltage 540 V)

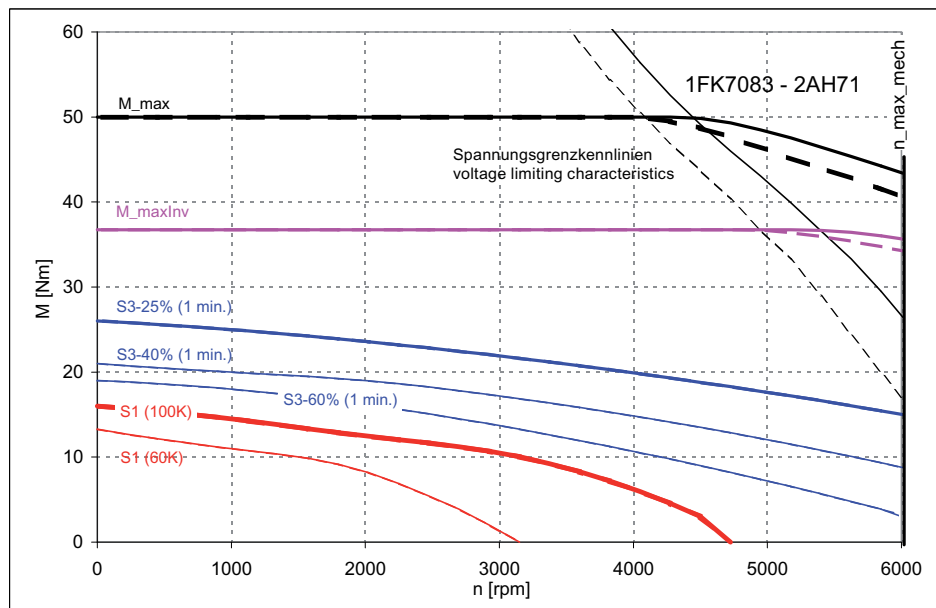

[—————] SINAMICS ALM 480 V-Netz (Zwischenkreisspannung 720 V DC) (DC-link voltage 720 V)

[- - - - -] SINAMICS BLM/SLM 480 V-Netz (Zwischenkreisspannung 650 V DC) (DC-link voltage 650 V)

Figure 4-31 1FK7083-2AH71

4.2 Torque-speed characteristic

Table 4- 31 1FK7084 Compact

Technical data	Code	Unit	-2AC71
Configuration data			
Rated speed	n_N	rpm	2000
Rated torque (100 K)	$M_N (100\text{ K})$	Nm	15.0
Rated current (100 K)	$I_N (100\text{ K})$	A	6.7
Static torque (100 K)	$M_0 (100\text{ K})$	Nm	20.0
Stall current (100 K)	$I_0 (100\text{ K})$	A	8.5
Static torque (60 K)	$M_0 (60\text{ K})$	Nm	16.6
Stall current (60 K)	$I_0 (60\text{ K})$	A	6.9
Optimum operating point			
Optimum speed	n_{opt}	rpm	2000
Optimum power	P_{opt}	kW	3.15
Limit data			
Max. permissible speed (mech.)	$n_{max\ mech}$	rpm	6000
Maximum torque	M_{max}	Nm	61
Maximum current	I_{max}	A	28.5
Motor data			
Pole number	2p		8
Torque constant (100 K)	k_T	Nm/A	2.36
Voltage constant (at 20 °C)	k_E	V/1000 rpm	152.0
Winding resistance (at 20 °C)	R_{ph}	Ω	0.585
Rotating field inductance	L_D	mH	12.0
Electrical time constant	T_{el}	ms	20.5
Mechanical time constant	T_{mech}	ms	1.02
Thermal time constant	T_{th}	min	55
Moment of inertia	J_{Mot}	kgm ²	$3.25 \cdot 10^{-3}$
Shaft torsional stiffness	C_t	Nm/rad	93000
Weight without brake	m_{Mot}	kg	18.3
Motor data with integrated brake			
Moment of inertia with brake	$J_{Mot\ Br}$	kgm ²	$3.55 \cdot 10^{-3}$
Shaft torsional stiffness with brake	$C_t\ Br$	Nm/rad	68000
Weight with brake	$m_{Mot\ Br}$	kg	21.3
Recommended Motor Module 6SL312□-□TE21-0AA□□			
Rated converter current	$I_{N\ Inv}$	A	9
Maximum converter current	$I_{max\ Inv}$	A	18
Max. torque at $I_{max\ Inv}$	$M_{max\ Inv}$	Nm	41.9
Maximum permissible speed (converter)	$n_{max\ Inv}$	rpm	3800

The rated data are valid for a 600 V DC link voltage.

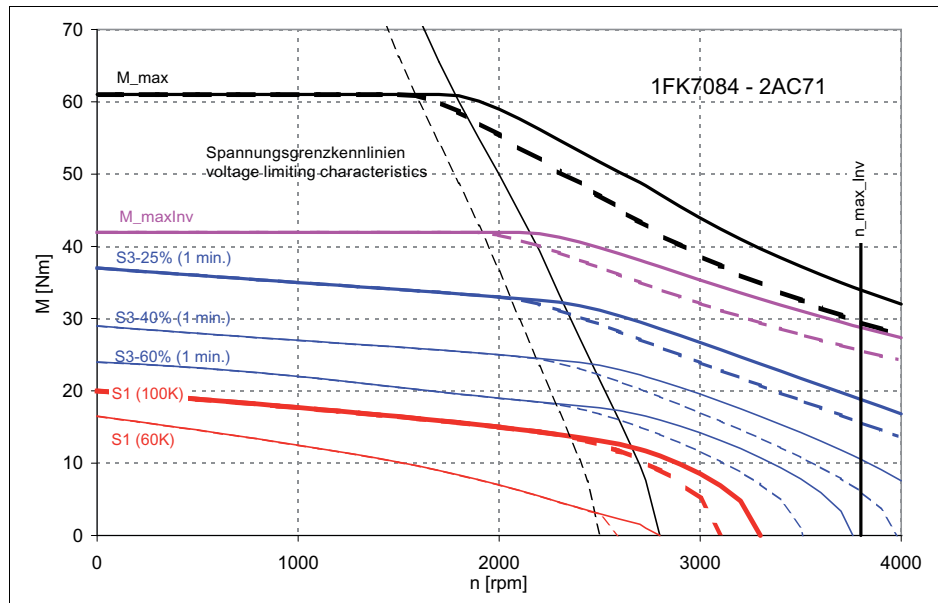

[—————] SINAMICS ALM 400 V-Netz (Zwischenkreisspannung 600 V DC) (DC-link voltage 600 V)

[- - - - -] SINAMICS BLM/SLM 400 V-Netz (Zwischenkreisspannung 540 V DC) (DC-link voltage 540 V)

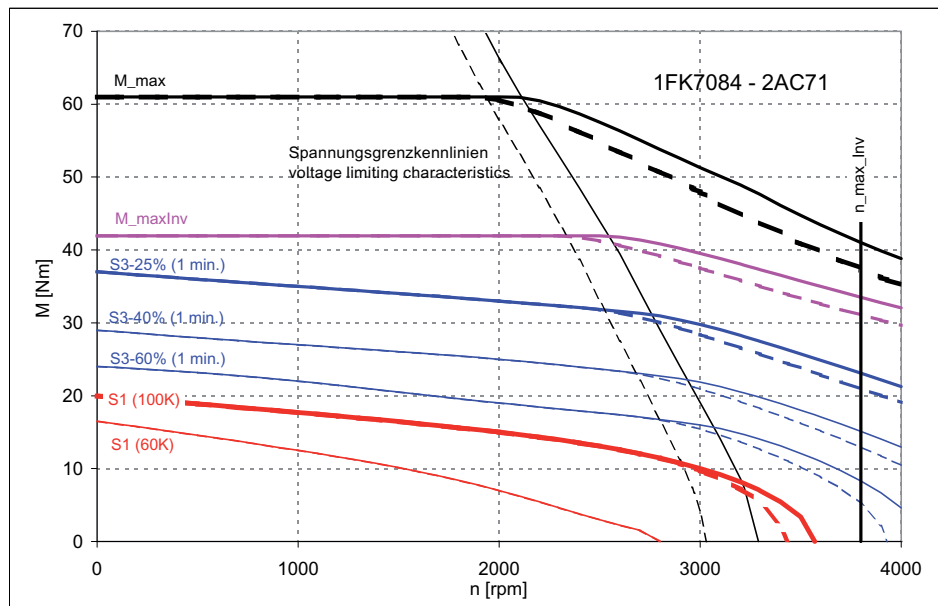

[—————] SINAMICS ALM 480 V-Netz (Zwischenkreisspannung 720 V DC) (DC-link voltage 720 V)

[- - - - -] SINAMICS BLM/SLM 480 V-Netz (Zwischenkreisspannung 650 V DC) (DC-link voltage 650 V)

Figure 4-32 1FK7084-2AC71

4.2 Torque-speed characteristic

Table 4- 32 1FK7084 Compact

Technical data	Code	Unit	-2AF71
Configuration data			
Rated speed	n_N	rpm	3000
Rated torque (100 K)	$M_N (100\text{ K})$	Nm	10.0
Rated current (100 K)	$I_N (100\text{ K})$	A	6.5
Static torque (100 K)	$M_0 (100\text{ K})$	Nm	20.0
Stall current (100 K)	$I_0 (100\text{ K})$	A	12.1
Static torque (60 K)	$M_0 (60\text{ K})$	Nm	16.6
Stall current (60 K)	$I_0 (60\text{ K})$	A	9.8
Optimum operating point			
Optimum speed	n_{opt}	rpm	2500
Optimum power	P_{opt}	kW	3.25
Limit data			
Max. permissible speed (mech.)	$n_{max\ mech}$	rpm	6000
Maximum torque	M_{max}	Nm	61
Maximum current	I_{max}	A	41.0
Motor data			
Pole number	2p		8
Torque constant (100 K)	k_T	Nm/A	1.655
Voltage constant (at 20 °C)	k_E	V/1000 rpm	106.5
Winding resistance (at 20 °C)	R_{ph}	Ω	0.284
Rotating field inductance	L_D	mH	5.9
Electrical time constant	T_{el}	ms	21.0
Mechanical time constant	T_{mech}	ms	1.01
Thermal time constant	T_{th}	min	55
Moment of inertia	J_{Mot}	kgm ²	$3.25 \cdot 10^{-3}$
Shaft torsional stiffness	C_t	Nm/rad	93000
Weight without brake	m_{Mot}	kg	18.3
Motor data with integrated brake			
Moment of inertia with brake	$J_{Mot\ Br}$	kgm ²	$3.55 \cdot 10^{-3}$
Shaft torsional stiffness with brake	$C_t\ Br$	Nm/rad	68000
Weight with brake	$m_{Mot\ Br}$	kg	21.3
Recommended Motor Module 6SL312□-□TE21-8AA□			
Rated converter current	$I_{N\ Inv}$	A	18
Maximum converter current	$I_{max\ Inv}$	A	36
Max. torque at $I_{max\ Inv}$	$M_{max\ Inv}$	Nm	55
Maximum permissible speed (converter)	$n_{max\ Inv}$	rpm	5400

The rated data are valid for a 600 V DC link voltage.

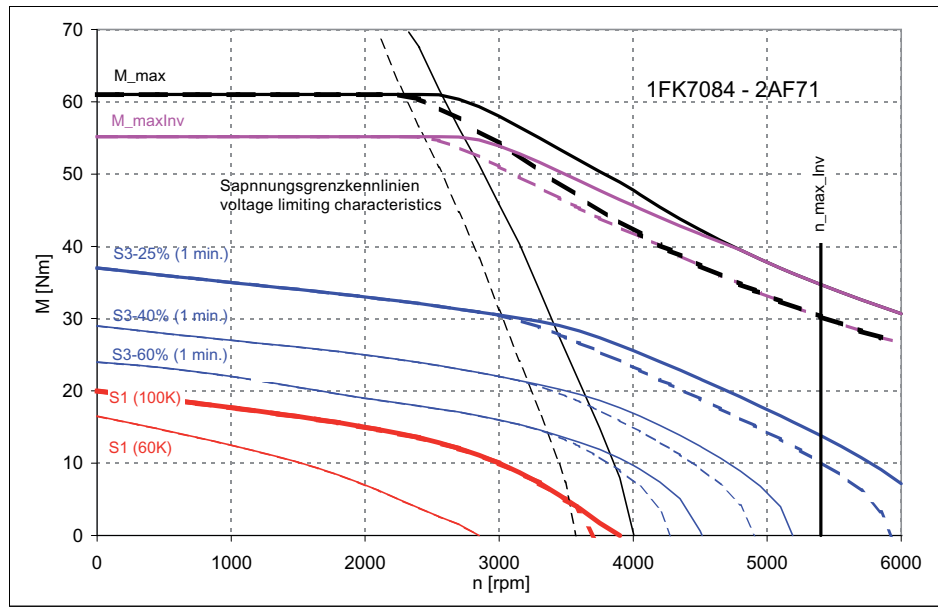

[———] SINAMICS ALM 400 V-Netz (Zwischenkreisspannung 600 V DC) (DC-link voltage 600 V)

[- - - -] SINAMICS BLM/SLM 400 V-Netz (Zwischenkreisspannung 540 V DC) (DC-link voltage 540 V)

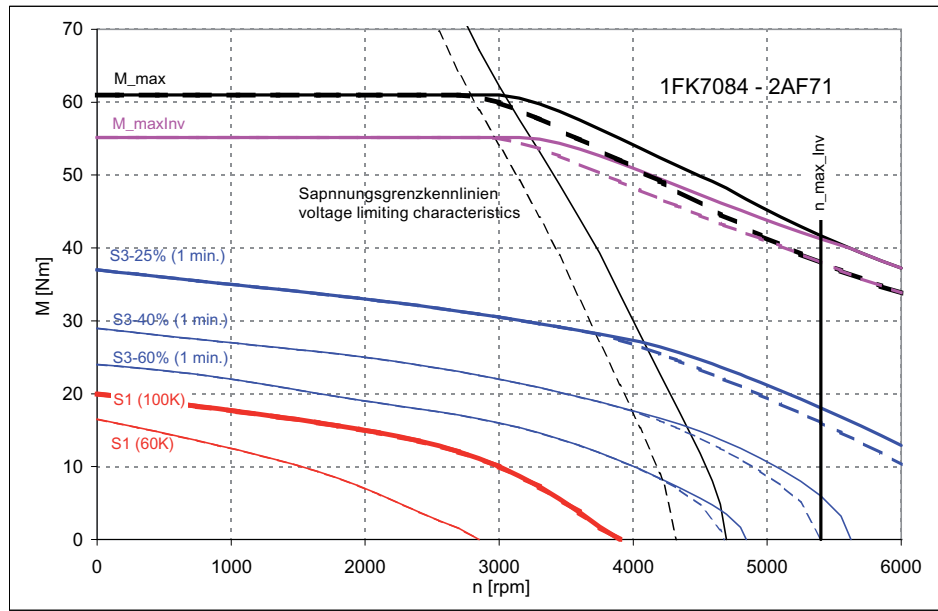

[———] SINAMICS ALM 480 V-Netz (Zwischenkreisspannung 720 V DC) (DC-link voltage 720 V)

[- - - -] SINAMICS BLM/SLM 480 V-Netz (Zwischenkreisspannung 650 V DC) (DC-link voltage 650 V)

Figure 4-33 1FK7084-2AF71

4.2 Torque-speed characteristic

Table 4- 33 1FK7100 Compact

Technical data	Code	Unit	-2AC71
Configuration data			
Rated speed	n_N	rpm	2000
Rated torque (100 K)	$M_N (100\text{ K})$	Nm	14.5
Rated current (100 K)	$I_N (100\text{ K})$	A	7.1
Static torque (100 K)	$M_0 (100\text{ K})$	Nm	18.0
Stall current (100 K)	$I_0 (100\text{ K})$	A	8.4
Static torque (60 K)	$M_0 (60\text{ K})$	Nm	14.9
Stall current (60 K)	$I_0 (60\text{ K})$	A	6.8
Optimum operating point			
Optimum speed	n_{opt}	rpm	2000
Optimum power	P_{opt}	kW	3.05
Limit data			
Max. permissible speed (mech.)	$n_{max\ mech}$	rpm	5000
Maximum torque	M_{max}	Nm	55
Maximum current	I_{max}	A	28.0
Motor data			
Pole number	2p		8
Torque constant (100 K)	k_T	Nm/A	2.14
Voltage constant (at 20 °C)	k_E	V/1000 rpm	138.0
Winding resistance (at 20 °C)	R_{ph}	Ω	0.55
Rotating field inductance	L_D	mH	12.7
Electrical time constant	T_{el}	ms	23.0
Mechanical time constant	T_{mech}	ms	1.95
Thermal time constant	T_{th}	min	55
Moment of inertia	J_{Mot}	kgm ²	$5.40 \cdot 10^{-3}$
Shaft torsional stiffness	C_t	Nm/rad	183000
Weight without brake	m_{Mot}	kg	17.6
Motor data with integrated brake			
Moment of inertia with brake	$J_{Mot\ Br}$	kgm ²	$6.20 \cdot 10^{-3}$
Shaft torsional stiffness with brake	$C_t\ Br$	Nm/rad	135000
Weight with brake	$m_{Mot\ Br}$	kg	21.0
Recommended Motor Module 6SL312□-□TE21-0AA□			
Rated converter current	$I_{N\ Inv}$	A	9
Maximum converter current	$I_{max\ Inv}$	A	18
Max. torque at $I_{max\ Inv}$	$M_{max\ Inv}$	Nm	38.1
Maximum permissible speed (converter)	$n_{max\ Inv}$	rpm	4200

The rated data are valid for a 600 V DC link voltage.

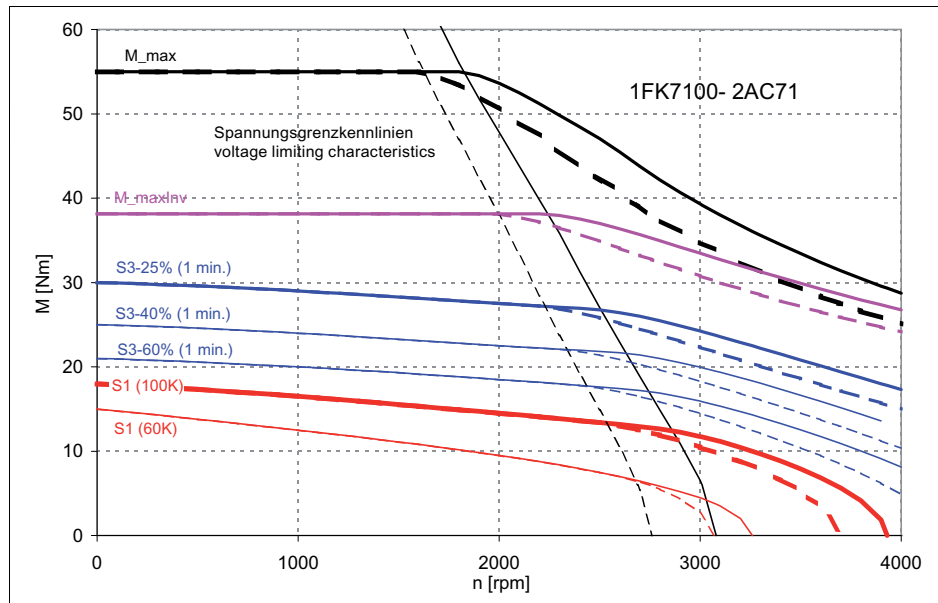

[—————] SINAMICS ALM 400 V-Netz (Zwischenkreisspannung 600 V DC) (DC-link voltage 600 V)

[- - - - -] SINAMICS BLM/SLM 400 V-Netz (Zwischenkreisspannung 540 V DC) (DC-link voltage 540 V)

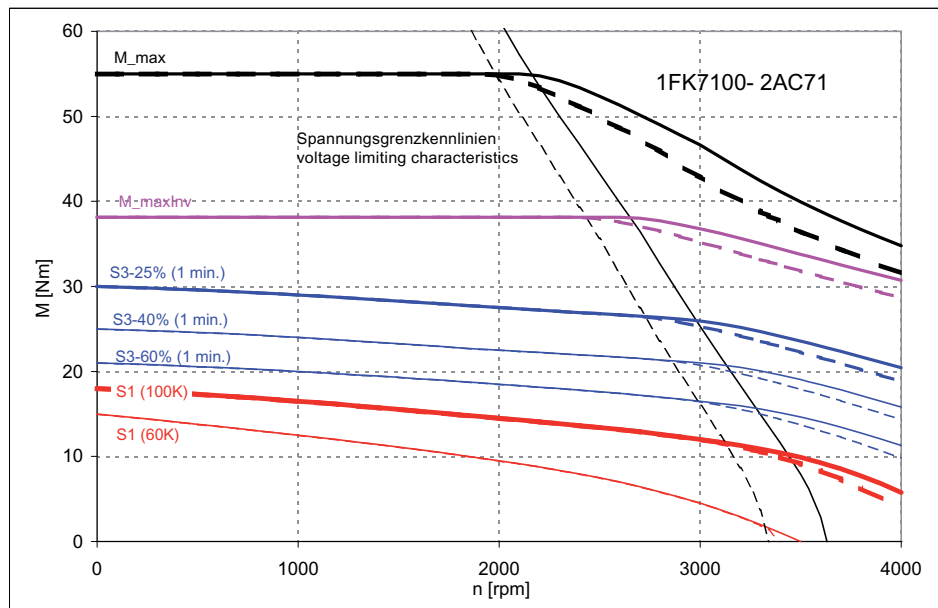

[—————] SINAMICS ALM 480 V-Netz (Zwischenkreisspannung 720 V DC) (DC-link voltage 720 V)

[- - - - -] SINAMICS BLM/SLM 480 V-Netz (Zwischenkreisspannung 650 V DC) (DC-link voltage 650 V)

Figure 4-34 1FK7100-2AC71

4.2 Torque-speed characteristic

Table 4- 34 1FK7100 Compact

Technical data	Code	Unit	-2AF71
Configuration data			
Rated speed	n_N	rpm	3000
Rated torque (100 K)	$M_N (100\text{ K})$	Nm	12.0
Rated current (100 K)	$I_N (100\text{ K})$	A	8.0
Static torque (100 K)	$M_0 (100\text{ K})$	Nm	18.0
Stall current (100 K)	$I_0 (100\text{ K})$	A	11.1
Static torque (60 K)	$M_0 (60\text{ K})$	Nm	14.9
Stall current (60 K)	$I_0 (60\text{ K})$	A	9.0
Optimum operating point			
Optimum speed	n_{opt}	rpm	3000
Optimum power	P_{opt}	kW	3.75
Limit data			
Max. permissible speed (mech.)	$n_{max\ mech}$	rpm	5000
Maximum torque	M_{max}	Nm	55
Maximum current	I_{max}	A	37.0
Motor data			
Pole number	2p		8
Torque constant (100 K)	k_T	Nm/A	1.62
Voltage constant (at 20 °C)	k_E	V/1000 rpm	104.5
Winding resistance (at 20 °C)	R_{ph}	Ω	0.324
Rotating field inductance	L_D	mH	7.3
Electrical time constant	T_{el}	ms	22.5
Mechanical time constant	T_{mech}	ms	2.0
Thermal time constant	T_{th}	min	55
Moment of inertia	J_{Mot}	kgm ²	$5.40 \cdot 10^{-3}$
Shaft torsional stiffness	C_t	Nm/rad	183000
Weight without brake	m_{Mot}	kg	17.6
Motor data with integrated brake			
Moment of inertia with brake	$J_{Mot\ Br}$	kgm ²	$6.20 \cdot 10^{-3}$
Shaft torsional stiffness with brake	$C_t\ Br$	Nm/rad	135000
Weight with brake	$m_{Mot\ Br}$	kg	21.0
Recommended Motor Module 6SL312□-□TE21-8AA□			
Rated converter current	$I_{N\ Inv}$	A	18
Maximum converter current	$I_{max\ Inv}$	A	36
Max. torque at $I_{max\ Inv}$	$M_{max\ Inv}$	Nm	54
Maximum permissible speed (converter)	$n_{max\ Inv}$	rpm	5000

The rated data are valid for a 600 V DC link voltage.

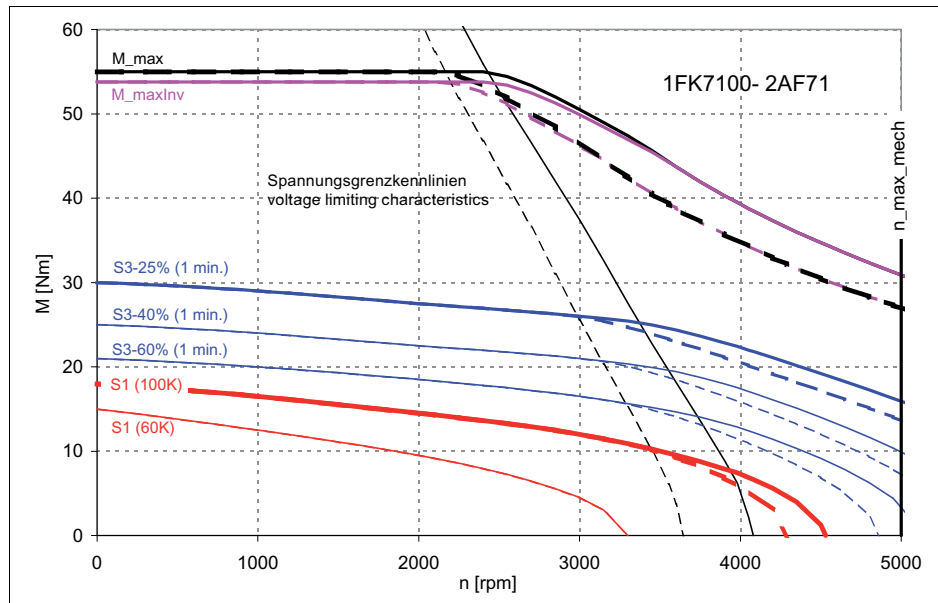

[—————] SINAMICS ALM 400 V-Netz (Zwischenkreisspannung 600 V DC) (DC-link voltage 600 V)

[- - - - -] SINAMICS BLM/SLM 400 V-Netz (Zwischenkreisspannung 540 V DC) (DC-link voltage 540 V)

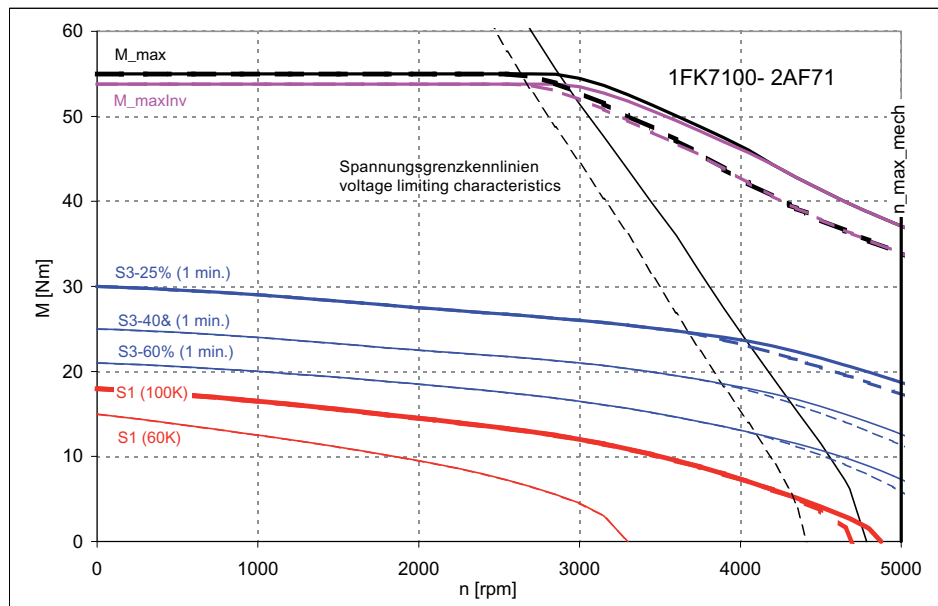

[—————] SINAMICS ALM 480 V-Netz (Zwischenkreisspannung 720 V DC) (DC-link voltage 720 V)

[- - - - -] SINAMICS BLM/SLM 480 V-Netz (Zwischenkreisspannung 650 V DC) (DC-link voltage 650 V)

Figure 4-35 1FK7100-2AF71

4.2 Torque-speed characteristic

Table 4- 35 1FK7101 Compact

Technical data	Code	Unit	-2AC71
Configuration data			
Rated speed	n_N	rpm	2000
Rated torque (100 K)	$M_N (100\text{ K})$	Nm	20.5
Rated current (100 K)	$I_N (100\text{ K})$	A	9.7
Static torque (100 K)	$M_0 (100\text{ K})$	Nm	27.0
Stall current (100 K)	$I_0 (100\text{ K})$	A	12.3
Static torque (60 K)	$M_0 (60\text{ K})$	Nm	22.5
Stall current (60 K)	$I_0 (60\text{ K})$	A	10.0
Optimum operating point			
Optimum speed	n_{opt}	rpm	2000
Optimum power	P_{opt}	kW	4.3
Limit data			
Max. permissible speed (mech.)	$n_{max\ mech}$	rpm	5000
Maximum torque	M_{max}	Nm	80
Maximum current	I_{max}	A	40.5
Motor data			
Pole number	2p		8
Torque constant (100 K)	k_T	Nm/A	2.15
Voltage constant (at 20 °C)	k_E	V/1000 rpm	144.5
Winding resistance (at 20 °C)	R_{ph}	Ω	0.343
Rotating field inductance	L_D	mH	8.5
Electrical time constant	T_{el}	ms	25.0
Mechanical time constant	T_{mech}	ms	1.62
Thermal time constant	T_{th}	min	60
Moment of inertia	J_{Mot}	kgm ²	$7.9 \cdot 10^{-3}$
Shaft torsional stiffness	C_t	Nm/rad	164000
Weight without brake	m_{Mot}	kg	23.0
Motor data with integrated brake			
Moment of inertia with brake	$J_{Mot\ Br}$	kgm ²	$8.7 \cdot 10^{-3}$
Shaft torsional stiffness with brake	$C_t\ Br$	Nm/rad	116000
Weight with brake	$m_{Mot\ Br}$	kg	27.5
Recommended Motor Module 6SL312□-□TE21-8AA□			
Rated converter current	$I_{N\ Inv}$	A	18
Maximum converter current	$I_{max\ Inv}$	A	36
Max. torque at $I_{max\ Inv}$	$M_{max\ Inv}$	Nm	73
Maximum permissible speed (converter)	$n_{max\ Inv}$	rpm	4000

The rated data are valid for a 600 V DC link voltage.

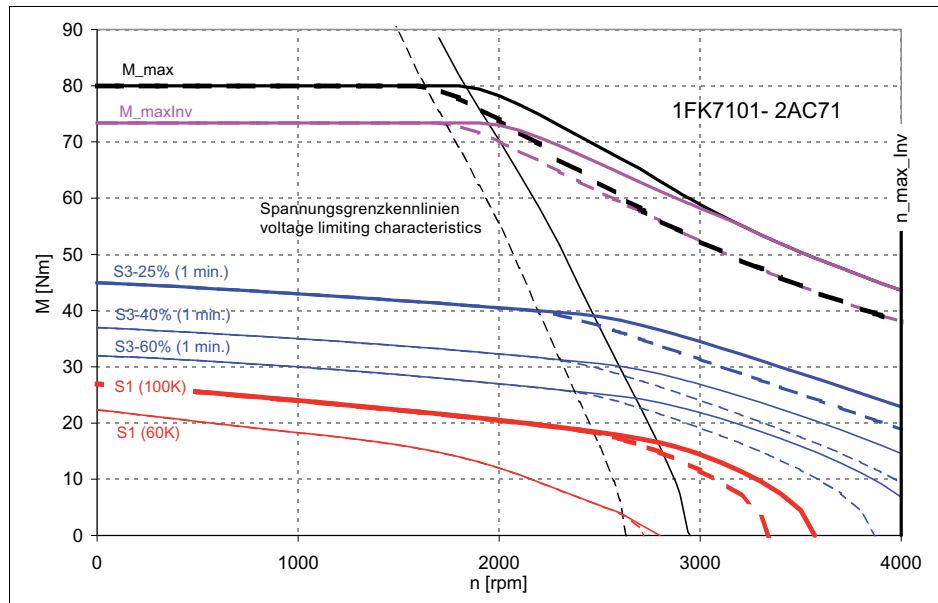

[———] SINAMICS ALM 400 V-Netz (Zwischenkreisspannung 600 V DC) (DC-link voltage 600 V)
 [- - - -] SINAMICS BLM/SLM 400 V-Netz (Zwischenkreisspannung 540 V DC) (DC-link voltage 540 V)

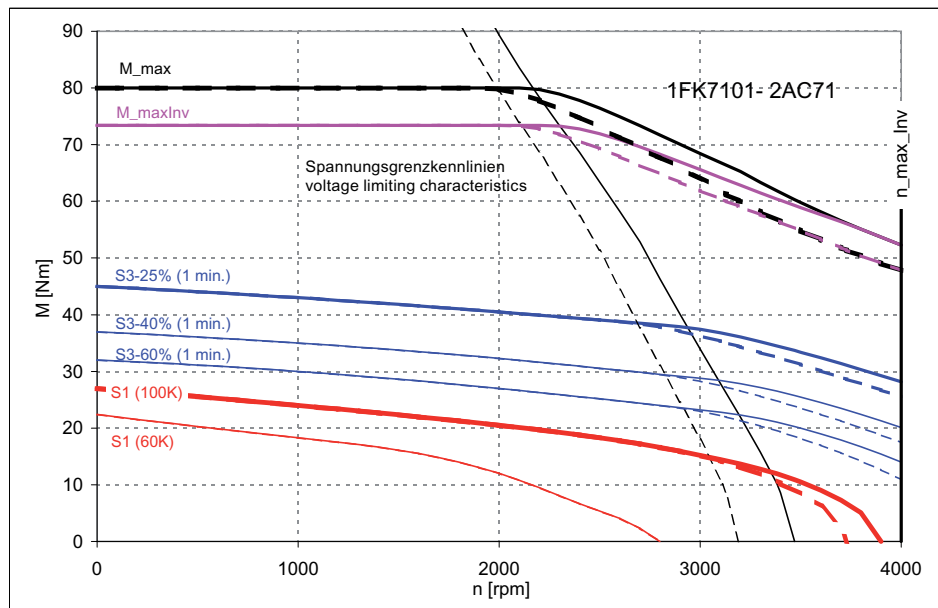

[———] SINAMICS ALM 480 V-Netz (Zwischenkreisspannung 720 V DC) (DC-link voltage 720 V)
 [- - - -] SINAMICS BLM/SLM 480 V-Netz (Zwischenkreisspannung 650 V DC) (DC-link voltage 650 V)

Figure 4-36 1FK7101-2AC71

4.2 Torque-speed characteristic

Table 4- 36 1FK7101 Compact

Technical data	Code	Unit	-2AF71
Configuration data			
Rated speed	n_N	rpm	3000
Rated torque (100 K)	$M_N (100\text{ K})$	Nm	15.5
Rated current (100 K)	$I_N (100\text{ K})$	A	11.6
Static torque (100 K)	$M_0 (100\text{ K})$	Nm	27.0
Stall current (100 K)	$I_0 (100\text{ K})$	A	18.8
Static torque (60 K)	$M_0 (60\text{ K})$	Nm	22.5
Stall current (60 K)	$I_0 (60\text{ K})$	A	15.2
Optimum operating point			
Optimum speed	n_{opt}	rpm	3000
Optimum power	P_{opt}	kW	4.85
Limit data			
Max. permissible speed (mech.)	$n_{max\ mech}$	rpm	5000
Maximum torque	M_{max}	Nm	80
Maximum current	I_{max}	A	63
Motor data			
Pole number	2p		8
Torque constant (100 K)	k_T	Nm/A	1.435
Voltage constant (at 20 °C)	k_E	V/1000 rpm	92.5
Winding resistance (at 20 °C)	R_{ph}	Ω	0.141
Rotating field inductance	L_D	mH	3.5
Electrical time constant	T_{el}	ms	25.0
Mechanical time constant	T_{mech}	ms	1.62
Thermal time constant	T_{th}	min	60
Moment of inertia	J_{Mot}	kgm ²	$7.9 \cdot 10^{-3}$
Shaft torsional stiffness	C_t	Nm/rad	164000
Weight without brake	m_{Mot}	kg	23.0
Motor data with integrated brake			
Moment of inertia with brake	$J_{Mot\ Br}$	kgm ²	$8.7 \cdot 10^{-3}$
Shaft torsional stiffness with brake	$C_t\ Br$	Nm/rad	116000
Weight with brake	$m_{Mot\ Br}$	kg	27.5
Recommended Motor Module 6SL312□-□TE21-8AA□			
Rated converter current	$I_{N\ Inv}$	A	18
Maximum converter current	$I_{max\ Inv}$	A	36
Max. torque at $I_{max\ Inv}$	$M_{max\ Inv}$	Nm	52
Maximum permissible speed (converter)	$n_{max\ Inv}$	rpm	5000

The rated data are valid for a 600 V DC link voltage.

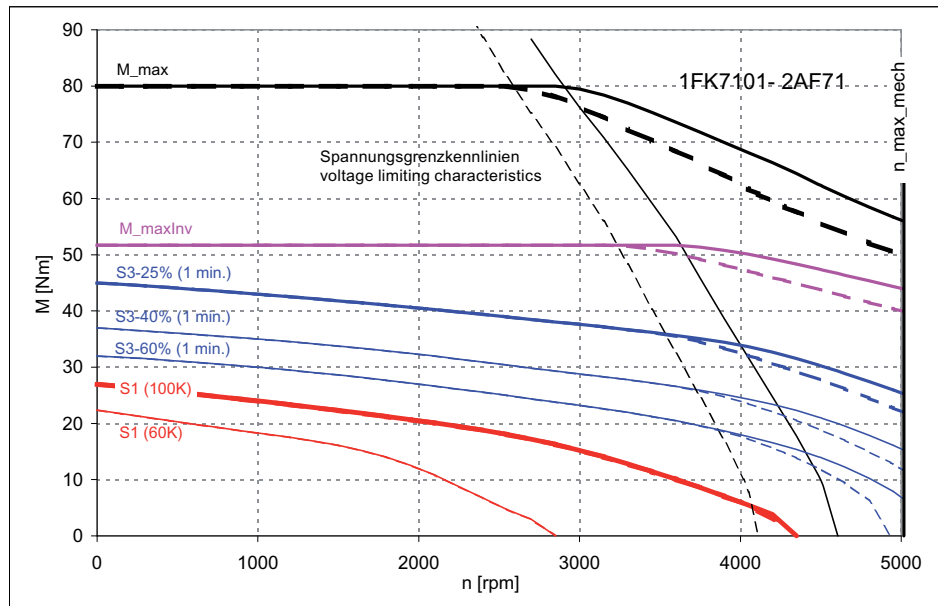

[—————] SINAMICS ALM 400 V-Netz (Zwischenkreisspannung 600 V DC) (DC-link voltage 600 V)

[-----] SINAMICS BLM/SLM 400 V-Netz (Zwischenkreisspannung 540 V DC) (DC-link voltage 540 V)

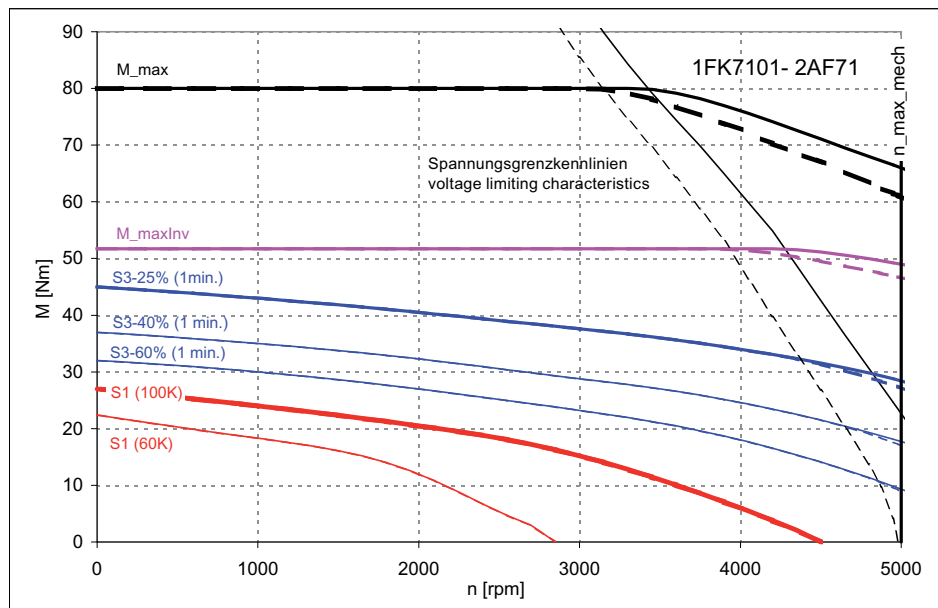

[—————] SINAMICS ALM 480 V-Netz (Zwischenkreisspannung 720 V DC) (DC-link voltage 720 V)

[-----] SINAMICS BLM/SLM 480 V-Netz (Zwischenkreisspannung 650 V DC) (DC-link voltage 650 V)

Figure 4-37 1FK7101-2AF71

4.2 Torque-speed characteristic

Table 4- 37 1FK7103 Compact

Technical data	Code	Unit	-2AC71
Configuration data			
Rated speed	n_N	rpm	2000
Rated torque (100 K)	$M_N (100\text{ K})$	Nm	25.0
Rated current (100 K)	$I_N (100\text{ K})$	A	11.0
Static torque (100 K)	$M_0 (100\text{ K})$	Nm	36.0
Stall current (100 K)	$I_0 (100\text{ K})$	A	14.4
Static torque (60 K)	$M_0 (60\text{ K})$	Nm	30.0
Stall current (60 K)	$I_0 (60\text{ K})$	A	11.6
Optimum operating point			
Optimum speed	n_{opt}	rpm	2000
Optimum power	P_{opt}	kW	5.2
Limit data			
Max. permissible speed (mech.)	$n_{max\ mech}$	rpm	5000
Maximum torque	M_{max}	Nm	108
Maximum current	I_{max}	A	46.5
Motor data			
Pole number	2p		8
Torque constant (100 K)	k_T	Nm/A	2.45
Voltage constant (at 20 °C)	k_E	V/1000 rpm	162.0
Winding resistance (at 20 °C)	R_{ph}	Ω	0.288
Rotating field inductance	L_D	mH	7.9
Electrical time constant	T_{el}	ms	27.5
Mechanical time constant	T_{mech}	ms	1.43
Thermal time constant	T_{th}	min	65
Moment of inertia	J_{Mot}	kgm ²	$10.4 \cdot 10^{-3}$
Shaft torsional stiffness	C_t	Nm/rad	148000
Weight without brake	m_{Mot}	kg	28.5
Motor data with integrated brake			
Moment of inertia with brake	$J_{Mot\ Br}$	kgm ²	$11.2 \cdot 10^{-3}$
Shaft torsional stiffness with brake	$C_t\ Br$	Nm/rad	108000
Weight with brake	$m_{Mot\ Br}$	kg	33.0
Recommended Motor Module 6SL312□-□TE21-8AA□			
Rated converter current	$I_{N\ Inv}$	A	18
Maximum converter current	$I_{max\ Inv}$	A	36
Max. torque at $I_{max\ Inv}$	$M_{max\ Inv}$	Nm	87
Maximum permissible speed (converter)	$n_{max\ Inv}$	rpm	3550

The rated data are valid for a 600 V DC link voltage.

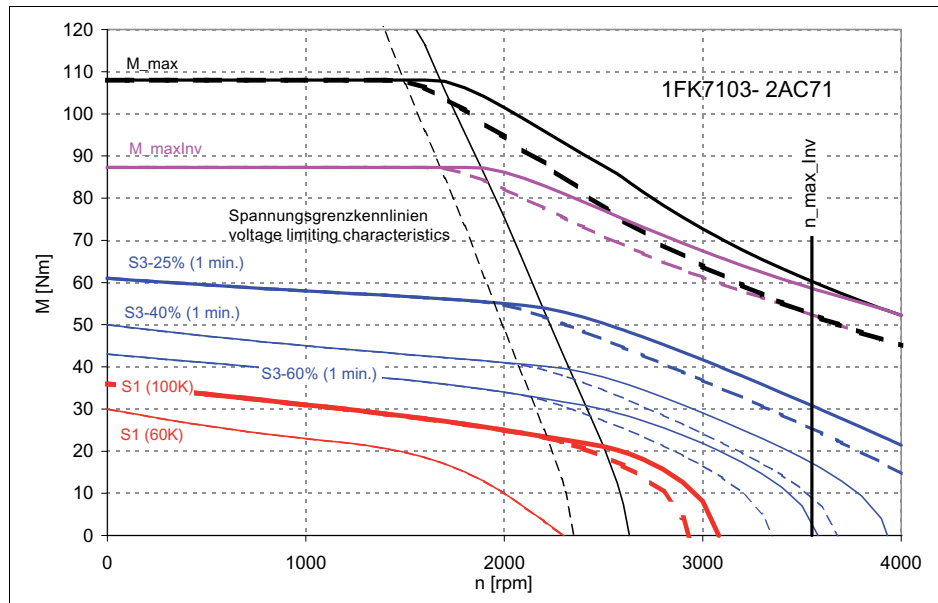

[—————] SINAMICS ALM 400 V-Netz (Zwischenkreisspannung 600 V DC) (DC-link voltage 600 V)

[- - - - -] SINAMICS BLM/SLM 400 V-Netz (Zwischenkreisspannung 540 V DC) (DC-link voltage 540 V)

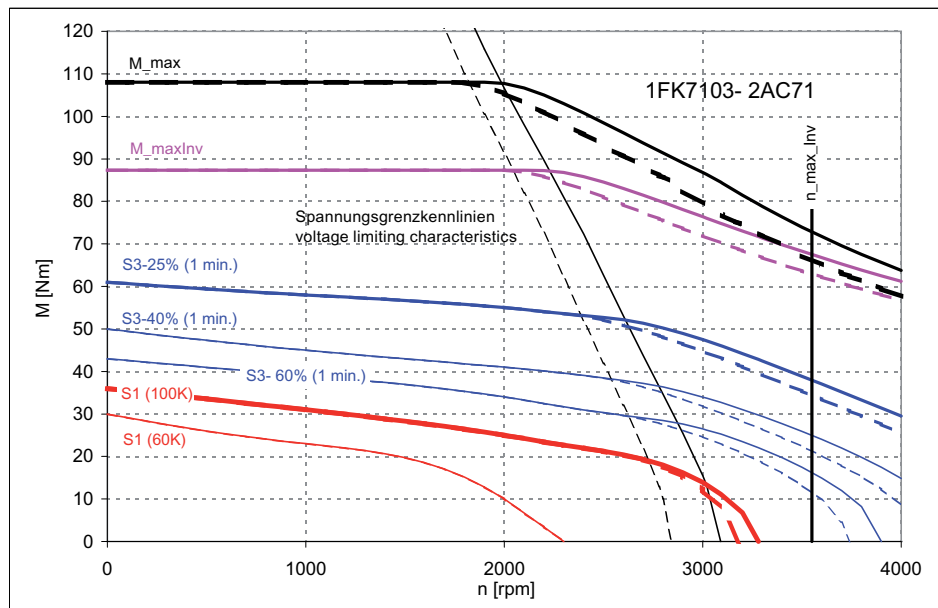

[—————] SINAMICS ALM 480 V-Netz (Zwischenkreisspannung 720 V DC) (DC-link voltage 720 V)

[- - - - -] SINAMICS BLM/SLM 480 V-Netz (Zwischenkreisspannung 650 V DC) (DC-link voltage 650 V)

Figure 4-38 1FK7103-2AC71

4.2 Torque-speed characteristic

Table 4- 38 1FK7103 Compact

Technical data	Code	Unit	-2AF71
Configuration data			
Rated speed	n_N	rpm	3000
Rated torque (100 K)	$M_N (100\text{ K})$	Nm	14.0
Rated current (100 K)	$I_N (100\text{ K})$	A	11.5
Static torque (100 K)	$M_0 (100\text{ K})$	Nm	36.0
Stall current (100 K)	$I_0 (100\text{ K})$	A	26.0
Static torque (60 K)	$M_0 (60\text{ K})$	Nm	30.0
Stall current (60 K)	$I_0 (60\text{ K})$	A	21.0
Optimum operating point			
Optimum speed	n_{opt}	rpm	2500
Optimum power	P_{opt}	kW	5.4
Limit data			
Max. permissible speed (mech.)	$n_{max\ mech}$	rpm	5000
Maximum torque	M_{max}	Nm	108
Maximum current	I_{max}	A	84
Motor data			
Pole number	2p		8
Torque constant (100 K)	k_T	Nm/A	1.385
Voltage constant (at 20 °C)	k_E	V/1000 rpm	89.5
Winding resistance (at 20 °C)	R_{ph}	Ω	0.0895
Rotating field inductance	L_D	mH	2.4
Electrical time constant	T_{el}	ms	27.0
Mechanical time constant	T_{mech}	ms	1.46
Thermal time constant	T_{th}	min	65
Moment of inertia	J_{Mot}	kgm ²	$10.4 \cdot 10^{-3}$
Shaft torsional stiffness	C_t	Nm/rad	148000
Weight without brake	m_{Mot}	kg	28.5
Motor data with integrated brake			
Moment of inertia with brake	$J_{Mot\ Br}$	kgm ²	$11.2 \cdot 10^{-3}$
Shaft torsional stiffness with brake	$C_t\ Br$	Nm/rad	108000
Weight with brake	$m_{Mot\ Br}$	kg	33.0
Recommended Motor Module 6SL312□-□TE23-0AA□			
Rated converter current	$I_{N\ Inv}$	A	30
Maximum converter current	$I_{max\ Inv}$	A	56
Max. torque at $I_{max\ Inv}$	$M_{max\ Inv}$	Nm	77
Maximum permissible speed (converter)	$n_{max\ Inv}$	rpm	5000

The rated data are valid for a 600 V DC link voltage.

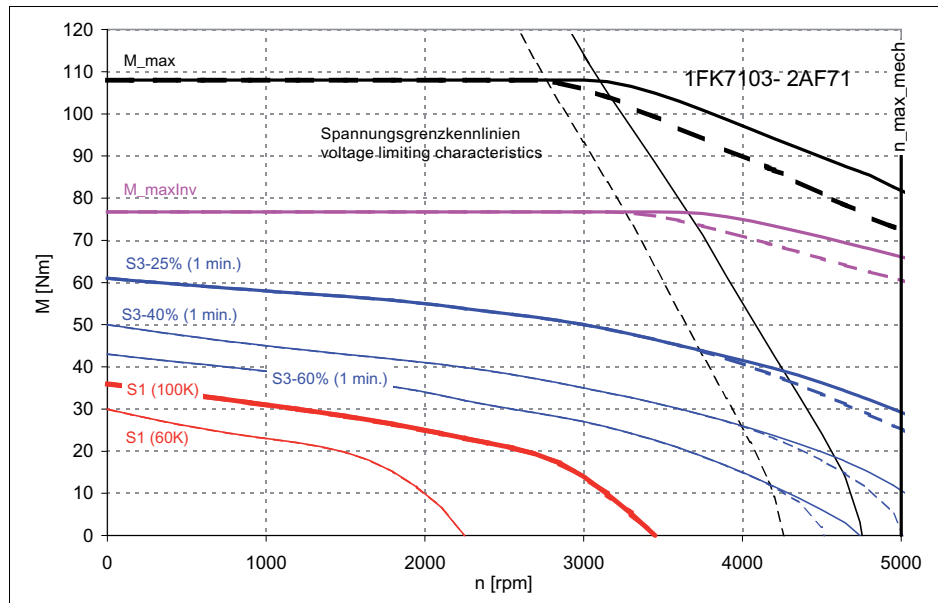

[—————] SINAMICS ALM 400 V-Netz (Zwischenkreisspannung 600 V DC) (DC-link voltage 600 V)

[- - - - -] SINAMICS BLM/SLM 400 V-Netz (Zwischenkreisspannung 540 V DC) (DC-link voltage 540 V)

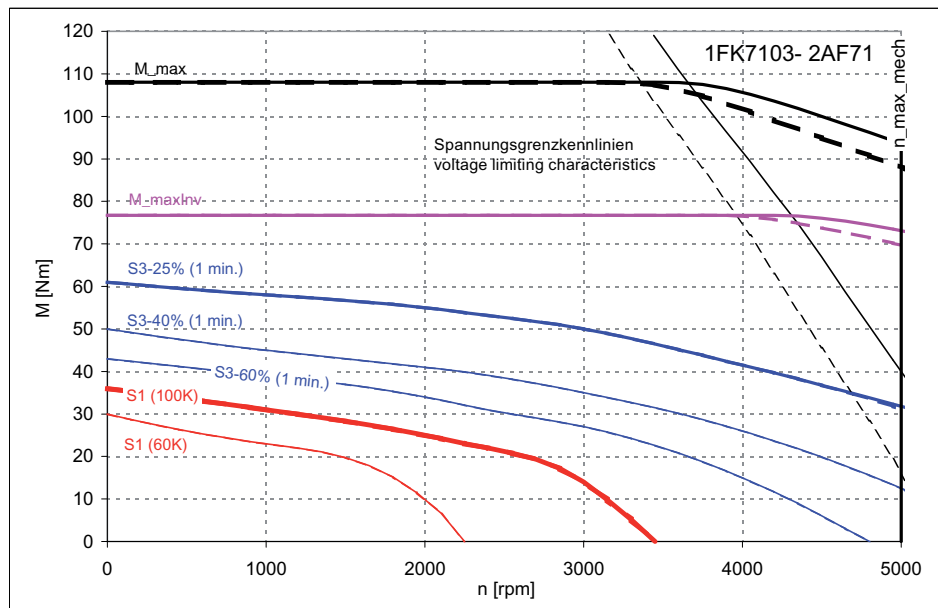

[—————] SINAMICS ALM 480 V-Netz (Zwischenkreisspannung 720 V DC) (DC-link voltage 720 V)

[- - - - -] SINAMICS BLM/SLM 480 V-Netz (Zwischenkreisspannung 650 V DC) (DC-link voltage 650 V)

Figure 4-39 1FK7103-2AF71

4.2 Torque-speed characteristic

Table 4- 39 1FK7105 Compact

Technical data	Code	Unit	-2AC71
Configuration data			
Rated speed	n_N	rpm	2000
Rated torque (100 K)	$M_N (100\text{ K})$	Nm	37.0
Rated current (100 K)	$I_N (100\text{ K})$	A	16.0
Static torque (100 K)	$M_0 (100\text{ K})$	Nm	48.0
Stall current (100 K)	$I_0 (100\text{ K})$	A	20.0
Static torque (60 K)	$M_0 (60\text{ K})$	Nm	40.0
Stall current (60 K)	$I_0 (60\text{ K})$	A	16.2
Optimum operating point			
Optimum speed	n_{opt}	rpm	2000
Optimum power	P_{opt}	kW	7.7
Limit data			
Max. permissible speed (mech.)	$n_{max\ mech}$	rpm	5000
Maximum torque	M_{max}	Nm	150
Maximum current	I_{max}	A	71
Motor data			
Pole number	2p		8
Torque constant (100 K)	k_T	Nm/A	2.37
Voltage constant (at 20 °C)	k_E	V/1000 rpm	157.5
Winding resistance (at 20 °C)	R_{ph}	Ω	0.175
Rotating field inductance	L_D	mH	4.5
Electrical time constant	T_{el}	ms	25.5
Mechanical time constant	T_{mech}	ms	1.4
Thermal time constant	T_{th}	min	70
Moment of inertia	J_{Mot}	kgm ²	15.4 · 10 ⁻³
Shaft torsional stiffness	C_t	Nm/rad	125000
Weight without brake	m_{Mot}	kg	39.0
Motor data with integrated brake			
Moment of inertia with brake	$J_{Mot\ Br}$	kgm ²	16.2 · 10 ⁻³
Shaft torsional stiffness with brake	$C_t\ Br$	Nm/rad	95000
Weight with brake	$m_{Mot\ Br}$	kg	43.5
Recommended Motor Module 6SL312□-□TE23-0AA□□			
Rated converter current	$I_{N\ Inv}$	A	30
Maximum converter current	$I_{max\ Inv}$	A	56
Max. torque at $I_{max\ Inv}$	$M_{max\ Inv}$	Nm	126
Maximum permissible speed (converter)	$n_{max\ Inv}$	rpm	3650

The rated data are valid for a 600 V DC link voltage.

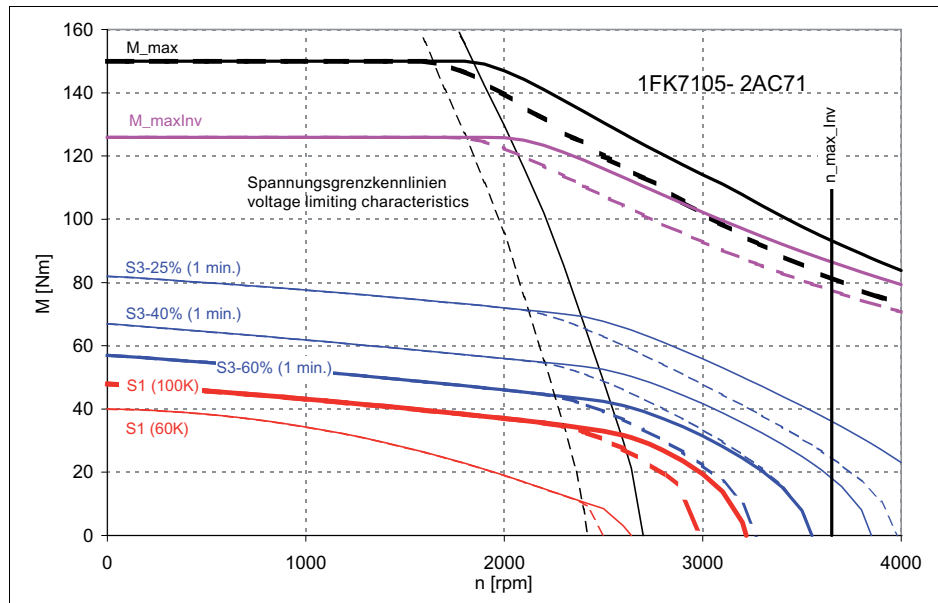

[—————] SINAMICS ALM 400 V-Netz (Zwischenkreisspannung 600 V DC) (DC-link voltage 600 V)
 [- - - - -] SINAMICS BLM/SLM 400 V-Netz (Zwischenkreisspannung 540 V DC) (DC-link voltage 540 V)

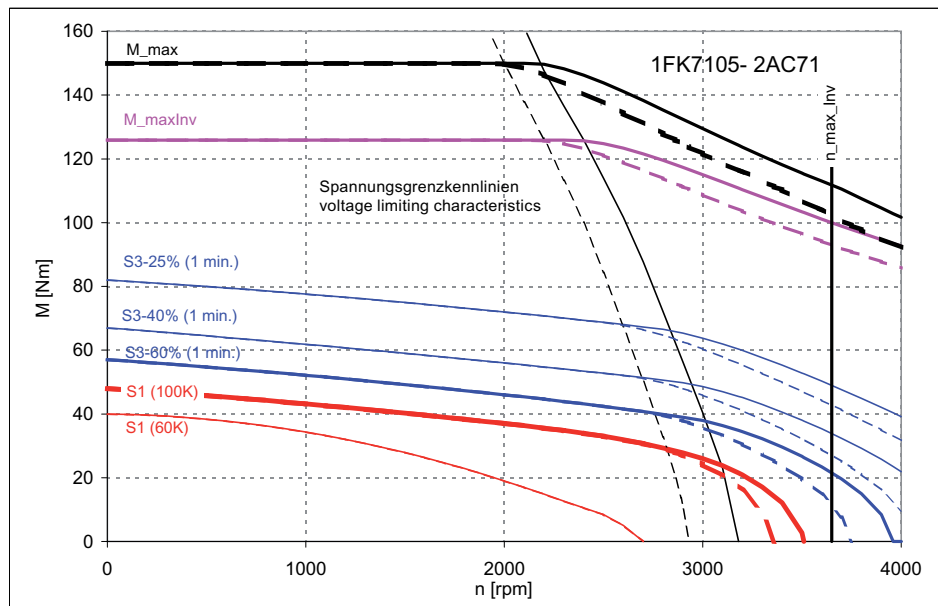

[—————] SINAMICS ALM 480 V-Netz (Zwischenkreisspannung 720 V DC) (DC-link voltage 720 V)
 [- - - - -] SINAMICS BLM/SLM 480 V-Netz (Zwischenkreisspannung 650 V DC) (DC-link voltage 650 V)

Figure 4-40 1FK7105-2AC71

4.2 Torque-speed characteristic

Table 4- 40 1FK7105 Compact

Technical data	Code	Unit	-2AF71
Configuration data			
Rated speed	n_N	rpm	3000
Rated torque (100 K)	$M_N (100\text{ K})$	Nm	26.0
Rated current (100 K)	$I_N (100\text{ K})$	A	18.0
Static torque (100 K)	$M_0 (100\text{ K})$	Nm	48.0
Stall current (100 K)	$I_0 (100\text{ K})$	A	31.0
Static torque (60 K)	$M_0 (60\text{ K})$	Nm	40.0
Stall current (60 K)	$I_0 (60\text{ K})$	A	25.0
Optimum operating point			
Optimum speed	n_{opt}	rpm	3000
Optimum power	P_{opt}	kW	8.2
Limit data			
Max. permissible speed (mech.)	$n_{max\ mech}$	rpm	5000
Maximum torque	M_{max}	Nm	150
Maximum current	I_{max}	A	109
Motor data			
Pole number	2p		8
Torque constant (100 K)	k_T	Nm/A	1.55
Voltage constant (at 20 °C)	k_E	V/1000 rpm	102.0
Winding resistance (at 20 °C)	R_{ph}	Ω	0.073
Rotating field inductance	L_D	mH	1.9
Electrical time constant	T_{el}	ms	26.0
Mechanical time constant	T_{mech}	ms	1.4
Thermal time constant	T_{th}	min	70
Moment of inertia	J_{Mot}	kgm ²	15.4 · 10 ⁻³
Shaft torsional stiffness	C_t	Nm/rad	125000
Weight without brake	m_{Mot}	kg	39.0
Motor data with integrated brake			
Moment of inertia with brake	$J_{Mot\ Br}$	kgm ²	16.2 · 10 ⁻³
Shaft torsional stiffness with brake	C_t	Nm/rad	95000
Weight with brake	$m_{Mot\ Br}$	kg	43.5
Recommended Motor Module 6SL312□-□TE13-0AA□			
Rated converter current	$I_{N\ Inv}$	A	30
Maximum converter current	$I_{max\ Inv}$	A	56
Max. torque at $I_{max\ Inv}$	$M_{max\ Inv}$	Nm	87
Maximum permissible speed (converter)	$n_{max\ Inv}$	rpm	5000

The rated data are valid for a 600 V DC link voltage.

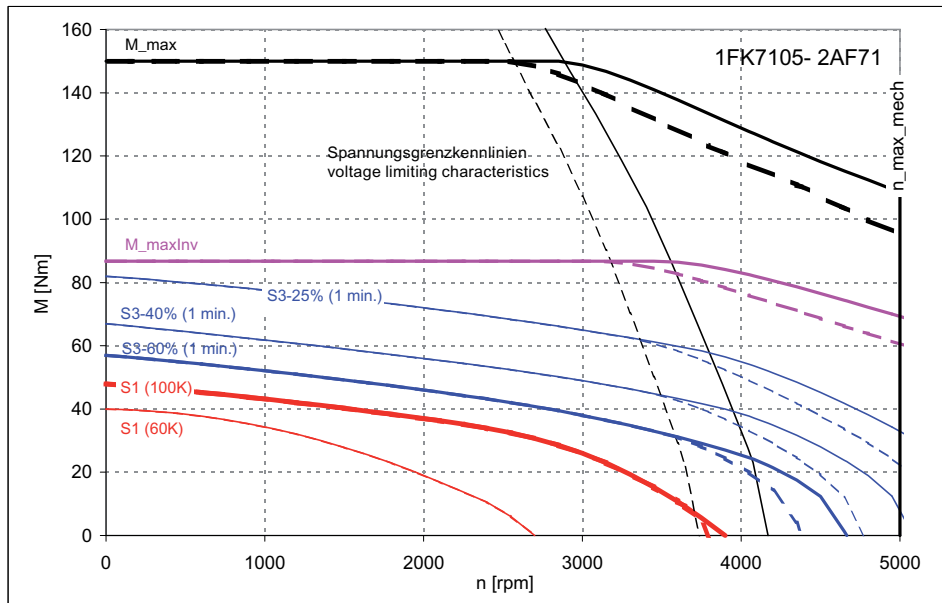

[—————] SINAMICS ALM 400 V-Netz (Zwischenkreisspannung 600 V DC) (DC-link voltage 600 V)
 [- - - - -] SINAMICS BLM/SLM 400 V-Netz (Zwischenkreisspannung 540 V DC) (DC-link voltage 540 V)

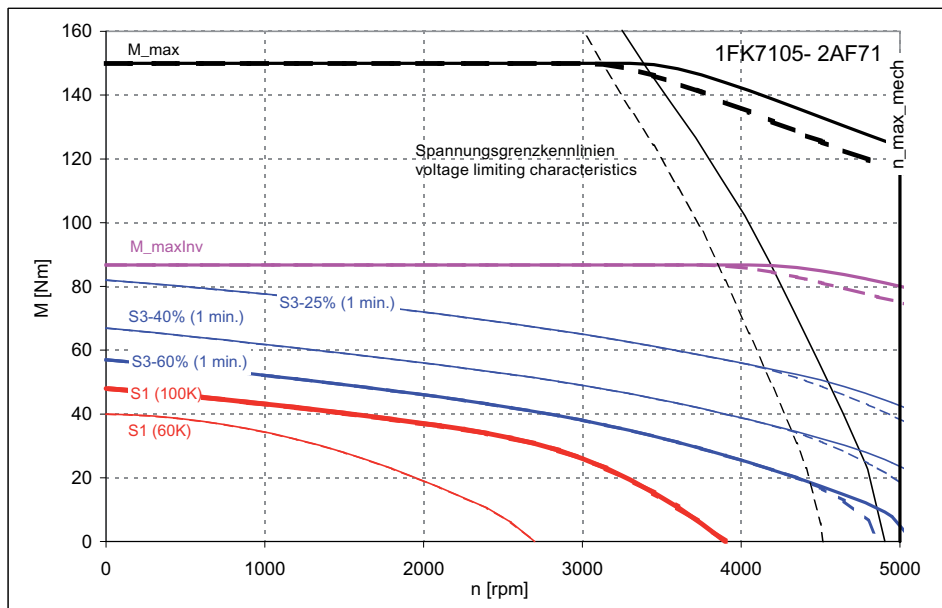

[—————] SINAMICS ALM 480 V-Netz (Zwischenkreisspannung 720 V DC) (DC-link voltage 720 V)
 [- - - - -] SINAMICS BLM/SLM 480 V-Netz (Zwischenkreisspannung 650 V DC) (DC-link voltage 650 V)

Figure 4-41 1FK7105-2AF71

4.2 Torque-speed characteristic

4.2.1.2 1FK7 High Dynamic

Table 4- 41 1FK7033 High Dynamic

Technical data	Code	Unit	-4CK71
Configuration data			
Rated speed	n_N	rpm	6000
Rated torque (100 K)	$M_N (100\text{ K})$	Nm	0.9
Rated current (100 K)	$I_N (100\text{ K})$	A	1.6
Static torque (100 K)	$M_0 (100\text{ K})$	Nm	1.3
Stall current (100 K)	$I_0 (100\text{ K})$	A	2.1
Static torque (60 K)	$M_0 (60\text{ K})$	Nm	1.08
Stall current (60 K)	$I_0 (60\text{ K})$	A	1.7
Optimum operating point			
Optimum speed	n_{opt}	rpm	6000
Optimum power	P_{opt}	kW	0.57
Limit data			
Max. permissible speed (mech.)	$n_{max\ mech}$	rpm	10000
Maximum torque	M_{max}	Nm	4.3
Maximum current	I_{max}	A	7.6
Motor data			
Pole number	2p		6
Torque constant (100 K)	k_T	Nm/A	0.62
Voltage constant (at 20 °C)	k_E	V/1000 rpm	39.5
Winding resistance (at 20 °C)	R_{ph}	Ω	3.51
Rotating field inductance	L_D	mH	22.0
Electrical time constant	T_{el}	ms	6.3
Mechanical time constant	T_{mech}	ms	0.68
Thermal time constant	T_{th}	min	25
Moment of inertia	J_{Mot}	kgm ²	0.025·10 ⁻³
Shaft torsional stiffness	C_t	Nm/rad	7300
Weight without brake	m_{Mot}	kg	3.0
Motor data with integrated brake			
Moment of inertia with brake	$J_{Mot\ Br}$	kgm ²	0.035·10 ⁻³
Shaft torsional stiffness with brake	$C_t\ Br$	Nm/rad	4700
Weight with brake	$m_{Mot\ Br}$	kg	3.4
Recommended Motor Module 6SL321□-□TE13-0AA□			
Rated converter current	$I_N\ Inv$	A	3
Maximum converter current	$I_{max\ Inv}$	A	6
Max. torque at $I_{max\ Inv}$	$M_{max\ Inv}$	Nm	3.5
Maximum permissible speed (converter)	$n_{max\ Inv}$	rpm	10000

The rated data are valid for a 600 V DC link voltage.

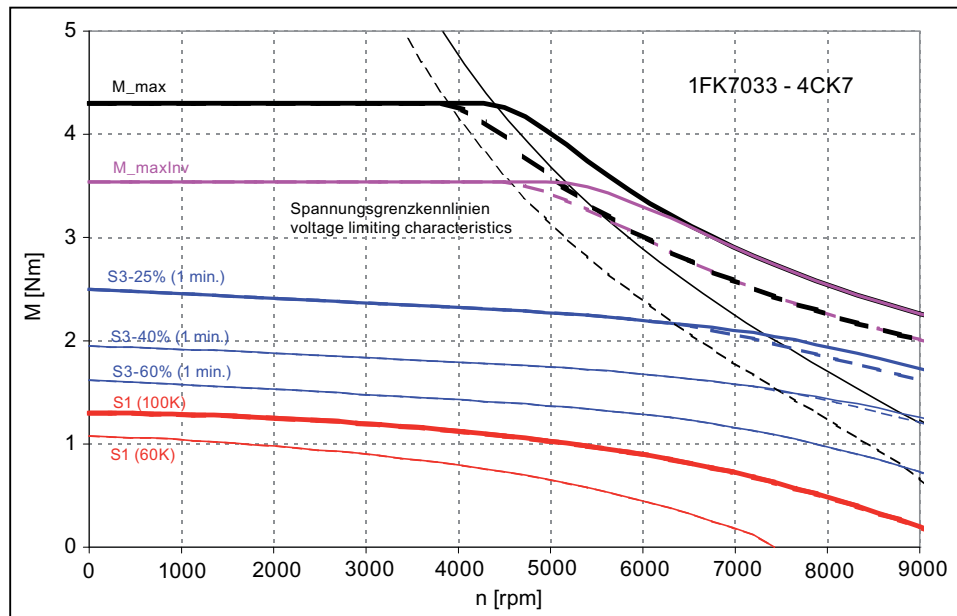

[——] SINAMICS ALM 400V-Netz (Zwischenkreisspannung 600V DC) (DC-link voltage 600 V)

[-----] SINAMICS BLM/SLM 400V-Netz (Zwischenkreisspannung 540V DC) (DC-link voltage 540 V)

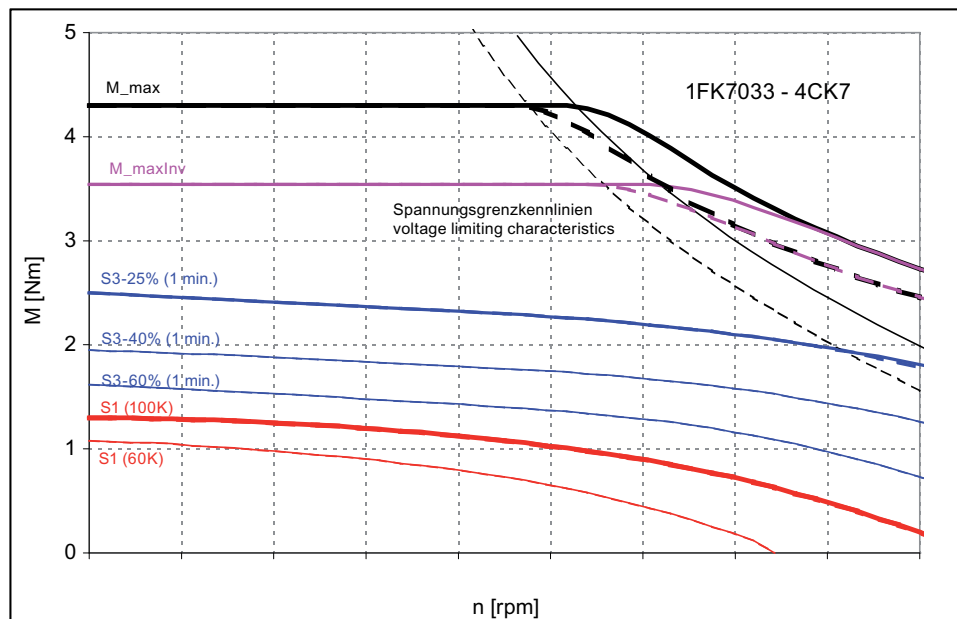

[——] SINAMICS ALM 480V-Netz (Zwischenkreisspannung 720V DC) (DC-link voltage 720 V)

[-----] SINAMICS BLM/SLM 480V-Netz (Zwischenkreisspannung 650V DC) (DC-link voltage 650 V)

Figure 4-42 1FK7033-4CK71

4.2 Torque-speed characteristic

Table 4- 42 1FK7043 High Dynamic

Technical data	Code	Unit	-4CH71
Configuration data			
Rated speed	n_N	rpm	4500
Rated torque (100 K)	$M_N (100\text{ K})$	Nm	2.6
Rated current (100 K)	$I_N (100\text{ K})$	A	3.3
Static torque (100 K)	$M_0 (100\text{ K})$	Nm	3.5
Stall current (100 K)	$I_0 (100\text{ K})$	A	4.1
Static torque (60 K)	$M_0 (60\text{ K})$	Nm	2.9
Stall current (60 K)	$I_0 (60\text{ K})$	A	3.3
Optimum operating point			
Optimum speed	n_{opt}	rpm	4500
Optimum power	P_{opt}	kW	1.23
Limit data			
Max. permissible speed (mech.)	$n_{max\ mech}$	rpm	9000
Maximum torque	M_{max}	Nm	10.0
Maximum current	I_{max}	A	12.5
Motor data			
Pole number	2p		6
Torque constant (100 K)	k_T	Nm/A	0.855
Voltage constant (at 20 °C)	k_E	V/1000 rpm	54.0
Winding resistance (at 20 °C)	R_{ph}	Ω	1.2
Rotating field inductance	L_D	mH	13.6
Electrical time constant	T_{el}	ms	11.3
Mechanical time constant	T_{mech}	ms	0.49
Thermal time constant	T_{th}	min	40
Moment of inertia	J_{Mot}	kgm ²	$0.1 \cdot 10^{-3}$
Shaft torsional stiffness	C_t	Nm/rad	11400
Weight without brake	m_{Mot}	kg	6.0
Motor data with integrated brake			
Moment of inertia with brake	$J_{Mot\ Br}$	kgm ²	$0.136 \cdot 10^{-3}$
Shaft torsional stiffness with brake	$C_t\ Br$	Nm/rad	9000
Weight with brake	$m_{Mot\ Br}$	kg	6.6
Recommended Motor Module 6SL321□-□TE15-0AA□			
Rated converter current	$I_{N\ Inv}$	A	5
Maximum converter current	$I_{max\ Inv}$	A	10
Max. torque at $I_{max\ Inv}$	$M_{max\ Inv}$	Nm	8.3
Maximum permissible speed (converter)	$n_{max\ Inv}$	rpm	9000

The rated data are valid for a 600 V DC link voltage.

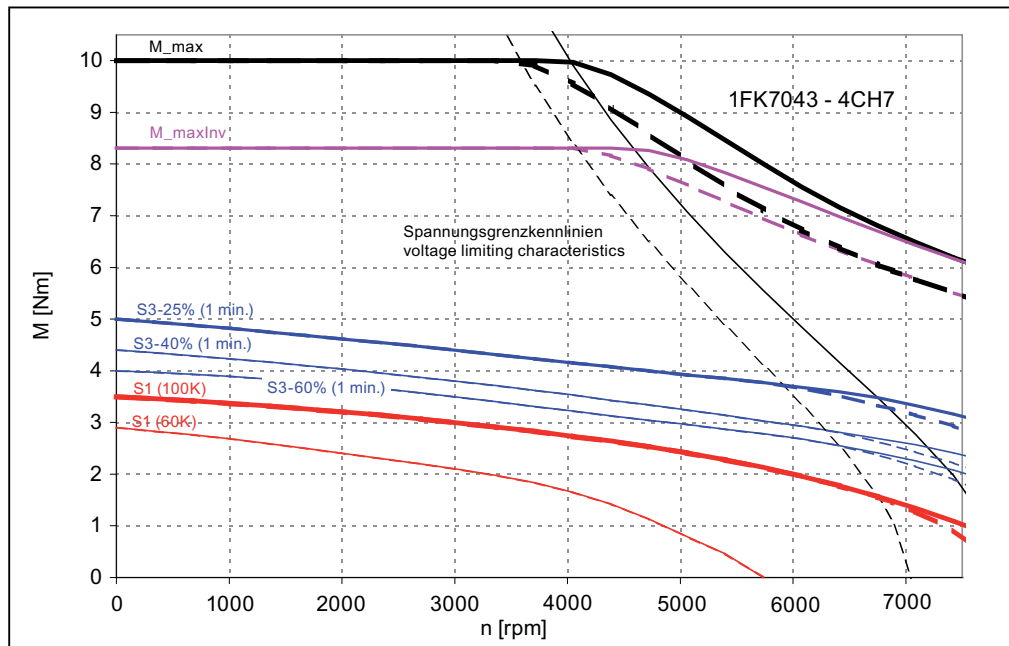

[——] SINAMICS ALM 400V-Netz (Zwischenkreisspannung 600V DC) (DC-link voltage 600 V)

[-----] SINAMICS BLM/SLM 400V-Netz (Zwischenkreisspannung 540V DC) (DC-link voltage 540 V)

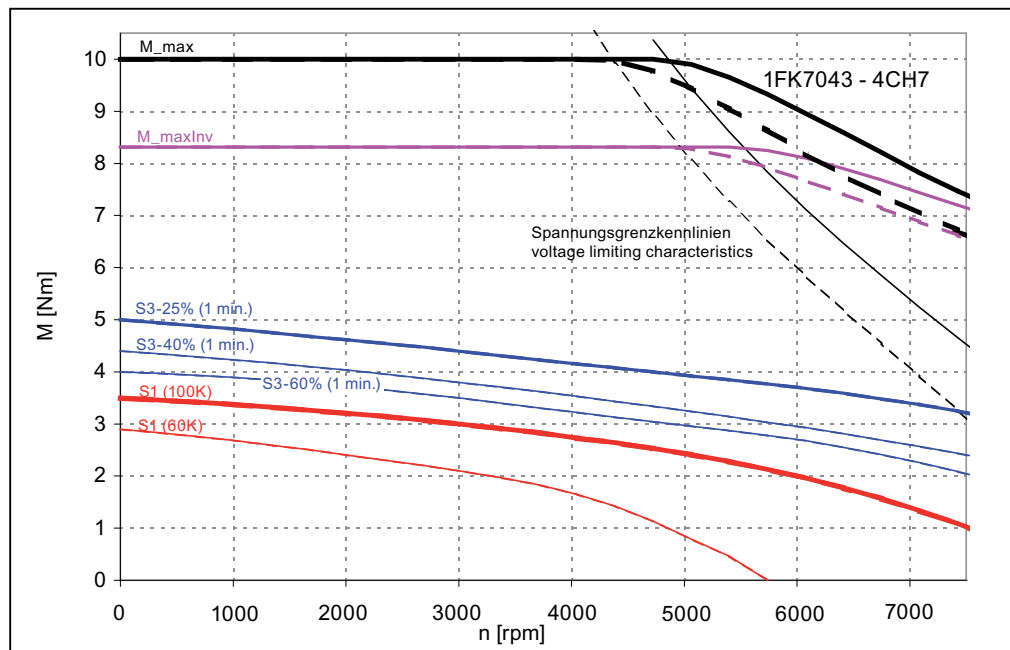

[——] SINAMICS ALM 480V-Netz (Zwischenkreisspannung 720V DC) (DC-link voltage 720 V)

[-----] SINAMICS BLM/SLM 480V-Netz (Zwischenkreisspannung 650V DC) (DC-link voltage 650 V)

Figure 4-43 1FK7043-4CH71

4.2 Torque-speed characteristic

Table 4- 43 1FK7043 High Dynamic

Technical data	Code	Unit	-4CK71
Configuration data			
Rated speed	n_N	rpm	6000
Rated torque (100 K)	$M_N (100\text{ K})$	Nm	2.0
Rated current (100 K)	$I_N (100\text{ K})$	A	3.5
Static torque (100 K)	$M_0 (100\text{ K})$	Nm	3.5
Stall current (100 K)	$I_0 (100\text{ K})$	A	5.6
Static torque (60 K)	$M_0 (60\text{ K})$	Nm	2.9
Stall current (60 K)	$I_0 (60\text{ K})$	A	4.5
Optimum operating point			
Optimum speed	n_{opt}	rpm	6000
Optimum power	P_{opt}	kW	1.26
Limit data			
Max. permissible speed (mech.)	$n_{max\ mech}$	rpm	9000
Maximum torque	M_{max}	Nm	10.0
Maximum current	I_{max}	A	17.0
Motor data			
Pole number	2p		6
Torque constant (100 K)	k_T	Nm/A	0.63
Voltage constant (at 20 °C)	k_E	V/1000 rpm	39.8
Winding resistance (at 20 °C)	R_{ph}	Ω	0.645
Rotating field inductance	L_D	mH	7.4
Electrical time constant	T_{el}	ms	11.5
Mechanical time constant	T_{mech}	ms	0.49
Thermal time constant	T_{th}	min	40
Moment of inertia	J_{Mot}	kgm ²	$0.1 \cdot 10^{-3}$
Shaft torsional stiffness	C_t	Nm/rad	11400
Weight without brake	m_{Mot}	kg	6.0
Motor data with integrated brake			
Moment of inertia with brake	$J_{Mot\ Br}$	kgm ²	$0.136 \cdot 10^{-3}$
Shaft torsional stiffness with brake	$C_t\ Br$	Nm/rad	9000
Weight with brake	$m_{Mot\ Br}$	kg	6.6
Recommended Motor Module 6SL321□-□TE15-0AA□			
Rated converter current	$I_{N\ Inv}$	A	9
Maximum converter current	$I_{max\ Inv}$	A	18
Max. torque at $I_{max\ Inv}$	$M_{max\ Inv}$	Nm	10.0
Maximum permissible speed (converter)	$n_{max\ Inv}$	rpm	9000

The rated data are valid for a 600 V DC link voltage.

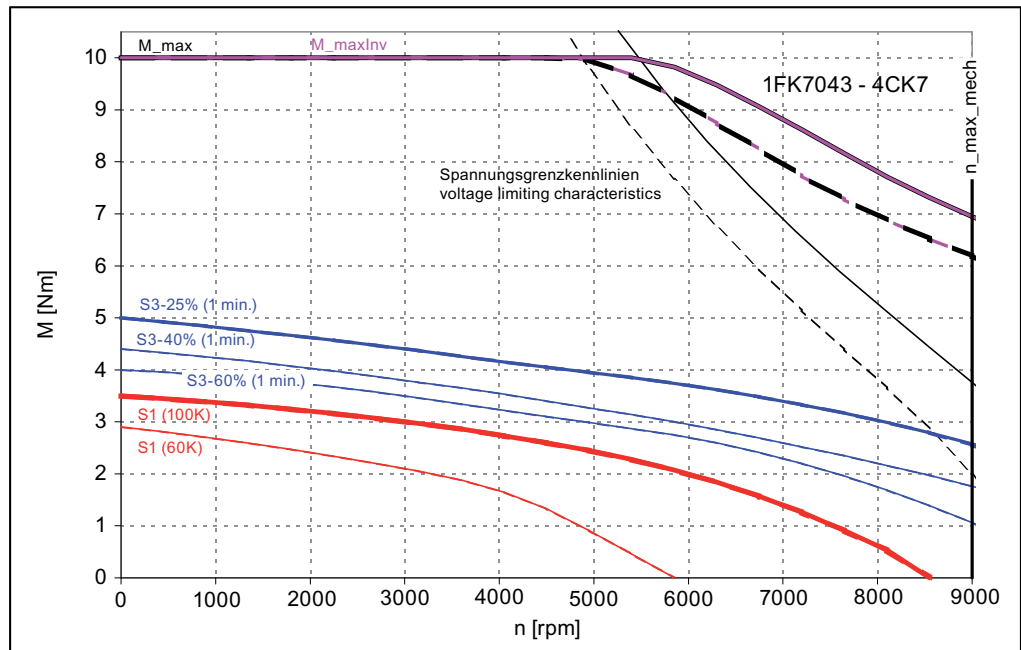

[—] SINAMICS ALM 400V-Netz (Zwischenkreisspannung 600V DC) (DC-link voltage 600 V)

[-----] SINAMICS BLM/SLM 400V-Netz (Zwischenkreisspannung 540V DC) (DC-link voltage 540 V)

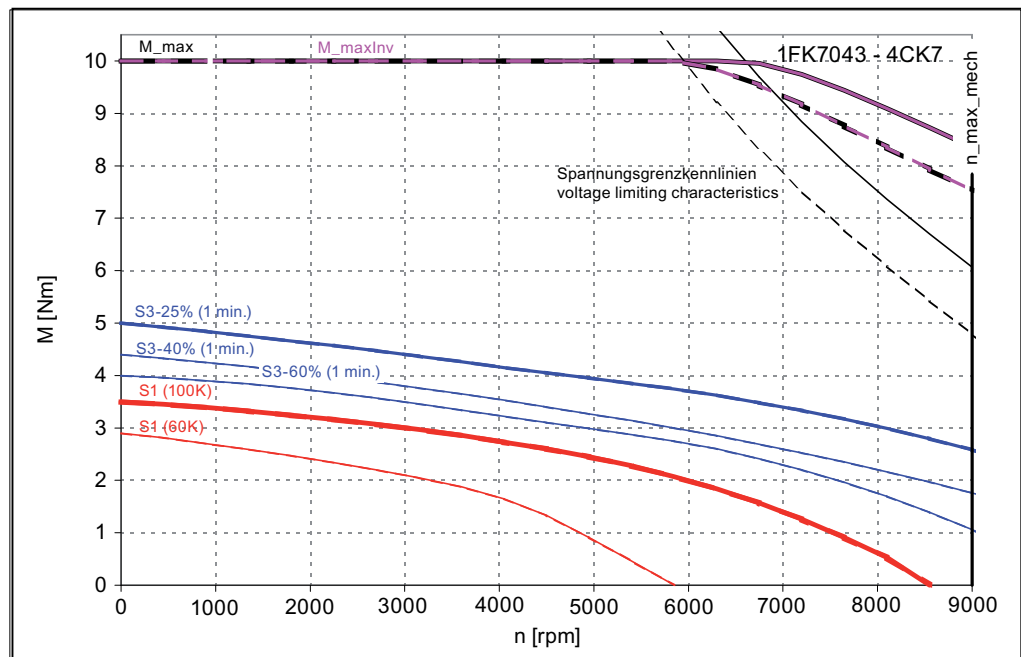

[—] SINAMICS ALM 480V-Netz (Zwischenkreisspannung 720V DC) (DC-link voltage 720 V)

[-----] SINAMICS BLM/SLM 480V-Netz (Zwischenkreisspannung 650V DC) (DC-link voltage 650 V)

Figure 4-44 1FK7043-4CK71

4.2 Torque-speed characteristic

Table 4- 44 1FK7044 High Dynamic

Technical data	Code	Unit	-4CF71
Configuration data			
Rated speed	n_N	rpm	3000
Rated torque (100 K)	$M_N (100\text{ K})$	Nm	3.7
Rated current (100 K)	$I_N (100\text{ K})$	A	3.45
Static torque (100 K)	$M_0 (100\text{ K})$	Nm	4.5
Stall current (100 K)	$I_0 (100\text{ K})$	A	4.0
Static torque (60 K)	$M_0 (60\text{ K})$	Nm	3.75
Stall current (60 K)	$I_0 (60\text{ K})$	A	3.2
Optimum operating point			
Optimum speed	n_{opt}	rpm	3000
Optimum power	P_{opt}	kW	1.16
Limit data			
Max. permissible speed (mech.)	$n_{max\ mech}$	rpm	9000
Maximum torque	M_{max}	Nm	13.0
Maximum current	I_{max}	A	12.1
Motor data			
Pole number	2p		6
Torque constant (100 K)	k_T	Nm/A	1.13
Voltage constant (at 20 °C)	k_E	V/1000 rpm	72.0
Winding resistance (at 20 °C)	R_{ph}	Ω	1.49
Rotating field inductance	L_D	mH	18.8
Electrical time constant	T_{el}	ms	12.6
Mechanical time constant	T_{mech}	ms	0.44
Thermal time constant	T_{th}	min	45
Moment of inertia	J_{Mot}	kgm ²	$0.126 \cdot 10^{-3}$
Shaft torsional stiffness	C_t	Nm/rad	9800
Weight without brake	m_{Mot}	kg	7.4
Motor data with integrated brake			
Moment of inertia with brake	$J_{Mot\ Br}$	kgm ²	$0.162 \cdot 10^{-3}$
Shaft torsional stiffness with brake	$C_t\ Br$	Nm/rad	7900
Weight with brake	$m_{Mot\ Br}$	kg	8.0
Recommended Motor Module 6SL312□-□TE15-0AA□			
Rated converter current	$I_{N\ Inv}$	A	5
Maximum converter current	$I_{max\ Inv}$	A	10
Max. torque at $I_{max\ Inv}$	$M_{max\ Inv}$	Nm	11.0
Maximum permissible speed (converter)	$n_{max\ Inv}$	rpm	8050

The rated data are valid for a 600 V DC link voltage.

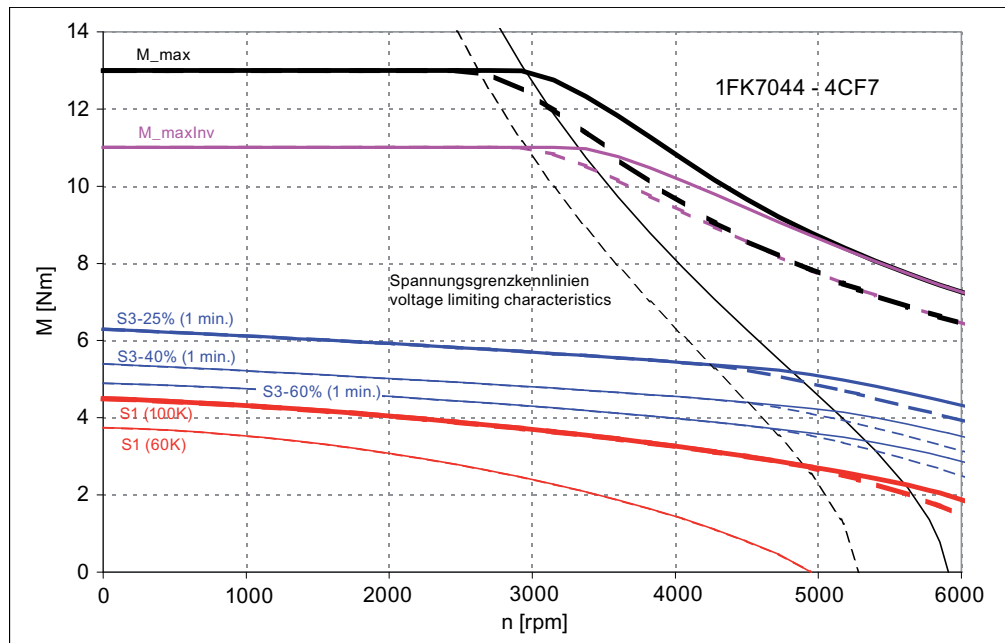

[——] SINAMICS ALM 400V-Netz (Zwischenkreisspannung 600V DC) (DC-link voltage 600 V)

[-----] SINAMICS BLM/SLM 400V-Netz (Zwischenkreisspannung 540V DC) (DC-link voltage 540 V)

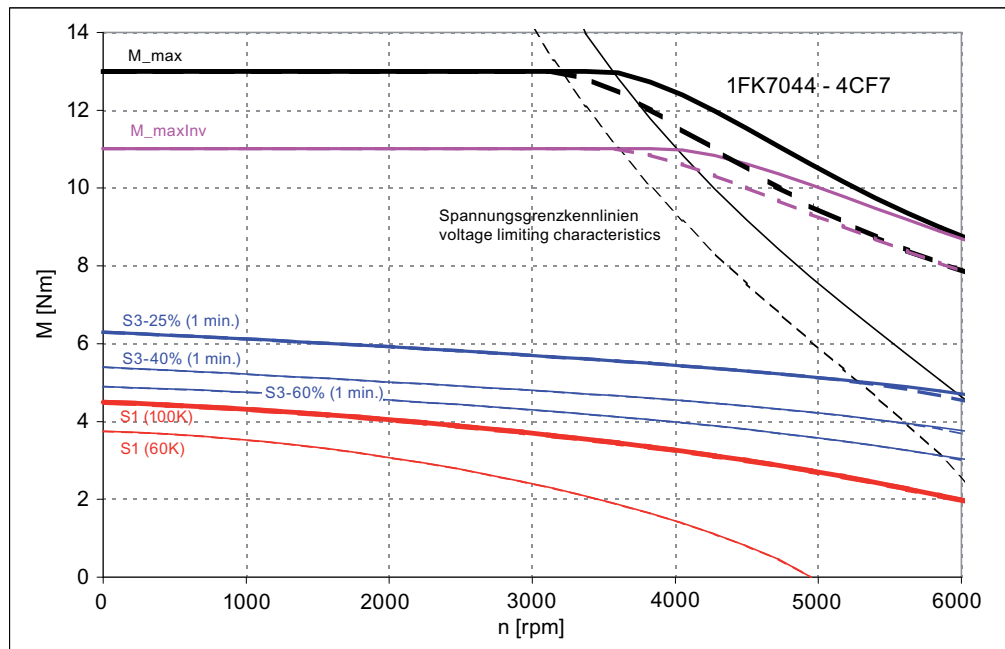

[——] SINAMICS ALM 480V-Netz (Zwischenkreisspannung 720V DC) (DC-link voltage 720 V)

[-----] SINAMICS BLM/SLM 480V-Netz (Zwischenkreisspannung 650V DC) (DC-link voltage 650 V)

Figure 4-45 1FK7044-4CF71

4.2 Torque-speed characteristic

Table 4- 45 1FK7044 High Dynamic

Technical data	Code	Unit	-4CH71
Configuration data			
Rated speed	n_N	rpm	4500
Rated torque (100 K)	$M_N (100\text{ K})$	Nm	3.0
Rated current (100 K)	$I_N (100\text{ K})$	A	3.9
Static torque (100 K)	$M_0 (100\text{ K})$	Nm	4.5
Stall current (100 K)	$I_0 (100\text{ K})$	A	5.4
Static torque (60 K)	$M_0 (60\text{ K})$	Nm	3.75
Stall current (60 K)	$I_0 (60\text{ K})$	A	4.35
Optimum operating point			
Optimum speed	n_{opt}	rpm	4500
Optimum power	P_{opt}	kW	1.41
Limit data			
Max. permissible speed (mech.)	$n_{max\ mech}$	rpm	9000
Maximum torque	M_{max}	Nm	13.0
Maximum current	I_{max}	A	16.4
Motor data			
Pole number	2p		6
Torque constant (100 K)	k_T	Nm/A	0.835
Voltage constant (at 20 °C)	k_E	V/1000 rpm	53.0
Winding resistance (at 20 °C)	R_{ph}	Ω	0.815
Rotating field inductance	L_D	mH	10.2
Electrical time constant	T_{el}	ms	12.5
Mechanical time constant	T_{mech}	ms	0.44
Thermal time constant	T_{th}	min	45
Moment of inertia	J_{Mot}	kgm ²	$0.126 \cdot 10^{-3}$
Shaft torsional stiffness	C_t	Nm/rad	9800
Weight without brake	m_{Mot}	kg	7.4
Motor data with integrated brake			
Moment of inertia with brake	$J_{Mot\ Br}$	kgm ²	$0.162 \cdot 10^{-3}$
Shaft torsional stiffness with brake	$C_t\ Br$	Nm/rad	7900
Weight with brake	$m_{Mot\ Br}$	kg	8.0
Recommended Motor Module 6SL321□-□TE15-0AA□			
Rated converter current	$I_{N\ Inv}$	A	9
Maximum converter current	$I_{max\ Inv}$	A	18
Max. torque at $I_{max\ Inv}$	$M_{max\ Inv}$	Nm	13.0
Maximum permissible speed (converter)	$n_{max\ Inv}$	rpm	9000

The rated data are valid for a 600 V DC link voltage.

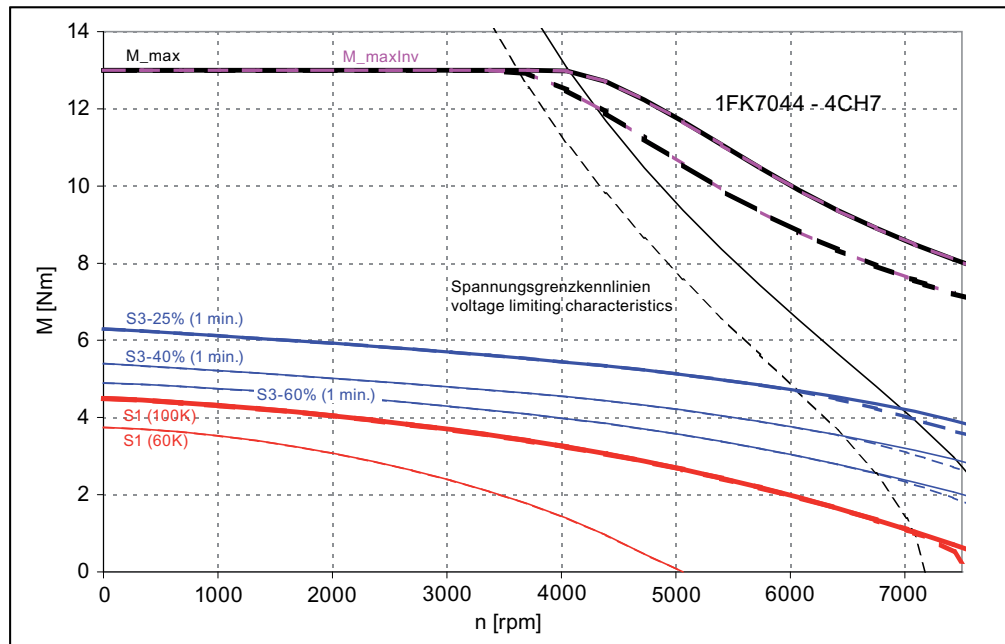

[———] SINAMICS ALM 400V-Netz (Zwischenkreisspannung 600V DC) (DC-link voltage 600 V)
 [- - - -] SINAMICS BLM/SLM 400V-Netz (Zwischenkreisspannung 540V DC) (DC-link voltage 540 V)

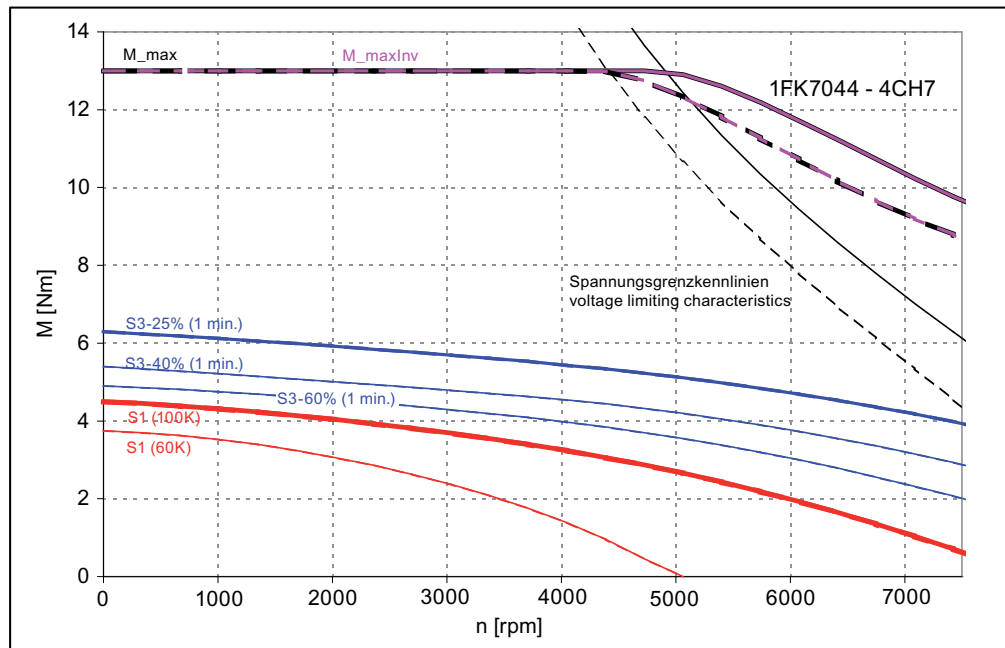

[———] SINAMICS ALM 480V-Netz (Zwischenkreisspannung 720V DC) (DC-link voltage 720 V)
 [- - - -] SINAMICS BLM/SLM 480V-Netz (Zwischenkreisspannung 650V DC) (DC-link voltage 650 V)

Figure 4-46 1FK7044-4CH71

4.2 Torque-speed characteristic

Table 4- 46 1FK7061 High Dynamic

Technical data	Code	Unit	-4CF71
Configuration data			
Rated speed	n_N	rpm	3000
Rated torque (100 K)	$M_N (100\text{ K})$	Nm	5.4
Rated current (100 K)	$I_N (100\text{ K})$	A	5.3
Static torque (100 K)	$M_0 (100\text{ K})$	Nm	6.4
Stall current (100 K)	$I_0 (100\text{ K})$	A	6.1
Static torque (60 K)	$M_0 (60\text{ K})$	Nm	5.3
Stall current (60 K)	$I_0 (60\text{ K})$	A	4.95
Optimum operating point			
Optimum speed	n_{opt}	rpm	3000
Optimum power	P_{opt}	kW	1.7
Limit data			
Max. permissible speed (mech.)	$n_{max\ mech}$	rpm	7500
Maximum torque	M_{max}	Nm	17.3
Maximum current	I_{max}	A	18.5
Motor data			
Pole number	2p		6
Torque constant (100 K)	k_T	Nm/A	1.05
Voltage constant (at 20 °C)	k_E	V/1000 rpm	67.5
Winding resistance (at 20 °C)	R_{ph}	Ω	0.715
Rotating field inductance	L_D	mH	22.0
Electrical time constant	T_{el}	ms	31.0
Mechanical time constant	T_{mech}	ms	0.79
Thermal time constant	T_{th}	min	45
Moment of inertia	J_{Mot}	kgm ²	$0.41 \cdot 10^{-3}$
Shaft torsional stiffness	C_t	Nm/rad	36500
Weight without brake	m_{Mot}	kg	9.5
Motor data with integrated brake			
Moment of inertia with brake	$J_{Mot\ Br}$	kgm ²	$0.51 \cdot 10^{-3}$
Shaft torsional stiffness with brake	$C_t\ Br$	Nm/rad	26500
Weight with brake	$m_{Mot\ Br}$	kg	11.0
Recommended Motor Module 6SL312□-□TE21-0AA□			
Rated converter current	$I_{N\ Inv}$	A	9
Maximum converter current	$I_{max\ Inv}$	A	18
Max. torque at $I_{max\ Inv}$	$M_{max\ Inv}$	Nm	17.0
Maximum permissible speed (converter)	$n_{max\ Inv}$	rpm	7500

The rated data are valid for a 600 V DC link voltage.

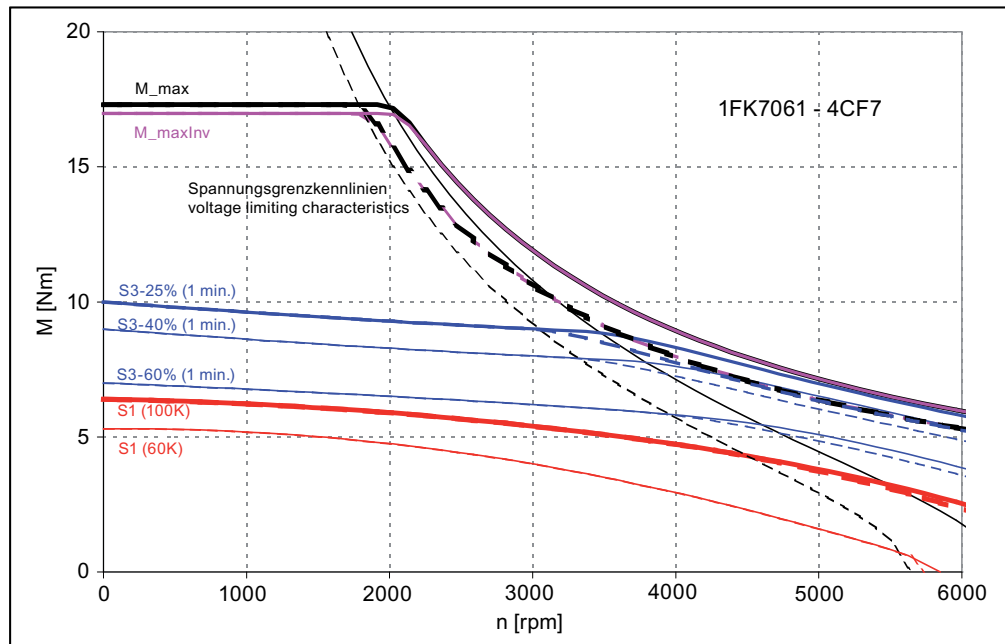

[———] SINAMICS ALM 400V-Netz (Zwischenkreisspannung 600V DC) (DC-link voltage 600 V)

[- - - - -] SINAMICS BLM/SLM 400V-Netz (Zwischenkreisspannung 540V DC) (DC-link voltage 540 V)

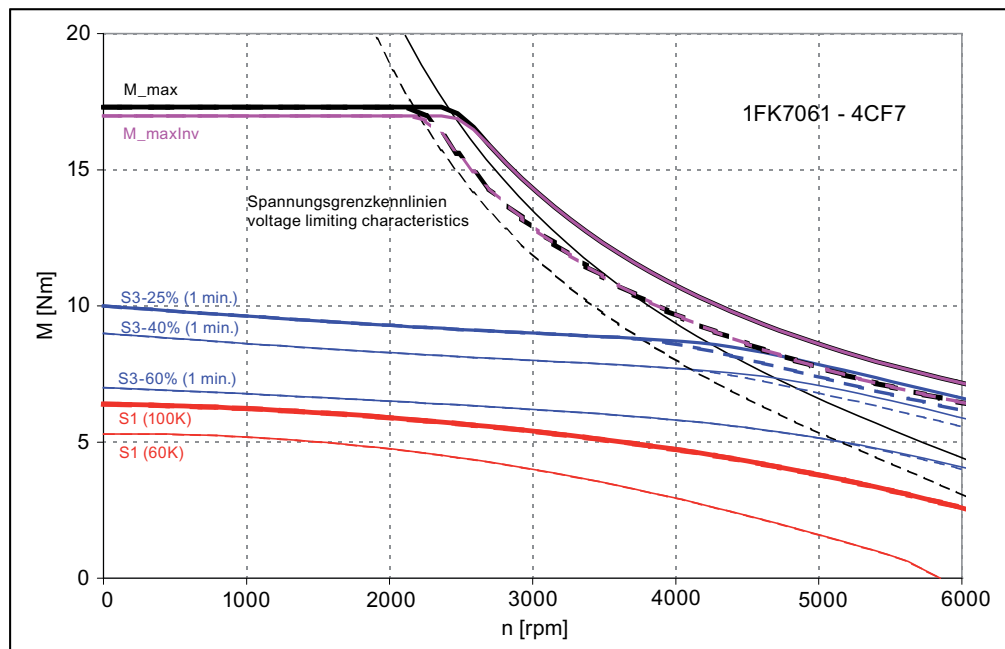

[———] SINAMICS ALM 480V-Netz (Zwischenkreisspannung 720V DC) (DC-link voltage 720 V)

[- - - - -] SINAMICS BLM/SLM 480V-Netz (Zwischenkreisspannung 650V DC) (DC-link voltage 650 V)

Figure 4-47 1FK7061-4CF71

4.2 Torque-speed characteristic

Table 4- 47 1FK7061 High Dynamic

Technical data	Code	Unit	-4CH71
Configuration data			
Rated speed	n_N	rpm	4500
Rated torque (100 K)	$M_N (100\text{ K})$	Nm	4.3
Rated current (100 K)	$I_N (100\text{ K})$	A	6.2
Static torque (100 K)	$M_0 (100\text{ K})$	Nm	6.4
Stall current (100 K)	$I_0 (100\text{ K})$	A	8.7
Static torque (60 K)	$M_0 (60\text{ K})$	Nm	5.3
Stall current (60 K)	$I_0 (60\text{ K})$	A	7.1
Optimum operating point			
Optimum speed	n_{opt}	rpm	4500
Optimum power	P_{opt}	kW	2.05
Limit data			
Max. permissible speed (mech.)	$n_{max\ mech}$	rpm	7500
Maximum torque	M_{max}	Nm	17.3
Maximum current	I_{max}	A	26.5
Motor data			
Pole number	2p		6
Torque constant (100 K)	k_T	Nm/A	0.73
Voltage constant (at 20 °C)	k_E	V/1000 rpm	47.0
Winding resistance (at 20 °C)	R_{ph}	Ω	0.348
Rotating field inductance	L_D	mH	10.7
Electrical time constant	T_{el}	ms	30.5
Mechanical time constant	T_{mech}	ms	0.79
Thermal time constant	T_{th}	min	45
Moment of inertia	J_{Mot}	kgm ²	$0.41 \cdot 10^{-3}$
Shaft torsional stiffness	C_t	Nm/rad	36500
Weight without brake	m_{Mot}	kg	9.5
Motor data with integrated brake			
Moment of inertia with brake	$J_{Mot\ Br}$	kgm ²	$0.51 \cdot 10^{-3}$
Shaft torsional stiffness with brake	$C_t\ Br$	Nm/rad	26500
Weight with brake	$m_{Mot\ Br}$	kg	11.0
Recommended Motor Module 6SL312□-□TE21-0AA□			
Rated converter current	$I_{N\ Inv}$	A	9
Maximum converter current	$I_{max\ Inv}$	A	18
Max. torque at $I_{max\ Inv}$	$M_{max\ Inv}$	Nm	13.1
Maximum permissible speed (converter)	$n_{max\ Inv}$	rpm	7500

The rated data are valid for a 600 V DC link voltage.

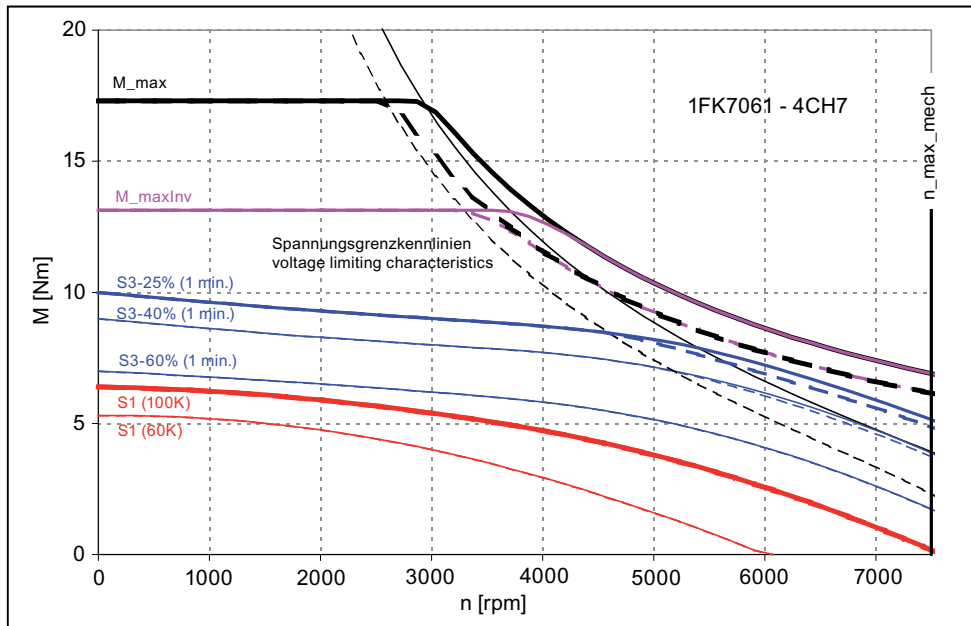

[———] SINAMICS ALM 400V-Netz (Zwischenkreisspannung 600V DC) (DC-link voltage 600 V)
 [- - - -] SINAMICS BLM/SLM 400V-Netz (Zwischenkreisspannung 540V DC) (DC-link voltage 540 V)

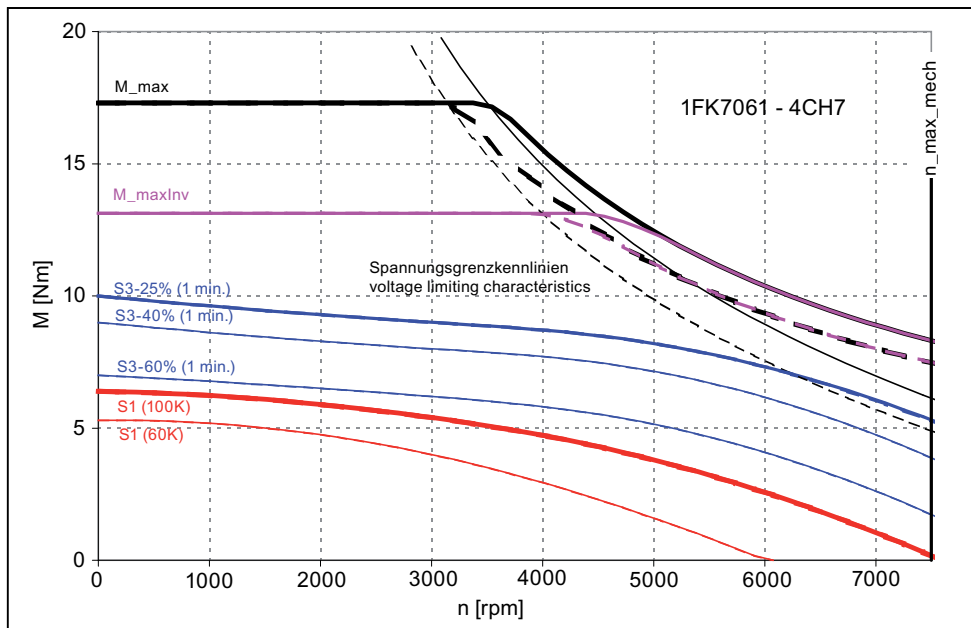

[———] SINAMICS ALM 480V-Netz (Zwischenkreisspannung 720V DC) (DC-link voltage 720 V)
 [- - - -] SINAMICS BLM/SLM 480V-Netz (Zwischenkreisspannung 650V DC) (DC-link voltage 650 V)

Figure 4-48 1FK7061-4CH71

4.2 Torque-speed characteristic

Table 4- 48 1FK7064 High Dynamic

Technical data	Code	Unit	-4CC71
Configuration data			
Rated speed	n_N	rpm	2000
Rated torque (100 K)	$M_N (100\text{ K})$	Nm	10.0
Rated current (100 K)	$I_N (100\text{ K})$	A	7.1
Static torque (100 K)	$M_0 (100\text{ K})$	Nm	12.0
Stall current (100 K)	$I_0 (100\text{ K})$	A	8.1
Static torque (60 K)	$M_0 (60\text{ K})$	Nm	10.0
Stall current (60 K)	$I_0 (60\text{ K})$	A	6.6
Optimum operating point			
Optimum speed	n_{opt}	rpm	2000
Optimum power	P_{opt}	kW	2.1
Limit data			
Max. permissible speed (mech.)	$n_{max\ mech}$	rpm	7500
Maximum torque	M_{max}	Nm	32.0
Maximum current	I_{max}	A	25.0
Motor data			
Pole number	2p		6
Torque constant (100 K)	k_T	Nm/A	1.48
Voltage constant (at 20 °C)	k_E	V/1000 rpm	94.0
Winding resistance (at 20 °C)	R_{ph}	Ω	0.585
Rotating field inductance	L_D	mH	21.5
Electrical time constant	T_{el}	ms	37.0
Mechanical time constant	T_{mech}	ms	0.6
Thermal time constant	T_{th}	min	55
Moment of inertia	J_{Mot}	kgm ²	$0.75 \cdot 10^{-3}$
Shaft torsional stiffness	C_t	Nm/rad	29500
Weight without brake	m_{Mot}	kg	15.4
Motor data with integrated brake			
Moment of inertia with brake	$J_{Mot\ Br}$	kgm ²	$0.85 \cdot 10^{-3}$
Shaft torsional stiffness with brake	$C_t\ Br$	Nm/rad	22500
Weight with brake	$m_{Mot\ Br}$	kg	16.8
Recommended Motor Module 6SL312□-□TE21-0AA□			
Rated converter current	$I_{N\ Inv}$	A	9
Maximum converter current	$I_{max\ Inv}$	A	18
Max. torque at $I_{max\ Inv}$	$M_{max\ Inv}$	Nm	26.0
Maximum permissible speed (converter)	$n_{max\ Inv}$	rpm	6150

The rated data are valid for a 600 V DC link voltage.

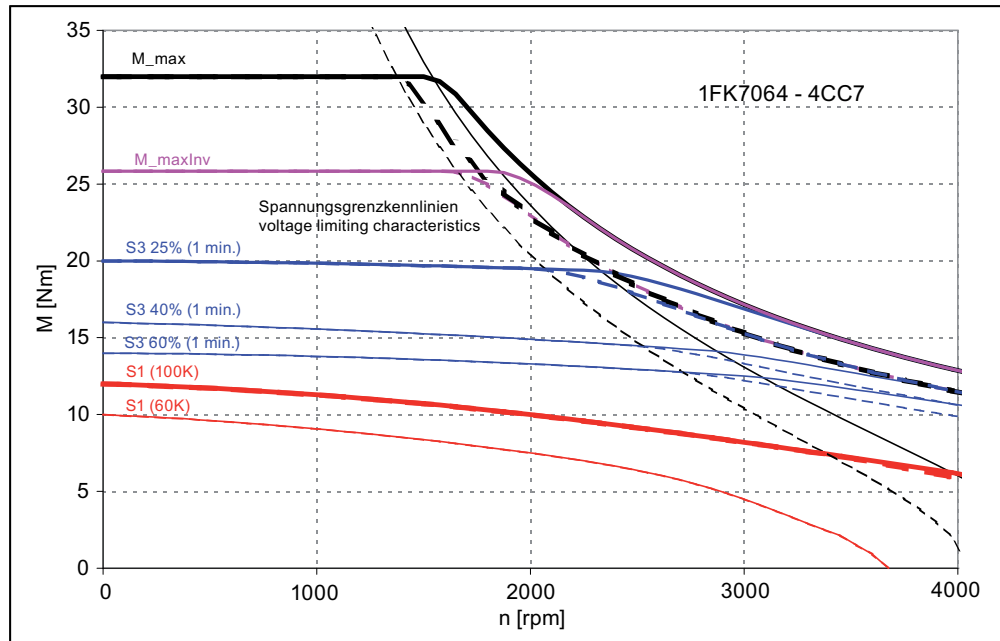

[———] SINAMICS ALM 400V-Netz (Zwischenkreisspannung 600V DC) (DC-link voltage 600 V)
 [- - - -] SINAMICS BLM/SLM 400V-Netz (Zwischenkreisspannung 540V DC) (DC-link voltage 540 V)

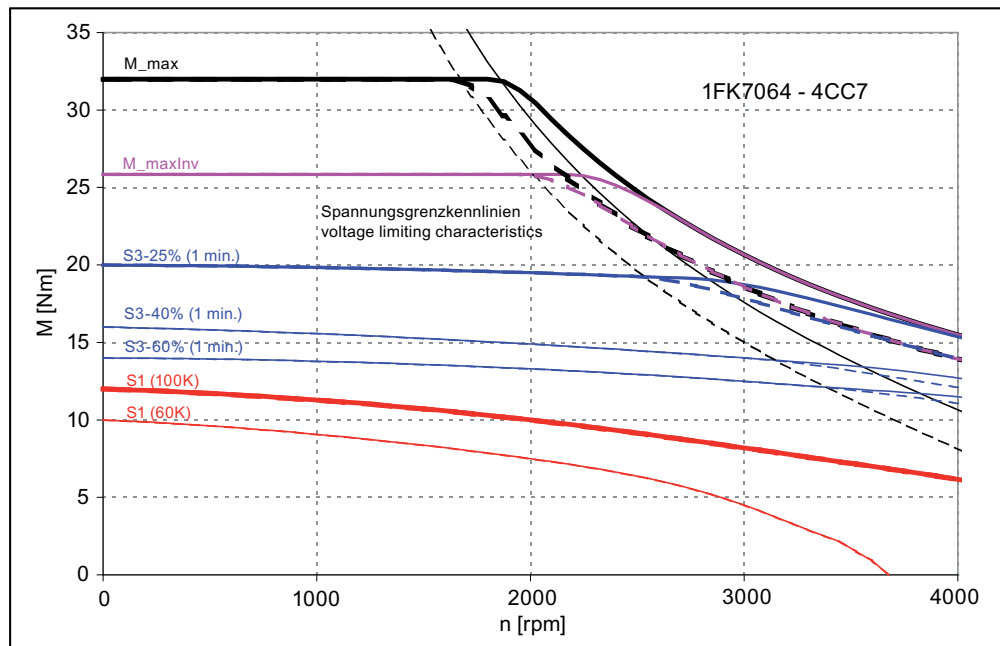

[———] SINAMICS ALM 480V-Netz (Zwischenkreisspannung 720V DC) (DC link-voltage 720 V)
 [- - - -] SINAMICS BLM/SLM 480V-Netz (Zwischenkreisspannung 650V DC) (DC-link voltage 650 V)

Figure 4-49 1FK7064-4CC71

4.2 Torque-speed characteristic

Table 4- 49 1FK7064 High Dynamic

Technical data	Code	Unit	-4CF71
Configuration data			
Rated speed	n_N	rpm	3000
Rated torque (100 K)	$M_N (100\text{ K})$	Nm	8.0
Rated current (100 K)	$I_N (100\text{ K})$	A	7.6
Static torque (100 K)	$M_0 (100\text{ K})$	Nm	12.0
Stall current (100 K)	$I_0 (100\text{ K})$	A	10.8
Static torque (60 K)	$M_0 (60\text{ K})$	Nm	10.0
Stall current (60 K)	$I_0 (60\text{ K})$	A	8.7
Optimum operating point			
Optimum speed	n_{opt}	rpm	3000
Optimum power	P_{opt}	kW	2.5
Limit data			
Max. permissible speed (mech.)	$n_{max\ mech}$	rpm	7500
Maximum torque	M_{max}	Nm	32.0
Maximum current	I_{max}	A	33.0
Motor data			
Pole number	2p		6
Torque constant (100 K)	k_T	Nm/A	1.11
Voltage constant (at 20 °C)	k_E	V/1000 rpm	70.5
Winding resistance (at 20 °C)	R_{ph}	Ω	0.348
Rotating field inductance	L_D	mH	12.0
Electrical time constant	T_{el}	ms	34.5
Mechanical time constant	T_{mech}	ms	0.64
Thermal time constant	T_{th}	min	55
Moment of inertia	J_{Mot}	kgm ²	$0.75 \cdot 10^{-3}$
Shaft torsional stiffness	C_t	Nm/rad	29500
Weight without brake	m_{Mot}	kg	15.4
Motor data with integrated brake			
Moment of inertia with brake	$J_{Mot\ Br}$	kgm ²	$0.85 \cdot 10^{-3}$
Shaft torsional stiffness with brake	$C_t\ Br$	Nm/rad	22500
Weight with brake	$m_{Mot\ Br}$	kg	16.8
Recommended Motor Module 6SL312□-□TE21-0AA□			
Rated converter current	$I_{N\ Inv}$	A	18
Maximum converter current	$I_{max\ Inv}$	A	36
Max. torque at $I_{max\ Inv}$	$M_{max\ Inv}$	Nm	32.0
Maximum permissible speed (converter)	$n_{max\ Inv}$	rpm	7500

The rated data are valid for a 600 V DC link voltage.

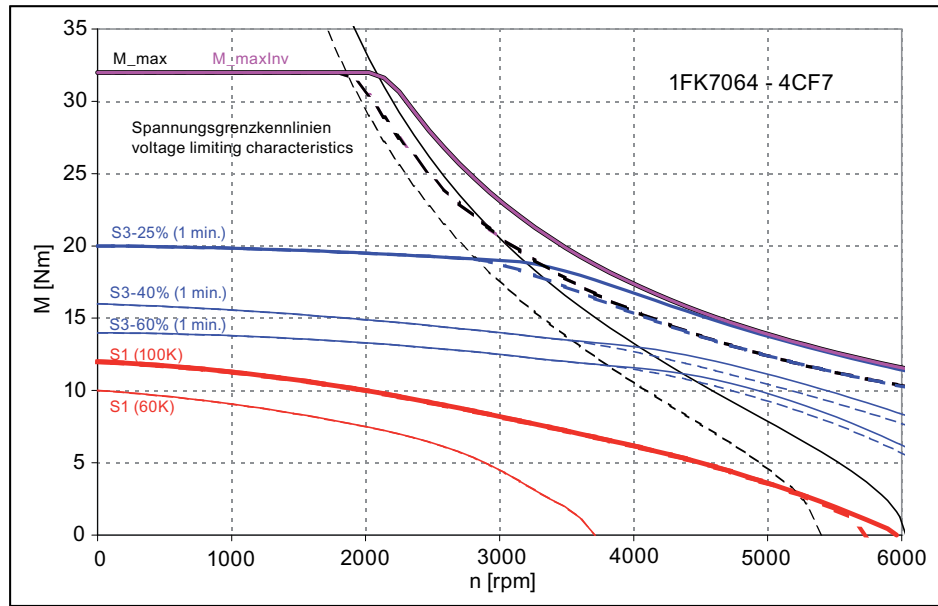

[———] SINAMICS ALM 400V-Netz (Zwischenkreisspannung 600V DC) (DC-link voltage 600 V)

[- - - -] SINAMICS BLM/SLM 400V-Netz (Zwischenkreisspannung 540V DC) (DC-link voltage 540 V)

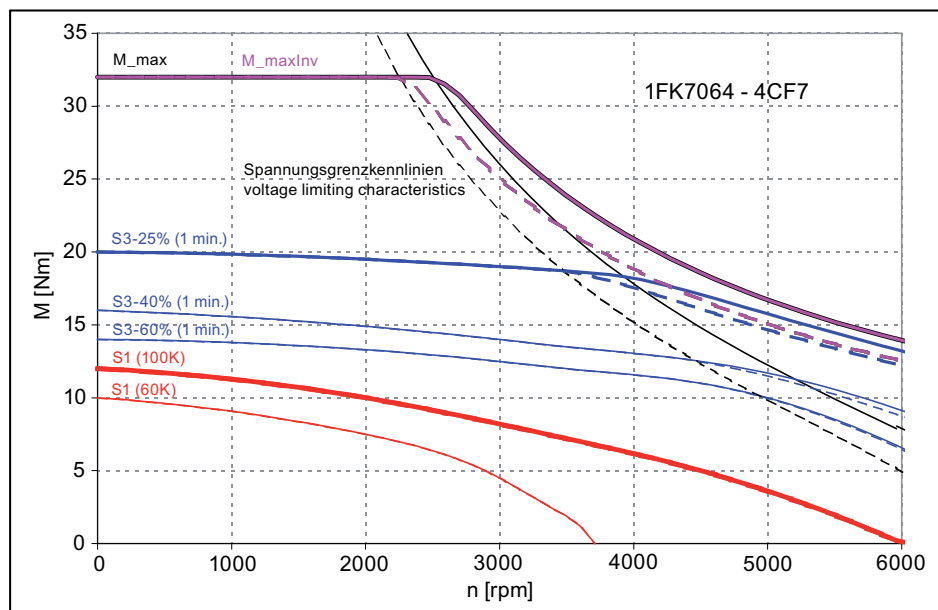

[———] SINAMICS ALM 480V-Netz (Zwischenkreisspannung 720V DC) (DC-link voltage 720 V)

[- - - -] SINAMICS BLM/SLM 480V-Netz (Zwischenkreisspannung 650V DC) (DC-link voltage 650 V)

Figure 4-50 1FK7064-4CF71

4.2 Torque-speed characteristic

Table 4- 50 1FK7064 High Dynamic

Technical data	Code	Unit	-4CH71
Configuration data			
Rated speed	n_N	rpm	4500
Rated torque (100 K)	$M_N (100\text{ K})$	Nm	5.0
Rated current (100 K)	$I_N (100\text{ K})$	A	7.0
Static torque (100 K)	$M_0 (100\text{ K})$	Nm	12.0
Stall current (100 K)	$I_0 (100\text{ K})$	A	15.0
Static torque (60 K)	$M_0 (60\text{ K})$	Nm	10.0
Stall current (60 K)	$I_0 (60\text{ K})$	A	12.2
Optimum operating point			
Optimum speed	n_{opt}	rpm	3500
Optimum power	P_{opt}	kW	2.75
Limit data			
Max. permissible speed (mech.)	$n_{max\ mech}$	rpm	7500
Maximum torque	M_{max}	Nm	32.0
Maximum current	I_{max}	A	46.0
Motor data			
Pole number	2p		6
Torque constant (100 K)	k_T	Nm/A	0.8
Voltage constant (at 20 °C)	k_E	V/1000 rpm	50.5
Winding resistance (at 20 °C)	R_{ph}	Ω	0.17
Rotating field inductance	L_D	mH	6.2
Electrical time constant	T_{el}	ms	36.5
Mechanical time constant	T_{mech}	ms	0.6
Thermal time constant	T_{th}	min	55
Moment of inertia	J_{Mot}	kgm ²	$0.75 \cdot 10^{-3}$
Shaft torsional stiffness	C_t	Nm/rad	29500
Weight without brake	m_{Mot}	kg	15.4
Motor data with integrated brake			
Moment of inertia with brake	$J_{Mot\ Br}$	kgm ²	$0.85 \cdot 10^{-3}$
Shaft torsional stiffness with brake	$C_t\ Br$	Nm/rad	22500
Weight with brake	$m_{Mot\ Br}$	kg	16.8
Recommended Motor Module 6SL312□-□TE21-8AA□			
Rated converter current	$I_{N\ Inv}$	A	18
Maximum converter current	$I_{max\ Inv}$	A	36
Max. torque at $I_{max\ Inv}$	$M_{max\ Inv}$	Nm	27.5
Maximum permissible speed (converter)	$n_{max\ Inv}$	rpm	7500

The rated data are valid for a 600 V DC link voltage.

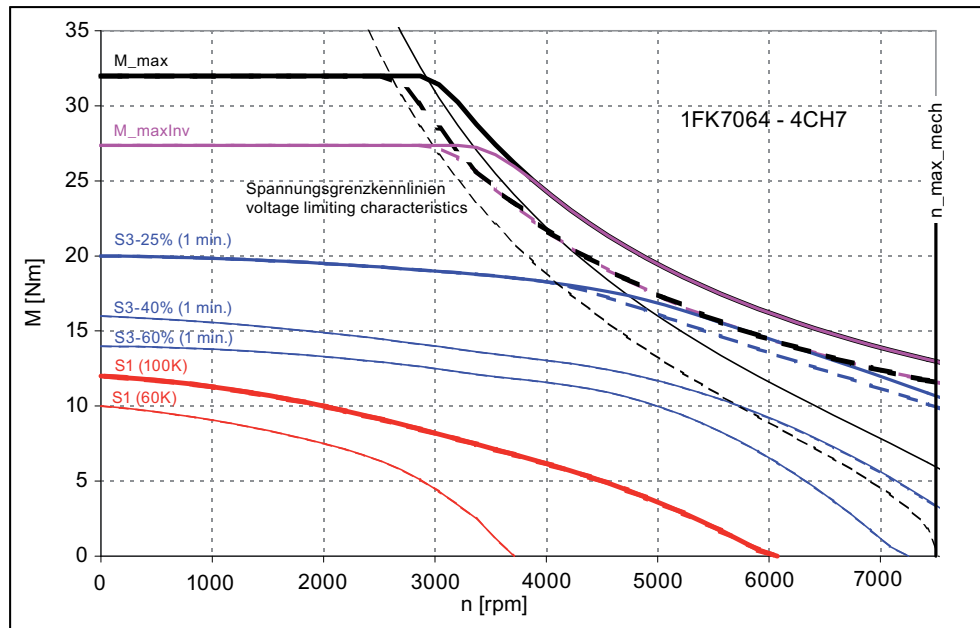

[——] SINAMICS ALM 400V-Netz (Zwischenkreisspannung 600V DC) (DC-link voltage 600 V)

[-----] SINAMICS BLM/SLM 400V-Netz (Zwischenkreisspannung 540V DC) (DC-link voltage 540 V)

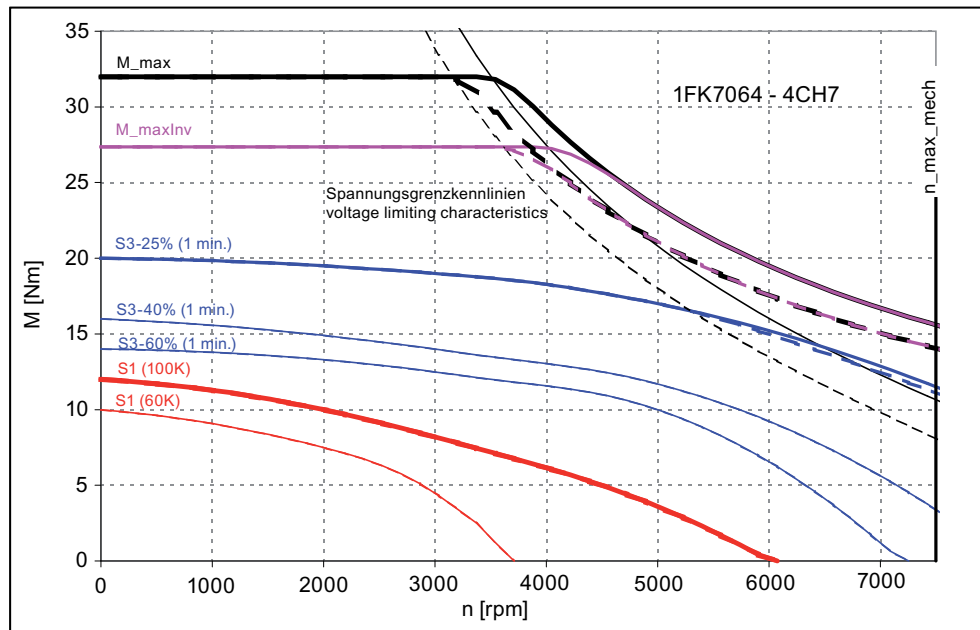

[——] SINAMICS ALM 480V-Netz (Zwischenkreisspannung 720V DC) (DC link-voltage 720 V)

[-----] SINAMICS BLM/SLM 480V-Netz (Zwischenkreisspannung 650V DC) (DC-link voltage 650 V)

Figure 4-51 1FK7064-4CH71

4.2 Torque-speed characteristic

Table 4- 51 1FK7085 High Dynamic

Technical data	Code	Unit	-4CC71
Configuration data			
Rated speed	n_N	rpm	2000
Rated torque (100 K)	$M_N (100\text{ K})$	Nm	15.0
Rated current (100 K)	$I_N (100\text{ K})$	A	10.0
Static torque (100 K)	$M_0 (100\text{ K})$	Nm	22.0
Stall current (100 K)	$I_0 (100\text{ K})$	A	13.5
Static torque (60 K)	$M_0 (60\text{ K})$	Nm	18.3
Stall current (60 K)	$I_0 (60\text{ K})$	A	10.9
Optimum operating point			
Optimum speed	n_{opt}	rpm	2000
Optimum power	P_{opt}	kW	3.15
Limit data			
Max. permissible speed (mech.)	$n_{max\ mech}$	rpm	6000
Maximum torque	M_{max}	Nm	65
Maximum current	I_{max}	A	51
Motor data			
Pole number	2p		8
Torque constant (100 K)	k_T	Nm/A	1.63
Voltage constant (at 20 °C)	k_E	V/1000 rpm	105.0
Winding resistance (at 20 °C)	R_{ph}	Ω	0.309
Rotating field inductance	L_D	mH	9.8
Electrical time constant	T_{el}	ms	31.5
Mechanical time constant	T_{mech}	ms	0.77
Thermal time constant	T_{th}	min	45
Moment of inertia	J_{Mot}	kgm ²	$2.2 \cdot 10^{-3}$
Shaft torsional stiffness	C_t	Nm/rad	84000
Weight without brake	m_{Mot}	kg	23.0
Motor data with integrated brake			
Moment of inertia with brake	$J_{Mot\ Br}$	kgm ²	$2.55 \cdot 10^{-3}$
Shaft torsional stiffness with brake	$C_t\ Br$	Nm/rad	63000
Weight with brake	$m_{Mot\ Br}$	kg	26.0
Recommended Motor Module 6SL312□-□TE21-8AA□			
Rated converter current	$I_{N\ Inv}$	A	18
Maximum converter current	$I_{max\ Inv}$	A	36
Max. torque at $I_{max\ Inv}$	$M_{max\ Inv}$	Nm	53
Maximum permissible speed (converter)	$n_{max\ Inv}$	rpm	5500

The rated data are valid for a 600 V DC link voltage.

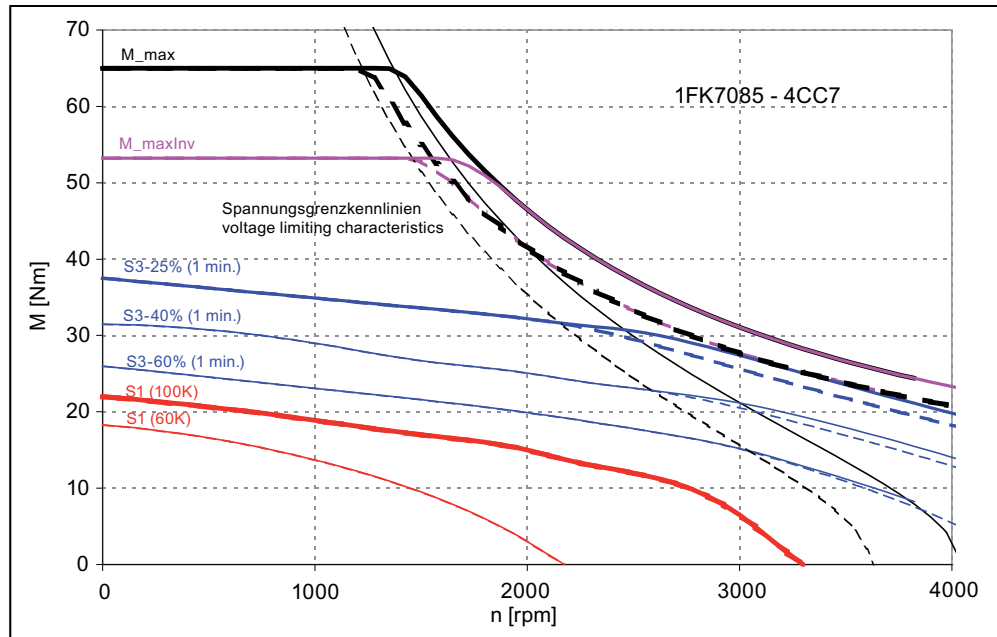

[—] SINAMICS ALM 400V-Netz (Zwischenkreisspannung 600V DC) (DC-link voltage 600 V)

[- - -] SINAMICS BLM/SLM 400V-Netz (Zwischenkreisspannung 540V DC) (DC-link voltage 540 V)

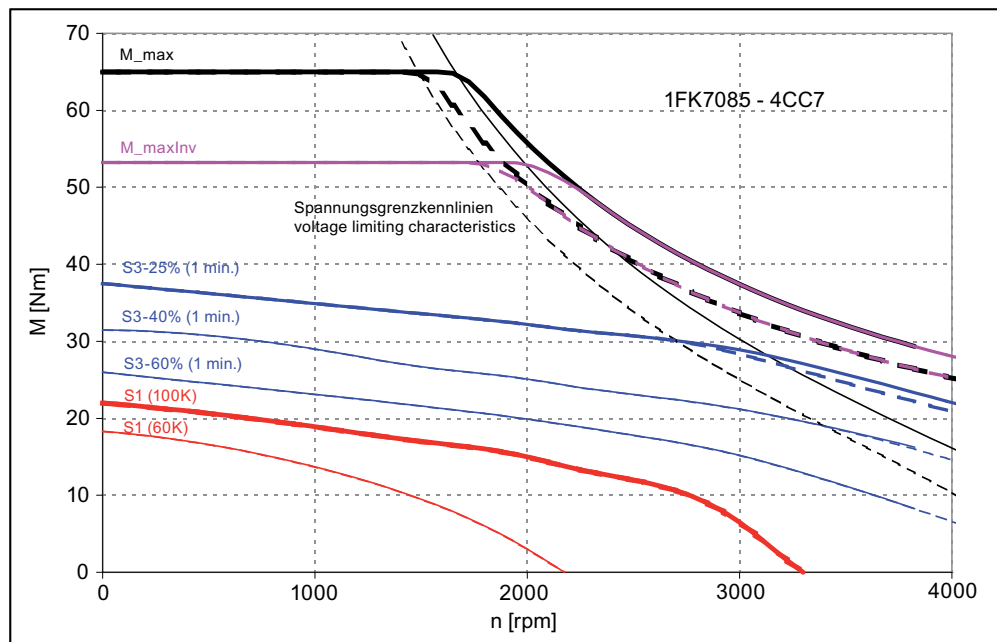

[—] SINAMICS ALM 400V-Netz (Zwischenkreisspannung 600V DC) (DC-link voltage 600 V)

[- - -] SINAMICS BLM/SLM 400V-Netz (Zwischenkreisspannung 540V DC) (DC-link voltage 540 V)

Figure 4-52 1FK7085-4CC71

4.2 Torque-speed characteristic

Table 4- 52 1FK7085 High Dynamic

Technical data	Code	Unit	-4CF71
Configuration data			
Rated speed	n_N	rpm	3000
Rated torque (100 K)	$M_N (100\text{ K})$	Nm	6.5
Rated current (100 K)	$I_N (100\text{ K})$	A	7.0
Static torque (100 K)	$M_0 (100\text{ K})$	Nm	22.0
Stall current (100 K)	$I_0 (100\text{ K})$	A	22.0
Static torque (60 K)	$M_0 (60\text{ K})$	Nm	18.3
Stall current (60 K)	$I_0 (60\text{ K})$	A	17.8
Optimum operating point			
Optimum speed	n_{opt}	rpm	2500
Optimum power	P_{opt}	kW	3.15
Limit data			
Max. permissible speed (mech.)	$n_{max\ mech}$	rpm	6000
Maximum torque	M_{max}	Nm	65
Maximum current	I_{max}	A	84
Motor data			
Pole number	2p		8
Torque constant (100 K)	k_T	Nm/A	1.0
Voltage constant (at 20 °C)	k_E	V/1000 rpm	64.5
Winding resistance (at 20 °C)	R_{ph}	Ω	0.118
Rotating field inductance	L_D	mH	3.7
Electrical time constant	T_{el}	ms	31.5
Mechanical time constant	T_{mech}	ms	0.78
Thermal time constant	T_{th}	min	65
Moment of inertia	J_{Mot}	kgm ²	$2.2 \cdot 10^{-3}$
Shaft torsional stiffness	C_t	Nm/rad	84000
Weight without brake	m_{Mot}	kg	23.0
Motor data with integrated brake			
Moment of inertia with brake	$J_{Mot\ Br}$	kgm ²	$2.55 \cdot 10^{-3}$
Shaft torsional stiffness with brake	$C_t\ Br$	Nm/rad	63000
Weight with brake	$m_{Mot\ Br}$	kg	26.0
Recommended Motor Module 6SL312□-□TE21-8AA□			
Rated converter current	$I_{N\ Inv}$	A	30
Maximum converter current	$I_{max\ Inv}$	A	56
Max. torque at $I_{max\ Inv}$	$M_{max\ Inv}$	Nm	51
Maximum permissible speed (converter)	$n_{max\ Inv}$	rpm	6000

The rated data are valid for a 600 V DC link voltage.

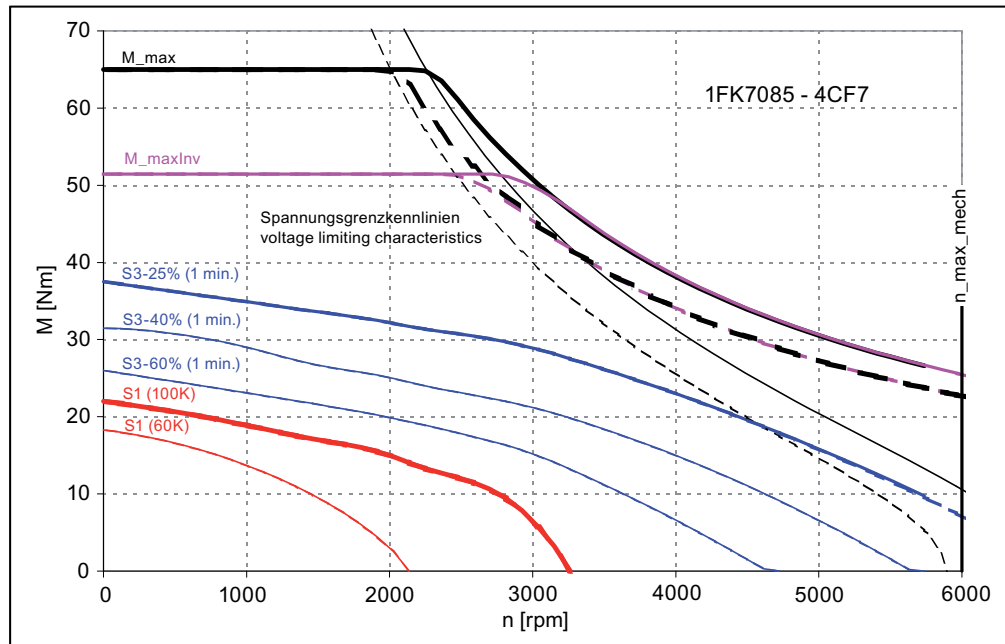

[——] SINAMICS ALM 400V-Netz (Zwischenkreisspannung 600V DC) (DC-link voltage 600 V)

[-----] SINAMICS BLM/SLM 400V-Netz (Zwischenkreisspannung 540V DC) (DC-link voltage 540 V)

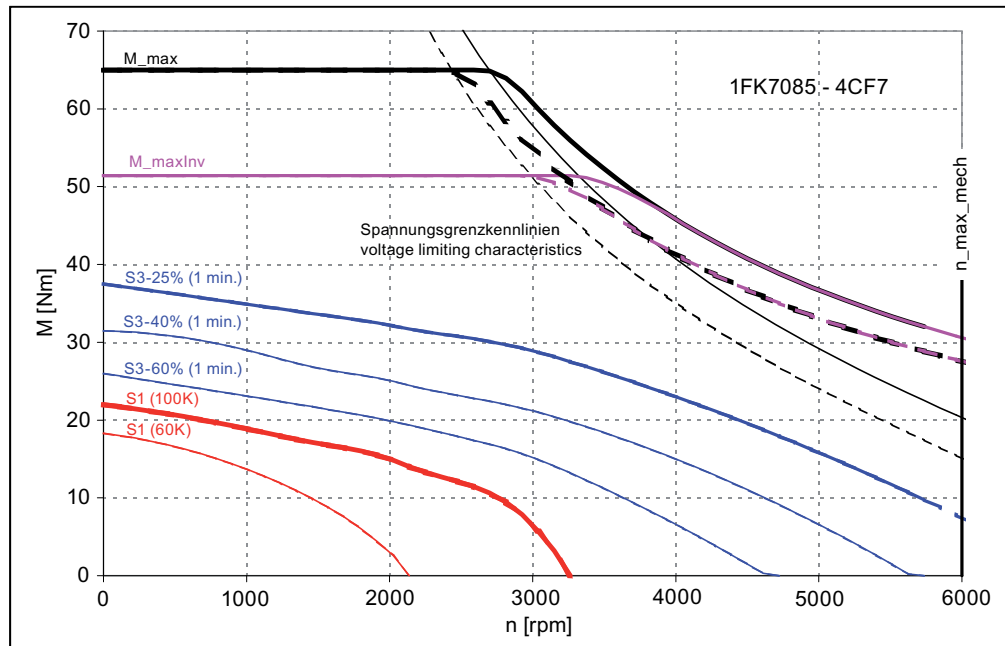

[——] SINAMICS ALM 480V-Netz (Zwischenkreisspannung 720V DC) (DC-link voltage 720 V)

[-----] SINAMICS BLM/SLM 480V-Netz (Zwischenkreisspannung 650V DC) (DC-link voltage 650 V)

Figure 4-53 1FK7085-4CF71

4.2 Torque-speed characteristic

Table 4- 53 1FK7086 High Dynamic

Technical data	Code	Unit	-4CC71
Configuration data			
Rated speed	n_N	rpm	2000
Rated torque (100 K)	$M_N (100\text{ K})$	Nm	18.0
Rated current (100 K)	$I_N (100\text{ K})$	A	9.0
Static torque (100 K)	$M_0 (100\text{ K})$	Nm	28.0
Stall current (100 K)	$I_0 (100\text{ K})$	A	13.2
Static torque (60 K)	$M_0 (60\text{ K})$	Nm	23.0
Stall current (60 K)	$I_0 (60\text{ K})$	A	10.7
Optimum operating point			
Optimum speed	n_{opt}	rpm	200
Optimum power	P_{opt}	kW	3.75
Limit data			
Max. permissible speed (mech.)	$n_{max\ mech}$	rpm	6000
Maximum torque	M_{max}	Nm	105
Maximum current	I_{max}	A	71
Motor data			
Pole number	2p		8
Torque constant (100 K)	k_T	Nm/A	2.12
Voltage constant (at 20 °C)	k_E	V/1000 rpm	138.0
Winding resistance (at 20 °C)	R_{ph}	Ω	0.309
Rotating field inductance	L_D	mH	8.2
Electrical time constant	T_{el}	ms	26.5
Mechanical time constant	T_{mech}	ms	0.455
Thermal time constant	T_{th}	min	65
Moment of inertia	J_{Mot}	kgm ²	$2.2 \cdot 10^{-3}$
Shaft torsional stiffness	C_t	Nm/rad	84000
Weight without brake	m_{Mot}	kg	23.0
Motor data with integrated brake			
Moment of inertia with brake	$J_{Mot\ Br}$	kgm ²	$2.55 \cdot 10^{-3}$
Shaft torsional stiffness with brake	$C_t\ Br$	Nm/rad	63000
Weight with brake	$m_{Mot\ Br}$	kg	26.0
Recommended Motor Module 6SL312□-□TE21-8AA□			
Rated converter current	$I_{N\ Inv}$	A	18
Maximum converter current	$I_{max\ Inv}$	A	36
Max. torque at $I_{max\ Inv}$	$M_{max\ Inv}$	Nm	69
Maximum permissible speed (converter)	$n_{max\ Inv}$	rpm	4200

The rated data are valid for a 600 V DC link voltage.

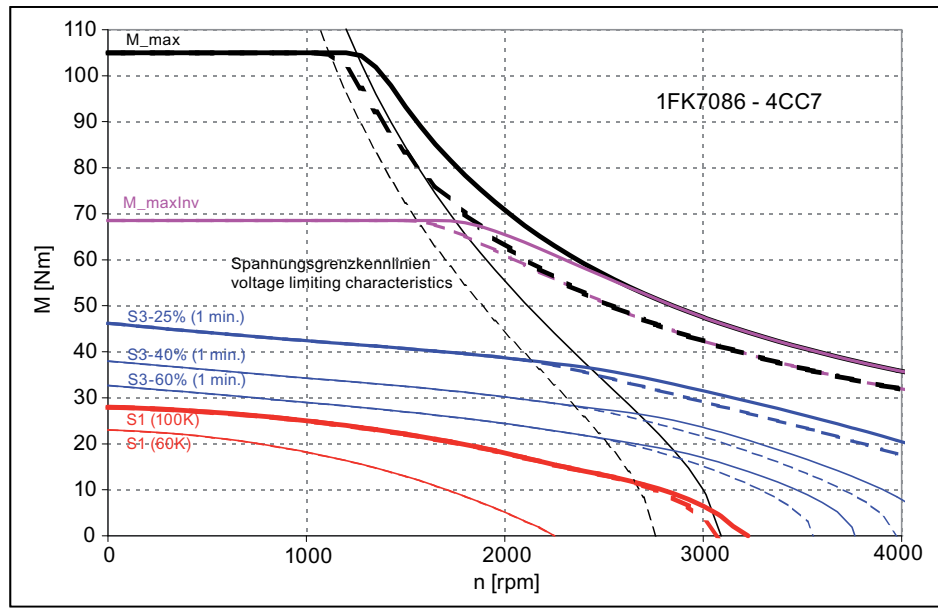

[———] SINAMICS ALM 400V-Netz (Zwischenkreisspannung 600V DC) (DC-link voltage 600 V)

[- - - -] SINAMICS BLM/SLM 400V-Netz (Zwischenkreisspannung 540V DC) (DC-link voltage 540 V)

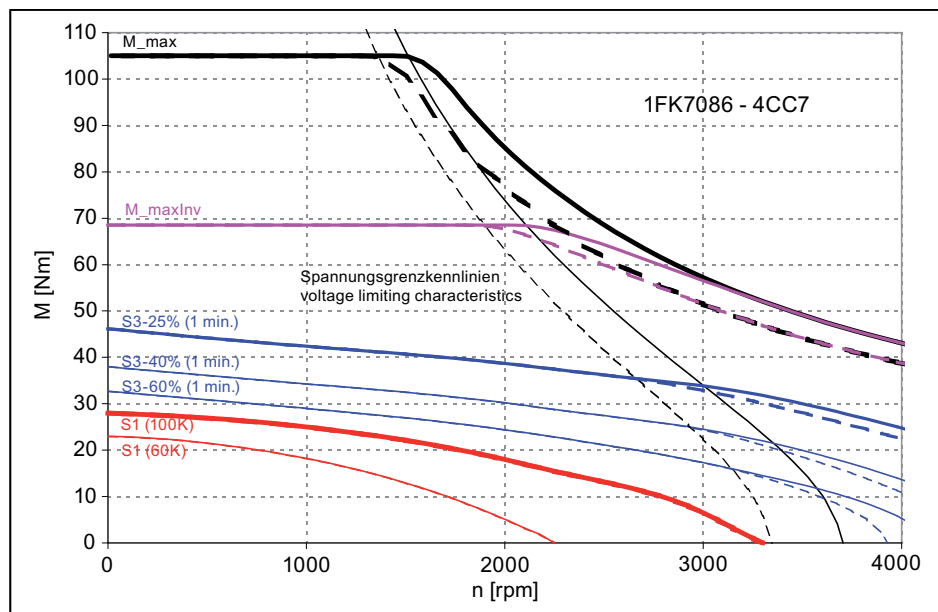

[———] SINAMICS ALM 400V-Netz (Zwischenkreisspannung 600V DC) (DC-link voltage 600 V)

[- - - -] SINAMICS BLM/SLM 400V-Netz (Zwischenkreisspannung 540V DC) (DC-link voltage 540 V)

Figure 4-54 1FK7086-4CC71

4.2 Torque-speed characteristic

Table 4- 54 1FK7086 High Dynamic

Technical data	Code	Unit	-4CF71
Configuration data			
Rated speed	n_N	rpm	3000
Rated torque (100 K)	$M_N (100\text{ K})$	Nm	6.5
Rated current (100 K)	$I_N (100\text{ K})$	A	5.7
Static torque (100 K)	$M_0 (100\text{ K})$	Nm	28.0
Stall current (100 K)	$I_0 (100\text{ K})$	A	21.5
Static torque (60 K)	$M_0 (60\text{ K})$	Nm	23.0
Stall current (60 K)	$I_0 (60\text{ K})$	A	17.4
Optimum operating point			
Optimum speed	n_{opt}	rpm	2000
Optimum power	P_{opt}	kW	3.75
Limit data			
Max. permissible speed (mech.)	$n_{max\ mech}$	rpm	6000
Maximum torque	M_{max}	Nm	105
Maximum current	I_{max}	A	115
Motor data			
Pole number	2p		8
Torque constant (100 K)	k_T	Nm/A	1.3
Voltage constant (at 20 °C)	k_E	V/1000 rpm	84.5
Winding resistance (at 20 °C)	R_{ph}	Ω	0.118
Rotating field inductance	L_D	mH	3.1
Electrical time constant	T_{el}	ms	26.5
Mechanical time constant	T_{mech}	ms	0.46
Thermal time constant	T_{th}	min	65
Moment of inertia	J_{Mot}	kgm ²	$2.2 \cdot 10^{-3}$
Shaft torsional stiffness	C_t	Nm/rad	84000
Weight without brake	m_{Mot}	kg	23.0
Motor data with integrated brake			
Moment of inertia with brake	$J_{Mot\ Br}$	kgm ²	$2.55 \cdot 10^{-3}$
Shaft torsional stiffness with brake	$C_t\ Br$	Nm/rad	63000
Weight with brake	$m_{Mot\ Br}$	kg	26.0
Recommended Motor Module 6SL312□-□TE23-0AA□			
Rated converter current	$I_{N\ Inv}$	A	30
Maximum converter current	$I_{max\ Inv}$	A	56
Max. torque at $I_{max\ Inv}$	$M_{max\ Inv}$	Nm	66
Maximum permissible speed (converter)	$n_{max\ Inv}$	rpm	6000

The rated data are valid for a 600 V DC link voltage.

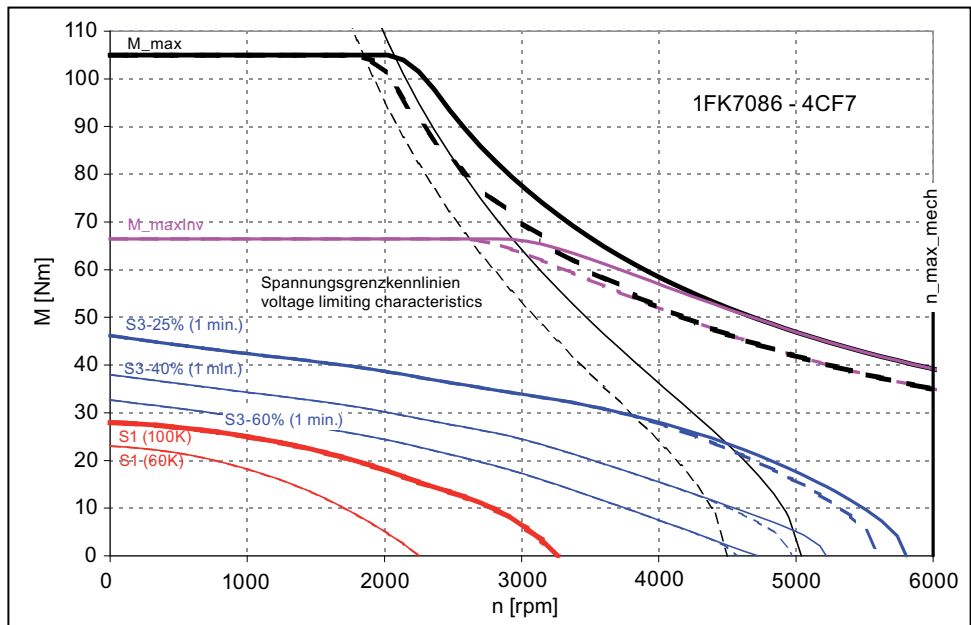

[——] SINAMICS ALM 400V-Netz (Zwischenkreisspannung 600V DC) (DC-link voltage 600 V)

[-----] SINAMICS BLM/SLM 400V-Netz (Zwischenkreisspannung 540V DC) (DC-link voltage 540 V)

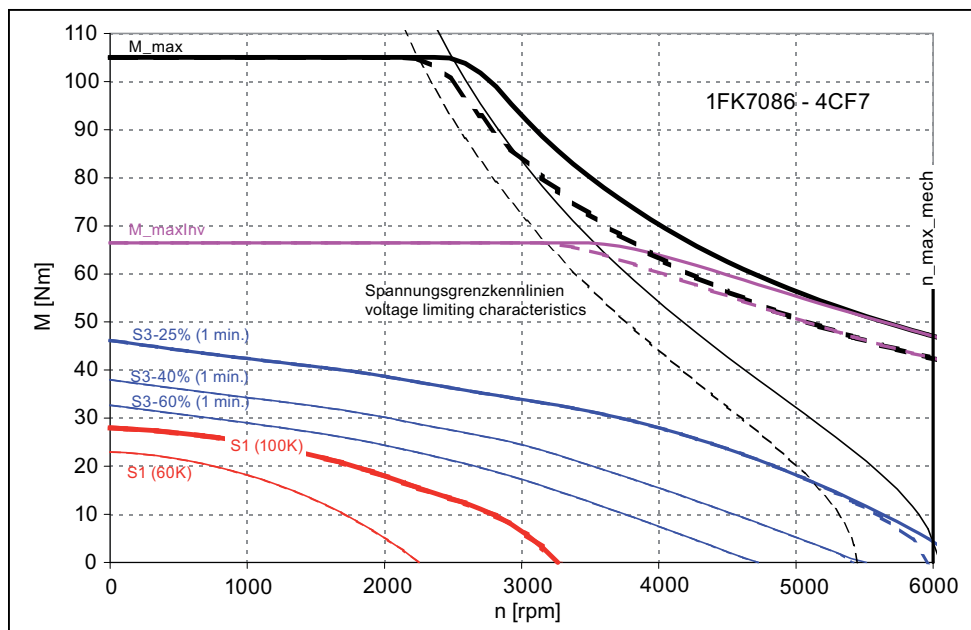

[——] SINAMICS ALM 480V-Netz (Zwischenkreisspannung 720V DC) (DC-link voltage 720 V)

[-----] SINAMICS BLM/SLM 480V-Netz (Zwischenkreisspannung 650V DC) (DC-link voltage 650 V)

Figure 4-55 1FK7086-4CF71

4.2 Torque-speed characteristic

4.2.1.3 1FK7 High Inertia

Table 4- 55 1FK7042 High Inertia

Technical data	Code	Unit	-3BK71
Configuration data			
Rated speed	n_N	rpm	6000
Rated torque (100 K)	$M_N (100 K)$	Nm	1.5
Rated current (100 K)	$I_N (100 K)$	A	2.5
Static torque (100 K)	$M_0 (100 K)$	Nm	3.0
Stall current (100 K)	$I_0 (100 K)$	A	4.4
Static torque (60 K)	$M_0 (60 K)$	Nm	2.5
Stall current (60 K)	$I_0 (60 K)$	A	3.55
Optimum operating point			
Optimum speed	n_{opt}	rpm	5000
Optimum power	P_{opt}	kW	1.02
Limit data			
Max. permissible speed (mech.)	$n_{max mech}$	rpm	9000
Maximum torque	M_{max}	Nm	10.5
Maximum current	I_{max}	A	15.3
Motor data			
Pole number	2p		8
Torque constant (100 K)	k_T	Nm/A	0.68
Voltage constant (at 20 °C)	k_E	V/1000 rpm	44.5
Winding resistance (at 20 °C)	R_{ph}	Ω	1.145
Rotating field inductance	L_D	mH	8.6
Electrical time constant	T_{el}	ms	7.5
Mechanical time constant	T_{mech}	ms	3.8
Thermal time constant	T_{th}	min	30
Moment of inertia	J_{Mot}	kgm ²	$0.51 \cdot 10^{-3}$
Shaft torsional stiffness	C_t	Nm/rad	14600
Weight without brake	m_{Mot}	kg	5.1
Motor data with integrated brake			
Moment of inertia with brake	$J_{Mot Br}$	kgm ²	$0.54 \cdot 10^{-3}$
Shaft torsional stiffness with brake	$C_t Br$	Nm/rad	10900
Weight with brake	$m_{Mot Br}$	kg	5.8
Recommended Motor Module 6SL312□-□TE15-0AA□			
Rated converter current	$I_N Inv$	A	5
Maximum converter current	$I_{max Inv}$	A	10
Max. torque at $I_{max Inv}$	$M_{max Inv}$	Nm	6.8
Maximum permissible speed (converter)	$n_{max Inv}$	rpm	9000

The rated data are valid for a 600 V DC link voltage.

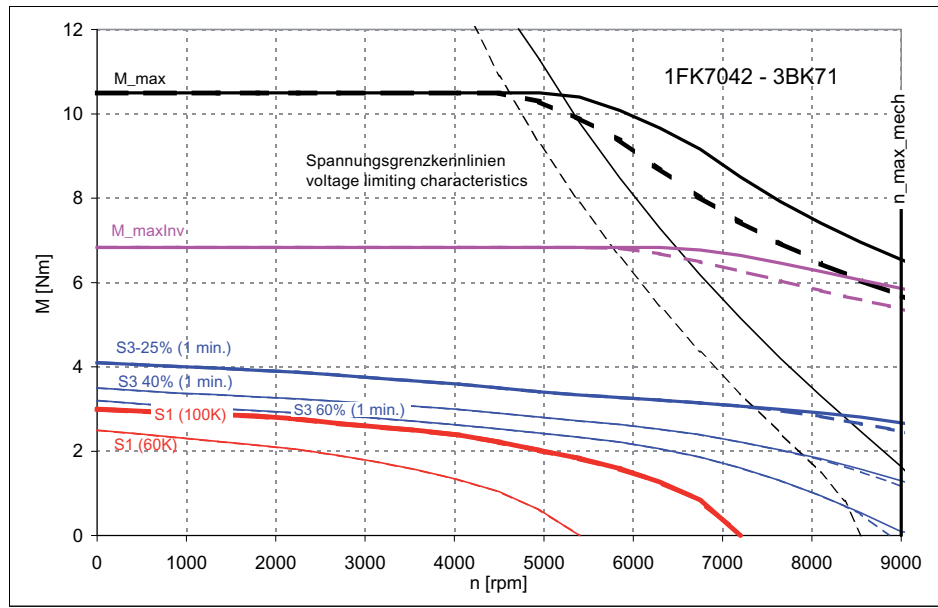

[————] SINAMICS ALM 400 V-Netz (Zwischenkreisspannung 600 V DC) (DC-link voltage 600 V)

[-----] SINAMICS BLM/SLM 400 V-Netz (Zwischenkreisspannung 540 V DC) (DC-link voltage 540 V)

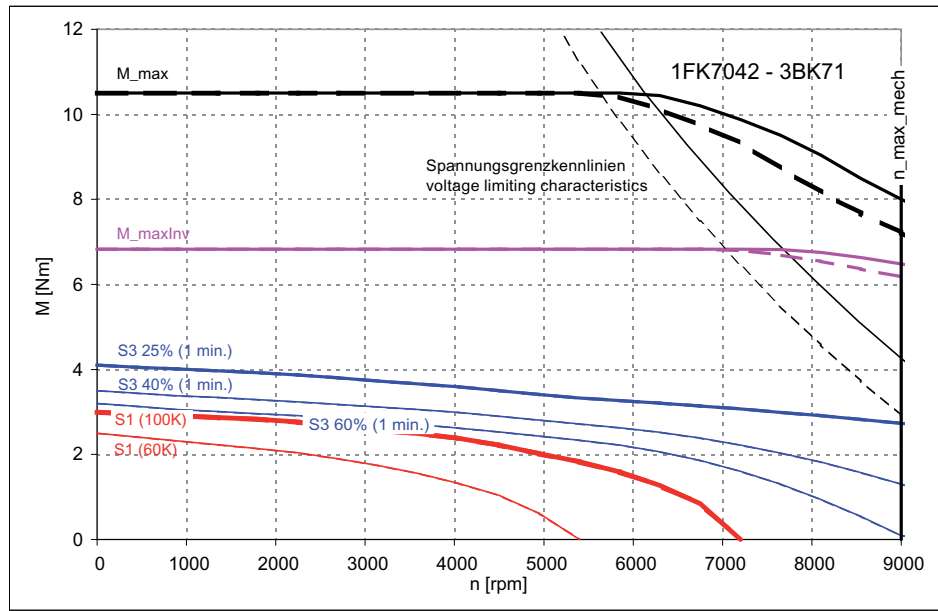

[————] SINAMICS ALM 480 V-Netz (Zwischenkreisspannung 720 V DC) (DC-link voltage 720 V)

[-----] SINAMICS BLM/SLM 480 V-Netz (Zwischenkreisspannung 650 V DC) (DC-link voltage 650 V)

Figure 4-56 1FK7042-3BK71

4.2 Torque-speed characteristic

Table 4- 56 1FK7060 High Inertia

Technical data	Code	Unit	-3BF71
Configuration data			
Rated speed	n_N	rpm	3000
Rated torque (100 K)	$M_N (100\text{ K})$	Nm	4.7
Rated current (100 K)	$I_N (100\text{ K})$	A	3.7
Static torque (100 K)	$M_0 (100\text{ K})$	Nm	6.0
Stall current (100 K)	$I_0 (100\text{ K})$	A	4.45
Static torque (60 K)	$M_0 (60\text{ K})$	Nm	5.0
Stall current (60 K)	$I_0 (60\text{ K})$	A	3.6
Optimum operating point			
Optimum speed	n_{opt}	rpm	3000
Optimum power	P_{opt}	kW	1.48
Limit data			
Max. permissible speed (mech.)	$n_{max\ mech}$	rpm	7200
Maximum torque	M_{max}	Nm	18.0
Maximum current	I_{max}	A	15.0
Motor data			
Pole number	2p		8
Torque constant (100 K)	k_T	Nm/A	1.33
Voltage constant (at 20 °C)	k_E	V/1000 rpm	85.5
Winding resistance (at 20 °C)	R_{ph}	Ω	1.35
Rotating field inductance	L_D	mH	15.2
Electrical time constant	T_{el}	ms	11.3
Mechanical time constant	T_{mech}	ms	2.8
Thermal time constant	T_{th}	min	30
Moment of inertia	J_{Mot}	kgm ²	$1.25 \cdot 10^{-3}$
Shaft torsional stiffness	C_t	Nm/rad	38500
Weight without brake	m_{Mot}	kg	7.9
Motor data with integrated brake			
Moment of inertia with brake	$J_{Mot\ Br}$	kgm ²	$1.35 \cdot 10^{-3}$
Shaft torsional stiffness with brake	$C_t\ Br$	Nm/rad	27500
Weight with brake	$m_{Mot\ Br}$	kg	9.3
Recommended Motor Module 6SL312□-□TE15-0AA□			
Rated converter current	$I_{N\ Inv}$	A	5
Maximum converter current	$I_{max\ Inv}$	A	10
Max. torque at $I_{max\ Inv}$	$M_{max\ Inv}$	Nm	13.2
Maximum permissible speed (converter)	$n_{max\ Inv}$	rpm	6700

The rated data are valid for a 600 V DC link voltage.

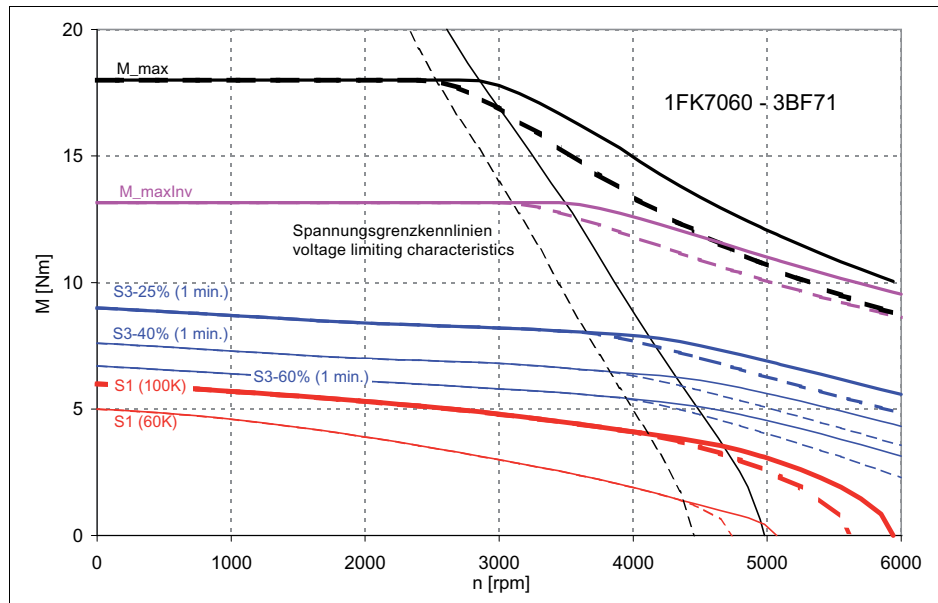

[—————] SINAMICS ALM 400 V-Netz (Zwischenkreisspannung 600 V DC) (DC-link voltage 600 V)

[- - - - -] SINAMICS BLM/SLM 400 V-Netz (Zwischenkreisspannung 540 V DC) (DC-link voltage 540 V)

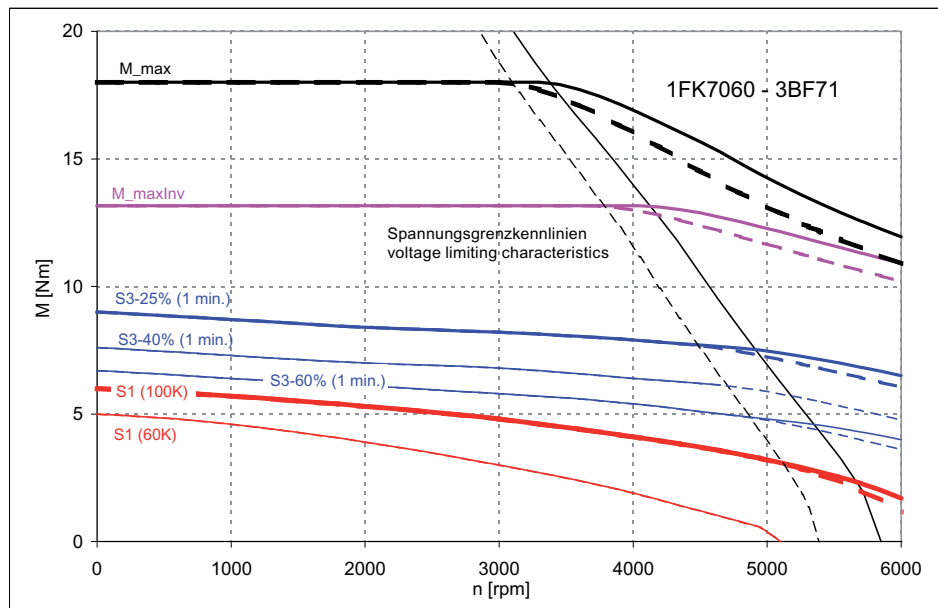

[—————] SINAMICS ALM 480 V-Netz (Zwischenkreisspannung 720 V DC) (DC-link voltage 720 V)

[- - - - -] SINAMICS BLM/SLM 480 V-Netz (Zwischenkreisspannung 650 V DC) (DC-link voltage 650 V)

Figure 4-57 1FK7060-3BF71

4.2 Torque-speed characteristic

Table 4- 57 1FK7062 High Inertia

Technical data	Code	Unit	-3BF71
Configuration data			
Rated speed	n_N	rpm	3000
Rated torque (100 K)	$M_N (100\text{ K})$	Nm	6.0
Rated current (100 K)	$I_N (100\text{ K})$	A	4.0
Static torque (100 K)	$M_0 (100\text{ K})$	Nm	8.5
Stall current (100 K)	$I_0 (100\text{ K})$	A	5.3
Static torque (60 K)	$M_0 (60\text{ K})$	Nm	7.1
Stall current (60 K)	$I_0 (60\text{ K})$	A	4.3
Optimum operating point			
Optimum speed	n_{opt}	rpm	3000
Optimum power	P_{opt}	kW	1.6
Limit data			
Max. permissible speed (mech.)	$n_{max\ mech}$	rpm	7200
Maximum torque	M_{max}	Nm	26.0
Maximum current	I_{max}	A	19.2
Motor data			
Pole number	2p		8
Torque constant (100 K)	k_T	Nm/A	1.605
Voltage constant (at 20 °C)	k_E	V/1000 rpm	102.5
Winding resistance (at 20 °C)	R_{ph}	Ω	1.145
Rotating field inductance	L_D	mH	14.6
Electrical time constant	T_{el}	ms	12.8
Mechanical time constant	T_{mech}	ms	3.15
Thermal time constant	T_{th}	min	35
Moment of inertia	J_{Mot}	kgm ²	$2.35 \cdot 10^{-3}$
Shaft torsional stiffness	C_t	Nm/rad	34500
Weight without brake	m_{Mot}	kg	10.7
Motor data with integrated brake			
Moment of inertia with brake	$J_{Mot\ Br}$	kgm ²	$2.45 \cdot 10^{-3}$
Shaft torsional stiffness with brake	$C_t\ Br$	Nm/rad	25000
Weight with brake	$m_{Mot\ Br}$	kg	12.1
Recommended Motor Module 6SL312□-□TE15-0AA□			
Rated converter current	$I_{N\ Inv}$	A	5
Maximum converter current	$I_{max\ Inv}$	A	10
Max. torque at $I_{max\ Inv}$	$M_{max\ Inv}$	Nm	16.0
Maximum permissible speed (converter)	$n_{max\ Inv}$	rpm	5600

The rated data are valid for a 600 V DC link voltage.

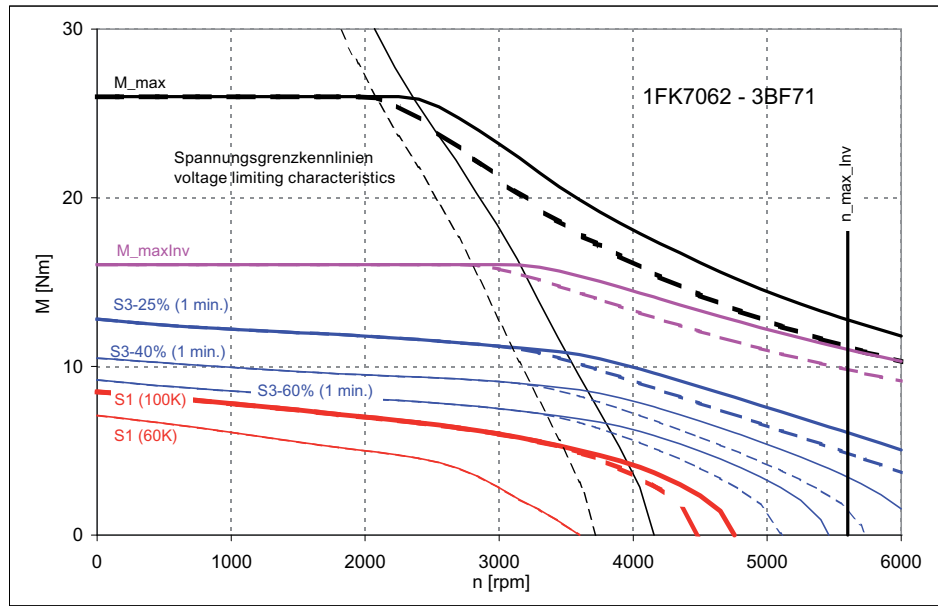

[————] SINAMICS ALM 400 V-Netz (Zwischenkreisspannung 600 V DC) (DC-link voltage 600 V)
 [-----] SINAMICS BLM/SLM 400 V-Netz (Zwischenkreisspannung 540 V DC) (DC-link voltage 540 V)

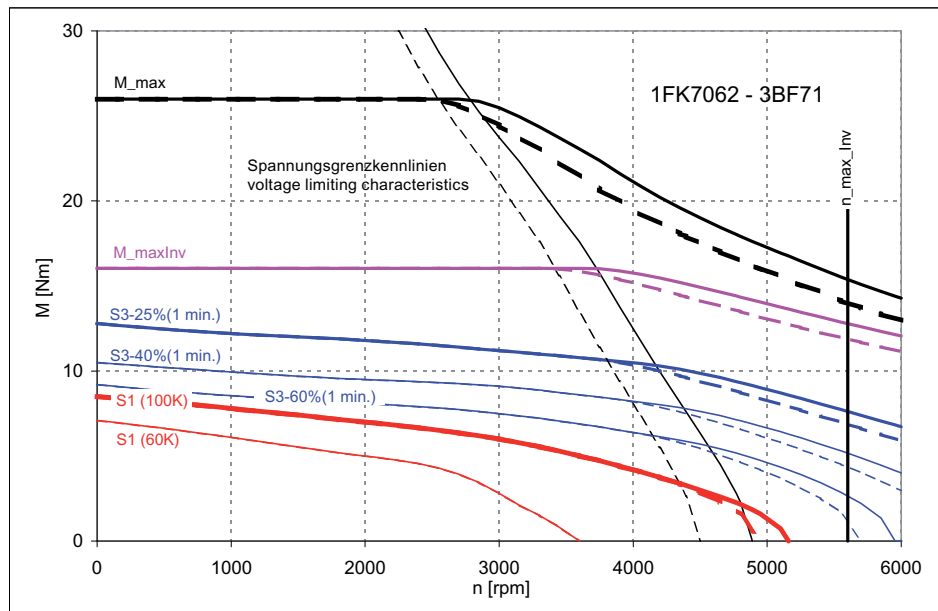

[————] SINAMICS ALM 480 V-Netz (Zwischenkreisspannung 720 V DC) (DC-link voltage 720 V)
 [-----] SINAMICS BLM/SLM 480 V-Netz (Zwischenkreisspannung 650 V DC) (DC-link voltage 650 V)

Figure 4-58 1FK7062-3BF71

4.2 Torque-speed characteristic

Table 4- 58 1FK7081 High Inertia

Technical data	Code	Unit	-3BF71
Configuration data			
Rated speed	n_N	rpm	3000
Rated torque (100 K)	$M_N (100\text{ K})$	Nm	8.7
Rated current (100 K)	$I_N (100\text{ K})$	A	6.8
Static torque (100 K)	$M_0 (100\text{ K})$	Nm	12.0
Stall current (100 K)	$I_0 (100\text{ K})$	A	8.7
Static torque (60 K)	$M_0 (60\text{ K})$	Nm	10.0
Stall current (60 K)	$I_0 (60\text{ K})$	A	7.1
Optimum operating point			
Optimum speed	n_{opt}	rpm	3000
Optimum power	P_{opt}	kW	2.75
Limit data			
Max. permissible speed (mech.)	$n_{max\ mech}$	rpm	6000
Maximum torque	M_{max}	Nm	37.0
Maximum current	I_{max}	A	30.0
Motor data			
Pole number	2p		8
Torque constant (100 K)	k_T	Nm/A	1.375
Voltage constant (at 20 °C)	k_E	V/1000 rpm	88.5
Winding resistance (at 20 °C)	R_{ph}	Ω	0.424
Rotating field inductance	L_D	mH	7.7
Electrical time constant	T_{el}	ms	18.2
Mechanical time constant	T_{mech}	ms	3.3
Thermal time constant	T_{th}	min	45
Moment of inertia	J_{Mot}	kgm ²	$4.90 \cdot 10^{-3}$
Shaft torsional stiffness	C_t	Nm/rad	100000
Weight without brake	m_{Mot}	kg	15.2
Motor data with integrated brake			
Moment of inertia with brake	$J_{Mot\ Br}$	kgm ²	$5.20 \cdot 10^{-3}$
Shaft torsional stiffness with brake	$C_t\ Br$	Nm/rad	71000
Weight with brake	$m_{Mot\ Br}$	kg	18.2
Recommended Motor Module 6SL312□-□TE21-0AA□			
Rated converter current	$I_{N\ Inv}$	A	9
Maximum converter current	$I_{max\ Inv}$	A	18
Max. torque at $I_{max\ Inv}$	$M_{max\ Inv}$	Nm	24.7
Maximum permissible speed (converter)	$n_{max\ Inv}$	rpm	6000

The rated data are valid for a 600 V DC link voltage.

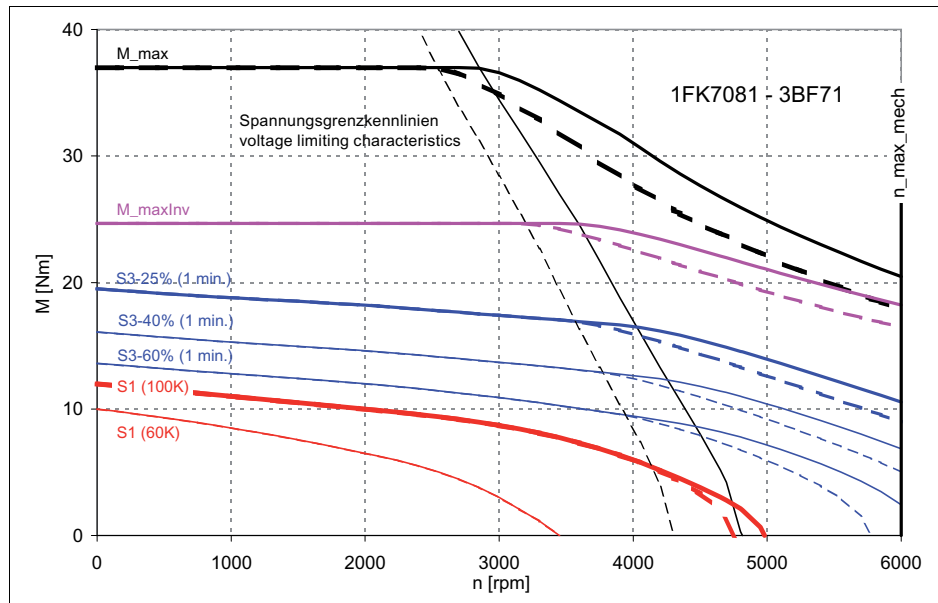

[—————] SINAMICS ALM 400 V-Netz (Zwischenkreisspannung 600 V DC) (DC-link voltage 600 V)

[- - - - -] SINAMICS BLM/SLM 400 V-Netz (Zwischenkreisspannung 540 V DC) (DC-link voltage 540 V)

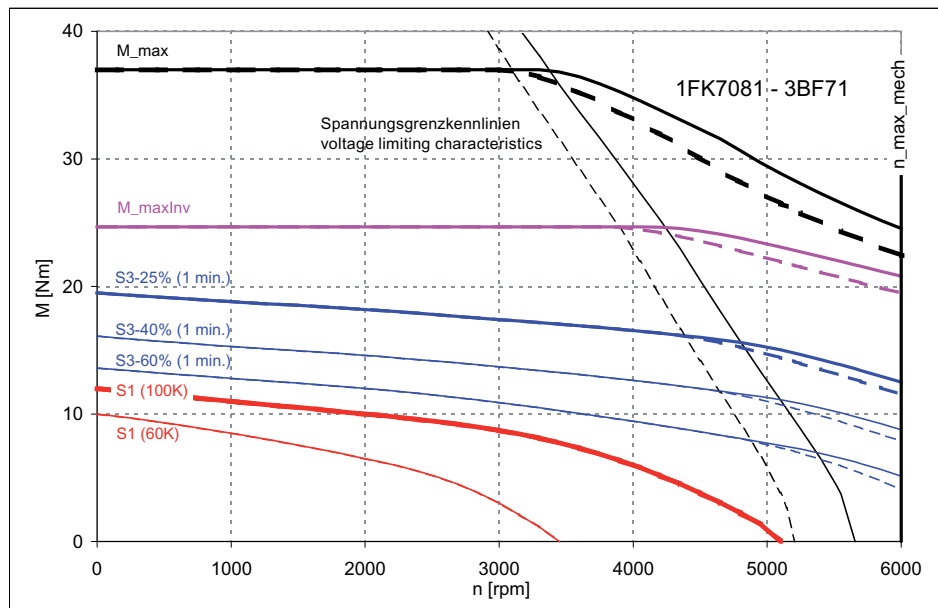

[—————] SINAMICS ALM 480 V-Netz (Zwischenkreisspannung 720 V DC) (DC-link voltage 720 V)

[- - - - -] SINAMICS BLM/SLM 480 V-Netz (Zwischenkreisspannung 650 V DC) (DC-link voltage 650 V)

Figure 4-59 1FK7081-3BF71

4.2 Torque-speed characteristic

Table 4- 59 1FK7084 High Inertia

Technical data	Code	Unit	-3BC71
Configuration data			
Rated speed	n_N	rpm	2000
Rated torque (100 K)	$M_N (100\text{ K})$	Nm	15.0
Rated current (100 K)	$I_N (100\text{ K})$	A	6.7
Static torque (100 K)	$M_0 (100\text{ K})$	Nm	20.0
Stall current (100 K)	$I_0 (100\text{ K})$	A	8.5
Static torque (60 K)	$M_0 (60\text{ K})$	Nm	16.8
Stall current (60 K)	$I_0 (60\text{ K})$	A	6.9
Optimum operating point			
Optimum speed	n_{opt}	rpm	2000
Optimum power	P_{opt}	kW	3.15
Limit data			
Max. permissible speed (mech.)	$n_{max\ mech}$	rpm	6000
Maximum torque	M_{max}	Nm	61
Maximum current	I_{max}	A	28.5
Motor data			
Pole number	2p		8
Torque constant (100 K)	k_T	Nm/A	2.36
Voltage constant (at 20 °C)	k_E	V/1000 rpm	152.0
Winding resistance (at 20 °C)	R_{ph}	Ω	0.585
Rotating field inductance	L_D	mH	12.0
Electrical time constant	T_{el}	ms	20.5
Mechanical time constant	T_{mech}	ms	3.1
Thermal time constant	T_{th}	min	55
Moment of inertia	J_{Mot}	kgm ²	$9.9 \cdot 10^{-3}$
Shaft torsional stiffness	C_t	Nm/rad	82000
Weight without brake	m_{Mot}	kg	23.0
Motor data with integrated brake			
Moment of inertia with brake	$J_{Mot\ Br}$	kgm ²	$10.2 \cdot 10^{-3}$
Shaft torsional stiffness with brake	$C_t\ Br$	Nm/rad	62000
Weight with brake	$m_{Mot\ Br}$	kg	26.0
Recommended Motor Module 6SL312□-□TE215-0AA□			
Rated converter current	$I_{N\ Inv}$	A	9
Maximum converter current	$I_{max\ Inv}$	A	18
Max. torque at $I_{max\ Inv}$	$M_{max\ Inv}$	Nm	41.9
Maximum permissible speed (converter)	$n_{max\ Inv}$	rpm	3800

The rated data are valid for a 600 V DC link voltage.

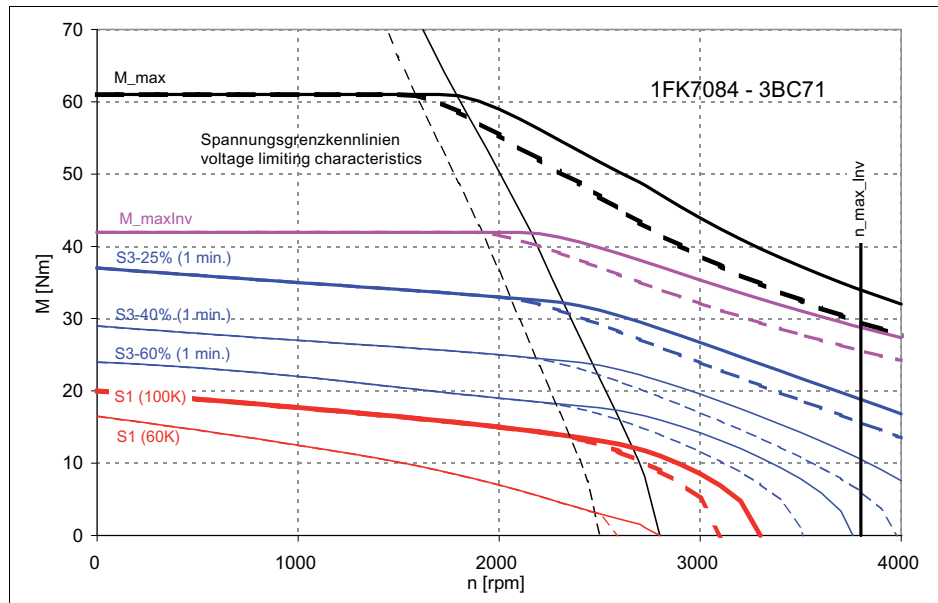

[—————] SINAMICS ALM 400 V-Netz (Zwischenkreisspannung 600 V DC) (DC-link voltage 600 V)

[- - - - -] SINAMICS BLM/SLM 400 V-Netz (Zwischenkreisspannung 540 V DC) (DC-link voltage 540 V)

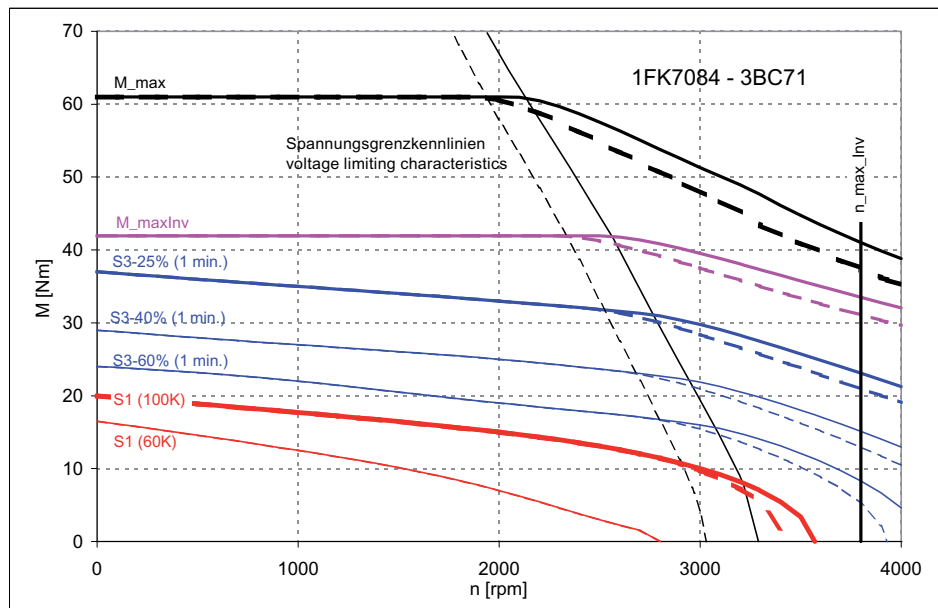

[—————] SINAMICS ALM 480 V-Netz (Zwischenkreisspannung 720 V DC) (DC-link voltage 720 V)

[- - - - -] SINAMICS BLM/SLM 480 V-Netz (Zwischenkreisspannung 650 V DC) (DC-link voltage 650 V)

Figure 4-60 1FK7084-3BC71

4.2 Torque-speed characteristic

Table 4- 60 1FK7084 High Inertia

Technical data	Code	Unit	-3BF71
Configuration data			
Rated speed	n_N	rpm	3000
Rated torque (100 K)	$M_N (100\text{ K})$	Nm	10.0
Rated current (100 K)	$I_N (100\text{ K})$	A	6.5
Static torque (100 K)	$M_0 (100\text{ K})$	Nm	20.0
Stall current (100 K)	$I_0 (100\text{ K})$	A	12.1
Static torque (60 K)	$M_0 (60\text{ K})$	Nm	16.6
Stall current (60 K)	$I_0 (60\text{ K})$	A	9.8
Optimum operating point			
Optimum speed	n_{opt}	rpm	2500
Optimum power	P_{opt}	kW	3.25
Limit data			
Max. permissible speed (mech.)	$n_{max\ mech}$	rpm	6000
Maximum torque	M_{max}	Nm	61
Maximum current	I_{max}	A	41.0
Motor data			
Pole number	2p		8
Torque constant (100 K)	k_T	Nm/A	1.655
Voltage constant (at 20 °C)	k_E	V/1000 rpm	106.5
Winding resistance (at 20 °C)	R_{ph}	Ω	0.284
Rotating field inductance	L_D	mH	5.9
Electrical time constant	T_{el}	ms	21.0
Mechanical time constant	T_{mech}	ms	3.1
Thermal time constant	T_{th}	min	55
Moment of inertia	J_{Mot}	kgm ²	$9.90 \cdot 10^{-3}$
Shaft torsional stiffness	C_t	Nm/rad	82000
Weight without brake	m_{Mot}	kg	23.0
Motor data with integrated brake			
Moment of inertia with brake	$J_{Mot\ Br}$	kgm ²	$1.02 \cdot 10^{-3}$
Shaft torsional stiffness with brake	$C_t\ Br$	Nm/rad	62000
Weight with brake	$m_{Mot\ Br}$	kg	26.0
Recommended Motor Module 6SL312□-□TE21-8AA□			
Rated converter current	$I_{N\ Inv}$	A	18
Maximum converter current	$I_{max\ Inv}$	A	36
Max. torque at $I_{max\ Inv}$	$M_{max\ Inv}$	Nm	55
Maximum permissible speed (converter)	$n_{max\ Inv}$	rpm	5400

The rated data are valid for a 600 V DC link voltage.

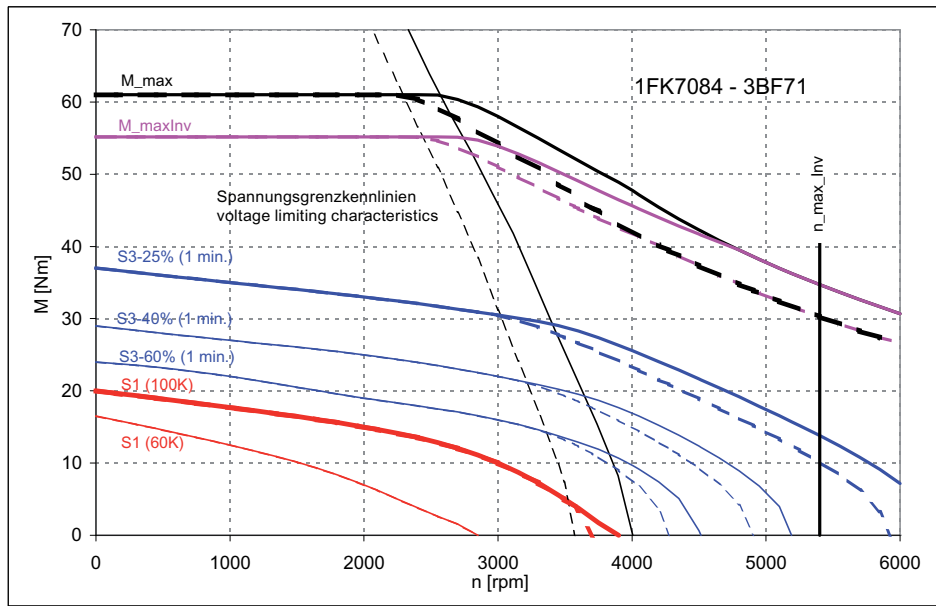

[—————] SINAMICS ALM 400 V-Netz (Zwischenkreisspannung 600 V DC) (DC-link voltage 600 V)

[- - - - -] SINAMICS BLM/SLM 400 V-Netz (Zwischenkreisspannung 540 V DC) (DC-link voltage 540 V)

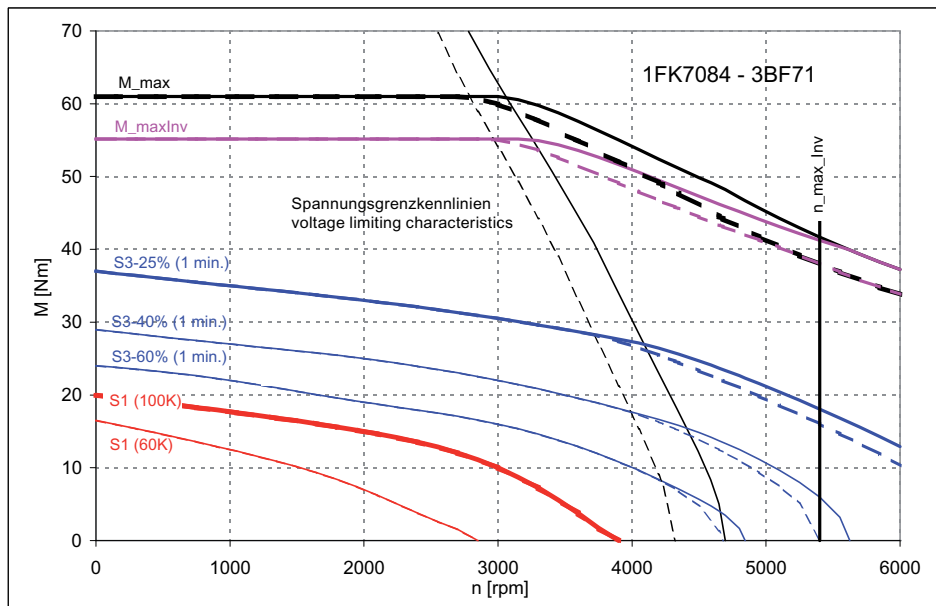

[—————] SINAMICS ALM 480 V-Netz (Zwischenkreisspannung 720 V DC) (DC-link voltage 720 V)

[- - - - -] SINAMICS BLM/SLM 480 V-Netz (Zwischenkreisspannung 650 V DC) (DC-link voltage 650 V)

Figure 4-61 1FK7084-3BF71

4.2 Torque-speed characteristic

4.2.2 1FK7 motors on SINAMICS S110 / S120 POWER MODULE with a line voltage of 1-ph. 200 V to 240 V AC

4.2.2.1 1FK7 Compact and 1FK7 High Dynamic

Table 4- 61 1FK7011 Compact

Technical data	Code	Unit	-5AK21	
Configuration data				
Rated speed	n_N	rpm	6000	
No. of poles	2p		8	
Rated torque (100 K)	M_N (100 K)	Nm	0.08	
Rated current	I_N	A	0.5	
Static torque (60 K)	M_0 (60 K)	Nm	0.15	
Static torque (100 K)	M_0 (100 K)	Nm	0.18	
Stall current (60 K)	I_0 (60 K)	A	0.7	
Stall current (100 K)	I_0 (100 K)	A	0.85	
Moment of inertia (with brake)	J_{MotBr}	10^{-4} kgm ²	0.083	
Moment of inertia (without brake)	J_{Mot}	10^{-4} kgm ²	0.064	
Optimum operating point				
Optimum speed	n_{opt}	rpm	5000	
Optimum power	P_{opt}	kW	0.06	
Limit data				
Max. permissible speed (mech.)	$n_{max\ mech}$	rpm	8000	
Max. permissible speed (converter)	$n_{max\ Inv}$	rpm	8000	
Max. torque	M_{max}	Nm	0.5	
Max. current	I_{max}	A	2.4	
Physical constants				
Torque constant	k_T	Nm/A	0.21	
Voltage constant	k_E	V/1000 rpm	14	
Winding resistance at 20°C	R_{ph}	Ohm	9.4	
Cyclic inductance	L_D	mH	13	
Electrical time constant	T_{el}	ms	1.4	
Mechanical time constant	T_{mech}	ms	4.1	
Thermal time constant	T_{th}	min	14	
Shaft torsional stiffness	C_t	Nm/rad	1400	
Weight with brake	m_{MotBr}	kg	1.0	
Weight without brake	m_{Mot}	kg	0.9	
Recommended Power Module 6SL3210-1SB11-0UA0				
Rated converter current	$I_N\ Inv$	A	0.9	
Max. converter current	$I_{max\ Inv}$	A	1.8	
Max. torque at $I_{max\ Inv}$	$M_{max\ Inv}$	Nm	0.37	

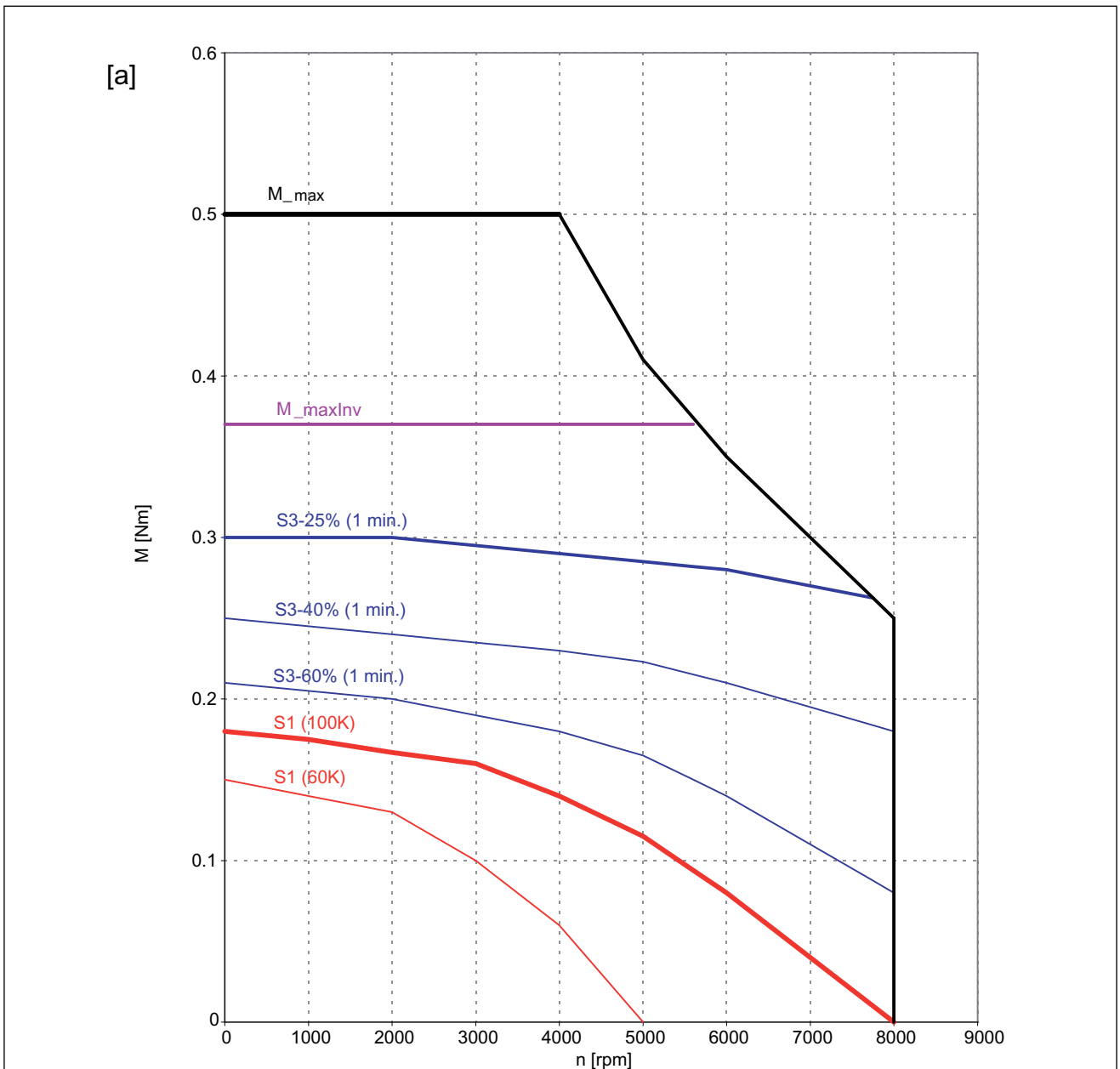

[a] SINAMICS 1AC 230 V

Figure 4-62 1FK7011-5AK21

4.2 Torque-speed characteristic

Table 4- 62 1FK7015 Compact

Technical data	Code	Unit	-5AK21	
Configuration data				
Rated speed	n_N	rpm	6000	
No. of poles	2p		8	
Rated torque (100 K)	M_N (100 K)	Nm	0.16	
Rated current	I_N	A	0.5	
Static torque (60 K)	M_0 (60 K)	Nm	0.29	
Static torque (100 K)	M_0 (100 K)	Nm	0.35	
Stall current (60 K)	I_0 (60 K)	A	0.7	
Stall current (100 K)	I_0 (100 K)	A	0.85	
Moment of inertia (with brake)	J_{MotBr}	10^{-4} kgm ²	0.102	
Moment of inertia (without brake)	J_{Mot}	10^{-4} kgm ²	0.083	
Optimum operating point				
Optimum speed	n_{opt}	rpm	5000	
Optimum power	P_{opt}	kW	0.12	
Limit data				
Max. permissible speed (mech.)	$n_{max\ mech}$	rpm	8000	
Max. permissible speed (converter)	$n_{max\ Inv}$	rpm	8000	
Max. torque	M_{max}	Nm	1	
Max. current	I_{max}	A	2.4	
Physical constants				
Torque constant	k_T	Nm/A	0.42	
Voltage constant	k_E	V/1000 rpm	28	
Winding resistance at 20°C	R_{ph}	Ohm	13.6	
Cyclic inductance	L_D	mH	26	
Electrical time constant	T_{el}	ms	1.9	
Mechanical time constant	T_{mech}	ms	1.9	
Thermal time constant	T_{th}	min	16	
Shaft torsional stiffness	C_t	Nm/rad	1300	
Weight with brake	m_{MotBr}	kg	1.2	
Weight without brake	m_{Mot}	kg	1.2	
Recommended Power Module 6SL3210-1SB11-0UA0				
Rated converter current	$I_N\ Inv$	A	0.9	
Max. converter current	$I_{max\ Inv}$	A	1.8	
Max. torque at $I_{max\ Inv}$	$M_{max\ Inv}$	Nm	0.75	

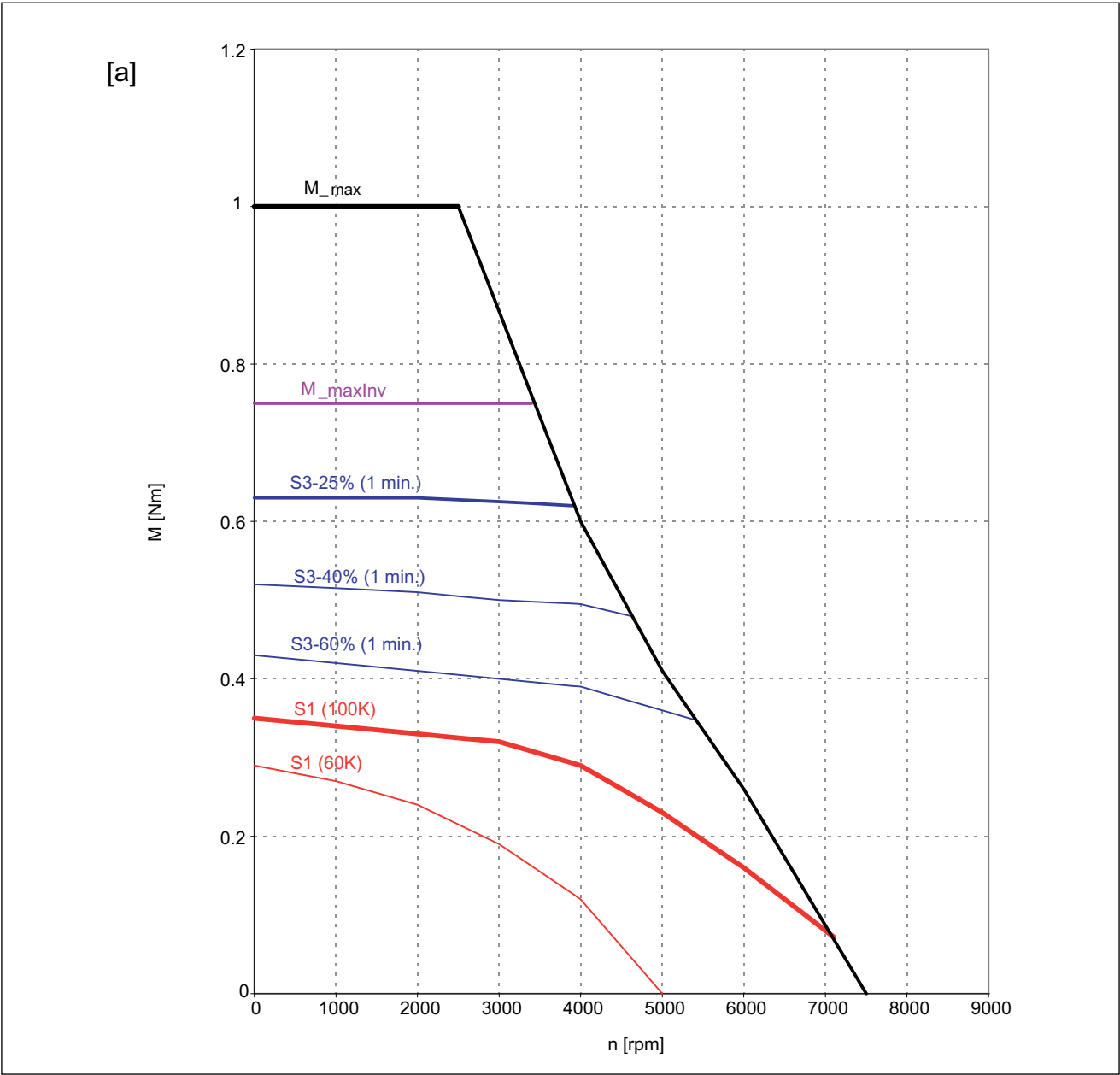

[a] SINAMICS 1AC 230 V

Figure 4-63 1FK7015-5AK21

4.2 Torque-speed characteristic

Table 4- 63 1FK7022 Compact

Technical data	Code	Unit	-5AK21	
Configuration data				
Rated speed	n_N	rpm	6000	
No. of poles	2p		6	
Rated torque (100 K)	M_N (100 K)	Nm	0.6	
Rated current	I_N	A	1.4	
Static torque (60 K)	M_0 (60 K)	Nm	0.7	
Static torque (100 K)	M_0 (100 K)	Nm	0.85	
Stall current (60 K)	I_0 (60 K)	A	1.5	
Stall current (100 K)	I_0 (100 K)	A	1.8	
Moment of inertia (with brake)	J_{MotBr}	10^{-4} kgm ²	0.35	
Moment of inertia (without brake)	J_{Mot}	10^{-4} kgm ²	0.28	
Optimum operating point				
Optimum speed	n_{opt}	rpm	6000	
Optimum power	P_{opt}	kW	0.38	
Limit data				
Max. permissible speed (mech.)	$n_{max\ mech}$	rpm	10000	
Max. permissible speed (converter)	$n_{max\ Inv}$	rpm	9990	
Max. torque	M_{max}	Nm	3.4	
Max. current	I_{max}	A	8.0	
Physical constants				
Torque constant	k_T	Nm/A	0.46	
Voltage constant	k_E	V/1000 rpm	29	
Winding resistance at 20°C	R_{ph}	Ohm	4.2	
Cyclic inductance	L_D	mH	9.1	
Electrical time constant	T_{el}	ms	2.2	
Mechanical time constant	T_{mech}	ms	1.7	
Thermal time constant	T_{th}	min	18	
Shaft torsional stiffness	C_t	Nm/rad	3000	
Weight with brake	m_{MotBr}	kg	2.0	
Weight without brake	m_{Mot}	kg	1.8	
Recommended power module 6SL3210-1SB12-3UA0				
Rated converter current	$I_N\ Inv$	A	2.3	
Max. converter current	$I_{max\ Inv}$	A	4.6	
Max. torque at $I_{max\ Inv}$	$M_{max\ Inv}$	Nm	2.0	

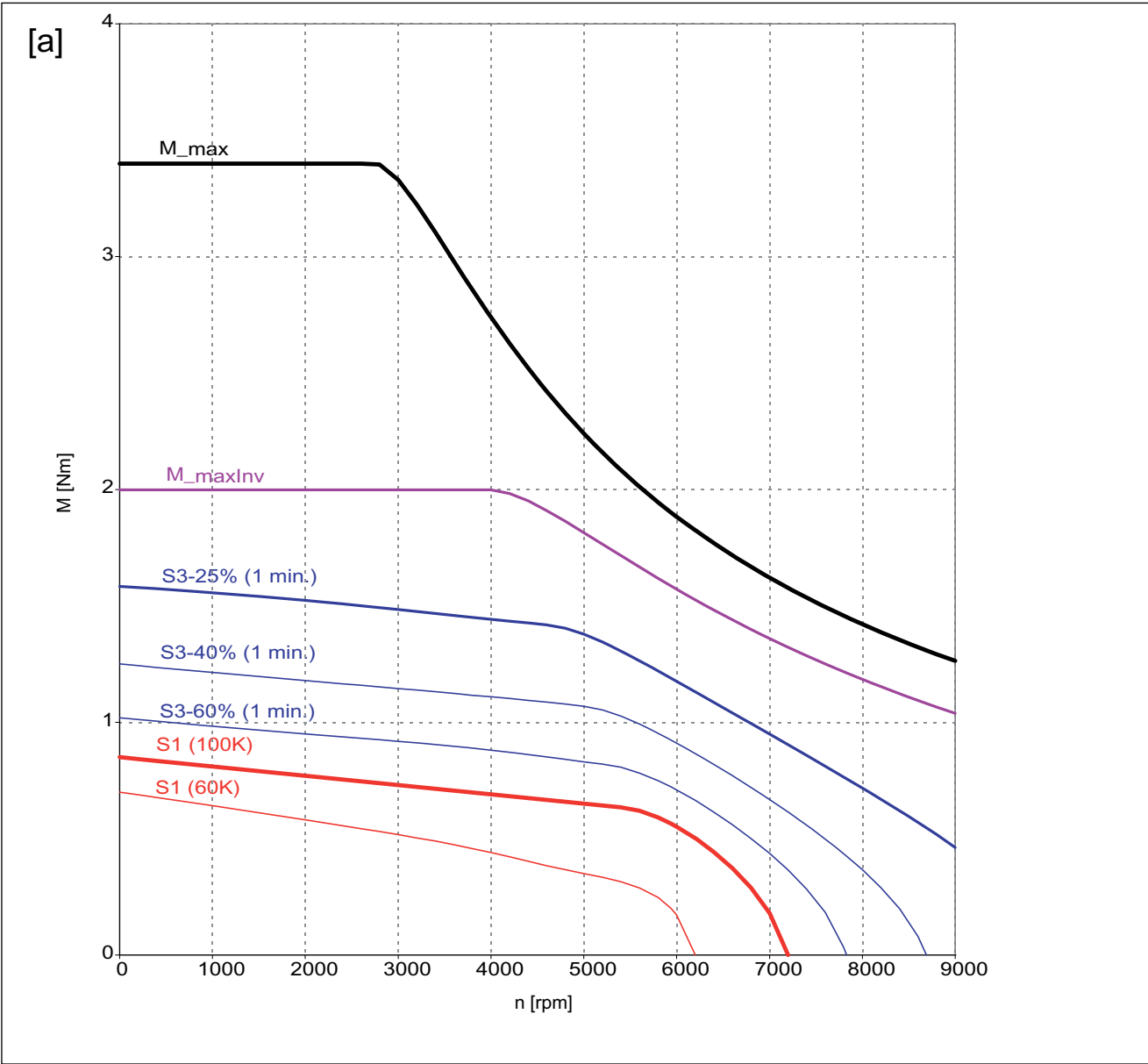

[a] SINAMICS 1AC 230 V
Figure 4-64 1FK7022-5AK21

4.2 Torque-speed characteristic

Table 4- 64 1FK7032 Compact

Technical data	Code	Unit	-2AF21
Configuration data			
Rated speed	n_N	rpm	3000
Rated torque (100 K)	$M_N (100\text{ K})$	Nm	1.0
Rated current (100 K)	$I_N (100\text{ K})$	A	1.6
Static torque (100 K)	$M_0 (100\text{ K})$	Nm	1.15
Stall current (100 K)	$I_0 (100\text{ K})$	A	1.7
Static torque (60 K)	$M_0 (60\text{ K})$	Nm	0.95
Stall current (60 K)	$I_0 (60\text{ K})$	A	1.4
Optimum operating point			
Optimum speed	n_{opt}	rpm	3000
Optimum power	P_{opt}	kW	0.315
Limit data			
Max. permissible speed (mech.)	$n_{max\ mech}$	rpm	10000
Maximum torque	M_{max}	Nm	4.5
Maximum current	I_{max}	A	7.0
Motor data			
Pole number	2p		6
Torque constant (100 K)	k_T	Nm/A	0.67
Voltage constant (at 20 °C)	k_E	V/1000 rpm	45.0
Winding resistance (at 20 °C)	R_{ph}	Ω	5.05
Rotating field inductance	L_D	mH	17.3
Electrical time constant	T_{el}	ms	3.45
Mechanical time constant	T_{mech}	ms	2.2
Thermal time constant	T_{th}	min	25
Moment of inertia	J_{Mot}	kgm ²	0.065·10 ⁻³
Shaft torsional stiffness	C_t	Nm/rad	6000
Weight without brake	m_{Mot}	kg	2.7
Motor data with integrated brake			
Moment of inertia with brake	$J_{Mot\ Br}$	kgm ²	0.075·10 ⁻³
Shaft torsional stiffness with brake	$C_t\ Br$	Nm/rad	4100
Weight with brake	$m_{Mot\ Br}$	kg	3.1
Recommended Motor Module 6SL312□-□TE13-0AA□			
Rated converter current	$I_{N\ Inv}$	A	2.3
Maximum converter current	$I_{max\ Inv}$	A	4.6
Max. torque at $I_{max\ Inv}$	$M_{max\ Inv}$	Nm	3.0
Maximum permissible speed (converter)	$n_{max\ Inv}$	rpm	6400

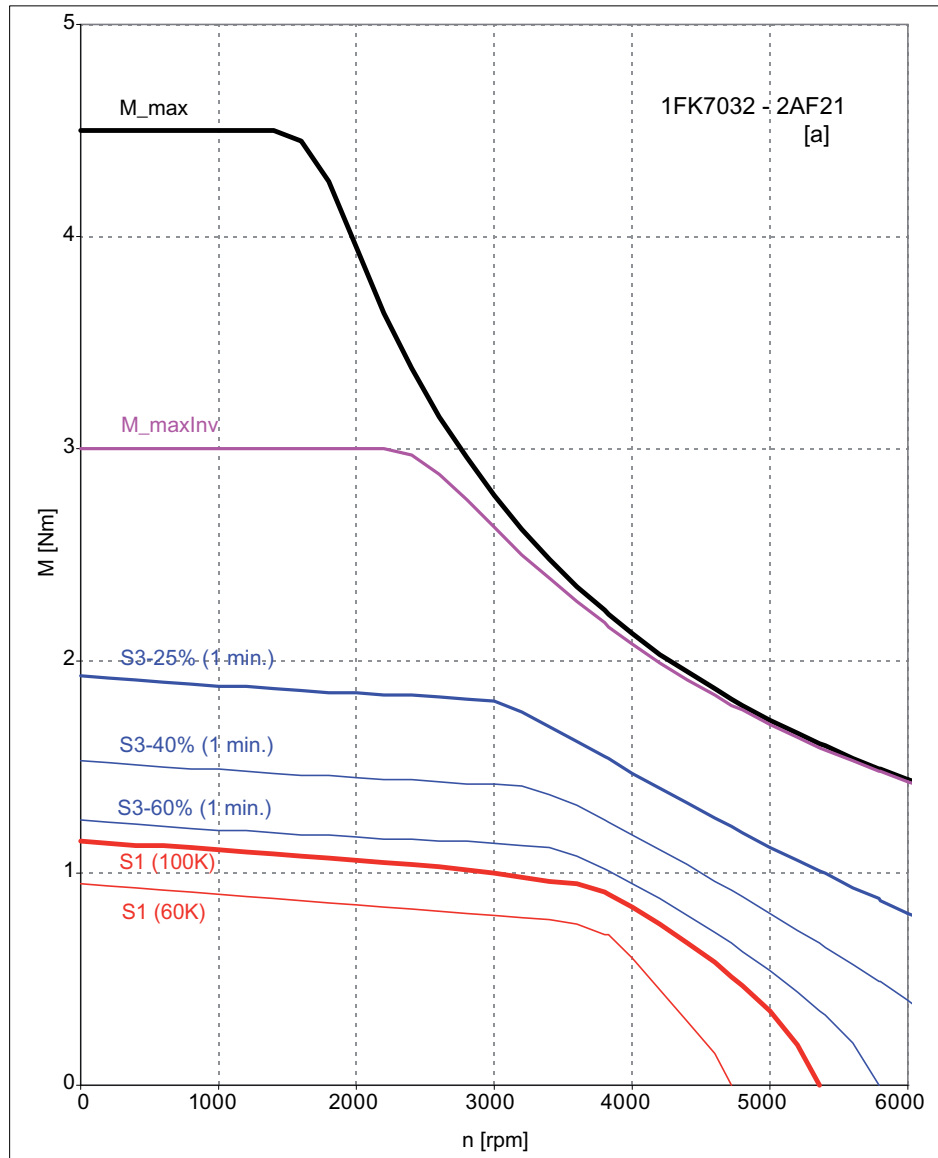

[a] SINAMICS 1 AC 230 V

Figure 4-65 1FK7032-2AF21

4.2 Torque-speed characteristic

Table 4- 65 1FK7034 Compact

Technical data	Code	Unit	-2AF21
Configuration data			
Rated speed	n_N	rpm	3000
Rated torque (100 K)	$M_N (100\text{ K})$	Nm	1.45
Rated current (100 K)	$I_N (100\text{ K})$	A	1.8
Static torque (100 K)	$M_0 (100\text{ K})$	Nm	1.6
Stall current (100 K)	$I_0 (100\text{ K})$	A	1.9
Static torque (60 K)	$M_0 (60\text{ K})$	Nm	1.35
Stall current (60 K)	$I_0 (60\text{ K})$	A	1.55
Optimum operating point			
Optimum speed	n_{opt}	rpm	3000
Optimum power	P_{opt}	kW	0.455
Limit data			
Max. permissible speed (mech.)	$n_{max\ mech}$	rpm	10000
Maximum torque	M_{max}	Nm	6.5
Maximum current	I_{max}	A	8
Motor data			
Pole number	2p		6
Torque constant (100 K)	k_T	Nm/A	0.84
Voltage constant (at 20 °C)	k_E	V/1000 rpm	55.0
Winding resistance (at 20 °C)	R_{ph}	Ω	4.46
Rotating field inductance	L_D	mH	17.2
Electrical time constant	T_{el}	ms	3.85
Mechanical time constant	T_{mech}	ms	1.71
Thermal time constant	T_{th}	min	30
Moment of inertia	J_{Mot}	kgm ²	$0.09 \cdot 10^{-3}$
Shaft torsional stiffness	C_t	Nm/rad	5300
Weight without brake	m_{Mot}	kg	3.5
Motor data with integrated brake			
Moment of inertia with brake	$J_{Mot\ Br}$	kgm ²	$0.10 \cdot 10^{-3}$
Shaft torsional stiffness with brake	$C_t\ Br$	Nm/rad	3750
Weight with brake	$m_{Mot\ Br}$	kg	3.9
Recommended Motor Module 6SL312□-□TE13-0AA□			
Rated converter current	$I_{N\ Inv}$	A	2.3
Maximum converter current	$I_{max\ Inv}$	A	4.6
Max. torque at $I_{max\ Inv}$	$M_{max\ Inv}$	Nm	3.9
Maximum permissible speed (converter)	$n_{max\ Inv}$	rpm	5200

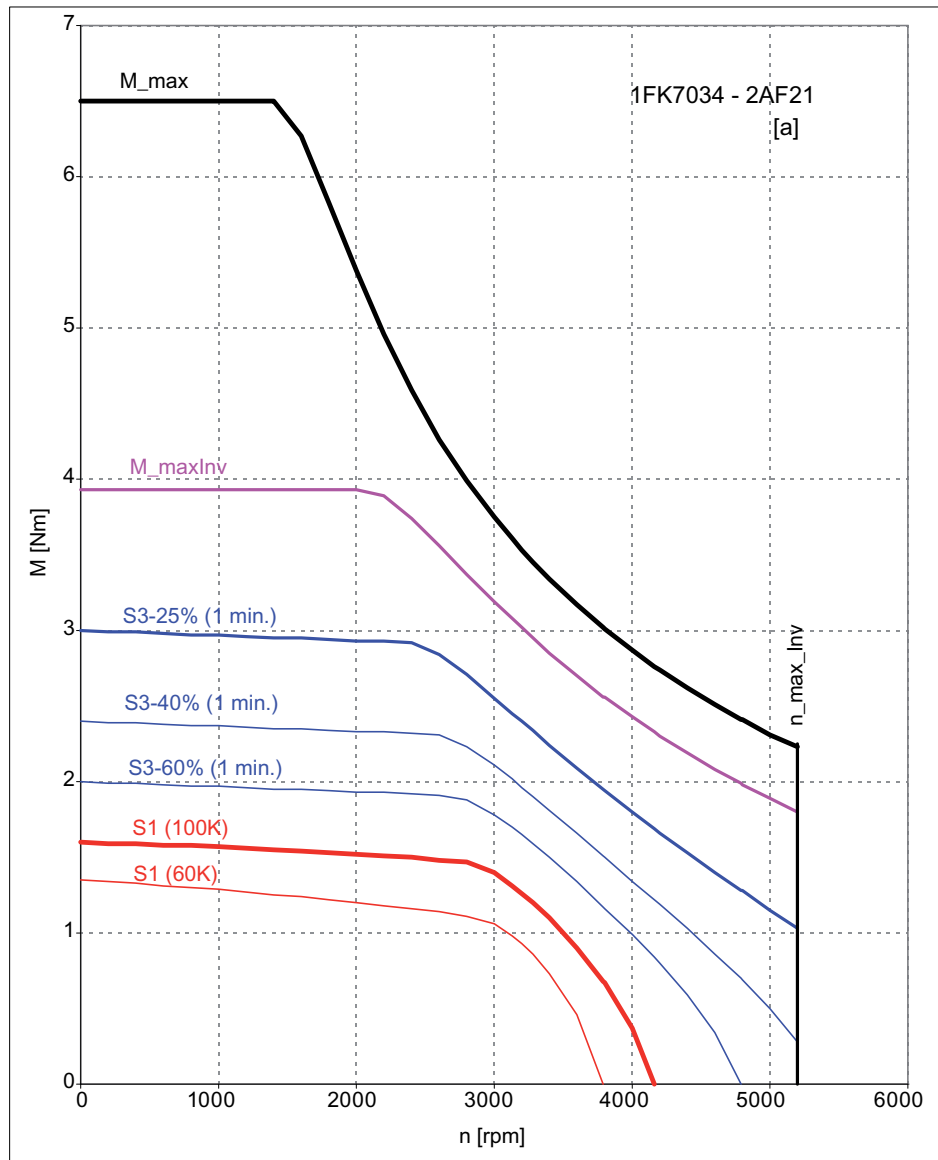

[a] SINAMICS 1 AC 230 V

Figure 4-66 1FK7034-2AF21

4.2 Torque-speed characteristic

Table 4- 66 1FK7042 Compact

Technical data	Code	Unit	-2AF21
Configuration data			
Rated speed	n_N	rpm	3000
Rated torque (100 K)	$M_N (100\text{ K})$	Nm	2.6
Rated current (100 K)	$I_N (100\text{ K})$	A	3.5
Static torque (100 K)	$M_0 (100\text{ K})$	Nm	3.0
Stall current (100 K)	$I_0 (100\text{ K})$	A	3.95
Static torque (60 K)	$M_0 (60\text{ K})$	Nm	2.5
Stall current (60 K)	$I_0 (60\text{ K})$	A	3.2
Optimum operating point			
Optimum speed	n_{opt}	rpm	3000
Optimum power	P_{opt}	kW	0.82
Limit data			
Max. permissible speed (mech.)	$n_{max\ mech}$	rpm	9000
Maximum torque	M_{max}	Nm	10.5
Maximum current	I_{max}	A	13.8
Motor data			
Pole number	2p		8
Torque constant (100 K)	k_T	Nm/A	0.76
Voltage constant (at 20 °C)	k_E	V/1000 rpm	49.6
Winding resistance (at 20 °C)	R_{ph}	Ω	1.435
Rotating field inductance	L_D	mH	10.6
Electrical time constant	T_{el}	ms	7.4
Mechanical time constant	T_{mech}	ms	2.15
Thermal time constant	T_{th}	min	30
Moment of inertia	J_{Mot}	kgm ²	$0.29 \cdot 10^{-3}$
Shaft torsional stiffness	C_t	Nm/rad	15500
Weight without brake	m_{Mot}	kg	4.6
Motor data with integrated brake			
Moment of inertia with brake	$J_{Mot\ Br}$	kgm ²	$0.32 \cdot 10^{-3}$
Shaft torsional stiffness with brake	$C_t\ Br$	Nm/rad	11400
Weight with brake	$m_{Mot\ Br}$	kg	5.3
Recommended Motor Module 6SL312□-□TE13-0AA□			
Rated converter current	$I_{N\ Inv}$	A	3.9
Maximum converter current	$I_{max\ Inv}$	A	7.8
Max. torque at $I_{max\ Inv}$	$M_{max\ Inv}$	Nm	6.0
Maximum permissible speed (converter)	$n_{max\ Inv}$	rpm	5800

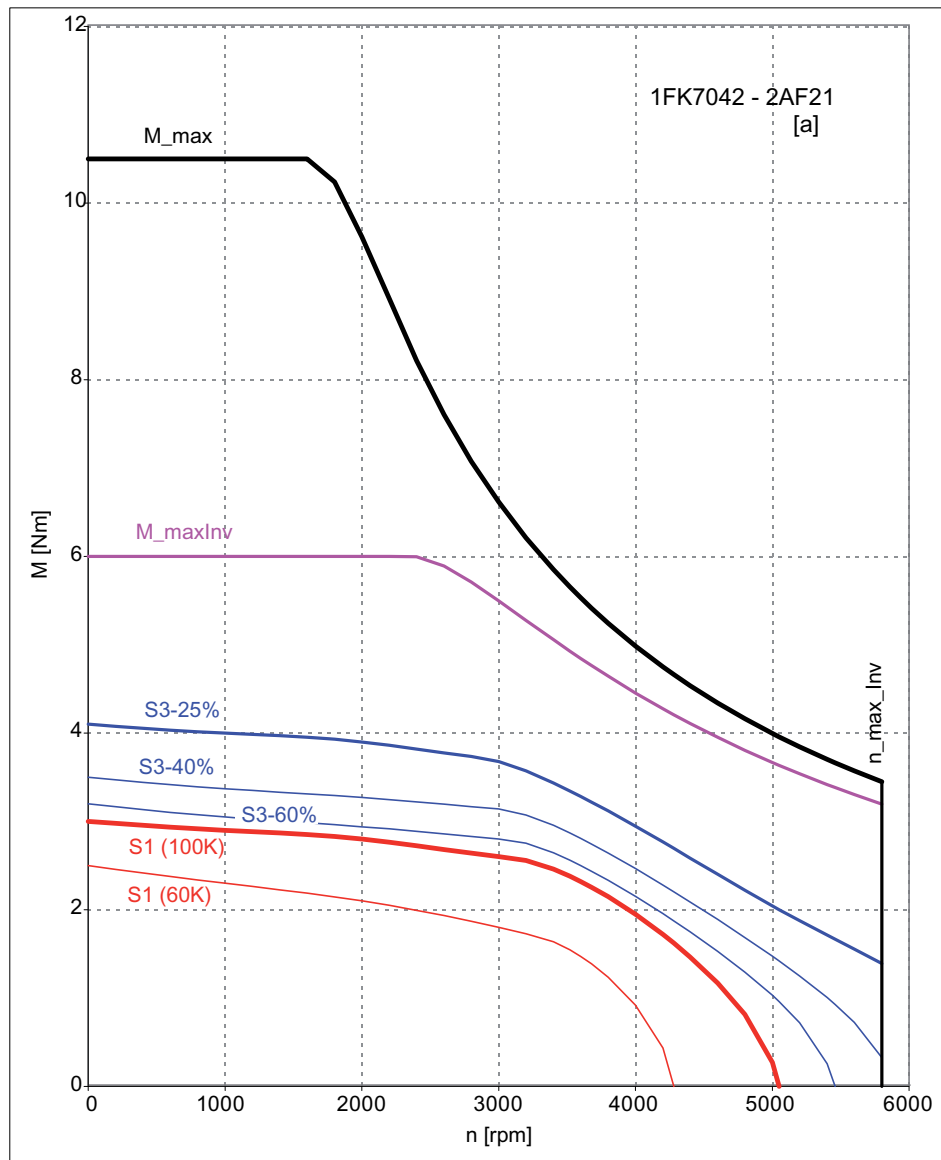

[a] SINAMICS 1 AC 230 V

Figure 4-67 1FK7042-2AF21

4.2 Torque-speed characteristic

Table 4- 67 1FK7033 High Dynamic

Technical data	Code	Unit	-4CF21
Configuration data			
Rated speed	n_N	rpm	3000
Rated torque (100 K)	$M_N (100\text{ K})$	Nm	1.2
Rated current (100 K)	$I_N (100\text{ K})$	A	2.05
Static torque (100 K)	$M_0 (100\text{ K})$	Nm	1.3
Stall current (100 K)	$I_0 (100\text{ K})$	A	2.1
Static torque (60 K)	$M_0 (60\text{ K})$	Nm	1.08
Stall current (60 K)	$I_0 (60\text{ K})$	A	1.7
Optimum operating point			
Optimum speed	n_{opt}	rpm	3000
Optimum power	P_{opt}	kW	0.375
Limit data			
Max. permissible speed (mech.)	$n_{max\ mech}$	rpm	10000
Maximum torque	M_{max}	Nm	4.3
Maximum current	I_{max}	A	7.6
Motor data			
Pole number	2p		6
Torque constant (100 K)	k_T	Nm/A	0.62
Voltage constant (at 20 °C)	k_E	V/1000 rpm	39.5
Winding resistance (at 20 °C)	R_{ph}	Ω	3.51
Rotating field inductance	L_D	mH	22.0
Electrical time constant	T_{el}	ms	6.3
Mechanical time constant	T_{mech}	ms	0.68
Thermal time constant	T_{th}	min	25
Moment of inertia	J_{Mot}	kgm ²	0.025·10 ⁻³
Shaft torsional stiffness	C_t	Nm/rad	7300
Weight without brake	m_{Mot}	kg	3.0
Motor data with integrated brake			
Moment of inertia with brake	$J_{Mot\ Br}$	kgm ²	0.035·10 ⁻³
Shaft torsional stiffness with brake	$C_t\ Br$	Nm/rad	4700
Weight with brake	$m_{Mot\ Br}$	kg	3.4
Recommended Motor Module 6SL321□-□SB12-3UA□			
Rated converter current	$I_{N\ Inv}$	A	2.3
Maximum converter current	$I_{max\ Inv}$	A	4.6
Max. torque at $I_{max\ Inv}$	$M_{max\ Inv}$	Nm	2.7
Maximum permissible speed (converter)	$n_{max\ Inv}$	rpm	7150

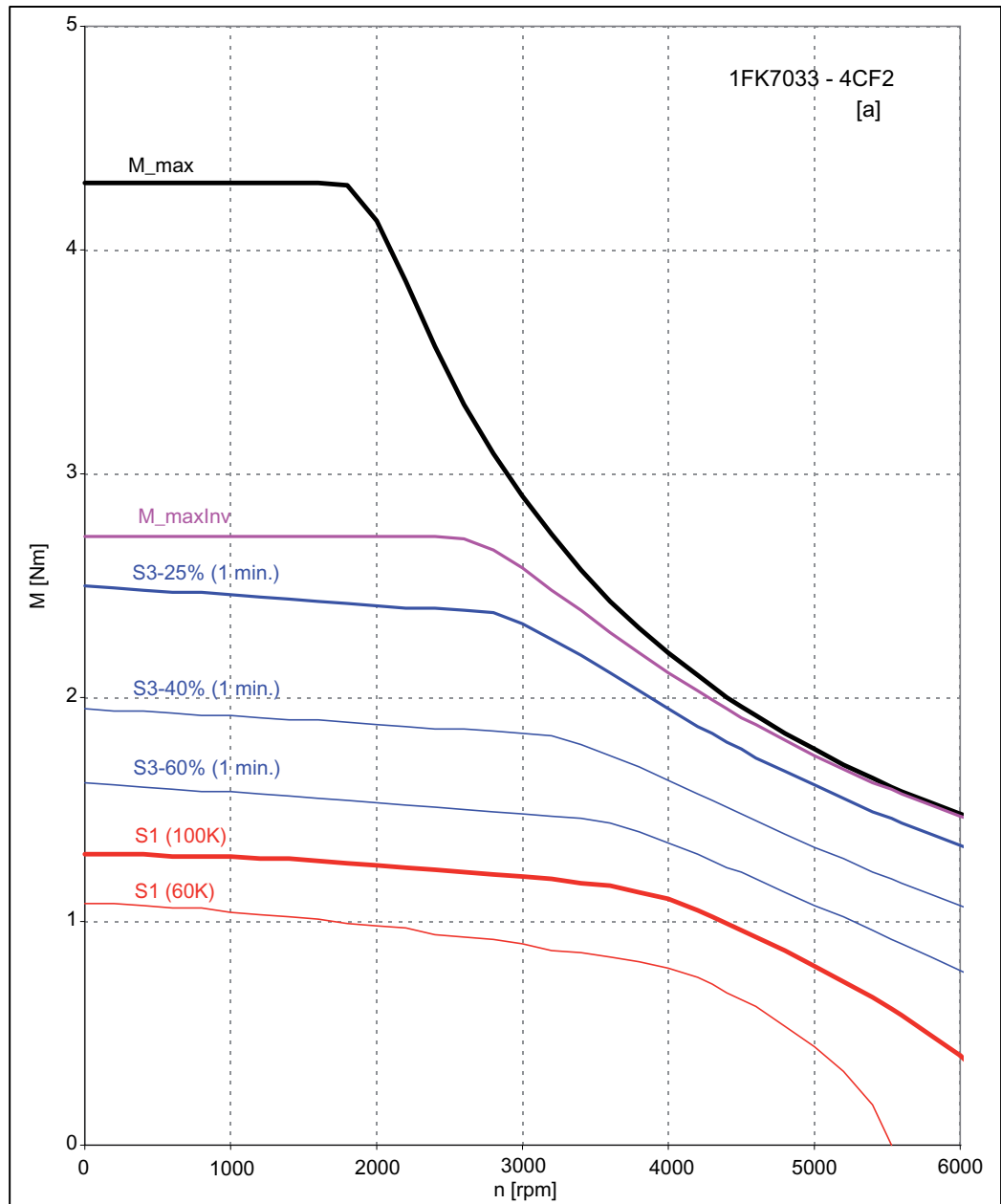

[a] SINAMICS 1 AC 230 V

Figure 4-68 1FK7033_4CF21

4.2 Torque-speed characteristic

Table 4- 68 1FK7043 High Dynamic

Technical data	Code	Unit	-4CF21
Configuration data			
Rated speed	n_N	rpm	3000
Rated torque (100 K)	$M_N (100\text{ K})$	Nm	3.0
Rated current (100 K)	$I_N (100\text{ K})$	A	3.7
Static torque (100 K)	$M_0 (100\text{ K})$	Nm	3.3
Stall current (100 K)	$I_0 (100\text{ K})$	A	3.9
Static torque (60 K)	$M_0 (60\text{ K})$	Nm	2.9
Stall current (60 K)	$I_0 (60\text{ K})$	A	3.3
Optimum operating point			
Optimum speed	n_{opt}	rpm	3000
Optimum power	P_{opt}	kW	0.94
Limit data			
Max. permissible speed (mech.)	$n_{max\ mech}$	rpm	9000
Maximum torque	M_{max}	Nm	10.0
Maximum current	I_{max}	A	12.5
Motor data			
Pole number	2p		6
Torque constant (100 K)	k_T	Nm/A	0.845
Voltage constant (at 20 °C)	k_E	V/1000 rpm	54.0
Winding resistance (at 20 °C)	R_{ph}	Ω	1.2
Rotating field inductance	L_D	mH	13.6
Electrical time constant	T_{el}	ms	11.3
Mechanical time constant	T_{mech}	ms	0.5
Thermal time constant	T_{th}	min	40
Moment of inertia	J_{Mot}	kgm ²	$0.1 \cdot 10^{-3}$
Shaft torsional stiffness	C_t	Nm/rad	11400
Weight without brake	m_{Mot}	kg	6.0
Motor data with integrated brake			
Moment of inertia with brake	$J_{Mot\ Br}$	kgm ²	$0.136 \cdot 10^{-3}$
Shaft torsional stiffness with brake	$C_t\ Br$	Nm/rad	9000
Weight with brake	$m_{Mot\ Br}$	kg	6.6
Recommended Motor Module 6SL321□-□SB13-9UA□			
Rated converter current	$I_{N\ Inv}$	A	3.9
Maximum converter current	$I_{max\ Inv}$	A	7.8
Max. torque at $I_{max\ Inv}$	$M_{max\ Inv}$	Nm	6.6
Maximum permissible speed (converter)	$n_{max\ Inv}$	rpm	5350

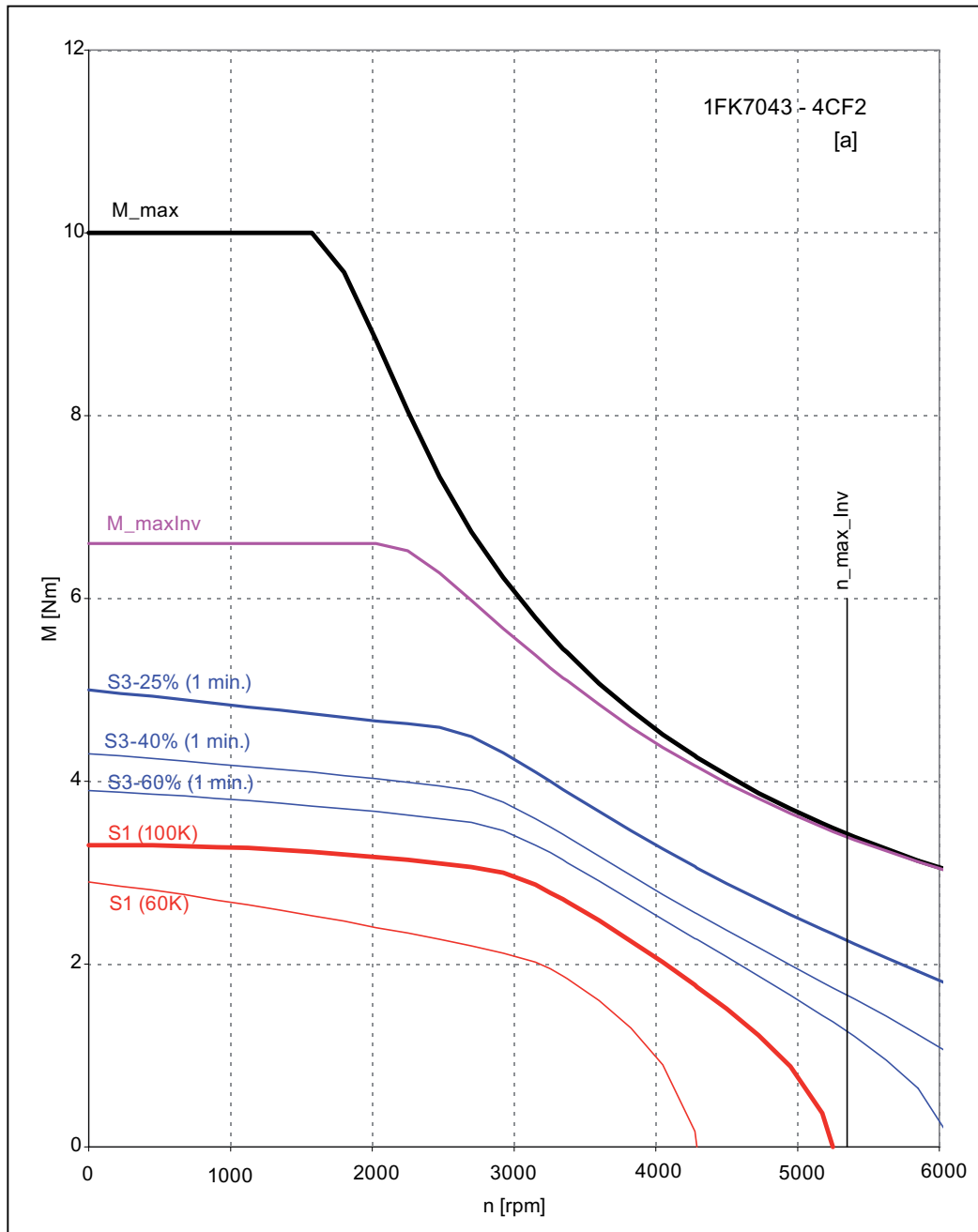

[a] SINAMICS 1 AC 230 V

Figure 4-69 1FK7043_4CF21

4.3 Dimension drawings

CAD CREATOR

Thanks to its easy to understand interface, the CAD CREATOR allows you to find the following quickly

- dimension drawings
- 2D/3D CAD data

and supports you when generating plant/system documentation regarding project-specific information. The data for motors, drives and CNC controls is currently available in the online version.

You can find further information on the Internet at: <http://www.siemens.com/cadcreator>

Motors

- 1FK7, 1FT7, 1FT6 synchronous motors
- 1FE1 built-in synchronous motors
- 1FW3 complete torque motors
- 1FW6 built-in torque motors
- 1FK7, 1FT7, 1FT6 geared motors
- 1PH8 synchronous/induction motors
- 1PH7, 1PH4, 1PL6, 1PM4, 1PM6 induction motors
- 2SP1 motor spindles
- 1FN3 linear motors

SINAMICS S120

- Control Units
- Power Modules (blocksize, chassis)
- Line Modules (booksize, chassis)
- Line-side components
- Motor Modules (booksize, chassis)
- DC link components
- Additional system components
- Load-side power components
- Encoder system connection
- MOTION-CONNECT connection system

SIMOTION

- SIMOTION D
- SIMOTION C

SINUMERIK solution line

- Control systems
- Operator components for CNC controls

How up-to-date are the dimension drawings

Note

Siemens AG reserves the right to change the dimensions of the motors as part of mechanical design improvements without prior notice. This means that dimensions drawings can go out-of-date. Up-to-date dimension drawings can be requested at no charge from your local SIEMENS representative.

4.3 Dimension drawings

4.3.1 1FK7 motors

For motor		Dimensions in mm (inches)										Shaft extension DE				
Shaft height	Type	DIN IEC	b ₁ N	c ₁ LA	e ₁ M	f AB	f ₁ T	g ₂ -	i ₂ -	s ₂ S	d D	d ₆ -	l E	t GA	u F	
1FK7 Compact																
20	1FK701		30 (1.18)	7 (0.28)	46 (1.81)	40 (1.57)	2,5 (0.10)	66 (2.60)	18 (0.71)	4,5 (0.18)	8 (0.31)	-	18 (0.71)	8,8 (0.35)	2 (0.08)	
28	1FK702		40 (1.57)	10 (0.39)	63 (2.48)	55 (2.17)	2,5 (0.10)	75 (2.95)	20 (0.79)	5,4 (0.21)	9 (0.35)	M3	20 (0.79)	10,2 (0.40)	3 (0.12)	

Shaft height	Type	Encoder systems: Resolver Absolute encoder AM16S/R / AM15DQ						Encoder systems: Incremental encoder IC2048S/R / IC22DQ Absolute encoder AM2048S/R / AM22DQ AM512S/R / AM20DQ AM32S/R / AM16DQ						
		without holding brake			with holding brake			without holding brake			with holding brake			
		k LB	o ₁ -	o ₂ -	k LB	o ₁ -	o ₂ -	k LB	o ₁ -	o ₂ -	k LB	o ₁ -	o ₂ -	
1FK7 Compact														
20	1FK7011	140 (5.51)	89 (3.50)	118 (4.65)	140 (5.51)	89 (3.50)	118 (4.65)	155 (6.10)	89 (3.50)	118 (4.65)	155 (6.10)	89 (3.50)	118 (4.65)	
	1FK7015	165 (6.50)	114 (4.49)	143 (5.63)	165 (6.50)	114 (4.49)	143 (5.63)	180 (7.09)	114 (4.49)	143 (5.63)	180 (7.09)	114 (4.49)	143 (5.63)	
28	1FK7022	153 (6.02)	95 (3.74)	128 (5.04)	175 (6.89)	95 (3.74)	150 (5.91)	178 (7.01)	95 (3.74)	128 (5.04)	200 (7.87)	95 (3.74)	150 (5.91)	

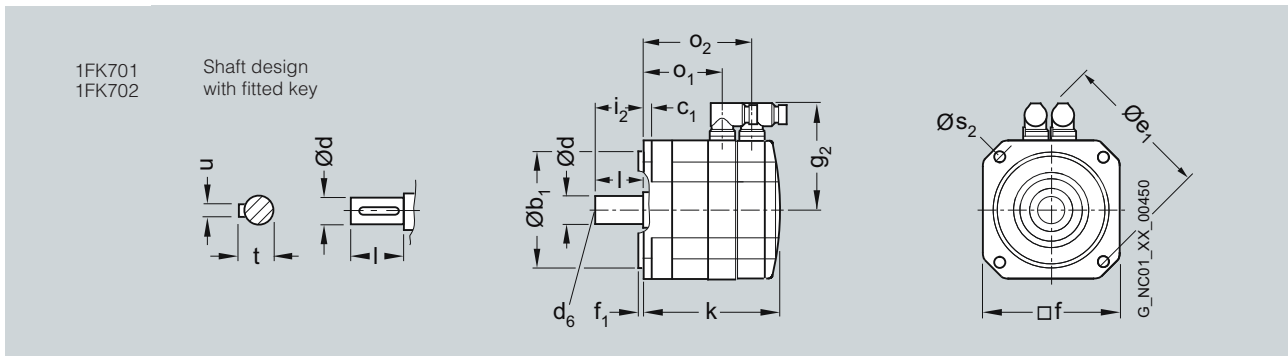

Shaft height	Type	DQI-Encoder with DRIVE-CLiQ interface (without resolver)								Encoder systems without DRIVE-CLiQ interface (without resolver)							
		without brake				with brake				without brake				with brake			
		g ₁	g ₂	o ₂	k LB	o ₁	k LB	o ₁	g ₁	g ₂	o ₂	k LB	o ₁	k LB	o ₁		
1FK7 Compact																	
36	1FK7032-2A	104,5 (4.11)	78 (3.07)	50 (1.97)	173 (6.81)	111 (4.37)	200 (7.87)	138 (5.43)	78 (3.07)	78 (3.07)	47 (1.85)	173 (6.81)	111 (4.37)	200 (7.87)	138 (5.43)		
	1FK7034-2A				198 (7.80)	136 (5.35)	225 (8.86)	163 (6.42)				198 (7.80)	136 (5.35)	225 (8.86)	163 (6.42)		
48	1FK7040-2A	104,5 (4.11)	90 (3.54)	50 (1.97)	147 (5.79)	85 (3.35)	179 (7.05)	117 (4.61)	94 (3.70)	90 (3.54)	52 (2.05)	152 (5.98)	85 (3.35)	184 (7.24)	117 (4.61)		
	1FK7042-2A				174 (6.85)	112 (4.41)	206 (8.11)	144 (5.67)				179 (7.05)	112 (4.41)	211 (8.31)	144 (5.67)		
63	1FK7060-2A	104,5 (4.11)	104 (4.09)	50 (1.97)	168 (6.61)	106 (4.17)	203 (7.99)	141 (5.55)	102 (4.02)	104 (4.09)	52 (2.05)	173 (6.81)	106 (4.17)	208 (8.19)	141 (5.55)		
	1FK7062-2A				190 (7.48)	128 (5.04)	226 (8.90)	163 (6.42)				195 (7.68)	128 (5.04)	231 (9.09)	163 (6.42)		
	1FK7063-2A				213 (8.39)	151 (5.94)	248 (9.76)	186 (7.32)				218 (8.58)	151 (5.94)	253 (9.96)	186 (7.32)		
80	1FK7080-2A	104,5 (4.11)	119 (4.69)	48 (1.89)	171 (6.73)	111 (4.37)	223 (8.78)	163 (6.42)	94 (3.70)	119 (4.69)	50 (1.97)	176 (6.93)	111 (4.37)	228 (8.98)	163 (6.42)		
	1FK7081-2A				190 (7.48)	130 (5.12)	242 (9.53)	182 (7.17)				195 (7.68)	130 (5.12)	247 (9.72)	182 (7.17)		
	1FK7083-2A				209 (8.23)	149 (5.87)	261 (10.28)	201 (7.91)				214 (8.43)	149 (5.87)	266 (10.47)	201 (7.91)		
	1FK7084-2A				229 (9.02)	168 (6.61)	281 (11.06)	221 (8.70)				234 (9.21)	168 (6.61)	286 (11.26)	221 (8.70)		
100	1FK7100-2A	104,5 (4.11)	137 (5.39)	53 (2.09)	183 (7.20)	118 (4.65)	220 (8.66)	170 (6.69)	94 (3.70)	137 (5.39)	55 (2.17)	188 (7.40)	118 (4.65)	225 (8.86)	170 (6.69)		
	1FK7101-2A		158 (6.22)		209 (8.23)	144 (5.67)	261 (10.28)	196 (7.72)		158 (6.22)		214 (8.43)	144 (5.67)	266 (10.47)	196 (7.72)		
	1FK7103-2A				235 (9.25)	170 (6.69)	287 (11.30)	222 (8.74)				240 (9.45)	170 (6.69)	292 (11.50)	222 (8.74)		
	1FK7105-2A				287 (11.30)	222 (8.74)	339 (13.35)	274 (10.79)				292 (11.50)	222 (8.74)	344 (13.54)	274 (10.79)		
1FK7 High Inertia																	
48	1FK7042-3B	104,5 (4.11)	90 (3.54)	50 (1.97)	187 (7.36)	125 (4.92)	219 (8.62)	157 (6.18)	94 (3.70)	90 (3.54)	52 (2.05)	192 (7.56)	125 (4.92)	224 (8.82)	157 (6.18)		
63	1FK7060-3B	104,5 (4.11)	104 (4.09)	50 (1.97)	182 (7.17)	120 (4.72)	217 (8.54)	155 (6.10)	102 (4.02)	104 (4.09)	52 (2.05)	187 (7.36)	120 (4.72)	222 (8.74)	155 (6.10)		
	1FK7062-3B				216 (8.50)	153 (6.02)	251 (9.88)	189 (7.44)				221 (8.70)	153 (6.02)	256 (10.08)	189 (7.44)		
80	1FK7081-3B	104,5 (4.11)	119 (4.69)	48 (1.89)	211 (8.31)	151 (5.94)	264 (10.39)	203 (7.99)	94 (3.70)	119 (4.69)	50 (1.97)	216 (8.50)	151 (5.94)	269 (10.59)	203 (7.99)		
	1FK7084-3B				270 (10.63)	209 (8.23)	322 (12.68)	262 (10.31)				275 (10.83)	209 (8.23)	327 (12.87)	262 (10.31)		
1FK7 High Dynamic																	
36	1FK7033-4C	104,5 (4.11)	78 (3.07)	50 (1.97)	183 (7.20)	121 (4.76)	210 (8.27)	148 (5.83)	78 (3.07)	78 (3.07)	47 (1.85)	183 (7.20)	121 (4.76)	210 (8.27)	148 (5.83)		
48	1FK7043-4C	104,5 (4.11)	90 (3.54)	56 (2.20)	200 (7.87)	132 (5.20)	232 (9.13)	164 (6.46)	94 (3.70)	90 (3.54)	58 (2.28)	205 (8.07)	132 (5.20)	237 (9.33)	164 (6.46)		
	1FK7044-4C				225 (8.86)	157 (6.18)	257 (10.12)	189 (7.44)				230 (9.06)	157 (6.18)	262 (10.31)	189 (7.44)		
63	1FK7061-4C	104,5 (4.11)	104 (4.09)	50 (1.97)	203 (7.99)	141 (5.55)	238 (9.37)	176 (6.93)	102 (4.02)	104 (4.09)	52 (2.05)	208 (8.19)	141 (5.55)	243 (9.57)	176 (6.93)		
	1FK7064-4C				267 (10.51)	205 (8.07)	302 (11.89)	240 (9.45)				272 (10.71)	205 (8.07)	307 (12.09)	240 (9.45)		
80	1FK708.-4CC	104,5 (4.11)	119 (4.69)	48 (1.89)	257 (10.12)	197 (7.76)	309 (12.17)	249 (9.80)	94 (3.70)	119 (4.69)	50 (1.97)	262 (10.31)	197 (7.76)	314 (12.36)	249 (9.80)		
	1FK708.-4CF		139 (5.47)									139 (5.47)					

4.3 Dimension drawings

For motor		Dimensions in mm (inches)										Shaft extension DE				
Shaft height	Type	DIN IEC	a ₁ P	b ₁ N	c ₁ LA	e ₁ M	f AB	f ₁ T	i ₂ -	s ₂ S	d D	d ₆ -	l E	t GA	u F	
1FK7 Compact/High Dynamic/High Inertia																
36	1FK703		90 (3.54)	60 (2.36)	8 (0.31)	75 (2.95)	72 (2.83)	3 (0.12)	30 (1.18)	6,5 (0.26)	14 (0.55)	M5	30 (1.18)	16 (0.63)	5 (0.20)	
48	1FK704		120 (4.72)	80 (3.15)	10 (0.39)	100 (3.94)	96 (3.78)	3 (0.12)	40 (1.57)	6,5 (0.26)	19 (0.75)	M6	40 (1.57)	21,5 (0.85)	6 (0.24)	
63	1FK706		155 (6.10)	110 (4.33)	10 (0.39)	130 (5.12)	126 (4.96)	3,5 (0.14)	50 (1.97)	9 (0.35)	24 (0.94)	M8	50 (1.97)	27 (1.06)	8 (0.31)	
80	1FK708		194 (7.64)	130 (5.12)	11,5 (0.45)	165 (6.50)	155 (6.10)	3,5 (0.14)	58 (2.28)	11 (0.43)	32 (1.26)	M12	58 (2.28)	35 (1.38)	10 (0.39)	
100	1FK710		245 (9.65)	180 (7.09)	13 (0.51)	215 (8.46)	192 (7.56)	4 (0.16)	80 (3.15)	14 (0.55)	38 (1.50)	M12	80 (3.15)	41 (1.61)	10 (0.39)	

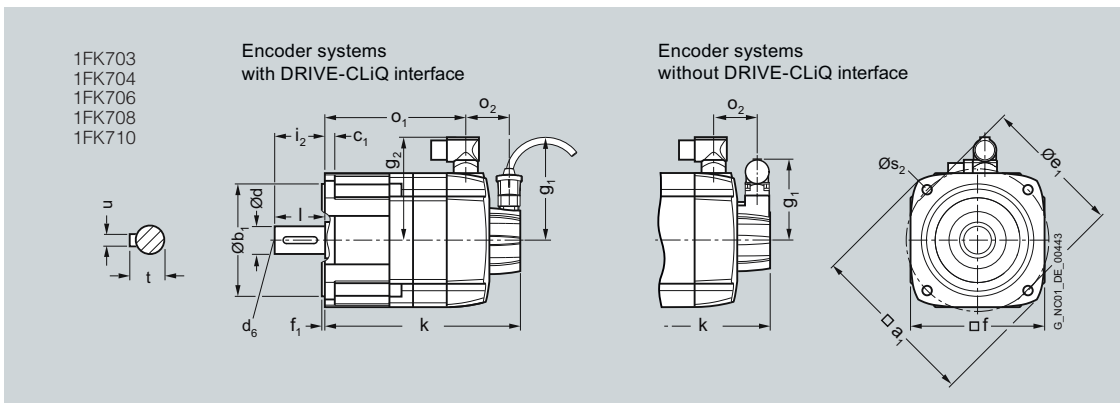

Shaft height	Type	Resolver with/without DRIVE-CLiQ interface						
		g ₁	g ₂	o ₂	without brake		with brake	
					k LB	o ₁	k LB	o ₁
1FK7 Compact								
36	1FK7032-2A	80 (3.15)	80 (3.15)	15 (0.59)	153 (6.02)	117 (4.61)	180 (7.09)	144 (5.67)
	1FK7034-2A				178 (7.01)	142 (5.59)	205 (8.07)	169 (6.65)
48	1FK7040-2A	90 (3.54)	90 (3.54)	23 (0.91)	132 (5.20)	85 (3.35)	164 (6.46)	117 (4.61)
	1FK7042-2A				160 (6.30)	112 (4.41)	192 (7.56)	144 (5.67)
63	1FK7060-2A	103 (4.06)	104 (4.09)	23 (0.91)	153 (6.02)	106 (4.17)	189 (7.44)	141 (5.55)
	1FK7062-2A				176 (6.93)	128 (5.04)	211 (8.31)	163 (6.42)
	1FK7063-2A				198 (7.80)	151 (5.94)	234 (9.21)	186 (7.32)
80	1FK7080-2A	118 (4.65)	119 (4.69)	21 (0.83)	157 (6.18)	111 (4.37)	209 (8.23)	163 (6.42)
	1FK7081-2A				176 (6.93)	130 (5.12)	228 (8.98)	182 (7.17)
	1FK7083-2A				195 (7.68)	149 (5.87)	247 (9.72)	201 (7.91)
	1FK7084-2A				214 (8.43)	168 (6.61)	266 (10.47)	221 (8.70)
100	1FK7100-2A	136 (5.35)	137 (5.39)	26 (1.02)	169 (6.65)	118 (4.65)	206 (8.11)	155 (6.10)
	1FK7101-2A				195 (7.68)	144 (5.67)	247 (9.72)	196 (7.72)
	1FK7103-2A				221 (8.70)	170 (6.69)	273 (10.75)	222 (8.74)
	1FK7105-2A				273 (10.75)	222 (8.74)	325 (12.80)	274 (10.79)
1FK7 High Dynamic								
36	1FK7033-4C	81 (3.19)	80 (3.15)	15 (0.59)	163 (6.42)	127 (5.00)	190 (7.48)	154 (6.06)
48	1FK7043-4C	90 (3.54)	90 (3.54)	23 (0.9)	186 (7.32)	138 (5.43)	218 (8.58)	170 (6.69)
	1FK7044-4C				211 (8.31)	163 (6.42)	243 (9.57)	195 (7.68)
63	1FK7061-4C	103 (4.06)	104 (4.09)	23 (0.9)	188 (7.40)	141 (5.55)	224 (8.82)	176 (6.93)
	1FK7064-4C				252 (9.92)	205 (8.07)	288 (11.34)	240 (9.45)
80	1FK708.-4CC	118 (4.65)	119 (4.69)	21 (0.83)	243 (9.57)	197 (7.76)	295 (11.61)	250 (9.84)
	1FK708.-4C							

Technical data and characteristics

4.3 Dimension drawings

For motor		Dimensions in mm (inches)											Shaft extension DE			
Shaft height	Type	DIN IEC	a ₁ P	b ₁ N	c ₁ LA	e ₁ M	f AB	f ₁ T	i ₂ -	s ₂ S	d D	d ₆ -	l E	t GA	u F	
1FK7 Compact/High Dynamic																
36	1FK703		90 (3.54)	60 (2.36)	8 (0.31)	75 (2.95)	72 (2.83)	3 (0.12)	30 (1.18)	6,5 (0.26)	14 (0.55)	M5	30 (1.18)	16 (0.63)	5 (0.20)	
48	1FK704		120 (4.72)	80 (3.15)	10 (0.39)	100 (3.94)	96 (3.78)	3 (0.12)	40 (1.57)	6,5 (0.26)	19 (0.75)	M6	40 (1.57)	21,5 (0.85)	6 (0.24)	
63	1FK706		155 (6.10)	110 (4.33)	10 (0.39)	130 (5.12)	126 (4.96)	3,5 (0.14)	50 (1.97)	9 (0.35)	24 (0.94)	M8	50 (1.97)	27 (1.06)	8 (0.31)	
80	1FK708		194 (7.64)	130 (5.12)	11,5 (0.45)	165 (6.50)	155 (6.10)	3,5 (0.14)	58 (2.28)	11 (0.43)	32 (1.26)	M12	58 (2.28)	35 (1.38)	10 (0.39)	
100	1FK710		245 (9.65)	180 (7.09)	13 (0.51)	215 (8.46)	192 (7.56)	4 (0.16)	80 (3.15)	14 (0.55)	38 (1.50)	M12	80 (3.15)	41 (1.61)	10 (0.39)	

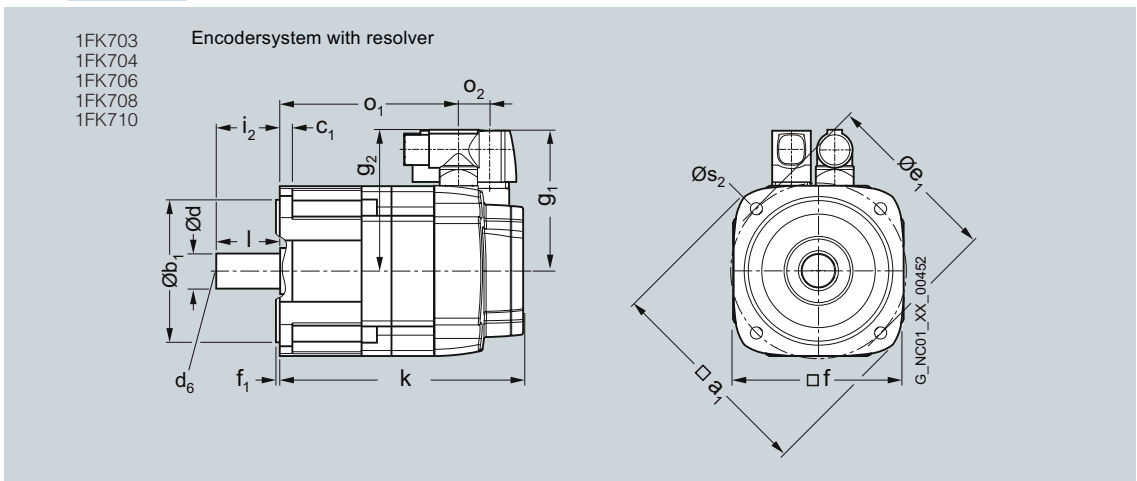

1FK7 motors with planetary gearboxes, series SP+

SP+ planetary gearbox		Dimension in mm (inches)			SP+ planetary gearbox two-stage		
Type	Motor Type	SP+ planetary gearbox single-stage -MF1			SP+ planetary gearbox two-stage -MF2		
		D1	F1	L1	D1	F1	L1
SP060S-	1FT702/1FK702	68 (2.68)	70 (2.76)	89,3 (3.52)	70 (2.76)	60 (2.36)	108 (4.25)
	1FT703/1FK703	68 (2.68)	70 (2.76)	94 (3.70)	68 (2.68)	70 (2.76)	116 (4.57)
	1FT704/1FK704	91 (3.58)	90 (3.54)	106 (4.17)	–	–	–
SP075S-	1FT702/1FK702	91 (3.58)	90 (3.54)	107,8 (4.24)	95 (3.74)	70 (2.76)	119 (4.69)
	1FT703/1FK703	91 (3.58)	90 (3.54)	107,8 (4.24)	95 (3.74)	70 (2.76)	123,4 (4.86)
	1FT704/1FK704	91 (3.58)	90 (3.54)	111,5 (4.39)	91 (3.58)	90 (3.54)	135,6 (5.34)
SP100S-	1FT702/1FK702	–	–	–	118 (4.65)	90 (3.54)	142,3 (5.60)
	1FT703/1FK703	–	–	–	118 (4.65)	90 (3.54)	142,3 (5.60)
	1FT704/1FK704	115 (4.53)	120 (4.72)	122 (4.80)	118 (4.65)	90 (3.54)	146 (5.75)
	1FT704/1FK706	115 (4.53)	120 (4.72)	129 (5.08)	115 (4.53)	120 (4.72)	164 (6.46)
SP140S-	1FT704/1FK704	–	–	–	152 (5.98)	120 (4.72)	186,3 (7.33)
	1FT706/1FK706	146 (5.75)	150 (5.91)	162,3 (6.39)	152 (5.98)	120 (4.72)	193,3 (7.61)
	1FT708/1FK708	146 (5.75)	150 (5.91)	171,3 (6.74)	146 (5.75)	150 (5.91)	220 (8.66)
	1FT710/1FK710	146 (5.75)	190 (7.48)	171,3 (6.74)	–	–	–
SP180S-	1FT706/1FK706	–	–	–	212 (8.35)	150 (5.91)	234 (9.21)
	1FT708/1FK708	207 (8.15)	210 (8.27)	198 (7.80)	212 (8.35)	150 (5.91)	242,9 (9.56)
	1FT710/1FK710	207 (8.15)	210 (8.27)	203,5 (8.01)	212 (8.35)	190 (7.48)	242,9 (9.56)
SP210S-	1FT708/1FK708	–	–	–	215 (8.46)	210 (8.27)	272 (10.71)
	1FT710/1FK710	215 (8.46)	190 (7.48)	242 (9.53)	215 (8.46)	210 (8.27)	272 (10.71)
SP240S-	1FT708/1FK708	–	–	–	245 (9.65)	210 (8.27)	297,5 (11.71)
	1FT710/1FK710	245 (9.65)	240 (9.45)	273 (10.75)	245 (9.65)	210 (8.27)	297,5 (11.71)

Technical data and characteristics

4.3 Dimension drawings

SP+ planetary gearbox										
Dimension in mm (inches)										
Type	D2	D3	D4	D5	F2	L2	L3	L5	L6	L7
1FT7/1FK7 motor with SP+ planetary gearbox, single-stage/two-stage										
SP060S-MF1/-MF2	16 (0.63)	60 (2.36)	68 (2.68)	5,5 (0.22)	62 (2.48)	28 (1.10)	20 (0.79)	6 (0.24)	18 (0.71)	5 (0.20)
SP075S-MF1/-MF2	22 (0.87)	70 (2.76)	85 (3.35)	6,6 (0.26)	83 (3.27)	36 (1.42)	20 (0.79)	7 (0.28)	24,5 (0.96)	6 (0.24)
SP100S-MF1/-MF2	32 (1.26)	90 (3.54)	120 (4.72)	9 (0.35)	112 (4.41)	58 (2.28)	30 (1.18)	10 (0.39)	35 (1.38)	10 (0.39)
SP140S-MF1/-MF2	40 (1.57)	130 (5.12)	165 (6.50)	11 (0.43)	140 (5.51)	82 (3.23)	30 (1.18)	12 (0.47)	43 (1.69)	12 (0.47)
SP180S-MF1/-MF2	55 (2.17)	160 (6.30)	215 (8.46)	13,5 (0.53)	168,5 (6.63)	82 (3.23)	30 (1.18)	15 (0.59)	59 (2.32)	16 (0.63)
SP210S-MF1/-MF2	75 (2.95)	180 (7.09)	250 (9.84)	17 (0.67)	168,5 (6.63)	105 (4.13)	38 (1.50)	17 (0.67)	79,5 (3.13)	20 (0.79)
SP240S-MF1/-MF2	85 (3.35)	200 (7.87)	290 (11.42)	17 (0.67)	168,5 (6.63)	130 (5.12)	40 (1.57)	20 (0.79)	90 (3.54)	22 (0.87)

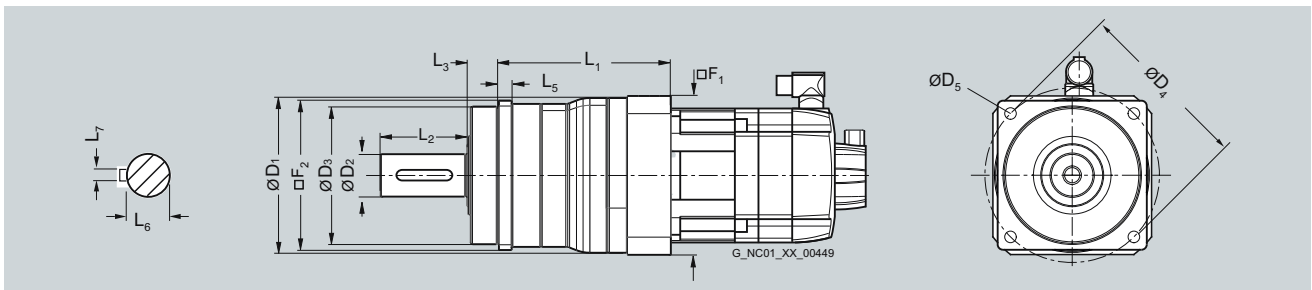

1FK7 motors with planetary gearbox, series LP+

LP+ planetary gearbox												
Dimension in mm (inches)												
Type	Motor Type	L1	L2	L3	L5	L6	L7	D1	D2	D3	D4	D5
1FK7 with LP+ planetary gearbox												
LP050-MO1	1FK702	63 (2.48)	18 (0.71)	6,5 (0.26)	8 (0.31)	13,5 (0.53)	4 (0.16)	50 (1.97)	12 (0.47)	35 (1.38)	44 (1.73)	M4
LP070-MO1	1FK702	83 (3.27)	28 (1.10)	8 (0.31)	10 (0.39)	18 (0.71)	5 (0.20)	70 (2.76)	16 (0.63)	52 (2.05)	62 (2.44)	M5
	1FK703	90 (3.54)										
LP090-MO1	1FK704	112 (4.41)	36 (1.42)	10 (0.39)	12 (0.47)	24,5 (0.96)	6 (0.24)	90 (3.54)	22 (0.87)	68 (2.68)	80 (3.15)	M6
	1FK706	122 (4.80)										
	1FK708	132 (5.20)										
LP120-MO1	1FK706	140 (5.51)	58 (2.28)	12 (0.47)	16 (0.63)	35 (1.38)	10 (0.39)	120 (4.72)	32 (1.26)	90 (3.54)	108 (4.25)	M8
	1FK708	150 (5.91)										
LP155-MO1	1FK708	168,5 (6.63)	82 (3.23)	15 (0.59)	20 (0.79)	43 (1.69)	12 (0.47)	155 (6.10)	40 (1.57)	120 (4.72)	140 (5.51)	M10
	1FK710	188,5 (7.42)										

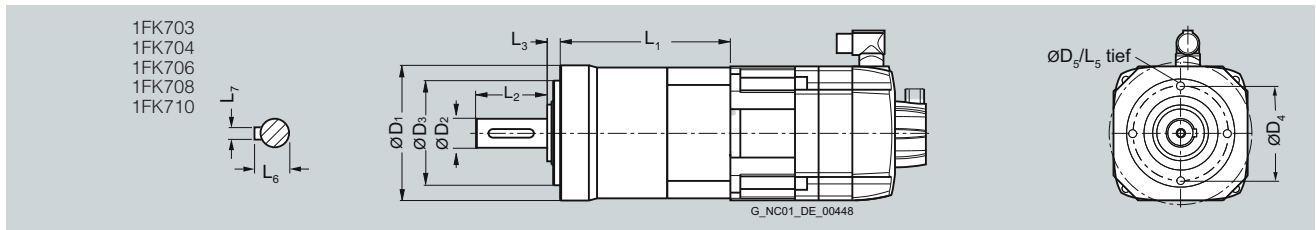

Motor components

5.1 Thermal motor protection

A temperature-dependent resistor is integrated as temperature sensor to monitor the motor temperature.

Table 5- 1 Features and technical data

Type	KTY 84 (PTC thermistor)
Resistance when cold (20°C)	Approx. 580 Ω
Resistance when hot (100°C)	Approx. 1000 Ω
Connection	via signal cable

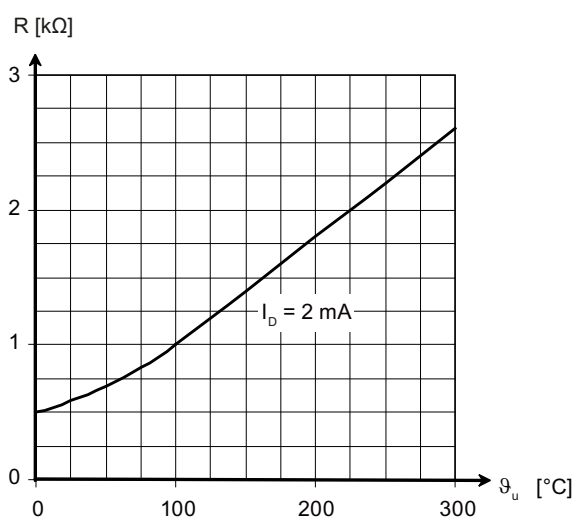

Figure 5-1 Resistance characteristic

The evaluation of the winding temperature is carried out in the converter. When a fault occurs, an appropriate message is output at the drive converter. When the motor temperature increases, a message "Alarm motor overtemperature" is output; this must be externally evaluated. If this signal is ignored, the drive converter shuts down with the appropriate fault message after a preset time period or when the motor limiting temperature or the shutdown temperature is exceeded.

 **CAUTION**

The integrated temperature sensor only protects the synchronous motors to a certain extent against overloads:

1FK701 to 1FK704: up to $2 \cdot I_0 (60 \text{ K})$ and speed $\neq 0$

1FK706 to 1FK710: up to $4 \cdot I_0 (60 \text{ K})$ and speed $\neq 0$

For load applications that are critical from a thermal perspective - e.g. overload when the motor is stationary or an overload of M_{\max} longer than 4 s, adequate protection is no longer available. The "thermal motor model i^2t monitoring" function must be activated in the converter.

The temperature sensor is part of a SELV circuit, which can be destroyed if high voltage is applied. The temperature sensor is designed so that the DIN/EN requirement for "protective separation" is fulfilled.

5.2 Encoder (option)

5.2.1 Encoder selection

Encoder systems with DRIVE-CLiQ interface

For motors with an integrated DRIVE-CLiQ interface, the analog encoder signal is internally converted to a digital signal. No further conversion of the encoder signal in the drive system is necessary. Motors with DRIVE-CLiQ interface simplify commissioning and diagnostics, as the motor and encoder system are identified automatically.

Encoder systems without a DRIVE-CLiQ interface

For motors without an integrated DRIVE-CLiQ interface, the analog encoder signal is first converted into a digital signal in the drive system. For these motors as well as external encoders, the encoder signals must be connected to SINAMICS S110 / S120 via Sensor Modules.

Table 5- 2 Encoders for 1FK7 motors

Without DRIVE-CLiQ		With DRIVE-CLiQ		Absolute position within a rotation (single-turn)	Absolute position over 4096 revolutions (multi-turn)	Can be used for Safety Integrated Extended Functions
Encoders	Marking in the MLFB	Encoders	Marking in the MLFB			
-	-	AS24DQI	B	Yes	No	Yes
-	-	AM24DQI	C	Yes	Yes	Yes
-	-	AS20DQI	Q	Yes	No	Yes
-	-	AM20DQI	R	Yes	Yes	Yes
AM2048S/R	E	AM22DQ	F	Yes	Yes	Yes
AM512S/R	H	AM20DQ	L	Yes	Yes	Yes
AM16S/R	J	AM15DQ	V	Yes	Yes	No
IC2048S/R	A	IC22DQ	D	No	No	Yes
Resolver p=1	T	R14DQ	P	Yes	No	No
Resolver p=3	S	R15DQ	U	No	No	No
Resolver p=4	S	R15DQ	U	No	No	No

Not every encoder is available for every motor frame size

Replacing an encoder

- General

For 1FK703 to 1FK710 motors, the encoder module (with the exception of resolver) can be simply replaced without requiring encoder adjustment.

The motors concerned can be identified by the 14th position in the order number.

Incremental encoders are referenced every time the system is started.

NOTICE

Absolute value encoders must be referenced again after the encoder has been replaced.

- Motors with DRIVE-CLiQ

NOTICE

Motor data (electronic rating plate)

You must ensure that the new encoder contains the correct motor data. If it does not, the motor may move in an uncontrolled fashion and cause significant material damage.
--

You can purchase a preprogrammed encoder module from the Siemens Service Center by quoting the relevant order number and serial number. If your encoder module is not preprogrammed, it must be programmed with the correct motor data prior to use.

5.2.2 Encoder connection for motors with a DRIVE-CLiQ interface

Motors with DRIVE-CLiQ interface have an internal Sensor Module. This includes an electronic rating plate. This simplifies commissioning for the SINAMICS S110 / S120 drive system, since all the motor parameters are set automatically.

 **WARNING**

Encoder modules with a DRIVE-CLiQ interface or Sensor Module contain motor and encoder-specific data as well as an electronic rating plate. This is why it may only be operated on the original motor - and must not be mounted onto other motors or replaced by modules from other motors.

The contacts of the DRIVE-CLiQ interface have direct contact to components that can be damaged/destroyed by electrostatic discharge (ESDs). Neither hands nor tools that could be electrostatically charged should come into contact with the connections.

5.2.3 Encoder connection for motors without DRIVE-CLiQ interface

Motors without an integrated DRIVE-CLiQ interface are connected via the 17-pin or 12-pin flange socket (see the section titled "Connection system").

5.2.4 Incremental encoders

Description

This encoder senses relative movements and does not supply absolute position information. In combination with an evaluation logic, a zero point can be determined using the integrated reference mark, which can be used to calculate the absolute position.

The encoder outputs sine and cosine signals. These can be interpolated using evaluation logic (usually 2048x) and the direction of rotation can be determined. In the version with a DRIVE-CLiQ interface, this evaluation logic is already integrated in the encoder.

Function and technical data

- Angular measuring system for commutation
- Speed actual value sensing
- Indirect incremental measuring system for the position control loop
- One zero pulse (reference mark) per revolution

Table 5- 3 Technical data for incremental encoders

Encoders	Code	Operating voltage	Max. current drain	A-B track: Resolution incremental (sin/cos periods per revolution)	C-D track: Rotor/commutation position (sin/cos periods per revolution)	Angular error
without DRIVE-CLiQ interface						
1FK701 and 1FK702: Incremental encoder sin/cos 1 Vpp, 2048 S/R with C and D tracks	IC2048S/R	5 V ±5 %	140 mA	2048 S/R (1 Vpp)	1 S/R (1 Vpp)	± 80 "
1FK703 to 1FK710: Incremental encoder sin/cos 1 Vpp, 2048 S/R with C and D tracks						± 40 "
with DRIVE-CLiQ interface						
1FK701 and 1FK702: Incremental encoder 22 bit resolution 4.194.304, internal 2048 S/R) + commutation position 11 bit	IC22DQ	24 V	180 mA	4.194.304 (=22 bit)	2048 (=11 bit)	± 80 "
1FK703 to 1FK710: Incremental encoder 22 bit resolution 4.194.304, internal 2048 S/R) + commutation position 11 bit						± 40 "

Mech. speed limit for all incremental encoders: 12000 rpm

Note: The "Single-turn absolute value encoders" are other encoders which can be used as incremental encoders in the SINAMICS drive system.

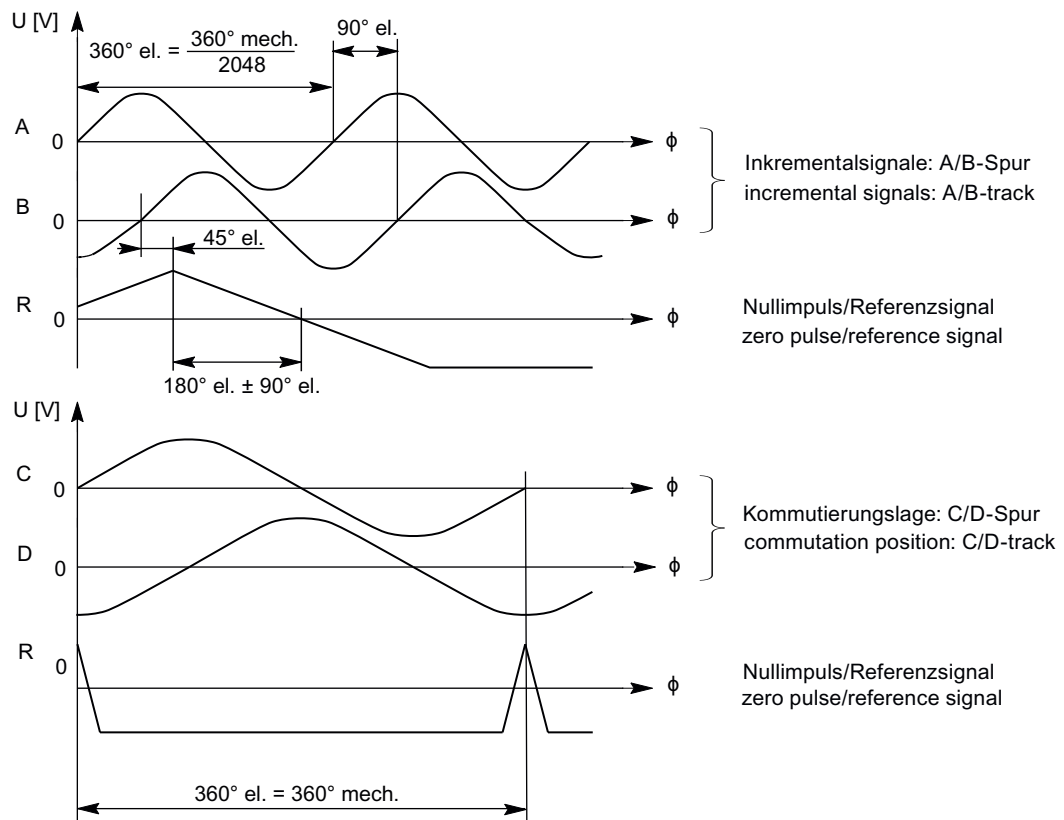

Figure 5-2 Signal sequence and assignment for encoder IC2048S/R without DRIVE-CLiQ interface for a positive direction of rotation

For encoder connection, pin assignment, and cables, refer to the section titled "Connection system".

5.2.5 Absolute value encoder

Description, multiturn absolute encoder

This encoder outputs an absolute angular position between 0° and 360° in the specified resolution. An internal measuring gearbox enables it to differentiate between 4096 rotations. So with a ball screw, for example, the absolute position of the slide can be determined over a long distance.

Description, absolute value singleturn

This encoder outputs an absolute angular position between 0° and 360° in the specified resolution. In contrast to the multi-turn absolute value encoder, it has no measuring gearbox and can therefore only supply the position value within one revolution. It does not have a traversing range.

Function and technical data

- Angular measuring system for commutation
- Speed actual value sensing
- Indirect measuring system for absolute position determination within a revolution
- Indirect measuring system for determining the absolute position within a traversing range of 4096 revolutions
- For multi-turn encoders: Indirect measuring system for absolute position determination within a traversing range
- Indirect incremental measuring system for position control loop

Table 5- 4 Technical data, absolute value encoder without DRIVE-CLiQ interface

Designation	Code	Operating voltage	Max. current drain	Absolute resolution (singleturn)	Traversing -range (multiturn)	A-B track: Resolution incremental (sin/cos periods per revolution)	Angular error
Serial absolute position interface: EnDat 2.1							
Absolute value encoder 2048 S/R, (4096 revolutions, multi-turn, with EnDat interface)	AM2048S/R	5 V ±5%	200 mA	8192 (=13 bit)	4096 (=12 bit)	2048 S/R (1 Vpp)	±40"
Absolute value encoder 512 S/R, (4096 revolutions, multi-turn, with EnDat interface)	AM512S/R	5 V ±5%	200 mA	8192 (=13 bit)	4096 (=12 bit)	512 S/R (1 Vpp)	±80"
Absolute value encoder 16 S/R, (4096 revolutions, multi-turn, with EnDat interface)	AM16S/R	5 V ±5%	210 mA	8192 (=13 bit)	4096 (=12 bit)	16 S/R (1 Vpp)	±480"

Table 5- 5 Technical data, absolute value encoder with DRIVE-CLiQ interface

Designation	Code	Operating voltage	Max. current drain	Absolute resolution (singleturn)	Traversing-range (multiturn)	Angle error
Serial absolute position interface: DRIVE-CLiQ						
Absolute encoder, single-turn, 24 bit	AS24DQI	24 V	110 mA	16.777.216 (=24 bit)	-	±40"
Absolute encoder 24 bit + 12 bit multiturn	AM24DQI	24 V	110 mA	16.777.216 (=24 bit)	4096 (=12 bit)	±40"
Absolute encoder, single-turn, 20 bit	AS20DQI	24 V	110 mA	1.048.576 (=20 bit)	-	±120"
Absolute encoder 20 bit + 12 bit multiturn	AM20DQI	24 V	110 mA	1.048.576 (=20 bit)	4096 (=12 bit)	±120"
Absolute encoder 22 bit + 12 bit multiturn	AM22DQ	24 V	210 mA	4.194.304 (=22 bit)	4096 (=12 bit)	±40"

Designation	Code	Operating voltage	Max. current drain	Absolute resolution (singleturn)	Traversing-range (multiturn)	Angle error
Absolute encoder 20 bit + 12 bit multiturn	AM20DQ	24 V	210 mA	1.048.576 (=20 bit)	4096 (=12 bit)	±80"
Absolute encoder 15 bit + 12 bit multiturn	AM15DQ	24 V	210 mA	32.768 (=15 bit)	4096 (=12 bit)	±480"

Mech. speed limit for all absolute value encoders: 12000 rpm

Signal sequence and assignment of the A/B track; refer to Fig. "Incremental encoders".

Note

Reduction of the thermal permissible rated torque for 1FK701 and 1FK702

As a result of the reduced maximum operating temperature of absolute encoders in shaft heights 20 and 28 with respect to incremental encoders, the thermally permissible rated torque of the relevant motors is reduced by 10 %.

5.2.6 Resolver

Description

The number of sine and cosine periods per revolution corresponds to the number of pole pairs of the resolver. In the case of a 2-pole resolver, the evaluation electronics may output an additional zero pulse per encoder revolution. This zero pulse ensures a unique assignment of the position information in relation to an encoder revolution. A 2-pole resolver can therefore be used as a single-turn encoder. 2-pole resolvers can be used for motors with any number of pairs of poles. With multi-pole resolvers, the pole pair numbers of the motor and the resolver are always identical. The resolution is correspondingly higher than for 2-pole resolvers.

Function and technical data

- Angular measuring system for commutation
- Speed actual value sensing
- Indirect incremental measuring system for the position control loop

Table 5- 6 Technical data, resolver without DRIVE-CLiQ interface

Designation	Short designation	Excitation voltage rms, excitation frequency	Angle error
2-pole resolver	Resolver p=1	2 ... 8 V, 5 ... 10 KHz	±840° for 1FK703 to 1FK710 ±1200° for 1FK701 and 1FK702
6-pole resolver	Resolver p=3	2 ... 8 V, 5 ... 10 KHz	±420°

Designation	Short designation	Excitation voltage rms, excitation frequency	Angle error
8-pole resolver	Resolver p=4	2 ... 8 V, 5 ... 10 KHz	±240°
Calculation of the output signals		Gear ratio $\dot{U} = 0.5 \pm 5\%$ $U_{\text{sine track}} = \dot{U} \times U_{\text{excitation}} \times \sin \alpha$ $U_{\text{cosine track}} = \dot{U} \times U_{\text{excitation}} \times \cos \alpha$ $\alpha = \arctan (U_{\text{sine track}} / U_{\text{cosine track}})$	

Table 5-7 Technical data, resolver with DRIVE-CLiQ interface

Designation	Short designation	Supply voltage	Resolution	Angle error
Resolver 15 bit, resolution 32768, internal, multi-pole	R15DQ	24 V	32.768 (=15 bit)	±420° for 6-pole ±240° for 8-pole
Resolver 14 bit resolution 16384, internal, 2-pole	R14DQ	24 V	16.384 (=14 bit)	±840° for 1FK703 to 1FK710 ±1200° for 1FK701 and 1FK702

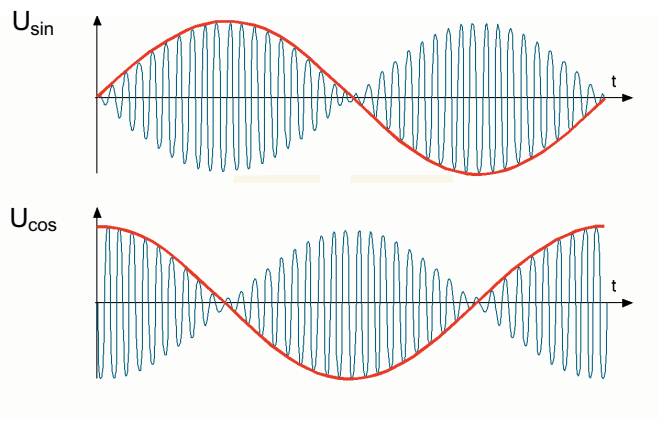

Figure 5-3 Output signals, resolver

5.3 Holding brake (option)

5.3.1 Properties

- The holding brake is used to clamp the motor shaft when the motor is at a standstill. The holding brake is **not** a working brake that is used to brake a motor that is still rotating.
- Restricted Emergency Stop operation is permissible. Up to 2000 braking operations can be executed with 300% rotor moment of inertia as external moment of inertia from a speed of 3000 RPM without the brake being subject to an inadmissible amount of wear. The specific highest switching work for each emergency braking operation may not be exceeded.
- The rated voltage of the holding brake is 24 VDC.

 CAUTION
--

The rated voltage is 24 VDC +/- 10%. Voltages outside this tolerance bandwidth can result in faults.
--

Inadmissible wear means that the braking function can no longer be guaranteed! It is not permissible to exceed the above specified Emergency Stop conditions or to repeatedly briefly accelerate the motor against a holding brake that is still closed. This means that the switching times of the brakes and relays must be taken into account in the drive control and enable functions.

NOTICE

Motors with or without holding brake cannot be subsequently retrofitted!
--

Motors with holding brake are longer by the mounted space required (refer to the dimension drawings).

5.3.2 Permanent-magnet brake

The magnetic field of the permanent magnets results in a pulling force on the brake armature disk. This means that in the no-current condition, the brake is closed and the motor shaft is held.

When 24 V DC rated voltage is connected to the brake, the solenoid – through which current flows – establishes an opposing field. As a result the force of the permanent magnets is neutralized and the brake opens without residual torque on account of the spring return. The permanent magnet brake has torsion-proof connection to the rotor of the motor. This is the reason that this brake is almost without any play.

CAUTION

Motors with integrated permanent-magnet holding brake cannot be subject to axial forces at the shaft end! This applies when installing the system and during operation.

5.3.3 Motor-side connection of the holding brake

In combination with the MOTION CONNECT power cable with integrated brake connection cable, the holding brake in the motor is intended for direct connection to the SINAMICS converter. Since safe electrical isolation from the motor winding is guaranteed for the brake cable in the motor and the power cable is designed as an enforced insulation, no further protection circuits are required in this case.

5.3.4 Protective circuitry for the brake

The brake can be activated via an external power supply. Since safe electrical isolation from the motor winding is guaranteed for the brake cable in the motor and the power cable is designed as an enforced insulation, this can also be a PELV (PELV = protective extra low voltage) supply. The relay K1, located between coil and contact, must also have enforced insulation in order to protect the internal logic voltage.

In the case of an external activation, the brake has to be provided with a protective circuit (see Fig. "Suggested circuit for the external power supply"). This protective circuit avoids parasitic voltage peaks and guarantees the switching times indicated (see Table "Technical data of holding brakes used").

The minimum voltage of 24 V DC -10% must be available at the connector on the motor side in order to guarantee that the brake reliably opens. If the maximum voltage of 24 V DC +10% is exceeded, the brake could re-close. The voltage drop along the brake feeder cable must be taken into consideration. The voltage drop ΔU for copper cables can be calculated approximately as follows:

$$\Delta U [V] = 0.042 \cdot (l/q) \cdot I_{\text{brake}}$$

l = Cable length [m]

q = Brake core cross section [mm²]

I_{brake} = Direct current of the brake [A]

CAUTION

In order to avoid overvoltages when shutting down and the possible negative impact on the plant or system environment, a protective circuit must be integrated into the feeder cable (see figure below)

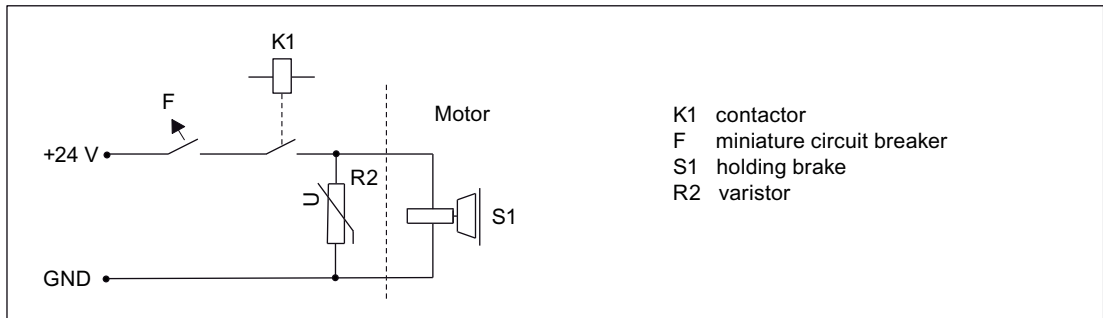

Figure 5-4 Suggested circuit for the external power supply with protective circuit

Table 5- 8 Example: Electronic components for the recommended circuit

Electr. component	Examples		
F	3RV10 circuit-breaker with current paths connected in series (if required with mounted auxiliary contact 3RV1901 to provide a feedback signal for the drive).	or	Miniature circuit-breaker 5SX21 (if required with mounted auxiliary contact to provide a feedback signal for the drive).
K1	Auxiliary contactor 3RH11	or	Contactor 3RT10
R2	Varistor SIOVS14K30 (EPCOS)		

5.3.5 Technical data of the holding brake

Table 5- 9 Technical data of the holding brakes

Motor type	Holding torque	Dynamic torque	DC current	Opening time	Closing time	Highest switched energy
	M_4	M_{1m}		T_0	With varistor	
	[Nm]	[Nm]	[A]	[ms]	t_{c1}	[J]
Permanent-magnet brakes for 1FK7 Compact, High Dynamic and High Inertia						
1FK701□	0.4	0.3	0.3	30	20	2
1FK702□	1	0.7	0.3	30	20	8

Motor type	Holding torque	Dynamic torque	DC current	Opening time	Closing time	Highest switched energy
	M_4	M_{1m}		T_0	With varistor	
	[Nm]	[Nm]	[A]	[ms]	t_{c1}	[J]
1FK703□	1.9	1	0.3	50	30	40
1FK704□	4	3	0.5	70	30	150
1FK706□	13	8.5	0.8	100	50	380
1FK708□	22	11	0.9	200	60	1400
1FK7100	23	11	1.0	300	70	3380
1FK7101	43	25	1.0	300	70	3380
1FK7103						
1FK7105						

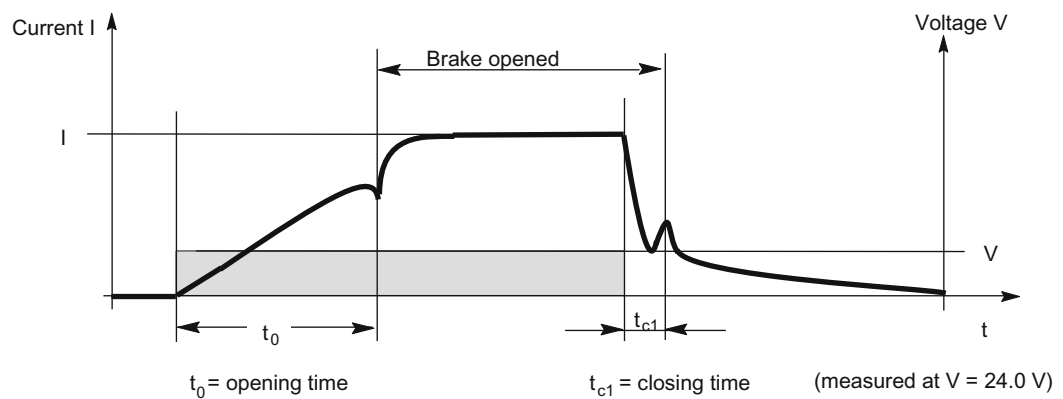

Figure 5-5 Terminology (time) for holding operation

Holding torque M_4

The holding torque M_4 is the highest permissible torque with which the closed brake can be loaded in steady-state operation without slip (holding function when motor is stationary).

Dynamic braking torque M_{1m}

The dynamic braking torque M_{1m} is the smallest mean dynamic braking torque that can occur for an Emergency Stop.

5.4 Brake resistances (armature short-circuit braking)

For transistor PWM converters, when the DC link voltage values are exceeded or if the electronics fails, then electrical braking is no longer possible. If the drive which is coasting down, can represent a potential hazard, then the motor can be braked by short-circuiting the armature. Armature short-circuit braking should be initiated at the latest by the limit switch in the traversing range of the feed axis.

The friction of the mechanical system and the switching times of the contactors must be taken into account when determining the distance that the feed axis takes to come to a complete stop. In order to avoid mechanical damage, mechanical stops should be located at the end of the absolute traversing range.

For servomotors with integrated holding brake, the holding brake can be simultaneously applied to create an additional braking torque – however, with some delay.

CAUTION

The converter pulses must first be canceled and this actually implemented before an armature short-circuit contactor is closed or opened. This prevents the contactor contacts from burning and eroding and destroying the converter.

WARNING

The drive must always be operationally braked using the setpoint input. For additional information, refer to the Converter Configuration Manual.

The optimum braking torque of the servomotor in regenerative operation can be obtained using armature short-circuit with a matching external resistor circuit.

Possible ordering address: <http://www.frizlen.com>

Note

It goes without saying that equivalent products from other manufacturers may be used. Our recommendations should be considered as such. We cannot accept any liability for the quality and properties/features of third-party products.

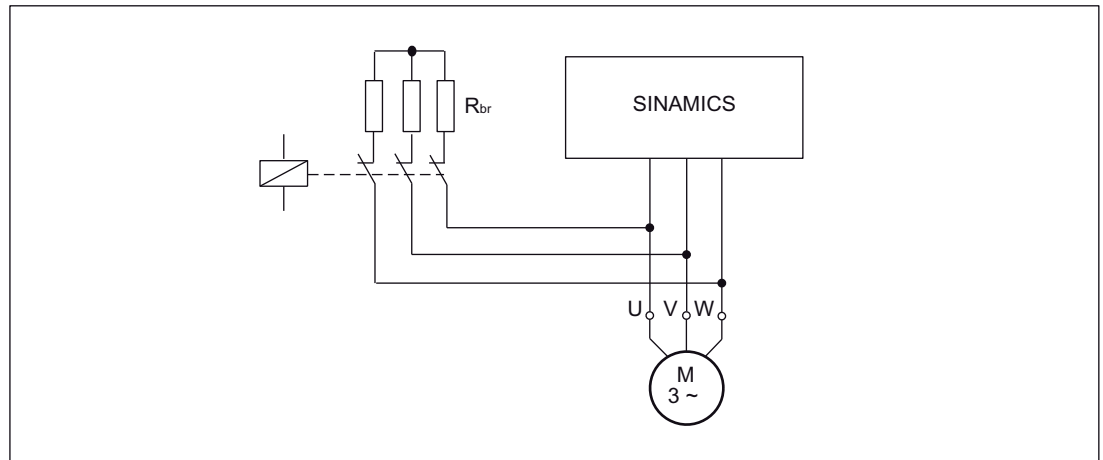

Figure 5-6 Circuit (schematic) with brake resistors

Rating

The ratings of the resistors must match the particular I^2t load capability. The resistors can be dimensioned so that a surface temperature of 300° C can occur briefly (max. 500 ms). In order to prevent the resistors from being destroyed, braking from the rated speed can occur max. every 2 minutes. Other braking cycles must be specified when ordering the resistors. The external moment of inertia and the intrinsic motor moment of inertia are decisive when dimensioning these resistors.

The kinetic energy must be specified when ordering in order to determine the resistor rating.

$$W = \frac{1}{2} \cdot J \cdot \omega^2$$

$$\omega = \frac{2 \cdot \pi}{60} \cdot n$$

W = kinetic energy [Ws]

J = Moment of inertia [kgm²]

ω = Angular speed [s⁻¹]

n = Speed [rpm]

Calculating the braking time

Braking time:
$$t_B = \frac{J_{tot} \cdot n}{9.55 \cdot M_B}$$

Moment of inertia:
$$J_{tot} = J_{mot} + J_{external}$$

t_B = Braking time [s]

n = operating speed [rpm]

M_B = average braking torque [Nm]

J_{tot} = moment of inertia [kgm²]

J_{mot} = motor moment of inertia [kgm²]

$J_{external}$ = external moment of inertia [kgm²]

NOTICE

When determining the run-on distance, the friction (taken into account as allowance in M_B) of the mechanical transmission elements and the switching delay times of the contactors must be taken into consideration. In order to prevent mechanical damage, mechanical end stops should be provided at the end of the absolute traversing range of the machine axes.

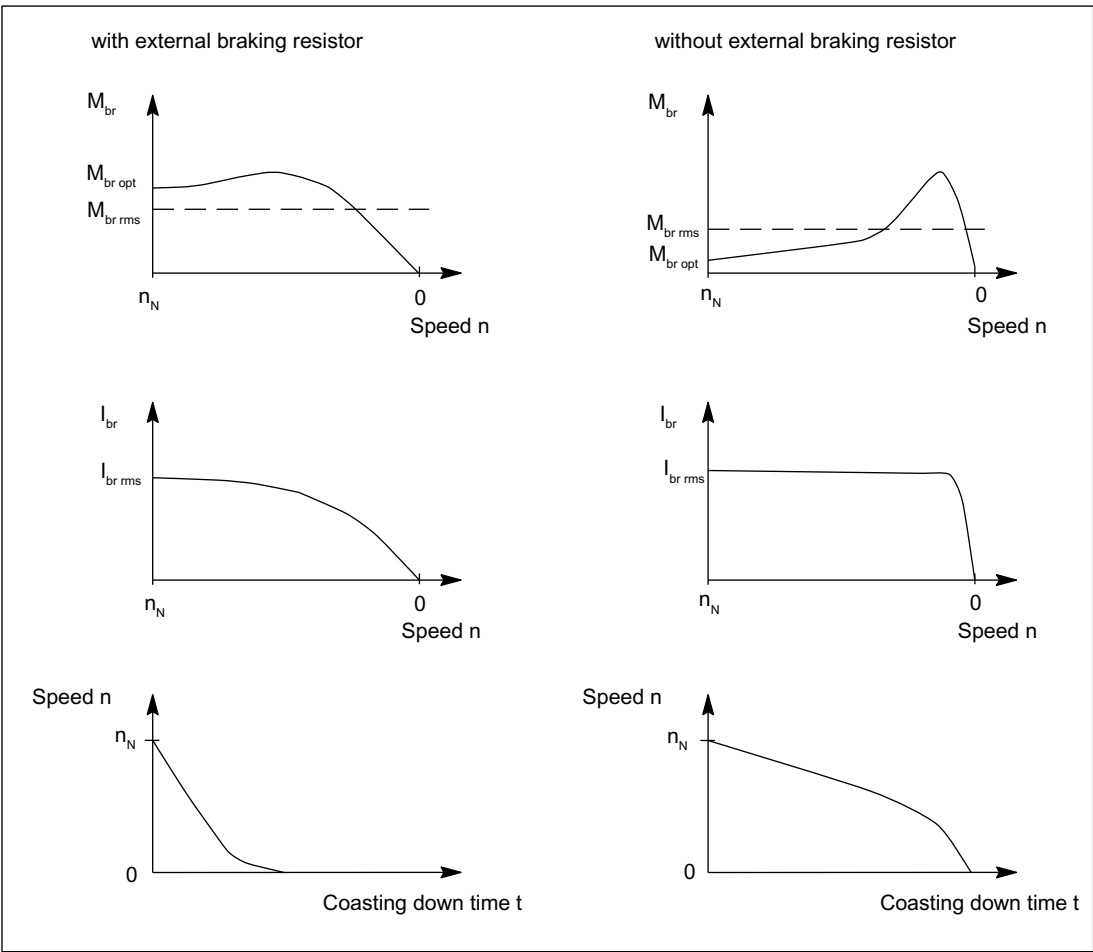

Figure 5-7 Armature short-circuit braking

5.4.1 Dimensioning of braking resistors

The correct dimensioning ensures an optimum braking time. The braking torques which are obtained are also listed in the tables. These data apply to braking operations from the rated speed and moment of inertia $J_{external} = J_{mot}$. If the drive is braked from another speed, then the braking time cannot be proportionally reduced. However, longer braking times cannot occur if the speed at the start of braking is less than the rated speed.

5.4 Brake resistances (armature short-circuit braking)

The data in the following table is calculated for rated values according to the data sheet. The variance during production as well as iron saturation have not been taken into account here. Higher currents and torques can occur than those calculated as a result of the saturation.

1FK7 Compact

Table 5- 10 Dynamic braking for 1FK7 Compact

Motor type	Braking resistor, external R_{opt} [Ω]	Average braking torque		Maximum braking torque $M_{br max}$ [Nm]	rms braking current	
		Without external braking resistor $M_{br rms}$ [Nm]	With external braking resistor $M_{br rms} (R_{opt})$ [Nm]		Without external braking resistor $I_{br rms}$ [A]	With external braking resistor $I_{br rms} (R_{opt})$ [A]
1FK7011-5AK71	2.3	0.13	0.14	0.17	2.5	2.3
1FK7015-5AK71	6.2	0.23	0.28	0.35	2.6	2.3
1FK7022-5AK71	4.1	1.0	1.2	1.5	5.9	5.4
1FK7032-2AK71	11.3	1.0	1.4	1.8	4.7	4.3
1FK7034-2AK71	11.8	1.5	2.2	2.7	5.8	5.3
1FK7040-2AK71	17.9	0.5	1.0	1.3	3.6	3.2
1FK7042-2AC71	18.2	1.6	2.1	2.7	2.6	2.4
1FK7042-2AF71	17.3	1.3	2.1	2.6	3.5	3.2
1FK7042-2AK71	9.7	0.8	2.1	2.6	7.1	6.4
1FK7060-2AC71	10.0	2.6	4.4	5.5	5.4	4.9
1FK7060-2AF71	8.2	2.1	4.4	5.5	7.7	6.9
1FK7060-2AH71	6.5	1.6	4.4	5.5	11.0	9.8
1FK7062-2AC71	15.5	3.6	6.6	8.2	5.4	4.9
1FK7062-2AF71	8.0	2.8	6.6	8.2	9.7	8.7
1FK7062-2AH71	5.5	2.1	6.5	8.1	14.5	13.0
1FK7063-2AC71	6.7	4.7	8.8	10.9	9.7	8.7
1FK7063-2AF71	4.7	3.7	8.8	11.0	14.6	13.1
1FK7063-2AH71	3.3	2.8	8.7	10.8	21.7	19.5
1FK7080-2AF71	9.8	2.1	5.9	7.3	8.4	7.5
1FK7080-2AH71	6.5	1.6	5.9	7.3	12.9	11.6
1FK7081-2AC71	8.6	4.1	9.3	11.6	9.0	8.1
1FK7081-2AF71	4.4	3.2	9.3	11.6	15.8	14.2
1FK7081-2AH71	3.0	2.4	9.4	11.7	23.9	21.4
1FK7083-2AC71	4.7	5.9	13.7	17.1	14.9	13.3
1FK7083-2AF71	4.0	4.6	13.8	17.1	20.2	18.1
1FK7083-2AH71	2.9	3.3	13.6	17.0	29.7	26.6
1FK7084-2AC71	4.4	7.3	17.7	21.9	17.4	15.6
1FK7084-2AF71	3.4	5.5	17.6	21.9	24.9	22.3
1FK7100-2AC71	4.8	5.2	13.8	17.1	15.0	13.4
1FK7100-2AF71	4.3	4.0	13.7	17.1	19.7	17.6

5.4 Brake resistances (armature short-circuit braking)

Motor type	Braking resistor, external R_{opt} [Ω]	Average braking torque		Maximum braking torque $M_{br max}$ [Nm]	rms braking current	
		Without external braking resistor $M_{br rms}$ [Nm]	With external braking resistor $M_{br rms} (R_{opt})$ [Nm]		Without external braking resistor $I_{br rms}$ [A]	With external braking resistor $I_{br rms} (R_{opt})$ [A]
1FK7101-2AC71	3.2	8.2	22.5	28.0	23.4	21.0
1FK7101-2AF71	2.1	6.1	22.4	27.9	36.4	32.6
1FK7103-2AC71	3.0	10.3	30.5	37.9	28.2	25.3
1FK7103-2AF71	1.4	7.9	30.6	38.0	51.4	46.0
1FK7105-2AC71	1.7	17.9	50.6	62.8	48.2	43.1
1FK7105-2AF71	1.1	13.3	50.2	62.4	70.0	66.2

Table 5- 11 Dynamic braking for 1FK7 Compact connected to a Power Module 1 AC 230 V

Motor type	Braking resistor, external R_{opt} [Ω]	Average braking torque		Maximum braking torque $M_{br max}$ [Nm]	rms braking current	
		Without external braking resistor $M_{br rms}$ [Nm]	With external braking resistor $M_{br rms} (R_{opt})$ [Nm]		Without external braking resistor $I_{br rms}$ [A]	With external braking resistor $I_{br rms} (R_{opt})$ [A]
1FK7011-5AK21	6.9	0.13	0.14	0.17	1.4	1.3
1FK7015-5AK21	19.1	0.23	0.28	0.34	1.5	1.3
1FK7022-5AK21	4.4	1.0	1.1	1.4	5.7	5.2
1FK7032-2AF21	3.5	1.2	1.3	1.7	4.3	4.0
1FK7034-2AF21	3.3	2.1	2.2	2.8	5.9	5.5
1FK7042-2AF21	3.6	1.9	2.8	3.4	8.4	7.6

1FK7 High Dynamic

Table 5- 12 Dynamic braking for 1FK7 High Dynamic

Motor type	Braking resistor, external R_{opt} [Ω]	Average braking torque		Maximum braking torque $M_{br max}$ [Nm]	rms braking current	
		Without external braking resistor $M_{br rms}$ [Nm]	With external braking resistor $M_{br rms} (R_{opt})$ [Nm]		Without external braking resistor $I_{br rms}$ [A]	With external braking resistor $I_{br rms} (R_{opt})$ [A]
1FK7033-4CK71	17.2	0.5	0.9	1.1	3.3	3.0
1FK7043-4CH71	8.4	1.1	2.6	3.3	7.3	6.5
1FK7043-4CK71	6.3	0.9	2.6	3.3	9.9	8.8
1FK7044-4CF71	7.4	1.7	3.4	4.2	7.0	6.3
1FK7044-4CH71	6.4	1.4	3.4	4.2	9.5	8.5

5.4 Brake resistances (armature short-circuit braking)

Motor type	Braking resistor, external R_{opt} [Ω]	Average braking torque		Maximum braking torque $M_{br max}$ [Nm]	rms braking current	
		Without external braking resistor $M_{br rms}$ [Nm]	With external braking resistor $M_{br rms} (R_{opt})$ [Nm]		Without external braking resistor $I_{br rms}$ [A]	With external braking resistor $I_{br rms} (R_{opt})$ [A]
1FK7061-4CF71	9.7	0.7	2.5	3.1	5.6	5.0
1FK7061-4CH71	7.2	0.5	2.5	3.1	8.1	7.2
1FK7064-4CC71	6.2	1.7	5.0	6.2	8.0	7.2
1FK7064-4CF71	5.3	1.3	5.1	6.3	10.8	9.7
1FK7064-4CH71	4.2	1.0	5.0	6.3	15.0	13.4
1FK7085-4CC71	3.8	3.2	10.3	12.8	14.8	13.2
1FK7085-4CF71	2.2	2.4	10.3	12.8	24.0	21.5
1FK7086-4CC71	3.1	7.4	21.3	26.5	23.2	20.7
1FK7086-4CF71	1.8	5.6	21.1	26.3	37.6	33.6

Table 5- 13 Dynamic braking for 1FK7 High Dynamic connected to a Power Module 1 AC 230 V

Motor type	Braking resistor, external R_{opt} [Ω]	Average braking torque		Maximum braking torque $M_{br max}$ [Nm]	rms braking current	
		Without external braking resistor $M_{br rms}$ [Nm]	With external braking resistor $M_{br rms} (R_{opt})$ [Nm]		Without external braking resistor $I_{br rms}$ [A]	With external braking resistor $I_{br rms} (R_{opt})$ [A]
1FK7033-4CF21	6.9	0.7	0.9	1.1	3.3	3.0
1FK7043-4CF21	5.2	1.4	2.6	3.3	7.3	6.5

1FK7 High Inertia

Table 5- 14 Dynamic braking for 1FK7 High Inertia

Motor type	Braking resistor, external R_{opt} [Ω]	Average braking torque		Maximum braking torque $M_{br max}$ [Nm]	rms braking current	
		Without external braking resistor $M_{br rms}$ [Nm]	With external braking resistor $M_{br rms} (R_{opt})$ [Nm]		Without external braking resistor $I_{br rms}$ [A]	With external braking resistor $I_{br rms} (R_{opt})$ [A]
1FK7042-3BK71	9.7	0.8	2.1	2.6	7.1	6.4
1FK7060-3BF71	8.2	2.1	4.4	5.5	7.7	6.9
1FK7062-3BF71	8.0	2.8	6.6	8.2	9.7	8.7
1FK7081-3BF71	4.4	3.2	9.3	11.6	15.8	14.2
1FK7084-3BC71	4.4	7.3	17.7	21.9	17.4	15.6
1FK7084-3BF71	3.4	5.5	17.6	21.9	24.9	22.3

5.5 Gearbox

5.5.1 Dimensioning the gearbox

Overview

- The following influencing parameters should be taken into consideration:
 - acceleration torque, permanent torque, number of cycles, cycle type, permissible input speed, mounting position, torsional backlash, torsional stiffness, and radial and axial forces.
 - Worm gearboxes are only conditionally suitable for reversing operation with servo applications.
- Technical data should be obtained from the catalogs of the gearbox manufacturers and similar sources.
- If the gearbox oil is in contact with the motor flange, then suitable shaft and flange seals must be selected.

Dimensioning for S3 duty

When engineering geared drive systems you can use the motor characteristic without reduction. Please note the permissible maximum torque and the permissible gearbox input speed.

$$M_{Mot} = M_{out} / (i \cdot \eta_G)$$

The motor and gearbox are assigned as follows: $M_{max, gear} \geq M_{0(100K)} \cdot i \cdot f$

$M_{max, gear}$	Max. permissible drive torque
$M_{0(100K)}$	Motor static torque
i	Gear ratio
f	Supplementary factor $f = f_1 \cdot f_2$

$f_1 = 2$	for motor accelerating torque
$f_2 = 1$	for ≤ 1000 gearbox switching cycles / h
$f_2 > 1$	for > 1000 switching cycles / h (refer to the gearbox catalog)
e.g. $f_2 = 1.5$	for 3000 switching cycles / h
$f_2 = 1.8$	for 5000 switching cycles / h
$f_2 = 2.0$	for 8000 switching cycles / h

NOTICE

Switching cycles can also be superimposed vibration! The supplementary factor (f_2) is then not sufficient when dimensioning the gearbox and gearboxes may fail.

The complete system should be optimized so that the higher-level vibration is minimized.

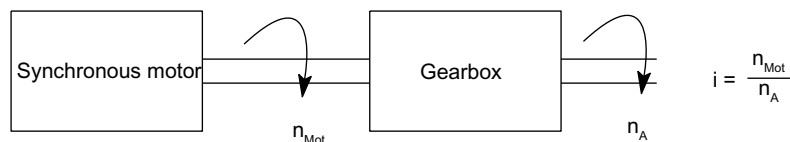

Figure 5-8 Gear ratio

The load torque and the required start-up velocity define the gearbox output torque, the output speed and therefore the output power.

The required drive power is calculated from this:

$$P_{out} [W] = P_{mot} [W] \cdot \eta_G = (\pi/30) \cdot M_{mot} [Nm] \cdot n_{mot} [rpm] \cdot \eta_G$$

Dimensioning for S1 duty

The gearbox itself generates heat due to friction and acts as a thermal barrier preventing heat from being dissipated through the motor flange. This is the reason that the torque must be reduced for S1 duty.

The required motor torque is calculated as follows:

$$M_{Mot} = \sqrt{\left(\frac{M_{ab} + M_V}{i \cdot \eta_G} \right)^2 - M_V^2} \quad \text{mit} \quad M_V = a \cdot b \cdot \frac{n_{Mot}}{60} (1 - \eta_G) \cdot \frac{k_T^2}{R_{Strw}}$$

M_{Mot}	Motor torque [Nm]
M_V	Calculated "torque loss" [Nm]
a	$\pi/3$ for 1FT7/1FK7 motors supplied with sinusoidal current
b	Weighting factor for gearbox losses (without dimensions); $b = 0.5$
η_G	Gearbox efficiency
i	Gearbox ratio ($i > 1$)
k_T	Torque constant [Nm/A]
M_{out}	Gearbox output torque [Nm]
n_A	Output speed of gearbox [rpm]
n_{Mot}	Motor speed [rpm]
R_{Strw}	Resistance when hot of the motor phase [Ω]; $R_{Strw} = 1.4 \cdot R_{Str}$ (see chapter headed "Technical data and characteristics")
P_{out}	Gearbox output power [W]

P_{Mot} Motor power [W]
 π pi = 3.1416

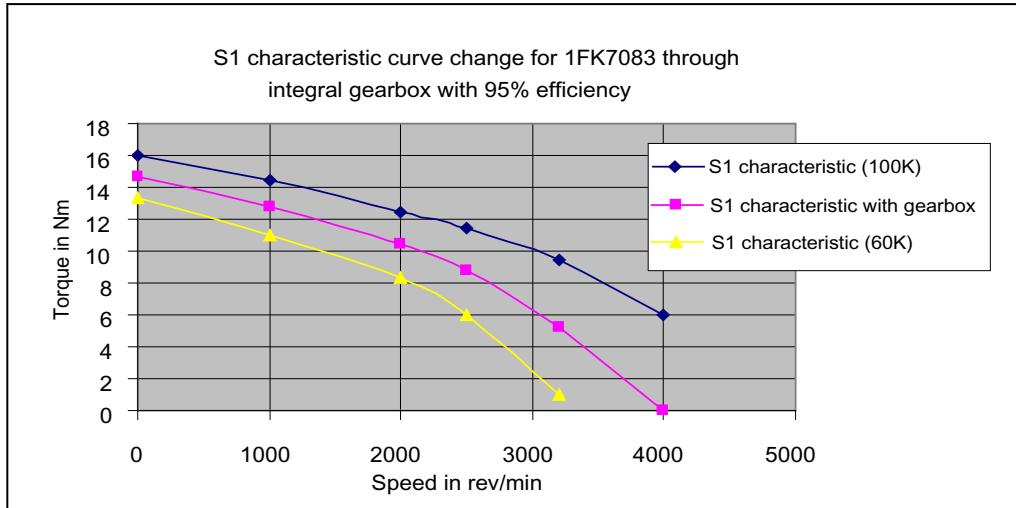

Figure 5-9 Example: 1FK7083 with angled gearbox (characteristic)

Information for additional characteristics: $S1_{gearbox} = S1_{100K} - (S1_{100K} - S1_{60K}) / 2$

Starting behavior of a motor when a gearbox is mounted

NOTICE

During commissioning, it should be assumed that an increased current will be drawn due to the lubrication characteristics (inadequate distribution of grease and oil) and the fact that the shaft sealing ring is being run-in.

5.5.2 Motors with planetary gears

5.5.2.1 Characteristics of SP+ series

Overview

1FK7 motors can easily be combined with planetary gearboxes to form compact coaxial drive units. The gearboxes are flanged directly at the DE of the motors.

When selecting the gearbox, ensure that its maximum permissible input speed is not exceeded by the maximum speed of the motor. In the case of high operating frequencies, allowance must be made for the withstand ratio f_z . The frictional losses of the gearbox must always be taken into account when engineering geared drives.

The gearboxes are only available in a non-balanced design.

Benefits

- High efficiency:
 - > 97% single-stage
 - > 94% 2-stage
- Minimum torsional play:
 - ≤ 4 arcmin single-stage
 - ≤ 6 arcmin 2-stage
- Power transmission from the central sun wheel to the planetary pinions
- No shaft deflections in the planetary pinions set due to the symmetrical force distribution
- Very low moment of inertia and hence short acceleration times of the motors
- Output shaft bearings dimensioned for high cantilever and axial loads with preloaded tapered-roller bearings
- The gearboxes are connected to the motor shaft via an integrated clamping hub A plain motor shaft end is necessary for this purpose. Radial eccentricity tolerance N in accordance with DIN 42955 and vibration severity grade A in accordance with EN 60034-14 are sufficient. The motor flange is adapted via adapter plates.
- Output shaft of gearbox exactly coaxial with the motor
- The gearboxes are sealed (seal between the gearbox and motor) and filled with oil at the factory. They are lubricated and sealed for their service life. The gearboxes are suitable for all mounting positions.
- Degree of protection of gearbox: IP65
- Small dimensions
- Low weight

Integration

The gearboxes assigned to the individual motors and the gear ratios available for these motor/gearbox combinations are listed in the selection table below. When making a selection, the maximum permissible input speed of the gearbox must be observed (this is the same as the maximum motor speed).

The motor/gearbox combinations listed in the following selection tables are mainly intended for cyclic operation S3 - 60% (ON period \leq 60% and \leq 20 min). Reduced maximum motor speeds and output torques apply for use in S1 continuous duty (ON period $>$ 60% or $>$ 20 min). The gearbox temperature may not exceed 90 °C

1FK7 motors for gearbox mounting must be implemented as follows:

- Plain motor shaft extension
- Protection class IP65
- Paint finish
 - paint finish is required for 1FK702 motors
 - 1FK703 to 1FK710 motors are only available, painted

5.5.2.2 Selection and ordering data, series SP+

Selection and ordering data, single-stage planetary gear, SP+ series

Motor Type	Planetary gearbox single-stage			Available gear ratio $i =$				Motor speed, max. S3-60 % n_{G1} (n_1) rpm	Output torque, max. S3-60 % M_{G2} (T_{2B}) Nm (lb _f -ft)	Radial output shaft loading, max. ¹⁾ F_r (F_{2Rmax}) N (lb _f)	Axial output shaft loading, max. ¹⁾ F_a (F_{2Amax}) N (lb _f)
	Type	Torsional backlash arcmin	Gearbox weight, approx. kg (lb)	4	5	7	10				
1FK7022	SP 060S-MF1	≤ 4	1.9 (4.2)	✓	✓	✓	✓	6000	40 (295) (32 for $i = 10$)	2700 (607)	2400 (540)
1FK7032				✓	✓	✓	✓				
1FK7033				✓	✓	✓	✓				
1FK7034				✓	✓	✓	✓				
1FK7040	SP 075S-MF1	≤ 4	3.9 (8.6)	✓	✓	✓	✓	6000	110 (81.1) (90 for $i = 10$)	4000 (899)	3350 (753)
1FK7042				✓	✓	✓	✓				
1FK7043				✓	✓	✓	✓				
1FK7044				✓	✓	✓	✓				
1FK7060	SP 100S-MF1	≤ 3	7.7 (17.0)	✓	✓	✓	✓	4500	300 (221) (225 for $i = 10$)	6300 (1416)	5650 (1270)
1FK7061				✓	✓	✓	✓				
1FK7062				✓	✓	✓	✓				
1FK7063				✓	✓	✓	✓				
1FK7064				✓	✓	✓	✓				
1FK7080	SP 140S-MF1	≤ 3	17.2 (37.9)	✓	✓	✓	✓	4000	600 (442) (480 for $i = 10$)	9450 (2124)	9870 (2219)
1FK7081				✓	✓	✓	✓				
1FK7083				✓	✓	✓	✓				
1FK7084				✓	✓	✓	✓				
1FK7085				✓	✓	✓	✓				
1FK7086				✓	✓	✓	✓				
1FK7100	SP 180S-MF1	≤ 3	34 (75.0)	✓	✓	✓	✓	3500	1100 (810) (880 for $i = 10$)	14700 (3305)	14150 (3181)
1FK7101				✓	✓	✓	✓				
1FK7103				✓	✓	✓	✓				
1FK7105				✓	✓	✓	-				
1FK7105	SP 210S-MF1	≤ 3	56 (123)	-	-	-	✓	2500	2500 (1844) (2400 for $i = 7$ 1900 for $i = 10$)	21000 (4721)	30000 (6744)
	Gear shaft			Order code							
	With fitted key			J02	J03	J05	J09				
	Without fitted key			J22	J23	J25	J29				

Preconditions:

With the following motor versions, SP+ planetary gearboxes can be mounted:

- Plain motor shaft extension, shaft and flange accuracy tolerance N, without/with holding brake
- IP65 degree of protection

SP+ planetary gearboxes can therefore only be ordered with these 1FK7 motors:

1FK7□□□-□□□□1-1□G1

1FK7□□□-□□□□1-1□H1

for 1FK702□: 1FK702□-□□□□1-1□G5

1FK702□-□□□□1-1□H5

✓ Possible

- Not possible

¹⁾ In reference to the output shaft center.

When ordering a motor with gearbox, **-Z** should be added to the order number.

Example:

1FK7042 motor without holding brake with single-stage SP+ planetary gearbox with $i = 7$ and gear shaft without fitted key.
1FK7042-2AF71-1AG5-**Z**; **J25**

Technical data, single-stage planetary gear, SP+ series

Planetary gearbox with 1FK7 motor									
Single-stage Type	Gear ratio	Motor speed	Output torque	Moments of inertia of gearbox (referred to the drive)					
				Continuous duty S1 ¹⁾	1FK702	1FK703.	1FK704.	1FK706.	1FK708.
		n_{N1}	$M_{N2} (T_{2N})$	J_1	J_1	J_1	J_1	J_1	J_1
		rpm	Nm (lb _F -ft)	kgcm ² (lb _F -in ²)	kgcm ² (lb _F -in ²)	kgcm ² (lb _F -in ²)	kgcm ² (lb _F -in ²)	kgcm ² (lb _F -in ²)	kgcm ² (lb _F -in ²)
SP 060S-MF1	4	3300	26 (19.2)	0.15 (0.05)	0.22 (0.08)	-	-	-	-
	5	3300	26 (19.2)	0.12 (0.04)	0.20 (0.07)	-	-	-	-
	7	4000	26 (19.2)	0.10 (0.03)	0.18 (0.06)	-	-	-	-
	10	4000	17 (12.5)	0.09 (0.03)	0.17 (0.06)	-	-	-	-
SP 075S-MF1	4	2900	75 (55.3)	-	-	0.78 (0.27)	-	-	-
	5	2900	75 (55.3)	-	-	0.68 (0.23)	-	-	-
	7	3100	75 (55.3)	-	-	0.59 (0.20)	-	-	-
	10	3100	52 (38.4)	-	-	0.54 (0.19)	-	-	-
SP 100S-MF1	4	2500	180 (133)	-	-	-	3.04 (1.04)	-	-
	5	2500	175 (129)	-	-	-	2.61 (0.89)	-	-
	7	2800	170 (125)	-	-	-	2.29 (0.78)	-	-
	10	2800	120 (88.5)	-	-	-	2.07 (0.71)	-	-
SP 140S-MF1	4	2100	360 (265)	-	-	-	-	11.0 (3.76)	-
	5	2100	360 (265)	-	-	-	-	9.95 (3.40)	-
	7	2600	360 (265)	-	-	-	-	9.01 (3.08)	-
	10	2600	220 (162)	-	-	-	-	8.44 (2.88)	-
SP 180S-MF1	4	1500	750 (553)	-	-	-	-	-	33.9 (11.6)
	5	1500	750 (553)	-	-	-	-	-	27.9 (9.53)
	7	2300	750 (553)	-	-	-	-	-	22.2 (7.59)
	10	2300	750 (553)	-	-	-	-	-	19.2 (6.56)
SP 210S-MF1	10	2000	1000 (738)	-	-	-	-	-	53.1 (18.1)

¹⁾ The limit values in the table apply for S1 continuous duty (ON time > 60 % or > 20 min) for a maximum gearbox temperature of 90 °C (194 °F).

Selection and ordering data, 2-stage planetary gear, SP+ series

Motor Type	Planetary gearbox two-stage			Available gear ratio $i =$					Motor speed, max. S3-60 % n_{G1} (n_1) rpm	Output torque, max. S3-60 % M_{G2} (T_{2B}) Nm (lb _f -ft)	Radial output shaft loading, max. ¹⁾ F_r (F_{2Rmax}) N (lb _f)	Axial output shaft loading, max. ¹⁾ F_a (F_{2Amax}) N (lb _f)							
	Type	Torsional backlash arcmin	Gearbox weight, approx. kg (lb)	16	20	28	40	50											
1FK7022	SP 060S-MF2	≤ 6	2 (4.41)	✓	✓	✓	-	-	6000	40 (29.5)	2700 (607)	2400 (540)							
1FK7032				✓	✓	-	-	-											
1FK7033				✓	✓	-	-	-											
1FK7022	SP 075S-MF2	≤ 6	3.6 (7.9)	-	-	-	✓	✓	6000	110 (81.1)	4000 (899)	3350 (753)							
1FK7032				-	-	✓	✓	✓											
1FK7033				-	-	✓	✓	✓											
1FK7034				✓	✓	✓	-	-											
1FK7040				✓	✓	✓	-	-											
1FK7042				✓	✓	-	-	-											
1FK7043				✓	-	-	-	-											
1FK7034	SP 100S-MF2	≤ 5	7.9 (17.4)	-	-	-	✓	✓	4500	300 (221)	6300 (1416)	2400 (540)							
1FK7040				-	-	-	✓	✓											
1FK7042				-	-	✓	✓	✓											
1FK7043				-	✓	✓	✓	✓											
1FK7044				✓	✓	✓	✓	-											
1FK7060				✓	✓	✓	-	-											
1FK7061				✓	✓	-	-	-											
1FK7062				✓	✓	-	-	-											
1FK7044				SP 140S-MF2	≤ 5	17 (37.5)	-	-					-	-	✓	4000	600 (442)	9450 (2124)	9870 (2219)
1FK7060							-	-					-	✓	✓				
1FK7061	-	-	✓				✓	✓											
1FK7062	-	-	✓				✓	-											
1FK7063	✓	✓	✓				-	-											
1FK7064	✓	✓	✓				-	-											
1FK7080	✓	✓	✓				✓	-											
1FK7081	✓	✓	✓				-	-											
1FK7083	✓	✓	-				-	-											
1FK7084	✓	-	-				-	-											
Gear shaft				Order code															
With fitted key				J12	J13	J15	J16	J17											
Without fitted key				J32	J33	J35	J36	J37											

Preconditions:

With the following motor versions, SP+ planetary gearboxes can be mounted:

- Plain motor shaft extension, shaft and flange accuracy tolerance N, without/with holding brake
- IP65 degree of protection

SP+ planetary gearboxes can therefore only be ordered with these 1FK7 motors:

1FK7□□□-□□□□1-1□G1

1FK7□□□-□□□□1-1□H1

for 1FK702□: 1FK702□-□□□□1-1□G5

1FK702□-□□□□1-1□H5

When ordering a motor with gearbox, **-Z** should be added to the order number.

Example:

1FK7042 motor without holding brake with single-stage SP+ planetary gearbox with $i = 7$ and gear shaft without fitted key.
1FK7042-2AF71-1AG5-Z; J25

✓ Possible

- Not possible

¹⁾ Referred to the center of the output shaft at 100 rpm.

5.5 Gearbox

Motor Type	Planetary gearbox two-stage			Available gear ratio $i =$					Motor speed, max. S3-60 % n_{G1} (n_1) rpm	Output torque, max. S3-60 % M_{G2} (T_{2B}) Nm (lb _F -ft)	Radial output shaft loading, max. ¹⁾ F_r (F_{2Rmax}) N (lb _f)	Axial output shaft loading, max. ¹⁾ F_a (F_{2Amax}) N (lb _f)
	Type	Torsional backlash arcmin	Gearbox weight, approx. kg (lb)	16	20	28	40	50				
1FK7062 1FK7063 1FK7064	SP 180S-MF2	≤ 5	36.4 (80.3)	-	-	-	-	✓	4000	1100 (811)	14700 (3305)	14150 (3181)
1FK7080				-	-	-	-	✓				
1FK7081				-	-	-	-	✓				
1FK7083				-	-	✓	-	-				
1FK7084				-	✓	✓	-	-				
1FK7085				✓	✓	-	-	-				
1FK7086				✓	✓	-	-	-				
1FK7100				✓	✓	✓	-	-				
1FK7101				✓	✓	-	-	-				
1FK7103				✓	-	-	-	-				
1FK7083 1FK7084 1FK7085 1FK7086	SP 210S-MF2	≤ 6	55 (121)	-	-	-	✓	✓	3500	2400 (1770) (2500 for $i = 20$)	21000 (4721)	30000 (6744)
1FK7100				-	-	-	✓	✓				
1FK7101				-	-	✓	-	-				
1FK7103				-	✓	-	-	-				
1FK7105				✓	✓	-	-	-				
1FK7101				-	-	✓	-	-				
1FK7103				-	-	✓	-	-				
1FK7101 1FK7103 1FK7105	SP 240S-MF2	≤ 6	80.6 (178)	-	-	✓	✓	✓	3500	4500 (3319) (4000 for $i = 40$ 4300 for $i = 50$)	30000 (6744)	33000 (7419)
1FK7103				-	-	✓	✓	-				
1FK7105				-	-	✓	-	-				
Gear shaft				Order code								
With fitted key				J12	J13	J15	J16	J17				
Without fitted key				J32	J33	J35	J36	J37				

Preconditions:

With the following motor versions, SP+ planetary gearboxes can be mounted:

- Plain motor shaft extension, shaft and flange accuracy tolerance N, without/with holding brake
- IP65 degree of protection

SP+ planetary gearboxes can therefore only be ordered with these 1FK7 motors:

1FK7□□□-□□□□1-1□G1
 1FK7□□□-□□□□1-1□H1
 for 1FK702□: 1FK702□-□□□□1-1□G5
 1FK702□-□□□□1-1□H5

- ✓ Possible
- Not possible

¹⁾ In reference to the output shaft center.

When ordering a motor with gearbox, **-Z** should be added to the order number.

Example:

1FK7042 motor without holding brake with single-stage SP+ planetary gearbox with $i = 7$ and gear shaft without fitted key.
 1FK7042-2AF71-1AG5-Z; J25

Technical data, 2-stage planetary gear, SP+ series

Planetary gearbox with 1FK7 motor									
Two-stage Type	Gear ratio	Motor speed	Output torque	Moments of inertia of gearbox (referred to the drive)					
				Continuous duty S1 ¹⁾	1FK702	1FK703.	1FK704.	1FK706.	1FK708.
		n_{N1}	$M_{N2} (T_{2N})$	J_1	J_1	J_1	J_1	J_1	J_1
		rpm	Nm (lb _F ft)	kgcm ² (lb _F in ²)	kgcm ² (lb _F in ²)	kgcm ² (lb _F in ²)	kgcm ² (lb _F in ²)	kgcm ² (lb _F in ²)	kgcm ² (lb _F in ²)
SP 060S-MF2	16	4400	26 (19.2)	0.08 (0.03)	0.17 (0.06)	–	–	–	–
	20	4400	26 (19.2)	0.07 (0.02)	0.16 (0.06)	–	–	–	–
	28	4400	26 (19.2)	0.06 (0.02)	–	–	–	–	–
SP 075S-MF2	16	3500	75 (55.3)	–	0.23 (0.08)	0.55 (0.19)	–	–	–
	20	3500	75 (55.3)	–	0.20 (0.07)	0.53 (0.19)	–	–	–
	28	3500	75 (55.3)	–	0.18 (0.06)	0.50 (0.17)	–	–	–
	40	3500	75 (55.3)	0.10 (0.03)	0.17 (0.06)	–	–	–	–
	50	3800	75 (55.3)	0.10 (0.03)	0.16 (0.06)	–	–	–	–
SP 100S-MF2	16	3100	180 (132)	–	–	0.81 (0.28)	2.18 (0.75)	–	–
	20	3100	180 (132)	–	–	0.70 (0.24)	2.07 (0.71)	–	–
	28	3100	180 (132)	–	–	0.60 (0.20)	1.97 (0.67)	–	–
	40	3100	180 (132)	–	0.38 (0.13)	0.55 (0.19)	–	–	–
	50	3500	175 (129)	–	0.38 (0.13)	0.54 (0.19)	–	–	–
SP 140S-MF2	16	2900	360 (266)	–	–	–	3.19 (1.09)	10.3 (3.52)	–
	20	2900	360 (266)	–	–	–	2.71 (0.93)	9.77 (3.34)	–
	28	2900	360 (266)	–	–	–	2.34 (0.80)	9.41 (3.22)	–
	40	2900	360 (266)	–	–	–	2.10 (0.72)	9.16 (3.13)	–
	50	3200	360 (266)	–	–	1.39 (0.48)	2.08 (0.71)	–	–
SP 180S-MF2	16	2700	750 (553)	–	–	–	–	12.4 (4.24)	13.5 (4.61)
	20	2700	750 (553)	–	–	–	–	10.9 (3.73)	12.0 (4.10)
	28	2700	750 (553)	–	–	–	–	9.48 (3.24)	10.6 (3.62)
	40	2700	750 (553)	–	–	–	5.51 (1.88)	8.67 (2.96)	–
	50	2900	750 (553)	–	–	–	5.45 (1.86)	8.61 (2.94)	–
SP 210S-MF2	16	2500	1500 (1106)	–	–	–	–	–	34.5 (11.8)
	20	2500	1500 (1106)	–	–	–	–	–	31.5 (10.8)
	28	2500	1500 (1106)	–	–	–	–	30.0 (10.3)	30.0 (10.3)
	40	2500	1500 (1106)	–	–	–	–	28.5 (9.74)	28.5 (9.74)
	50	2500	1500 (1106)	–	–	–	–	28.3 (9.67)	28.3 (9.67)
SP 240S-MF2	28	2500	2500 (1844)	–	–	–	–	–	30.5 (10.4)
	40	2500	2500 (1844)	–	–	–	–	–	28.2 (9.64)
	50	2500	2500 (1844)	–	–	–	–	–	27.9 (9.53)

¹⁾ The limit values in the table apply for S1 continuous duty (ON time > 60 % or > 20 min) for a maximum gearbox temperature of 90 °C (194 °F).

5.5.2.3 Characteristics of the LP+ series

Overview

1FK7 motors can be combined with planetary gears to form compact coaxial drive units. The gearboxes are flanged directly at the DE of the motors.

When selecting the gearbox, ensure that its maximum permissible input speed is not exceeded by the maximum speed of the motor. In the case of high operating frequencies, allowance must be made for the withstand ratio f_2 . The frictional losses of the gearbox must always be taken into account when engineering geared drives.

The gearboxes are only available in a non-balanced design and with fitted key.

Benefits

- High efficiency, single-stage: > 97 %
- Minimal torsional backlash, 1-stage: ≤ 12 arcmin
- Power transmission from the central sun wheel to the planet wheels
- No shaft deflections in the planet wheel set as the force is symmetrically distributed
- The gearboxes are connected to the motor shaft via an integrated clamping hub A plain motor shaft end is necessary for this purpose. Radial eccentricity tolerance N in accordance with DIN 42955 and vibration severity grade A in accordance with EN 60034-14 are sufficient. The motor flange is adapted via adapter plates
- Output shaft of gearbox exactly coaxial with the motor
- The gearboxes are suitable for all mounting positions
- The gearboxes are sealed (seal between gearbox and motor) and filled with grease in the factory. They are lubricated and sealed for their service life.
- Degree of protection of gearbox: IP64
- Small dimensions
- Low weight

Integration

1FK702□ to 1FK710□ synchronous motors can be supplied ex works (SIEMENS) complete with a flange-mounted planetary gearbox.

The gearboxes assigned to the individual motors as well as the gearbox ratios, available for these motor-gearbox combinations are listed in the Selection and ordering data table. When making a selection, the maximum permissible input speed of the gearbox must be observed (this is the same as the maximum motor speed).

The motor/gearbox combinations listed in the selection tables are mainly intended for cyclic operation S3 - 60% (ON period \leq 60% and \leq 20 min). Reduced maximum motor speeds and output torques apply for use in S1 continuous duty (ON period $>$ 60% or $>$ 20 min). The gearbox temperature may not exceed 90 °C

1FK7 motors for gearbox mounting must be implemented as follows:

- Plain motor shaft extension
- Degree of protection IP64
- Paint finish
 - paint finish is required for 1FK702 motors
 - 1FK703 to 1FK710 motors are only available, painted

5.5 Gearbox

5.5.2.4 Selection and ordering data, series LP+

Motor Type	Planetary gearbox LP+ single-stage Torsional backlash ≤ 12 arcmin		Available gear ratio i =		Input speed, max. S3-60 %	Output torque, max. S3-60 %		Output shaft radial force, max. ¹⁾	Gearbox moment of inertia
	Type	Gearbox weight, approx. kg (lb)	5	10	n _{G1} rpm	M _{G2} at i = 5 Nm (lb _f -ft)	M _{G2} at i = 10 Nm (lb _f -ft)	F _r N (lb _f)	J _G at i = 5/10 10 ⁻⁴ kgm ² (10 ⁻³ lb _f -in-s ²)
1FK7022	LP 050-MO1	0.75 (1.65)	✓	–	8000	12 (8.9)	11 (8.1)	650 (146)	0.055 (0.05)
1FK7022	LP 070-MO1	2 (4.41)	–	✓	6000	35 (25.8)	32 (23.6)	1450 (326)	0.28 (0.25)
1FK7032			✓	✓					
1FK7033			✓	✓					
1FK7034			✓	✓					
1FK7040	LP 090-MO1	4 (8.82)	✓	✓	6000	90 (66.4)	80 (59.0)	1900 (427)	1.77 (1.57)
1FK7042			✓	✓					
1FK7043			✓	✓					
1FK7044			✓	✓					
1FK7060	LP 120-MO1	8.6 (19.0)	✓	✓	4800	220 (162)	200 (148)	4000 (899)	5.42 (4.80)
1FK7061			✓	✓					
1FK7062			✓	✓					
1FK7063			✓	✓					
1FK7064			✓	–					
1FK7080	LP 155-MO1	17 (37.5)	✓	✓	3600	450 (332)	350 (258)	6000 (1349)	25.7 (22.8)
1FK7081			✓	✓					
1FK7083			✓	✓					
1FK7084			✓	✓					
1FK7085			✓	✓					
1FK7086			✓	✓					
1FK7100			✓	✓					
1FK7101	✓	–							
1FK7103	✓	–							
1FK7105	✓	–							
Gear shaft With fitted key		Order code V40 V42							

Preconditions:

With the following motor versions, LP+ planetary gearboxes can be mounted:

- Plain motor shaft extension, shaft and flange accuracy tolerance N, without/with holding brake
- IP64 degree of protection

LP+ planetary gearbox can therefore only be ordered with these 1FK7 motors:

1FK7□□□-□□□□1-1□G0
 1FK7□□□-□□□□1-1□H0
 for 1FK702□: 1FK702□-□□□□1-1□G3
 1FK702□-□□□□1-1□H3

When ordering a motor with gearbox, **-Z** should be added to the order number.

Example:

1FK7042 motor with holding brake with single-stage LP+ planetary gearbox with i = 5 and gear shaft with fitted key.
 1FK7042-3BK71-1AH0-Z; V40

Continuous duty

Continuous duty is permissible at the rated speed and rated torque. The gearbox temperature may not exceed 90 °C (194 °F).

Planetary gearbox LP+ single-stage Torsional backlash ≤ 12 arcmin	Rated input speed	Rated output torque	
Type	n _{G1}	M _{G2} at i = 5	M _{G2} at i = 10
	rpm	Nm (lb _f -ft)	Nm (lb _f -ft)
LP 050-MO1	4000	5.7 (4.2)	–
LP 070-MO1	3700	18 (13.3)	16.5 (12.2)
LP 090-MO1	3400	45 (33.2)	40 (29.5)
LP 120-MO1	2600	110 (81.1)	100 (73.8)
LP 155-MO1	2000	320 (236)	190 (140)

✓ Possible

– Not possible

¹⁾ Referred to the center of the output shaft at 100 rpm.

5.6 Drive coupling

Function description

In order to achieve optimum drive-out characteristics, ROTEX® GS couplings supplied by KTR should be used. The advantages of ROTEX® GS couplings include:

- 2 to 4x torsional stiffness of a belt-driven gearbox
- No intermeshing teeth (when compared to belt gearboxes)
- Low moment of inertia
- Good control behavior

They must be optimally harmonized with existing machine masses, the mounted mechanical system, the machine stiffness, etc.

KTR provides assistance in the selection of the coupling, refer to <http://www.ktr.com>

Connection system

6.1 SINAMICS drive I/O

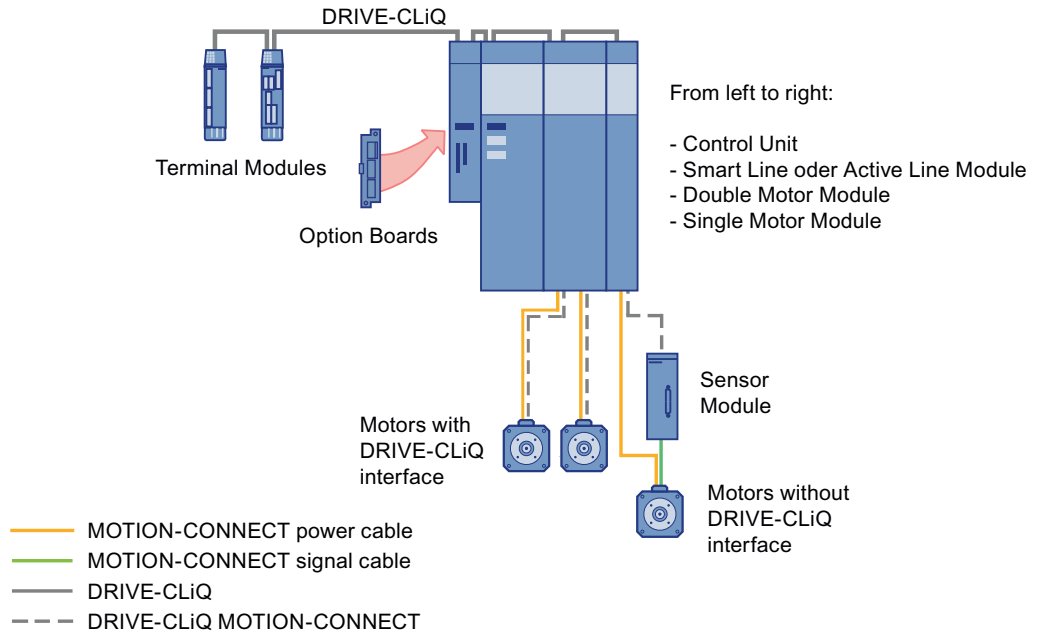



Figure 6-1 Example: SINAMICS S120 system overview

6.2 Power connection

 WARNING
Before carrying out any work on the motor, please ensure that it is powered-down and the system is locked-out so that the motor cannot re-start!
The motors are not designed to be connected directly to the line supply.

Connection assignment, power connector at the motor

Power connections U, V, W
Brake connection BD1+, BD2- (only when ordered)

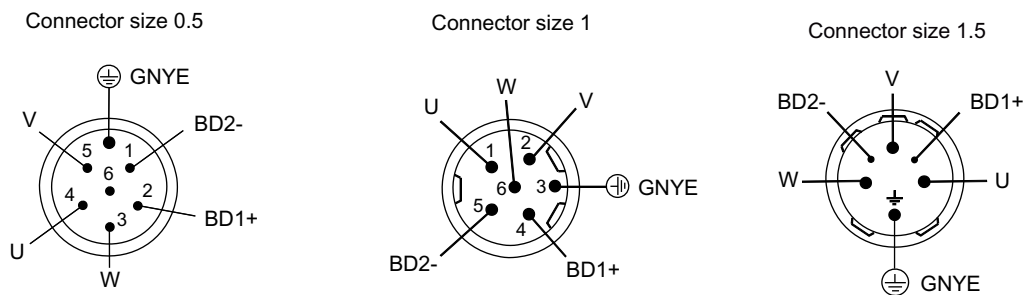

Figure 6-2 Power connection

Connecting-up notes

The overall system compatibility is only guaranteed when using shielded power cables.

Shields must be incorporated in the protective grounding concept. Protective ground should be connected to conductors that are open-circuit and that are not being used and also electrical cables that can be touched. If the brake feeder cables in the SIEMENS cable accessories are not used, then the brake conductor cores and shields must be connected to the cabinet ground (open-circuit cables result in capacitive charges!).

Connecting cables should be appropriately strain relieved.

Current-carrying capacity for power and signal cables

The current-carrying capacity of PVC/PUR-insulated copper cables is specified for routing types B1, B2 and C under continuous operating conditions in the table with reference to an ambient air temperature of 40 °C. For other ambient temperatures, the values must be corrected by the factors from the "Derating factors" table.

Table 6- 1 Cable cross section and current-carrying capacity

Cross section [mm ²]	Current-carrying capacity rms; AC 50/60 Hz or DC for routing type		
	B1 [A]	B2 [A]	C [A]
Electronics (according to EN 60204-1)			
0.20	-	4.3	4.4
0.50	-	7.5	7.5
0.75	-	9	9.5
Power (according to EN 60204-1)			
0.75	8.6	8.5	9.8
1.00	10.3	10.1	11.7
1.50	13.5	13.1	15.2
2.50	18.3	17.4	21
4	24	23	28
6	31	30	36
10	44	40	50
16	59	54	66
25	77	70	84
35	96	86	104
50	117	103	125

1) Extrapolated values

Table 6- 2 Derating factors for power and signal cables

Ambient air temperature [°C]	Derating factor according to EN 60204-1 Table D1
30	1.15
35	1.08
40	1.00
45	0.91
50	0.82
55	0.71
60	0.58

6.3 Signal connection

DRIVE-CLiQ is the preferred method for connecting the encoder systems to SINAMICS.

Motors with a DRIVE-CLiQ interface can be ordered for this purpose. Motors with a DRIVE-CLiQ interface can be directly connected to the associated motor module via the available MOTION-CONNECT DRIVE-CLiQ cables. The MOTION-CONNECT DRIVE-CLiQ cable is connected to the motor in degree of protection IP67. The DRIVE-CLiQ interface supplies power to the motor encoder via the integrated 24 VDC supply and transfers the motor encoder and temperature signals and the electronic type plate data, e.g. a unique identification number, rating data (voltage, current, torque) to the control unit. The MOTION-CONNECT DRIVE-CLiQ cable is used universally for connecting the various encoder types. These motors simplify commissioning and diagnostics, as the motor and encoder type are identified automatically.

Encoder connection on motors with DRIVE-CLiQ

Motors with DRIVE-CLiQ can be directly connected to the corresponding Motor Module via the available DRIVE-CLiQ cables (MOTION-CONNECT). This data is transferred directly to the Control Unit.

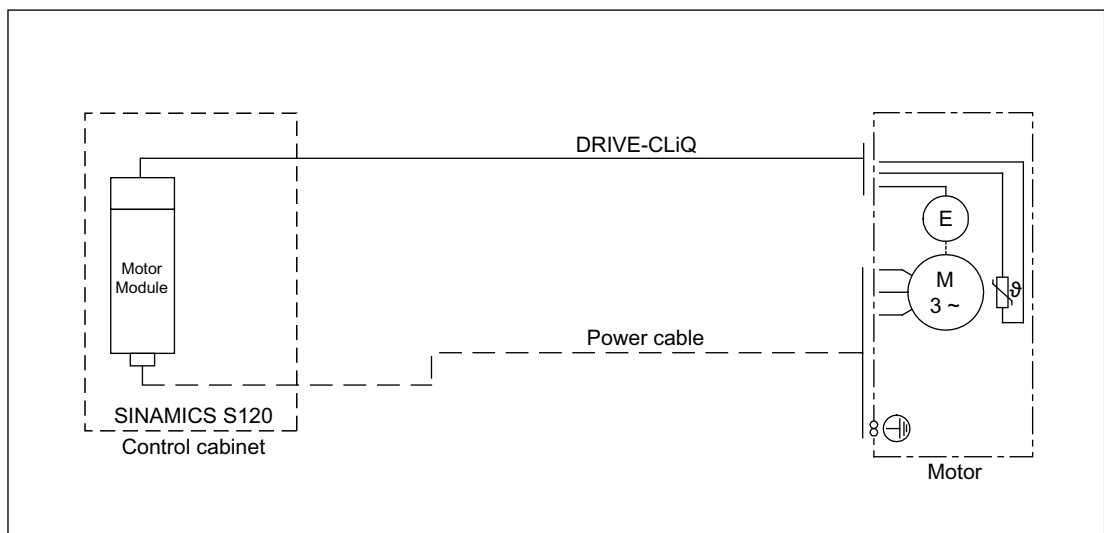

Figure 6-3 Example: Encoder interface with DRIVE-CLiQ

Cables on motors with DRIVE-CLiQ

With DRIVE-CLiQ, the same cable is used for all encoder types. Only prefabricated cables from Siemens (MOTION-CONNECT) may be used.

Table 6-3 Prefabricated cable

6FX	□	002	-	□DC□□	-	□□ □	0
	↓ ↓					↓↓↓	
	5 MOTION-CONNECT 500				Length max. cable length 100 m		
	8 MOTION-CONNECT 800				max. cable length 50 m		

Encoder connection on motors without DRIVE-CLiQ

If a motor is not equipped with a DRIVE-CLiQ interface, the speed encoder and temperature sensor are connected via a signal connector.

Motors without DRIVE-CLiQ require a Sensor Module Cabinet (SMC) for operation with a SINAMICS S110 / S120 drive system. The motor is connected to the SMC via a signal line. The SMC is connected to the Motor Module via a DRIVE-CLiQ cable (MOTION-CONNECT).

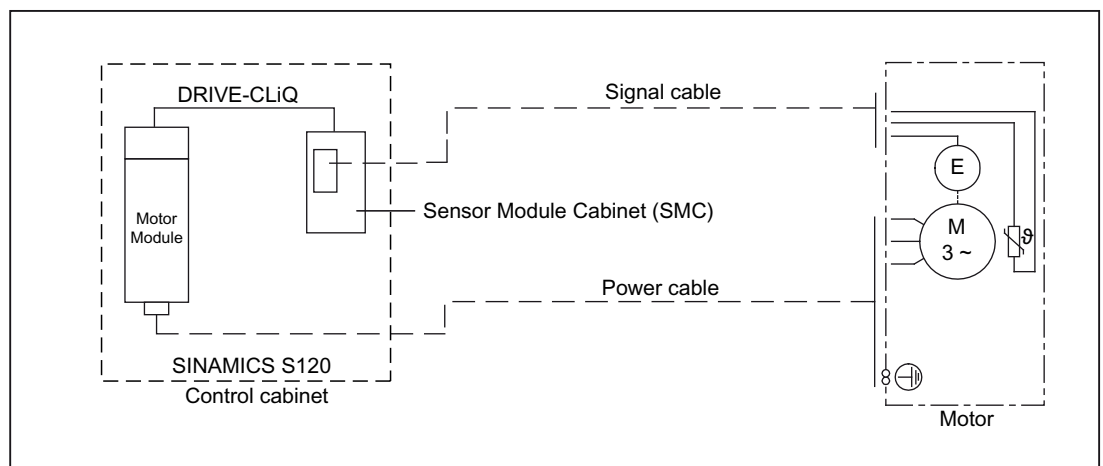
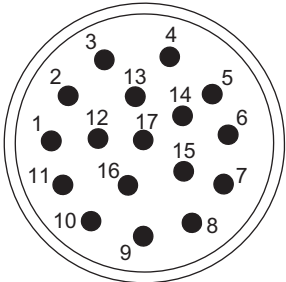

Figure 6-4 Example: Encoder interface without DRIVE-CLiQ

Incremental encoder and absolute encoder without DRIVE-CLiQ

Table 6- 4 Pin assignment for 17-pin angle plug with pin contacts

PIN No.	Incremental encoders	Absolute encoders				When viewing the plug-in side (pins)
	IC2048S/R	AM2048S/R	AM512S/R	AM32S/R	AM16S/R	
1	A	A				
2	A*	A*				
3	R	data				
4	D*	not connected				
5	C	clock				
6	C*	not connected				
7	M encoder	M encoder				
8	+1R1	+1R1				
9	-1R2	-1R2				
10	P encoder	P encoder				
11	B	B				
12	B*	B*				
13	R*	data*				
14	D	clock*				
15	0 V sense	0 V sense				
16	5 V sense	5 V sense				
17	not connected	not connected				

Resolver without DRIVE-CLiQ

Table 6- 5 Connection assignment for 12/17-pin flange socket

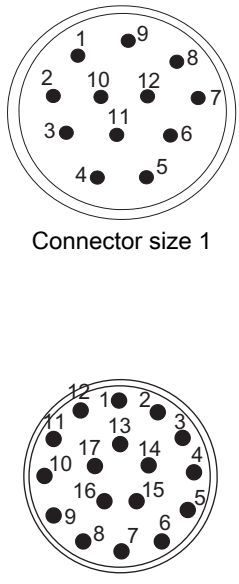
PIN No.	Description of the signals		When viewing the plug-in side (pins)
	12-pin Connector size 1 for 1FK702□ to 1FK710□	17-pin Connector size 0.5 for 1FK701□	
1	S2	+1R1	 <p>Connector size 1</p> <p>Connector size 0.5</p>
2	S4	-1R2	
3	not connected	not connected	
4	not connected	S1	
5	not connected	S3	
6	not connected	not connected	
7	R2	S2	
8	+1R1	S4	
9	-1R2	not connected	
10	R1	R1	
11	S1	R2	
12	S3	not connected	
13	---	not connected	
14	---	not connected	
15	---	not connected	
16	---	not connected	
17	---	not connected	

Cables on motors without DRIVE-CLiQ

It is recommended to use prefabricated cables from Siemens (MOTION-CONNECT). These offer many advantages over cables made by other manufacturers in terms of operational reliability, quality, and cost.

Table 6- 6 Cables

Motor	Connector type	Connector size	Cables ⁴⁾ Incremental encoder	Cables ⁴⁾ Absolute encoder	Cables ⁴⁾ Resolver
1FK701	SPEED-CONNECT	0.5	6FX□002-2CN20-□□□0 ²⁾	6FX□002-2EN20-□□□0 ²⁾	6FX□002-2FN20-□□□0 ¹⁾
1FK702	Union nut	1	6FX□002-2CA31-□□□0 ¹⁾	6FX□002-2EG10-□□□0 ¹⁾	6FX□002-2CF02-□□□0 ³⁾
1FK703 1FK704 1FK706 1FK708 1FK710	SPEED-CONNECT	1	6FX□002-2CQ31-□□□0 ¹⁾	6FX□002-2EQ31-□□□0 ¹⁾	-

1) Max. cable length 100 m

2) Max. cable length 50 m

3) Max. cable length resolver multi-pole 50 m, 2-pole resolver 130 m

4) 6FX5 = MOTION-CONNECT 500, 6FX8 = MOTION CONNECT 800

For other technical data and length code, refer to Catalog, Chapter "MOTION-CONNECT connection system"

6.4 Quick-release lock

The motors can be connected via a quick-release catch (SPEED-CONNECT). The motor connectors are designed in such a way that both the new quick-release lock cables and the conventional cables with screw-type connection can be used.

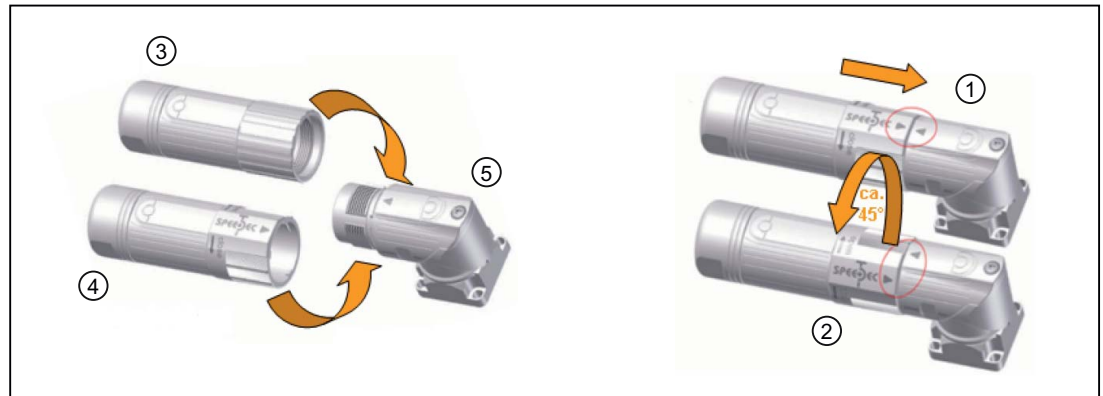

- 1+2 Establishing a contact with the SPEED-CONNECT connector
- 3 Screw-type connection
- 4 SPEED-CONNECT
- 5 Motor connectors with SPEED-CONNECT

Figure 6-5 Quick-release lock

6.5 Rotating the connector at the motor

Power connectors and signal connectors can be rotated to a limited extent. A suitable socket connector can be used to rotate the angle plug. The socket connector must be completely screwed on in order to avoid damaging the pin contacts. For encoders with integrated Sensor Modules (DQI) the cable outlet towards the top is fixed and cannot be changed.

NOTICE

Rotating the connectors

- It is not permissible that the specified rotation range is exceeded.
- In order to guarantee the degree of protection, max. 10 revolutions are permissible.
- Connectors should be rotated using the matching mating connector located on the connector thread. Only rotate Sensor Modules by hand. The use of pipe wrenches, hammers, or similar is not permitted.

6.5 Rotating the connector at the motor

Table 6-7 Direction of rotation and max. torque when rotating

Connectors	Rotation range	Max. torque when rotating
Power connector, size 0.5	270°	8 Nm
Power connector, size 1	270°	12 Nm
Signal connector (without DRIVE-CLiQ)	230° for 1FK701 180° for 1FK702	8 Nm 12 Nm
Signal connector (with DRIVE-CLiQ)	270°	8 Nm

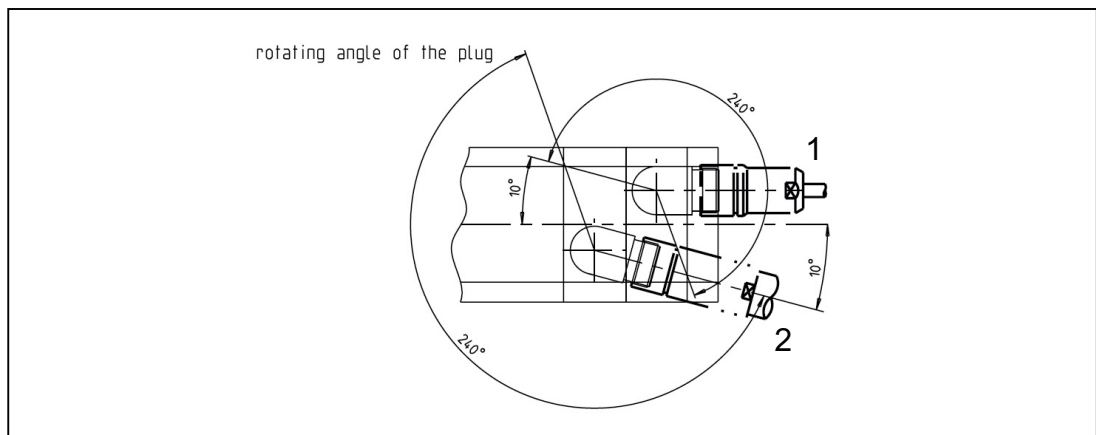

- 1 Signal connector
- 2 Power connector

Figure 6-6 For 1FK701/1FK702 the connector can be rotated

**Ability to rotate the power connector for motors with DRIVE-CLiQ interface without Sensor Modules
1FK7□□□-□□□□□-□X□□; X = B, C, Q, R**

Table 6- 8 Rotation range of the power connector

Motor	Angle α	Angle β	Connector size	Drawing
1FK703	122°	208°	1	
1FK704 1FK706 1FK708 1FK710	135°	195°	1	
1FK708 1FK710	195°	140°	1.5	

**Ability to rotate the connectors for motors without a DRIVE-CLiQ interface and for motors with DRIVE-CLiQ interface via Sensor Modules
1FK7□□□-□□□□□-□X□□; X = A, E, H, D, F, L**

Table 6- 9 Rotation range of the power connector

Motor	Angle α	Angle β	Connector size	Drawing
1FK703	122°	158°	1	
1FK704 1FK706 1FK708	135°	140°	1	
1FK710	135°	195°	1	
1FK708 1FK710	195°	140°	1.5	

6.5 Rotating the connector at the motor

Table 6- 10 Rotation range of the signal connector

Motor	with DRIVE-CLiQ via Sensor Module		connector without DRIVE-CLiQ		Drawing
	Angle α'	Angle β'	Angle α'	Angle β'	
1FK703	160°	130°	160°	135°	See Table, "Power connectors"
1FK704	145°	140°	145°	130°	
1FK706	140°	145°	150°	135°	
1FK708	105°	100°	105°	105°	
1FK710					

Table 6- 11 Max. torque when rotating

Connectors	Max. torque when rotating
Power connector, size 1	12 Nm
Power connector, size 1.5	20 Nm
Signal connector (without DRIVE-CLiQ)	12 Nm
Signal connector (with DRIVE-CLiQ)	8 Nm

Information about using the motors

7.1 Transport / storage before use

The motors should be stored indoors in dry conditions with low-dust and low vibration levels ($v_{\text{eff}} < 0.2$ mm/s). The motors should not be stored longer than two years at room temperature (+5° C to +40° C) to retain the service life of the grease.

Observe the additional notes regarding transport and storage in the operating instructions.

7.2 Environmental conditions

Operating temperature range: -15° C to +40° C (without any restrictions).

All of the catalog data refer to an ambient temperature of 40° C, mounted so that the motors are not thermally insulated and an installation altitude up to 1000 m above sea level.

Under conditions other than those specified above (ambient temperature > 40° C or installation altitude > 1000 m above sea level), the permissible torque/power must be determined using the factors from the following table.

Ambient temperatures and installation altitudes are rounded-off to 5° C or 500 m respectively.

Table 7- 1 Factors to reduce the torque/power (de-rating)

Installation altitude above sea level [m]	Ambient temperature in ° C				
	< 30	30 - 40	45	50	55
1000	1.07	1.00	0.96	0.92	0.87
1500	1.04	0.97	0.93	0.89	0.84
2000	1.00	0.94	0.90	0.86	0.82
2500	0.96	0.90	0.86	0.83	0.78
3000	0.92	0.86	0.82	0.79	0.75
3500	0.88	0.82	0.79	0.75	0.71
4000	0.82	0.77	0.74	0.71	0.67

7.3 Routing cables in a damp environment

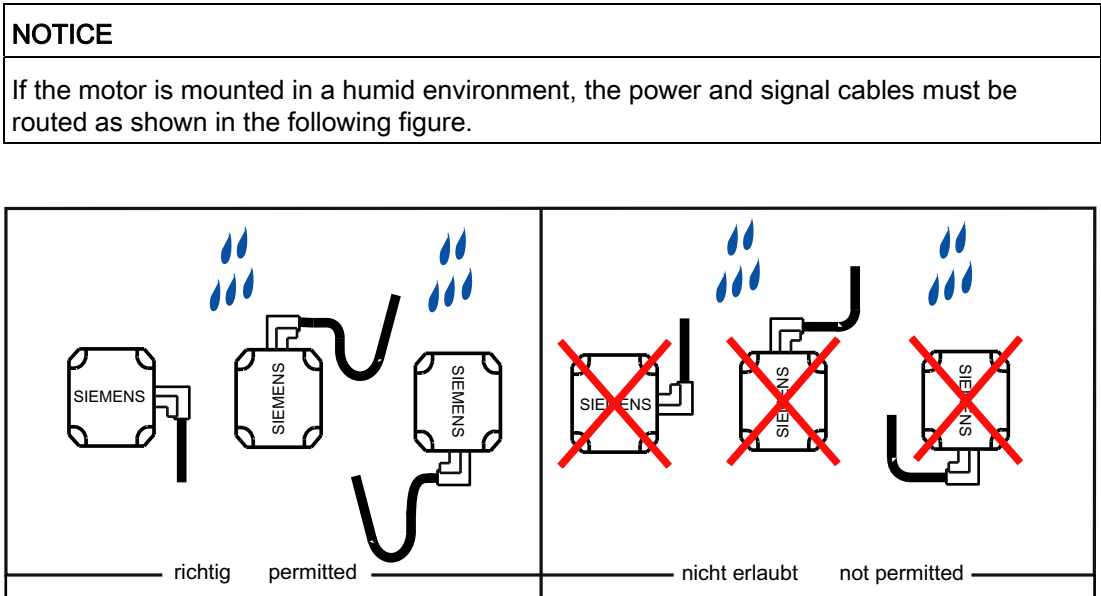
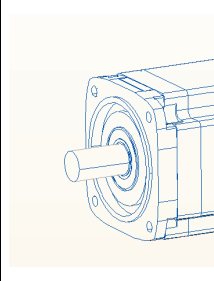
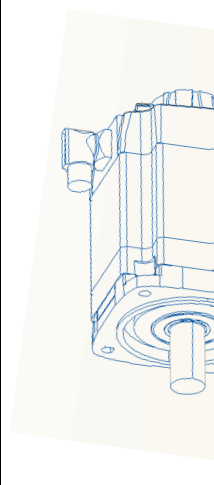
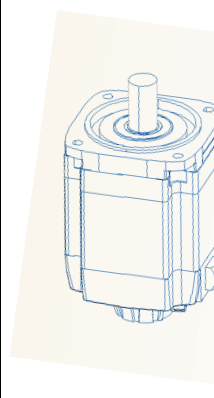

Figure 7-1 Principle cable routing in a moist environment

7.4 Types of construction

Table 7- 2 Designation of types of construction (acc. to IEC 60034-7)

Designation	Representation	Description
IM B5		Standard
IM V1		The 1FK7 motors can be used in types of construction IM V1 and IM V3 without special ordering. Note: When configuring the IM V3 type of construction, attention must be paid to the permissible axial forces (force due to the weight of the drive elements) and especially to the necessary degree of protection.
IM V3		

7.5 Mounting conditions

Some of the motor power loss is dissipated through the flange when the motor is connected to the mounting flange.

Non-thermally insulated mounting

The following mounting conditions apply for the specified motor data:

Table 7-3 Non-thermally insulated mounting conditions

Shaft height	Steel plate, width x height x thickness [mm]	Mounting surface[m ²]
1FK701□	120 x 100 x 10	0.012
1FK702□ to 1FK704□	120 x 100 x 40	0.012
1FK706□ to 1FK710□	450 x 370 x 30	0.17

For larger mounting surfaces, the heat dissipation conditions improve.

Thermally insulated mounting without additionally mounted components

For non-ventilated motors, the motor torque must be reduced by between 5 % and 10 %. We recommend configuring the motor using the $M_{0(60K)}$ values. As the speed increases, the reduction factor rises (see Fig. "Effect of the mounting conditions on the S1 characteristic").

Thermally insulated mounting with additionally mounted components

- Holding brake (integrated in the motor). No additional torque reduction required
- Gearbox; the torque has to be reduced (see Fig. "Effect of the mounting conditions on the S1 characteristics")

Effect of thermally insulated/non-insulated mounting without and with gearbox

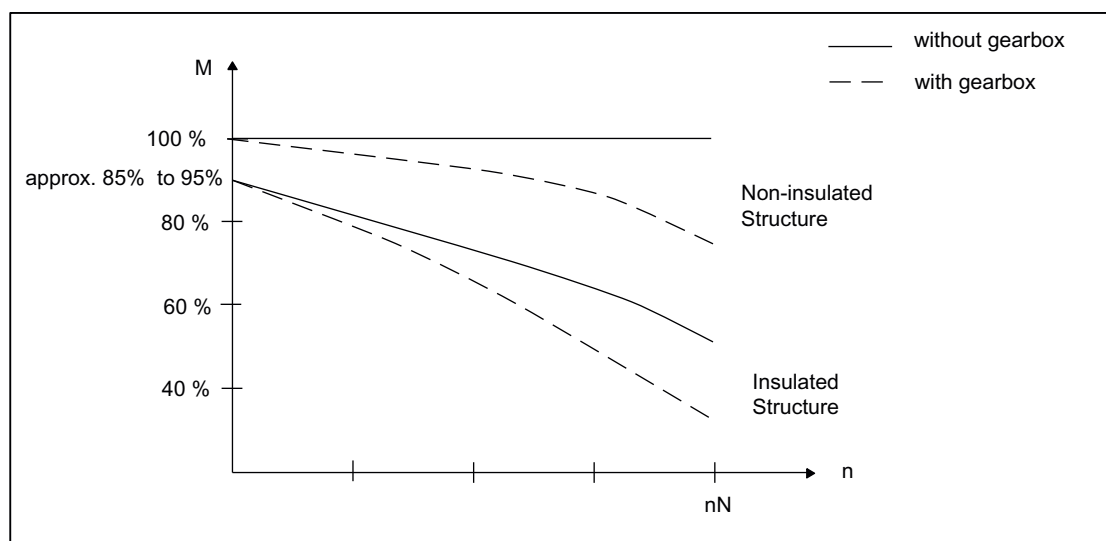

Figure 7-2 Effect of the mounting conditions on the S1 characteristic

7.6 Vibratory load

For perfect function and to comply with the motor specification (particularly the bearing service life) the vibration values specified in the following table must not be exceeded.

Table 7- 4 Vibration values

Vibration speed v_{rms} according to ISO 10816	Max. 4.5 mm/s
Vibration acceleration a_{peak} axial ¹⁾	25 m/s ²
Vibration acceleration a_{peak} radial ¹⁾	50 m/s ²

1) For motors with separately driven fans, the limit value for axial and radial vibration acceleration is limited to 10 m/s².

The measurement points should be selected in accordance with ISO 10816-1 Paragraph 3.2. The vibration values must not exceed the specified limits at any measurement point.

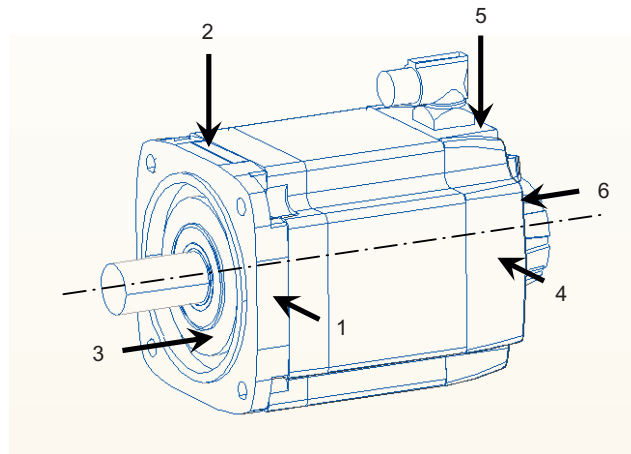

Figure 7-3 Vibration values at the measurement points

The **vibration acceleration** must be measured in a frequency band of 10 to 2000 Hz. The maximum peak value in the time range is to be considered.

To measure the **vibration speed**, the measuring equipment must fulfill the requirements of ISO 2954.

7.7 Permissible line system configurations

In combination with the drive system, the motors are generally approved for operation on TN and TT systems with **grounded neutral** and on IT systems.

In operation on IT systems, the occurrence of a first fault between an active part and ground must be signaled by a monitoring device. In accordance with IEC 60364-4-41 it is recommended that the first fault should be eliminated as quickly as practically possible.

In systems with a **grounded external conductor**, an isolating transformer with grounded neutral (secondary side) must be connected between the line supply and the drive system to protect the motor insulation from excessive stress. The majority of TT systems have a grounded external conductor, so in this case an isolating transformer must be used.

Appendix

A.1 Description of terms

Rated torque M_N

Thermally permissible continuous torque in S1 duty at the rated motor speed.

Rated speed n_N

The characteristic speed range for the motor is defined in the speed-torque diagram by the rated speed.

Rated current I_N

RMS motor phase current for generating the particular rated torque. Specification of the RMS value of a sinusoidal current.

Rated converter current $I_{N\text{ conv}}$

RMS converter output current (per phase) that can be supplied on a continuing basis by the recommended Motor Module. The recommended Motor Module is determined with the stall current I_0 (100K).

Braking torque $M_{br\text{ eff}}$

$M_{br\text{ eff}}$ corresponds to the average braking torque for armature short-circuit braking that is achieved through the upstream braking resistor R_{opt} .

Braking resistance R_{opt}

R_{opt} corresponds to the optimum resistance value per phase that is switched in series external to the motor winding for the armature short-circuit braking function.

DE

Drive end = Drive end of the motor

Cyclic inductance L_D

The cyclic inductance is the sum of the air gap inductance and leakage inductance relative to the single-strand equivalent circuit diagram. It consists of the self-inductance of a phase and the coupled inductance to other phases.

Torque constant k_T (value for a 100 K average winding temperature rise)

Quotient obtained from the static torque and stall current.

Calculation: $k_T = M_{0, 100\text{ K}} / I_{0, 100\text{ K}}$
 The constant applies up to approx. $2 \cdot M_{0, 60\text{ K}}$ in the case of self-cooled motors

Note

This constant is not applicable when configuring the necessary rated and acceleration currents (motor losses!).

The steady-state load and the frictional torques must also be included in the calculation.

Electrical time constant T_{el}

Quotient obtained from the rotating field inductance and winding resistance. $T_{el} = L_D / R_{Str}$

Maximum speed n_{max}

The maximum mechanically permissible operating speed n_{max} is the lesser of the maximum mechanically permissible speed and the maximum permissible speed at the converter.

Maximum torque M_{max}

Torque that is generated at the maximum permissible current. The maximum torque is briefly available for high-speed operations (dynamic response to quickly changing loads).

The maximum torque is limited by the closed-loop control parameters.

Maximum torque (limited by converter) $M_{max\ conv}$

The maximum torque that can be applied (temporarily) for operation on the recommended motor module.

Max. current I_{max}

This current limit is only determined by the magnetic circuit. Even if this is briefly exceeded, it can result in an irreversible de-magnetization of the magnetic material. Specification of the RMS value of a sinusoidal current.

Maximum converter current $I_{\max \text{ conv}}$

RMS converter output current (per phase) that can be supplied temporarily by the recommended motor module

Maximum permissible speed (mechanical) n_{\max} .

The maximum mechanically permissible speed is $n_{\max \text{ mech}}$. It is defined by the centrifugal forces and frictional forces in the bearing.

Maximum permissible speed at converter $n_{\max \text{ conv}}$

The maximum permissible operating speed for operation at a converter is $n_{\max \text{ conv}}$ (e.g. limited by withstand voltage, maximum frequency).

Mechanical time constant T_{mech}

The mechanical time constant is obtained from the tangent at a theoretical ramp-up function through the origin.

$$T_{\text{mech}} = 3 \cdot R_{\text{Str}} \cdot J_{\text{Mot}} / k_{\text{T}}^2 \text{ [s]}$$

J_{Mot} = Servomotor moment of inertia [kgm²]

R_{Str} = Phase resistance of the stator winding [Ohm]

k_{T} = Torque constant [Nm/A]

NDE

Non-drive end = Non-drive end of the motor

Optimum operating point

Operating point at which the maximum continuous output of the motor is normally provided at high efficiency (see figure below).

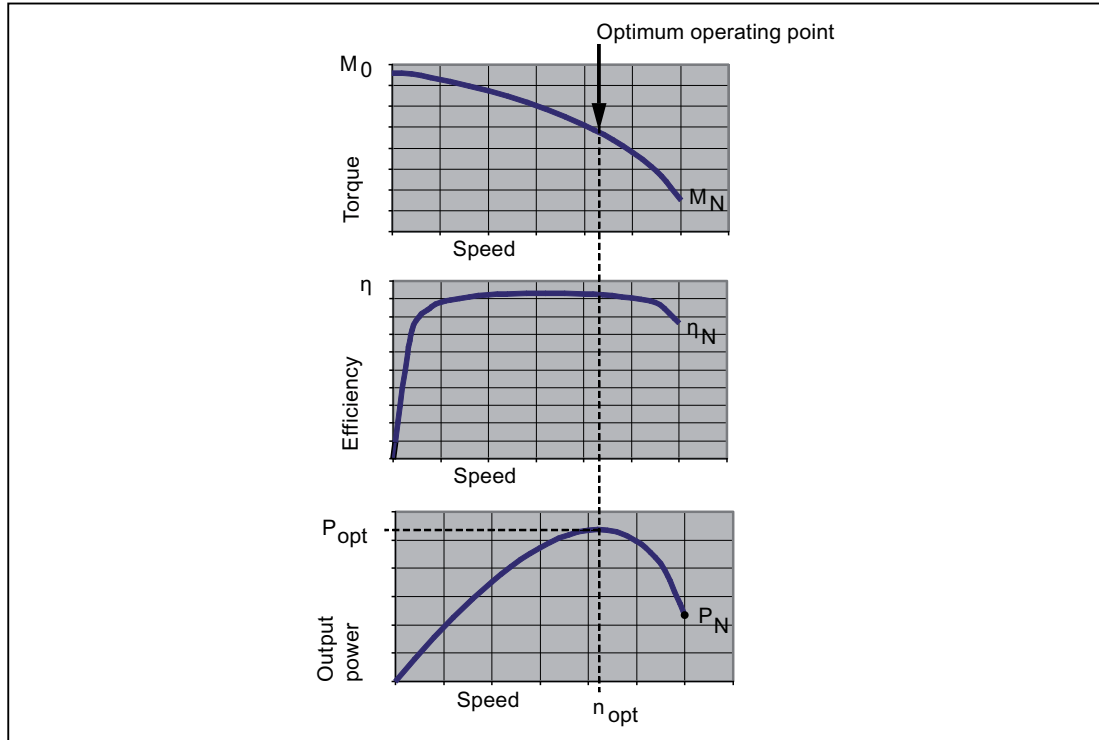

Figure A-1 Optimum operating point

Optimum speed n_{opt}

Speed at which the optimum motor power is output.

If the rated speed is less than the optimum speed, the rated speed is indicated.

Optimum power P_{opt}

Power achieved at the optimum speed.

The rated speed is the optimum speed (see optimum speed), the optimum power corresponds to the rated power.

Number of poles $2p$

Number of magnetic north and south poles on the rotor. p is the number of pole pairs.

Voltage constant k_E (value at 20° C rotor temperature)

Rms value of the induced motor voltage at a speed of 1000 rpm and a rotor temperature of 20 °C.

Static torque M_0

Thermal limit torque at motor standstill corresponding to utilization according to 100 K or 60 K. This can be output for an unlimited time when $n = 0$ rpm. M_0 is always greater than the rated torque M_N .

Stall current I_0

Motor phase current to generate the particular stall torque ($M_0 = k_T \cdot I_0$). Specification of the RMS value of a sinusoidal current.

Thermal time constant T_{th}

Defines the increase in the motor frame temperature when the motor load is suddenly increased (step function) to the permissible S1 torque. The motor has reached 63% of its final temperature after T_{th} .

Moment of inertia J_{Mot}

Moment of inertia of rotating motor parts. J_{Mot} = without brake, J_{MotBr} = with brake.

Shaft torsional stiffness $C_{t Mot}$

This specifies the shaft torsional stiffness from the center of the rotor laminated core to the center of the shaft end. $C_{t Mot}$ = without brake, $C_{t MotBr}$ = with brake.

Winding resistance R_{Str} at 20 °C winding temperature

The resistance of a phase at a winding temperature of 20° C is specified. The winding has a star circuit configuration.

A.2 Declaration of conformity



EG-Konformitätserklärung EC Declaration of Conformity No. 664.20022.21

Hersteller: **Siemens Aktiengesellschaft**
Manufacturer: Industrie Sector
DT MC EWN

Anschrift: Industriestraße 1
Address: 97615 Bad Neustadt a. d. Saale
Germany

Produktbezeichnung: **Drehstrom – Synchronmotor, Servoantrieb Typ 1FK7...**
Description of the product: *Three-phase synchronous servo-motor, type 1FK7...*

Die bezeichneten Produkte stimmen in der von uns in Verkehr gebrachten Ausführung mit den Vorschriften folgender Europäischer Richtlinie überein:
The products described above in the form as delivered are in conformity with the provisions of the following European Directive:

2006/95/EG Richtlinie des Europäischen Parlaments und de Rates vom 12.Dezember 2006 zur Angleichung der Rechtsvorschriften der Mitgliedstaaten betreffend elektrische Betriebsmittel zur Verwendung innerhalb bestimmter Spannungsgrenzen.
Directive of the European Parliament and the Council of 12. December 2006 on the approximation of the laws of the Member States related to electrical equipment designed for use within certain voltage limits.

Die Konformität mit der Richtlinie wird nachgewiesen durch die Einhaltung folgender Normen:
Conformity to the Directive is assured through the application of the following Standards:

EN 60034-1*): 2004 EN 60204-1 : 2006
*) mit allen relevanten Teilen / *with all relevant parts*

Die Sicherheitshinweise und Betriebsanleitungen sind zu beachten.
The safety and manual documentation have to be considered in detail.

Erste CE - Kennzeichnung: 2002 / *first CE - marking: 2002*

Die bezeichneten Produkte sind zum Einbau in andere Maschinen bestimmt. Die Inbetriebnahme ist solange untersagt, bis die Konformität des Endproduktes mit der Richtlinie 2006/42/EG festgestellt ist. Alle Sicherheitshinweise der zugehörigen Produktdokumentation sind zu beachten sowie dem Endanwender zur Kenntnis zu geben.

Diese Erklärung stellt keine Beschaffenheits- und Haltbarkeitsgarantie gemäß § 443 BGB dar.
The products supplied are intended exclusively for installation in a machine. Commissioning is prohibited until it has been established that the end product conforms with the Directive 2006/42/EU. All safety instructions in the associated product documentation must be observed and given to the end user for his/her information. This declaration contains no condition and durability guarantee to § 443 BGB (German Civilian Code).

Bad Neustadt, den 10.02.2010

Siemens Aktiengesellschaft

Frank Michael,
Head of the Electric Motor Factory, Bad Neustadt

Dr. Jan Dainat,
Head von Engineering Department (KT)

Diese Erklärung bescheinigt die Übereinstimmung mit der genannten Richtlinie, ist jedoch keine Zusicherung von Eigenschaften.
This declaration certifies the conformity to the specified Directive, but contains no assurance of properties.

Ersatz für / *Substitute for* 664.20022.21 Stand / *Status:* 02/2002

Ausgabestand / Status: 02/2010
Erstausgabe / first document: 02/2002

Siemens Aktiengesellschaft: Chairman of the Supervisory Board: Gerhard Cromme; Managing Board: Peter Loescher, Chairman, President and Chief Executive Officer; Wolfgang Dehen, Heinrich Hiesinger, Joe Kaeser, Barbara Kux, Hermann Requardt, Siegfried Russwurm, Peter Y. Solmsen; Registered offices: Berlin and Munich, Germany; Commercial registries: Berlin Charlottenburg, HRB 12300, Munich, HRB 6684; WEEE-Reg.-No. DE 23691322

Index

A

Armature short-circuit braking, 222
Axial eccentricity, 56

B

Belt pre-tension, 50
Brake resistors, 222

C

CAD CREATOR, 198
Concentricity, 56
Configuring, 35
Coupling outputs, 241

D

Danger and warning information, 5
Declaration of conformity, 266
Disposal, 8
DRIVE-CLIQ interface, 212

E

Effects on mounting, 258
Environmental compatibility, 8
Environmental conditions, 255
ESDS instructions, 7

G

Gearbox, 228

H

Holding brake, 218
Hotline, 4

N

Natural cooling, 47
Noise emission, 59

R

Radial force loading, 51
Rating plate, 26

S

Shaft end, 58
SinuCom, 38
SIZER for SIEMENS Drives, 35
Smooth running, 56
Sound pressure level, 59
STARTER, 37

T

Technical data

1FK7011-5AK21, 182
1FK7011-5AK71, 70
1FK7015-5AK21, 184
1FK7015-5AK71, 72
1FK7022-5AK21, 186
1FK7022-5AK71, 74
1FK7032-2AF21, 188
1FK7032-2AK71, 76
1FK7033-4CF21, 194
1FK7033-4CK71, 142
1FK7034-2AF21, 190
1FK7034-2AK71, 78
1FK7040-2AK71, 80
1FK7042-2AC71, 82
1FK7042-2AF21, 192
1FK7042-2AF71, 84
1FK7042-2AK71, 86
1FK7042-3BK71, 170
1FK7043-4CF21, 196
1FK7043-4CH71, 144
1FK7043-4CK71, 146
1FK7044-4CF71, 148
1FK7044-4CH71, 150

- 1FK7060-2AC71, 88
- 1FK7060-2AF71, 90
- 1FK7060-2AH71, 92
- 1FK7060-3BF71, 172
- 1FK7061-4CF71, 152
- 1FK7061-4CH71, 154
- 1FK7062-2AC71, 94
- 1FK7062-2AF71, 96
- 1FK7062-2AH71, 98
- 1FK7062-3BF71, 174
- 1FK7063-2AC71, 100
- 1FK7063-2AF71, 102
- 1FK7063-2AH71, 104
- 1FK7064-4CC71, 156
- 1FK7064-4CF71, 158
- 1FK7064-4CH71, 160
- 1FK7080-2AF71, 106
- 1FK7080-2AH71, 108
- 1FK7081-2AC71, 110
- 1FK7081-2AF71, 112
- 1FK7081-2AH71, 114
- 1FK7081-3BF71, 176
- 1FK7083-2AC71, 116
- 1FK7083-2AF71, 118
- 1FK7083-2AH71, 120
- 1FK7084-2AC71, 122
- 1FK7084-2AF71, 124
- 1FK7084-3BC71, 178
- 1FK7084-3BF71, 180
- 1FK7085-4CC71, 162
- 1FK7085-4CF71, 164
- 1FK7086-4CC71, 166
- 1FK7086-4CF71, 168
- 1FK7100-2AC71, 126
- 1FK7100-2AF71, 128
- 1FK7101-2AC71, 130
- 1FK7101-2AF71, 132
- 1FK7103-2AC71, 134
- 1FK7103-2AF71, 136
- 1FK7105-2AC71, 138
- 1FK7105-2AF71, 140

- Technical features, 18
- Technical Support, 4
- Thermal motor protection, 209
- Third-party products, 8
- Training, 3

V

- Vibration response, 58

Siemens AG
Industry Sector
Drive Technologies
Motion Control Systems
P.O. Box 3180
91050 ERLANGEN
GERMANY

Subject to change without prior notice
© Siemens AG 2011

www.siemens.com/motioncontrol