

Equipment for special machines
WS 400-10/20/22
Operator panels

| | | |
|-------------|--|---------------|
| Description | | Edition 11.91 |
|-------------|--|---------------|

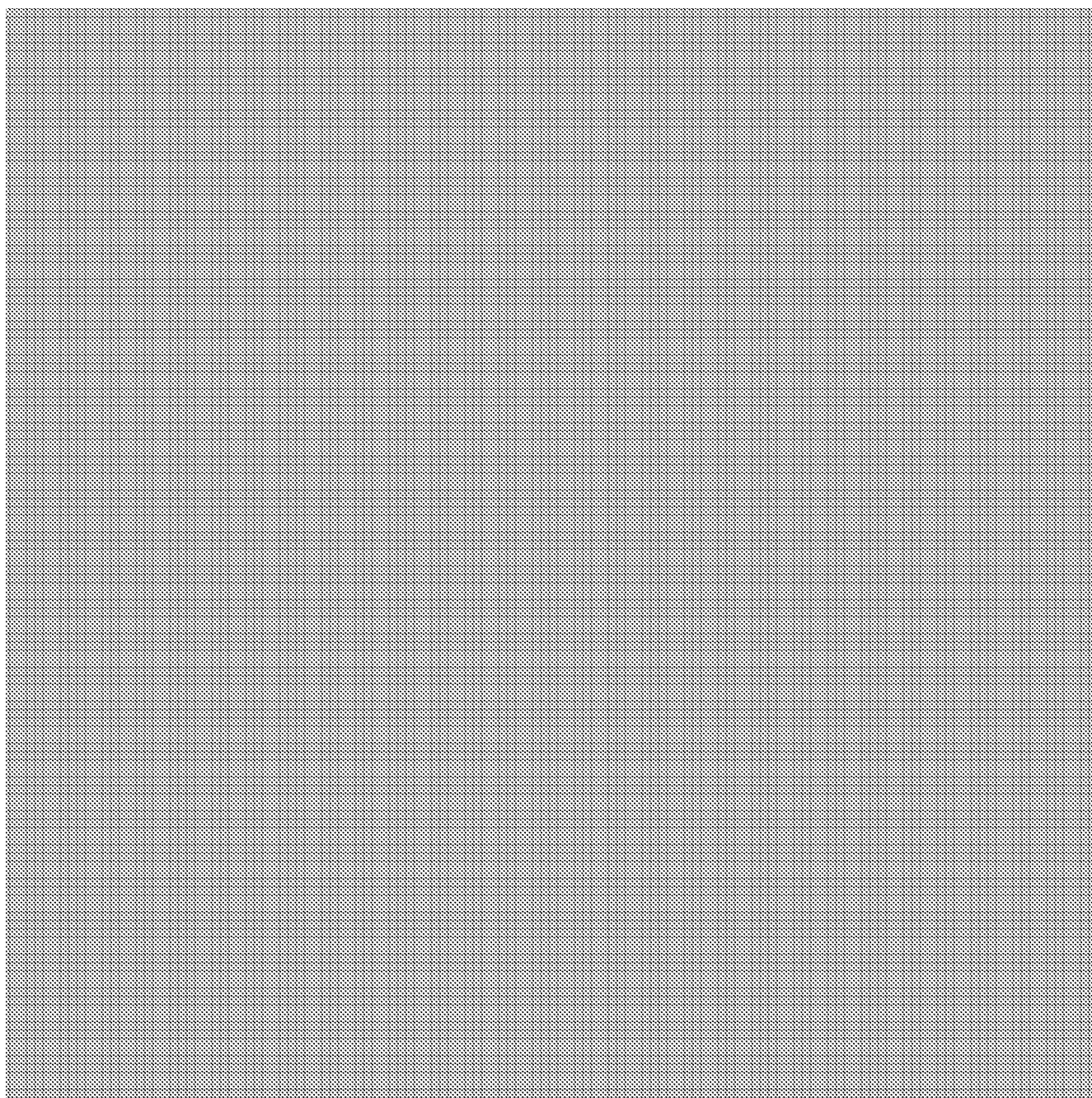

Equipment for special machines

WS 400

Manual

Siemens AG
Automation Group
Automation Systems
for Machine Tools, Robots
and Special-Purpose Machines
P.O. Box 31 80, D-91050 Erlangen
Federal Republic of Germany

© Siemens AG 1994 All Rights Reserved
Subject to change without prior notice
570 093 300 020

Siemens Aktiengesellschaft

Order No. 6ZB5 440-0AR02-0BA3
Printed in the Fed. Rep. of Germany
(819) RGWE/540090 BS 12940.1 (1260)

Equipment for special machines

WS 400-10/20/22
Operator panels

Description

Structure 2

Functioning method 3

Connection
of the operator panels 4

Technical data 5

Operating data 6

Please note

As it was our aim to provide you with a concise manual for the product in hand, we have refrained from including every single detail about the product types available. It is therefore beyond the scope of this manual to discuss every situation that could arise when commissioning, running and servicing the product.

Should you require additional information, please do not hesitate to contact your nearest Siemens representative.

The contents of this product are not part of an earlier or current agreement, undertaking or contract, nor shall they supersede any such previous arrangements. The obligations of Siemens result from the sales contract in force which also describes the warranty conditions that are valid. The contractual warranty clause is neither extended nor restricted in any way by the contents of this manual.

SIMATIC, SIMODRIVE, SINEC, SINUMERIK, STEP are registered trade marks of Siemens Aktiengesellschaft.

The remaining designations referred to in this manual may be trade marks whose use through third parties for their own purposes may infringe the rights of the owners of the trade mark.

This publication was produced on the Siemens 5800 Office System.

Subject to change without prior notice.

The reproduction, transmission or use of this document or its contents is not permitted without express written authority. Offenders will be liable for damages. All rights, including rights created by patent grant or registration of a utility model or design, are reserved.

© Siemens AG 1994 All Rights Reserved

Contents

| | Page |
|----------|---|
| 1 | Area of application 1-1 |
| 2 | Structure 2-1 |
| 2.1 | Structure of the operating elements - common characteristics ... 2-1 |
| 2.2 | Functions of the operating elements 2-2 |
| 3 | Functioning method 3-1 |
| 3.1 | Functioning method of the operating elements of the WS 400-10 .. 3-1 |
| 3.2 | Functioning method of the operating elements of the WS 400-20/22 / alpha block 3-1 |
| 3.2.1 | Connection via the parallel interface to the SIMATIC S5 3-1 |
| 3.2.2 | Keyboard code of the operator panel WS 400-20 3-3 |
| 3.2.3 | Keyboard code of the operator panel WS 400-22 3-4 |
| 3.2.4 | Keyboard code of the alpha block 3-5 |
| 3.3 | Switch settings and operating elements 3-6 |
| 3.3.1 | Operator panels with 9"-B/W-Monitor 3-6 |
| 3.3.2 | Operator panels with 9"-Colour-Monitor 3-7 |
| 3.3.3 | Operator panels with EL-display 3-7 |
| 4 | Connection of the operator panels 4-1 |
| 4.1 | Operator panels with 9"-B/W-Monitor 4-1 |
| 4.2 | Operator panels with 9"-Colour-Monitor 4-2 |
| 4.3 | Operator panels with EL-display 4-3 |
| 4.4 | EL-Display (Built-in version) 4-4 |
| 4.5 | Alpha block 4-5 |
| 4.6 | Cable plans 4-6 |
| 4.6.1 | Connection cables for colour monitors 4-8 |
| 4.6.2 | Connection cables for monochrome monitors 4-9 |
| 4.6.3 | Connection cables for the EL-display 4-10 |
| 4.7 | Connection for voltage supply 4-11 |

| | | |
|----------|---|-----|
| 5 | Technical data | 5-1 |
| 5.1 | Operator panel WS 400-10 with 9" B/W-Monitor | 5-2 |
| 5.2 | Operator panel WS 400-10 with EL-display | 5-3 |
| 5.3 | Operator panel WS 400-20 with 9" B/W-Monitor | 5-4 |
| 5.4 | Operator panel WS 400-20 with 9" Colour-Monitor | 5-5 |
| 5.5 | Operator panel WS 400-20 with EL-display | 5-6 |
| 5.6 | Operator panel WS 400-22 with 9" B/W-Monitor | 5-7 |
| 5.7 | Alpha block | 5-8 |
| 5.8 | EL-bus clamp | 5-9 |
| | | |
| 6 | Ordering data | 6-1 |

1 Area of application

Owing to the continuing automation of machine tools, systems for operating and monitoring processes are becoming more and more important. Data and texts can be entered much faster with the help of comfortable operation methods, and comfortable monitoring methods allow a fast and exact recognition of faults.

The WS 400 operator panels and the visualisation module WF 470 supply individual, flexible and economic solutions in this area.

The operator panel WS 400-10 can be used when there is no manual input of operating data required for the machine because, for example, it is operated over a bus system from a central control. The eight function keys and the 9"-monitor offer possibilities for control and monitoring as well as for diagnosis of errors.

The operator panel WS 400-20 has an additional 10-key block and an input block so that it can be used for comfortable input of data. This can help to generate traversing programs for the positioning module WF726 of the WS700 system.

The operator panel WS 400-22 is similar to the WS 400-20 but it has 16 keys with individually used LEDs .

The operator panels WS 400-10 and WS 400-20 can also be supplied with an Electro-Luminescence (EL) display instead of the 9"-monitor for special use. These versions are only 9 cm deep and can be used in a maximum distance of 18 meters to the WF 470 module. The lifetime of an EL-display is twice as high as the lifetime of a picture tube. Because of the exactly defined geometry of the pixels, EL-displays are especially useful for graphic displays. Every pixel of the WF 470 corresponds to a pixel on the display which results in an optimum resolution. For construction of special operator panels, the EL-display with built-in adaption electronics can also be delivered individually.

An alpha block with its own current supply is offered as a supplement to the operator panels WS 400-20 and WS 400-22.

2 Structure

2.1 Structure of the operating elements - common characteristics

The operating system WS 400 was developed for memory-programmable controls especially for the SIMATIC S5 with the diagnostics and display system WF 470. As the device is intended for use in industrial manufacturing, the following characteristics were given special attention:

- rugged mechanical keyboard
- stress-resisting unpollutionable plastic protection foil
- ergonomic operation by
 - mechanical pressure points
 - pre-gated keys
- silicon free, therefore also usable in the area of enamelling processing
- consequent module structure: Every module can be exchanged without soldering in the case of service.
- Wide range power unit: from 90V to 260V, from 47Hz to 63Hz; a safe voltage supply without switching (not for versions with EL-display)
- function compatible to the compact operating panels of the already existing visualisation system WS 400

The operating panels WS 400 and the compact operating panel with the extension modules have the same keyboard code and the same interfaces. Therefore, they can easily be exchanged.

The panel is connected over 8 digital inputs of the parallel interface. For the SIMATIC S5, the function block FB 201 and the data block DB 201 are needed for the decoding (not for WS 400-10).

2.2 Functions of the operating elements

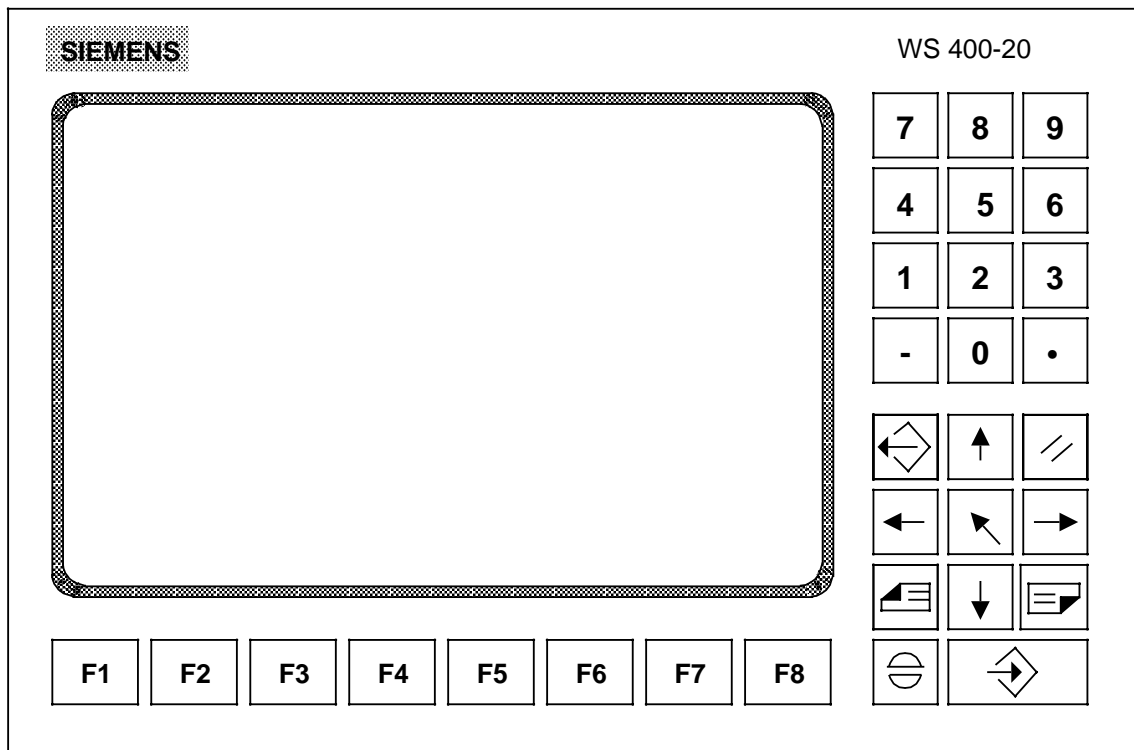

Figure 2.1 Operating panel WS 400-20

All units have:

- at least 8 function keys



- a complete block of numbers with the decimal point and minus signs (except WS 400-10)

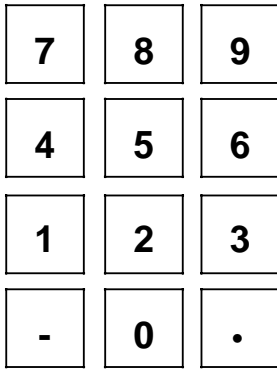

- Special keys (except WS 400-10) for

- Cursor control

| | | | |
|---|---|---|---|
| ↓ | ↑ | ← | → |
|---|---|---|---|
- Data input

| |
|---|
| ↘ |
|---|
- Output of overview mask

| |
|---|
| ↙ |
|---|
- Delete-function

| |
|----|
| // |
|----|
- Scroll picture

| | | | | | | | | | | | | | |
|--|---|--|--|--|--|--|--|--|--|--|--|--|--|
| <table border="1" style="border-collapse: collapse;"> <tr><td style="width: 10px; height: 10px;">▲</td><td style="width: 20px; height: 10px;"> </td></tr> <tr><td style="width: 10px; height: 10px;"> </td><td style="width: 20px; height: 10px;"> </td></tr> <tr><td style="width: 10px; height: 10px;"> </td><td style="width: 20px; height: 10px;"> </td></tr> </table> | ▲ | | | | | | <table border="1" style="border-collapse: collapse;"> <tr><td style="width: 10px; height: 10px;"> </td><td style="width: 20px; height: 10px;"> </td></tr> <tr><td style="width: 10px; height: 10px;"> </td><td style="width: 20px; height: 10px;"> </td></tr> <tr><td style="width: 10px; height: 10px;"> </td><td style="width: 20px; height: 10px;"> </td></tr> </table> | | | | | | |
| ▲ | | | | | | | | | | | | | |
| | | | | | | | | | | | | | |
| | | | | | | | | | | | | | |
| | | | | | | | | | | | | | |
| | | | | | | | | | | | | | |
| | | | | | | | | | | | | | |
- Acknowledge faults

| |
|---|
| ⊖ |
|---|

3 Functioning method

For the next chapter, the SIMATIC S5 terminology and the programming language STEP5 are assumed to be known.

3.1 Functioning method of the operating elements of the WS 400-10

The function keys of the operator panel WS 400-10 are connected as switch contacts with a common root to the 15 pole subminiature connector X1. From there, they can be connected with and recognised by digital inputs to the SIMATIC S5. It is not necessary to use the standard function block FB 201 and the data block DB 201, as the analysis is easier in the user program.

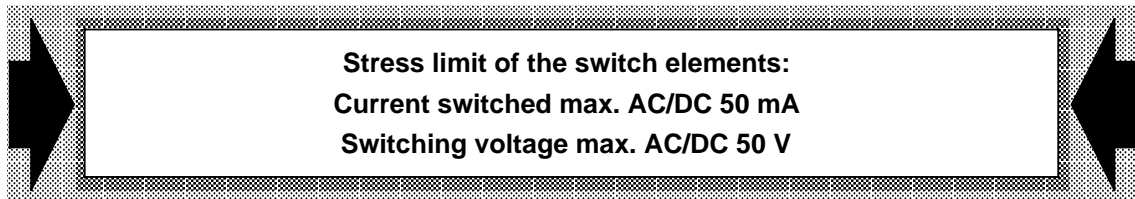

3.2 Functioning method of the operating elements of the WS 400-20/22 / alpha block

3.2.1 Connection via the parallel interface to the SIMATIC S5

When the operating panels WS 400-20/22 are connected to the SIMATIC S5, the standard function block FB 201 and the data block DB 201 are needed. These modules are delivered with the linking software S5-WF 470. The standard blocks FB 201 and DB 201 can also be loaded with other block numbers into the SIMATIC S5.

| Parameter of FB 201 | Designation | Note | Param. Type | Data Type | Allowed values |
|---------------------|--|---------------------|-------------|-----------|--|
| EBDB | EB: Keyboard input byte DB: Data block number | | D | KY | EB 0 - EB 127 DB 0 - DB 255 (Standard: DB 201) |
| FL-M | Edge flag | free flag or output | E | BI | M 0.0 - M 199.7 |
| TAST | Parameter for FB S5-WF470 | Flag byte | A | BY | MB 0 - MB 199 |
| FKTS | Function keys | Flag word | A | W | MW 0 - MW 198 |

The input byte EB contains the key code in Bit 0 to Bit 6 and the strobe signal "Key pressed" (TG) in Bit 7.

The data block DB (DB 201 standard) contains the allocation key code - WF 470-Code.

In the output byte "TAST" the WF 470-Code is read out. The byte "TAST" is used as input byte for the function block FB "S5-WF 470".

The edge flag FL-M has a 1-Signal as long as a key is pressed.

When a function key F1 to F8 is pressed (or F1 to F16), a bit is automatically set in the output parameter "FKTS" and therefore a flag is assigned to every function key.

The allocation is shown graphically in the following table:

| | | | | | | | | | |
|----------------|-----|-----|-----|-----|-----|-----|-----|----|---------------|
| Function key | F8 | F7 | F6 | F5 | F4 | F3 | F2 | F1 | } Flag word X |
| Flag byte: X | .7 | .6 | .5 | .4 | .3 | .2 | .1 | .0 | |
| Funktion key | F16 | F15 | F14 | F13 | F12 | F11 | F10 | F9 | } Flag word X |
| Flag byte: X+1 | .7 | .6 | .5 | .4 | .3 | .2 | .1 | .0 | |

Example of a call:

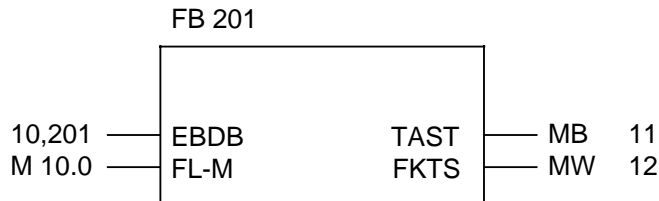

The following table shows the connection of the keyboards to the SIMATIC S5 when a standard function block FB 201 is used.

| Connector X1 at the operator panel/alpha block | Connection to S5 (when FB 201 is used) | Function |
|--|--|--------------------------|
| PIN 1 | E X.7 | Key pressed |
| PIN 2 | E X.0 | Key code of the Keyboard |
| PIN 3 | E X.1 | |
| PIN 4 | E X.2 | |
| PIN 5 | E X.3 | |
| PIN 6 | E X.4 | |
| PIN 7 | E X.5 | |
| PIN 8 | E X.6 | |
| PIN 9 | } Mass | |
| PIN 10 | | |
| PIN 11 | | |
| PIN 12 | | |
| PIN 13 | | |
| PIN 14 | | |
| PIN 15 | | |

(X=Input byte number)

3.2.2 Keyboard code of the operator panel WS 400-20

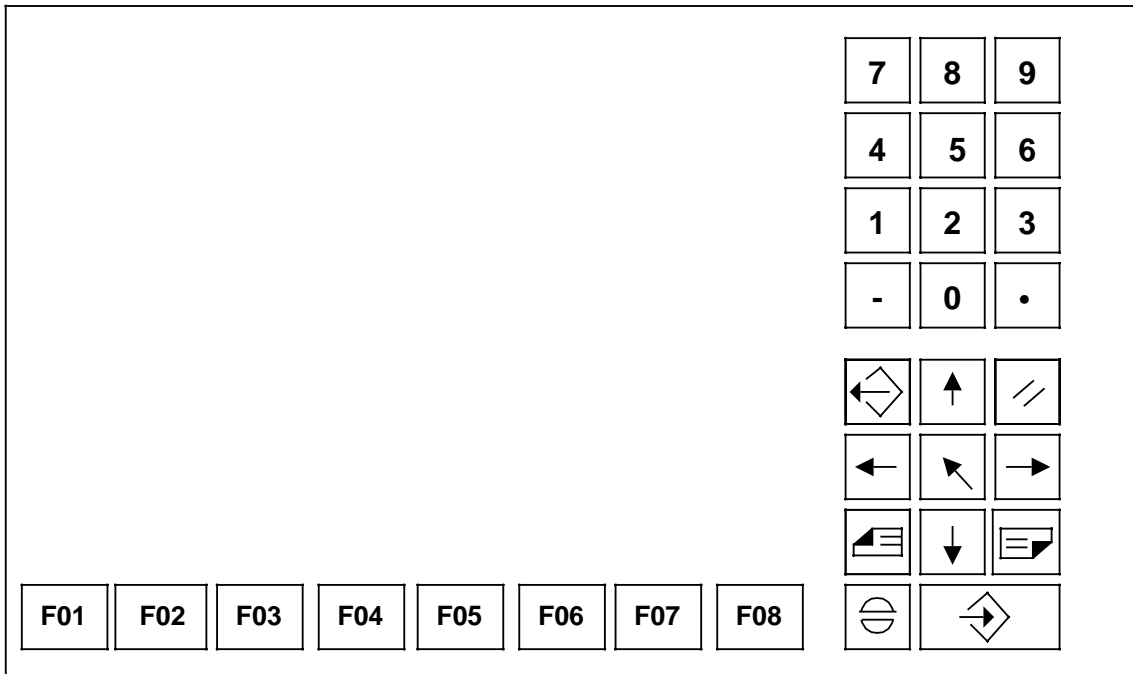

Figure 3.1 Keyboard of the operator panel WS 400-20

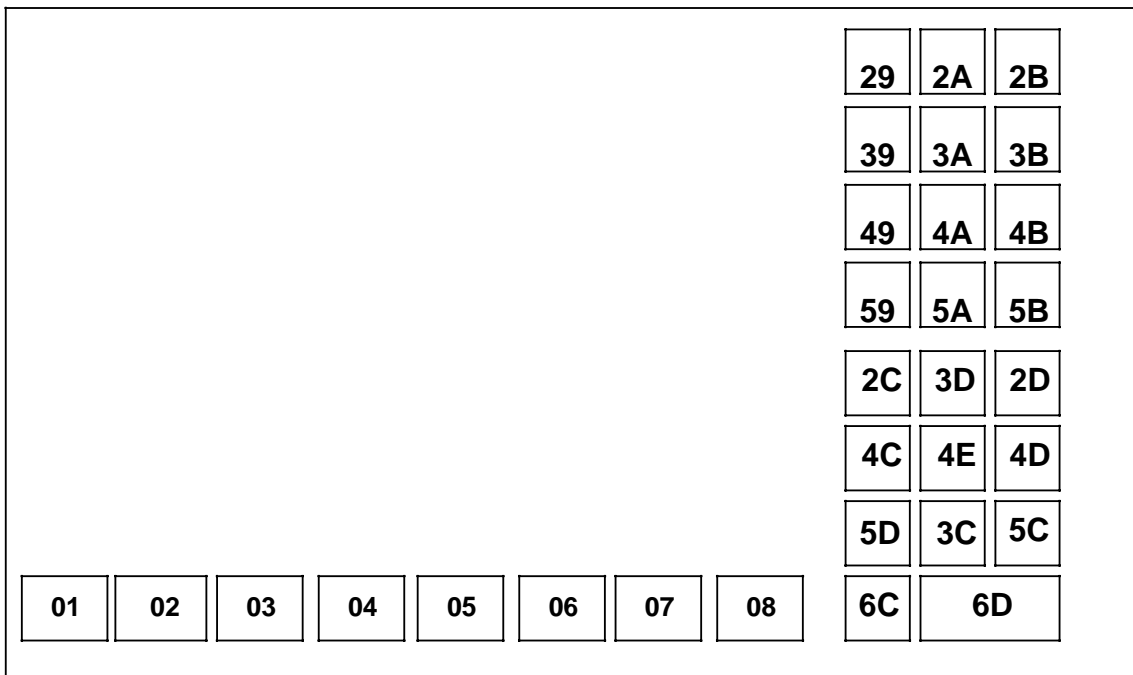

Figure 3.2 Keyboard of the operator panel WS 400-20

3.2.3 Keyboard code of the operator panel WS 400-22

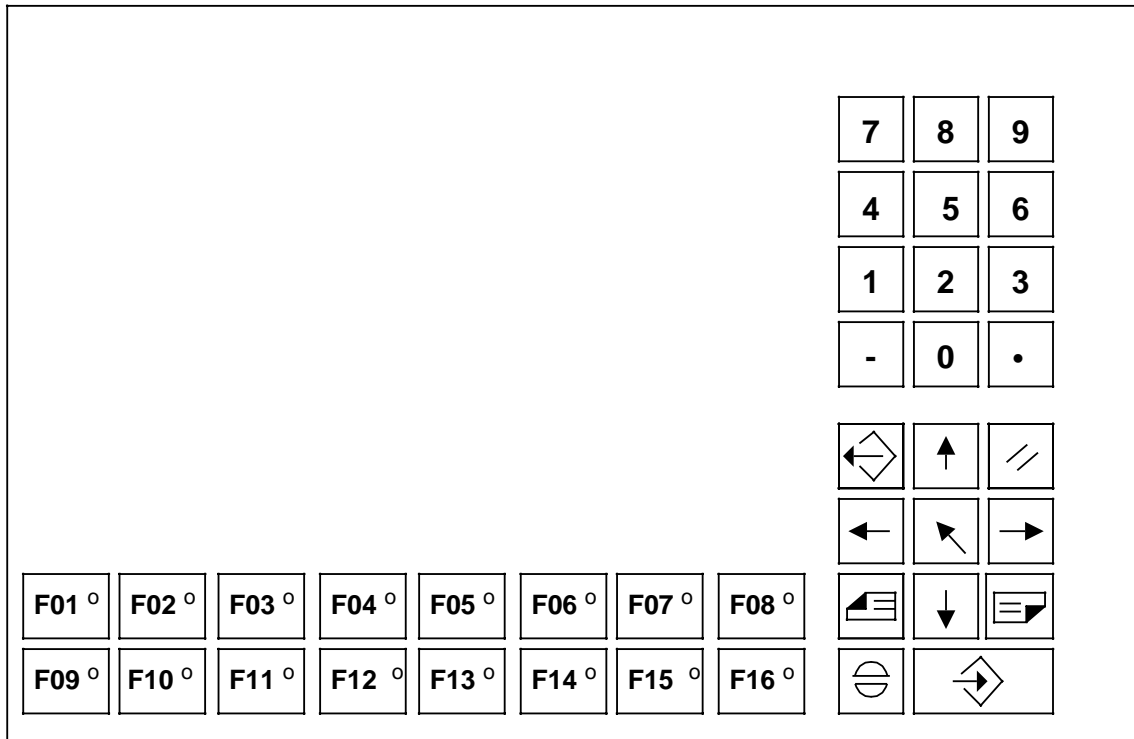

Figure 3.3 Keyboard of the operator panel WS 400-22

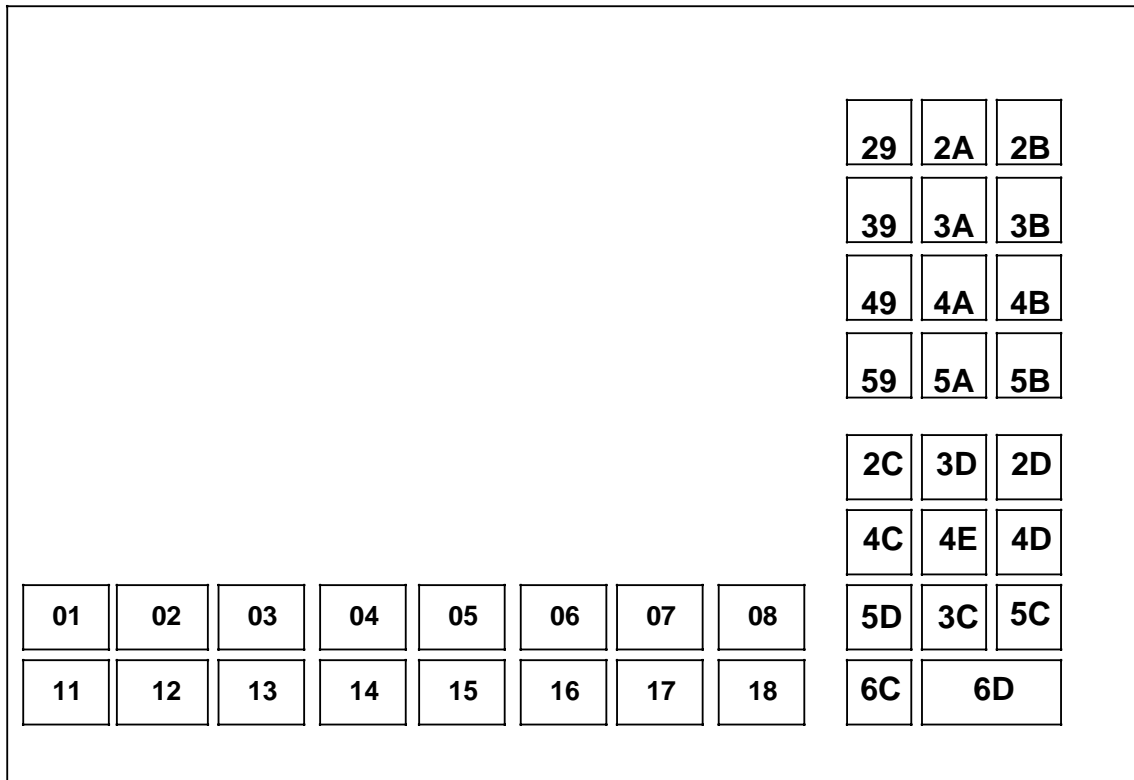

Figure 3.4 Keyboard of the operator panel WS 400-22

3.2.4 Keyboard code of the alpha block

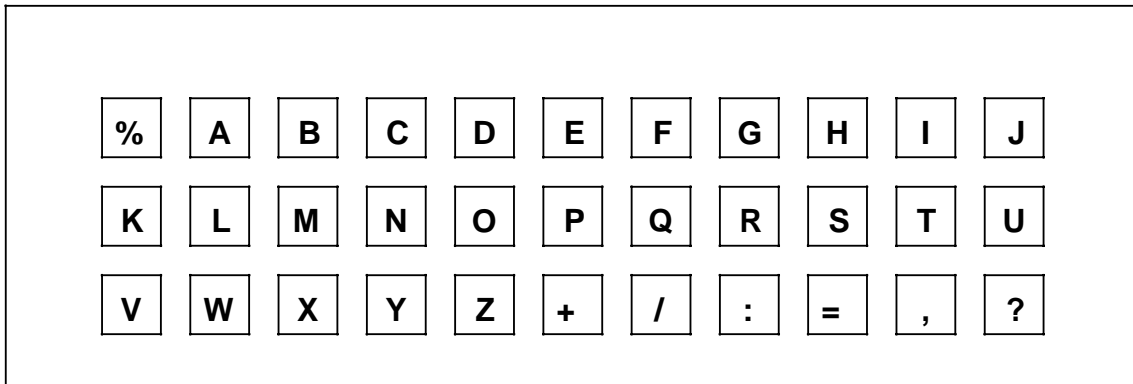

Figure 3.5 Keyboard of the alpha block

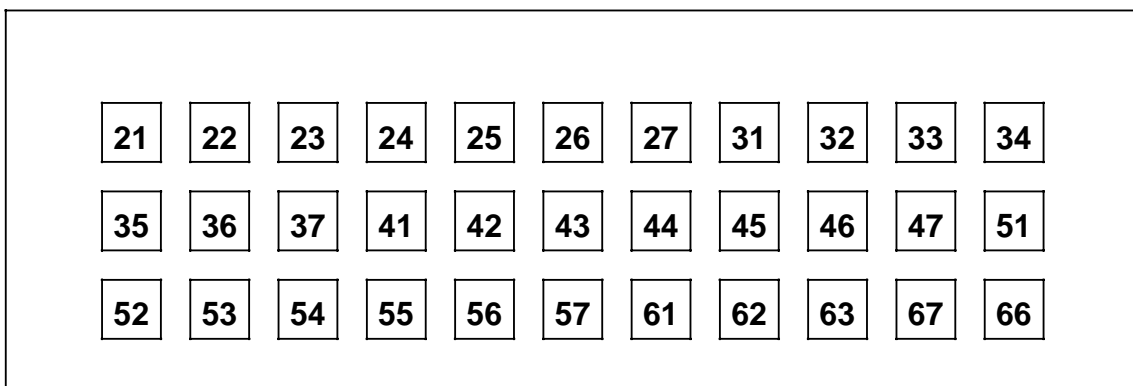
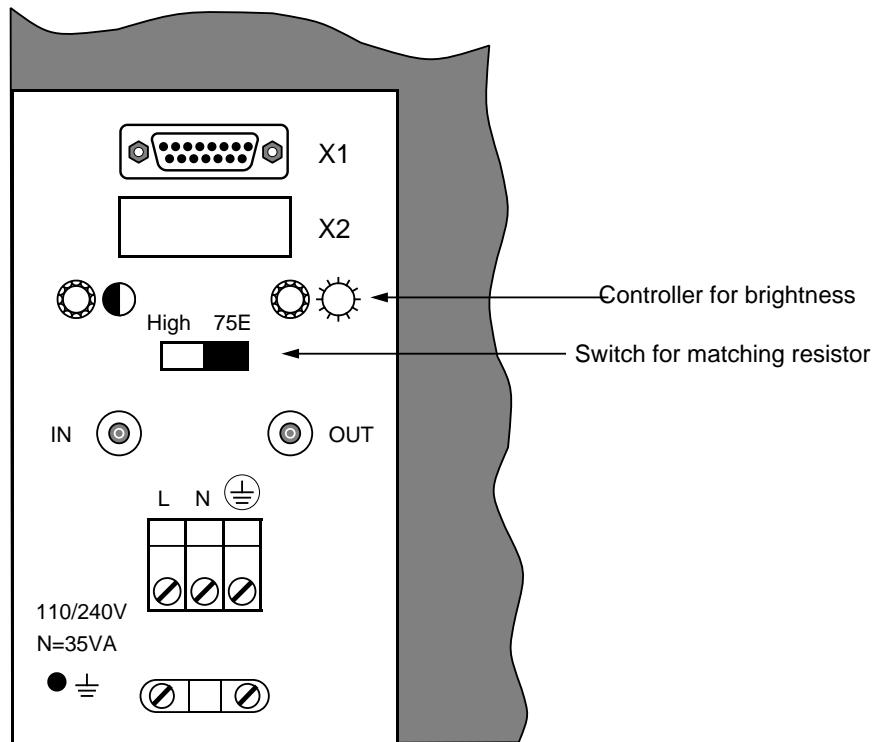

Figure 3.6 Keyboard code of the alpha block

3.3 Switch settings and operating elements

3.3.1 Operator panels with 9"-B/W-Monitor



With the controller for brightness, you can set the required display brightness.

The switch for the matching resistor must only be switched to the setting "High" when another operator panel or another monitor is connected via the BAS socket "OUT". For operation without continued loop of the monitor signal, the switch must be set to "75E".

3.3.2 Operator panels with 9"-Colour-Monitor

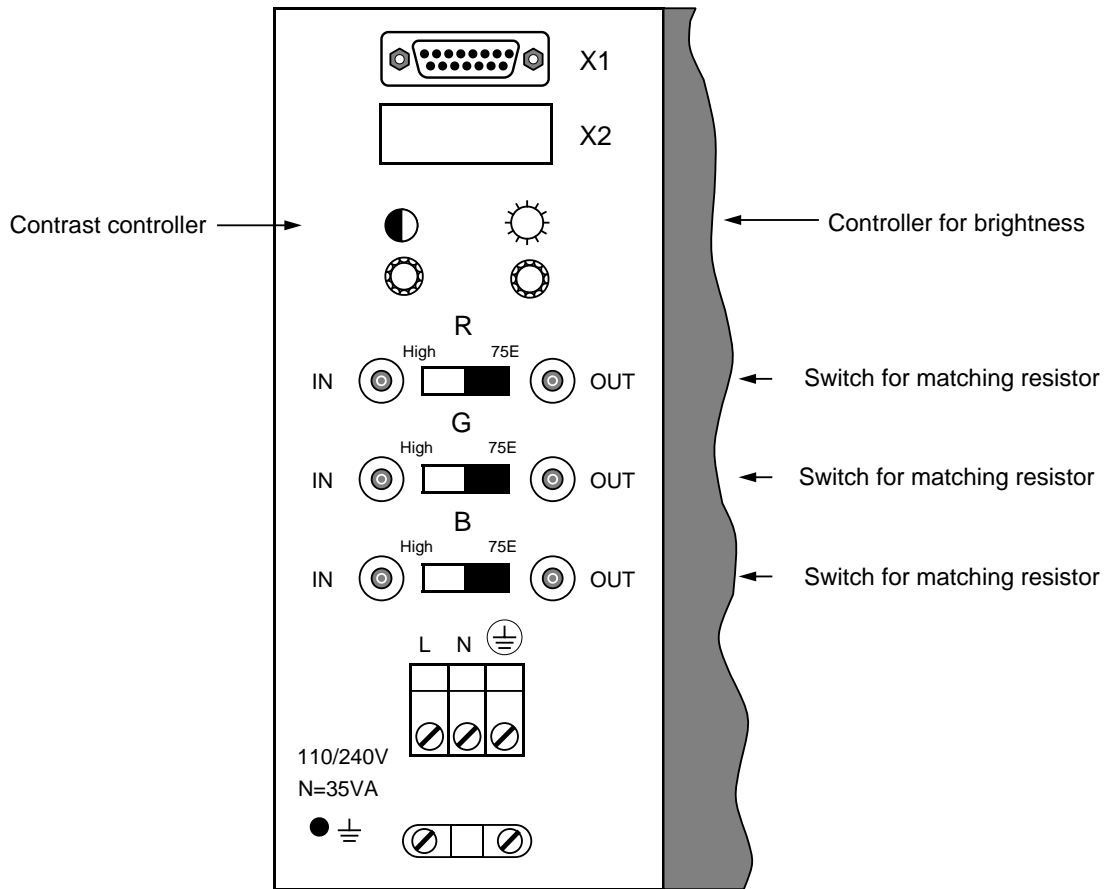

With the controller for brightness, you can set the required display brightness, and with the controller for contrast you can set the required contrast of the display.

The switch for the matching resistor must only be switched to the setting "High" when another operator panel or another monitor is connected over the BAS socket "OUT". For operation without continued loop of the monitor signal, the switch must be set to "75E".

3.3.3 Operator panels with EL-display

There are no switches or elements for the EL-display.

4 Connection of the operator panels

4.1 Operator panels with 9"-B/W-Monitor

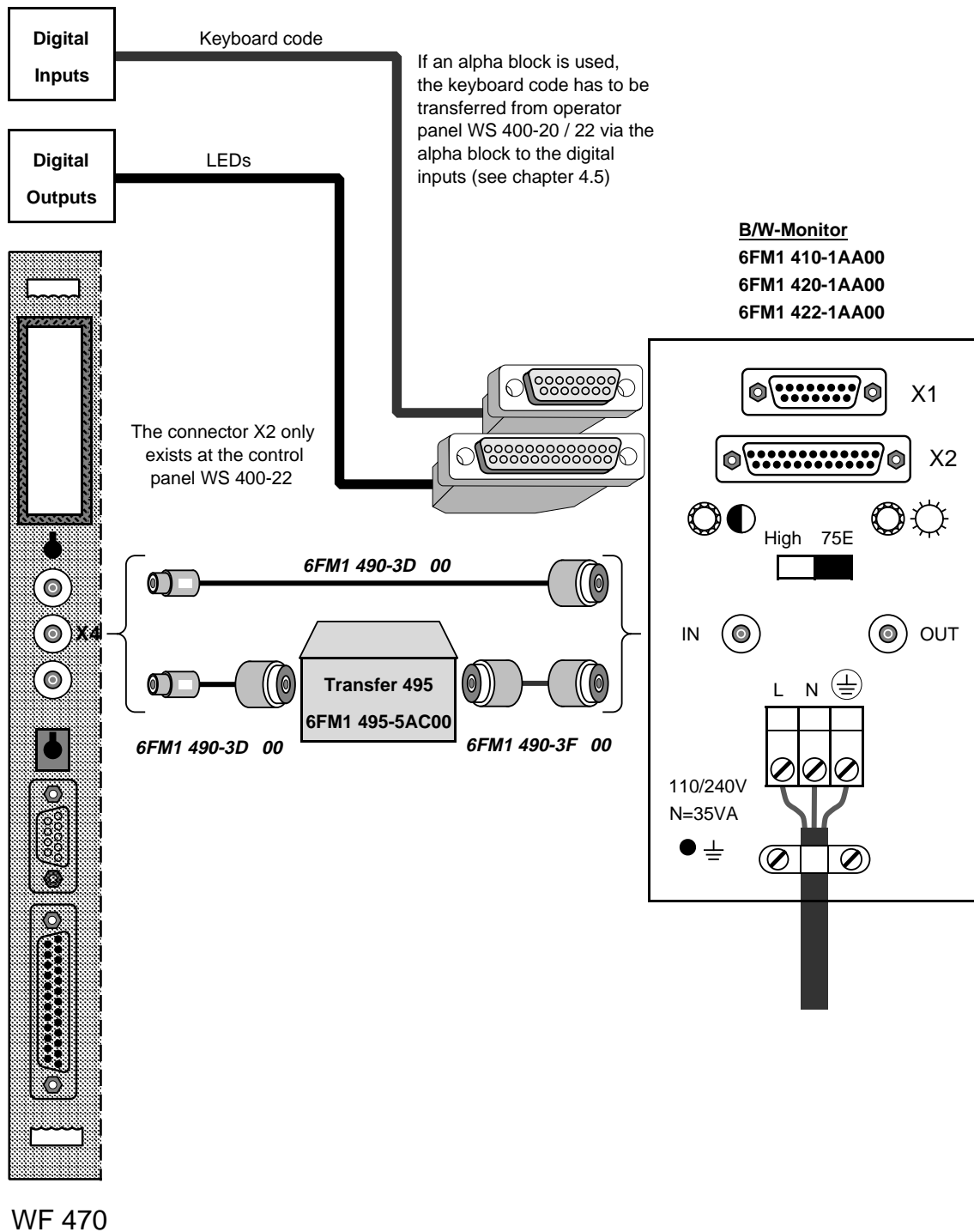

4.2 Operator panel with 9"-Colour-Monitor

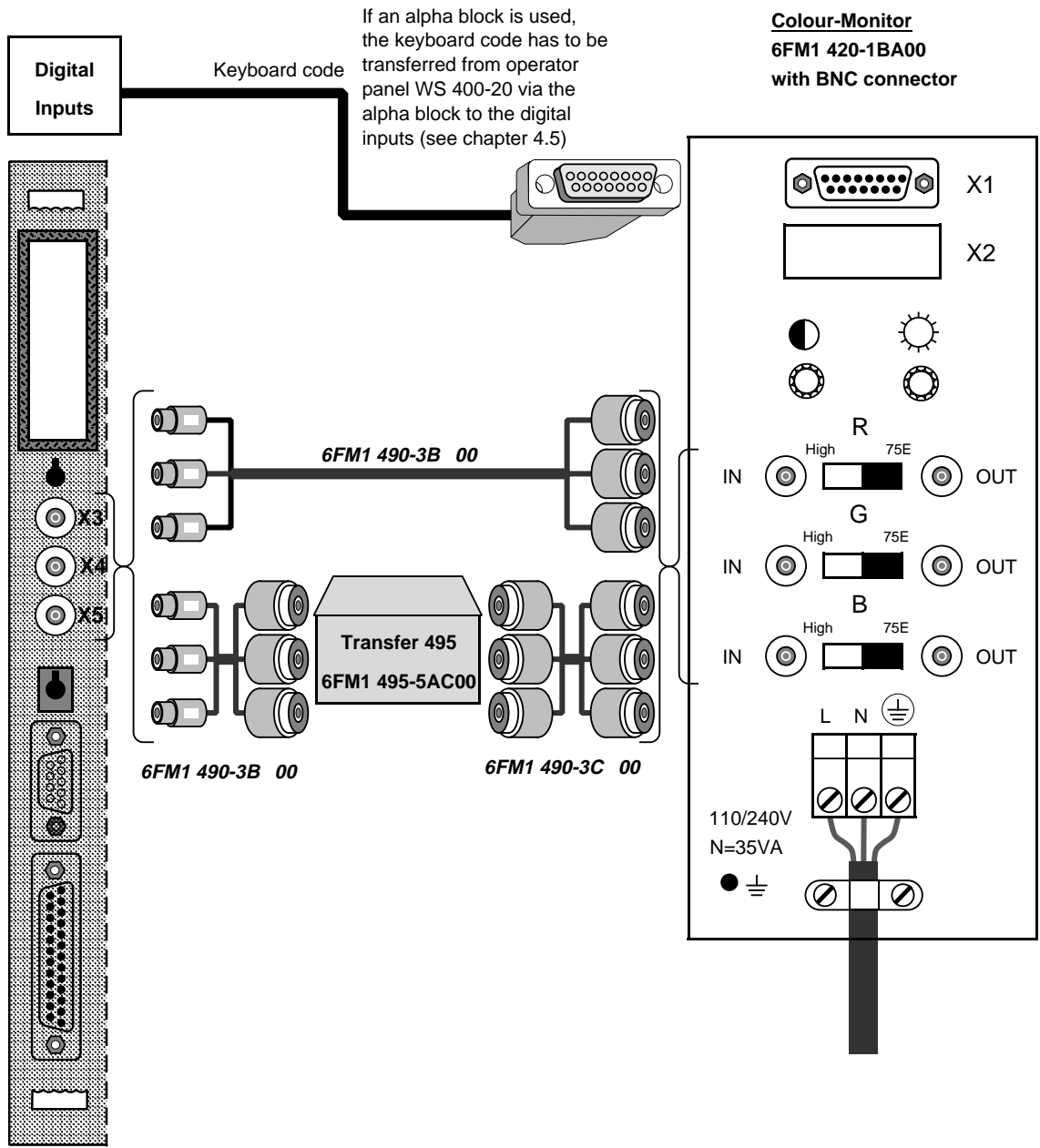

WF 470

4.3 Operator panels with EL-display

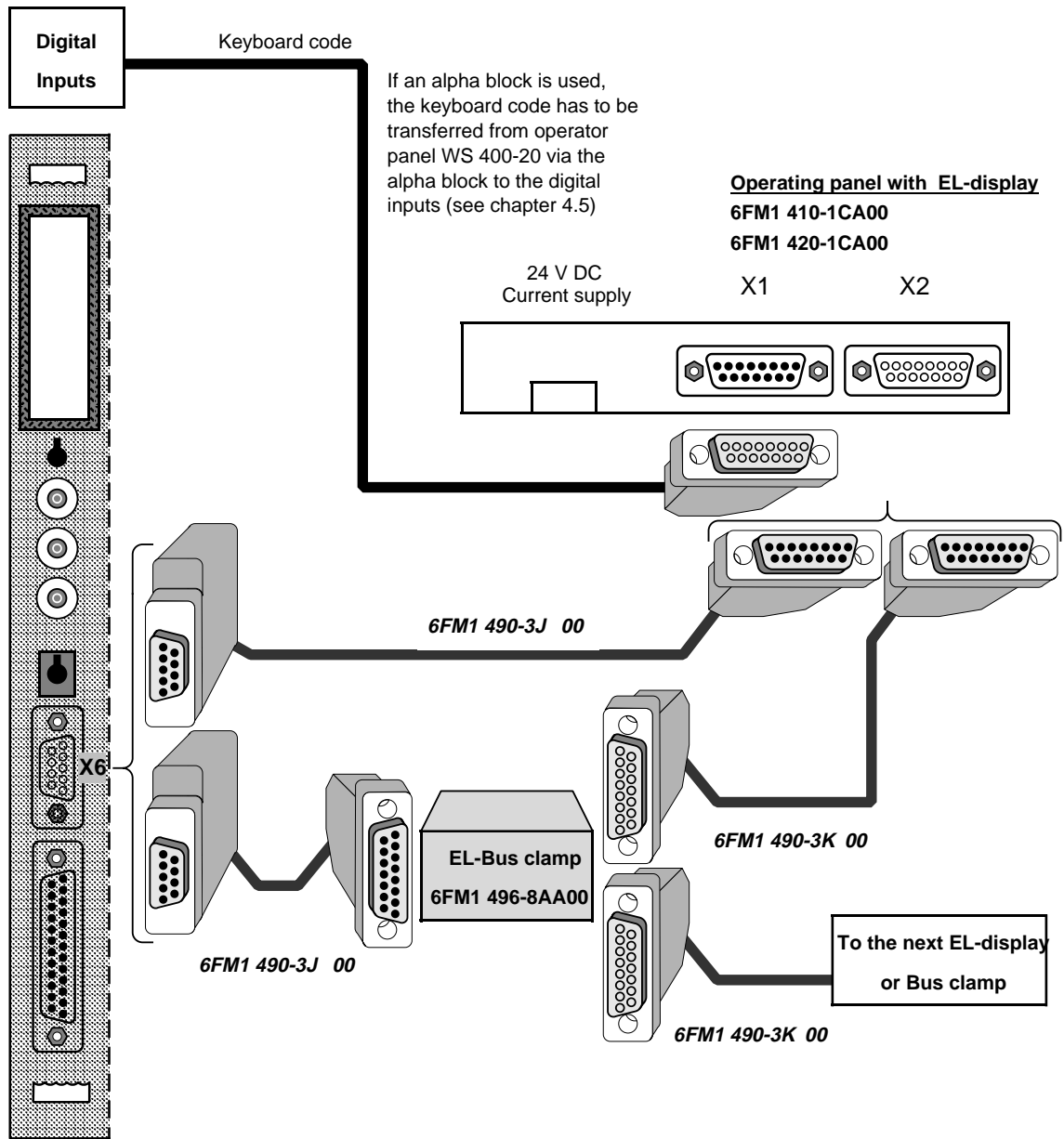

WF 470

4.4 EL-display (Built-in version)

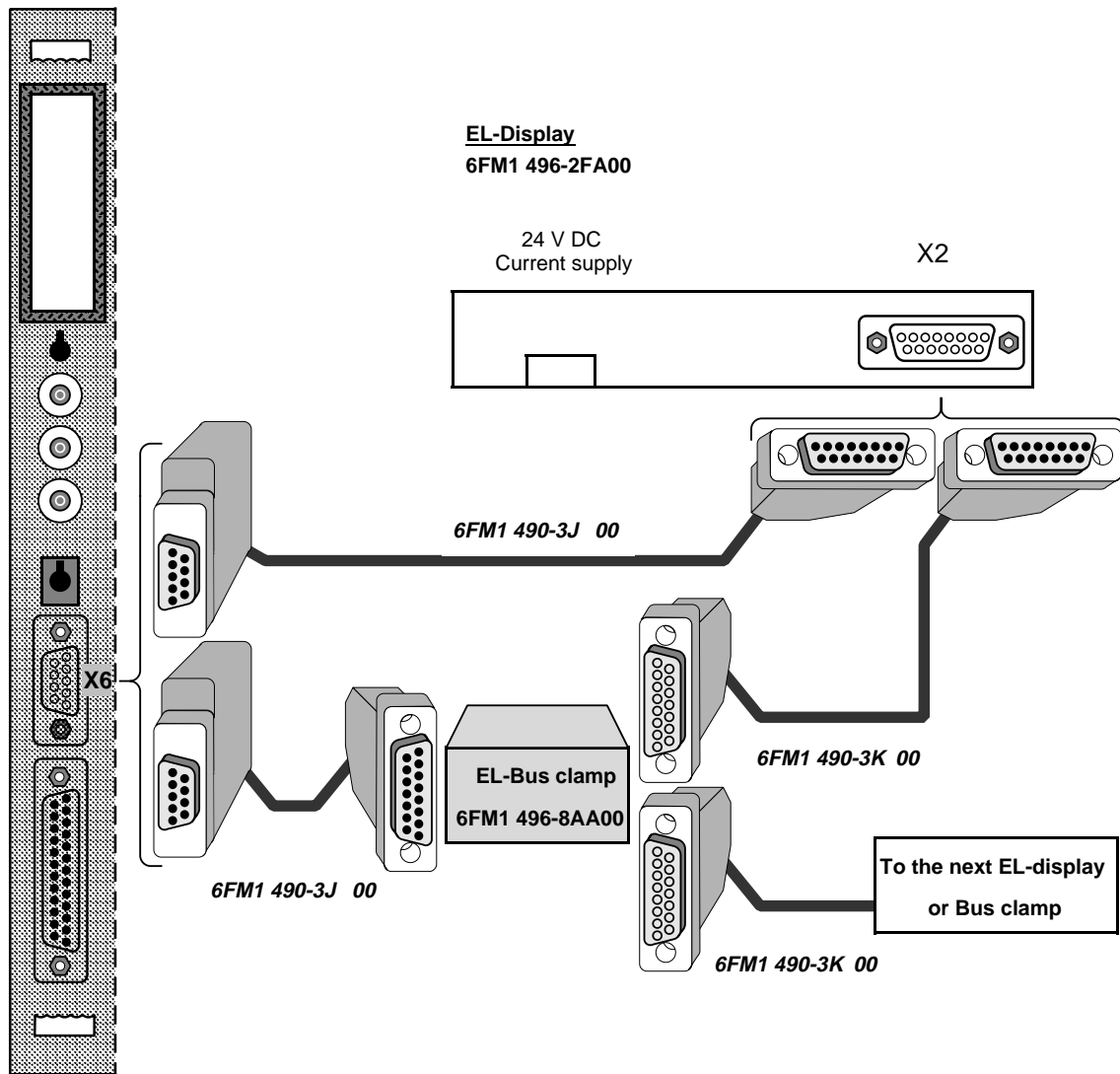

WF 470

4.5 Alpha block

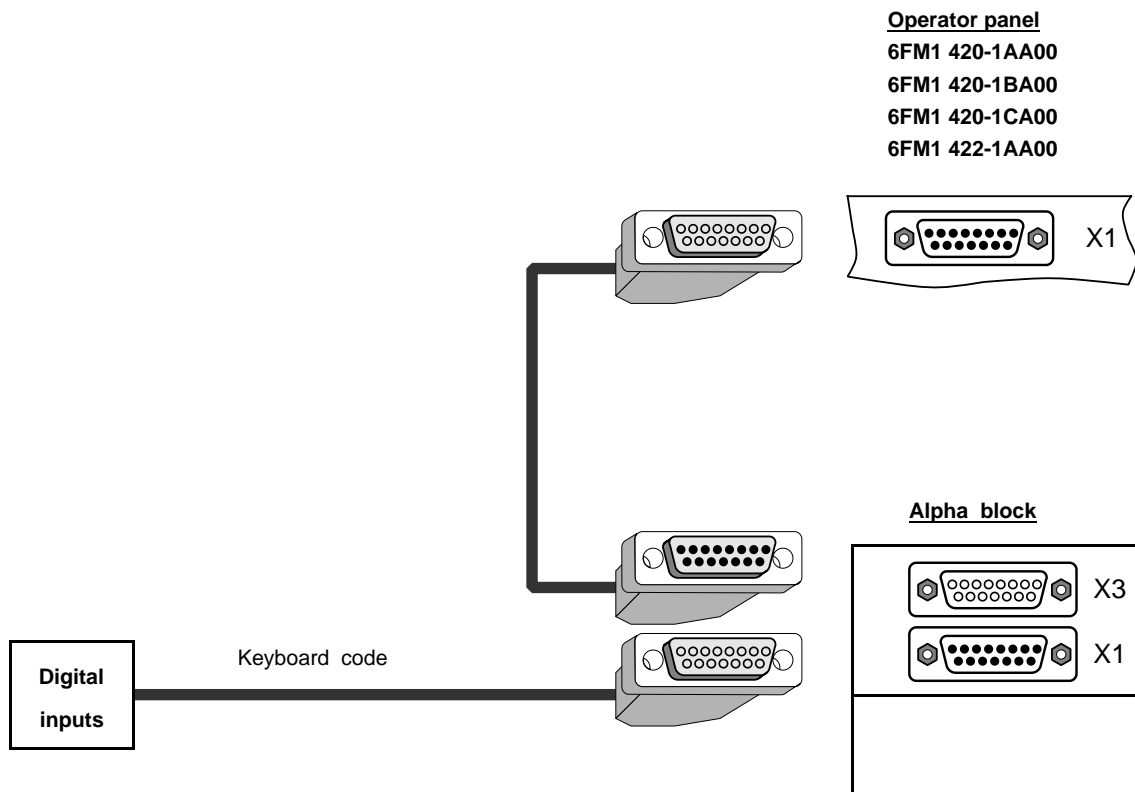

4.6 Cable plans

Connection and functions on the connector X1 with the WS 400-10

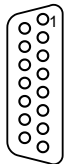
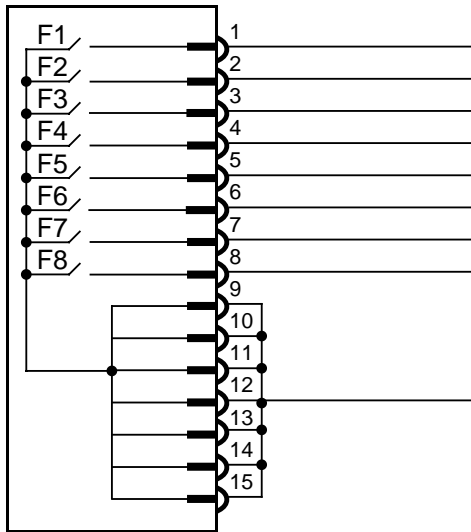

Connector
6FM1790-8CA00
15 pole socket
Solder side

Connection and functions on the connector X1 with the WS 400-20/22

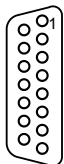
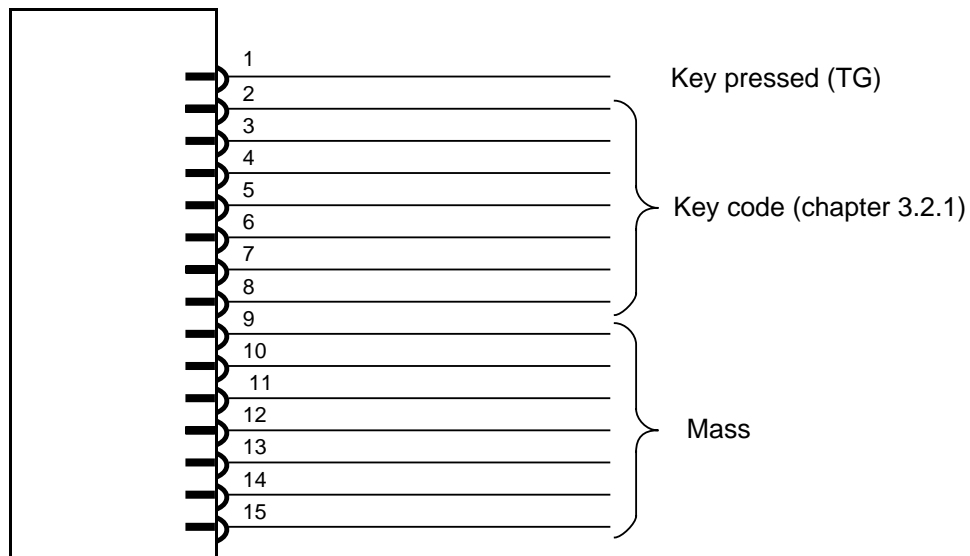

Connector
6FM1790-8CA00
15 pole socket
Solder side

Connection and function on the connector X2 with the WS400-22

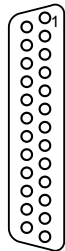
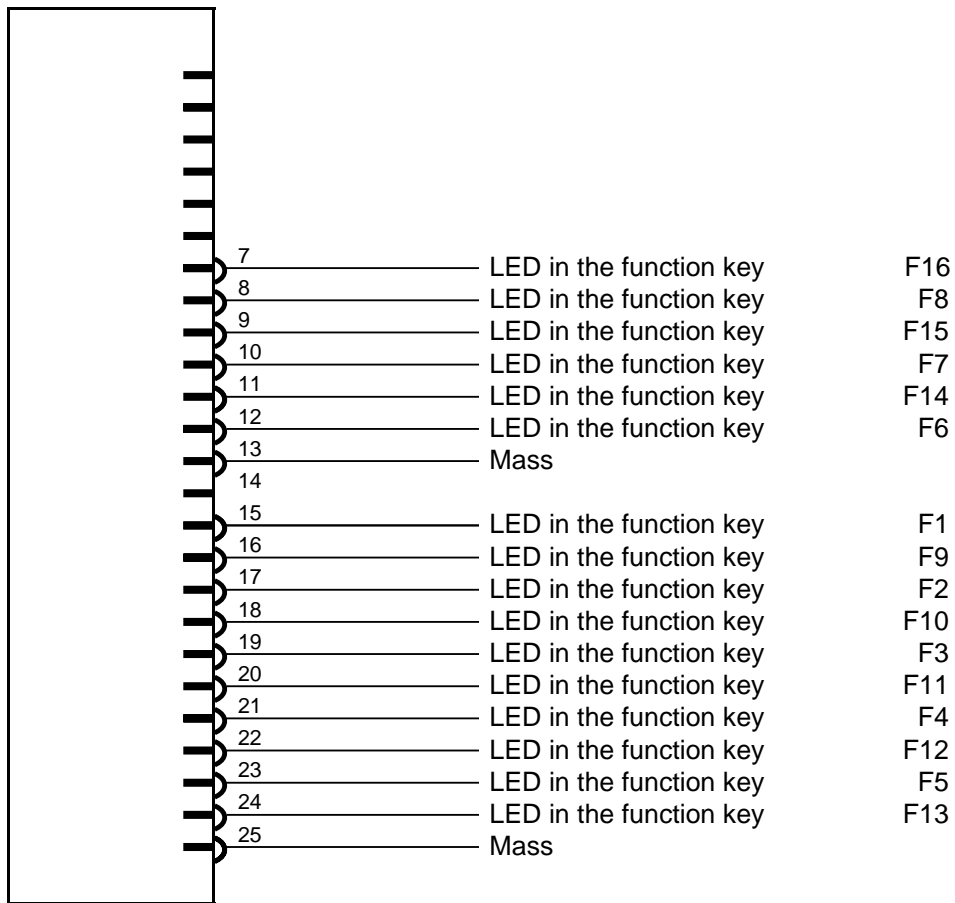

Connector

25 pole socket

Solder side

The keyboard electronic system is supplied with 24V DC internally via the monitor converter.
Supply via X2 is not necessary!

Connection and function on the connector X3 with the alpha block

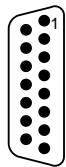
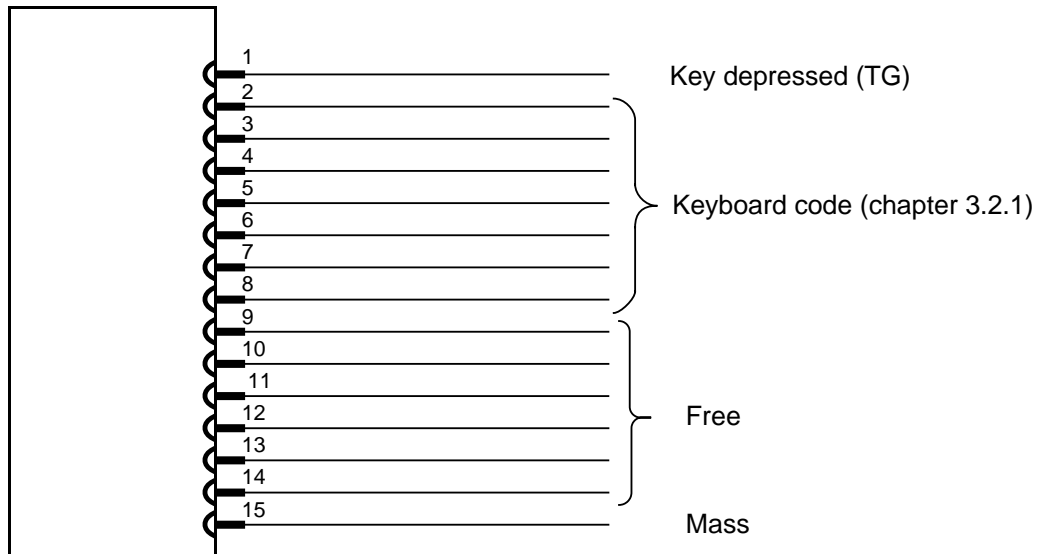

Connector
6FM1 790-8DA00
15 pole socket
Solder side

4.6.1 Connection cables for colour monitors

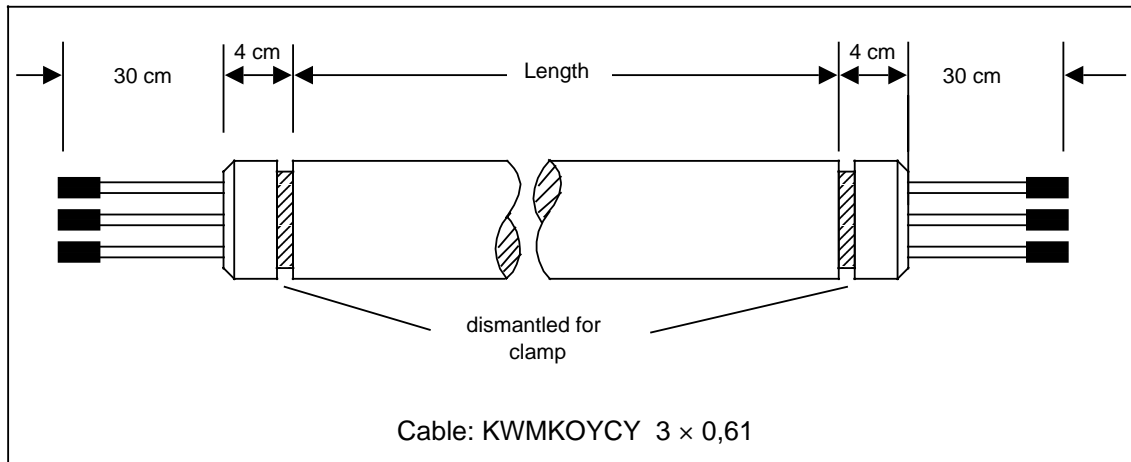
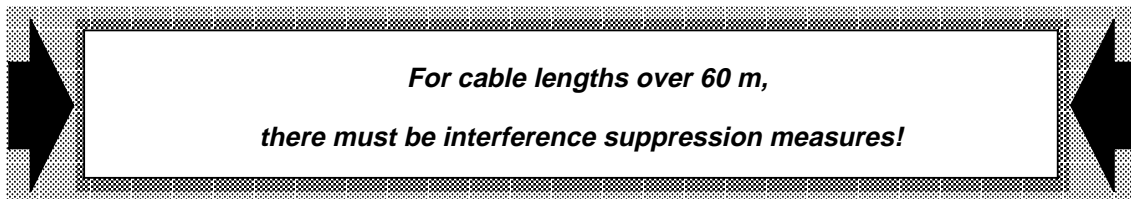

Characteristics of the cable:

3 x individual coaxial-cables, PVC shield, Polyurethane shield, additional complete shield

Connector Coaxial connector or BNC connector, depending on choice

Temperature range: - 40° C to 90° C

Resistance: against oil, coolants from VDE 472/804

Smallest bending radius: 150mm

| | | | |
|------------|---------|------|---------|
| Impedance: | 20 MHz | 6,1 | dB/100m |
| | 100 MHz | 10,8 | dB/100m |
| | 200 MHz | 21 | dB/100m |
| | 500 MHz | 34,2 | dB/100m |
| | 1 GHz | 48,1 | dB/100m |

WF 470**Colour monitor**

Order number: 6FM1 490-3B 00

3 x Coaxial socket

3 x BNC connector

Transfer device**Colour monitor**

Order number: 6FM1 490-3C 00

3 x BNC connector

3 x BNC connector

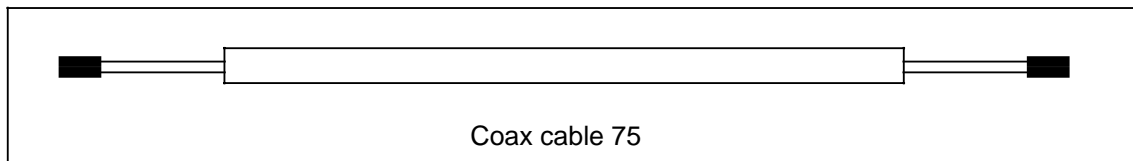
4.6.2 Connection cable for monochrome monitors**WF 470****Monochrome monitor**

Order number: 6FM1 490-3D 00

1 x Coaxial socket

1 x BNC connector

Transfer device**Monochrome monitor**

Order number: 6FM1 490-3F 00

1 x BNC connector

1 x BNC connector

4.6.3 Connection cable for the EL-display

Order number: 6FM1 490-3J 00

WF 470
X6

EL-Bus clamp

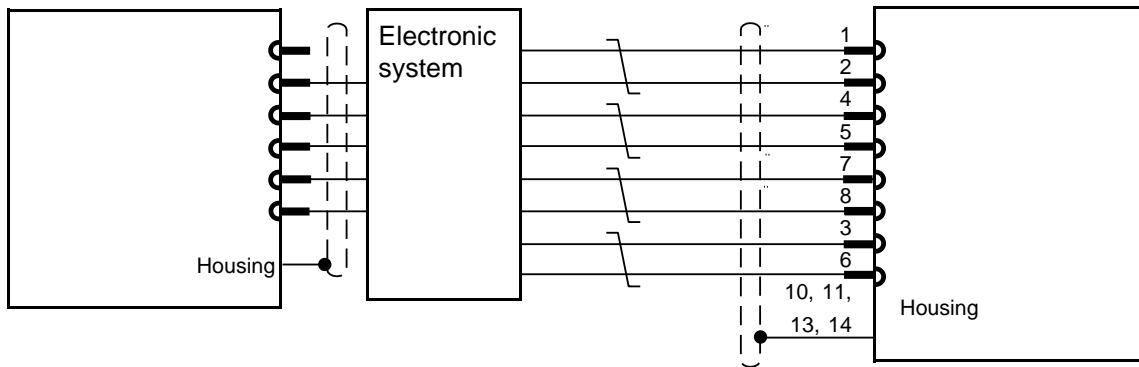

Connector
6FM1 790-8DA00
15- pole plug
Solder side

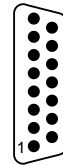

Order number: 6FM1 490-3K 00

EL-Bus clamp

EL-display
X2

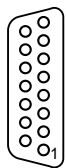
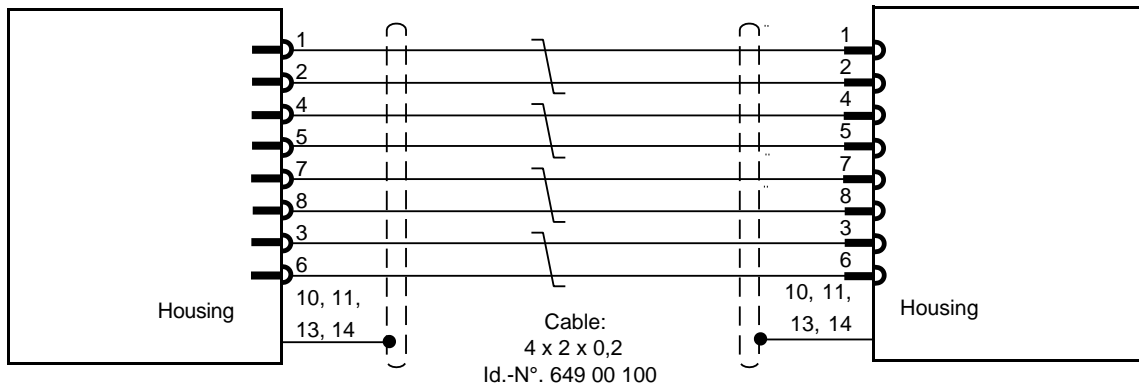

Connector
6FM1 790-8CA00
15- pole socket
Solder side

Connector
6FM1 790-8DA00
15- pole plug
Solder side

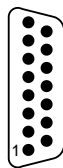

4.7 Connection for voltage supply

Operator panels with 9"-monitor:

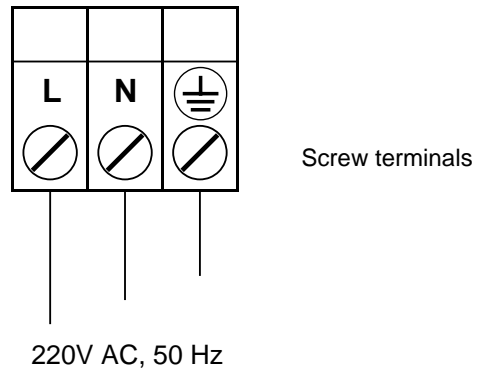

Operator panels with EL-display:

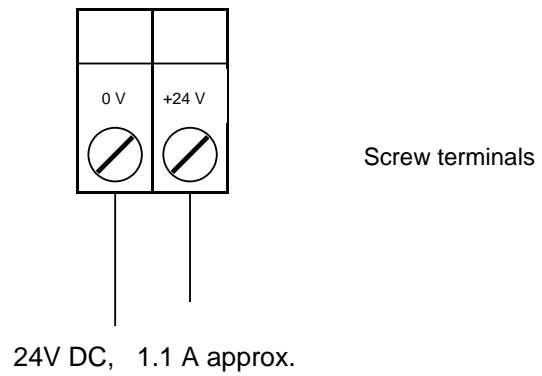

5 Technical data

| | |
|--|--|
| Keyboard | Foil keyboard with short-stroke keys |
| Interface – Keyboard – 9"-Monitor – EL-display – Alpha block | 8 Bit parallel. 24V DC BAS-Signal on BNC socket Connection only over special cable 8 Bit parallel, 24V DC |
| Operating temperature | 0 to 50°C |
| Storage temperature | - 20 to 70°C |
| Protection method front side | IP54 |
| Voltage supply – 9"-B/W-Monitor – 9"-Colour-Monitor – Alpha block – EL-display – EL-bus clamp | 115V/240V –20 % to +10 %, 47 - 63Hz, about 25W 115V/240V –20 % to +10 %, 47 - 63Hz, about 35W 115V/240V – 6 % to +10 %, 47 - 63Hz, about 10W 24V DC, about 1.1A 24V DC. about 0.35A |
| 9"-Monitor – Horizontal frequency – Vertical frequency – Resolution EL-display – Vertical frequency – Resolution | 15.625 kHz 50-60 Hz 517x387 Pixel 50 Hz 512x256 Pixel |
| Measures (B x H x T in mm). weights WS 400-10 with 9"B/W-Monitor with EL-display WS 400-20 with 9"-B/W-Monitor with 9"-Colour-Monitor with EL-display WS 400-22 with 9"-B/W-Monitor Alpha block EL-display built-in version EL - Bus clamp | 277 x 230 x 270 about 4.0 kg 277 x 230 x 83 about 2.0 kg 353 x 230 x 270 about 4.5 kg 353 x 230 x 340 about 5.0 kg 353 x 230 x 83 about 2.5 kg 353 x 255 x 270 about 5.0 kg 353 x 115 x 72 about 1.0 kg 267 x 148 x 74 about 1.4 kg 122 x 120 x 80 about 1.0 kg |
| Required space for connector (Rearside) | about 50 mm |

5.1 Operator panel WS 400-10 with 9"-Monitor

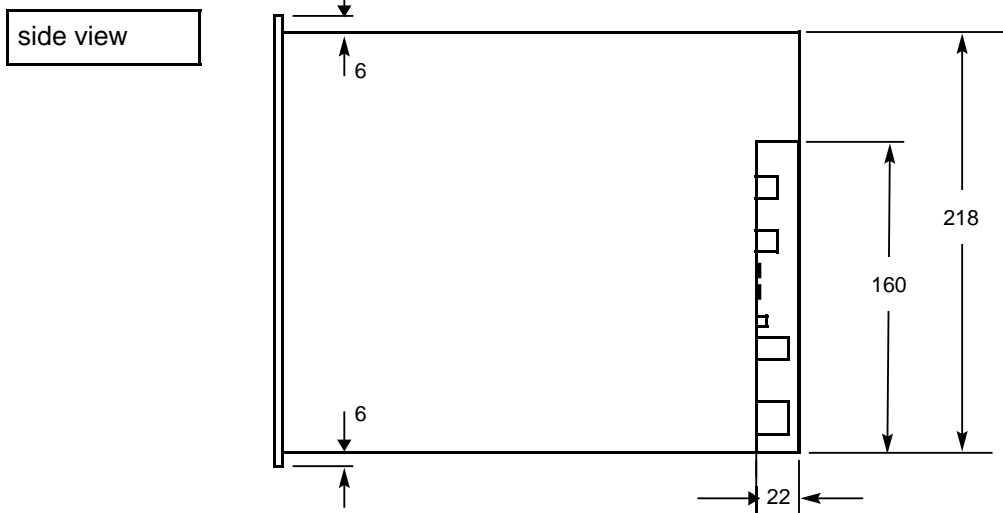
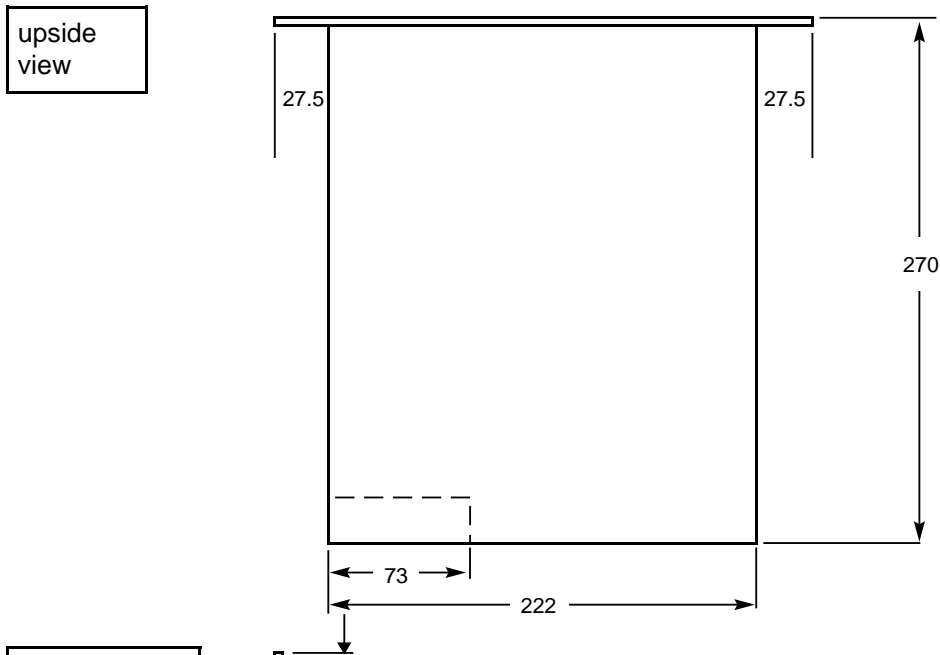
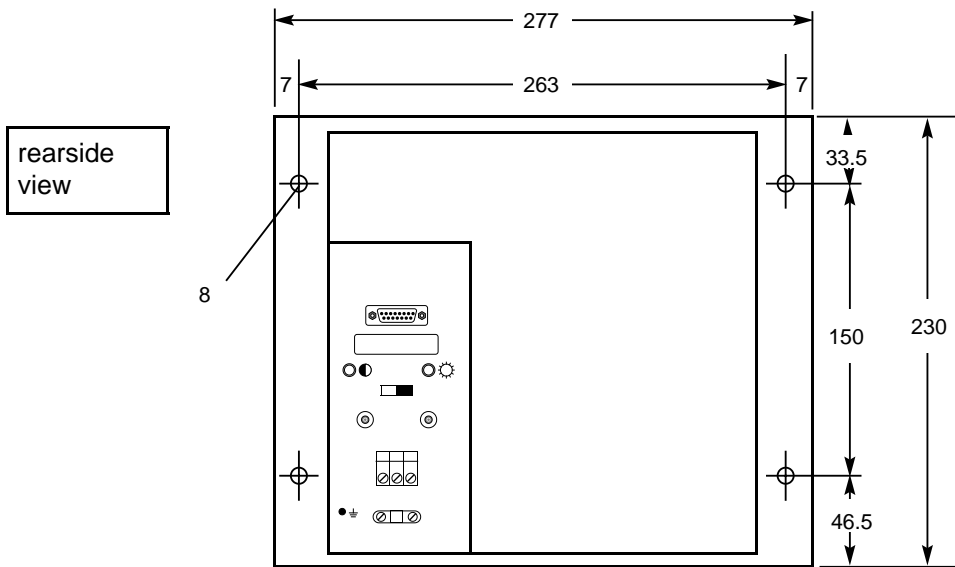

5.2 Operator panel WS 400-10 with EL-display

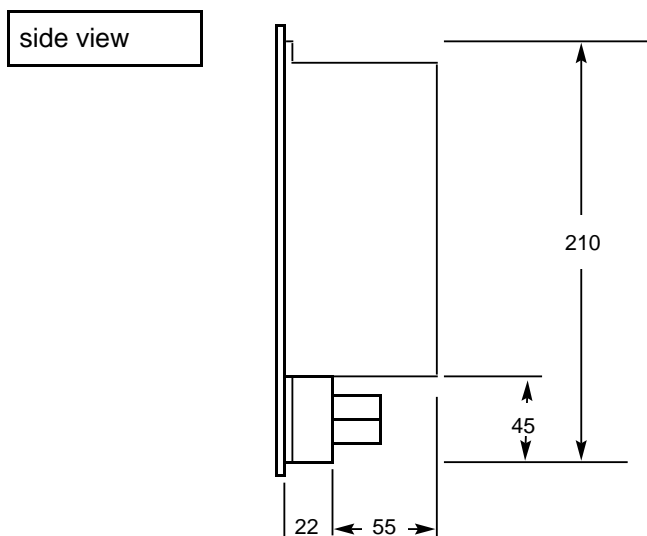
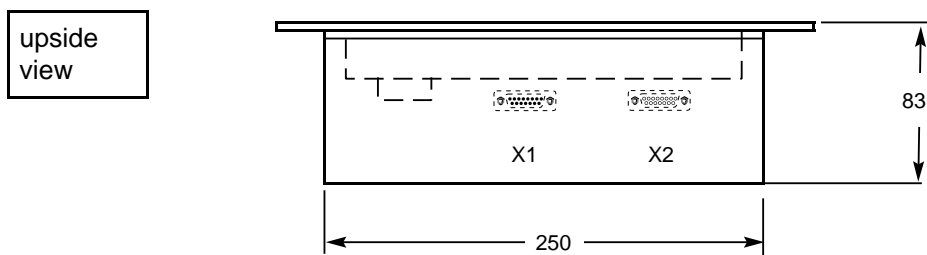
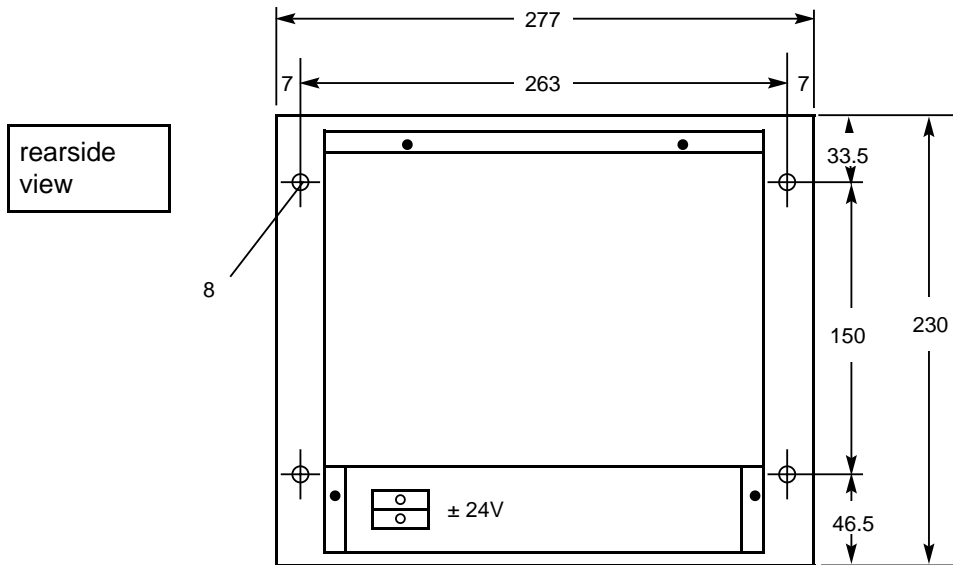

5.3 Operator panel WS 400-20 with 9" B/W-Monitor

rearside view

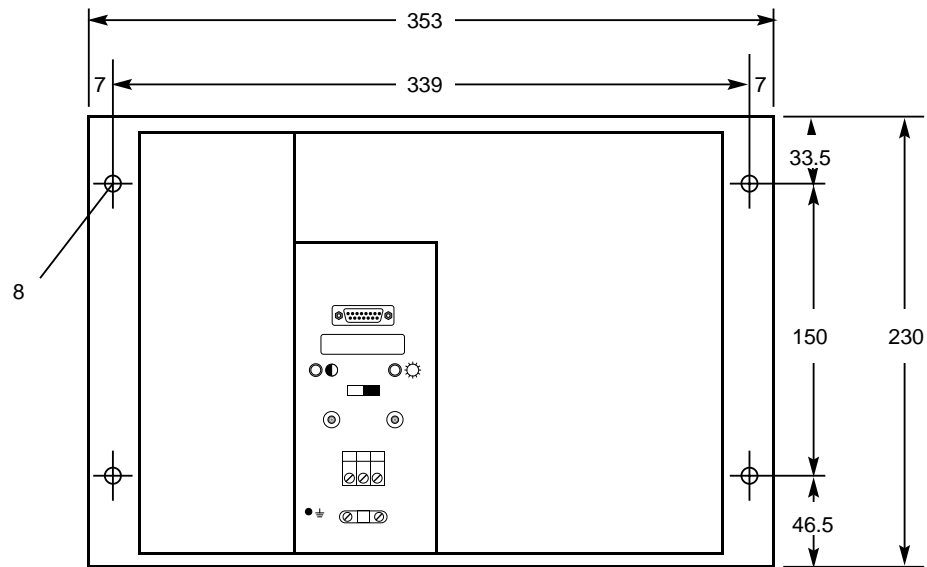

upside view

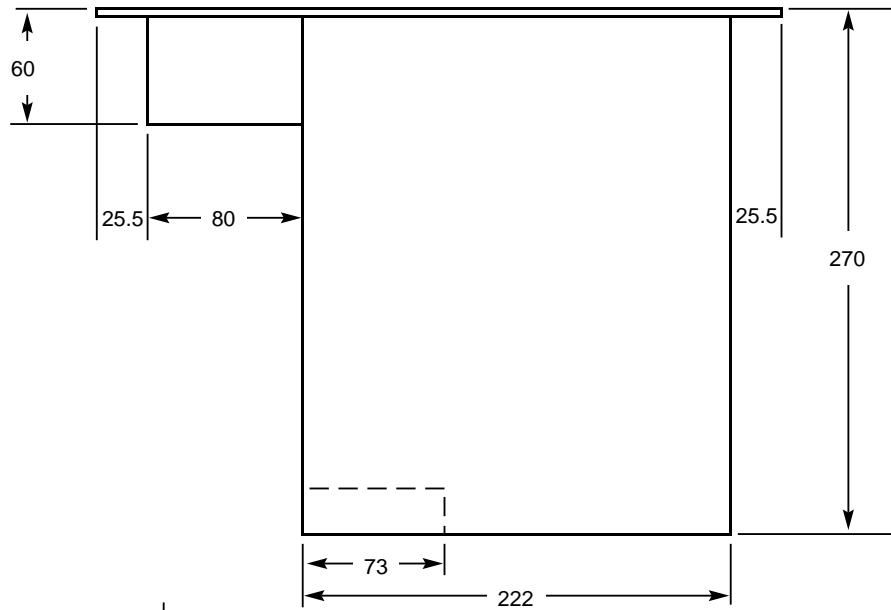

side view

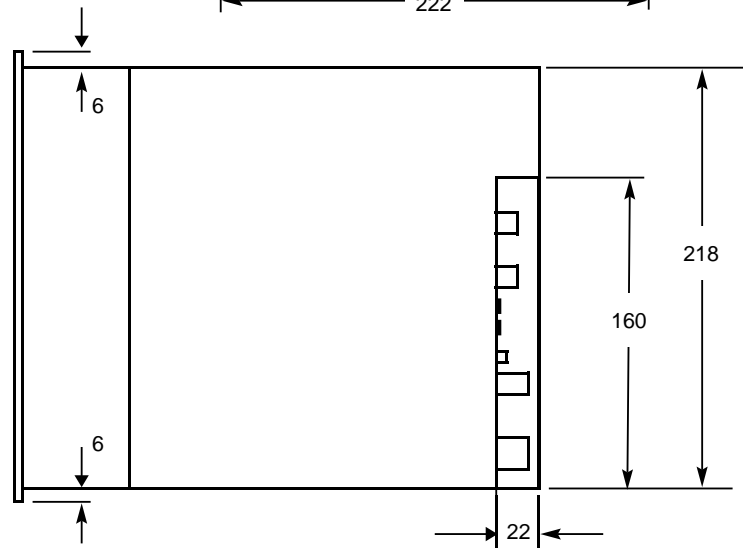

5.4 Operator panel WS 400-20 with 9" Colour-Monitor

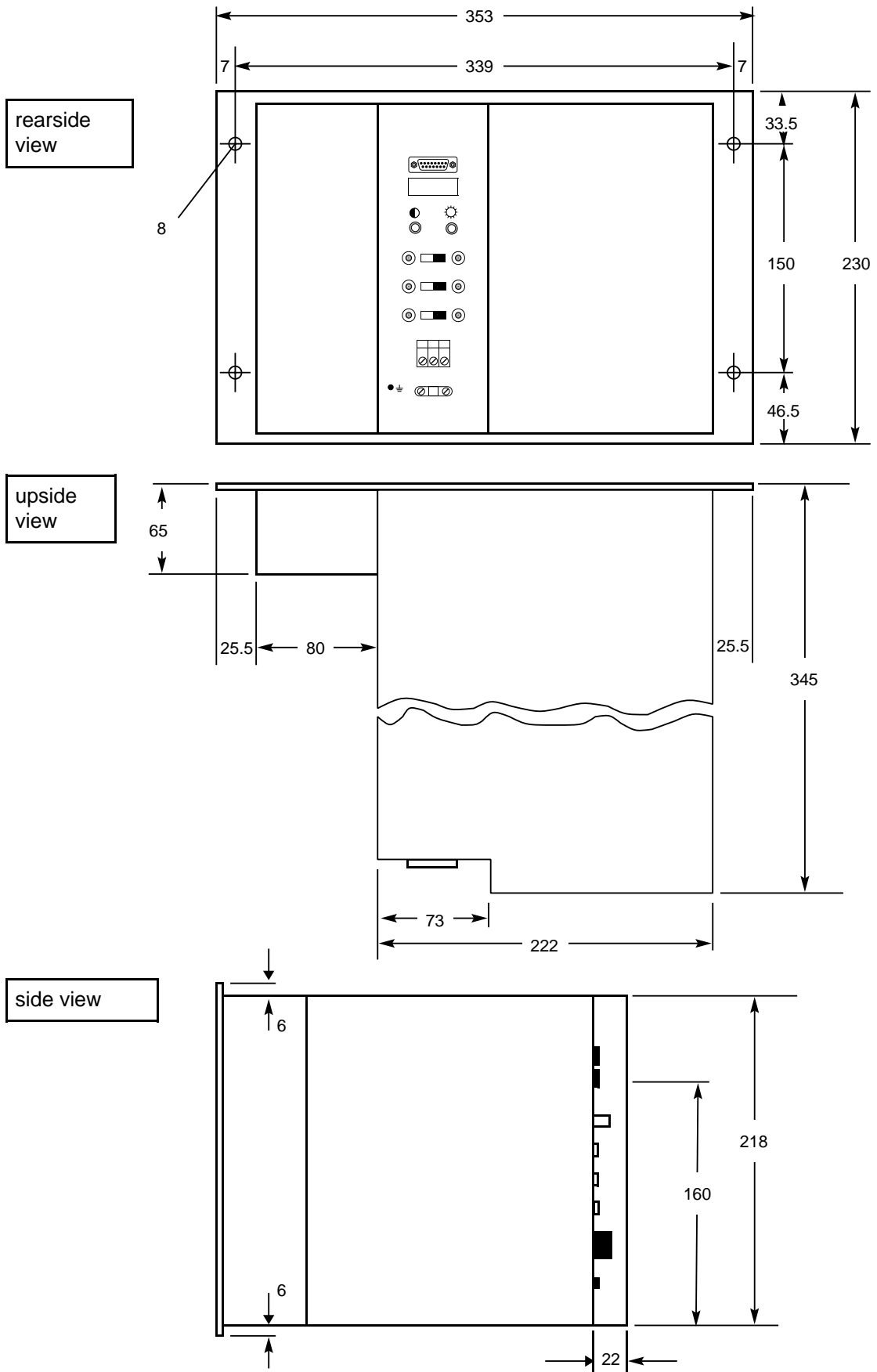

5.5 Operator panel WS 400-20 with EL-display

rearside view

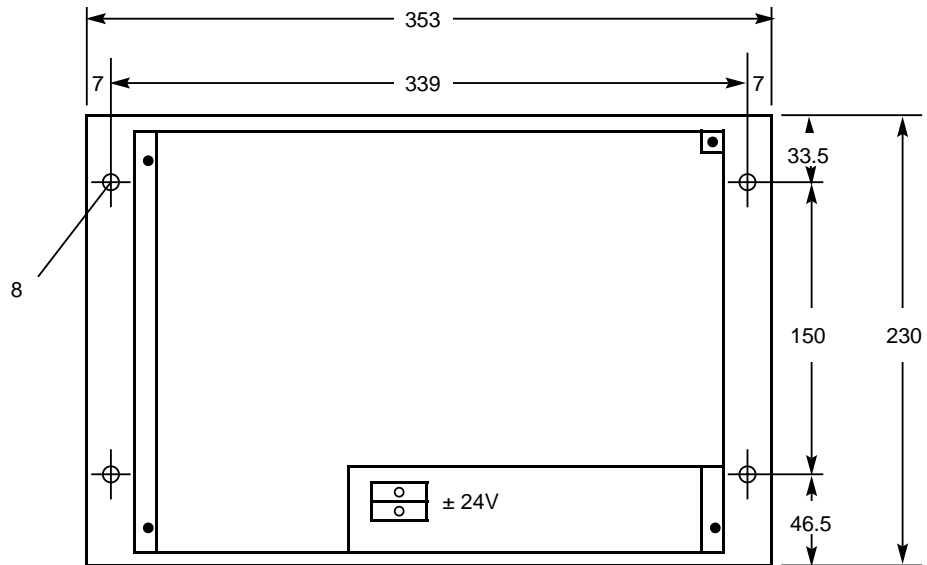

upside view

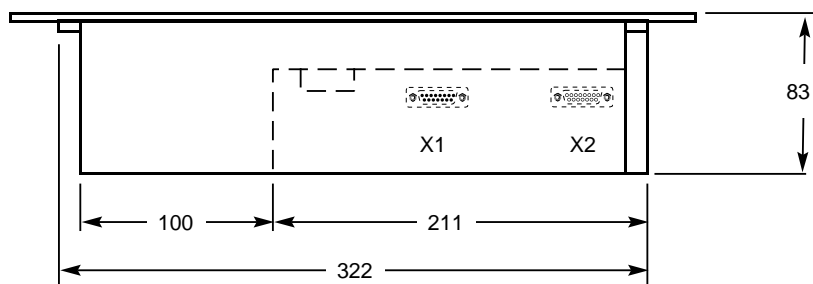

side view

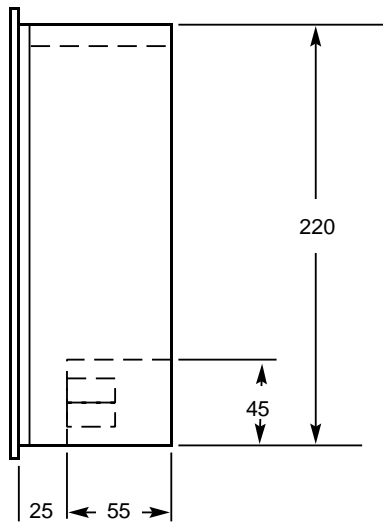

5.6 Operator panel WS 400-22 with 9" B/W-Monitor

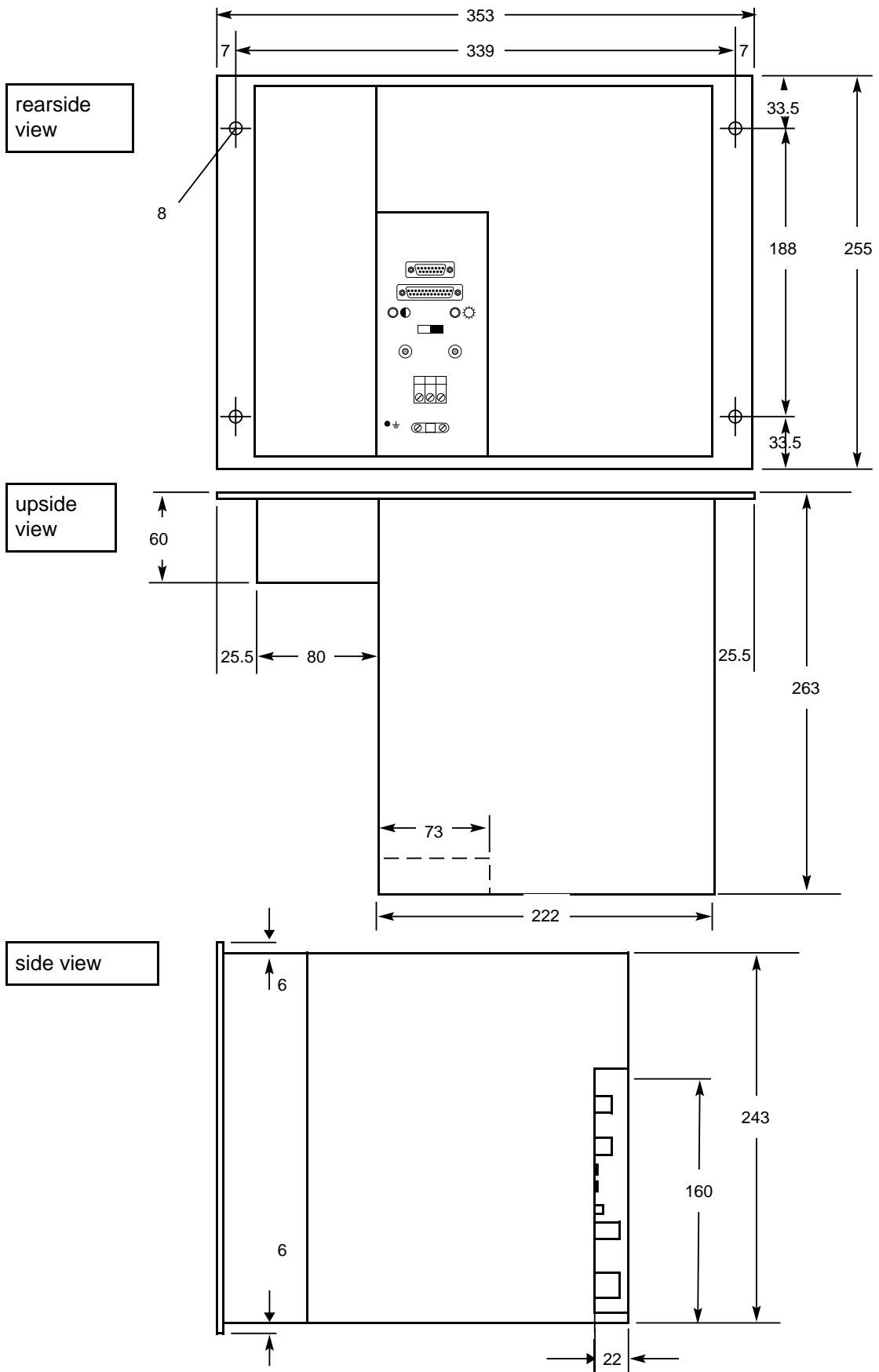

5.7 Alpha block

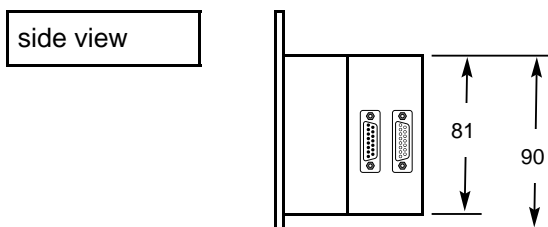
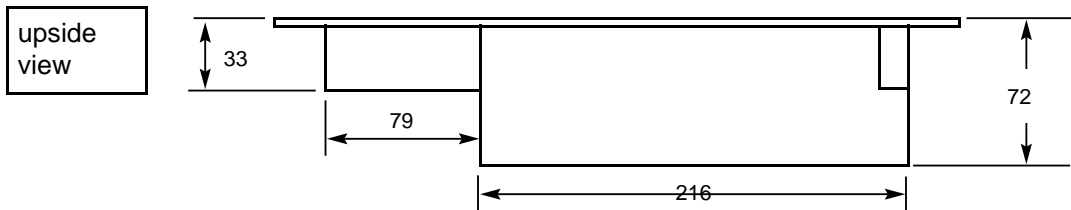
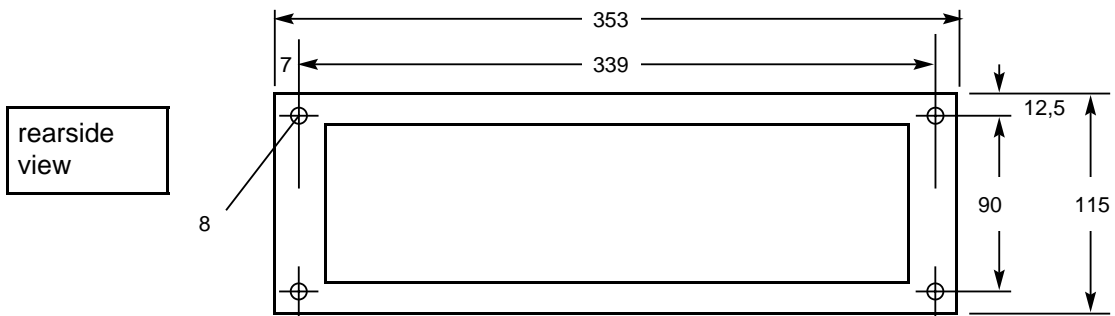

5.8 EL - Bus clamp

upside view

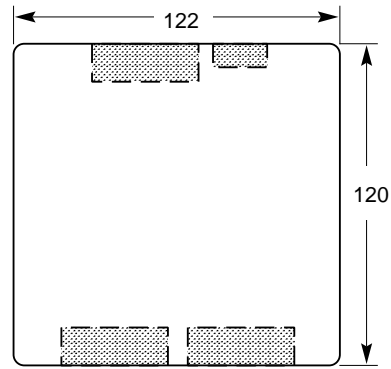

side view

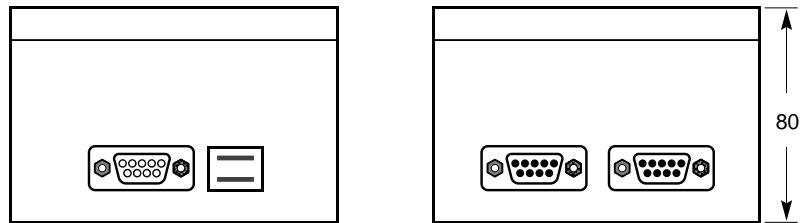

Drilling pattern for mounting

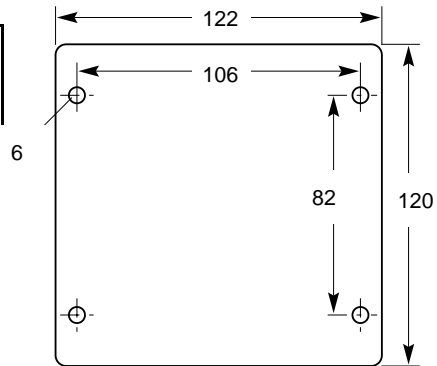

6 Ordering data

| Hardware | | Order number |
|----------------|---|--|
| WS 400-10 | with 9"-Monitor,B/W with EL - display | 6FM1 410-1AA00 6FM1 410-1CA00 |
| WS 400-20 | with 9"-Monitor, B/W mit 9"- Colour Monitor with EL - display | 6FM1 420-1AA00 6FM1 420-1BA00 6FM1 420-1CA00 |
| WS 400-22 | with 9"-B/W-Monitor | 6FM1 422-1AA00 |
| Alpha block | | 6FM1 420-2AA00 |
| EL - display | Built-in version | 6FM1 496-2FA00 |
| EL - Bus clamp | | 6FM1 496-8AA00 |

| Length key | |
|-------------|---|
| Length 2 m | A |
| Length 5 m | B |
| Length 10 m | C |
| Length 18 m | D |
| Length 25 m | E |
| Length 35 m | F |
| Length 50 m | G |
| Length 60 m | H |

| Connector | Order number |
|-----------------------|----------------|
| for X 1 (Key signals) | 6FM1 790-8CA00 |
| for X 2 (LEDs) | |
| for X 3 (Key signals) | 6FM1 790-8DA00 |

| Documentation | Order number |
|-------------------------------|---------------------|
| Description WF 470 | 6ZB5 440-0JF02-0BA2 |
| Product Brief WF 470 | 6ZB5 440-0FV02-0BA0 |
| Product Brief WS 400-10/20/22 | 6ZB5 440-0AK02-0AB0 |

| Cables | | Order number |
|--|---|--------------------------------------|
| from WF 470 (X3, X4, X5) to RGB-BAS-Colour-monitor or to Transfer device | Length 2 m to 60 m Special length ¹⁾ (Length specification required) | 6FM1 490-3B 00 6FM1 490-3BZ00 |
| from Transfer device or from RGB-BAS-Colour-monitor to RGB-BAS-Colour-monitor | Length 2 m to 35 m Special length ¹⁾ (Length specification required) | 6FM1 490-3C 00 6FM1 490-3CZ00 |
| from WF 470 X4 to Monochrome-monitor or to Transfer device | Length 2 m to 60 m Special length ¹⁾ (Length specification required) | 6FM1 400-3D00 6FM1 496-2FA00 |
| from Transfer device or from Monochrome-monitor to Monochrome-monitor | Length 2 m to 60 m Special length ¹⁾ (Length specification required) | 6FM1 490-3F 00 6FM1 490-3FZ00 |
| from WF 470 (X6) to EL - display or to EL - Bus clamp | Length 2 m to 18 m Special length max. 18 m | 6FM1 490-3J 00 6FM1 490-3JZ00 |
| from EL -Bus clamp to EL - display or to EL - Bus clamp | Length 2 m to 18 m Special length max. 18 m | 6FM1 490-3K 00 6FM1 490-3KZ00 |

Siemens AG

AUT V260
Postfach3180
D-91050 Erlangen
Fed. Rep. of Germany

Corrections

For Publication/Manual:
Equipment for special machines
WS 400-10/20/22
Operator panels

Description

Order-No.: 6ZB5 440-0AR02-0BA3
Edition: November 1991

From:

Name _____

Company/Dept. _____

Address _____

Telephone _____ /

If you find any printing errors when reading this publication, please let us know, using this form. We also welcome any suggestions to improve the manual.

Suggestions and/or corrections