

Operating Instructions Edition 02/2006

SIMATIC VS120
Image Processing Systems

simatic sensors

SIEMENS

SIEMENS

SIMATIC Sensors

Image processing systems Vision Sensor SIMATIC VS120

Operating Instructions

Introduction	1
Safety instructions	2
Description	3
Image processing	4
Network and system integration	5
Installation	6
Connecting	7
Commissioning	8
Operation	9
Process interfacing over an automation system (PLC, PC)	10
Alarm, error and system messages	11
Technical data	12
Dimension drawings	13
Scope of delivery/Spares/Accessories	14
Service & Support	15
Directives and declarations	16

Safety Guidelines

This manual contains notices you have to observe in order to ensure your personal safety, as well as to prevent damage to property. The notices referring to your personal safety are highlighted in the manual by a safety alert symbol, notices referring only to property damage have no safety alert symbol. These notices shown below are graded according to the degree of danger.



Danger

indicates that death or severe personal injury **will** result if proper precautions are not taken.



Warning

indicates that death or severe personal injury **may** result if proper precautions are not taken.



Caution

with a safety alert symbol, indicates that minor personal injury can result if proper precautions are not taken.

Caution

without a safety alert symbol, indicates that property damage can result if proper precautions are not taken.

Notice

indicates that an unintended result or situation can occur if the corresponding information is not taken into account.

If more than one degree of danger is present, the warning notice representing the highest degree of danger will be used. A notice warning of injury to persons with a safety alert symbol may also include a warning relating to property damage.

Qualified Personnel

The device/system may only be set up and used in conjunction with this documentation. Commissioning and operation of a device/system may only be performed by **qualified personnel**. Within the context of the safety notes in this documentation qualified persons are defined as persons who are authorized to commission, ground and label devices, systems and circuits in accordance with established safety practices and standards.

Prescribed Usage

Note the following:



Warning

This device may only be used for the applications described in the catalog or the technical description and only in connection with devices or components from other manufacturers which have been approved or recommended by Siemens. Correct, reliable operation of the product requires proper transport, storage, positioning and assembly as well as careful operation and maintenance.

Trademarks

All names identified by ® are registered trademarks of the Siemens AG. The remaining trademarks in this publication may be trademarks whose use by third parties for their own purposes could violate the rights of the owner.

Disclaimer of Liability

We have reviewed the contents of this publication to ensure consistency with the hardware and software described. Since variance cannot be precluded entirely, we cannot guarantee full consistency. However, the information in this publication is reviewed regularly and any necessary corrections are included in subsequent editions.

Table of contents

1	Introduction	1-1
2	Safety instructions	2-1
3	Description	3-1
3.1	Product description	3-1
3.2	Performance features	3-2
3.3	Function	3-3
3.4	System components	3-4
3.5	System requirements	3-5
3.6	Design of the SIMATIC VS120 processing unit.....	3-6
3.7	Design of the sensor head with LED ring flash.....	3-8
4	Image processing	4-1
4.1	General information	4-1
4.2	Shutter Speed and Brightness	4-2
4.2.1	Different exposures and brightnesses	4-2
4.2.2	Disturbing contours caused by shine.....	4-3
4.3	Generating models and detecting orientation	4-5
4.3.1	Setting for the Precision parameter	4-5
4.3.2	Measures for optimizing object recognition	4-6
4.4	Quality of the measured values	4-7
4.5	Geometric distortion.....	4-8
4.6	Main ROI and sub-ROI	4-8
4.6.1	Example: Main ROI and 3 sub-ROIs	4-9
4.6.2	Example of the influence of sub-ROIs on the quality value	4-10
4.7	Job parameter.....	4-13
4.8	Search parameter	4-16
4.9	Model type parameter.....	4-17
4.10	Model sets.....	4-19
5	Network and system integration	5-1
5.1	Overview	5-1
5.2	System configuration over digital I/O	5-2
5.3	PROFIBUS DP system configuration	5-3
5.4	PROFINET IO system configuration.....	5-4
5.5	System configuration with Ethernet or RS-232 over Com server	5-5

6	Installation	6-1
6.1	Installing the SIMATIC VS120 processing unit	6-1
6.2	Installing the sensor head with LED ring flash	6-1
7	Connecting	7-1
7.1	Guidelines on installation and avoiding electrical interference	7-1
7.2	Guidelines on installation when using PROFIBUS DP or PROFINET IO	7-1
7.3	Connecting components	7-2
8	Commissioning	8-1
8.1	Prerequisites	8-1
8.2	Overview of the steps in commissioning	8-2
8.3	Turn on the VS120 processing unit	8-3
8.4	Establish an Ethernet connection between the processing unit and PG / PC	8-5
8.4.1	Select the connection variant	8-5
8.4.1.1	Connection variants	8-5
8.4.1.2	Operating the VS120 processing unit as a DHCP server	8-6
8.4.1.3	Connecting the VS120 processing unit manually	8-7
8.4.1.4	Integrating the VS120 processing unit as a DHCP client in a network	8-9
8.4.1.5	Integrating the VS120 processing unit as a device in a PROFINET IO network	8-10
8.4.2	Check whether a proxy server is being used	8-12
8.4.3	Change the proxy configuration of your Internet Explorer	8-13
8.4.4	Check the connection	8-14
8.5	Start setup support over the Internet Explorer	8-15
8.6	Adjust the sensor head using setup support	8-17
9	Operation	9-1
9.1	Overview	9-1
9.2	Working with the processing unit	9-1
9.2.1	Introduction	9-1
9.2.2	Adjust	9-2
9.2.3	Connect	9-2
9.2.4	RUN	9-9
9.2.5	Options	9-15
9.2.6	Maintain	9-18
9.3	Working with setup support	9-19
9.3.1	Introduction	9-19
9.3.2	Adjust Sensor	9-24
9.3.3	Connections	9-25
9.3.4	Train	9-27
9.3.5	Processing	9-33
9.3.6	Options	9-37
9.3.7	Information	9-43
9.3.8	Maintain	9-49
9.3.9	Stop	9-51
10	Process interfacing over an automation system (PLC, PC)	10-1
10.1	Integrating the PROFIBUS DP slave SIMATIC VS120 in HW Config	10-1
10.2	Integrating the PROFINET IO device SIMATIC VS120 in HW Config	10-4
10.3	Control over the "DI/DO" I/O interface	10-7

10.4	Control over PROFIBUS DP and PROFINET IO	10-10
10.4.1	Principle of data transfer over PROFIBUS DP and PROFINET IO	10-10
10.4.2	Assignments for PROFIBUS DP / PROFINET IO-relevant interfaces for the processing unit	10-11
10.4.2.1	Control byte	10-11
10.4.2.2	Status byte	10-12
10.4.2.3	User data interface "Send" VS120 processing unit >>> automation system	10-12
10.4.2.4	User data interface "Receive" automation system >>> VS120 processing unit	10-14
10.4.3	Programming data fragmentation	10-14
10.5	Function block FB1	10-16
10.5.1	Job	10-16
10.5.2	Parameter	10-17
10.5.3	Operator control	10-19
10.5.4	Error information	10-20
10.6	Sample programs	10-21
10.6.1	Example 1: Program for interfacing the SIMATIC VS120 processing unit with a SIMATIC controller using FB1	10-21
10.6.2	Example 2: Program for archiving diagnostic information on a PC/PG	10-23
11	Alarm, error and system messages	11-1
11.1	Overview	11-1
11.2	Error messages and error handling	11-1
11.3	Diagnostics based on the "BF" LED	11-10
11.4	Slave diagnostics or /O device diagnostics	11-11
12	Technical data	12-1
12.1	General technical specifications	12-1
12.2	Technical specifications of SIMATIC VS120	12-5
12.3	Port assignment of the processing unit	12-8
13	Dimension drawings	13-1
13.1	SIMATIC VS120 processing unit	13-1
13.2	SIMATIC VS120 sensor head	13-2
13.3	SIMATIC VS120 lighting unit	13-3
14	Scope of delivery/Spares/Accessories	14-1
14.1	Components	14-1
14.2	Full packages	14-2
14.3	Accessories	14-4
14.4	C-mount lens and inspection window size	14-5
15	Service & Support	15-1
15.1	A&D Mall / Interactive Catalog (CA01)	15-1
15.2	Service and support	15-1
16	Directives and declarations	16-1
	Glossary	Glossary-1
	Index	Index-1

Introduction

Purpose of the manual

This manual contains all the information you require to install, commission and work with the SIMATIC VS120 Vision Sensor System.

It is intended both for persons configuring and installing automated plants with image processing systems and for service and maintenance technicians.

Scope of this manual

The manual is valid for all supplied versions of the SIMATIC VS120 Vision Sensor system and the processing unit with order number (MLFB) 6GF1 018-2AA10.

Safety instructions



Caution

Please observe the safety instructions on the back of the cover sheet of this documentation. You should not make any expansions to your device unless you have read the relevant safety instructions.

This device meets the relevant safety requirements in compliance with IEC, VDE, and EN. If you have questions about the validity of the installation in the planned environment, please contact your service representative.

Repairs

Only authorized personnel are permitted to repair the device.



Warning

Unauthorized opening of and improper repairs to the device may result in substantial damage to equipment or risk of personal injury to the user.

System expansion

Only install system expansions intended for this device. If you install other upgrades, you may damage the system or violate the safety requirements and regulations for radio frequency interference suppression. Contact your technical support team or where you purchased your device to find out which system expansion devices may safely be installed.

Caution

If you install or exchange system expansions and damage your device, the warranty becomes void.

Description

3.1 Product description

The SIMATIC VS120 Vision Sensor is used for the optical detection and testing of objects with lighting from above. The SIMATIC VS120 Vision Sensor checks whether or not the correct object is being tested, whether or not it is damaged and the position of the object.

The SIMATIC VS120 Vision Sensor returns the following recognition values during object recognition:

- x coordinate
- y coordinate
- Angle
- Quality rating of the specimen, number of detected parts

This object recognition data is transferred to processing units in automation systems. The data is processed in the processing units of the automation systems.

The SIMATIC VS120 Vision Sensor is suitable for:

- Recognition of parts in sorting tasks
- Determining the position for Pick & Place applications
- Checking the presence and position of objects in production
- Checking position in feed systems, for example with oscillating conveyors, workpiece holder, conveyor belts, circulating systems, grasper units and robots.
- Quality control of specimens

3.2 Performance features

- Overhead lighting head with LED ring flash
- Object recognition with object search and object test
- Commissioning using adjustment support on the PG / PC with installed Internet Explorer
- Up to 20 objects tested per second
- Up to 64 specimens can be stored
- Two digital outputs are available for sorting the specimens: OK, N_OK
- Fully Web-based user interface
- Extensive operator control and monitoring functions even in the processing mode
- Wide-ranging diagnostics and logging functions: Error image memory and event logging
- Firmware update using operator interface of the Web browser
- Control via Digital I/O, PROFIBUS DP and PROFINET IO
- Result output via:
 - PROFIBUS DP
 - PROFINET IO
 - RS-232 port of an RS-232 Ethernet converter
 - TCP/IP connection of the PC / PG

3.3 Function

Testing correctness of individual characteristics of the specimen

64 models are available for the recognition of specimens. The SIMATIC VS120 checks whether or not the individual characteristics of the specimens have the same shape as the in the trained model.

When specifying the recognition and evaluation areas, avoid shiny surfaces on specimens.

Principle of edge recognition

To recognize image patterns, edges are used. These edges from the images are the transitions from light to dark or vice versa. A model is created from the sum of the edges extracted in the image and their arrangement.

Recognition and localization of parts

The SIMATIC VS120 scans specimens and determines the coordinates including the roll angle and passes them to the control system such as S7, for example, via PROFIBUS DP.

Testing the completeness of a model

The SIMATIC VS120 also checks specimens for completeness. Deviations from the trained model are detected and the quality values of the evaluation are displayed.

Sorting functions for models and model sets

Depending on the importance of the application, 15 model sets with 64 different models can be assembled and saved for processing. The models are sorted according to the application with a controller for processing with the SIMATIC VS120.

3.4 System components

SIMATIC VS120 Vision Sensor full package comprising:

- Sensor
- Processing unit
- Lighting
- Cable

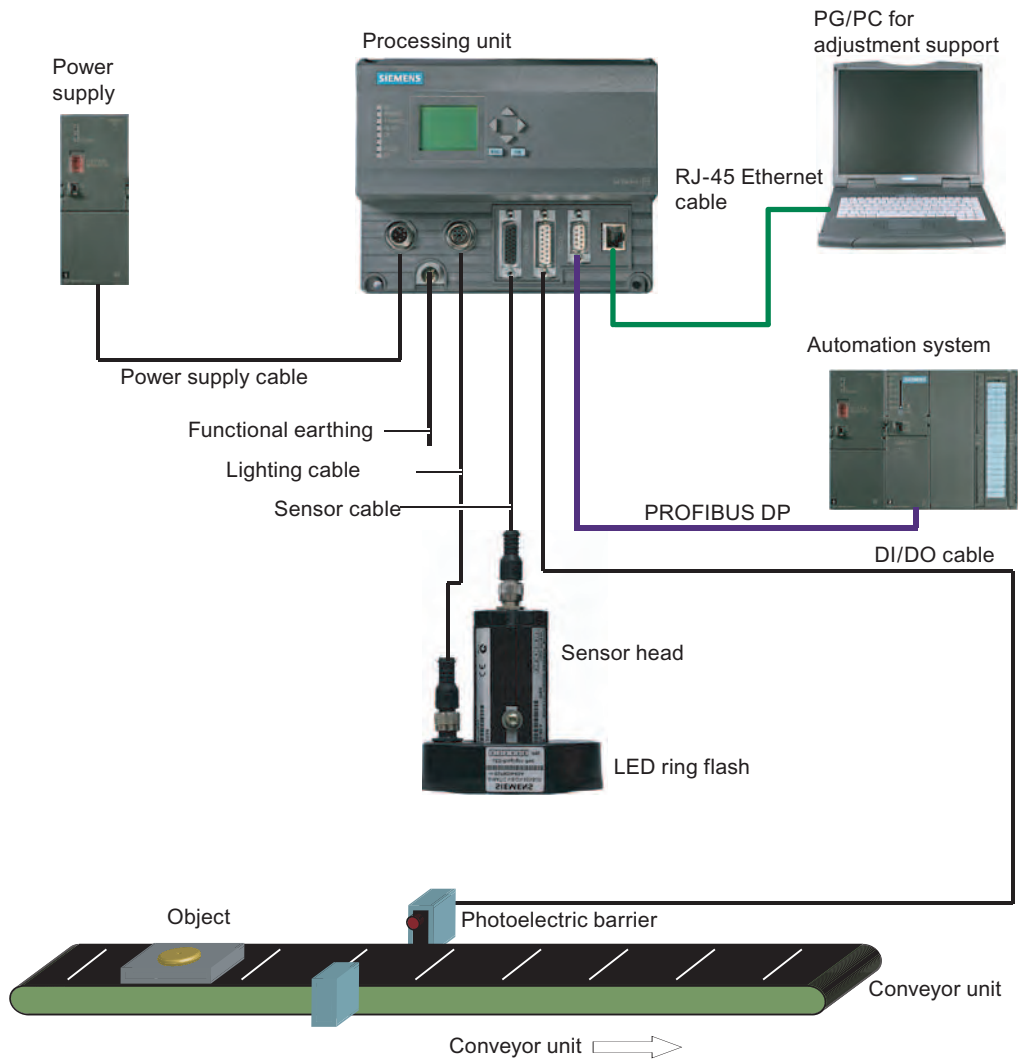

Figure 3-1 Example of a typical system configuration with conveyor system

3.5 System requirements

You require the following hardware and software components for the SIMATIC VS120 Vision Sensor system:

Hardware

- SIMATIC VS120 processing unit
- Sensor head with CCD sensor chip for detection of the object
- LED ring flash for SIMATIC VS with degree of protection IP65 (not included in every full package), for optimum illumination of the object
- Cables:
 - Power supply cable
 - Lighting cable
 - Sensor cable
 - DI / DO cable
- Documentation package
 - Operating Instructions (compact)
 - Documentation CD

You also require the following:

- 24 V DC, 2 A power supply; (20.4...28.8 V DC, safety extra low voltage, SELV).
- PC / PG with the following configuration:
 - At least 500 MHz clock frequency
 - Graphics card with at least 65536 colors and a resolution of at least 1024 x 768 pixels
 - Ethernet port with up to 100 Mbps (protocol: TCP/IP)
- Crossover RJ-45 Ethernet cable for connecting the processing unit and the PC / PG

Software

- Microsoft Windows XP Professional SP1 operating system with Internet Explorer 6.0 as of SP1
- Microsoft Java VM or Sun Java VM version J2SE 1.4.2_06 or J2SE 5.0 (you will find more detailed information on the Internet at the following address <http://www.java.sun.com/J2SE>)

3.6 Design of the SIMATIC VS120 processing unit

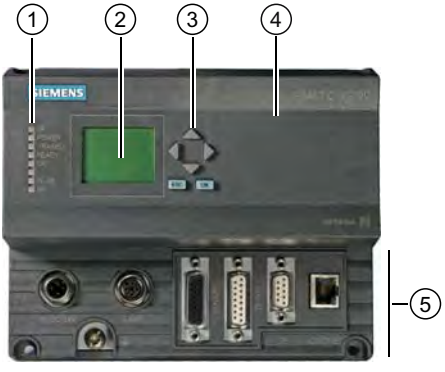
VS120 processing unit (MLFB 6GF1 018-2AA10)	Item No.	Meaning
	(1)	Status LEDs
	(2)	LCD display
	(3)	Keypad
	(4)	Housing consisting of hood and base
	(5)	Interfaces

Status LEDs	LEDs	Color	Meaning
	SF	Red	General fault
	POWER	Green	Power supply is turned on
	TRAINED	Green	Selected model has been trained
	READY	Green	<ul style="list-style-type: none"> • off = device startup or SIMATIC VS120 in Stop • on = SIMATIC VS120 in Run
	OK	Green	Result good: Model was recognized
	-	Green	-
	N_OK	Yellow	Result bad: Object was not recognized
	BF	Red	Bus fault on PROFIBUS DP or PROFINET IO

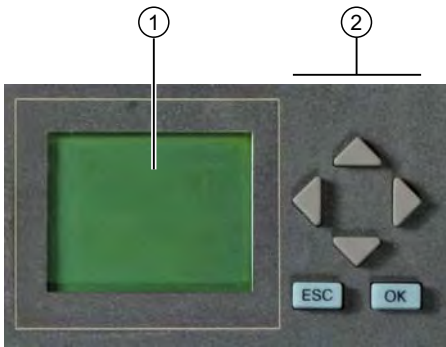
LCD display and keypad	Item No.	Designation	Meaning
	(1)	LCD display	Displays menu commands (lines 1 to 3) and the keys that are currently available (line 4)
	(2)	Keypad	Navigation from menu to menu and within the menus

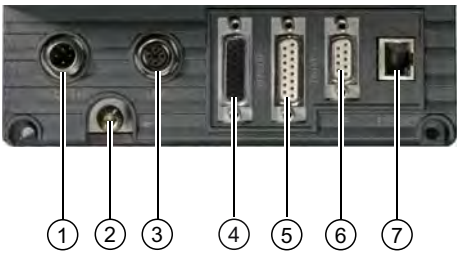
Interfaces	Item No.	Meaning
	(1)	Supply voltage 24 V DC, circular M12 connector
	(2)	Functional ground with M5 screw-type connector
	(3)	Lighting unit, circular M12 connector
	(4)	Sensor head, HD D-sub connector, 26-pin
	(5)	I/O, D-sub connector, 15-pin
	(6)	PROFIBUS DP, D-sub connector, 9-pin
	(7)	Ethernet / PROFINET IO; RJ-45 plug

Description

3.7 Design of the sensor head with LED ring flash

3.7 Design of the sensor head with LED ring flash

Sensor head with LED ring flash	Item No.	Meaning
	(1)	Circular connector M12
	(2)	Sensor head
	(3)	LED ring flash (not supplied with all full packages)
	(4)	Lens, permanently installed and non-adjustable (fixed focus version)

Image processing

4.1 General information

To form patterns that can be recognized, edges (transitions from light to dark or vice versa) from the image are used. Although the algorithm extracts the edges automatically, the user must make sure that the lighting is ideal for an image with good contrast; in other words, to create models for recognition, it is essential to use the lighting correctly to achieve an image with high contrast.

Note

The installation of suitable lighting often involves more time than all the other activities such as securing the camera, connecting to the PLC, training, setting the correct triggers etc. together. With metallic surfaces in particular, it is advisable to ask the advice of a lighting expert due to the possible shine.

Part of object recognition is the recognition of the position of the object in the image. The starting point is the midpoint of the image to which all coordinates relate. The top left has the coordinates (-320; 240) and bottom right (320; -240).

If the object is not recognized, the position at the top left is output for x / y. The user should always query whether or not this is an OK / N_OK evaluation and not rely on the x / y positions!



4.2 Shutter Speed and Brightness

Correct exposure time (shutter speed) influences the quality of the extracted edges. To control the exposure time / brightness, you can use the parameters Shutter speed and Brightness.

The shutter speed / brightness must be set to obtain the optimum contrast. The automatic exposure control can help to achieve the optimum shutter speed setting.

Below, you will find examples of different shutter speeds and disturbing contours:

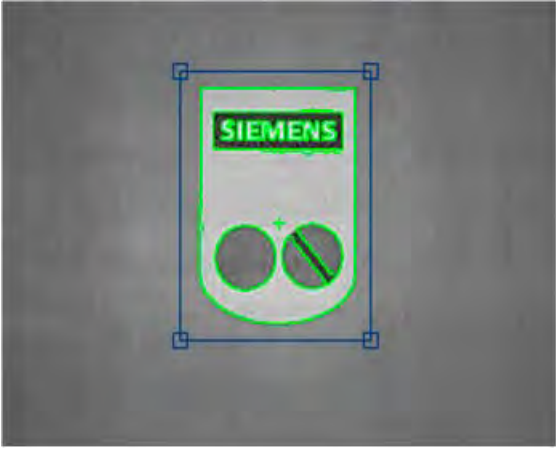
4.2.1 Different exposures and brightnesses

Correct exposure		Shutter speed: 3800 Brightness: 357
Overexposure		Shutter speed: 6000 Brightness: 357 or Shutter speed: 3800 Brightness: 500

<p>Underexposure</p>	 A grayscale image of a Siemens logo with green edge detection overlays. The logo is underexposed, making it difficult to distinguish from the background. The word 'SIEMENS' is at the top, and there are two circles below it. A blue bounding box surrounds the entire logo area.	<p>Shutter speed: 800 Brightness: 357 or Shutter speed: 3800 Brightness: 93</p>
----------------------	--	--

4.2.2 Disturbing contours caused by shine

Shiny areas on the surfaces of the part cause disturbing edges that must be avoided for a representative model. In the example shown below, you can see clearly that even the automatic shutter control can cause bad edges in this case. These edges make recognition of the parts unreliable since they are often not reproducible.

Unwanted edge lines

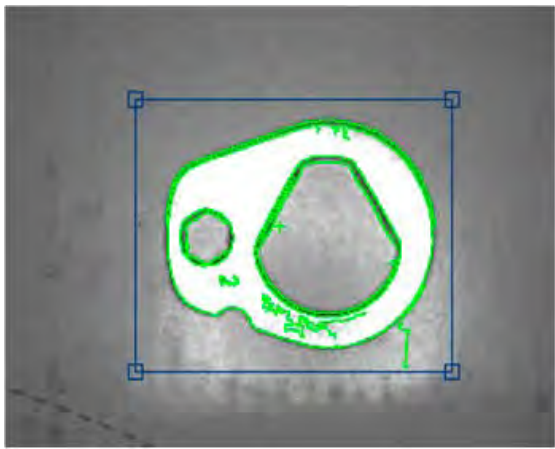
 A grayscale image of a Siemens logo with green edge detection overlays. The logo is underexposed, causing bright, shiny areas that create unwanted edge lines. A blue bounding box surrounds the entire logo area.	<p>In the trained model shown here, you can see unwanted edge lines that reduce quality during the search and recognition and therefore ought to be avoided.</p>
--	--

Remedy by manual overexposure

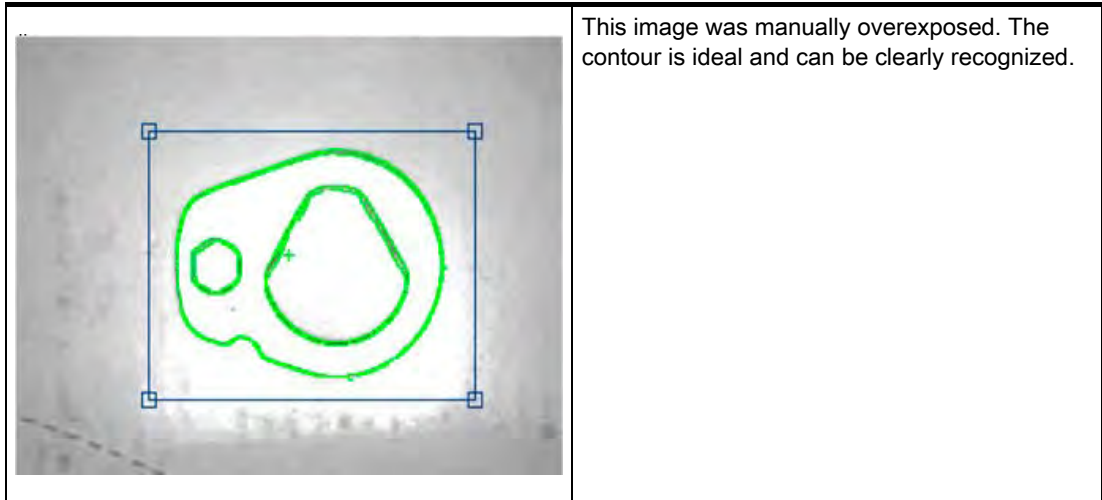

If this method cannot be used, the user can do the following:

- Use the erasure function on the edges of the model to enable optimally training for the contour
- Correct the problem by setting the shutter speed offset for automatic exposure control

Other interference affecting object recognition

In addition to the previously mentioned interference, other factors can also have a negative influence on the search for a pattern.

- Shadows (particularly caused by the depth of the objects)
- Non-uniform lighting
- Geometric distortion by the lens, particularly when the camera is not perpendicular to the pattern
- Blurring due to motion if the shutter speed is too slow for moving parts

There are functions and parameters in the SIMATIC VS120 Vision Sensor to reduce the negative effects of such interference in recognizing parts. They help to create optimal edges from the image to generate patterns.

4.3 Generating models and detecting orientation

A model is created from the sum of the edges extracted in the image and their arrangement. To ensure good processing quality, the contours of the model should lie within the ROI (Region of Interest).

4.3.1 Setting for the Precision parameter

The precision setting is based on the size of the ROIs and recognizable changes in the specimen. The search for a part in the image is "pyramidal". It starts with a coarse search at low resolution and finishes with a fine search at high resolution. The Precision parameter affects the coarse and fine search.

Coarse and fine search

The table shows the start and end values of the resolution during the search process with the various levels of precision.

Precision level	Start value for the resolution Width x Height (in pixels)	End value for the resolution Width x Height (in pixels)
Fine1	320 x 240	640 x 480
Fine2	160 x 120	640 x 480
Fine3	80 x 60	640 x 480
Medium1	80x60	320 x 240
Medium2	40x30	320 x 240
Coarse1	40x30	160 x 120
Coarse2	20x15	160 x 120

The **precision for determining the position** should be set as follows:

- "Fine" for the sub-pixel range
- "Medium" for +/-1 pixel and +/-1°
- "Coarse" for +/- 2 pixels and +/-1°
 - The precision for determining the position still depends on the pattern size and the number of edges found in it and may therefore deviate from the values shown above.
 - The angle precision can be increased to < 1° with the "Angle Precision" parameter in "Options - Extras tab".

Note

If the setting is "Fine1" and the model is large, the processing times may be several seconds.

Note

If exposure is set to "Manual" and the user changes the precision in the adjustment support (adjust sensor), the "shutter speed" exposure parameter is adjusted automatically. Depending on the distance of the object to the camera, this can cause inaccuracies.

Example for declaring the Precision parameter

A wall is hung full of A4 sheets on which various texts have been printed. An observer has the task of finding a specific sheet among all the others.

Procedure:

- To accelerate the search, the observer stands at a considerable distance from the wall. The distance from the wall selected by the observer depends on the criteria on which the search is based, among other factors.
- The observer begins to presort all the sheets. If the observer is looking for a large rough drawing, they will stand a long way away to be able to see all drawings at the same time. In this case, the observer would select "Fine3".
- If the observer concentrates on details, such as text format or heading, he would move closer. Since he is examining more details, the search takes correspondingly longer. In this case, the observer would select Fine2 or Fine1.
- Once the observer has made a rough selection, he moves closer to the sheets and investigates each sheet in detail. He now exactly compares individual words and image details with a reference sheet. The observer no longer examines each sheet in detail because he has already limited the selection.

The algorithm of the SIMATIC VS120 Vision Sensor works in much the same way as the example described above.

4.3.2 Measures for optimizing object recognition

Problem: Object was not trained

If the object could not be trained, the reason may be that there were not enough contours in the selected ROI.

Remedy

- Make sure that the ROI is selected correctly (position and size) and that the object is within the ROI when training.
- If this problem still occurs, the object to be trained has too few contours. In this case, a change in the setting of the precision towards greater precision might help, for example, from Medium2 to Medium1 or to Fine1.

- If these measures still do not lead to success, try the following for example:
 - Select other lighting
 - Specify other more detailed object regions in the ROI
 - Enlarge the ROI or similar
- Another remedy is to change the brightness with high contrast in order to clearly detect the change in the image.

4.4 Quality of the measured values

All the displayed measured values for imaging geometry of a read model are subject to the following inaccuracies.

Processing precision

- for the position (x and y coordinates): up to ± 0.1 pixels
- for the angle (angle precision): up to $\pm 0,2^\circ$

The **processing precision** is influenced by the following factors:

- Lighting effects such as reflection and shadow
- Perspective distortion, such when the camera is too close to or at too oblique an angle to the object
- Differences in the object, for example, dirty objects
- Variation in the trained background structure

Fluctuations in size

Fluctuations in size in the image up to $\pm 10\%$ are tolerated, if the specimens are the same position as the trained pattern. These fluctuations can be caused by the following:

- Different distances between specimens and the lens caused by a different position on the conveyor belt or workpiece holder
- Different pattern sizes in the specimen

Perspective distortion

- Perspective distortion in the recorded image are tolerated if the specimens have the same orientation as the trained pattern.
- If there is perspective distortion and the orientation is different, no general statement is possible. In this case, the shape of the specimens and the angle between the camera level and pattern level are the factors that determine whether or not the specimens can be recognized.

Relationship between resolution and pixel size

The following table shows which actual length corresponds to the side length of a pixel. Remember that this value applies only for the specified image width. The sensor heads 6GF2 002-8DA (SIMATIC VS120 for large specimens) and 6GF2 002-8EA (SIMATIC VS120 for small specimens) were based on the maximum possible image widths.

	Graphic width	Resolution per pixel at 640*480	Resolution per pixel at 320*240
SIMATIC VS120 for large specimens	70 mm	$70/640 = 0.11$ mm / pixel	$70/320 = 0,22$ mm / pixel
SIMATIC VS120 for small specimens	40 mm	$40/640 = 0,06$ mm / pixel	$40/320 = 0,13$ mm / pixel
C/CS mount	12 mm	$12/640 = 0.02$ mm / pixel	$12/320 = 0.04$ mm / pixel

4.5 Geometric distortion

Geometric distortion caused by the lens is compensated. With sensor heads with fixed lenses, the value of the distortion is set automatically and should no longer be changed. If standard lenses with a C mount are used, the user can make the compensation manually by changing the parameters.

4.6 Main ROI and sub-ROI

Processing with main ROIs is usually sufficient to evaluate the image. ROIs (Region of Interest) are used to distinguish a part from the background better. The sub-ROI option added to the main ROI allows certain details of patterns, which would otherwise be indistinguishable in comparison to the total contour, to be weighted more heavily. Testing for damage or completeness are examples of this.

This is, for example, the case if you have shiny areas or variable areas in the object. Using sub-ROIs, you can concentrate the search and the evaluation on the important characteristics and suppress irrelevant ones.

Procedure

1. Training of the main ROI concentrating on the invariable characteristics of the specimen
2. Select the "ROI: New" button the dialog "Training - ROI tab" of the adjustment support. A rectangle or circle appears on the screen depending on the shape selected for the sub-ROI.
3. Changing the size and position of the sub-ROI in the same way you define the main ROI

4.6.1 Example: Main ROI and 3 sub-ROIs

Example: Main ROI and 3 sub-ROIs

Task description: The task is to check whether the Siemens logo was printed completely.

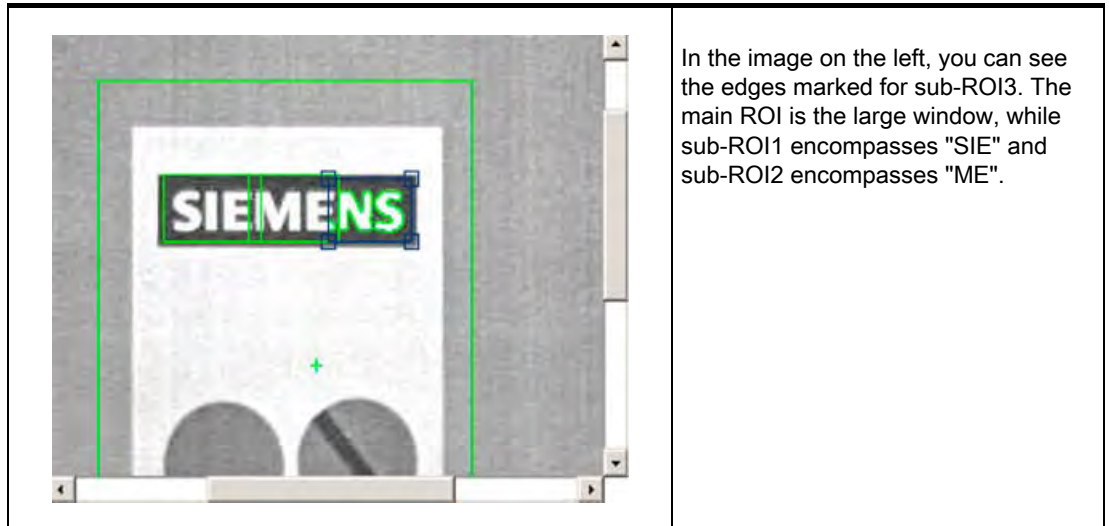

In the image on the left, you can see the edges marked for sub-ROI3. The main ROI is the large window, while sub-ROI1 encompasses "SIE" and sub-ROI2 encompasses "ME".

Parameter assignment

Parameter name	Main ROI	Sub-ROI 1, 2 and 3
Task	Find (default)	Find (default)
scaling	Fixed	Fixed (default)
Precision	Fine3	Fine1
Model. type	Edges (default)	Edges (default)

- The sub-ROIs can be set with the precision Fine1 since the pattern windows are small. This ensures that no details are lost.
- Fine3 should, however, be selected for the main ROI otherwise the processing time will take too long. In this case, the selection of the precision (Fine1, Fine2 or Fine3) has no effect on the quality value of the result.

Example of recognition of a bad object

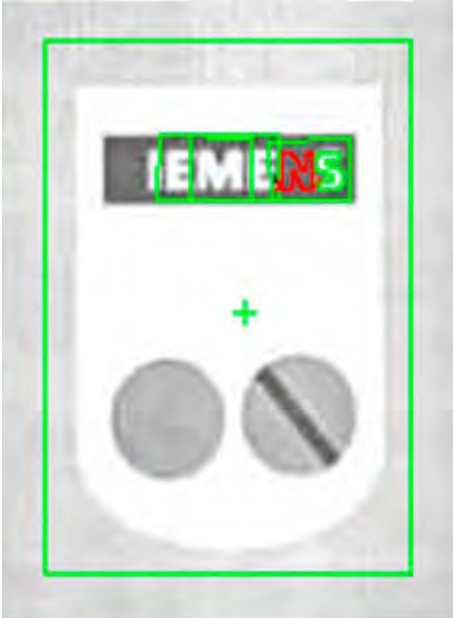
	<p>In this example, the "S" and the "N" are missing. If only one ROI had been trained, the quality would have been 87.2% (=quality of the main ROI).</p> <p>Sub-ROI1: 60.6% Sub-ROI2: 98.7% Sub-ROI3: 42.0%</p> <p>70% is selected as the quality limit for all ROIs and an object is then evaluated as N_OK if a sub-ROI falls below the quality limit.</p>
--	--

4.6.2 Example of the influence of sub-ROIs on the quality value

Based on the example below, we will illustrate the effects on the quality value of a specimen of using sub-ROIs.

Note



If features are allowed in the area enclosed by the ROI or sub-ROIs that you do not want to be evaluated, select "Find" as the job in the "Options - Training tab" of the adjustment support. Otherwise, select the value "Identify".

The example model appears as follows:

Note

If only one main ROI is used, the cumulative quality corresponds to the quality of the main ROI.

If sub-ROI and main ROI are used, the cumulative quality is calculated from the average of the sub-ROI qualities.

Without sub-ROIs, green rectangle means main ROI.	With sub-ROIs, red rectangle means sub-ROIs
	

The following specimens must be evaluated:

Specimen 1:	Job:	Without sub-ROIs	With sub-ROIs
	Identify	Q _C = 100 %	Q _A = 100 %
	Find	Q _C = 100 %	Q _A = 100 %

Note

- Q_C is the cumulative quality of the main-ROI
- Q_A is the average value of the quality of the sub-ROIs

Specimen 2:	Job:	Without sub-ROIs	With sub-ROIs
	Identify	Q _C < 100 %	Q _A < 100 %
	Find	Q _C = 100 %	Q _A = 100 %

Specimen 3:	Job:	Without sub-ROIs	With sub-ROIs
	Identify	Q _C < 100 %	Q _A = 100 %
	Find	Q _C = 100 %	Q _A = 100 %

Specimen 4:	Job:	Without sub-ROIs	With sub-ROIs
	Identify	Q _C < 100 %	Q _A = 100 %
	Find	Q _C < 100 %	Q _A = 100 %

Specimen 5:	Job:	Without sub-ROIs	With sub-ROIs
	Identify	Q _C < 100 %	Q _A < 100 %
	Find	Q _C = 100 %	Q _A = 100 %

4.7 Job parameter

The Job parameter has the options "Find" and "Identify"

Find



If the "Find" option is selected, **additional edges** of the specimen are **not taken into consideration**.



Identify

If the "Identify" option is selected, **additional edges** of the detected specimen are **taken into consideration** and compared with the edges of the reference model.

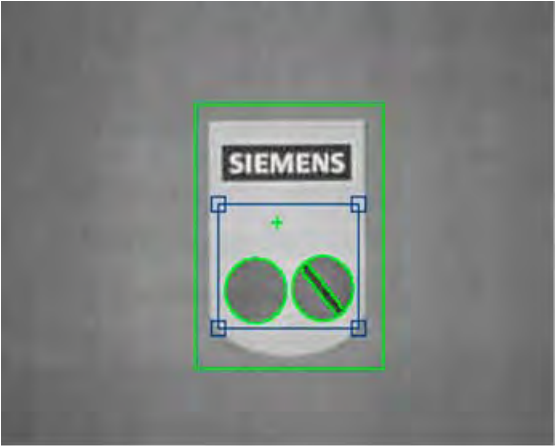
Example

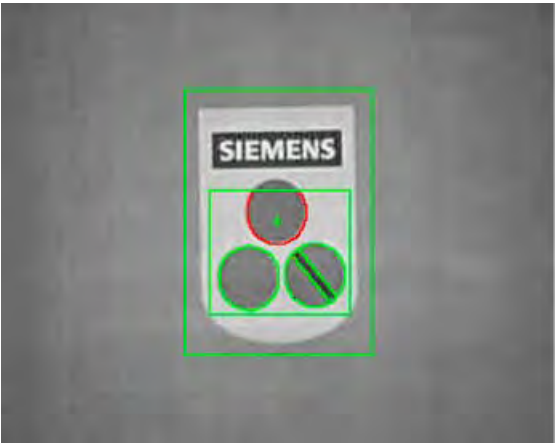
Metal plate with three holes. If "Find" is set, the quality 100% will be output for a metal plate with an additional hole. If "Identify" is set, the quality value will be lower because the additional edges of the fourth hole do not have corresponding edges in the reference image.

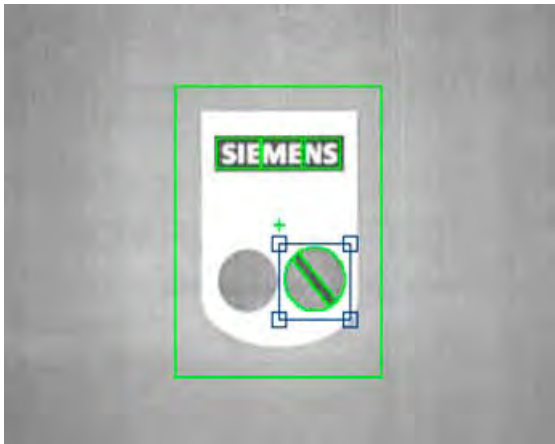
Example 1	
	Trained sub-ROI
	"Find" job. Result: Quality 99.3%
	"Identify" job. Result: Quality 69% The additional edges of the object pattern that are not included in the reference pattern can be clearly seen.

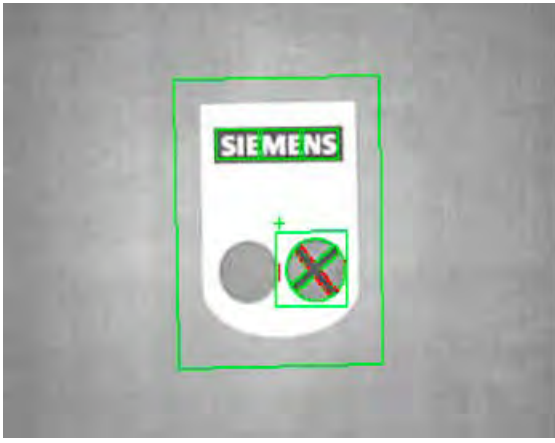
Example 2	
	<p>An additional sub-ROI is trained:</p>
	<p>"Find" job</p> <p>If the "Job" parameter is set to the value "Find", the following quality values are obtained:</p> <ul style="list-style-type: none">• Main ROI: 98.7%• Additional sub-ROI: 90.5% <p>Even a value of 90.5% is too unreliable to be able to set the quality limit here.</p>
	<p>"Identify" job.</p> <p>The "Job" parameter is now set to "Identify" for the additional sub-ROI. The following result is then achieved:</p> <p>Quality value of the additional sub-ROI: 69.3%</p> <p>Changes can now no longer be reliably detected with an increased quality limit.</p>

4.8 Search parameter

Two areas can be specified for image recognition.

- Limited: The ROIs around the specimen cannot extend beyond the edge of the image. Limited is the default value.
- Open: The ROIs around the specimens can go beyond the edge of the image by a maximum value specified by **d**

You must specify the maximum value **d** by the following when an open area is used:

$$d_{\max} = 30\% \text{ of } \sqrt{b^2 + h^2}$$

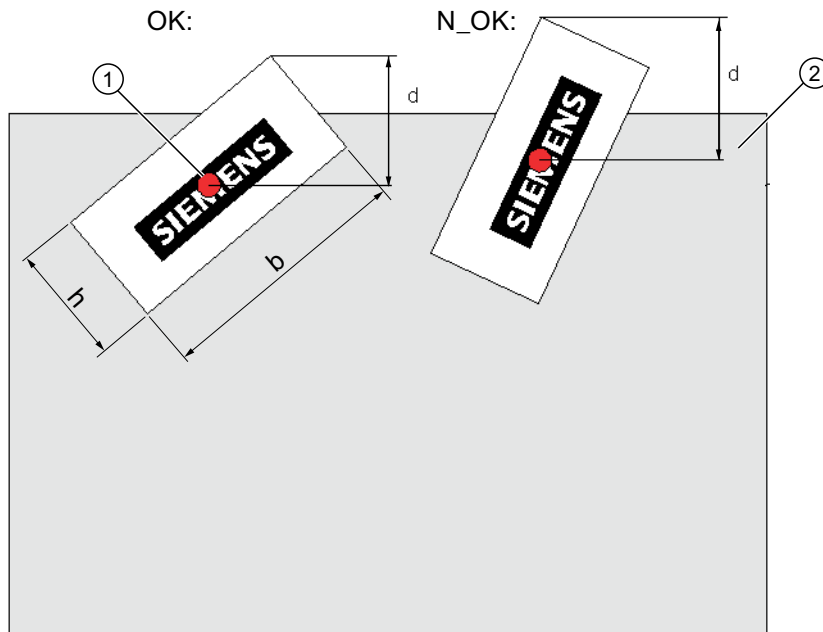

Figure 4-1 Search parameter

w = width

h = height

d = maximum value for the position beyond the edge of the image

OK = position for processing OK

N_OK = position for processing not OK

1) = center point of the pattern



2) = image area

4.9 Model type parameter

The human eye instinctively classifies edges with a strong contrast as being more important than those with a weak contrast. In the "Model type" parameter, this phenomenon is taken into consideration in the processing with two settings:

- **Edges** if prominent edges of the specimen are important for processing. Edges is the *default value*
- **Area** if all the edges in the specimen are weighted the same for processing.

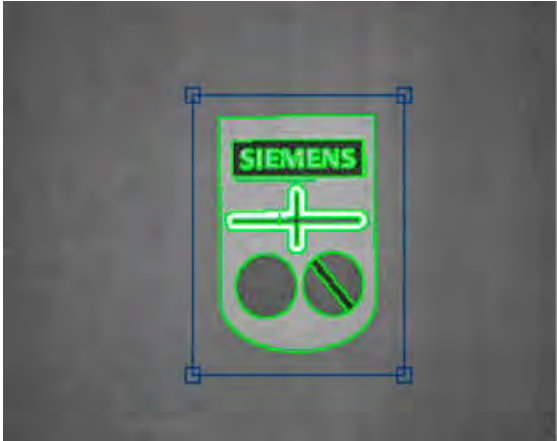
Example

	<p>The cross in the middle is a contour with significantly greater contrast than other contours. If an application requires this region to be weighted as being more important than the rest for the search, "Edge" should be set as the model type.</p>
	<p>"Edge" model type parameter Result: Quality value 53%</p>
	<p>"Area" model type parameter If you want all areas to be weighted the same, select "Area". Result: Quality value 76.5%</p>

4.10 Model sets

Features

- The model sets functions enables the SIMATIC VS120 Vision Sensor to classify (sort) parts.
- Classification involves individual examination of the models in the model set. Classification is considered successful if at least one of these models is evaluated as OK. A model with the highest cumulative quality is determined from all the models evaluated as OK. This evaluation result is generated as "Best".
- The number of models allowed in a model set depends on the complexity of the mode and is limited by the storage capacity of the VS120 processing unit.
- Increasing the number of models in the model set, increases beyond proportion the processing time by several seconds.
- Up to 40 trained models can be added to each model set.
- The option of integrating several models in a single model set can be enabled in Options > Extras > Use Multimodel.

Note

Exposure Control Model Set

The settings for the model with the lowest model number always apply for setting the exposure of a model set.

Note

Error messages

The following error messages can occur in processing mode for the model sets:

- One of the models in the model set has not yet been trained.
 - A model set contains models with different precision (important in this respect: only the precision value of the parameter counts, in other words, all models must be either "Fine" or "Coarse").
 - The model set contains too many models that are too large so that there is not enough storage space.
-

Example

The model set consists of two models. You need to decide if the image to be processed contains the "SIEMENS" model or the "COMPANY" model.



"SIEMENS" model

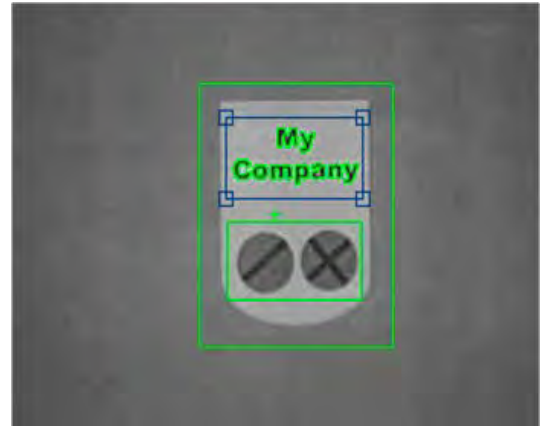

"COMPANY" model

- The user selects this model set instead of the model in processing mode. Each captured image is evaluated in comparison to the individual models in the model set.
- The first captured image contains the "SIEMENS" specimen. The contours of the specimen match those in the "SIEMENS" model, but deviate strongly from the contours of the "COMPANY" model. The VS120 processing unit delivers the result, OK, and the number of the "SIEMENS" model.



- The next captured image contains the "COMPANY" specimen. The contours of the specimen match those in the "COMPANY" model, but deviate strongly from the contours of the "SIEMENS" model. The VS120 processing unit delivers the result, OK, and the number of the "COMPANY" model.



Network and system integration

5.1 Overview

The SIMATIC VS120 system can be configured as follows for the acquisition and processing of recognition values:

- System configuration with digital I/O
- PROFIBUS DP environment
- PROFINET IO environment
- System configuration Ethernet (TCP / IP) or RS-232, for example, via Com server

Note

Other combinations of modes are permitted, for example, control via PROFIBUS DP and result output via RS-232.

5.2 System configuration over digital I/O

Acquisition and output of recognition values via digital I/O

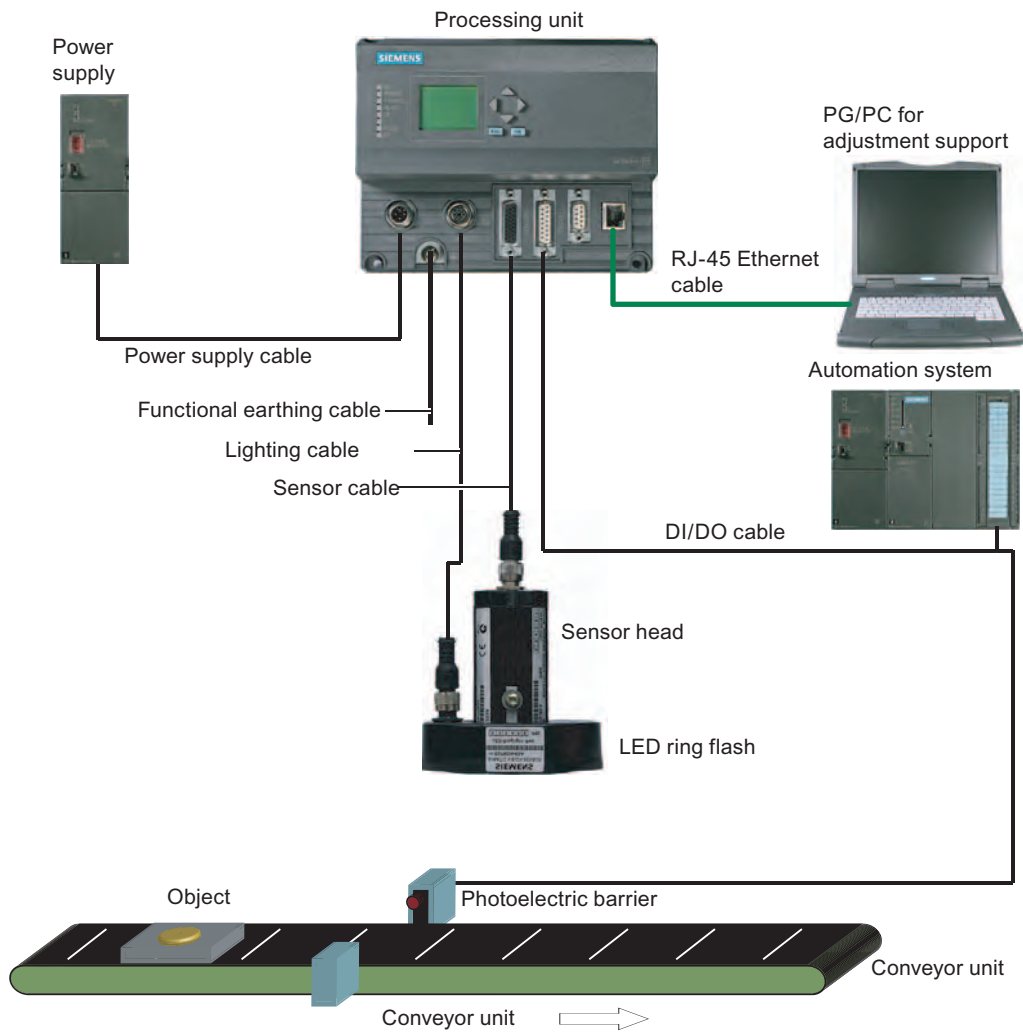

Figure 5-1 System configuration via digital I/O

System features:

- A PC/PG dedicated to adjustment is connected via the Ethernet port.
- The connection to an automation system is established via digital I/Os.
- The SIMATIC VS120 is controlled by the automation system via digital I/Os.
- The OK or N_OK results of the specimen are passed to the automation system via digital I/Os.

5.3 PROFIBUS DP system configuration

Acquisition and output of recognition values in a PROFIBUS DP environment

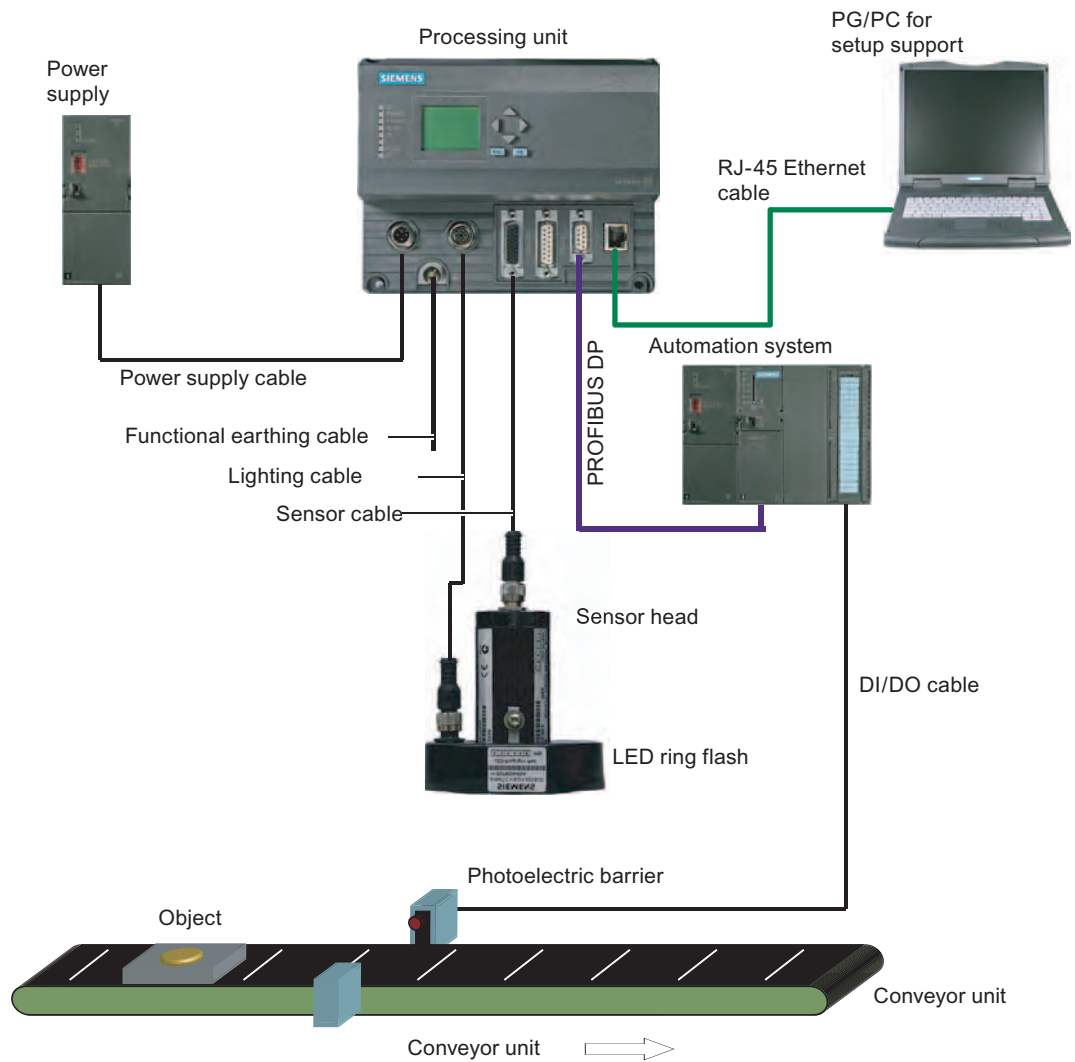

Figure 5-2 System configuration with PROFIBUS DP

System features:

- A PC/PG dedicated to adjustment is connected via the Ethernet port.
- The connection to an automation system is established via PROFIBUS DP.
- The SIMATIC VS120 is controlled by the automation system via PROFIBUS DP.
- The results from the specimen are output to the automation system via PROFIBUS DP.

5.4 PROFINET IO system configuration

Acquisition and output of recognition values in a PROFINET IO environment

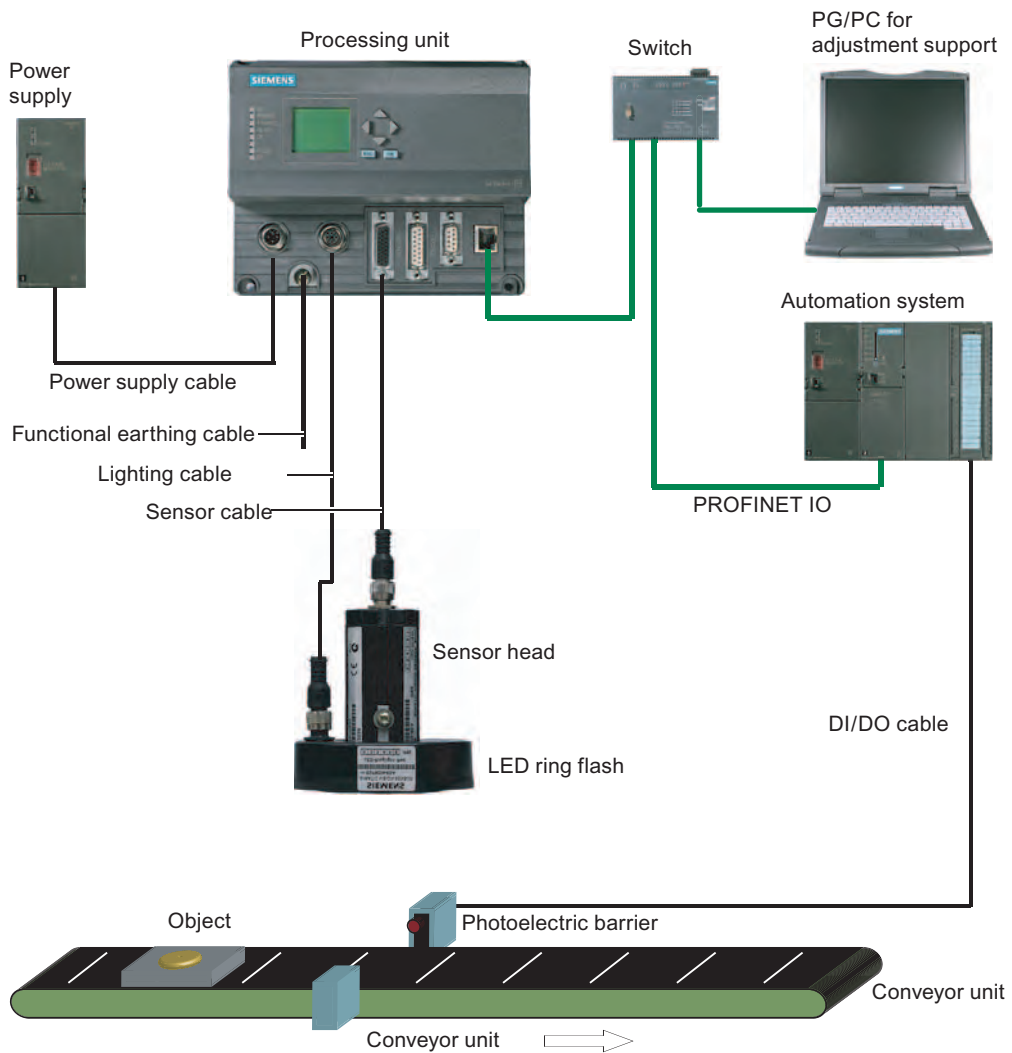

Figure 5-3 System configuration with PROFINET IO

System features:

- A PC / PG dedicated to adjustment is connected via the Ethernet (TCP/IP) and a switch.
- There is also a connection to a PROFINET IO compliant automation system via Ethernet and a switch.
- The SIMATIC VS120 is controlled by the automation system.
- The results from the specimen are output to the automation system via PROFINET IO.

5.5 System configuration with Ethernet or RS-232 over Com server

Acquisition and output of recognition values with Ethernet (TCP / IP)

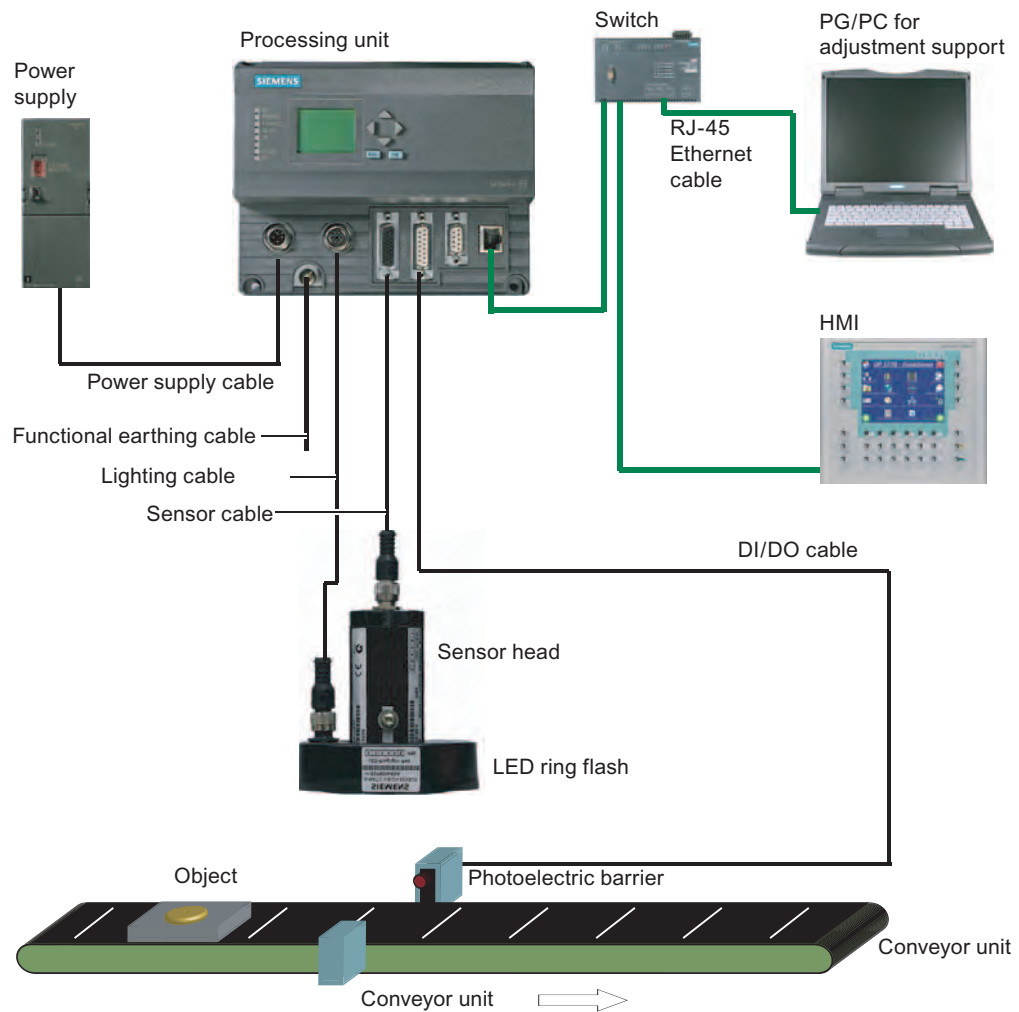

Figure 5-4 System configuration with Ethernet (TCP/IP)

System features:

- The PC / PG for adjustment support is connected to the processing unit via a network.
- The SIMATIC VS120 is controlled by the HMI.
- The results from the specimen are output to the HMI.

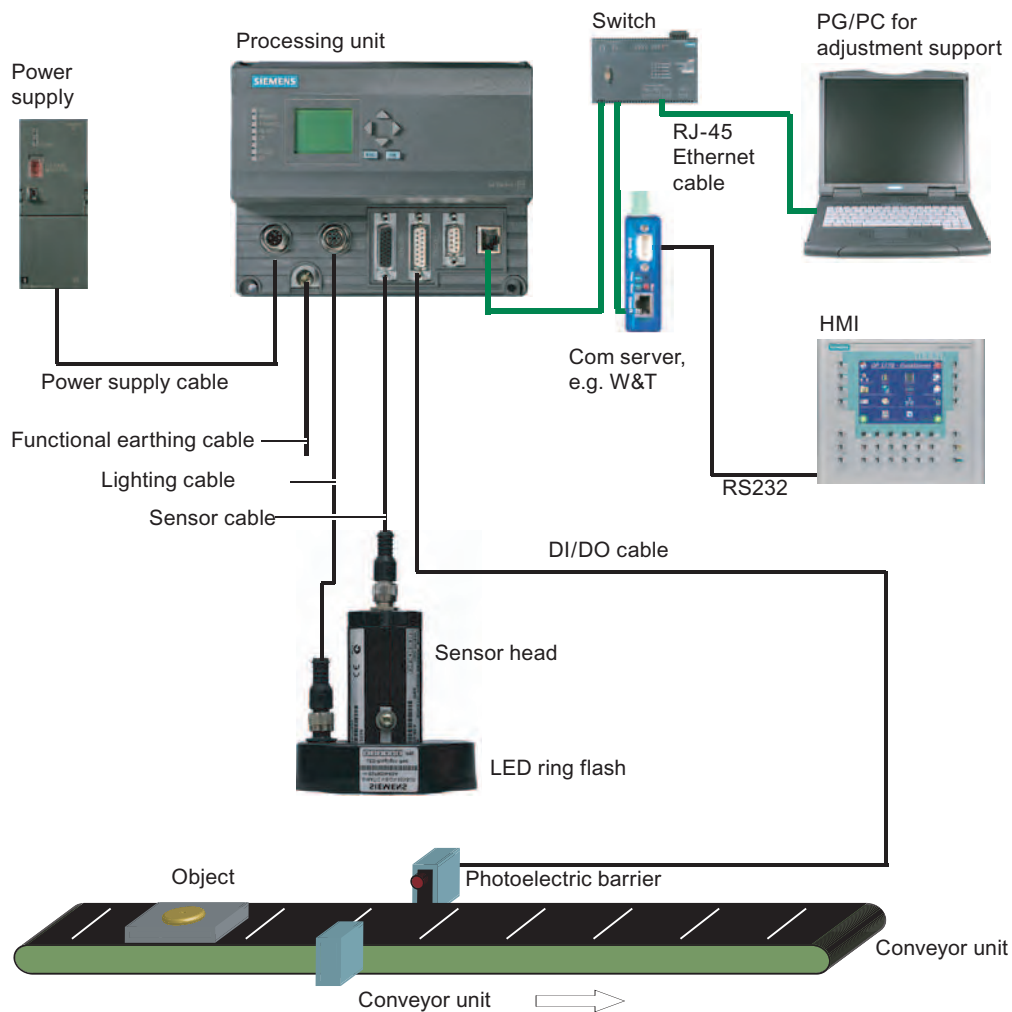

Figure 5-5 System configuration with RS-232 via Com server

System features:

- The PC / PG for adjustment support is connected to the processing unit via a network.
- The results are output to the HMI via the RS-232 port of the Com server, for example W&T.

Installation

6.1 Installing the SIMATIC VS120 processing unit

1. For the location of the fixing holes, refer to the *Dimensional Drawing of the SIMATIC VS120 Processing Unit*
2. Mount the processing unit so that it is easily accessible for the operator

6.2 Installing the sensor head with LED ring flash

Notice**Aligning the optical axis**

Align the optical axis of the sensor head vertical to the direction in which the object is conveyed. Otherwise the image of the object will be distorted. The evaluation will be inaccurate.

If the objects always pass the sensor head in the same position, the angle of the mid axis of the objects to the vertical can be up to 45°.

Notice**Distance D between sensor and object**

The ideal distance D between sensor and object depends on the type of sensor head. With sensor heads with the order numbers (MLFB) below, the recommended distance D is as follows:

- 6GF2 002-8DA01: 100 mm
 - 6GF2 002-8EA01: 90 mm
-

There are two possible ways to install the LED ring flash:

- LED ring flash on the sensor head, parallel to the optical axis of the sensor head

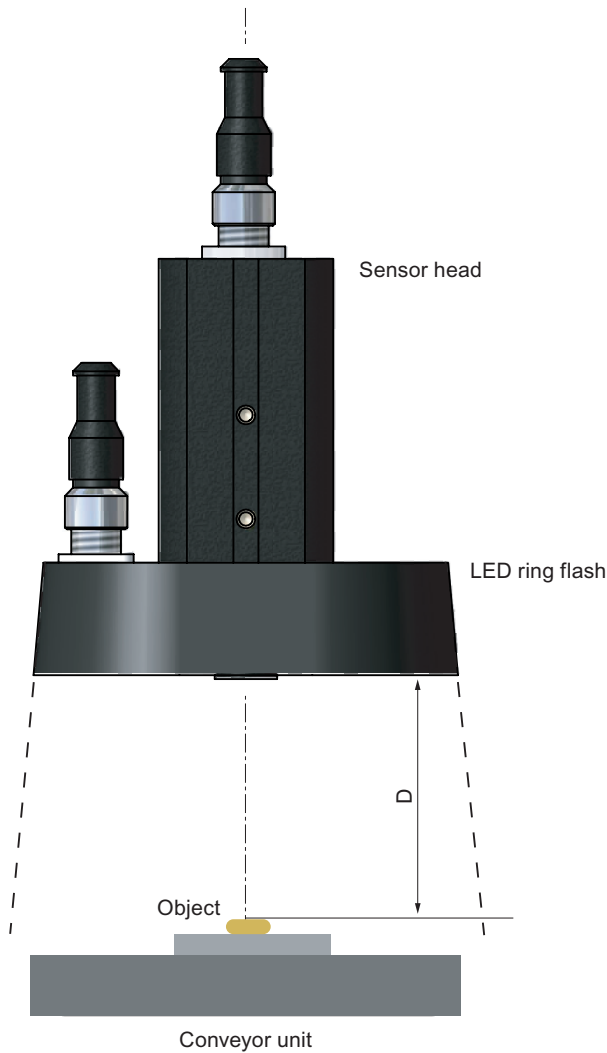

Figure 6-1 Components

How to mount the LED ring flash on the sensor head

The LED ring flash is supplied with two mounting brackets to allow it to be mounted on the sensor head.

1. Screw the mounting bracket onto the LED ring sensor
2. Push the sensor head through the LED ring sensor
3. Guide the mounting brackets into the grooves of the sensor head
4. Secure the mounting bracket with screws.

How to mount the sensor head

A mounting plate is supplied with the sensor head.

1. Insert the mounting plate in one of the grooves of the sensor head
2. Secure the sensor to your holder with a mounting plate

How to mount the LED ring flash beside the sensor head

No ring light flash is supplied to secure the LED ring flash beside the sensor head. For ordering information on a suitable ring flash holder, refer to the section *Accessories* in the operating instructions.

1. Mount the sensor head on your holder
 2. Secure the LED ring flash to the ring flash holder
 3. Secure the ring light holder to your holder
- LED ring flash beside the sensor head, at an angle to the optical axis of the sensor head

Notice

LED ring flash beside the sensor head

If the object causes interfering reflections when the LED ring flash is mounted on the sensor head, mount the LED ring flash beside the sensor head.

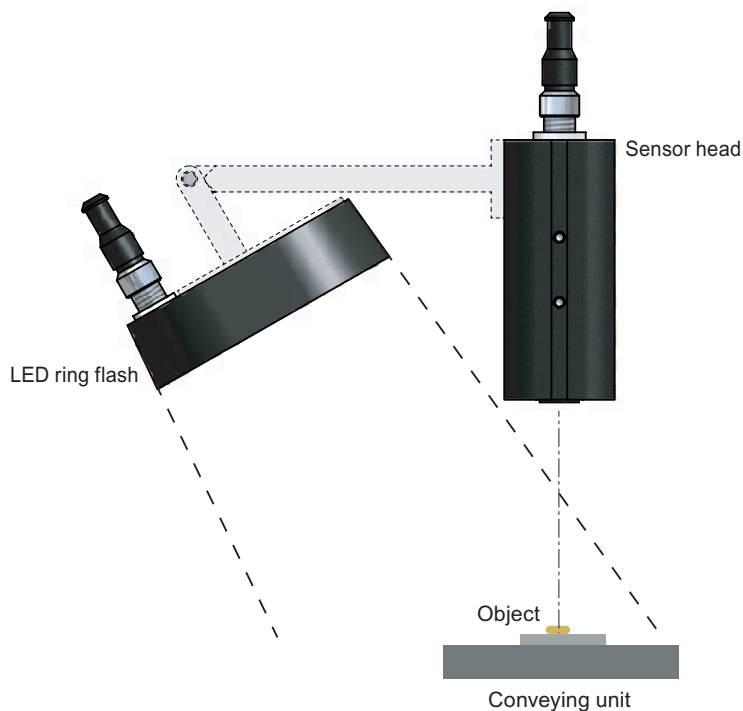

Figure 6-2 Components with ring light

Connecting

7.1 Guidelines on installation and avoiding electrical interference

To avoid interference, you must shield your system. Low-frequency (LF) and high-frequency (HF) interference signals can result in an incorrect response if the system is badly grounded or not shielded.

Interference signals can be caused, for example, by

- Switching relays or contactors (large, fast changes in current or voltage and HF interference signals);
- Different ground potentials between two parts of the system (LF interference signals)

Using / installing interference-proof cable

- Always use the supplied cable to connect the sensor head.
- All plug-in connections must be secured by screws or a locking mechanism.
- Signal lines must not run parallel to power cables. A separate cable channel must be used with a minimum clearance of 50 cm from power cables.

Note

For more detailed information, refer to the installation manual SIMATIC S7-300 Programmable Controller, Hardware and Installation in the section on "Wiring".

7.2 Guidelines on installation when using PROFIBUS DP or PROFINET IO

If you are using PROFIBUS DP or PROFINET I/O to control the device and/or to transfer the results the installation and configuration guidelines must be kept to.

7.3 Connecting components

Connect the processing unit with the other components using the connectors on the front panel.

The pinning of the connectors is described in the section: "Technical specifications" and with the description of the supplied cable in section: "Scope of delivery/Spares/Accessories".



Caution

Do not connect or disconnect cables when the power supply is on.



Warning

Grounding the SIMATIC VS120 cancels the ungrounded configuration of the power unit.

Note

The DC load power supply must meet the following requirements:

Only a safe, isolated extra-low voltage of 24 V DC may be used as the load current supply. Safe isolation can be implemented according to the requirements of:

- VDE 0100-410 / HD 384-4-41 S2 / IEC 60364-4-41 as protective extra low voltage with safe isolation (PELV) or
- VDE 0805 / EN 60950 / IEC 60950 as safety extra-low voltage (SELV) or VDE 0106 Part 101.

The power supply chassis of the I/O and CPU must be connected to the power supply chassis of the processing unit.



Figure 7-1 Locations of the connection element

Wiring	Connector label	Type	Number of pins	Cable cross section	Type
Functional earth	⏚	Screw-type terminal	1	1.5 mm ²	Stranded conductor
Power supply	IN 24 V DC	Circular M12 connector	4	0.56 mm ²	Pin
Lighting unit	LAMP	Circular M12 connector	4	0.23 mm ²	Socket
Sensor head (shielded cable)	SENSOR	HD D-sub	26	0.09 mm ²	Socket
I/O	DI/DO	D-sub	15	0.14 mm ²	Socket
PROFIBUS DP	DP	D-sub	9	-	Socket
Ethernet	ETHERNET	RJ45	8	-	Socket

Cable connection

- Read the guidelines on preventing electrical interference.
- Connect the processing unit to the sensor head and the lighting unit with the cables.
- Connect functional ground of the processing unit with chassis with a ring \varnothing M5 and a cable cross section of at least 1.5 mm².
- Connect the processing unit to the 24 V DC load power supply with $I = 2$ A.
- Connect the PC/PG to the processing unit using an Ethernet cable.
- Arrange the cabling according to your configuration.

Commissioning

8.1 Prerequisites

Notice

All activities are described based on the classic Windows Start menu.

If your Windows Start menu is not displayed in the classic style, change it as follows:

1. Right-click on the taskbar and select "Properties".
 2. Change to the "Start Menu" tab and select the "Classic Start Menu" radio button.
 3. Click "OK" to close the dialog box.
-

Requirements for commissioning:

- Administrator privileges
- Enabled JAVA JIT Compiler

Checking for administrator privileges

1. Click **Start > Settings > Control Panel > Administrative Tools > Computer Management**
2. Click on **System > Local Users and Groups > Groups > Administrators**

If you are included in the group of administrators, you have administrator privileges. Otherwise contact your network administrator.

Enabling the JAVA JIT compiler

1. Select **Tools > Internet Options** in the Internet Explorer and make the settings as shown in the figure below:

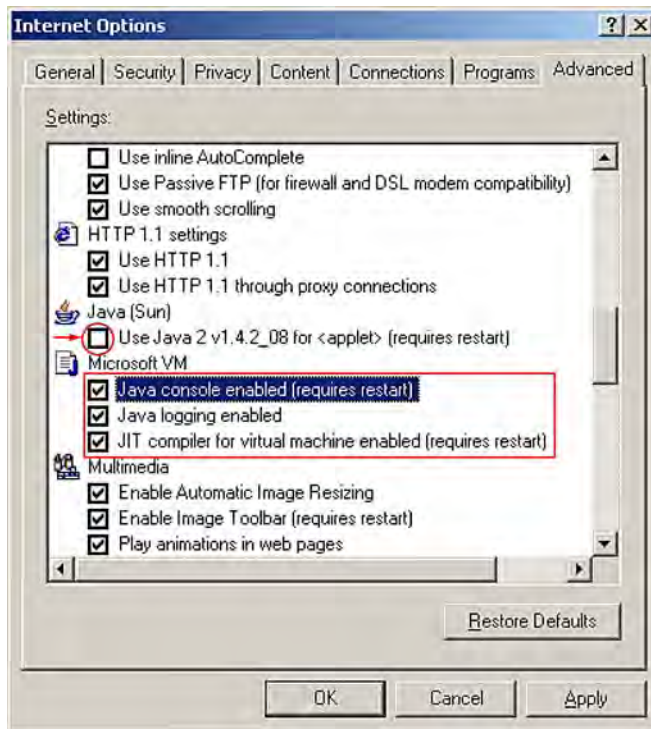

Figure 8-1 Settings for the Java JIT compiler

8.2 Overview of the steps in commissioning

Step	Activity
1	Turn on the VS120 processing unit
2	Establish an Ethernet connection between the VS120 processing unit and PG / PC:
	2.1 Select the connection variant
	2.2 Check if a proxy server is being used
	2.3 If a proxy server is being used: Change the proxy configuration of your Internet Explorer
3	Establish and check the connections
4	Start adjustment support over the Internet Explorer
5	Adjust the sensor head using adjustment support

8.3 Turn on the VS120 processing unit

Initial commissioning:

Turn on the power supply of the VS120 processing unit for its initial commissioning. The VS120 processing unit then performs a self-test:

- Test of the Ethernet connection
- Function test of the sensor head

Note

During the initial commissioning, "Factory Settings Used" appears on the LCD display. Confirm this with "OK."

Once the self-test is completed, "Adjust" appears on the LCD display.

Normal mode:

Each time the SIMATIC VS120 starts up, the VS120 processing unit runs the following self-test:

- Test of the stored settings and model data
- Test of the Ethernet connection
- If appropriate, test of the connection to PROFINET IO
- If appropriate, test of the Ethernet RS-232 converter or TCP server and connection to the PC / PG
- If appropriate, test of whether data can be exchanged with PROFIBUS DP
- Function test of the sensor head
- If appropriate, test of the connection for archiving model data

If the self-test completes without any errors, the main menu, the "Adjust" display or the RUN menu is displayed on the LCD display depending on the status when the device was last turned off.

- "Main" menu:

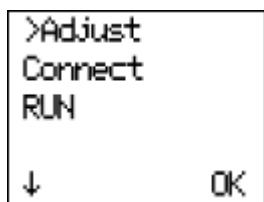

- "Adjust" displayed on the LCD display:

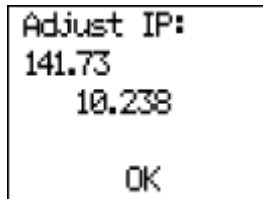

```
Adjust IP:  
141.73  
10.238  
  
OK
```

- "RUN" menu:

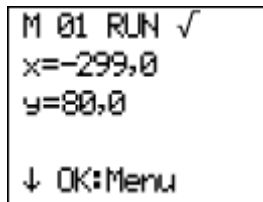

```
M 01 RUN ✓  
x=-299,0  
y=80,0  
  
↓ OK:Menu
```

Note

Apart from controlling from the VS120 processing unit, you can also control SIMATIC VS120 with the adjustment support.

Next step

Perform the activities described in the section *Establish an Ethernet connection between the VS120 processing unit and PC / PG.*

8.4 Establish an Ethernet connection between the processing unit and PG / PC

8.4.1 Select the connection variant

8.4.1.1 Connection variants

You can connect the VS120 processing unit via a direct connection or via a network with a PC / PG. In all cases, the TCP/IP Ethernet protocol is used for communication.

Direct connection

- Operating the VS120 processing unit as a DHCP server
- Connecting the VS120 processing unit manually

Connection over a network

- Integrating the VS120 processing unit as a DHCP client in a network
- Integrating the VS120 processing unit as a device in a PROFINET IO network

Notice

Operating the VS120 processing unit in a network can interfere with the communication in your network if you make certain settings in the **Connect > Ports > Ethernet > IP Mode** menu. You should therefore only connect the VS120 processing unit to the network after you have completed configuration and checked your settings carefully.

Next step

Select one of the connection variants from the next sections.

8.4.1.2 Operating the VS120 processing unit as a DHCP server

You want to do the following with the VS120 processing unit:

- Connect directly to the PC / PG
- Operate the VS120 processing unit as a DHCP server to assign the following addresses of the processing unit automatically:
 - IP address
 - DNS server address

Notice

Under no circumstances connect the VS120 processing unit in this mode to an existing DHCP server in the house network over a switch as you may disrupt the operation of the house network. You can only implement an additional connection from the PC to your previous network over a second network adapter in this PC.

Note

In this mode, you can connect up to four PCs to the VS120 processing unit via a switch since a maximum of four IP addresses can be assigned automatically.

Procedure

1. Configure the VS120 processing unit as a DHCP server.
2. Configure your PC / PG as a DHCP client
3. Establish an Ethernet connection

Step 1: Configuring the VS120 processing unit as a DHCP server

1. After turning on the VS120 processing unit and after the self-test is completed, go to the "Connect" menu and confirm with "OK".
2. Confirm the selected "Ports" menu command with "OK".
3. Change to the "Ethernet" menu and confirm with "OK"
4. Confirm the selected "IP Mode" menu command with "OK".
5. Select "DHCPSErv" and confirm with "OK"

Step 2: Configure your PC / PG as a DHCP client

1. Click Start > Settings > Network and Dial-up Connections
2. In the "Network and Dial-up Connections" dialog, select your active local area connection to the network
3. Select "Properties" in the context menu and select the "Internet Protocol (TCP/IP)" entry.
4. Click the "Properties" button
5. Select the "Obtain an IP address automatically" radio button

Step 3: Establish the Ethernet connection

1. Establish an Ethernet connection between the VS120 processing unit and PC / PG. Use a network cable of the type "Ethernet RJ-45 (crossover)"

Note

Instead of the network cable of the type "Ethernet RJ-45 (crossover)", you can also use a network cable of the type "Ethernet RJ-45" with a switch for the connection between the VS120 processing unit and the PC / PG.

Next step

Perform the activities described in the section *Check the connection*.

8.4.1.3 Connecting the VS120 processing unit manually

You want to do the following with the VS120 processing unit:

- Connect directly to the PC / PG
- Configure manually to change the IP address of the VS120 processing unit or to assign an address yourself

Requirements

The PC / PG has the following default network setting that it cannot/should not be modified: In the "Internet Protocol (TCP/IP) Properties" dialog, the "Use the following IP address" radio button is selected.

You can check the setting by following the steps described in the section "Procedure for checking the IP setting of the PC / PG".

Procedure

1. Check the IP setting of the PC / PG
2. Configure the VS120 processing unit manually
3. Establish an Ethernet connection

Step 1: Checking the IP setting of the PC / PG

1. Click Start > Settings > Network and Dial-up Connections
2. In the "Network and Dial-up Connections" dialog, select your active local area connection to the network
3. Select "Properties" in the context menu and select the "Internet Protocol (TCP/IP)" entry.
4. Click the "Properties" button
5. Note down the displayed IP address and subnet mask of your PC / PG.

Step 2: Manual configuration of the VS120 processing unit

Notice

- The IP address of the VS120 processing unit must be in the same subnet as the IP address of the PC.
 - The default gateway is not necessary for a direct connection between the VS120 processing unit and a PC / PG
-

1. After turning on the VS120 processing unit and after the self-test is completed, go to the "Connect" menu and confirm with "OK".
2. Confirm the selected "Ports" menu command with "OK".
3. Change to the "Ethernet" menu and confirm with "OK"
4. Confirm the selected "IP Mode" menu command with "OK".
5. Select "Manual" and confirm with "OK"
6. Change to the "IP Address" menu and confirm with "OK"
7. Now enter the IP address of the VS120 processing unit with the arrow keys and confirm with "OK".
8. Change to the "IP Mask" menu and confirm with "OK"
9. Enter the subnet mask with the arrow keys and confirm with "OK"

Step 3: Establish the Ethernet connection

1. Establish an Ethernet connection between the VS120 processing unit and PC / PG. Use a network cable of the type "Ethernet RJ-45 (crossover)"

Next step

Perform the activities described in the section *Check the connection*.

8.4.1.4 Integrating the VS120 processing unit as a DHCP client in a network

You want to do the following with the VS120 processing unit:

- Connect to the PC / PG over your existing network
- Operate as a DHCP client because the IP address configurations are assigned to the PCs in the existing network by a DHCP server

Notice

Depending on your network structure, it may be necessary to inform the DHCP server of the MAC address, the unique device identifier of the VS120 processing unit. You can see these in the **Connect > Ports > Ethernet > MAC Info** menu.

Note

If your network administrator can assign a DNS name (Domain Name Service) for the VS120 processing unit, you can address the device by name in much the same way as an intranet server.

Procedure

1. Configure the VS120 processing unit as a DHCP client
2. Configure your PC as a DHCP client
3. Establish an Ethernet connection

Step 1: Configuring the VS120 processing unit as a DHCP client

1. After turning on the VS120 processing unit and after the self-test is completed, go to the "Connect" menu and confirm with "OK".
2. Confirm the selected "Ports" menu command with "OK".
3. Change to the "Ethernet" menu and confirm with "OK"
4. Confirm the selected "IP Mode" menu command with "OK".
5. Select "DHCP" and confirm with "OK"

Step 2: Configuring your PC as a DHCP client

1. Click Start > Settings > Network and Dial-up Connections
2. In the "Network and Dial-up Connections" dialog, select your active local area connection to the network
3. Select "Properties" in the context menu and select the "Internet Protocol (TCP/IP)" entry.
4. Click the "Properties" button
5. Select the "Obtain an IP address automatically" radio button

Step 3: Establish the Ethernet connection

1. Establish an Ethernet connection between your PC and your existing network. Use a network cable of the type "Ethernet RJ-45"
2. Establish an Ethernet connection between the VS120 processing unit and your existing network. Use a network cable of the type "Ethernet RJ-45"

Next step

Follow the steps described in the section *Check whether a proxy server is being used.*

8.4.1.5 Integrating the VS120 processing unit as a device in a PROFINET IO network

You want to do the following with the VS120 processing unit:

- Connect to the PC / PG over your existing PROFINET IO network
- Integrate the unit as a device in a PROFINET IO network because the IP configuration will be assigned by the PROFINET IO controller

Notice

The IP configuration of the VS120 processing unit is set in STEP 7. It is not possible to set the parameters on the VS120 processing unit.

Procedure

1. Configure the VS120 processing unit as a PROFINET IO device
2. Make the parameter settings for the IP configuration of the VS120 processing unit in STEP 7.
3. Integrate your PC in the PROFINET IO network
4. Establish an Ethernet connection

Step 1: Configuring the VS120 processing unit as a PROFINET IO device

1. After turning on the VS120 processing unit and after the self-test is completed, go to the "Connect" menu and confirm with "OK".
2. Confirm the selected "Ports" menu command with "OK".
3. Change to the "Ethernet" menu and confirm with "OK"
4. Confirm the selected "IP Mode" menu command with "OK".
5. Select "PNIO" and confirm with "OK"

Note

The VS120 processing reboots after the IP mode is changed to "PNIO".

Step 2: Setting the parameters for the IP configuration of the VS120 processing unit in STEP 7

For a description, refer to the section: *Integrating the PROFINET IO device SIMATIC VS120 in HW Config*

Step 3: Integrating your PC in the PROFINET IO network

Notice

- The network attachment must not have an IP address that is already being used in your network
 - The IP address of the PC must be in the same subnet as the IP address of the VS120 processing unit. If necessary, the port configuration of the PC must be adapted
-

1. Click Start > Settings > Network and Dial-up Connections
2. In the "Network and Dial-up Connections" dialog, select the existing local area connection to the network. This must have the status "Enabled".
3. Select "Properties" in the context menu and select the "Internet Protocol (TCP/IP)" entry.
4. Click the "Properties" button
5. Select the "Use the following IP address" radio button
6. Adapt the "IP address" and "Subnet mask" to your PROFINET IO network

Step 4: Establish the Ethernet connection

1. Establish an Ethernet connection between your PC and a switch in your existing PROFINET IO network. Use a network cable of the type "Ethernet RJ-45"
2. Establish an Ethernet connection between the VS120 processing unit and your existing network. Use a network cable of the type "Ethernet RJ-45"

Next step

Follow the steps described in the section *Check whether a proxy server is being used*.

8.4.2 Check whether a proxy server is being used

If the VS120 processing unit is used in a network with proxy servers, the following problems can occur:

- The address entered for the VS120 processing unit is not known to the Internet Explorer
- Error message when starting adjustment support

You should therefore check whether or not a proxy server is entered in the "Local Area Network (LAN) Settings" dialog of the Internet Explorer.

Procedure

1. Start the Internet Explorer and select the menu command Tools > Internet Options...
2. Click on the "Connections" tab
3. Click on the "LAN Settings" button in the "Local Area Network (LAN) settings" group box.
4. If the "Use a proxy server" check box is selected in the "Proxy server" group box, a proxy server is used and the "Advanced" button is enabled.

Result

A proxy server is used in the Internet Explorer if one of the following conditions is met:

- The "Use a proxy server for your LAN" check box is enabled in the "Proxy server" group box
- The "Advanced" button is enabled.

Next step

- Follow the steps described in the section *Change the proxy configuration of your Internet Explorer* only if a proxy server is used in the Internet Explorer
- If no proxy server is used in the Internet Explorer, skip to the steps described in the section *Check the connection*

8.4.3 Change the proxy configuration of your Internet Explorer

Change the proxy configuration of your Internet Explorer only if a proxy server is used in the Internet Explorer.

Procedure

1. Start the Internet Explorer and select the menu command Options > Internet Options
2. Click on the "Connections" tab
3. Click on the "LAN Settings" button in the "Local Area Network (LAN) settings" group box.
4. In the next dialog "Local Area Network (LAN) Settings", clear all the check boxes and confirm with OK

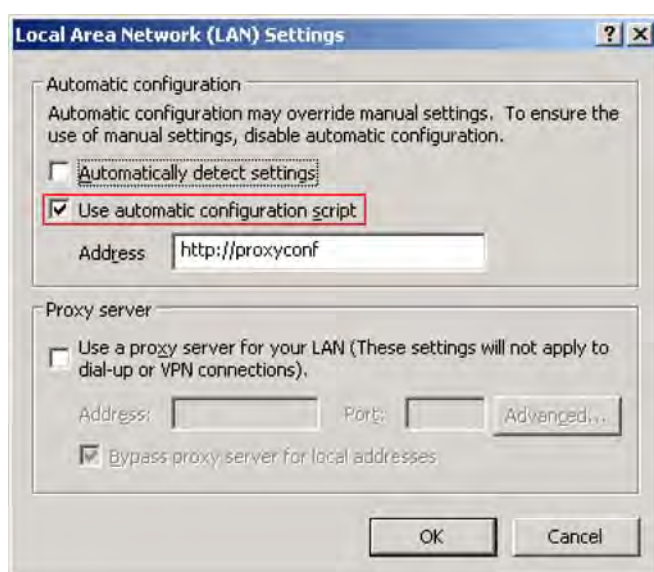

Figure 8-2 Settings for the local area network

As an alternative, if the "Use a proxy server for your LAN" check box needs to be selected, click the "Advanced" button in the "Proxy server" area and enter the current IP address of the VS120 processing unit in the "Exceptions" area in the "Proxy Settings" dialog.

Note

You can also enter computer names in the "Exceptions" area. The computer name is resolved into a static or dynamic IP address by the DNS server in the network.

Next step

Perform the activities described in the section *Check the connection*.

8.4.4 Check the connection

Checking the connection tells you whether or not the configured Ethernet connection between the PC and the VS120 processing unit is working.

You can only start adjustment support from your Internet Explorer and operate the VS120 processing unit from your PC after you have checked the connection.

Requirements

- The VS120 processing unit was either integrated in your existing network or connected directly to a PC
- The network cable is connected to the VS120 processing unit
- The VS120 processing unit is connected to a 24 V DC power supply unit and is being supplied with power
- The VS120 processing unit self-test is completed

Procedure

1. Make sure that the VS120 processing unit and PC are correctly connected to the existing network or are connected together using an Ethernet crossover cable
2. After turning on the VS120 processing unit and after the self-test is completed, go to the "Connect" menu and confirm with "OK".
3. Confirm the selected "Ports" menu command with "OK".
4. Change to the "Ethernet" menu and confirm with "OK"
5. Change to the "IP Address" menu and confirm with "OK"
6. Note down the IP address displayed on the VS120 processing unit
7. Open the command prompt on the PC with **Start > Run** and enter the program name "cmd".
8. In the command prompt, enter the following:
ping <IP address or name of the VS120 processing unit>
Example: ping 192.168.0.42
9. Confirm your entry by pressing the enter key on the keyboard

Result

If the connection from the PC to the VS120 processing unit exists, 4 packets are first sent from the PC to the processing unit as shown above and then 4 packets are returned from the VS120 processing unit to the PC.

The reply from the VS120 processing unit appears on the PC, for example, as follows:

```
Reply from 192.168.0.2 bytes=32 time<10ms TTL=255
Reply from 192.168.0.2 bytes=32 time<10ms TTL=255
Reply from 192.168.0.2 bytes=32 time<10ms TTL=255
Reply from 192.168.0.2 bytes=32 time<10ms TTL=255
```

This is followed by the ping statistics for 192.168.0.2.

Next step

- If you receive a reply from the VS120 processing unit on the PC, follow the steps described in the section *Start adjustment support over the Internet Explorer*
- If you do not receive a reply from the VS120 processing unit, repeat the steps described in the section *Establish connection and between VS120 processing unit and PG / PG* and/or contact your network administrator

8.5 Start setup support over the Internet Explorer

To be able to work with the adjustment support implemented on the VS120 processing unit, establish a connection from the Internet Explorer to the adjustment support

Requirements

The section *Establishing a connection between the VS120 processing unit and PC / PG* was completed successfully. As described in the section *Check the connection*, you have established a confirmed connection from the VS120 processing unit to the PC / PG.

Procedure

1. Start the PC
2. Turn on the power supply of the VS120 processing unit. Once the self-test has completed, go to "Adjust" in the LSD display
3. Press the OK button of the VS120 processing unit. The IP address appears on the LCD display
4. Note down the IP address of the VS120 processing unit
5. Start the Internet Explorer
6. In the "IP address" input box, enter the IP address of the VS120 processing unit.
7. Press the enter key on the keypad

Result

The start page of the "Vision Sensor SIMATIC VS120" adjustment support appears in the Internet Explorer. From here, you have access to all functions required to test the models.



Figure 8-3 Home

The adjustment support is started with "Adjust Sensor". The SIMATIC VS120 then automatically blocks operator input at the VS120 processing unit. The LCD display of the VS120 processing unit displays the message: "Settings controlled by Web".

Next step

Follow the steps described in the section *Adjust the sensor head using adjustment support*.

8.6 Adjust the sensor head using setup support

Before you commission the "SIMATIC VS120 Vision Sensor", you must adjust the sensor head correctly. You do this with the "SIMATIC VS120 Vision Sensor" adjustment support that is available in the Internet Explorer. The adjustment support shows you an image as seen by the sensor head.

Note

Online Help

At the bottom right of each page of adjustment support, you will see a "Help" button with which you can call up online help at any time. The relevant help text of the online help opens depending on the currently open dialog.

Requirements

The Start Page of the "SIMATIC VS120 Vision Sensor" adjustment support was started over the Internet Explorer

Procedure

1. On the start page of the adjustment support, click on "Sensor Adjustment". The "Adjustment" user interface opens. The sensor head view is displayed and updated several times per second.

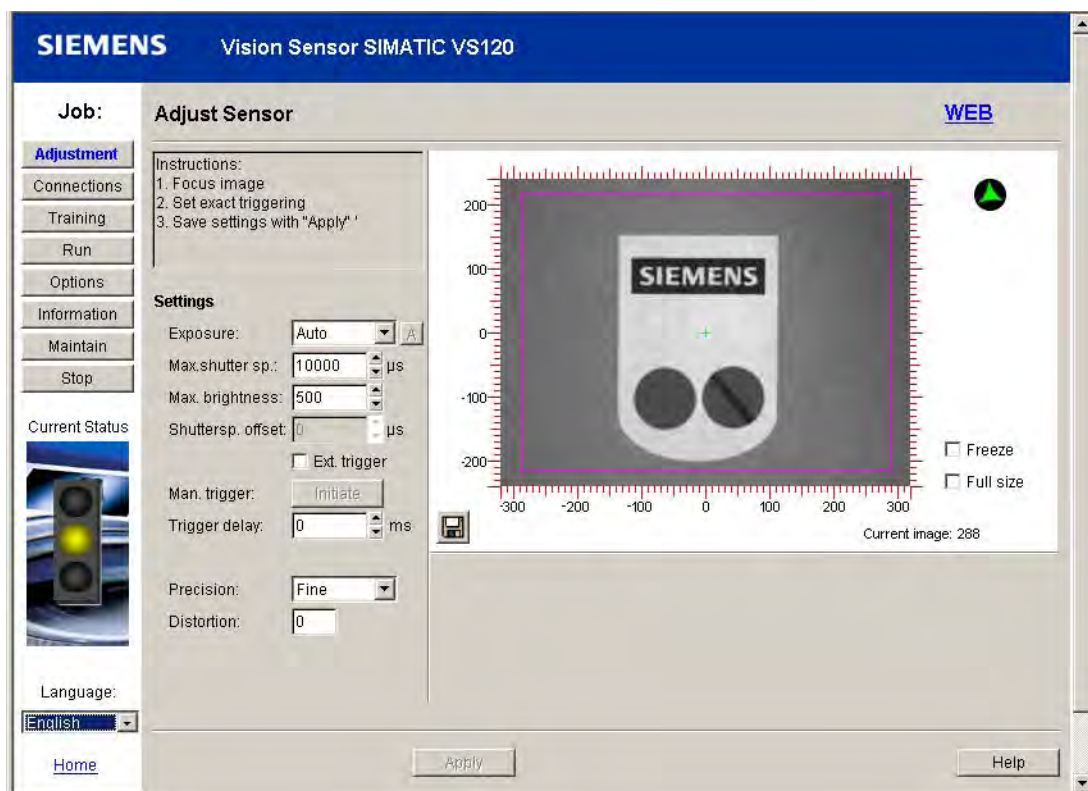

Figure 8-4 Adjustment

8.6 Adjust the sensor head using setup support

2. Position an object below the sensor head
3. Set the displayed image to that it is sharp by adjusting the distance between the end of the sensor head and the model correctly
4. Secure the sensor head and then check the image sharpness again
5. Make sure that the triggering is exact and the content of the image has as much contrast as possible

If necessary, correct the settings or use the automatic shutter mode. You can set the following parameters:

- Exposure settings
- Trigger settings
- Precision
- Distortion

Notice

If Shutter is set to Auto, the model must remain fully in the image for at least 100 ms.

6. Click the "Apply" button to save the settings.

Note

If you have too many errors, clean the lens and diffuser with a lint-free cloth.

Result

You have successfully commissioned "SIMATIC VS120 Vision Sensor". You can now train and process your models for your application. Refer to the section *Operation* for more information.

Operation

9.1 Overview

There are two ways of operating the SIMATIC VS120:

- From the VS120 processing unit, see the section: *Working with the VS120 processing unit*
- Using adjustment support See the section *Working with adjustment support on the PC*

You can set and change all parameter settings with adjustment support on the PC. Configuration on the VS120 processing unit itself is limited.

9.2 Working with the processing unit

9.2.1 Introduction

The display of the VS120 processing unit is used to show the coordinates and the orientation of the test object currently being viewed and the associated quality value. You can also navigate between the menus and make entries in the LCD display.

Example of an LCD display:

```
M 01 RUN N
X=-299.0
Y=0.0
↓ OK: Info
```

Five levels are implemented as selection menus or displays:

- Adjust
- Connect
- RUN
- Options
- Maintain

9.2.2 Adjust

"Adjust" display

The **Adjust** LCD display displays the current IP address.

9.2.3 Connect

"Connect" menu

The following schematics provide you with an overview of all the parameters of the SIMATIC VS120 that can be set in the **Connect** menu.

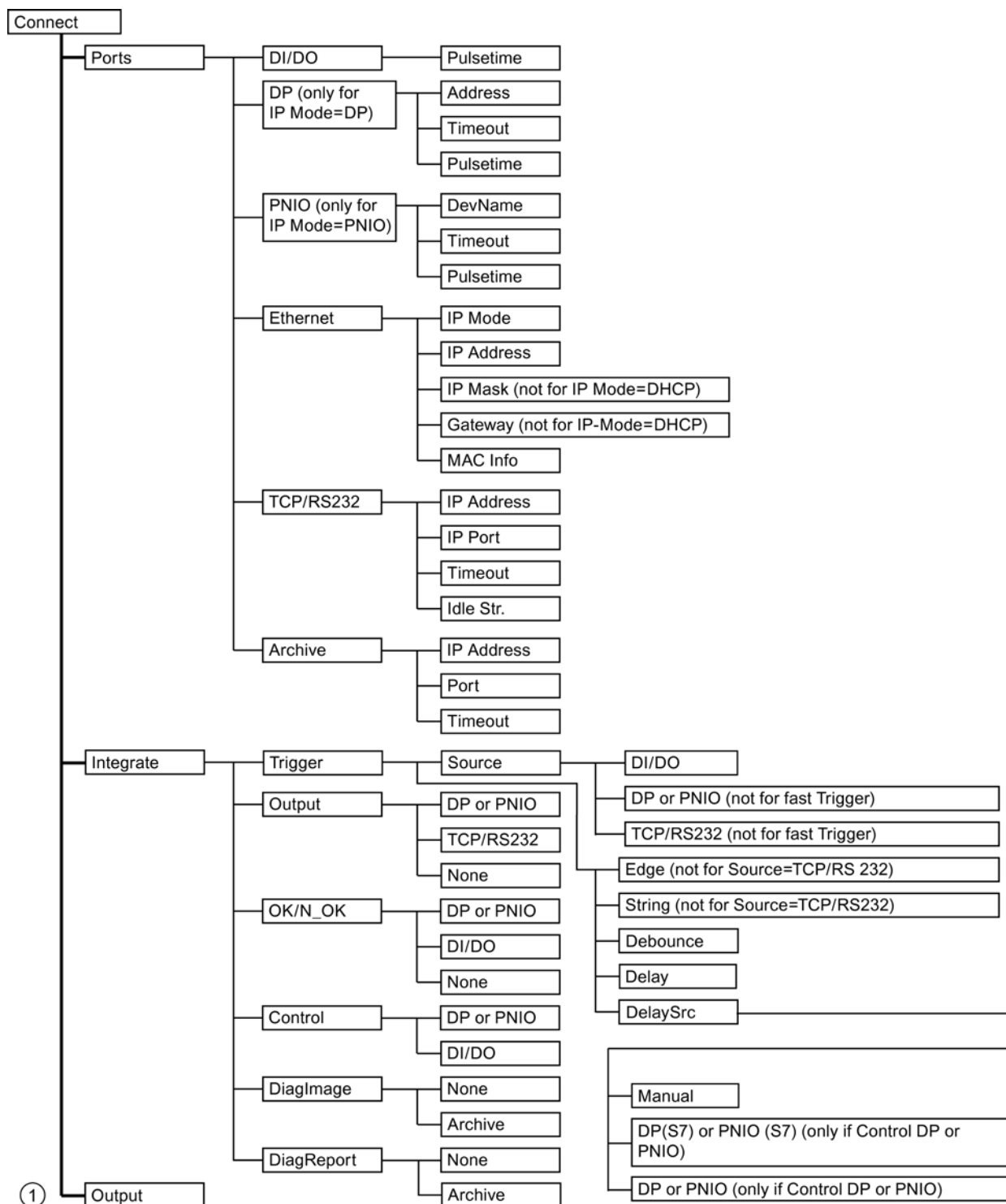

Figure 9-1 Structure of the Connect menu

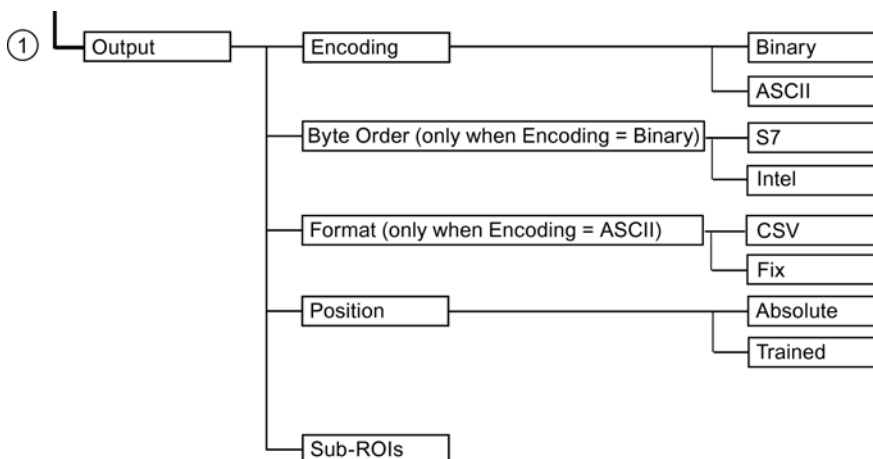

Figure 9-2 Structure of the Connect menu continued

"Connect" parameter menu

Parameters Port	Path	Possible Values	Default	Meaning
Pulsetime	Ports>DI/DO	5 to 999	30	Pulse time of the digital outputs OK, N_OK in ms on the DI/DO interface
Address (not active if IP Mode = PNIO)	Ports>DP	1 to 125	7	Address on PROFIBUS DP
Timeout (not active if IP Mode = PNIO)	Ports>DP	100 to 2000	500	Handshake monitoring time in ms
Pulsetime (not active if IP Mode = PNIO)	Ports>DP	5 to 999	30	Pulse time of the digital outputs OK, N_OK in ms when output is via PROFIBUS DP
DevName (only active if IP Mode = PNIO)	Ports>PNIO	String (0 to 9, A to Z, a to z, ".", "-"). The string must match the conventions of the domain name system.	VS120	Name of the device on PROFINET Note: PROFINET is not case sensitive
Timeout (only active if IP Mode = PNIO)	Ports>PNIO	100 to 2000	500	Handshake monitoring time in ms
Pulsetime (only active if IP Mode = PNIO)	Ports>PNIO	5 to 999	30	Pulse time of the digital outputs OK, N_OK in ms when output is via PROFINET IO Note: For the pulse time, select a higher value than for the update time of the PROFINET IO system in HW Config.
IP mode	Ports>Ethernet			Assignment of the IP address to the processing unit in the network.

Parameters Port	Path	Possible Values	Default	Meaning
IP Address	Ports>Ethernet	xxx.xxx.xxx.xxx (xxx = 0 to 255)	192.168.0.42	IP address of the processing unit (An IP address consists of four numbers separated by periods with each number being in a range from 0 to 255.)
IP Mask (not active if IP Mode = DHCP)	Ports>Ethernet	xxx.xxx.xxx.xxx (xxx = 0 to 255) except: 0.0.0.0 255.255.255.255	255.255.255.0	The subnet mask indicates which part of the IP address specifies the network and which part specifies the VS120 processing unit: For xxx.xxx.xxx.xxx, binary requires that the left part be made up of ones without a gap and the right part be made up of zeros without a gap. Example: 11111111.10100000 is not permitted.
Gateway (not active if IP Mode = DHCP)	Ports>Ethernet	xxx.xxx.xxx.xxx (xxx=0 to 255)	192.168.0.255	IP address of the network node that can establish connections outside of the current subnet
MAC Info	Ports>Ethernet	Cannot be modified	Device-dependent	The MAC address (Media Access Control) is the hardware address of each network device and is used to identify the device uniquely in the network.
IP Address	Ports> TCP/RS232	xxx.xxx.xxx.xxx (xxx=0 to 255)	192.168.0.43	IP address of the Ethernet RS-232 converter or of the PC/PG on which a TCP server runs.
IP port	Ports> TCP/RS232	1 to 65535	8000	IP port of the Ethernet RS-232 converter or of the PC/PG on which a TCP server runs.
Timeout	Ports> TCP/RS232	0 to 3600	0	<ul style="list-style-type: none"> 0: There is no transfer of cyclic monitoring frames to determine whether the connection still exists between the processing unit and the Ethernet RS-232 converter or the PC/PG on which a TCP server runs. Otherwise: Time in seconds after which a monitoring frame is sent to determine whether the connection still exists between the processing unit and the Ethernet RS-232 converter or the PC/PG on which a TCP server runs. The check is implemented by sending the "Idling string" ("IdleStr." menu) to the recipient at the intervals set with the parameter. If the check fails, an error is output (only when the processing unit is in RUN) and the connection is reestablished.

Parameters Port	Path	Possible Values	Default	Meaning
IdleStr.	Ports> TCP/RS232	Freely selectable character string	\r\n	String to determine whether the connection still exists between the processing unit and the Ethernet RS-232 converter or the PC/PG on which a TCP server runs. It is transferred cyclically. Select this so that the recipient can clearly distinguish it from the generated results. The string can be a maximum of 100 bytes.
IP Address	Ports> Archive	xxx.xxx.xxx.xxx (xxx=0 to 255)	192.168.0.45	IP address of the server for diagnostic information
Port	Ports> Archive	1 to 65535	8765	Corresponding port of this server
Timeout	Ports> Archive	0 to 3600	10	<ul style="list-style-type: none"> • 0: There is no transfer of cyclic monitoring frames to check the connection between processing unit and server. • Otherwise: Time in seconds after which a monitoring frame is sent to check the connection between processing unit and server. If the server does not respond to this frame within the monitoring time, an error is output (only when the processing unit is in RUN) and the connection is reestablished.

Parameters Integrate	Path	Possible Values	Default	Meaning
Source	Integrate> Trigger	<ul style="list-style-type: none"> • DI/DO • DP or PNIO • TCP/RS-232 	DI/DO	Here, you set the port over which the trigger signal is sent to the processing unit.
Edge (only if Source=TCP/RS-232)	Integrate> Trigger	<ul style="list-style-type: none"> • Rising • Falling 	Rising	The function indicates whether the trigger is on a rising or falling edge.
String (only if Source=TCP/RS-232)	Integrate> Trigger	ASCII characters	T	If the string specified here is sent over the RS-232 port of an RS-232 Ethernet converter or a TCP server, the processing unit generates a trigger signal.
Debounce	Integrate> Trigger	0 to 9999 ms	0 ms	The function indicates the period for which triggers are ignored due to debouncing.

Parameters	Path	Possible Values	Default	Meaning
Integrate				
Delay	Integrate> Trigger	<ul style="list-style-type: none"> 0 to 9999 ms for normal triggers 0 to 9999950 µs with a fast trigger or if DelaySrc is not manual 	0 ms	This is where you enter the time by which the trigger signal should be delayed. Note: If DelaySrc is not manual, the values received via DP / PNIO are displayed here. They cannot be edited.
DelaySrc	Integrate> Trigger	<ul style="list-style-type: none"> Manual DP(S7) or PNIO(S7) DP or PNIO 	Manual	Note: <ul style="list-style-type: none"> DP(S7) corresponds to PROFIBUS DP with S7 format (big endian format) DP corresponds to PROFIBUS DP with Intel format (little endian format)
DP(S7) or PNIO(S7) (only if Control DP or PNIO)	Integrate> Trigger> DelaySrc	-	-	The trigger delay is received through the DP(S7) or PNIO(S7) user data interface from the controller in S7 format.
DP or PNIO (only if Control DP or PNIO)	Integrate> Trigger> DelaySrc	-	-	The trigger delay is received by the controller over the user data interface DP or PNIO in Intel format.
Manual	Integrate> Trigger> DelaySrc	-	-	Editable values are used in the delay.
Output	Integrate	<ul style="list-style-type: none"> DP or PNIO TCP/RS-232 None 	None	This is where you enter the interface via which the results are output.
OK/N_OK	Integrate	<ul style="list-style-type: none"> DP or PNIO DI/DO None 	DI/DO	Here, you specify the interface over which the result bits OK and N_OK are output.
Control	Integrate	<ul style="list-style-type: none"> DP or PNIO DI/DO 	DI/DO	Here you specify the port for the DISA, SEL0, SEL1, SEL2, SEL3, RES, IN_OP, TRD, RDY signals.
DiagImage	Integrate	<ul style="list-style-type: none"> None Archives 	None	This is where you specify if the diagnostic images should be sent to a server.
DiagReport	Integrate	<ul style="list-style-type: none"> None Archives 	None	This is where you specify if the diagnostic reports should be sent to a server.

Parameters Output	Path	Possible Values	Default	Meaning
Encoding	Output	<ul style="list-style-type: none"> • Binary • ASCII 	Binary	The results for the main ROI and sub-ROI are sent as binary data or ASCII strings through the output interface set in Integrate>Output
Byte order (only if Encoding = Binary)	Output	<ul style="list-style-type: none"> • S7 • Intel 	S7	<p>Specifies the byte sequence for data types greater than 8 bits.</p> <p>S7 format: Big endian (for a data type greater than 8 bits, the low byte is at the most significant byte position.)</p> <p>Intel format: Little endian (for a data type greater than 8 bits, the low byte is at the least significant byte position.)</p>
Format (only if Encoding = ASCII)	Output	<ul style="list-style-type: none"> • CSV • Fix 	CSV	<p>This is where you enter the format for your output data.</p> <ul style="list-style-type: none"> • CSV: Send in CSV format • Fix: Send individual results with a fixed length of 12 characters
Position	Output	<ul style="list-style-type: none"> • Absolute • Trained 	Absolute	<p>This is where you specify the reference point.</p> <p>Absolute: The position of all ROIs are output as absolute in relation to the image center</p> <p>Trained:: The position of the main ROI is output relative to its position at training based on the image center. The position of the sub-ROI is output relative to its position at training based on the center of the main ROI.</p> <p>Note: This parameter only relates to the results to be transferred and not to the displayed results from the screen and applets.</p>
Sub-ROIs	Output	0 ... 16	16	This is where you enter the number of sub-ROIs that you wish to transfer.

9.2.4 RUN

RUN menu

The following table shows the menus of the RUN menu level.

Menu	Meaning
Model	Select the model number Note: May also be model set depending on the configuration.
STOP	Stop processing and change to the STOP menu level
QLimit	Enter the quality value for the evaluation as a percentage. Note: The display is only visible if you are not working with model sets.
Info	Information function
ResetStat	Resets all statistical information.

Structure of the Info display for a model from the RUN menu

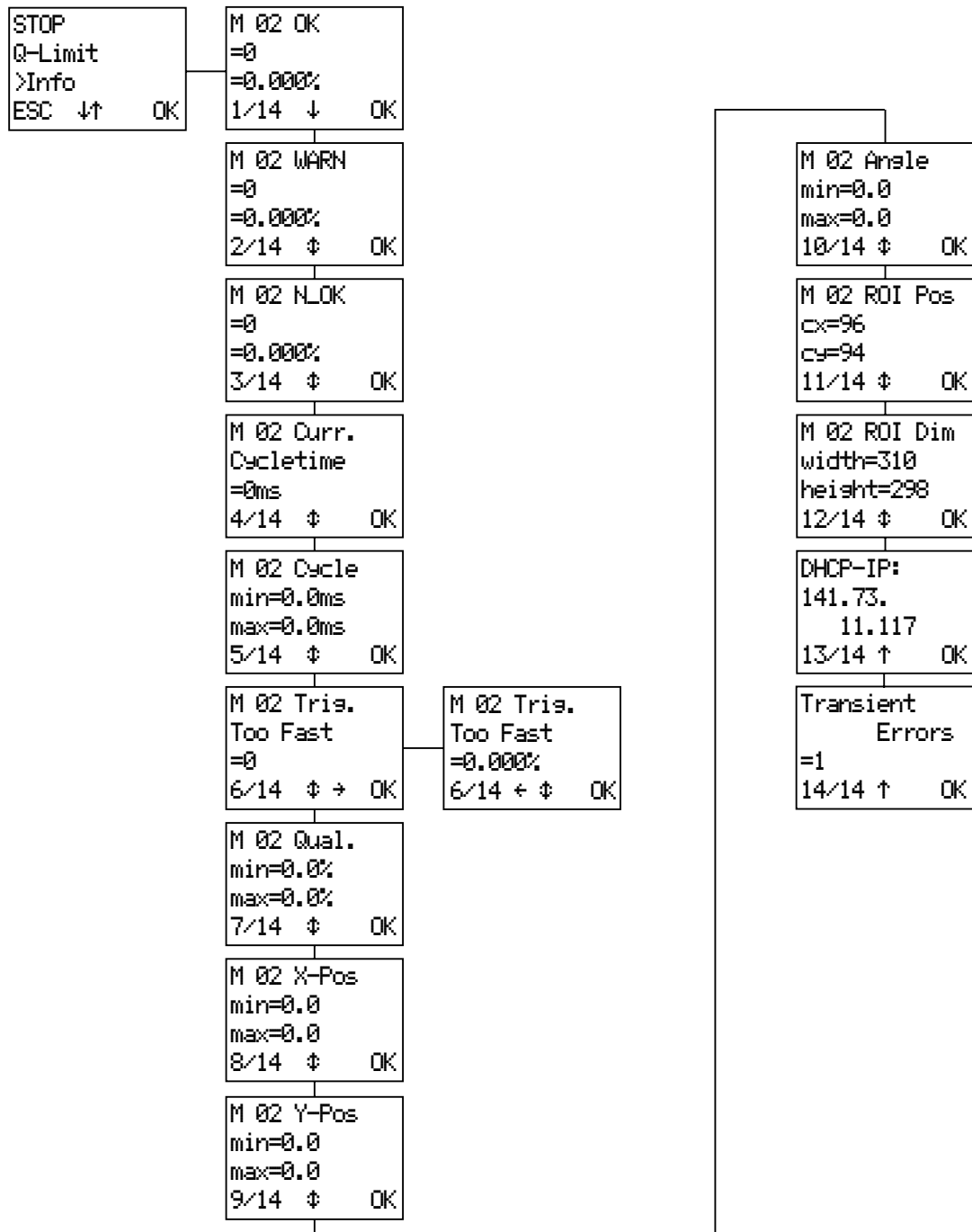

Figure 9-3 Info display for a model from the RUN menu

Note

"Transient Errors", the last menu command in the RUN menu, only appears when an error occurs.

Sequence of tasks in the RUN menu for a model based on the example of a model with number 2:

Step	Display	Activity
1	<pre>STOP Q-Limit > Info ESC ↓↑ OK</pre>	Select "Info" on the processing unit at the "RUN" menu level using the ↓ and ↑ arrow keys and press "OK". This opens the first Info screen.
2	<pre>M 02 OK =3226 =99.907% 1/14 ↓ OK</pre>	Using the arrow buttons ↓ and ↑, you can display further Info screens. Pressing "OK" returns you to the highest hierarchy level of the "RUN" menu.

Step	Display	Meaning
1	<pre>M 02 OK =3226 =99.907% 1/14 ↓ OK</pre>	Since the last processing start, the pattern search for model 2 was performed successfully in 3226 image recordings. This corresponds to 99.907% of all images processed since processing last started.
2	<pre>M 02 WARN =6 =0.194% 2/14 ⚡ OK</pre>	6 examinations were below the warning limit since the last start of processing. This corresponds to 0.194 % of all images processed since processing last started.
3	<pre>M 02 N_LOK =3 =0.093% 3/14 ⚡ OK</pre>	3 specimens could not be identified as model 2 since processing started. This corresponds to 0.093 % of all images processed since processing last started.
4	<pre>M 02 Curr. Cycletime =300ms 4/14 ⚡ OK</pre>	The required processing time (cycle time) for the specimen currently under examination is 300 ms.
5	<pre>M 02 Cycle min=120ms max=276ms 5/14 ⚡ OK</pre>	Since the beginning of the statistical analysis for model 02, the shortest evaluation time was 120 ms and the longest 276 ms.

Step	Display	Meaning
6	<pre>M 02 Tris. Too Fast =0 6/14 + \$ OK</pre>	<pre>M 02 Tris. Too Fast =0.000% 6/14 + \$ OK</pre> <p>Absolute and relative number of image processing procedures during which the next trigger signal came too fast</p>
7	<pre>M 02 Qual. min=85% max=99% 7/14 \$ OK</pre>	<p>Since the beginning of the statistical analysis for the model 02, the lowest quality value was 85% and the highest 99%.</p>
8	<pre>M 02 X-Pos min=-222 max=233 8/14 \$ OK</pre>	<p>Since the beginning of the statistical analysis for model 02, the lowest x coordinate of the target rectangle was -222 and the highest 233.</p>
9	<pre>M 02 Y-Pos min=-14 max=89 9/14 \$ OK</pre>	<p>Since the beginning of the statistical analysis for model 02, the lowest y coordinate of the target rectangle was -14 and the highest 89.</p>
10	<pre>M 02 Angle min=-120.1° max=179.3° 10/14 \$ OK</pre>	<p>Since the beginning of the statistical analysis for the model 02, the lowest roll angel was -120.1° and the highest 179.3°.</p>
11	<pre>M 02 ROI Pos cx=-2 cy=4 11/14 \$ OK</pre>	<p>For model 02, the midpoint of the target rectangle has the following coordinates: x=-2, y=4</p>
12	<pre>M 02 ROI Dim width=101 height=102 12/14 \$ OK</pre>	<p>For model 02, the target rectangle has the following dimensions: Width=101, Height=102</p>

Step	Display	Meaning
13	<div style="border: 1px solid black; padding: 5px; width: fit-content;"> ManuelIP: 192.168. 0.42 13/14 ⌵ OK </div>	Display of the IP address of the processing unit in the network.
14	<div style="border: 1px solid black; padding: 5px; width: fit-content;"> Transient Errors =1 14/14 ↑ OK </div>	Connection interrupted in the PROFIBUS DP or PROFINET IO network.

Structure of the Info display for a model set from the RUN menu

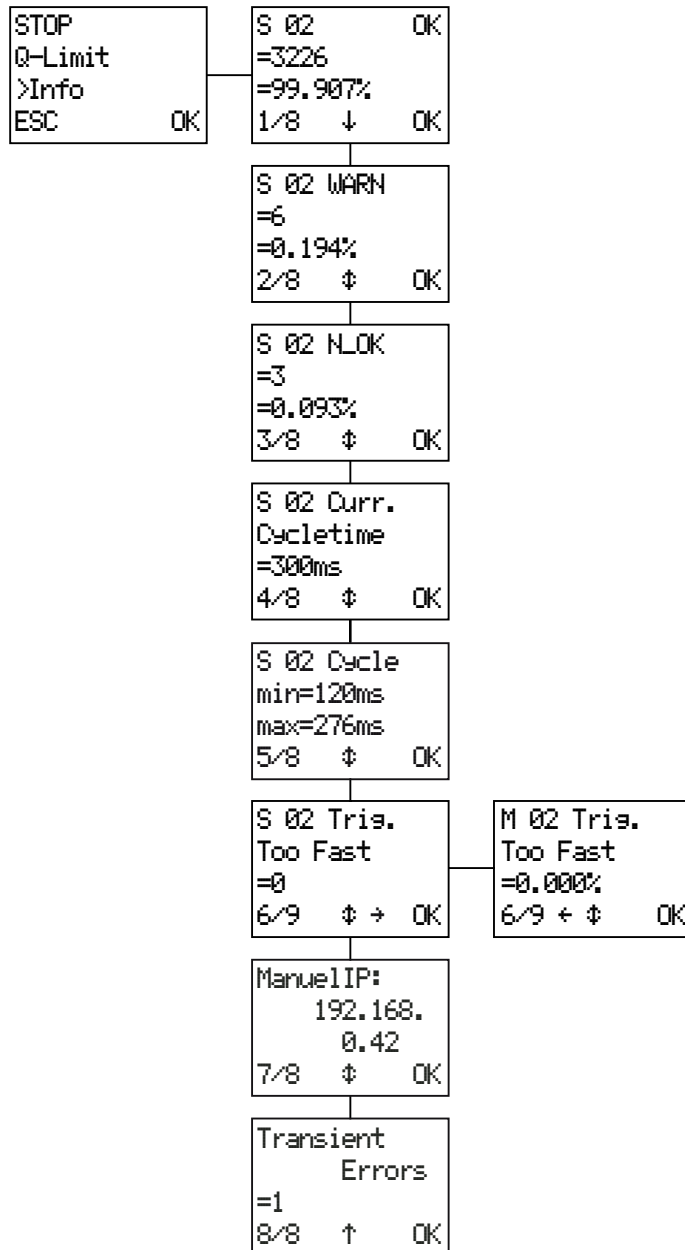

Figure 9-4 RUN menu for a model set

Note

"Transient Errors", the last menu command in the RUN menu, only appears when an error occurs.

9.2.5 Options

Options menu

The following schematics provide you with an overview of all the parameters of the SIMATIC VS120 that can be set in the **Options** menu.

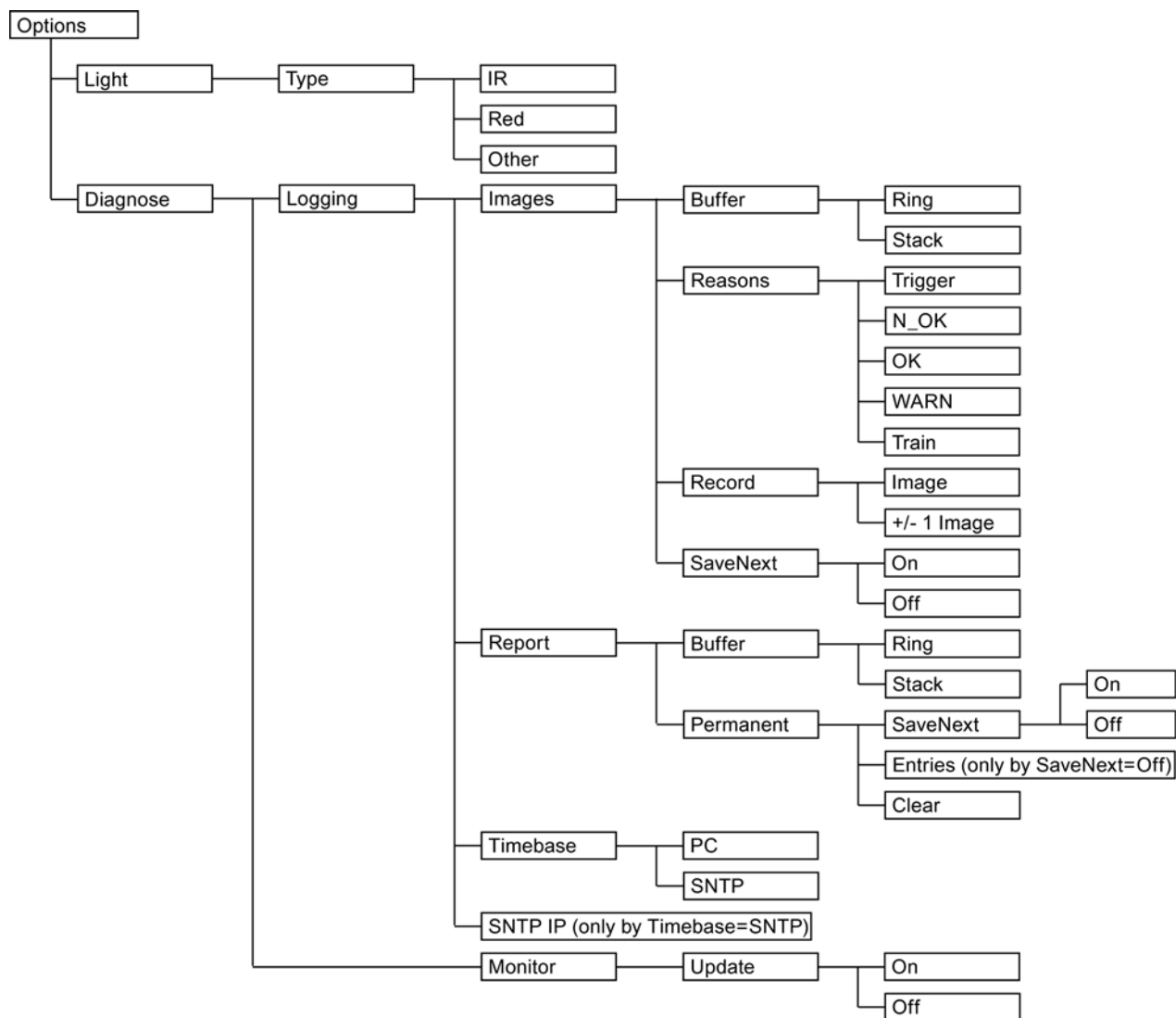

Figure 9-5 Structure of the options menu

Options parameter menu

Parameters	Path	Possible Values	Default	Meaning
Light				
Type	Light	<ul style="list-style-type: none"> • IR • Red • Other 	Red	Here, you enter the type of illumination being used.

Parameters	Path	Possible Values	Default	Meaning
Diagnostics				
Buffer	Diagnose> Logging> Images	<ul style="list-style-type: none"> • Ring • Stack 	Ring	<ul style="list-style-type: none"> • Type of image buffer:· • Ring: When the buffer contains 6 entries, entries 1,2 ... are overwritten. • Stack: When the buffer contains 6 entries, no further entries are made.
Reasons	Diagnose> Logging> Images	<ul style="list-style-type: none"> • Trigger • N_OK • OK • WARN • Train 	N_OK	This is where you specify what causes an image to be saved.
Record	Diagnose> Logging> Images	<ul style="list-style-type: none"> • Image • +/- 1 Image: 	Image	<ul style="list-style-type: none"> • Image: If one or more of the causes listed above occurs, the current image is saved. • +/- 1 Image: Not only the current image but also the previous and next image are saved.
Save Next	Diagnose> Logging> Images	<ul style="list-style-type: none"> • On • Off 	Off	<ul style="list-style-type: none"> • On: The image belonging to the next NOK event is saved permanently in the EEPROM.
Buffer	Diagnose> Logging> Report	<ul style="list-style-type: none"> • Ring • Stack 	Ring	<ul style="list-style-type: none"> • Ring: When the diagnostic buffer contains 5000 entries, entries 1,2 ... are overwritten. • Stack: When the diagnostic buffer contains 5000 entries, no further entries are made.
Save Next	Diagnose> Logging> Report> Permanent	<ul style="list-style-type: none"> • On • Off 	Off	<p>As soon as the function is enabled, as many diagnostic entries as you specify in "Entries" are saved in the EEPROM. Existing entries are deleted when you switch over to On. If the diagnostic buffer in the EEPROM reaches the number of permanently storable diagnostic data records, no further entries are made.</p> <p>Note: Deleting takes several seconds.</p>
Entries	Diagnose> Logging> Report> Permanent	10 to 2000	2000	Number diagnostic data records that can be stored on the EEPROM

Parameters	Path	Possible Values	Default	Meaning
Diagnostics				
Clear	Diagnose> Logging> Report> Permanent	-	-	Delete all the diagnostic entries stored on the EEPROM Note: Deleting takes several seconds.
Timebase	Diagnose> Logging	<ul style="list-style-type: none"> • PC • SNTP 	PC	Here, you specify the source for the time stamp of the diagnostic events.
SNTP IP (only when Timebase= SNTP)	Diagnose> Logging	xxx.xxx.xxx.xxx (xxx=0 to 255)	192.168.0.44	IP address of the SNTP server
Update	Diagnose> Monitor	<ul style="list-style-type: none"> • On • Off 	On	This is where you specify if diagnostic images, reports and a current image is to be displayed in processing mode. <ul style="list-style-type: none"> • On: Display • Off: Not displayed

9.2.6 Maintain

Maintain menu

The following schematics provide you with an overview of all the parameters of the SIMATIC VS120 that can be set in **Maintain**.

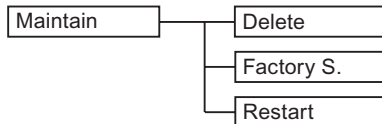

Figure 9-6 Structure of the Maintain menu

Maintain parameter menu

Parameters Maintain	Path	Possible Values	Default	Meaning
Delete	Maintain> Delete	Model 01 to model 64	01	This function deletes individual models
FactoryS	Maintain> FactoryS	<ul style="list-style-type: none"> • ESC • OK 	-	This function resets the VS120 processing unit to the factory settings and restarts it.
Restart	Maintain> Restart	<ul style="list-style-type: none"> • ESC • OK 	-	This function restarts the VS120 processing unit.

9.3 Working with setup support

9.3.1 Introduction

Notice**Possible data loss!**

The editing data is lost if the Internet Explorer or the input screens are turned off without first saving the data because the application does not have session memory.

You should therefore always save your data to avoid losing it.

Note**Online Help**

At the bottom right of each page of adjustment support, you will see a "Help" button with which you can call up online help at any time. The relevant help text of the online help opens depending on the currently open dialog.

Open the Start Page of the adjustment support in the Internet Explorer, refer to the section "Commissioning using adjustment support on the PG / PC with installed Internet Explorer".

With "**Adjust Sensor**", you display the user interface of the SIMATIC VS120.

Note

When you open adjustment support, the dialog that opens corresponds to the current operating state of the VS120 processing unit. The appropriate job is activated depending on the previous operating state of the VS120 processing unit.

If, for example, the VS120 processing unit is in Stop mode, the page below opens:

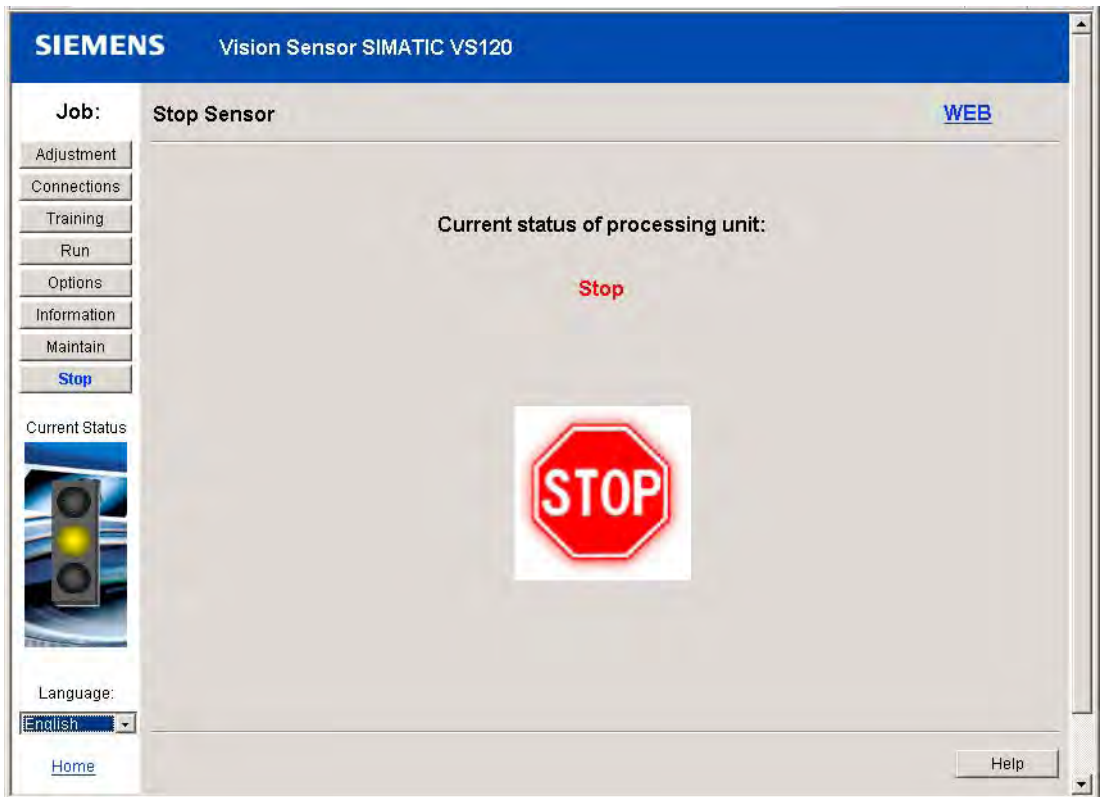

Figure 9-7 Stop

In the left part of the user interface, you will see the list of jobs in the form of buttons. You activate the required job by clicking on the appropriate button. The corresponding dialog then opens on the right of the user interface. At the same time, the text of the buttons becomes bold and the font color changes to blue.

The SIMATIC VS120 Vision Sensor user interface based on the Web server, provides the following dialog boxes for processing images:

Task

- Adjustment;
- Connections;
- Train;
- Run;
- Options;
- Info;
- Management;
- Stop

Traffic Light

Below the Job buttons, there is a traffic light with which you can see the operating status of the VS120 processing unit at a glance. The traffic light can have the following states:

- Green: VS120 processing mode with results output
- Yellow: STOP including adjustment and training
- Red: Errors

Error display

If an error occurs, the traffic light changes to red and the corresponding error message, the meaning of the error and ways to eliminate the error are displayed.

You acknowledge the error by clicking the "Acknowledge" button.

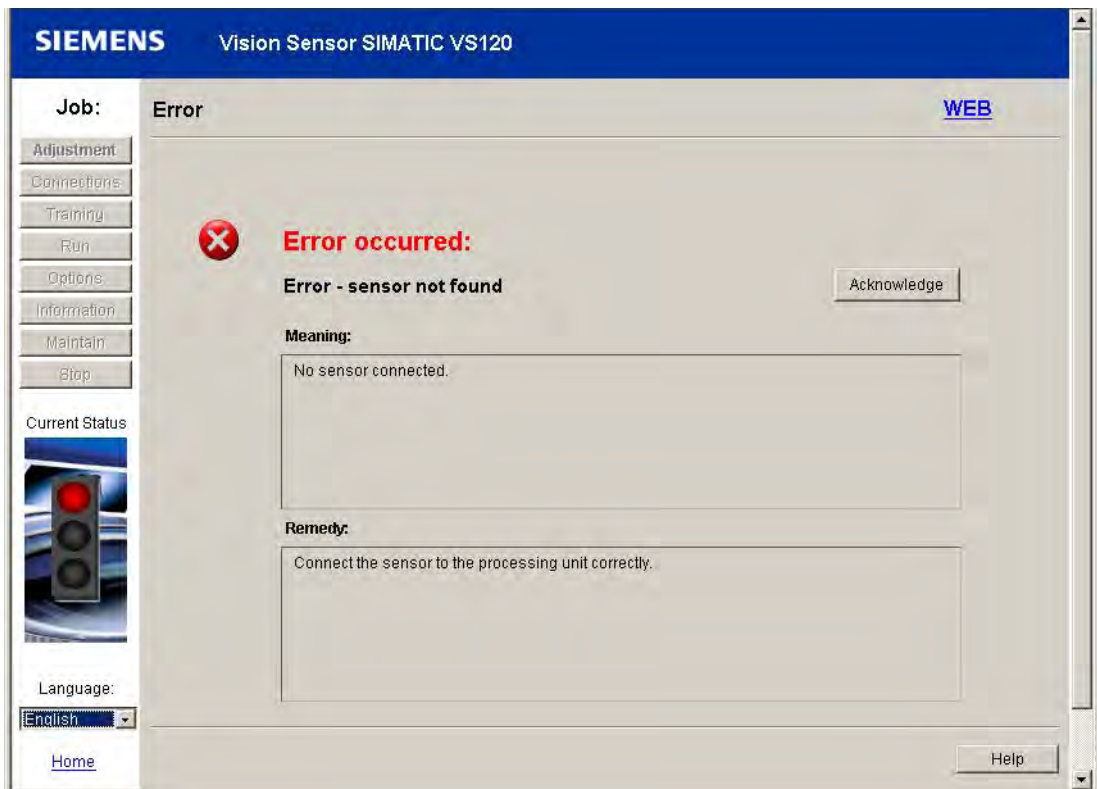

Figure 9-8 Error Message

Changing the language setting

At the bottom left, you will see a drop-down list box for language selection. You can change the language setting for the entire user interface at any time.

User name

The currently logged on user, WEB for example, is shown at the upper right of the page. By clicking on the user name, you open "Options - Security tab".

The following users are possible:

- WEB (default): General user who can execute tasks without explicitly logging on
- Service: Service technicians
- User1: Freely available
- Admin: Administrator

The "Admin" user assigns permissions for all users and changes their passwords.

Note

The "WEB" setting effectively means no user. It simply indicates that there is a connection between the Web browser and the adjustment support.

Help

At the bottom right, you will see a "Help" button with which you can call up online help at any time.

9.3.2 Adjust Sensor

In this dialog, you make the basic settings for processing the image.

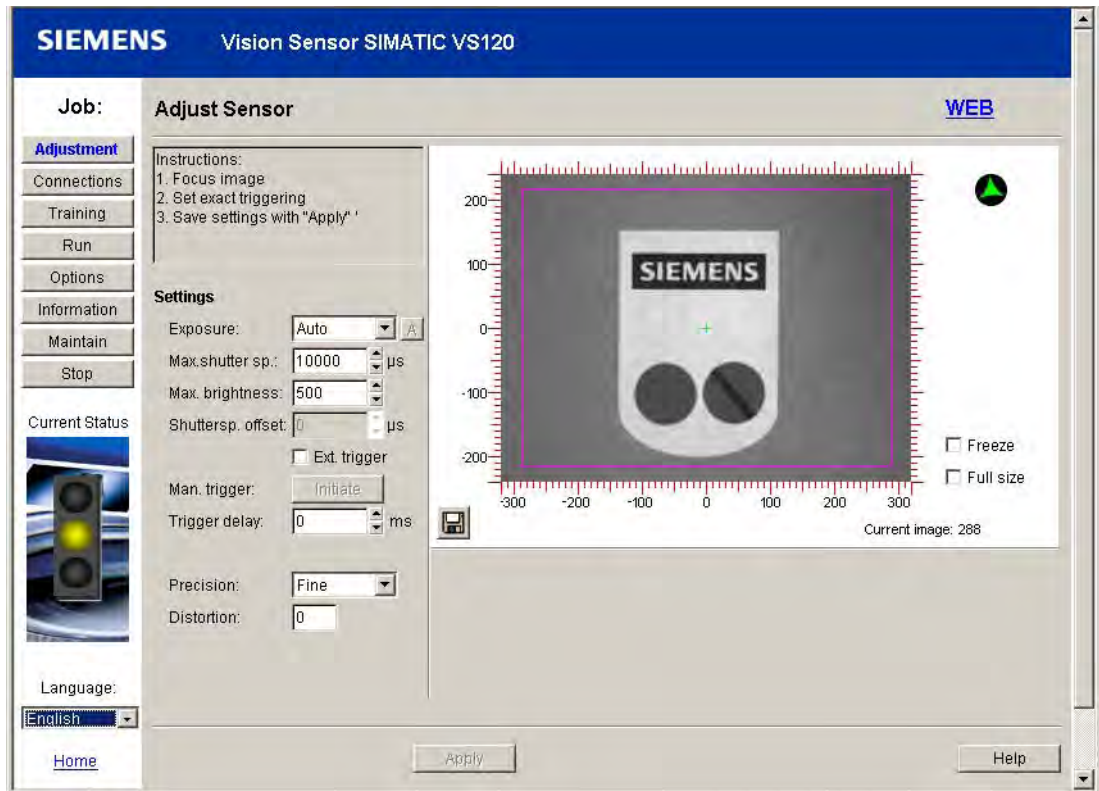

Figure 9-9 Adjustment

Settings

This is where you enter the parameters for image capture and processing.

9.3.3 Connections

The Connections dialog is made up of the following three parts:

- Part 1/3: Interfaces
- Part 2/3: Integration
- Part 3/3: Version

Part 1/3: Interfaces

Here, you specify the communication ports and the parameters for the ports.

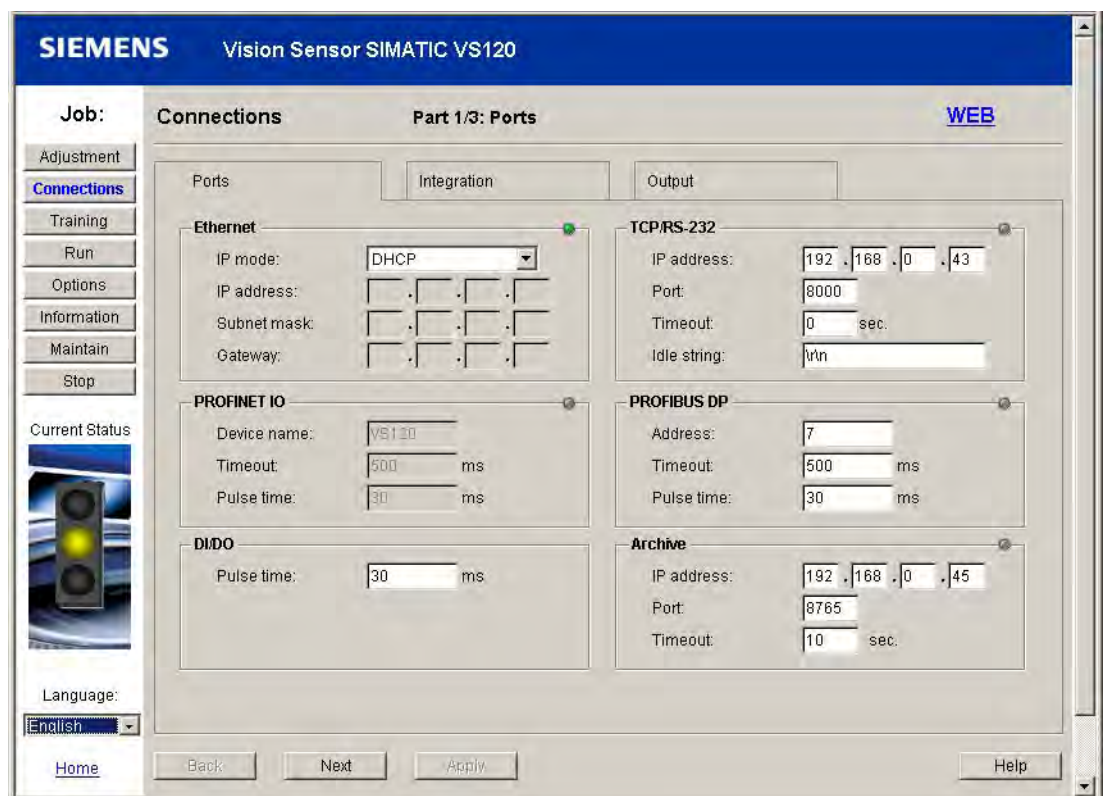

Figure 9-10 Connections - Ports tab

Part 2/3: Integration

This is where you specify the path over which signals are sent to the VS120 processing unit and over which path the results are output.

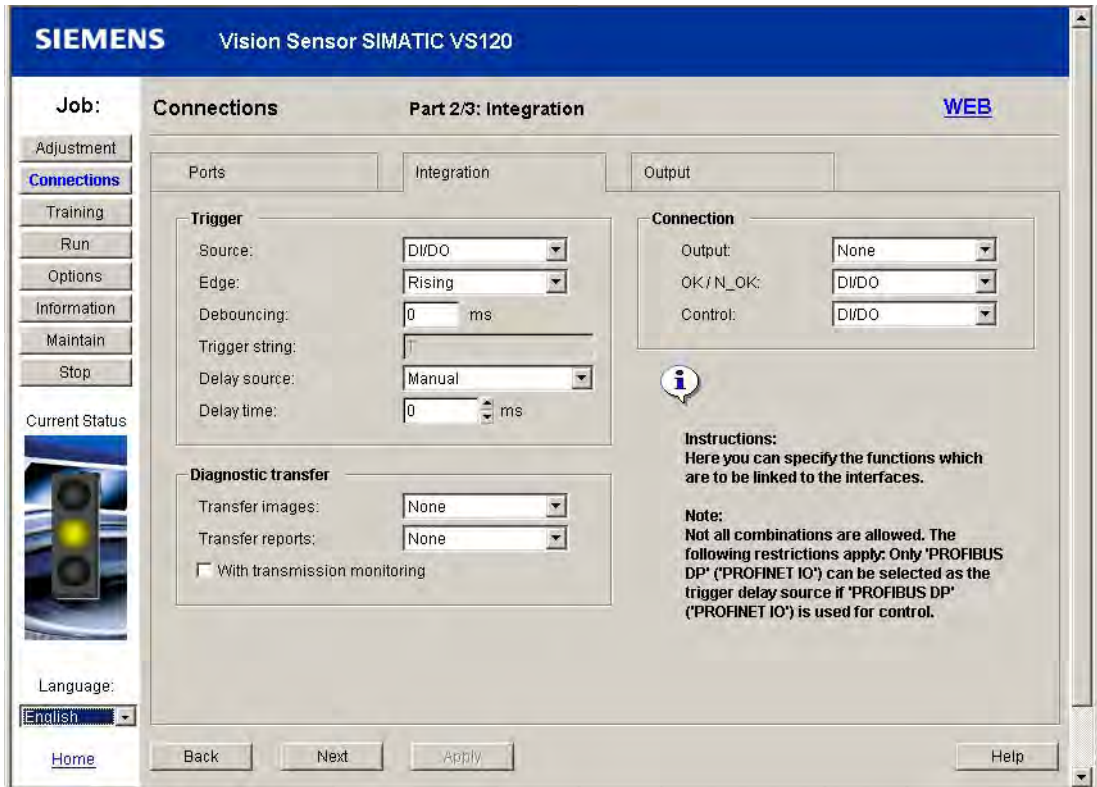

Figure 9-11 Connections - Integration tab

Part 3/3: Version

This is where you specify the format for outputting the results through the interface set in the *Connections - Output* selection menu of the "Connections - Integration tab".

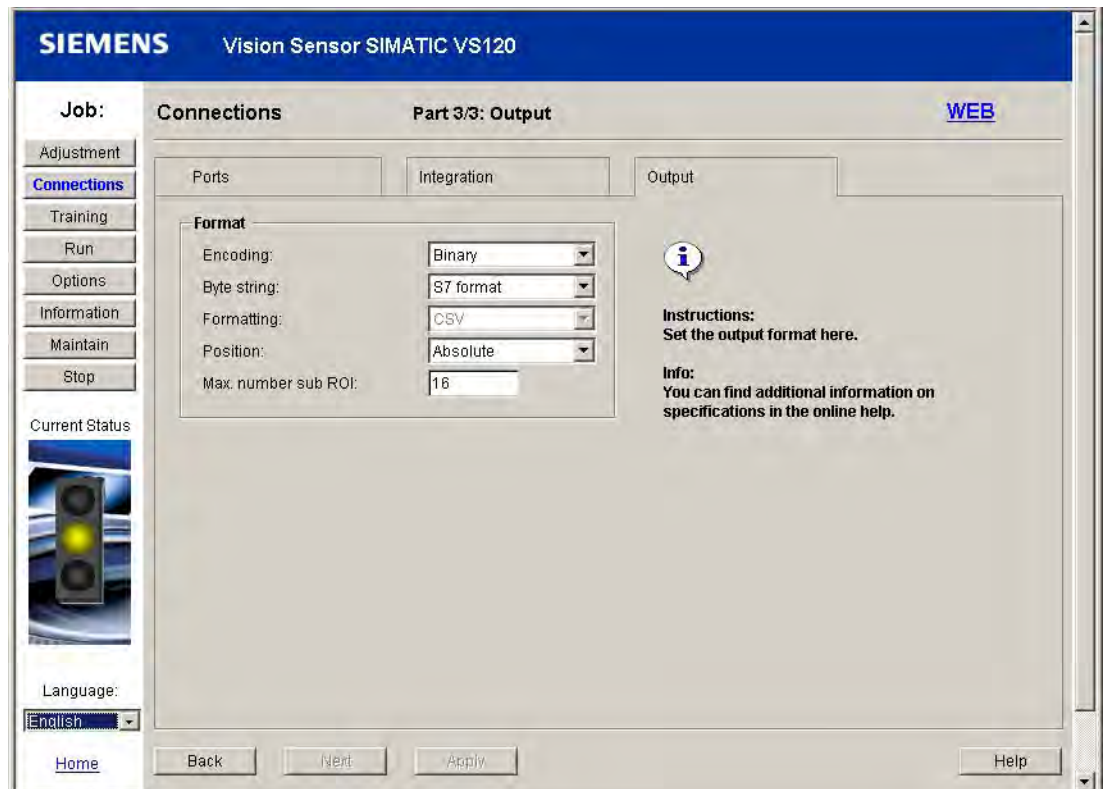

Figure 9-12 Connections - Output tab

9.3.4 Train

When a model is transferred, the SIMATIC VS120 Vision Sensor learns the significant characteristics (edges) of the model's main ROIs and Sub-ROIs for subsequent processing of the specimen.

After selecting **Training**, five tabs appear:

- Selection
- ROI
- Edges
- Test
- Save

The easiest way to train a model is to work through the tabs one after the other. You can use the *Next* and *Back* buttons to navigate between the tabs. You can, however, also select specific tabs. If tabs are skipped, the default values will be set.

Part 1/5: Selection

You can set the parameters for models, images and manual trigger in the "Training - Selection tab".

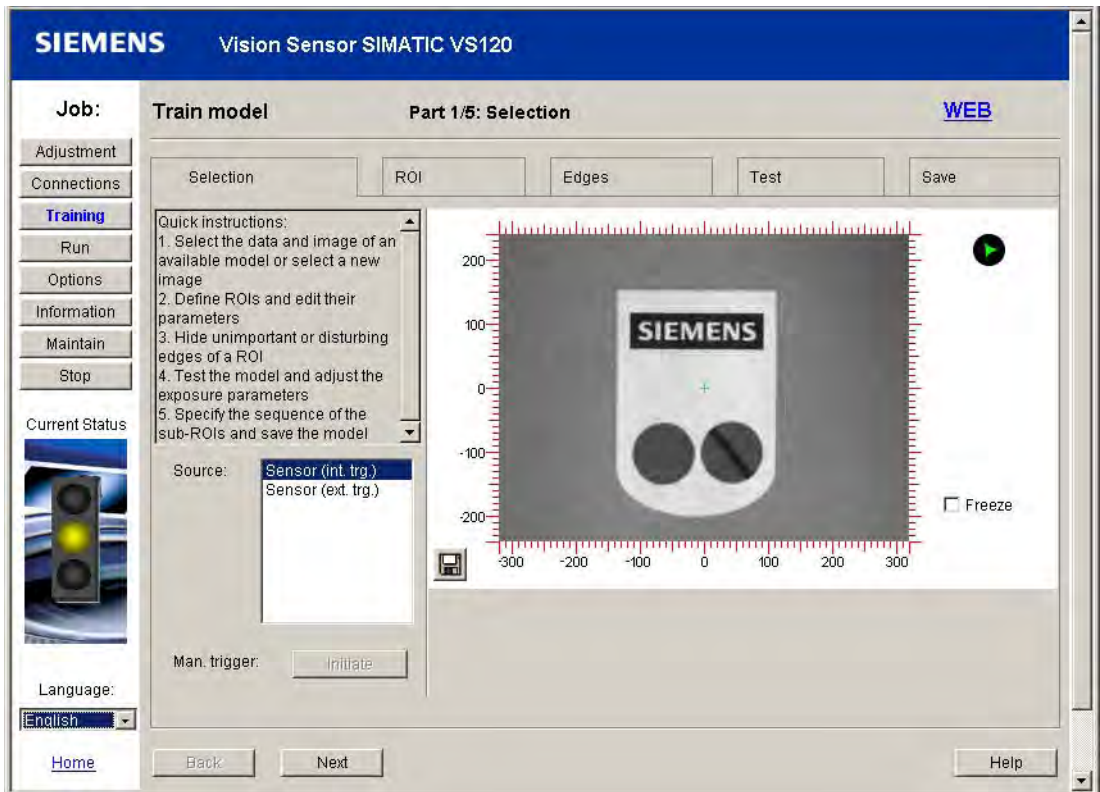

Figure 9-13 Training - Selection tab

Part 2/5: ROI

In the "Training - ROI" tab, you can specify the properties for the main ROI and the sub-ROIs. You define the main ROI and any sub-ROIs for image processing in the ROI tab. The relationships between the functions of main ROI and sub-ROI are described in the section *Image processing*.

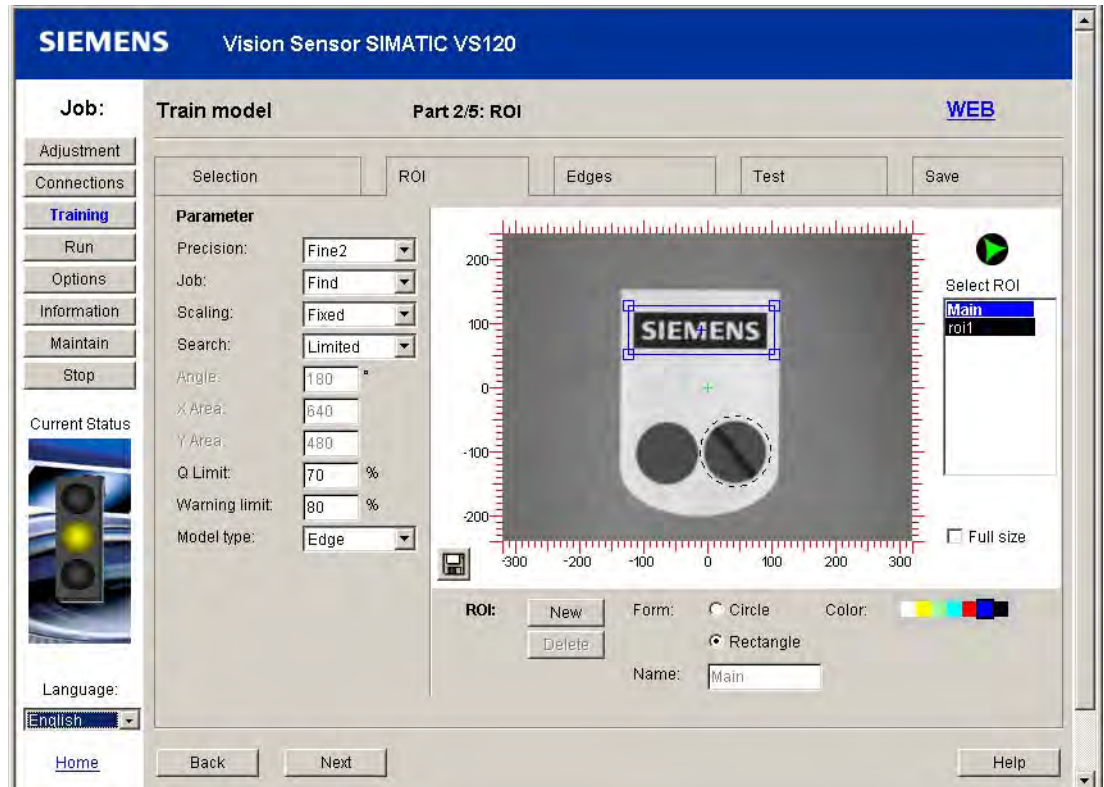

Figure 9-14 Training - ROI tab

Note

- The main ROI is always available and cannot be deleted. Sub-ROIs can be created by pressing the "New" button or deleted with "Delete".
- The outside edges of the main ROI should be very close to the model to obtain a good evaluation of the image.
- The sub-ROIs will only be found if the quality of the main ROI is better than the defined quality limit (Q Limit).

Main ROI and sub-ROIs:

A main ROI is selected with the mouse for image processing. This main ROI indicates the specimen in the exposure that should be analyzed. You can define up to 16 sub-ROIs for this. These sub-ROIs define regions within the main ROI in greater detail. For evaluation, the sub-ROIs can also be located outside the main ROI.

Changes to main and sub-ROIs:

- A ROI can be picked up by its edge and moved using drag-and-drop.
- When you click on it, square handles appear at the corners that allow you to change the size.
- A round handle appears at the corners when you click on the ROI again. The ROI can be rotated in this state.
- Using the "ROI shape" radio buttons, you can switch between a circle and a rectangular form for the current ROI .
- The coordinates of the current ROI are displayed below the image: Position (x, y), Size (width, height) and Angle.
- If you require more precise positioning, you can zoom the image to its original size using the "Full size" *check box*.

Names and colors:

- In the "Name" text box, you can assign a name with a maximum of 8 characters to each sub-ROI.
- The names of the defined ROIs are displayed in the selection list and can be selected by clicking on them in the list or by clicking on them in the image.
- You can assign a color to each ROI in addition to the name to help you identify it in the image. The ROI is then displayed with this color in the image and selection list.
- In this selection list and in the selection lists of the other tabs, the currently selected ROI is shown as follows:
 - Non-selected ROIs are dashed
 - Selected ROIs are solid
 - Selected and editable ROIs are solid and provided with marking points

Part 3/5: Edges

If you click on the Training - Edges tab, you start the editing of edges or retouching of unnecessary image features.

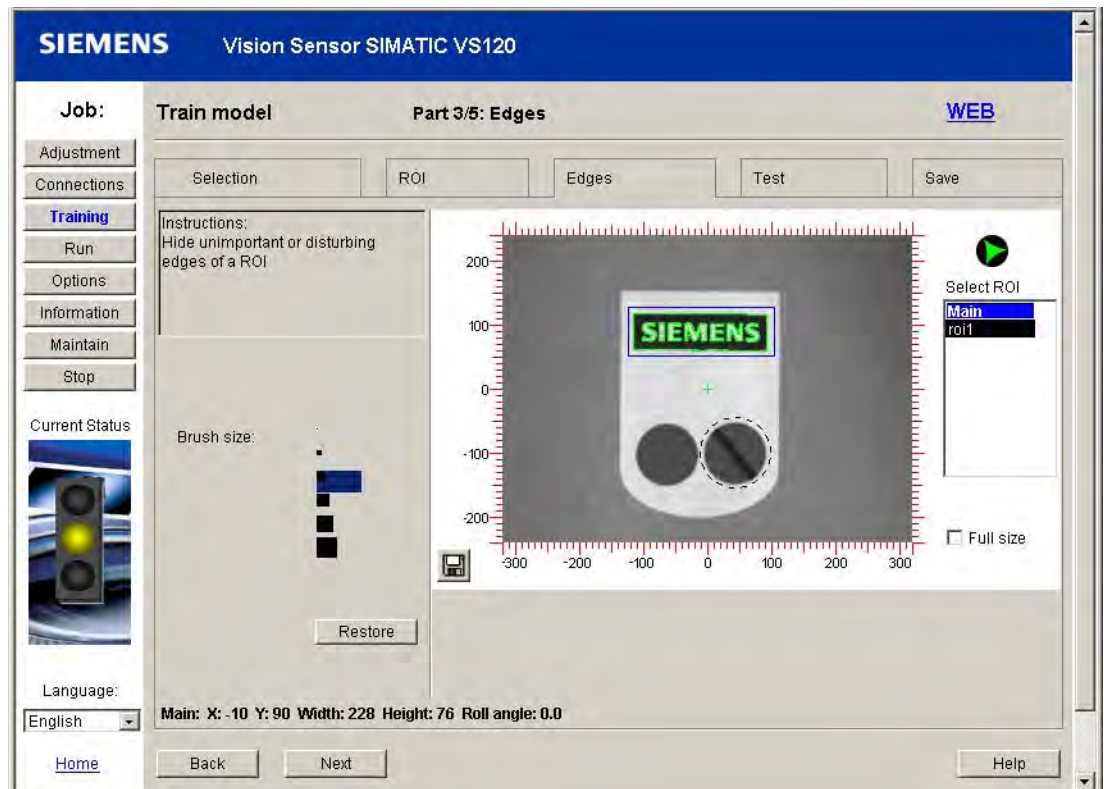

Figure 9-15 Training - Edges tab

The edges found by the algorithm are outlined in the image. Specific edges can now be marked as unimportant for each ROI by erasing them with a brush. To do this, you select the respective ROI in the selection list or by clicking on it in the image, and erasing the edge with the brush.

On the left, you can see various brush thicknesses that can be selected by clicking on them. The erasures made in the currently selected ROI can be removed with the "Reset" button.

Part 4/5: Test

You start the training program by clicking on the "Single-steps" or "Continuous" control buttons in the Training - Test tab. The displays are for the most part identical to the Run panel with the exceptions:

- Separate statistics are kept
- There is no output to the port
- Models are evaluated but not model sets.

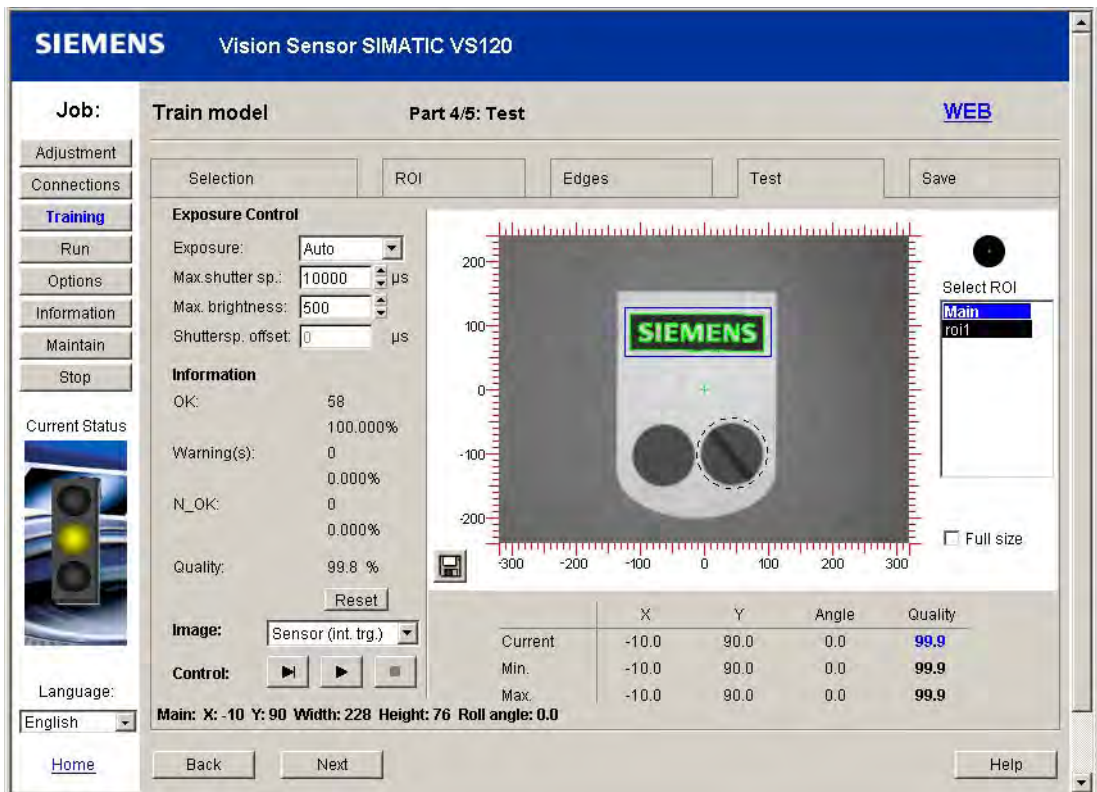

Figure 9-16 Training - Test tab

Part 5/5: Save

You can save a trained model by opening the Training - Save tab. In the Number and Name text boxes, enter the number and name (max. 8 characters) of the model you want to save.

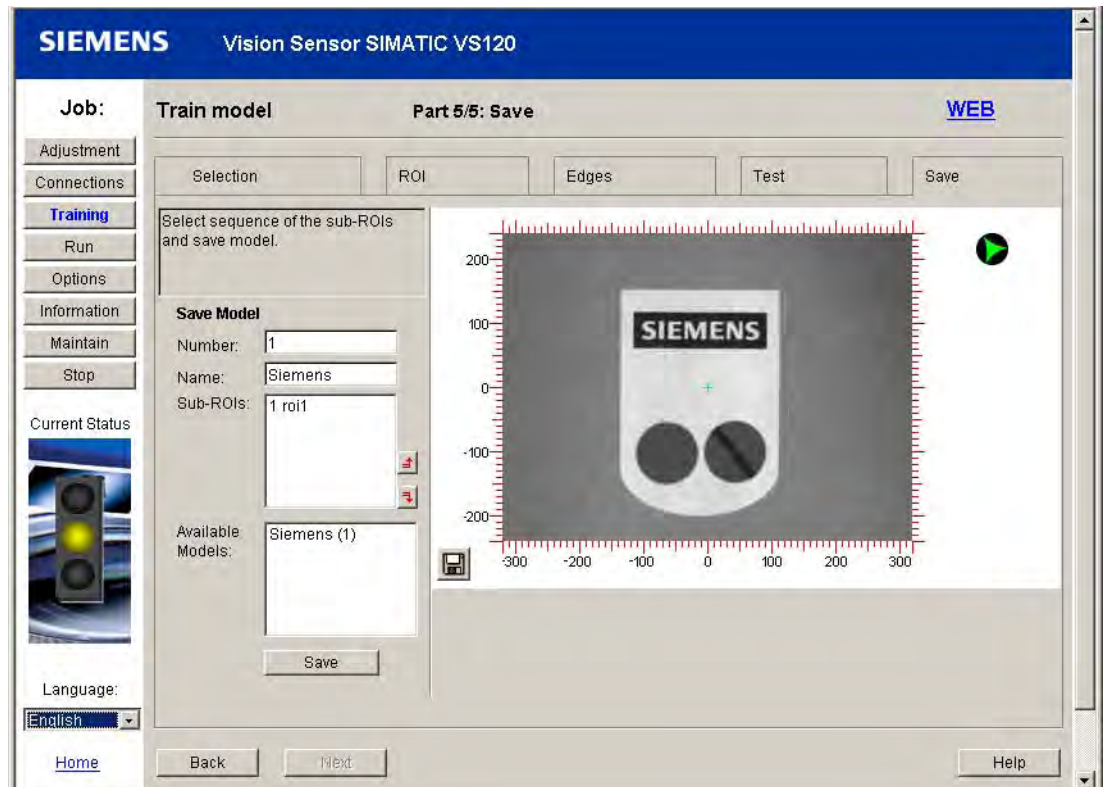

Figure 9-17 Training - Save tab

9.3.5 Processing

The "Processing" panel is divided into two areas: You start processing a model or model set with "Start" on the left. Statistics on the currently running process are also displayed in a multiple-page area. This corresponds to the results shown in the Info - Statistics tab.

- The Q limit and warning limit can be increased or decreased using the Q Limit button for optimizing the processing. The current value is shown beside the buttons and the modified values can be stored on the controller with "Apply".
- On the right, you can see the most recently processed image. The results from the last evaluation are also graphically displayed in this image. The results to be displayed can be configured in drop-down lists and check boxes located next to and below the image.
- A table below the current image shows the result of the most recent evaluation. The content of the table can be configured with a drop-down list next to the current image.

Select model / Select model set

This is where you enter the number of a previously trained model or model set that you want to compare with a current specimen. The numbers of all previously trained models or model sets are displayed in a drop-down list box.

Note

The "Model" drop-down list appears when the "Multimodel" drop-down list is set to "Use" in the "Options - Extras" tab. This is equivalent to normal mode.

The "Model Set" drop-down list appears when the "Multimodel - Use" is set to "On" in the "Options - Extras" tab. This is equivalent to classification mode.

Normal mode during test and recognition

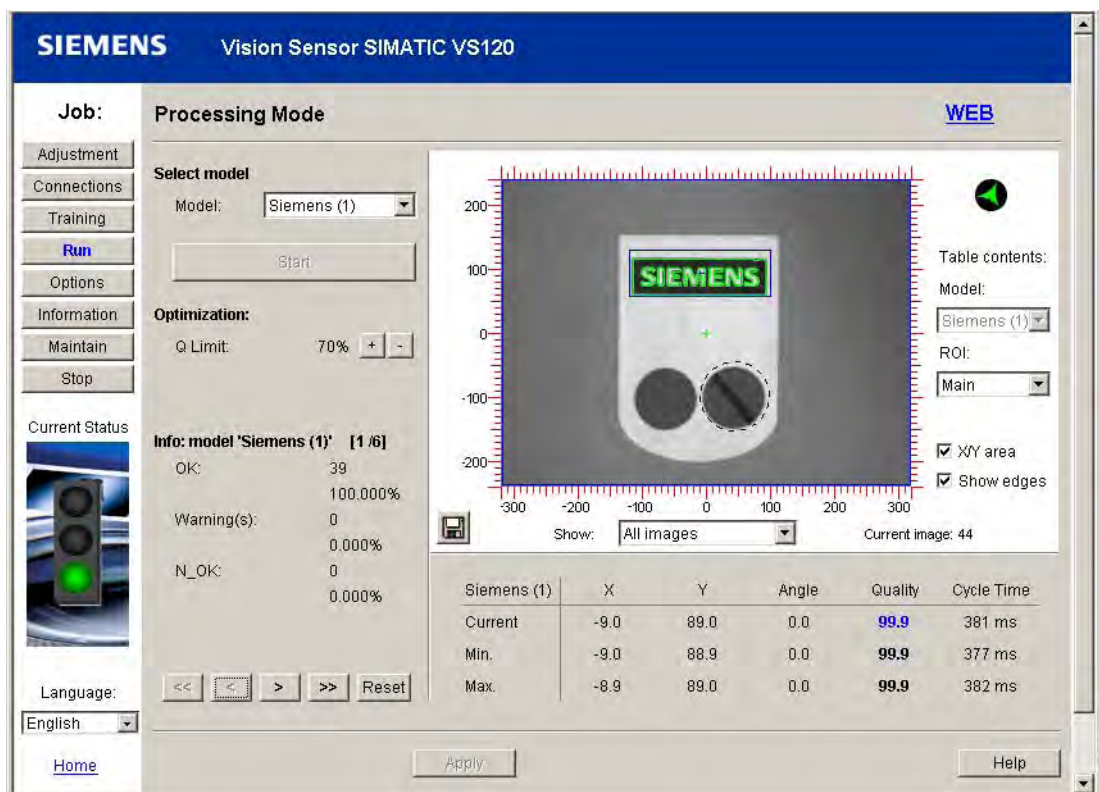



Figure 9-18 Processing in normal mode

Features

- You can navigate through the processing results information using the  buttons.
- The ROI whose result should be displayed can be selected in normal mode under "Table content ROI" on the right.
- The quality is displayed color-code based on the results.
- The ROIs are displayed in the color specified in the "Training - ROI tab"

Note

Edges are only shown if the "Show edges" check box is enabled.

- Color scheme for edges in processing mode:
 - *Blue*: Edge lines that have been erased
 - *Green*: Edges above the threshold value
 - *Red*: Edges below the threshold value appear in red

Example of processing results for testing and recognition in normal mode

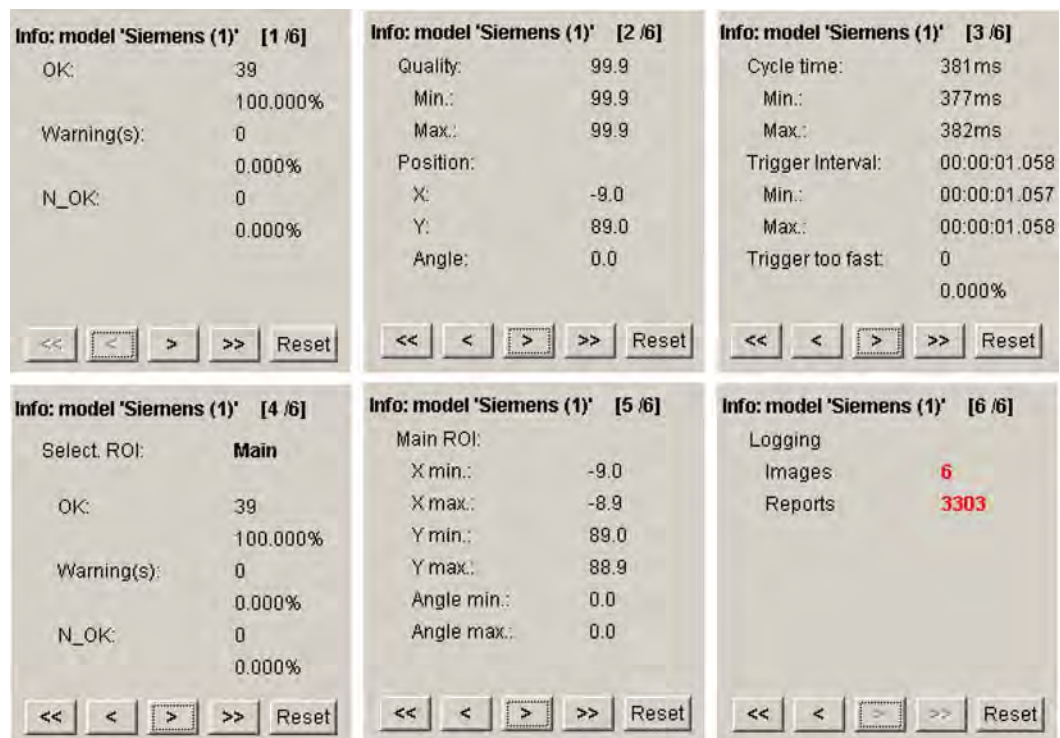

The figure displays six screenshots of the 'Info' pages for model 'Siemens (1)' in normal mode, arranged in a 2x3 grid. Each screenshot shows a different page of information, with navigation buttons at the bottom of each page.

Page	Info: model 'Siemens (1)' [1 /6]	Info: model 'Siemens (1)' [2 /6]	Info: model 'Siemens (1)' [3 /6]
1	OK: 39 Warning(s): 0 N_OK: 0	Quality: 99.9 Min.: 99.9 Max.: 99.9 Position: X: -9.0 Y: 89.0 Angle: 0.0	Cycle time: 381 ms Min.: 377ms Max.: 382ms Trigger Interval: 00:00:01.058 Min.: 00:00:01.057 Max.: 00:00:01.058 Trigger too fast: 0
2	Select ROI: Main OK: 39 Warning(s): 0 N_OK: 0	Main ROI: X min.: -9.0 X max.: -8.9 Y min.: 89.0 Y max.: 88.9 Angle min.: 0.0 Angle max.: 0.0	Logging Images: 6 Reports: 3303

Figure 9-19 Info pages: Processing in normal mode

Classification mode for part recognition

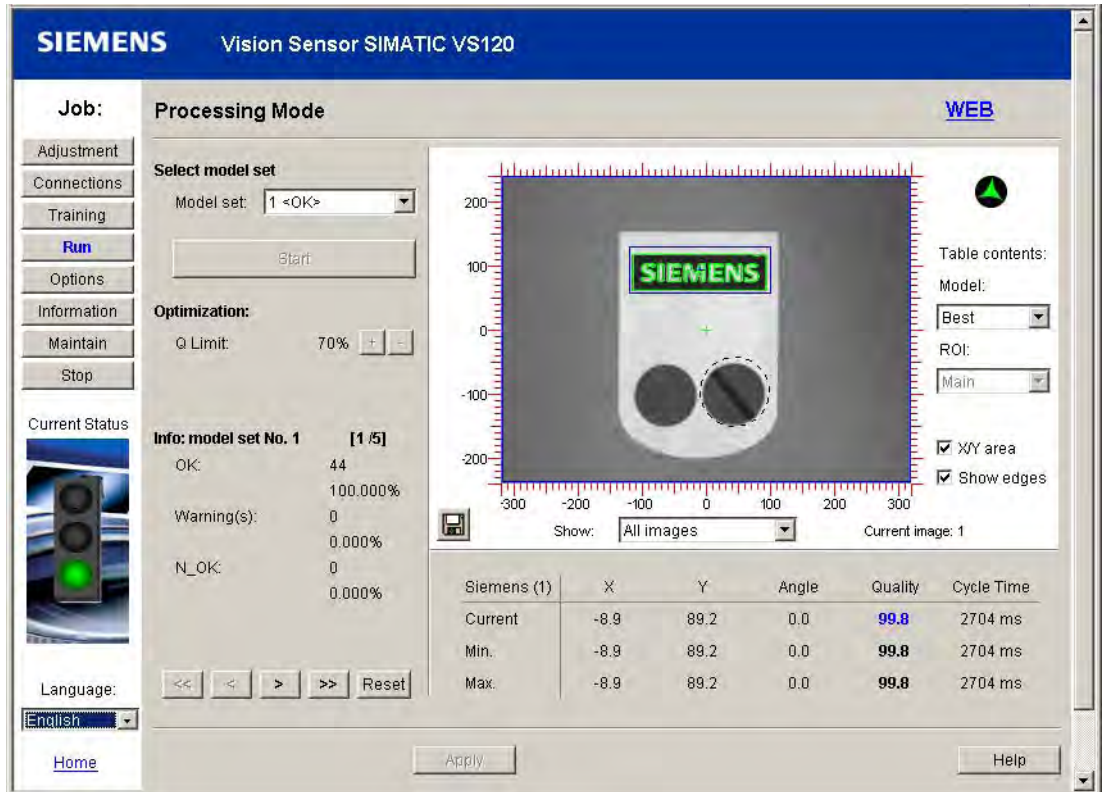

Figure 9-20 Processing with classification mode

Features

- The processing mode with model sets provides you with evaluation results for the entire model set.
- Information about the best model, the individual models and any sub-ROIs in the models is also displayed.
- The quality is displayed color-code based on the results.

Example of processing results for part recognition with classification mode

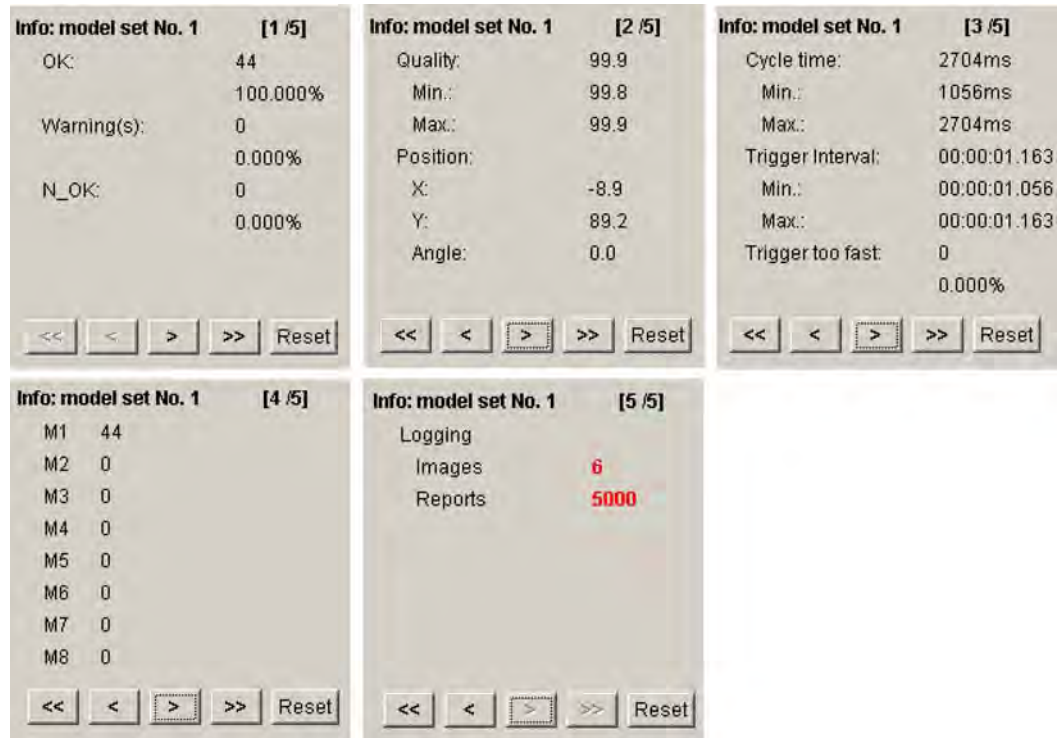

Figure 9-21 Information pages for processing with classification

9.3.6 Options

You can change additional default settings for training models, user permissions, saving information for diagnostic purposes and additional functions for image processing under "Options". The optional settings have a direct affect on the tasks such as training and evaluation.

The "Options" dialog is made up of the following four parts:

- Part 1/4: Training
- Part 2/4: Security
- Part 3/4: Diagnostics & Monitoring
- Part 4/4: Extras

Part 1/4 Training

You can make the settings for training the main ROI and sub-ROI in the "Options - Training tab".

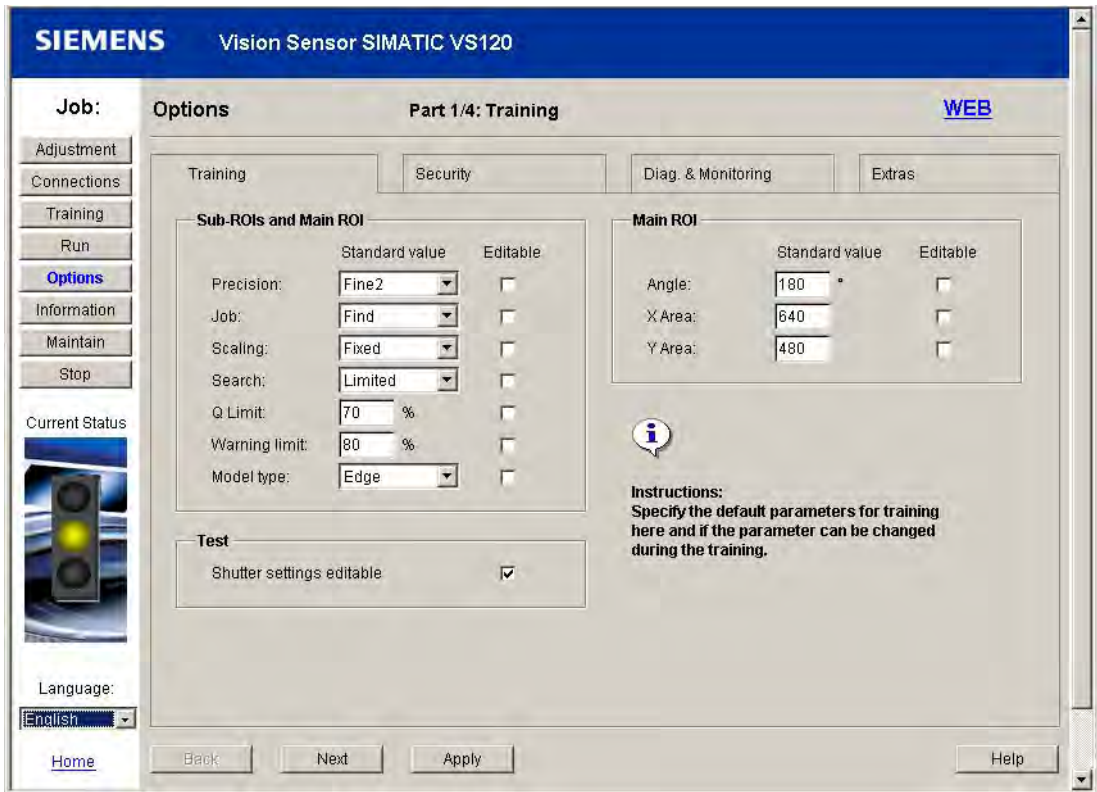

Figure 9-22 Options - Training tab

As default, the "Editable" check box is not selected. If you enable a check box, Precision for example, you can change these parameters during training. Otherwise, the default values here are used for training.

Note

The setting for the "Precision" depends on the setting for the precision in the "Adjustment".

Part 2/4: Security

By clicking on the user name or on **Safety** in **Options**, you open "Options - Security tab". You can see all the currently assigned user permissions here.

Notice

In the **Security** tab, the administrator specifies which user is permitted to execute which tasks and can, when necessary, change the passwords of the users. The permissions can only be changed with **administrator privileges**.

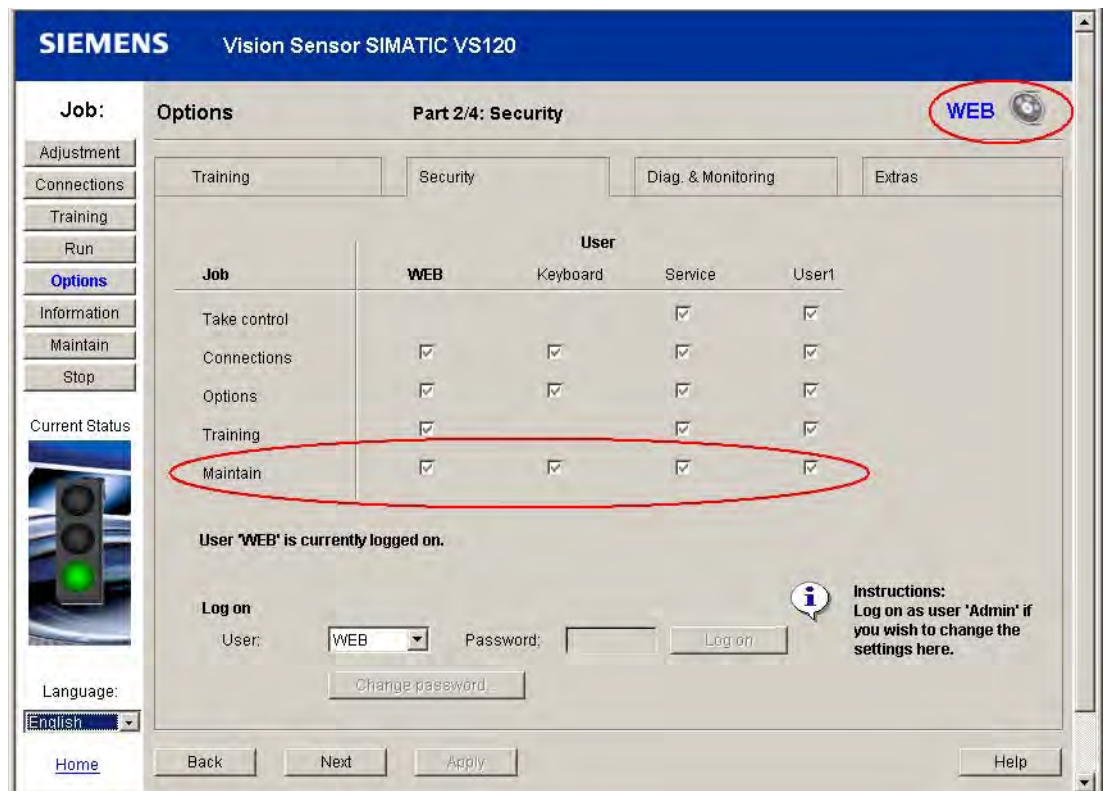

Figure 9-23 Options - Security tab - user rights

Currently logged on user and adjustment support mode

By moving the mouse pointer on WEB, a popup field displays the permissions of the user. The following icons can be displayed in the popup:



Red padlock with black R: Read-only mode, in other words, no operator input possible because the adjustment support of another PC has control of the processing unit.



Gray padlock: The logged on user has no permissions to change settings.



Red padlock with green D: DISA is active. Only the Service and User1 users can take over control of the processing unit from the controller.



Green padlock with gray D: The currently logged on user has taken control of the processing unit or the controller.



The processing mode is active. If you want to make changes, you must first switch the processing unit to STOP.

Users can log on under their names with the appropriate password. Below the "User" table, you can see which user is currently logged on.

User

- WEB (default): General user who can execute tasks without explicitly logging on
- Service: Service technicians
- User1: Freely available
- Admin: Administrator

The "Admin" user assigns permissions for all users and changes their passwords.

Note

The "WEB" setting effectively means no user. It simply indicates that there is a connection between the Web browser and the adjustment support.

In the "Log on" box, you can change these permissions by selecting a user from the "User" drop-down list box and logging on with the correct password.

"Change password ..." Button

The administrator can change the password of any user as follows:

- The "Admin" user logs on. The "Change password ..." button is enabled.
- The administrator selects the user whose password needs to be changed in the "User" drop-down list box.
- Clicking the "Change password ..." button, opens a dialog in which the password of the selected user can be changed.

Assigning Permissions

The "Admin" user is the only user who can assign permissions. To assign permissions, select a user in the table and select the check boxes for the permissions you want to assign to the user.

The rows of the table contain the possible tasks and the columns the possible users.

Note

If the DISA bit is set, in other words, when SIMATIC VS120 Vision Sensor is controlled by a programmable controller, you must log on at the VS120 processing unit as follows:

1. Make sure that only one PC accesses the VS120 processing unit (red padlock with green D).
 2. Place the mouse pointer on the currently logged-on user (top right) and click. This brings you to the "Options - Security" page.
 3. Log on as a user such as "User1" or "Service") who is allowed to take control of the SIMATIC VS120 Vision Sensor ("Take control" check box selected). Remember, however, that logging on means intervention in the control of the SIMATIC VS120 Vision Sensor by the programmable controller (only relevant for functions that require the DISA bit, for example, change models).
-

Part 3/4: Diagn. & Monitoring

In Options - Diagnostics & Monitoring, you specify the information to be stored for diagnostic purposes.

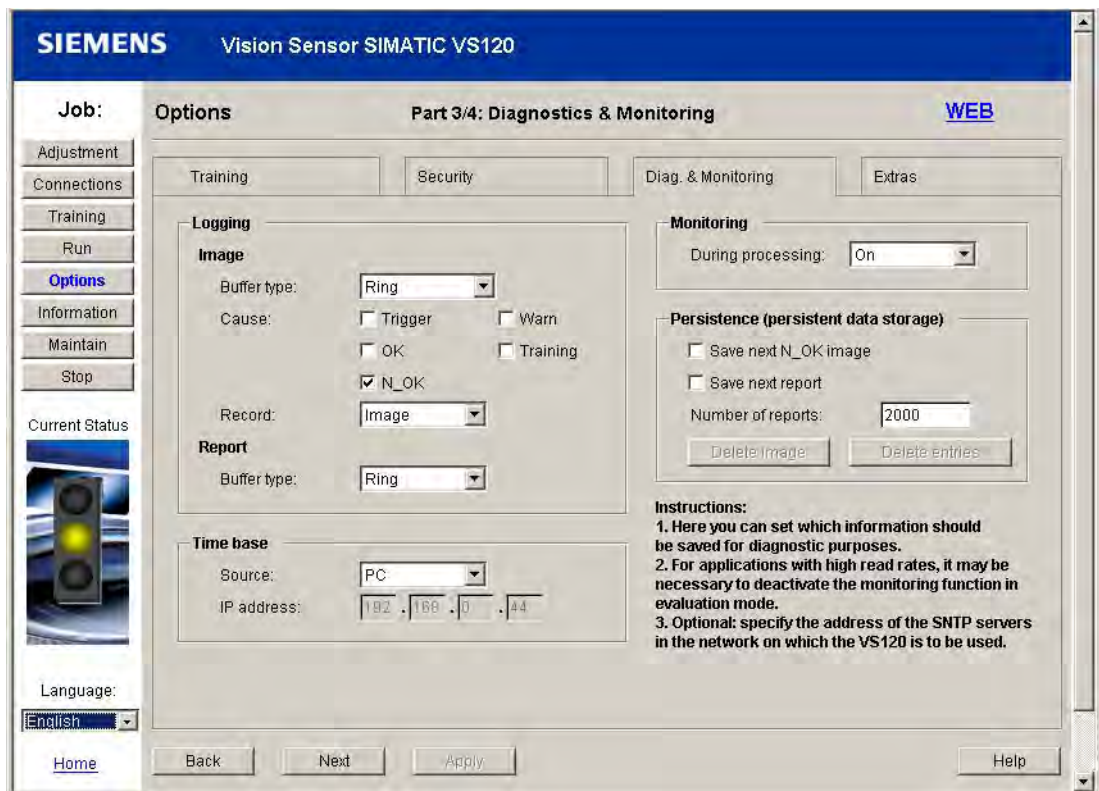

Figure 9-24 Options - Diagnostics & Monitoring tab

Part 4/4: Extras

You can specify the additional functions you want to use for image processing in the Options - Extras tab.

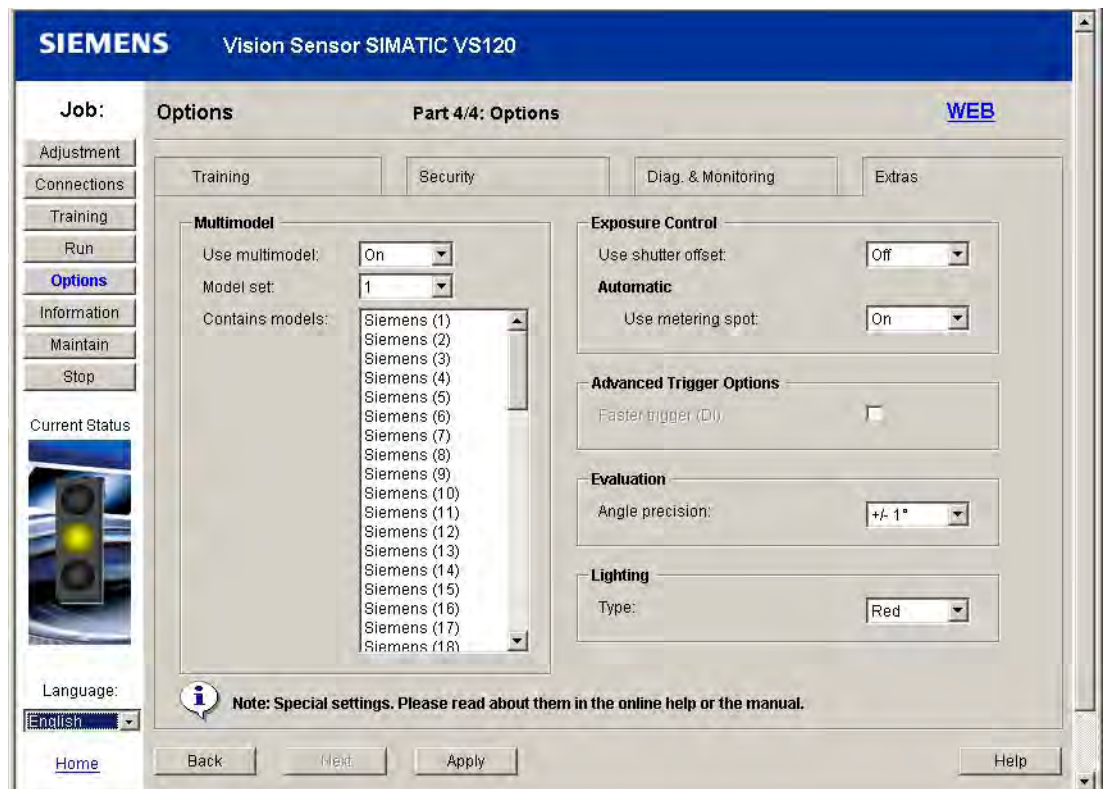

Figure 9-25 Options - Extras tab

9.3.7 Information

The Information dialog consists of four parts:

- Part 1/4: Statistics
- Part 2/4: Model
- Part 3/4: Diagnostics
- Part 4/4: Device Info

Part 1/4: Statistics

This part of the dialog shows you the statistics for recognition with the currently active models / model sets.

Normal mode for examination and recognition (default mode)

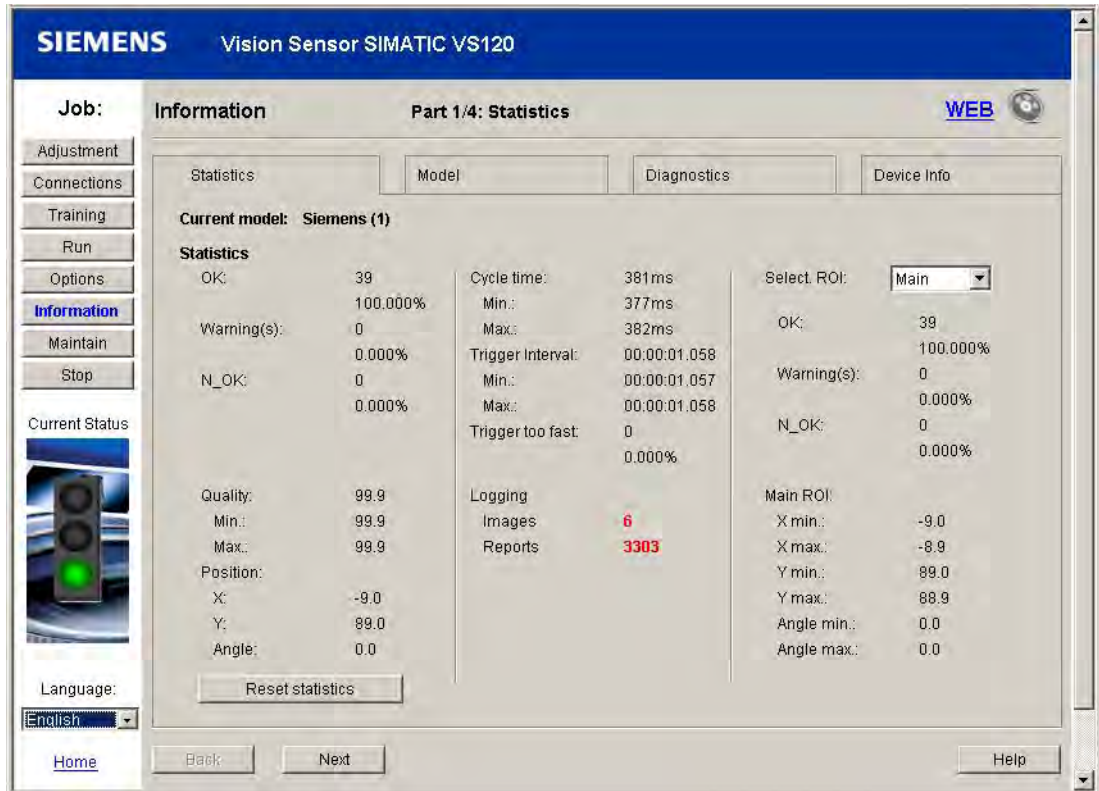

Figure 9-26 Information - Statistics tab in normal mode

You can clear the statistics with the “Reset statistics” button if you have management permissions (see Options - Security tab). The statistics are reset automatically when you change the model.

The list box contains the names of the main ROIs and sub-ROIs of the models. For each main ROI and sub-ROI, you can display the results for OK, Warn and N_OK.

Part recognition with classification mode

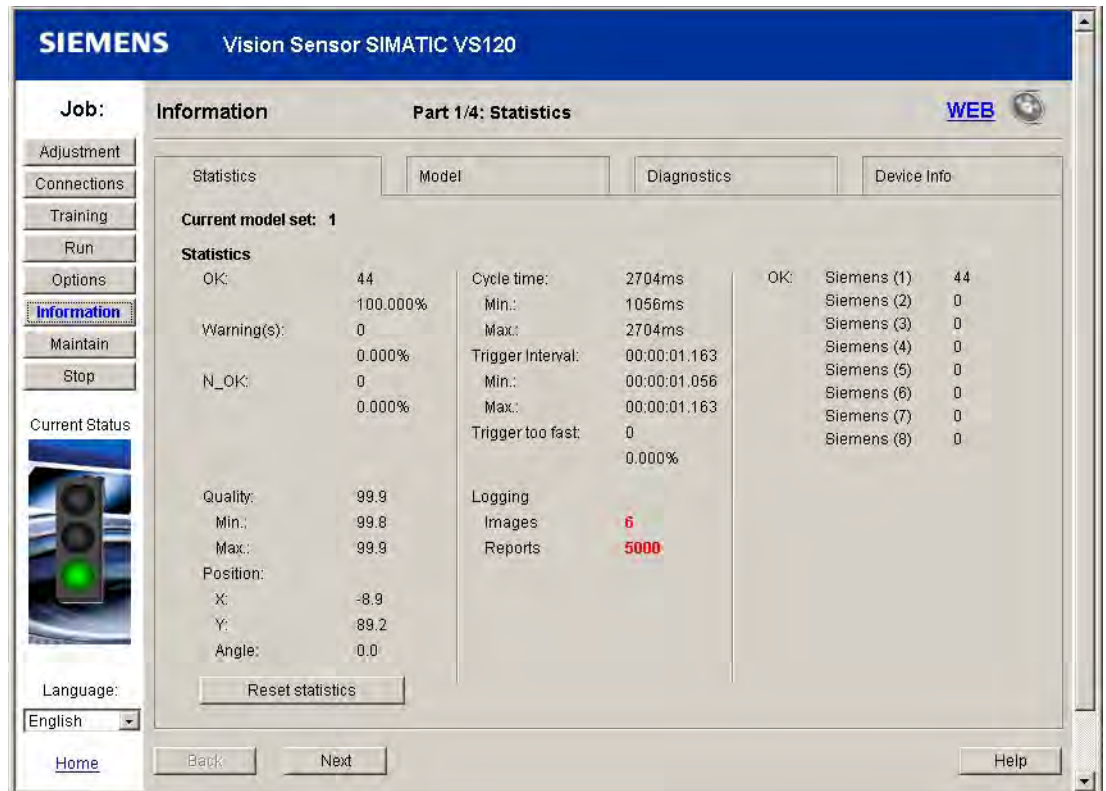

Figure 9-27 Info - Statistics tab in classification mode

In contrast to normal mode, the following statistics results are displayed:

- No results for the sub-ROIs.
- The frequency of the models recognized with OK for the models included in the model set.

Part 2/4: Model

This part of the dialog shows you all the existing information on the selected model.

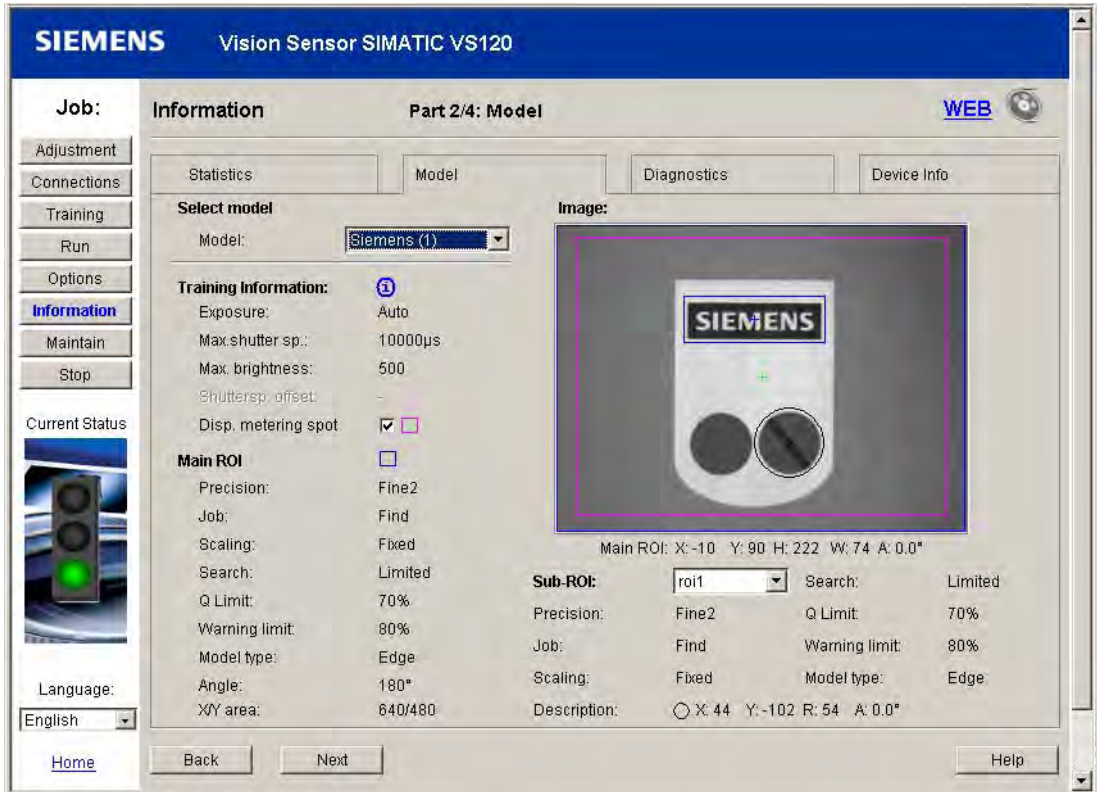

Figure 9-28 Information - Model tab

Part 3/4: Diagnostics

In this part of the, you can display, delete and save and open diagnostics images and diagnostics reports.

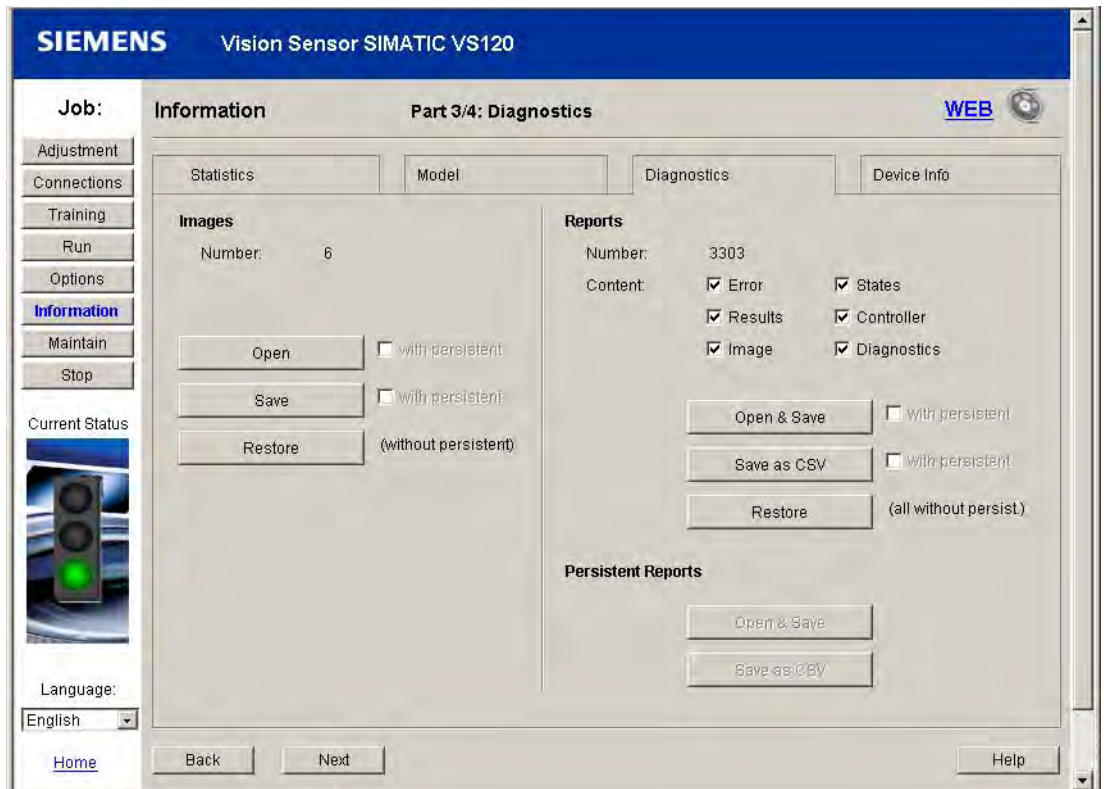

Figure 9-29 Information - Diagnostics tab

Note

The persistent data records option is enabled, when necessary, in the Options - Extras tab

Part 4/4: Device Info

This part of the dialog provides you with information on the processing unit, the firmware and the sensor head.

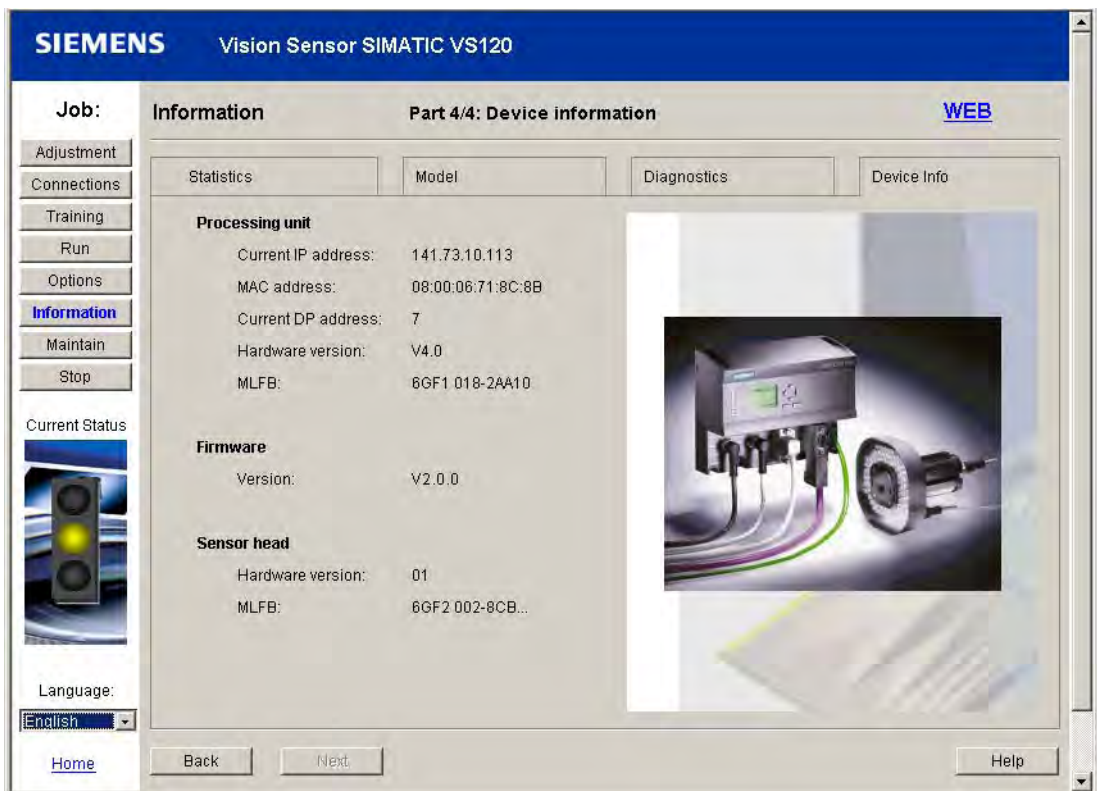

Figure 9-30 Information - Device Information tab

9.3.8 Maintain

The Maintain dialog offers options for deleting, configuring, saving and restoring models and resetting the SIMATIC VS120 to the original factory state. You can also perform any required firmware update in the Maintain dialog.

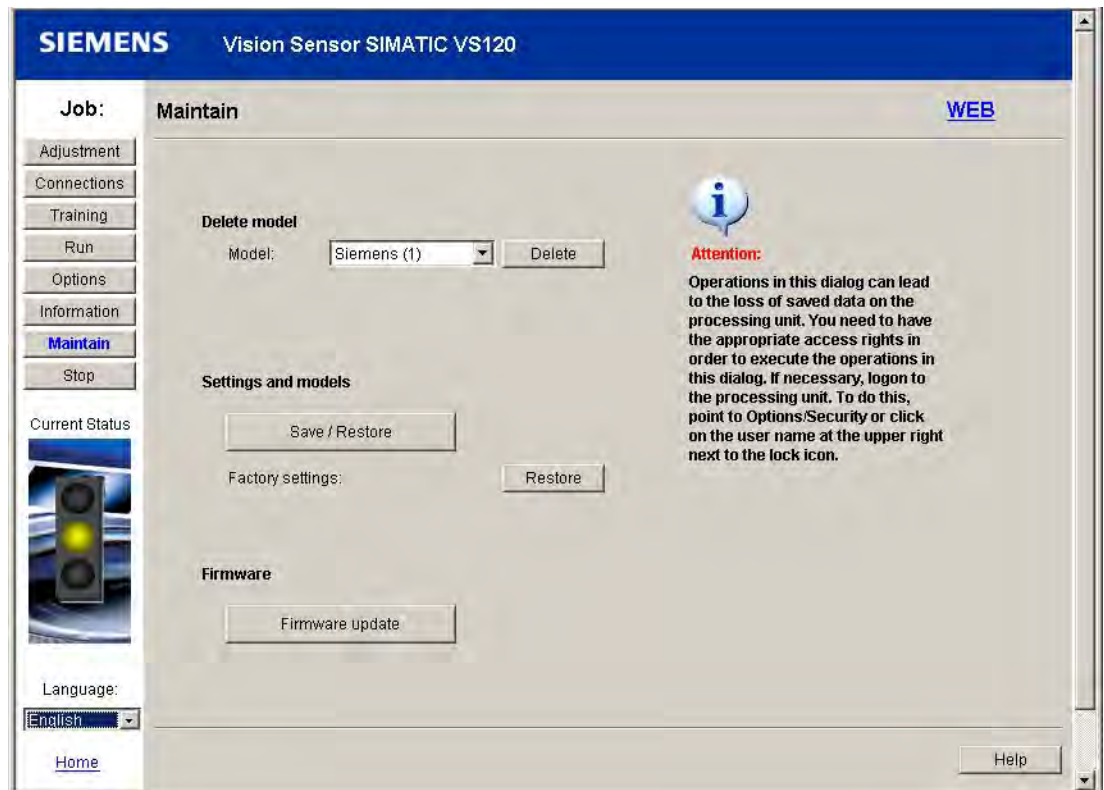

Figure 9-31 Maintain

Note

When you load a model on the processing unit, the parameters saved with the model are also loaded and therefore valid.

Firmware

The "Firmware update" button opens a Web page where you can update the firmware.

Note

If you control the SIMATIC VS120 from an automation system, make sure that the DISA bit is not set during the firmware update. This prevents a programmable controller from changing the VS120 processing unit to RUN.

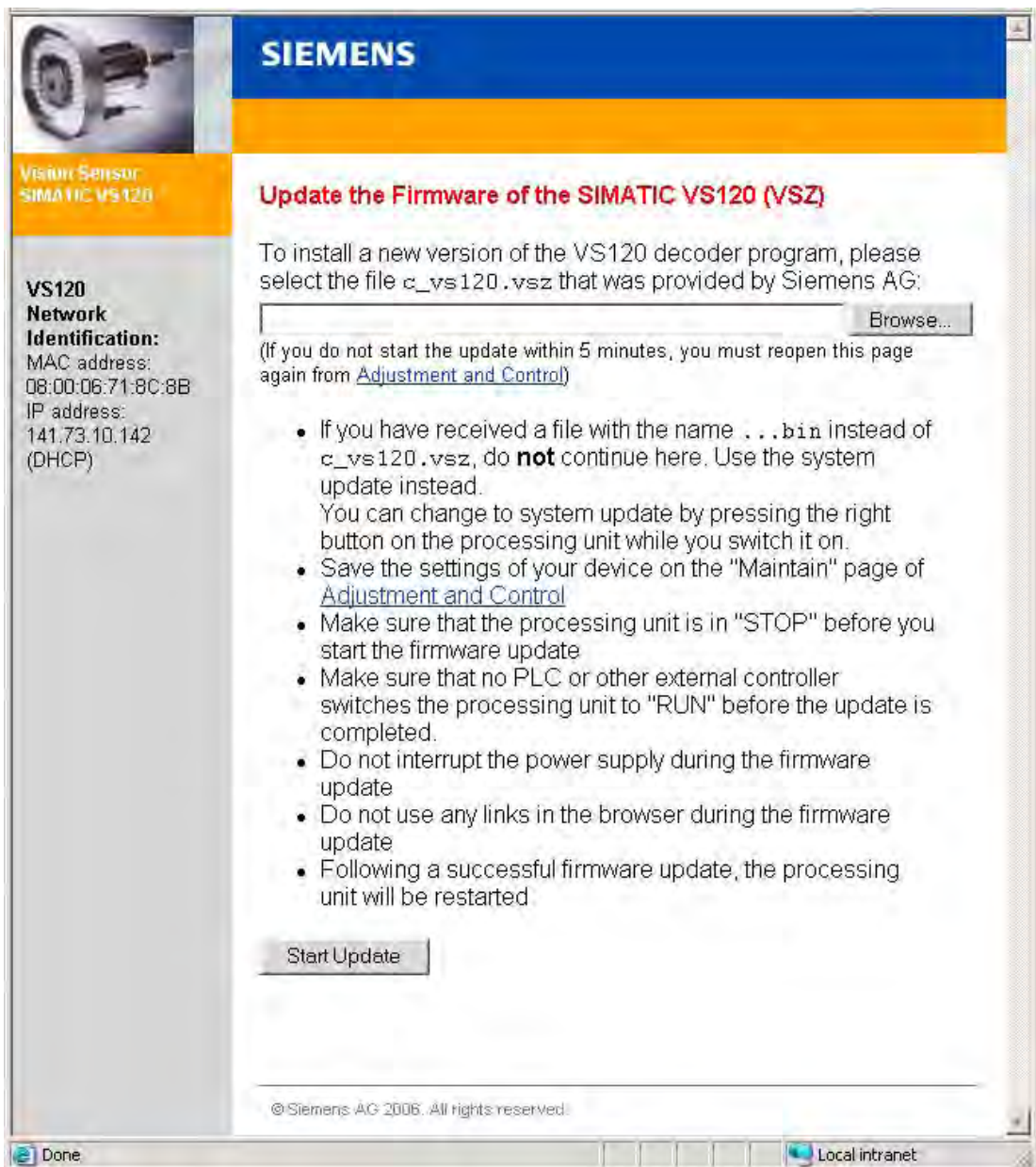

Figure 9-32 Updating the firmware of the SIMATIC VS120

9.3.9 Stop

When you call this dialog, you change the VS120 processing unit to STOP mode.

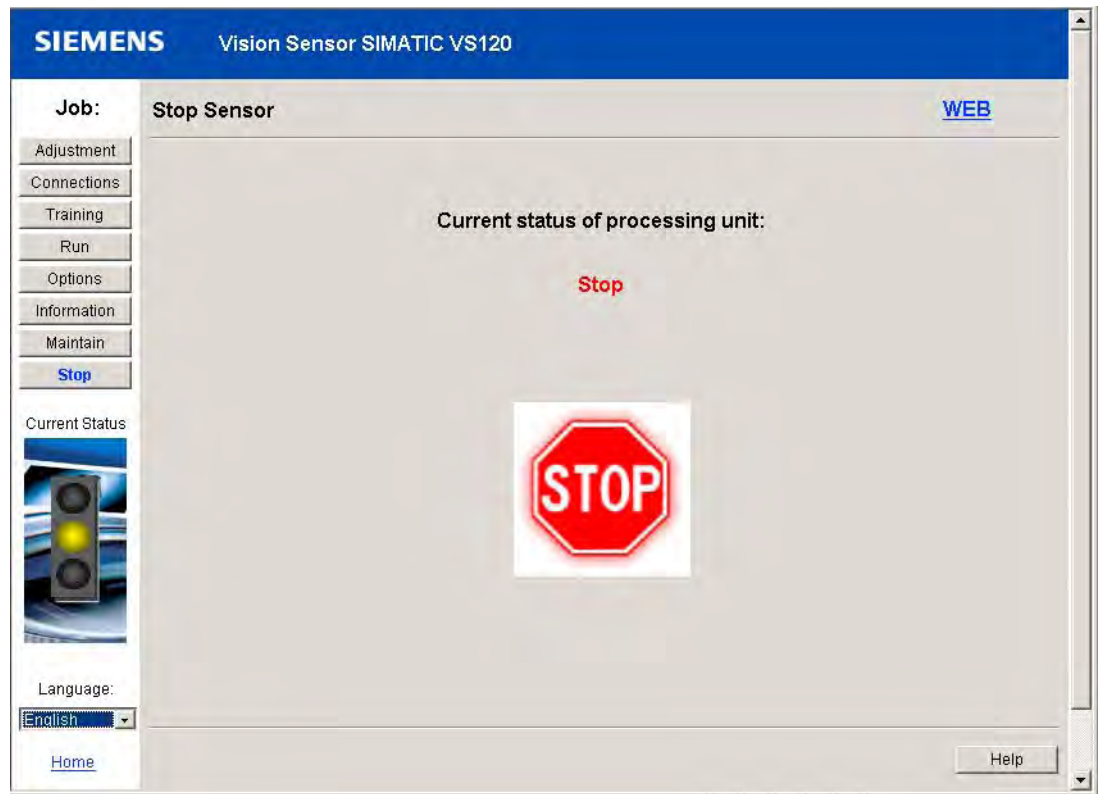

Figure 9-33 Stop

Process interfacing over an automation system (PLC, PC)

10

10.1 Integrating the PROFIBUS DP slave SIMATIC VS120 in HW Config

Installing the GSD file (device master file)

The supplied GSD file **SI0180ED.GSD** contains the properties of the PROFIBUS DP slave SIMATIC VS120.

If necessary, the file can be downloaded from the Internet at:
<http://support.automation.siemens.com>

Module catalog of HW Config

Notice

If you have a STEP 7 version earlier than V5.3 SP1, the SIMATIC VS120 Vision Sensor is not yet included in the module catalog of HW Config. You will first need to add the GSD file of the SIMATIC VS120 Vision Sensor with **Extras > Install GSD Files....** The corresponding graphics file **VS1X0__N.DIB** must also be in the same directory as the GSD file.

The SIMATIC VS120 Vision Sensor appears in the module catalog of HW Config (see screenshot below):

- As of STEP 7 V5.3 SP1 in PROFIBUS DP \ Sensors \ VS100 \ VS120
- In STEP 7 earlier than V5.3 SP1 in PROFIBUS DP \ Additional Field Devices \ General \ Machine Vision

Configuration example

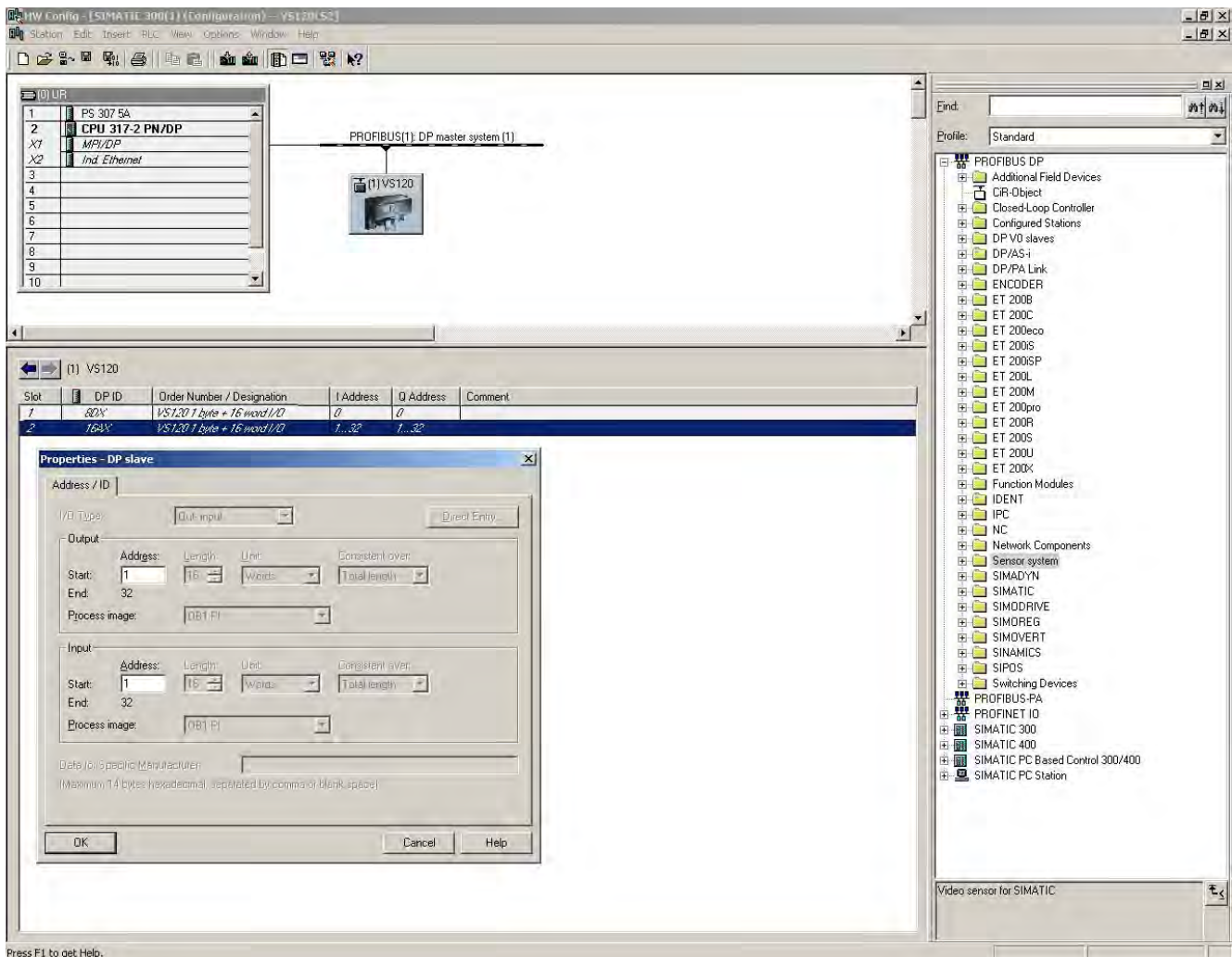

Figure 10-1 Integrating the PROFIBUS DP device SIMATIC VS120 in HW Config

In the configuration example above, the control byte of the SIMATIC VS120 was set to output address 0 and the status byte of the SIMATIC VS120 was set to input address 0 of the CPU (DP master, slot 1). If these addresses are in the process image of OB1 (process image partition "OB1 PI"), you can work here in OB1 with process image access (for example "A I0.6" or "S Q0.1"). If this is not the case, you must work with direct I/O access (for example "L PIB 0").

In the configuration example above, the start of the 16 word long consistent communication area of the SIMATIC VS120 Vision Sensor was set to input address 1 and output address 1 (slot 2).

If these addresses are in the process image of OB1 (process image partition "OB1-PI"), you can work in OB1 with process image access (for example "L IW 2", "T QB 1") without violating the consistency.

This applies only to CPUs that transfer consistent user data using the process image. If, on the other hand, these addresses are not in the process image of OB1, you will need to access the communication area of the SIMATIC VS120 using SFCs 14 "DPRD_DAT" and 15 "DPWR_DAT" to ensure consistency.

Notice

The consistent user data transfer per process image is supported by the following S7 CPUs:

- from the CPU 318 and S7-400 CPUs as of firmware version V3.0.0
- from all S7-300 CPUs with MMC

for all other S7-300 and S7-400 CPUs, installation of SFCs 14 "DPRD_DAT" and 15 "DPWR_DAT" is absolutely necessary.

Transmission rate of PROFIBUS DP

The SIMATIC VS120 Vision Sensor automatically detects the transmission rates of PROFIBUS DP. Even if the transmission rate has changed, this is detected automatically. The following values possible:

- 9.6 Kbps
- 19.2 Kbps
- 45.45 Kbps
- 93.75 Kbps
- 187.5 Kbps
- 500 Kbps
- 1.5 Mbps
- 3 Mbps
- 6 Mbps
- 12 Mbps

PROFIBUS DP address of the SIMATIC VS120 processing unit

The PROFIBUS DP address of the SIMATIC VS120 processing unit is set in the menu **Settings > Ports > DP Addr.** of the processing unit. Possible values are 1 to 125.

10.2 Integrating the PROFINET IO device SIMATIC VS120 in HW Config

Installing the GSD file (device master file)

The supplied GSD file **GSDML-V2.0-Siemens-002A-VS100-20060208.xml** contains the properties of the PROFINET IO device SIMATIC VS120.

If necessary, the file can be downloaded from the Internet at:
<http://support.automation.siemens.com>

Module catalog of HW Config

Notice

If you have a STEP 7 version earlier than V5.4, the SIMATIC VS120 Vision Sensor is not yet included in the module catalog of HW Config. You will first need to add the GSD file of the SIMATIC VS120 Vision Sensor with **Extras > Install GSD Files....** The corresponding graphics file **VS100.bmp** must also be in the same directory as the GSD file.

The SIMATIC VS120 Vision Sensor appears in the module catalog of HW Config (see screenshot below):

- As of STEP 7 V5.4 in PROFINET IO \ Sensors \ VS100 \ VS120

Configuration example

Note

When installing a CPU 317-2 PN/DP, you have to select "Transmission medium/duplex" "Automatic settings" in the individual network in the Properties window of the PROFINET I/O system (slot X2) on the "Options" tab.

Caution

SIMATIC VS120 Vision Sensor does not support an update time less than 4 ms and cannot be set to lower update times. If you configure with STEP 7 V5.3 + SP1, the minimum update time for all PROFINET IO devices of the affected PROFINET system changes to 4 ms.

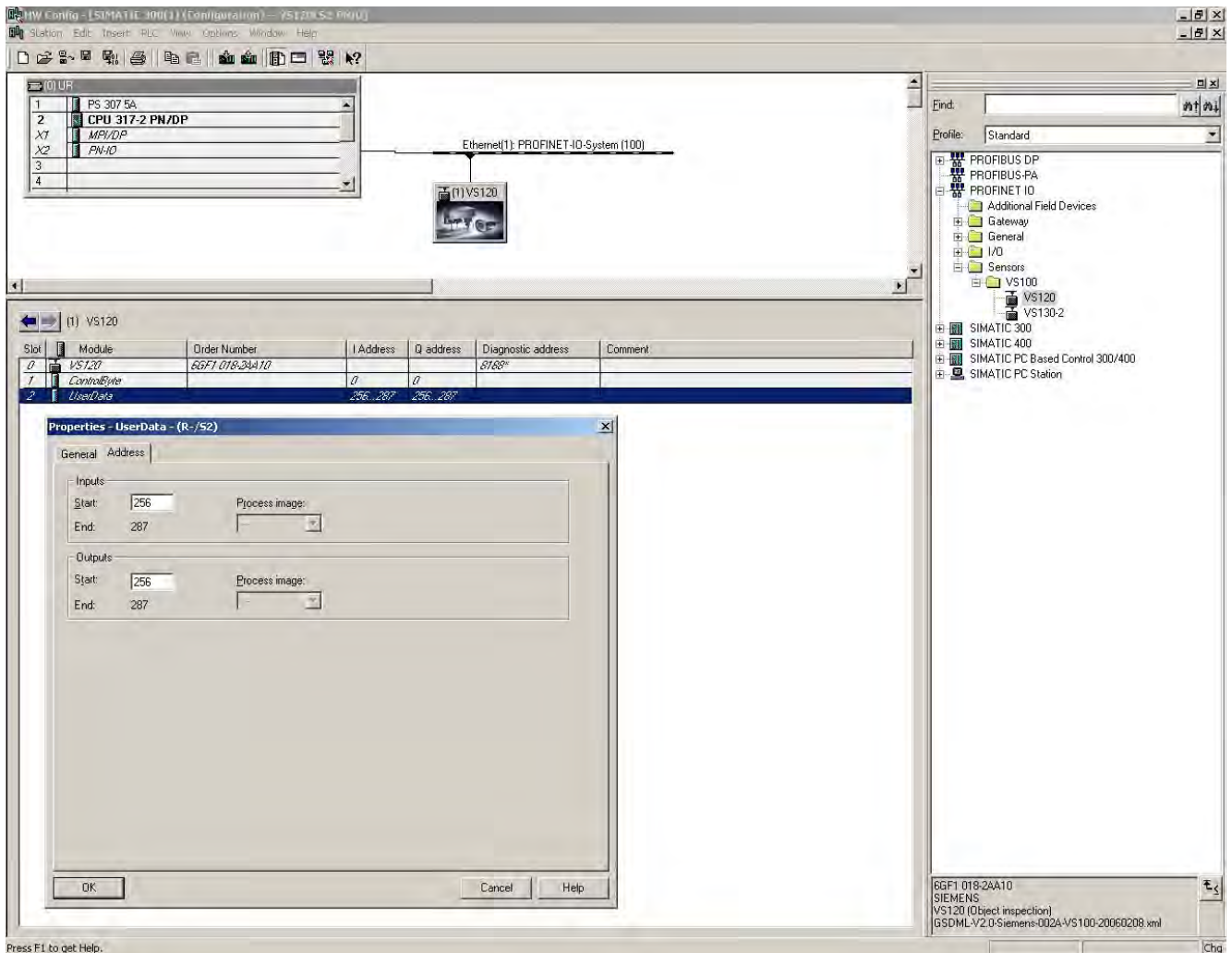

Figure 10-2 Integrating the PROFINET IO device SIMATIC VS120 in HW Config

In the configuration example above, the start of the 16 word long consistent communication area of the SIMATIC VS120 Vision Sensor was set to input address 256 and output address 256 (slot 2). If these addresses are in the process image of OB1 (process image partition "OB1-PI"), you can work in OB1 with process image access (for example "LIW 2", "TQB 1") without violating the consistency. This applies only to CPUs that transfer consistent user data using the process image, refer to the safety notice below.

If, on the other hand, these addresses are not in the process image of OB1, you will need to access the communication area of the SIMATIC VS120 using SFCs 14 "DPRD_DAT" and 15 "DPWR_DAT" to ensure consistency.

Notice

The consistent user data transfer per process image is supported by the following S7 CPUs:

- from the CPU 318 and S7-400 CPUs as of firmware version V3.0.0
- from all S7-300 CPUs with MMC

for all other S7-300 and S7-400 CPUs, installation of SFCs 14 "DPRD_DAT" and 15 "DPWR_DAT" is absolutely necessary.

Transmission rate of PROFINET IO

The SIMATIC VS120 Vision Sensor automatically detects the transmission rates of PROFINET IO. PROFINET IO is operated in 100 Mbps full duplex mode.

Assigning the device name

Follow the procedures below when entering the device name for the SIMATIC VS120 processing unit:

1. In HW Config, open the properties window of the SIMATIC VS120 Vision Sensor and enter the device name there. When you are done, save and compile the hardware configuration.
2. Inform the SIMATIC VS120 processing unit of the device name you just specified. This is possible in three ways:
 - In HW Config, select **PLC > Ethernet > Edit Ethernet Node...** and click the "Browse" button. Following this, all the devices connected to the PNIO system will be displayed (Caution: SIMATIC VS120 must be in "PNIO" IP mode otherwise it is not displayed!). Select SIMATIC VS120 by its MAC address and identify it if needed with the "Flash" button. If the identification is successfully, the "LINK" LED on the Ethernet connector of the SIMATIC VS120 flashes. Enter the device name and confirm it by clicking on the "Assign Name" button.
 - Enter the device name directly in the SIMATIC VS120 processing unit with the menu command **Connect > Ports > PNIO > DevName**).
 - Assign and transfer the device name using the adjustment support: **Connections - Ports tab > PROFINET IO area > Device name parameter**

10.3 Control over the "DI/DO" I/O interface

You will find the connector pin assignment of the I/O interface in the section *Technical specifications* in *Port assignment of the processing unit*.

Control byte

Bit no.	Signal	Function
0	DISA	Disable: Disable manual keypad input, model selection via digital I/O
1	SEL0	Select 0: Model selection bit 0
2	SEL1	Select 1: Model selection bit 1
3	SEL2	Select 2: Model selection bit 2
4	SEL3	Select 3: Model selection bit 3
5	-	Not assigned
6	TRG	Trigger: Image recording and start of processing
7	RES	Reset: Reset error on positive-going edge

Note

- The SEL0, SEL1, SEL2, and SEL3 signals are effective only when DISA=1.
- The RES signal (bit no. 7) is effective regardless of the DISA signal (bit no. 0).

Status byte

Bit no.	Signal	Function	LEDs
0	IN_OP	In operation: <ul style="list-style-type: none"> • 0 = error message is displayed • 1 = SIMATIC VS120 functional, no errors 	Group error <ul style="list-style-type: none"> • SF on • SF off
1	TRD	Trained: <ul style="list-style-type: none"> • 0 = Model/model set cannot be run • 1 = Model/model set can be run 	TRAINED
2	RDY	Ready: <ul style="list-style-type: none"> • 0 = Device startup or SIMATIC VS120 in Stop • 1 = SIMATIC VS120 in processing mode (Run) 	READY
3	OK	Model was recognized: <ul style="list-style-type: none"> • 1 = OK during debounce pulse time 	OK
4	-	Not assigned	-
5	N_OK	Model was not recognized 1 = N_OK during debounce pulse time	N_OK

Model selection

To select a model, apply the appropriate bit pattern to the inputs SEL0 to SEL3. You can select models 1 to 15. If all the inputs of "Select" are set to 0, the last selected model is retained.

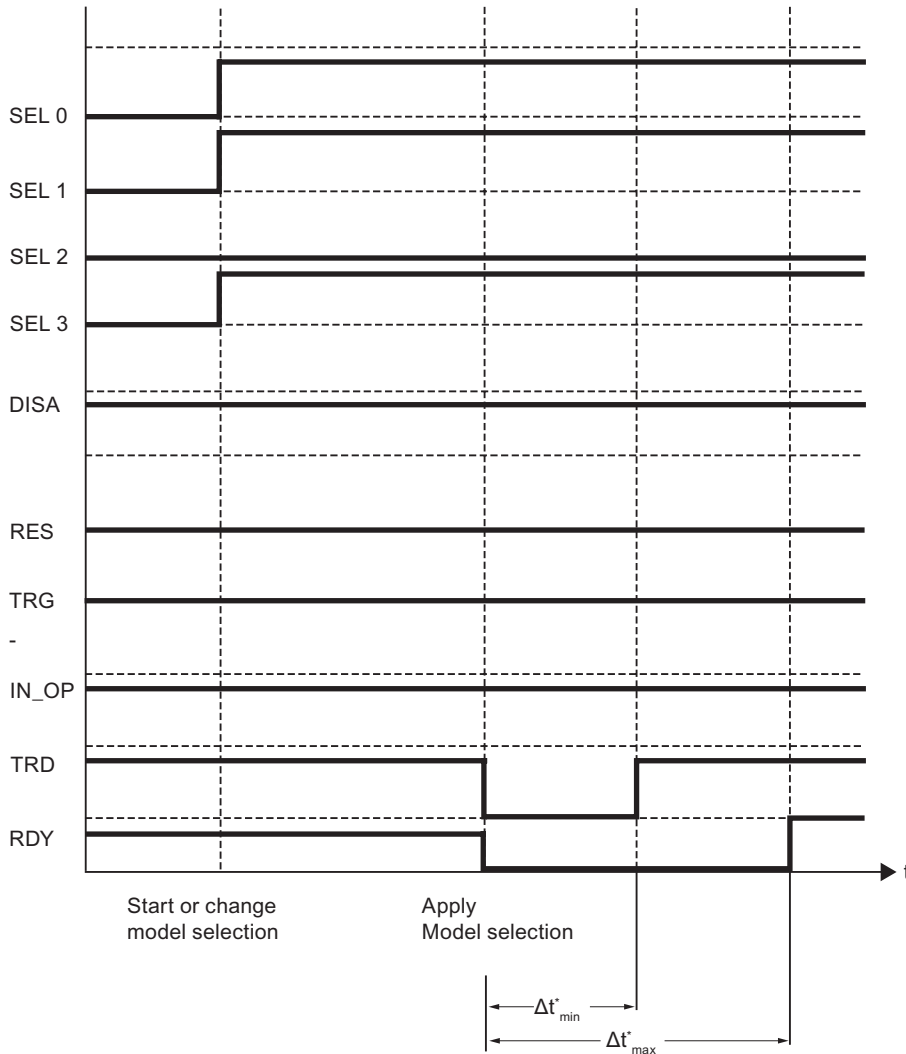

Figure 10-3 Model selection

Legend:

^{*)} Δt of the model at, for example, $\Delta t_{min} = 150$ ms (regardless of model/model set) and $\Delta t_{max} =$ depending on model/model set. This process may take a few minutes.

Note

Only 15 models can be selected. If there is a larger number of models, the selection must be made using model sets.

Creating a bit pattern

Step	Input	Output	Description
1	DISA=1 TRG=0 RES=0		Preparing for model selection and model sets DISA must have the value 1. No edge change is required, however.
2	SEL0=1 SEL1=1 SEL2=0 SEL3=1		Select model/model sets (based on example of model 11)
3		TRD=0 RDY=0	Model switchover starts after max. 150 ms
4		TRD=1 RDY=0	The model selection is confirmed after 150 ms. Model 11 is selected.
5		TRD=1 RDY=1	The model changeover is completed after approximately 150 ms to a few minutes (depending on the model/model set).

Note

If the selected model has not been trained, TRD and RDY retain the value 0.

10.4 Control over PROFIBUS DP and PROFINET IO

10.4.1 Principle of data transfer over PROFIBUS DP and PROFINET IO

The following block diagram shows the relevant interfaces of the SIMATIC VS120 processing unit for data transmission over PROFIBUS DP and PROFINET I/O.

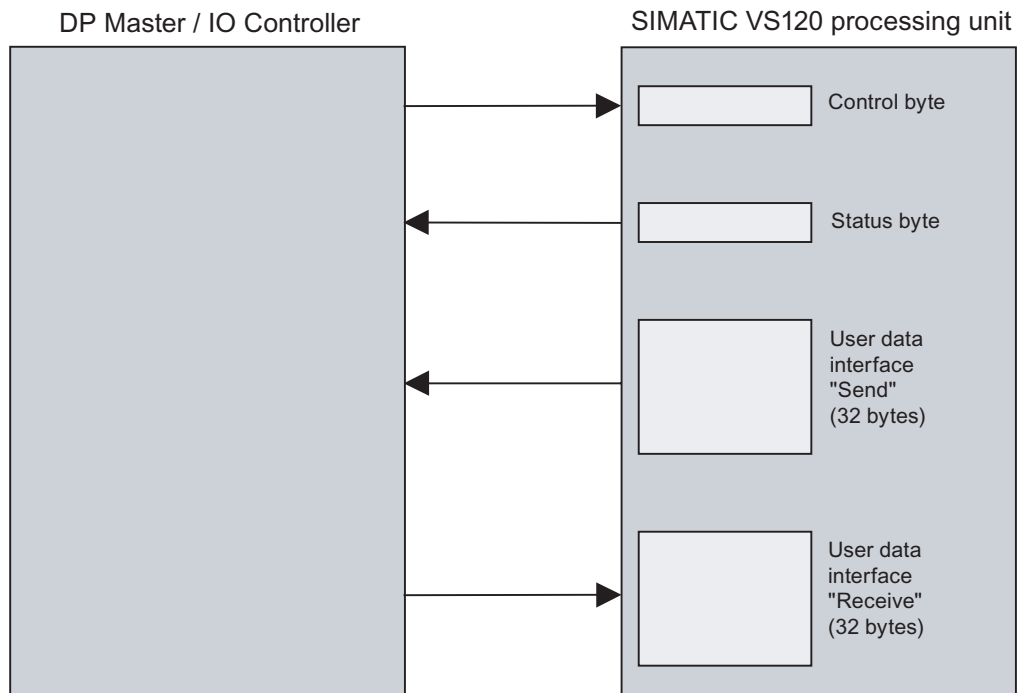

Figure 10-4 Data transfer over PROFIBUS DP and PROFINET IO

Note

Of the "Send" user data interface, bytes 0 to 31 are relevant, of the "Receive" user data interface, only bytes 0 to 9 are relevant.

If these two user data interfaces are not located in the process image of OB1, you must use SFC14 "DPRD_DAT" during the data transfer from the "Send" user data interface of the SIMATIC VS120 processing unit to the PROFIBUS DP master to ensure data consistency. In the opposite direction, SFC15 "DPWR_DAT" must be used for data transmission from the PROFIBUS DP master to the "Receive" user data interface.

10.4.2 Assignments for PROFIBUS DP / PROFINET IO-relevant interfaces for the processing unit

10.4.2.1 Control byte

Bit no.	Signal	Function
0	DISA	Disable: Disable manual keypad input, model selection via PROFIBUS DP / PROFINET IO
1	SEL0	Select 0: Model selection bit 0
2	SEL1	Select 1: Model selection bit 1
3	SEL2	Select 2: Model selection bit 2
4	SEL3	Select 3: Model selection bit 3
5	-	Not assigned
6	TRG	Trigger: Image recording and start of processing
7	RES	Reset: Reset error on positive-going edge

Note

The TRG and RES signals (bits no.6 and 7) are effective regardless of the DISA signal (bit no. 0).

10.4.2.2 Status byte

Bit no.	Signal	Function
0	IN_OP	In operation: 0 = SIMATIC VS120 starting up or error message is displayed. 1 = SIMATIC VS120 functional, no errors
1	TRD	Trained: • 0 = Model/model set cannot be run. • 1 = Model/model set can be run.
2	RDY	Ready: • 0 = Device startup or SIMATIC VS120 in Stop • 1 = SIMATIC VS120 in processing mode (Run)
3	OK	Object was recognized • 1 = OK during debounce pulse time
4	-	Not assigned
5	N_OK	Object was not recognized 1 = N_OK during debounce pulse time
6	-	Reserved
7	-	Reserved

Note

The control byte is written and then read and evaluated in much the same way as shown in the timing diagram in the section *Control over the I/O interface "DI / DO"*.

10.4.2.3 User data interface "Send" VS120 processing unit >>> automation system

Byte no.	Data type	Meaning
0	BYTE	Reserved
1	BYTE	Consecutive number of the data packet to be sent to the PROFIBUS DP master
2 + 3	WORD	Net total length of the data to be transmitted in bytes in STEP 7 format
4	BYTE	Reserved
5	Byte	1. User data byte
...
31.	Byte	27. User data byte

User data structure

User data byte	Data type	Meaning
User data block 1		
1	BYTE	Total warning ^{*)} <ul style="list-style-type: none"> • 0 = Warning limit exceeded • 1 = Below warning limit
2	BYTE	Total result ^{*)} <ul style="list-style-type: none"> • 0 = N_OK • 1 = OK.
3	BYTE	Total quality value (relates to the total result with main ROI and all sub-ROIs).
4 to 7	REAL	Main ROI: x position
8 to 11	REAL	Main ROI: y position
12 to 15	REAL	Main ROI: Angle
16	BYTE	Model number: Processed model of the selected model set.
17	BYTE	Main ROI quality
18	BYTE	Number of sub-ROIs: n
19	BYTE	Reserved
20 + 21	WORD	Reserved
22	BYTE	1. Sub-ROI: <ul style="list-style-type: none"> • 0 = N_OK • 1 =OK • 3 = Below warning limit
23	BYTE	1. Sub-ROI quality values as percentage
24 to 27	REAL	1. Sub-ROI x position
User data block 2		
28 to 31	REAL	1. Sub-ROI y position
32 to 35	REAL	1. Sub-ROI angle
....
22 + n × 14	BYTE	nth sub-ROI results: <ul style="list-style-type: none"> • 0 = N_OK • 1 =OK • 3 = Below warning limit
23 + n × 14	BYTE	nth sub-ROI quality values as percentage
24 + n × 14 to 27 + n × 14	REAL	nth sub-ROI x position
28 + n × 14 to 31 + n × 14	REAL	nth sub-ROI y position
32 + n × 14 to 35 + n × 14	REAL	nth sub-ROI angle

^{*)} Value relates to the total result with main ROI and all sub-ROIs

10.4.2.4 User data interface "Receive" automation system >>> VS120 processing unit

Byte no.	Data type	Meaning
0	BYTE	Reserved
1	BYTE	Consecutive number of the data packet received from the DP master
2	BYTE	Reserved
3	BYTE	Reserved
4	BYTE	Reserved
5	BYTE	Reserved
6 to 9	DINT	Delay time for hardware trigger delay ^{*)}
10 to 31	BYTE	Reserved

^{*)} Delay time is the delay of the trigger signal by the specified time.

10.4.3 Programming data fragmentation

Note

You require a handshake procedure if you use a controller with a S7-CPU and the FB1 function block.

Handshaking

The following section introduces the handshake mechanism that ensures the consistency of all the data sent from the processing unit to the PROFIBUS DP master or PROFINET I/O controller regardless of any configured PROFIBUS DP or PROFINET IO consistency mechanisms. This mechanism must be used with every transfer, even if only one block of data is transferred.

Note

With handshakes, the data transfer must be constant at 32 bytes (inputs and outputs).

Procedure

Step	Activity in the user program of the DP master or I/O controller
1	Poll byte 1 of the "Send" user data interface. As long as this byte has the value 0, there is no new data. If it has the value 1, go to step 2.
2	The value 1 in byte 1 of the "Send" user data interface means: The SIMATIC VS120 has started data transmission. Read the net total length of the data to be transferred from bytes 2 and 3 of the "Send" user data interface and the user data of the first data packet from bytes 5 to 31.
3	Acknowledge correct receipt of the first data packet by writing the value 1 in byte 1 of the "Receive" user data interface. The processing unit polls byte 1 of the "Receive" user data interface. As soon as it reads the value 1, it fills bytes 5 to 31 of the "Send" user data interface with the user data of the second data packet and enters the number of this data package (in this case 2) in byte 1.
4	Poll byte 1 of the "Send" user data interface. As long as this still contains the number of the previously transferred data packet (1), there is no new data. As soon as byte 1 has the value 2 (number of the next data packet), go to step 5.
5	Read the user data of the second data packet from bytes 5 to 31.
6	Acknowledge correct receipt of the second data packet by writing the value 2 in byte 1 of the "Receive" user data interface.
...	...
Last - 4	Poll byte 1 of the "Send" user data interface. As long as this contains the number of the last but one data packet, the data of the last data packet is not yet available. As soon as byte 1 has the number of the last data packet, go to next step.
Last - 3	Read the user data of the last data packet from bytes 5 to 31.
Last - 2	Acknowledge receipt of the last data packet by writing the number of the last data packet in byte 1 of the "Receive" user data interface. The processing unit polls byte 1 of the "Receive" user data interface. As soon as it reads the number of the last data packet, it writes the value 0 to bytes 2 and 3 of the user data interface and also to byte 1. The value 0 in byte 1 signals the end of the current data transfer to the PROFINET DP master.
Last - 1	Poll byte 1 of the "Send" user data interface. As soon as the value 0 is read, go to last step.
Last	Acknowledge correct receipt of all data by writing the value 0 in byte 1 of the "Receive" user data interface.

Response to problems, timeouts, and errors

The processing unit monitors the following:

- The time between the arrival of two acknowledgments from the DP master is monitored for the time-out set in the Connect > Ports > DP > Timeout or Connect > Ports > PNIO > Timeout menu.
- The correct sequence of the acknowledged data packets of the DP master or I/O controller is monitored.

If an error occurs, the processing unit enters B#16#FF in byte 1 of the "Send" user data interface and so aborts the current data transmission.

If an error occurs, writing B#16#FF to byte 1 of the "Receive" user data interface causes the current data transmission to be aborted.

10.5 Function block FB1

To simplify operation of the functions of SIMATIC VS120 Vision Sensor, there is a function block FB1 for IO operations.

In addition to the SIMATIC S7 system mechanisms for the integration of SIMATIC VS120 Vision Sensor in a PROFIBUS DP or PROFINET IO environment, FB1 simplifies the software integration in control programs.

10.5.1 Job

Tasks of the function block FB1

- Selecting a model or model set
- Reading the result data and entering it in DB10 (DB10 is included in the documentation package)
- Operating the control and status interface (triggers, results bits,...)
- Transferring the delay time of the trigger
- Outputting error messages

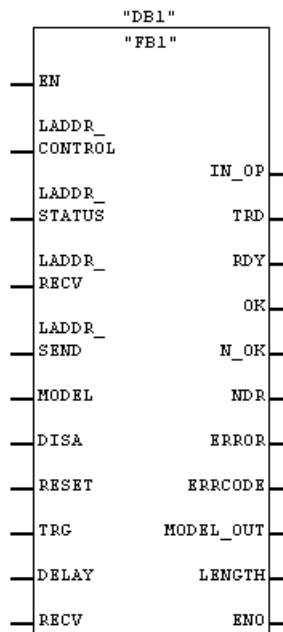

Figure 10-5 Function block FB1

Tasks of data block DB10

DB10 is designed for the structured entry/storage of data from a main ROI and a maximum of 16 sub-ROIs. The number of sub-ROIs is set in Connections - Output tab in adjustment support

10.5.2 Parameter

Parameters	Declaration	Data type	Description
LADDR_CONTROL	INPUT	INT	Address of the control byte of the SIMATIC VS120 interface entered in Connection Controller. This parameter must be interconnected!
LADDR_STATUS	INPUT	INT	Address of the status byte of the SIMATIC VS120 interface entered in Connection Controller.
LADDR_RECV	INPUT	INT	Start address of the "Send" user data interface of the SIMATIC VS120 / "Receive" of the PLC.
LADDR_SEND	INPUT	INT	Start address of the "Receive" user data interface of the SIMATIC VS120 / "Send" of the PLC.
MODEL	INPUT	BYTE	Model number ± 1 to ± 15 Note: The DISA bit must be set in order to change models.
DISA	INPUT	BOOL	Disable: Disable manual keypad operation
RESET	INPUT	BOOL	Reset: Reset processing unit error or FB error. Note: Not dependent on the DISA bit.
TRG	INPUT	BOOL	Trigger: Image recording and start of processing
DELAY	INPUT	DINT	Delay time: Transfer of the trigger delay time to the SIMATIC VS120 in μs . (value range 0 - 9.999.999 μs). Note: The delay value is a multiple of 50 μs , with rounding limit of 0 or 50 μs . For example, 49 μs become 0 μs . 65 μs becomes 50 μs
RECV	INPUT	ANY	Receive: Receive range for the result values Only the data block area and the BYTE data type are allowed. These parameters must be interconnected and the data block must be at least as large as the maximum expected result.
IN_OP	OUTPUT	BOOL	In operation: <ul style="list-style-type: none"> 0 = error message is displayed 1 = SIMATIC VS120 functional, no errors
TRD	OUTPUT	BOOL	Trained: <ul style="list-style-type: none"> 0 = Model/model set cannot be run 1 = Model/model set can be run
RDY	OUTPUT	BOOL	Ready: <ul style="list-style-type: none"> 0 = Device startup or SIMATIC VS120 in Stop 1 = SIMATIC VS120 in processing mode (Run)
OK	OUTPUT	BOOL	Object was recognized 1 = OK during debounce pulse time
N_OK	OUTPUT	BOOL	Object was not recognized 1 = N_OK during debounce pulse time

Parameters	Decla- ration	Data type	Description
NDR	OUTPUT	BOOL	New Data Received: Receive new data Note: This parameter is available for only one CPU cycle.
ERROR	OUTPUT	BOOL	An error has occurred.
ERRCODE	OUTPUT	WORD	The system outputs a return value with error code if an error occurs while it executes the function: <ul style="list-style-type: none"> • W#16#0000: No error • W#16#1xyz: FB1 internal fault • W#16#2xyz: Processing unit error • W#16#8xyz: Error messages of internal SFCs
MODEL_OUT	OUTPUT	BYTE	Number of the currently selected model
LENGTH	OUTPUT	INT	Length of the result in bytes

10.5.3 Operator control

Model selection

- The DISA bit must be set to 1 in order to select a model.
- The desire model number is set at the FB1 MODEL input.
- The model change is completed when the TRD and RDY bits change from FALSE to TRUE. In this case, the applied model number is applied to the MODEL_OUT output.
- As long as no model has been transferred, the value 0 is output at the MODEL_OUT output.
- The MODEL_OUT output changes to 0 as soon as the DISA bit is reset.
- If MODEL = 0, the last selected model is retained. 0 is output at the MODEL_OUT output.

Reset

- When errors are reset, the SIMATIC VS120 module errors (IN_OP = 0) and the FB1 transmission errors are reset.

Triggering

- Image processing with the SIMATIC VS120 can be triggered with the trigger input at FB1.
- In mixed operation "control over PROFIBUS DP and triggering over DI/DO", the trigger signal can be connected directly to the VS120 processing unit. In this case, the TRG FB1 parameter remains free.

Transferring the delay time

- The time value for hardware trigger delay is set at the FB1 DELAY parameter. With the Delay time parameter, you can specify the value for hardware-based triggering.

Reading and transferring result data

- FB1 is always ready to receive.
- Following an OK or N_OK evaluation, the result data is output
- The data are valid if the NDR bit changes from 0 to 1.
- The number of sub-ROIs to be transferred is set in the "Connections - Output tab" of the adjustment support.

10.5.4 Error information

If an error occurred, ERROR is set to 1. The precise cause of the error is then displayed in ERRCODE.

Error Information

- 0000: No error
- 1xyz: FB1 internal fault
- 2xyz: Processing unit error
- 8xyz: Error messages of internal SFCs

ERRCODE

ERRCODE (W#16#)	ERROR	Explanation
0000	0	No error
1001	1	Illegal model number (Model parameter) Values 1 to 15 are permissible.
1002	1	Receive area not permitted. Only the BYTE data type is allowed.
1003	1	Data area not permitted. Only data blocks are permitted.
1004	1	The receive area does not exist (data block does not exist).
1005	1	The receive area is too short.
1006	1	The receive area is write-protected.
1007	1	The delay value is outside the permitted range of 0 to 9,999,999 µs.
2001	1	The selected model number has not been trained.
80xx	1	Transfer of SFC14 and SFC15 error messages.
8090	1	You have not configured any module for the logical base address specified.
80A0	1	The system has detected an IO access error.
80C0	1	System error at external PROFIBUS DP interface.

Module fault

The VS120 module fault (IN_OP=0) is not applied to the ERROR group error bit since when turning on and off, it is not possible to determine whether the controller is starting up or is in a fault status.

Note

It is recommended to always evaluate the IN_OP bit.

10.6 Sample programs

We have written the following example programs for you:

- Example 1: Program for interfacing the SIMATIC VS120 processing unit with a SIMATIC controller using FB1
- Example 2: Program for archiving diagnostic information on a PC/PG

10.6.1 Example 1: Program for interfacing the SIMATIC VS120 processing unit with a SIMATIC controller using FB1

Note

The program described here is also available on the documentation CD of the documentation package in Examples\SIMATIC.

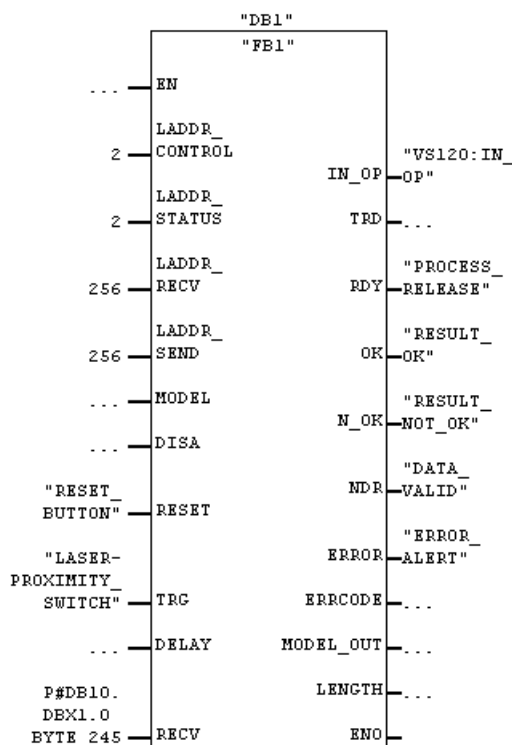

Figure 10-6 Example program FB1

Legend:

Parameters used	Parameters of FB1	Meaning
RESET_BUTTON	RESET	Reset button to acknowledge errors
LASER- PROXIMITY_SWITCH	TRG	Light barrier for triggering
P#DB10. DBX1.0 BYTE 245	RECV	Receive range for the result values
VS120:IN_OP	IN_OP	SIMATIC VS120 functional, no errors
PROCESS_RELEASE	RDY	SIMATIC VS120 in processing mode (Run)
RESULT_OK	OK	Model was recognized
RESULT_NOT_OK	N_OK	Object was not recognized
DATA_VALID	NDR	Receive new data
ERROR_ALERT	ERROR	An error has occurred.

Including FB1 in a STEP 7 program

In the supplied STEP 7 program, the FC1 function contains an example for outputting the result data.

Process interfacing

The SIMATIC VS120 processing unit is connected over PROFIBUS DP or PROFINET IO to a programmable controller. If a photoelectric barrier or a proximity switch is used for triggering, the trigger signals must be read by a digital input module. The received data is stored in data block DB10 in bytes 1 to 245.

10.6.2 Example 2: Program for archiving diagnostic information on a PC/PG

Note

The program described here is also available on the documentation CD of the documentation package in Examples\Diagnostics.

With the "archivedemo.exe" example, you can archive diagnostic data records in the form of csv files (can be read, for example, with Excel) and diagnostic images as bitmaps on a PC. In addition to the diagnostic images, a text file is transferred that contains details of the image.

Process interfacing

The PC / PG is connected to the VS120 processing unit via Ethernet for archiving the records and/or the diagnostic images.

Adjustment support

Make the following settings in adjustment support:

- *Connections - Interfaces tab* dialog:
In "Archive", enter the IP address and the port of the PC/PG on which you want to archive the diagnostic information.
- *Connections - Integration tab* dialog:
In "Diagnostic transfer", select what you want to archive.
Only diagnostic data records, only diagnostic images or both

Example program

- Under "Connection", set the IP configuration of the Ethernet interface of your PC through which you want to communication with the VS120 processing unit. The settings must be identical to the values that you have set on the VS120 processing unit under "Connections - Interfaces tab" - Archive or with **Connect ->Ports - > Archive**.
- Enter the maximum size of a csv file in "Options". If the current csv file exceeds this size, the example program creates a new csv file. In the "Timeout" input box, you can also specify the time in seconds after which the example program stops itself if it has not received a response from the VS120 processing unit during this time. This allows you to check whether the connection to the VS120 processing unit is still established
- In "Output", you specify the folders in which the diagnostic images and the csv files will be stored.
- Once you have clicked the "Start" button, the program waits for the connection to be established by the VS120 processing unit. The transfer of the diagnostic data begins after the connection has been established.
- The file names have the following structure:
 - csv files: diagrecs_<date>_<time>.csv
 - Bitmaps: diagimg_<date>_<time>.bmp
 - Details of the image: diagimg_<date>_<time>.txt

Alarm, error and system messages

11.1 Overview

With certain operator input and if an error occurs in the processing, the SIMATIC VS120 provides you with diagnostic information. This is achieved as follows:

- Information on error diagnostics and error messages of the processing unit and setup support
- Information on warnings and instructions on the LCD display of the processing unit
- Diagnostics messages based on the "BF" LED
- Diagnostic messages for PROFIBUS DP and PROFINET IO

11.2 Error messages and error handling

Error messages

When error messages are generated, the "IN_OP" signal (in operation) is reset and the SF LED (group error) is lit.

With the exception of the error messages PROFIBUS DP error and PROFINET IO error, you must acknowledge all errors that occur by setting the RES bit of the control byte.

If the SIMATIC VS120 is connected to PROFIBUS DP or PROFINET IO, all error messages trigger a diagnostic interrupt on the respective DP master or I/O controller, for which there is a number in the "PROFIBUS DP bit no. starting at diagnostic byte 0 (DP)" or "PROFINET IO Value" column in the following table. How the diagnostic information is read from the SIMATIC VS120 and evaluated is explained in the section *Slave Diagnostics or IO Diagnostics*.

No.	Message on the LCD display	PROFIBUS DP bit no. starting at diagnostic byte 0	PROFINET IO Value	Description	Remedies
1	Invalid sensor	0	W#16# 5000	The connected sensor head is not supported.	Connect a sensor supported by SIMATIC VS120.
2	Sensor not found	1	W#16# 5001	No sensor head connected.	Connect the sensor to the processing unit correctly.

11.2 Error messages and error handling

No.	Message on the LCD display	PROFIBUS DP bit no. starting at diagnostic byte 0	PROFINET IO Value	Description	Remedies
3	Model corrupt	5	W#16# 5005	The model could not be recreated.	Run the training again.
4	Internal file error	5	W#16# 5005	An error occurred when saving to the read-only memory.	Contact Customer Support if this error occurs often.
5	TCP/RS232 Trm. Error	7	W#16# 5007	The send buffer is full because the data cannot be sent in an adequately short time,	Reduce the trigger frequency or process the results more quickly on the server. A high load on the network to which the processing unit is connected can also block the transfer of the data. If necessary, check the network connection.
6	Archive Trm. Error	7	W#16# 5007	The send buffer is full because the data cannot be sent in an adequately short time or the server does not confirm receipt of the data in good time	Reduce the trigger frequency or reduce the amount of diagnostic data to be archived. Process the results on the server faster. A high load on the network to which the processing unit is connected can also block the transfer of the data. If necessary, check the network connection.

No.	Message on the LCD display	PROFIBUS DP bit no. starting at diagnostic byte 0	PROFINET IO Value	Description	Remedies
7	DP/PNIO Trm. Error	7	W#16# 5007	The transfer of the last read result is not yet completed, the next read result is, however, already available, or the DP master or IO controller does not reply within the handshake monitoring time (parameter Connect >Ports >DP >Timeout on processing unit or within the time limit parameter in PROFIBUS DP in Part 1/3: Ports of the Connections dialog in the adjustment support, parameter Connect >Ports >PNIO >Timeout on processing unit or within the time limit parameter in PROFINET IO in Part 1/3: Ports in the "Connections" dialog in the adjustment support).	Reduce the trigger frequency or process the results more quickly. If necessary, change the transmission rate for the DP configuration or the update time for the PROFINET configuration.
8	Invalid DP parameters	8	-	The PROFIBUS DP settings are not correct	Correct the DP settings.
9	PROFIBUS DP Error	13	-	Error in PROFIBUS DP communication.	Make sure that the parameters for communication over PROFIBUS DP and the communication partners are correctly configured and active. Check the connection to the DP master.

11.2 Error messages and error handling

No.	Message on the LCD display	PROFIBUS DP bit no. starting at diagnostic byte 0	PROFINET IO Value	Description	Remedies
10	TCP/RS232 Communic.	14	W#16#500E	Connection error in communication over a TCP connection or when using an Ethernet RS-232 converter: There is no TCP connection or the data transmission cannot be completed within the set time.	Make sure that the connected TCP server or Ethernet RS-232 converter is correctly configured and ready to receive. Depending on the connected Ethernet RS-232 converter, it can take up to 20 s before changes to the RS-232 settings or parameter changes for the trigger source or the output of the result string to "TCP/RS232" take effect. During this time, the first trigger of a processing cycle should not occur nor should that be a change to RUN.
11	Archive Communic.	14	W#16#500E	Error in communication over the archiving connection: There is no TCP connection, the server does not respond within the set time limit or violates the archiving protocol.	Check the connection to the server. Make sure that the data is processed by the server in an adequately short time and that the protocol is maintained.

No.	Message on the LCD display	PROFIBUS DP bit no. starting at diagnostic byte 0	PROFINET IO Value	Description	Remedies
12	Lamp overload	15	W#16#500F	<p>The IR lighting unit is overloaded. Below you will see the maximum trigger frequency f_T for the selected shutter speeds TB:</p> <p>TB = 500 μs with f_T = 60 Hz TB = 1000 μs with f_T = 40 Hz TB = 2000 μs with f_T = 20 Hz TB = 3000 μs with f_T = 13 Hz TB = 4000 μs with f_T = 10 Hz TB = 5000 μs with f_T = 8 Hz TB = 6000 μs with f_T = 7 Hz TB = 7000 μs with f_T = 6 Hz TB = 8000 μs with f_T = 5 Hz TB = 9000 μs with f_T = 4.5 Hz TB = 10000 μs with f_T = 4 Hz</p> <p>Note: Trigger frequencies > 33 Hz are not practicable.</p>	Reduce the trigger frequency or reduce the shutter speed.
13	PROFINET IO Error	-	W#16# 5011	An error occurred in PROFINET IO communication	Make sure that the parameters for communication over PROFINET IO and the communication partners are correctly configured and active. Check the connection to the IO controller.

Occurrence of PROFIBUS DP or PROFINET IO errors

If a "PROFIBUS DP Error" or "PROFINET IO Error" occurs, the processing unit checks during the time the error is displayed if the cause of the error continues to be present.

When the relevant communication is reestablished, the processing unit resets the error display.

In any case, you can acknowledge the error manually (on the processing unit or in the adjustment support) and thereby make changes to the configuration.

The occurrence of these two errors as well as their automatic acknowledgment are permanently saved in the diagnostics records, in other words, the corresponding entries are not overwritten by new errors. They are indicated at the following locations if their number deviates from zero:

- In the Info menu of the VS120 processing unit
- In the adjustment support for the "Processing" job
- In the adjustment support for the "Info" job in the "Statistics" tab

Note

The occurrence of a PROFIBUS DP Error or PROFINET IO Error results in an OB86 call (rack failure) in a SIMATIC S7-CPU.

If you have not programmed OB86, the CPU goes to STOP.

Warnings/instructions as LCD displays on the processing unit

No.	Message	Description	Remedies
1	PROFIBUS Connection failed	When setting Control, OK/N_OK, Output or Trigger on PROFIBUS DP, no connection could be established. The setting is adopted when the message is acknowledged with OK. The settings are not applied if you acknowledge with ESC.	You must correct the PROFIBUS DP parameters or activate the communication partner.
2	Permission denied for ...	The security settings prevent this value being set in the menu of the processing unit.	Set the value over the Web user interface or change the security settings over the Web user interface.
3	Restart to Activate	A device name change on PROFINET IO only becomes active after restarting the processing unit.	Turn the power supply for the processing unit off and on again.
4	TCP/IP Esc:Skip	During the self-test, the system waits for the activation of the TCP/IP connections (if applicable when obtaining the IP address from the DHCP server).	If the message does not disappear automatically after a few seconds, check the network connection. With ESC, you can skip connection establishment (or it continues in the background).

No.	Message	Description	Remedies
5	Archive Esc:Skip	In the self-test, the system waits for the TCP/IP connection to the archiving software to be established.	If the message does not disappear automatically after a few seconds, check the connection to the archiving software. With ESC, you can skip connection establishment (or it continues in the background).
6	TCP/RS232 Esc: Skip	In the self-test no connection to the configured Ethernet RS-232 converter or PC/PG with TCP server can be established (yet).	If the message does not disappear automatically after a few seconds, check the connection to the Ethernet RS-232 server or PC/PG with TCP server. With ESC, you can skip connection establishment (or it continues in the background).
7	PROFIBUS Esc:Skip	During the self-test, it is still not possible to start communication over PROFIBUS DP.	If the message does not disappear automatically after a few seconds, check the connection to the DP master. With ESC, you can skip connection establishment (or it continues in the background).
8	PROFINET Esc:Skip	During the self-test, it is still not possible to start communication over PROFINET.	This message has its origins in the changeover of the IP address during reconfiguration. The message exists until the changeover procedure has ended. If the message does not disappear automatically after a few seconds, check the connection to the IO controller. With ESC, you can skip connection establishment (or it continues in the background).
9	Factory Settings used.	The defaults for all parameters are used, no models have been trained. After the self-test, the processing unit changes immediately to the Adjust mode.	
10	This will cause a restart.	IP mode is changed to PNIO or it is in PNIO and should obtain a different value. The change comes into effect only after a restart of the processing unit. Confirmation with "OK" leads to a restart. If you press "ESC", the change is not applied and no restart occurs.	
11	This will reset DelaySrc	If you change the current parameter, the configured trigger delay source is reset to "manual".	

No.	Message	Description	Remedies
12	Invalid Netmask	You have entered an illegal value in a subnet mask under Ports > Ethernet. The value will not be used.	The subnet mask must have the form xxx.xxx.xxx.xxx with xxx = 0...255, and binary requires that the left part be made up of ones without a gap and the right part be made up of zeros without a gap. In addition, the 0.0.0.0 and 255.255.255.255 masks are not allowed.
13	Must be a DNS-style Name	The entered PROFINET station name does not match the DNS convention.	
14	Hires not supported	You cannot operate a high-resolution sensor with this processing unit.	Use a low resolution sensor.
15	Hardware not supported	You cannot operate this firmware on your processing unit.	Use the system update to install firmware that is valid for your processing unit or use a processing unit with a version that supports this firmware version.
16	Loading model data. Please wait...	When starting processing or when a model (set) is changed, the model data is loaded and preprocessed. This can take several seconds or even minutes depending on the amount of data.	
17	Model not trained	When working with an automation system, a model was selected that has not been trained	Check your model selection. If necessary, retrain the model.
18	Model set incomplete	When working with an automation system, a model set was selected that contains untrained models	Remove the untrained model from the model set or train the missing model.
19	Different precisions	When working with an automation system, a model set was selected that contains models with different precisions.	Based on Information -> Models, check the precision of the models in the set. If necessary, train models
20	Model set too large	When working with an automation system, a model set was selected whose models cannot all be loaded in memory at the same time.	Remove the models from the model set or reduce the number of sub-ROIs in the individual models. Check whether you could work with lower precision.

Error information FB1

See the section *Control over an automation system (PLC, PC) / function block FB1*

Display: Temporary error

"Temporary errors: xx" on the SIMATIC VS120 Vision Sensor indicates that there was a problem on the connection over PROFIBUS DP or PROFINET IO, where "xx" is the number of problems.

Example:

During operation, new project engineering data is transferred to the CPU with HW Config. The CPU then terminates the connection to the slaves and restarts communication with PROFIBUS DP. This is noted on the SIMATIC VS120 Vision Sensor and the error messages are incremented as temporary errors.

If the counter reading for temporary errors increases, this may indicate that the connection with PROFIBUS DP was restarted often or that the slaves had new parameters assigned by the CPU. This symptom indicates that the PROFIBUS DP segments are not working efficiently. It may be necessary for a PROFIBUS DP systems specialist to check the entire system.

11.3 Diagnostics based on the "BF" LED

"BF" LED with PROFIBUS DP

"BF" LED	Meaning if an error occurs	Remedies
ON	SIMATIC VS120 is not in the data exchange phase but is searching for the transmission rate	<ul style="list-style-type: none"> • Check that the bus connector is correctly inserted. • Check that there is no break on the bus cable to the DP master. • If you use an S7 DP master: Check the diagnostic buffer of the DP master or the slave diagnostic information in HW Config.
Flashing	SIMATIC VS120 is neither in the data exchange phase nor searching for the transmission rate	<ul style="list-style-type: none"> • Check the cable lengths relative to the transmission rate. • Check the settings of the terminating resistors. • Check the configuration of the DP master (PROFIBUS address, transmission rate, configuration, bus profile). • If you use an S7 DP master: Check the diagnostic buffer of the DP master or the slave diagnostic information in HW Config.

"BF" LED with PROFINET I/O

"BF" LED	Meaning if an error occurs	Remedies
ON	<ul style="list-style-type: none"> • Bus problem (no physical connection to a subnet/switch) • Wrong transmission rate • Full duplex transmission is not enabled 	Check that the bus connector is correctly inserted.
Flashing	<ul style="list-style-type: none"> • Bus communication via PROFINET IO has been interrupted. • IP address is incorrect. • Bad engineering configuration • Incorrect parameter assignment • Incorrect or missing device name • IO controller not available/switched off but Ethernet connection established 	<p>Check whether the IP address or device name is duplicated on the network.</p> <p>Check the settings of the IO controller.</p>

11.4 Slave diagnostics or I/O device diagnostics

Errors such as "Sensor not found" trigger a slave or I/O device diagnostic message. Slave diagnostics works according to the PROFIBUS standards EN 50170 and IEC 61158 / IEC 61784. Depending on the DP master or I/O controller, the diagnostic information can be read with STEP 7.

How to read out the slave or IO device diagnostic information and how it is structured is described briefly below. You will find a detailed description in the *Distributed I/O Station ET 200M* manual or in the *PROFINET IO – From PROFIBUS DP to PROFINET IO* Programming Manual.

Note

SIMATIC® VS120 does not support the SYNC and FREEZE control commands. If the SIMATIC® VS120 slave nevertheless receives one of these control commands, bit 0 in diagnostic byte 1 is set (see Section Diagnostics in PROFIBUS DP).

Reading out diagnostic information with S7

If an error message such as "Sensor not found" occurs on the processing unit and you are using an S7 CPU as the DP master or I/O controller, the diagnostic interrupt OB (OB82) is started.

Its local variables OB_82_EV_CLASS, OB_82_MDL_DEFECT, and OB82_EXT_FAULT can have the following values:

Variable	Value	Meaning
OB_82_EV_CLASS	B#16#39	Event entering state
OB_82_MDL_DEFECT	TRUE	Module fault
OB_82_EXT_FAULT	TRUE	External fault

Unfortunately it is not possible to recognize the actual cause of the problem from the local variables of OB82. This can be determined as follows:

- For PROFIBUS DP: by calling SFC13 "DPNRM_DG" or SFB 54 "RALRM" in OB82;
- For PROFINET IO: by calling SFB54 "RALRM" in OB82.

The entry "Module fault" appears in the diagnostic buffer and the relevant text from the GSD file is shown as the module status of the SIMATIC VS120, for example "Sensor not found".

When the error is eliminated (in the example: you have inserted the sensor again) and acknowledged this on the processing unit, the diagnostic interrupt OB (OB82) is started again on the DP master or IO controller.

11.4 Slave diagnostics or /O device diagnostics

Its local variables OB_82_EV_CLASS, OB_82_MDL_DEFECT, and OB82_EXT_FAULT can have the following values:

Variable	Value	Meaning
OB_82_EV_CLASS	B#16#38	Event exiting state
OB_82_MDL_DEFECT	FALSE	No module fault
OB_82_EXT_FAULT	FALSE	No external error

The entry "Module OK" now appears in the diagnostic buffer in PROFIBUS DP and the error text from the GSD file is no longer shown as the module status of the SIMATIC VS120.

Diagnostics for PROFIBUS DP

Reading the diagnostics data (slave diagnostics) with the SFC13 "DPNRM_DG"

Bytes 7 through 10 of the slave diagnostic information (diagnostic bytes 0 through 3) read with SFC13 correspond to the 32-bit long field "Unit_Diag_Bit" of the GSD file SI0180ED.GSD or the diagnostic bits shown in the table in Error messages.

The slave diagnostic information is structured designed as follows:

PROFIBUS frame	Meaning	Scope of validity
Byte 0	Station status 1 (bit 3 = 1: External diagnostic information available)	According to standard
Byte 1	Station status 2	According to standard
Byte 2	Station status 3	According to standard
Byte 3	Master PROFIBUS address	According to standard
Byte 4	Manufacturer ID (high byte): B#16#80	According to standard
Byte 5	Manufacturer ID (low byte): B#16#ED	According to standard
Byte 6	Length of the SIMATIC VS120-specific diagnostic data including byte 6: B#16#05	According to standard
Byte 7	Diagnostic byte 0 (bit 1 "Sensor not found")	SIMATIC VS120-specific
Byte 8	Diagnostic byte 1	SIMATIC VS120-specific
Byte 9	Diagnostic byte 2	SIMATIC VS120-specific
Byte 10	Diagnostic byte 3	SIMATIC VS120-specific

Receive alarm with SFB54 "RALRM"

SFB 54 "RALRM" returns the following diagnostic information in the TINFO parameter (task information) for PROFIBUS DP:

Byte	Value	Meaning
0 to 19	See OB description	Start information of the OB in which SFB 54 is called.
20 to 21	Depending on configuration	Address: <ul style="list-style-type: none"> • Bit 0 to 7: Station number (acc. to configuration) • Bit 8 to 14: DP master system ID (acc. to configuration) • Bit 15: 0
22	B#16#00	<ul style="list-style-type: none"> • Bit 0 to 3: Slave type (DP) • Bit 4 to 7: Profile type: 0000
23	B#16#01	<ul style="list-style-type: none"> • Bit 0 to 3: Alarm information type (alarm of a non-DPV1 slave / non-IO device) • Bit 4 to 7: Structure version
24	B#16#00 / B#16#01	Flags of the PROFIBUS DP master interface: <ul style="list-style-type: none"> • Bit 0 = 0: Alarm from integrated interface module • Bit 0 = 1: Alarm from external interface module • Bit 1 to 7: In each case 0
25	B#16#01 / B#16#00	Flags of the PROFIBUS DP master interface: <ul style="list-style-type: none"> • Bit 0 = 1 for alarm entering state • Bit 0 = 0 for alarm exiting state • Bit 1 to 7: In each case 0
26 to 27	W#16#80ED	PROFIBUS identification number (fixed)

SFB54 "RALRM" returns the following diagnostic information in the AINFO parameter (alarm status information) for PROFIBUS DP:

Byte	Value	Meaning
0	B#16#0F	Length of the received alarm information in bytes: 15
1	B#16#01	ID for the alarm type: 1=diagnostic interrupt
2	B#16#00	Slot number of the alarm triggering component
3	B#16#01 / B#16#02	1: event entering state, slot fault 2: event exiting state, slot fault cleared
4	According to standard	Station status 1 (bit 3 = 1: External diagnostic information available)
5	According to standard	Station status 2
6	According to standard	Station status 3
7	According to standard	Master PROFIBUS DP address
8	B#16#80	Manufacturer ID (high byte)
9	B#16#ED	Manufacturer ID (low byte)
10	B#16#05	Length of the SIMATIC VS120-specific diagnostic data including this byte
11	SIMATIC® VS120	Diagnostic byte 0 (bit 1 "Sensor not found")
12	SIMATIC® VS120	Diagnostic byte 1
13	SIMATIC® VS120	Diagnostic byte 2
14	SIMATIC® VS120	Diagnostic byte 3

Diagnostics for PROFINET IO

Receive alarm with SFB54 "RALRM"

SFB54 "RALRM" returns the following diagnostic information in the TINFO parameter (task information) for PROFINET IO:

Byte	Value	Meaning
0 to 19	See OB description	Start information of the OB in which SFB 54 is called
20 to 21	Depending on configuration	Address: <ul style="list-style-type: none"> • Bit 0 to 10: Station number (acc. to configuration) • Bit 11 to 14: IO system ID (acc. to configuration) • Bit 15: 1
22	B#16#08	<ul style="list-style-type: none"> • Bit 0 to 3: Slave type 1000 = PNIO • Bit 4 to 7: Profile type: 0000
23	B#16#00	<ul style="list-style-type: none"> • Bit 0 to 3: Alarm info type: 0000 • Bit 4 to 7: Structure version: 0000
24	B#16#00 / B#16#01	Flags of the PNIO controller interface: <ul style="list-style-type: none"> • Bit 0 = 0: Alarm from integrated interface module • Bit 0 = 1: Alarm from external interface module • Bits 1 through 7: In each case 0
25	B#16#01 / B#16#00	Flags of the PNIO controller interface: <ul style="list-style-type: none"> • Bit 0 = 1 for alarm entering state • Bit 0 = 0 for alarm exiting state • Bits 1 through 7: In each case 0
26 to 27	W#16#0B01	PNIO device identification number (fixed)
28 to 29	W#16#002A	Manufacturer ID (fixed)
30 to 31	W#16# 0001	Identification number of the instance

The SFB 54 "RALRM" returns the following diagnostic information in the AINFO parameter (alarm status information) for PROFINET IO:

Note

Only bytes 0 to 25 of the AINFO parameter are written for alarms exiting state (see also the meaning of bytes 2 and 3 of AINFO).

Byte	Value	Meaning
0 to 1	W#16# 0002	Block type (fixed)
2 to 3	W#16#0022 / W#16#0016	Length of diagnostic data with alarm entering / exiting state
4 to 5	W#16# 0100	Version (fixed)
6 to 7	W#16#0001 / W#16#000C	ID for the alarm type: Diagnostic interrupt entering state / diagnostic interrupt exiting state
8 to 11	DW#16# 00000000	API (fixed)
12 to 13	W#16# 0000	Slot (fixed)
14 to 15	W#16# 0001	Subslot (fixed)
16 to 19	DW#16# 00000300	Module identification (fixed)
20 to 23	DW#16# 00000000	Submodule identification (fixed)
24 to 25	W#16#Bxxx / W#16#0xxx	Alarm specifier for alarms entering/exiting state: <ul style="list-style-type: none"> • Bits 0 through 10: Sequence number • Bit 11: Channel diagnostics: 0 (fixed) • Bit 12: Status of vendor-specific diagnostics • Bit 13: Status of diagnostics on submodule • Bit 14: reserved: 0 • Bit 15: Application relation diagnostic status
26 to 27	W#16#0003	Format ID for manufacturer-specific diagnostics (fixed)
28 to 29	W#16# 0000	Slot (fixed)
30 to 31	W#16# 0001	Subslot (fixed)
32 to 33	W#16# 0000	Channel (fixed)
34 to 35	W#16# 0805	Properties (fixed)
36 to 37	Value from the table in Error messages	ID for occurring error

Read data record with SFB52 "RDREC"

In contrast to event-based reading of diagnostic data with the SFB54, it is also possible to read diagnostic data based on the status. Status-related reading of the diagnostic data is performed using SFB52 "RDREC".

SFB52 is called as follows:

- Assign the diagnostic address of the SIMATIC VS120 to the parameter ID in hexadecimal format.
- Assign the INDEX parameter the value 2.

The diagnostic data record is structured as follows:

Byte	Value	Meaning
0 to 1	W#16# 0010	Data record type: Diagnostic data record
2 to 3	W#16# 0012	Data record length starting at byte 4: 18 bytes
4 to 5	W#16# 0100	Version
6 to 7	W#16# 0000	Slot
8 to 9	W#16# 0001	Subslot
10 to 11	W#16# 0000	Channel
12	B#16#08 / B#16#10	Error detected / no error detected
13	B#16#05	Indicates that all variables are save word by word beginning at byte 14
14 to 15	W#16#0003	ID for manufacturer-specific diagnostics
16 to 17	W#16# 0000	Channel number
18 to 19	W#16#0805 / W#16#1005	Content identical to bytes 12 and 13
20 to 21	Value from the table in Error messages	ID for occurring error

Technical data

12.1 General technical specifications

Power supply		
Supply voltage (UN)	24 V DC; (20.4...28.8 V DC, safety extra low voltage, SELV). SIMATIC VS120 does not have integrated protection against surge in the μ s range (surge pulse). For external measures, see EMC.	
<ul style="list-style-type: none"> • Input voltage protected against polarity reversal • Power down (bridgeable) 	Yes	≤ 20 ms
Current consumption (IN)	Typical: I = 2 A (maximum load of 1.5 A over the digital inputs/outputs)	
Fuse	Max. 10 A	
Inrush current	I ₁ max. 10 A; < 1 ms	
Safety requirements complying with	IEC 61131-2 corresponds to DIN EN 61131-2	
Electromagnetic compatibility		
Pulse-shaped interference		
Interference	Test voltage	Corr. to severity
Electrostatic discharge according to IEC 61000-4-2	<ul style="list-style-type: none"> • Air discharge: ± 8 kV • Contact discharge: ± 6 kV 	3
Burst pulse (fast transients) complying with IEC 61000-4-4	<ul style="list-style-type: none"> • 2 kV (power supply cable) • 2 kV (signal line) 	3
Surge complying with IEC 61000-4-5		
Coupling	Test voltage	Corr. to severity
Asymmetrical	2 kV (power supply cable) direct voltage with protective elements	3
Symmetrical	1 kV (power supply cable) direct voltage with protective elements	3

Electromagnetic compatibility		
Sine-shaped interference		
RF interference (electromagnetic fields)	Test values	Corr. to severity
Conforming to IEC 61000-4-3	10 V/m at 80 % amplitude modulation of 1 kHz in the range from 80 to 1000 MHz	3
Conforming to IEC 61000-4-3	10 V/m at 50% pulse modulation at 900 MHz	3
RF interference on cable/cable shields	Test values	Corr. to severity
Conforming to IEC 61000-4-6	Test voltage 10 V at 80% amplitude modulation of 1 kHz in the range from 9 kHz to 80 MHz	3
Emitted interference		
Limit class	<ul style="list-style-type: none"> • Emitted interference of electromagnetic fields in accordance with EN 55011: Limit class A, group 1; • Emitted interference via the AC input power supply in accordance with EN 55011: Limit class A, group 1; • Emitted interference and illumination are within the limit value to comply with EN 55022: Class B. 	

Transport and Storage of Modules

With regard to transportation and storage conditions, the SIMATIC VS120 surpasses the requirements specified in IEC 61131-2. The following conditions apply to modules that are transported and stored in the original packaging.

The climatic conditions correspond to IEC 60721-3-3, Class 3K7 for storage and IEC 60721-3-2, Class 2K4 for transport.

The mechanical conditions correspond to IEC 60721-3-2, Class 2M2.

Conditions	Permitted range
Free fall	≤ 1 m (up to 10 kg)
Temperature	-30 to +70° C
Atmospheric pressure	1080 to 660 hPa, corresponds to a height of 1000 to 3500 m
Relative humidity (at +25 °C)	5 to 95%, no condensation
Sine-shaped oscillations complying with IEC 60068-2-6	5 - 9 Hz: 3.5 mm 9 - 500 Hz: 9.8 m/s ²
Shock complying with IEC 60068-2-29	250 m/s ² , 6 ms, 1000 shocks

Mechanical Environmental Conditions for Operation

SIMATIC VS120 is designed for fixed installation in an environment protected from the weather and meets the conditions for use complying with DIN IEC 60721-3-3:

- Class 3M3 (mechanical requirements);
- Class 3K3 (climatic environmental conditions);

Mechanical environmental conditions, sine-shaped oscillations

Frequency range in Hz	Test values
$10 \leq f < 58$	0.075 mm amplitude
$58 \leq f < 500$	1 g constant acceleration

Test for mechanical environmental conditions

Test for / Test standard	Comments
Vibrations Oscillation test complying with IEC 60068-2-6 (sine)	<ul style="list-style-type: none"> • Vibration type: Frequency cycles with a rate of change of 1 octave/minute. <ul style="list-style-type: none"> – $10 \text{ Hz} \leq f < 58 \text{ Hz}$, constant amplitude 0.075 mm – $58 \text{ Hz} \leq f < 500 \text{ Hz}$, constant acceleration 1 g – $10 \text{ Hz} \leq f \leq 55 \text{ Hz}$, amplitude 1 mm (only sensor head and lighting unit) • Vibration duration: 10 frequency cycles per axis in each of the 3 perpendicular axes.

Test for / Test standard	Comments
Shock Shock test complying with IEC 60068-2-29	<ul style="list-style-type: none"> • Type of shock: Half-sine • Strength of the shock: <ul style="list-style-type: none"> – Processing unit 10 g peak value / 16 ms duration – Sensor head, illumination: 10 g peak value / 16 ms duration • Direction of shock: 100 shocks in each of the 3 perpendicular axes
Shock test complying with IEC 60068-2-27	Sensor head, illumination: <ul style="list-style-type: none"> • 70 g peak value / 6 ms duration 3 times in each direction • 30 g peak value / 11 ms duration 3 times in each direction

Ambient climatic conditions for operation

Ambient conditions	Permitted range	Comments
Temperature	0 to +50° C	
Temperature change	Max. 10 °C/h	
Relative humidity	max. 95 % at +25 °C	No condensation, corresponds to relative humidity degree 2 to IEC 61131-2.
Atmospheric pressure	1080 to 795 hPa, corresponds to a height of 1000 to 2000 m	
Contaminant concentration	<ul style="list-style-type: none"> • SO₂: < 0.5 ppm; RH < 60 %, no condensation • H₂S: < 0.1 ppm; RH < 60 %, no condensation 	<ul style="list-style-type: none"> • Check: 10 ppm; 4 days • Check: 1 ppm; 4 days

Note

The mechanical and climatic environmental conditions for operation specified above apply only to the sensor heads with order numbers 6GF2 002-8DA01 and 6GF2 002-8EA01.

For the sensor heads with order numbers 6GF2 002-8CB, the mechanical and climatic environmental conditions depend on the lens used.

Test voltages to IEC 61131-2

Circuits with nominal voltage U_e to other circuits or ground.	Test voltage
--	---------------------

0 V < U_e ≤ 50 V	350 V
--------------------	-------

50 V < U_e ≤ 100 V	700 V
----------------------	-------

100 V < U_e ≤ 150 V	1300 V
-----------------------	--------

150 V < U_e ≤ 300 V	2200 V
-----------------------	--------

12.2 Technical specifications of SIMATIC VS120

Lighting unit			
LED ring flash	<ul style="list-style-type: none"> • LEDs, wavelength 630 nm (red) • Ring flash with flash duration of 20 µs ... 10 ms, diffuse • DIN EN 60825-1:1994+A11:1996+A2:2001 		
Casing	Plastic		
Dimensions (W x H x D) in mm	102 × 102 × 26.5		
Weight	Approx. 0.13 kg		
Rated voltage	16.5 V DC		
Degree of protection	IP 65		
Sensor head			
Image capture	CCD chip ¼", 640 × 480, square pixels; full-frame shutter		
Image data transfer	Triggered image capture		
Casing	Aluminum profile casing, anodized black		
Dimensions (W x H x D) in mm	42 × 42 × 110		
Weight	Approx. 0.24 kg		
Rated voltage	16.5 V DC		
	SIMATIC VS120 for large specimens	SIMATIC VS120 for small specimens	Sensor head for variable specimens (C/CS mount)
Distance sensor front edge – test piece	100 mm	90 mm	Depending on lens
Field of vision	70 mm × 50 mm	40 mm × 30 mm	Variable, depending on lens
Degree of protection	IP 65 to IEC 60529		
CCD resolution	0.11 mm÷pixels	0.06 mm÷pixels	Image width ÷ 640 pixels

Processing unit	
Operator controls	4-row text display and 6 control buttons
Training new models and model sets	Models can be trained.
Number of models that can be stored	64 different models in 15 model sets; can be selected with adjustment support, buttons, or digital inputs, non-volatile storage
Triggering tests	External via digital input or via PROFIBUS DP, PROFINET IO or Ethernet TCP connection, Minimum pulse duration 5 ms
Commissioning software	Web interface for commissioning, mounting and adjustment of the sensor head and lighting
Casing	Plastic, all cables can be plugged in, suitable for installation without cubicle
Dimensions (W x H x D) in mm	170 × 140 × 76
Weight	Approx. 0.5 kg
Rated voltage	16.5 V DC
Degree of protection	IP 40 to IEC 60529

Interfaces on the processing unit

Interface for load current supply	<ul style="list-style-type: none"> • 4-pin circular connector (male) for load current supply • Cable length: 10 m (4 × 0.56 mm²) • Rated input voltage: 24 V DC • Rated input current: 2.2 A • Input voltage range: 20.4 V... 28.8 V DC
Illumination control	<ul style="list-style-type: none"> • 4-pin circular connector (female) for power supply and for triggering the flash • Power consumption at 16.5 V: Max. 0.3 A • Cable length: 2,5 m (4 × 0.23 mm²)
Sensor head interface	<ul style="list-style-type: none"> • Digital interface (26-pin D-sub female connector) for connecting the SIMATIC VS120 sensor head • Power consumption at 16.5 V DC: Max. 0.16 A • Cable length: 2.5 m (26 × 0.09 mm²)
Digital inputs for 24 V DC	<ul style="list-style-type: none"> • 8; one being a trigger input with interrupt capability for standard binary sensors, • 7 further PLC-compliant control inputs
Digital outputs for 24 V DC	<ul style="list-style-type: none"> • 6; max. load 0.5 A each, however in total a maximum of 1.5 A (15-pin D-sub female for inputs/outputs) • Cable length: 10 m (15 × 0.14 mm²)
DP interface	<ul style="list-style-type: none"> • 9-pin D-sub socket; programmable; <ul style="list-style-type: none"> – Isolated: Data lines A, B; control lines RTS; 5 V power supply (max. 90 mA) – Grounded Shield of the DP12 connecting cable; RS 485; floating – Non-floating 24 V DC/150 mA
Ethernet interface	<ul style="list-style-type: none"> • 8-pin RJ-45 jack, 10/100 Mbps

Side length of a pixel	Graphic width	Actual length at a resolution of 640 × 480	Actual length at a resolution of 640 × 480
SIMATIC VS120 for large specimens	70 mm	70/640 mm	70/320 mm
SIMATIC VS120 for small specimens	40 mm	40/640 mm	40/320 mm
C/CS mount	12 mm	12/640 mm	12/320 mm
	300 mm	300/640 mm	300/240 mm

12.3 Port assignment of the processing unit

Power supply "IN 24 V DC" (pin)				
Wiring	Name	Function	Direction	Wire color
1	+24V	24 V DC supply voltage	-	Red
2	+24V	24 V DC supply voltage	-	Orange
3	M	Ground	-	Black
4	M	Ground	-	Brown

Interface to the Lighting Unit "LAMP" (socket)				
Wiring	Name	Function	Direction	
1	+16V	16.5 V DC supply voltage	-	
2	LIGHT	Pulse to start a light flash (24 V DC)	Output	
3	M	Ground	-	
4	M	Ground	-	

Interface to Sensor Head "SENSOR" (socket)				
Wiring	Name	Function	Direction	
Casing		Shielding	-	
9	M		-	
10	M		-	
14		+16 V	-	
20	TxD _P	Image data +	Input	
21	TxD _N	Image data -	Input	
22	CLK _P	Image synchronization +	Output	
23	CLK _N	Image synchronization -	Output	
24	RxD _P	Sensor parameter +	Output	
25	RxD _N	Sensor parameter -	Output	
26	M		-	

I/O interface "DI/DO" (socket)				
Wiring	Name	Function	Direction	Wire color
1	DISA	Disable: Disable manual keypad input, model selection via digital I/O	Input	Black
2	SEL0	Select 0: Model selection: Bit 0	Input	Brown
3	SEL1	Select 1: Model selection: Bit 1	Input	Green
4	SEL2	Select 2: Model selection: Bit 2	Input	Orange
5	SEL3	Select 3: Model selection: Bit 3	Input	Yellow

I/O interface "DI/DO" (socket)				
6	--	Not used	--	--
7	TRG	Trigger: An evaluation is started on the positive-going edge	Input	Blue
8	RES	Reset: Reset error	Input	Violet
9	IN_OP	In operation: <ul style="list-style-type: none"> • 0 = SIMATIC VS120 starting up or error message is displayed. • 1 = SIMATIC VS120 functional, no errors 	Output	White-black
10	TRD	Trained: Selected model has been trained.	Output	White-brown
11	RDY	Ready: <ul style="list-style-type: none"> • 0 = Device startup or SIMATIC VS120 in Stop • 1 = SIMATIC VS120 in processing mode (Run) 	Output	White-green
12	OK	Evaluation result: Trained model was recognized.	Output	White-orange
13	--	Not used	--	--
14	N_OK	Evaluation result: Trained model was not recognized.	Output	White-red
15	M	Ground	-	Gray

PROFIBUS DP Interface (socket)		
Wiring	Name	Function
1	-	Not used
2	M	Chassis, non-floating
3	LTG_B	Data line (I/O)
4	RTSAS	Turn on PLC transmitter (O)
5	GND	Chassis, floating
6	P5V	+ 5 V (fused) floating
7	24V	Non-floating
8	LTG_A	Data line (I/O)
9	-	Not used

12.3 Port assignment of the processing unit

Ethernet interface "ETHERNET" (socket)		
Wiring	Name	Function
1	TxD +	Send data +
2	TxD -	Send data -
3	RxD +	Receive data +
4	-	Not used
5	-	Not used
6	RxD -	Receive data -
7	-	Not used
8	GND	Chassis, non-floating

Dimension drawings

13.1 SIMATIC VS120 processing unit

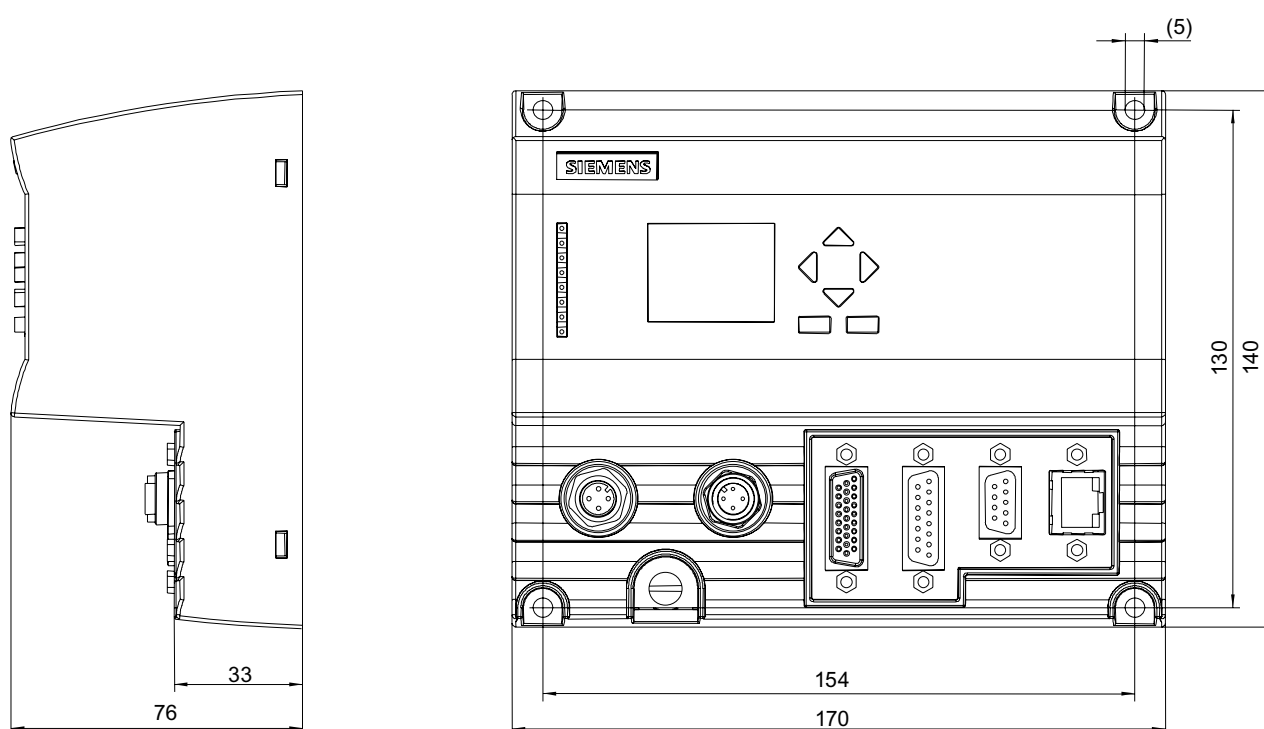

Figure 13-1 Processing unit

- Intended fixing screws M4×12 or longer
- Permitted, static bending radii with:
 - Power supply cable with a minimum radius of 40 mm
 - Illumination cable with a minimum radius of 25 mm
 - Sensor cable with a minimum radius of 40 mm
 - DI / DO cable with a minimum radius of 50 mm

13.2 SIMATIC VS120 sensor head

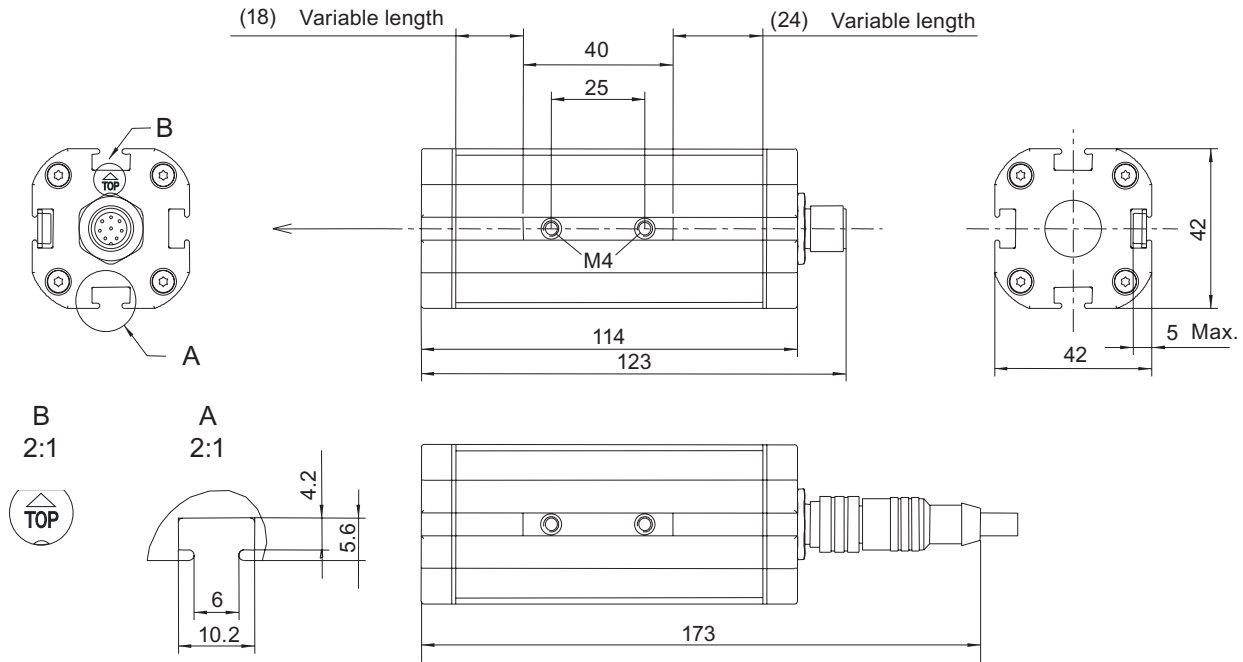

Figure 13-2 Sensor head

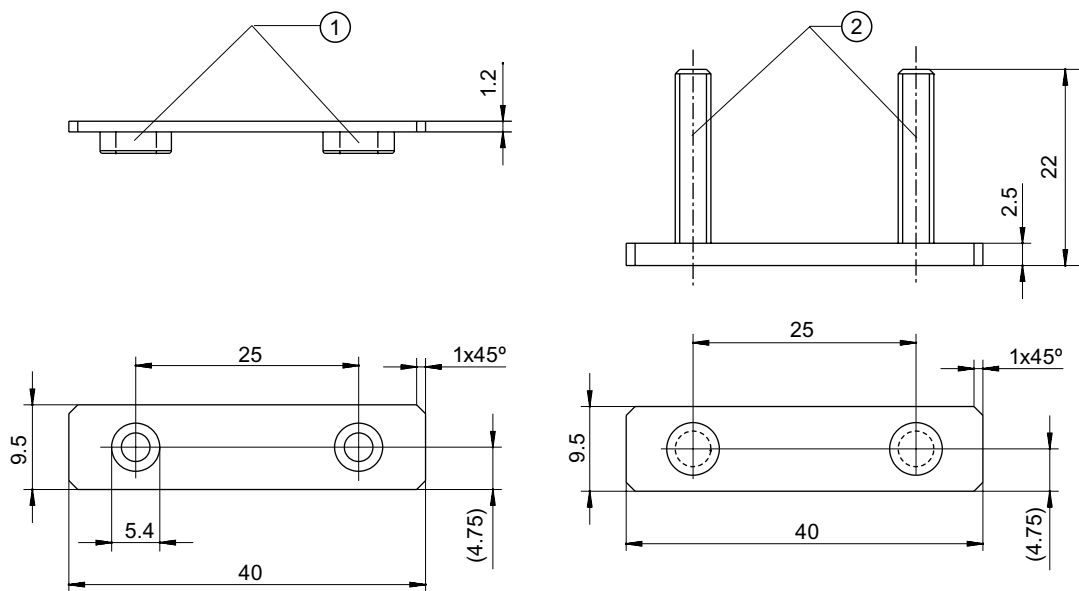

Figure 13-3 Mounting plate for sensor head

- 1) press-in nut M4
- 2) press-in bolt M4 x 22

13.3 SIMATIC VS120 lighting unit

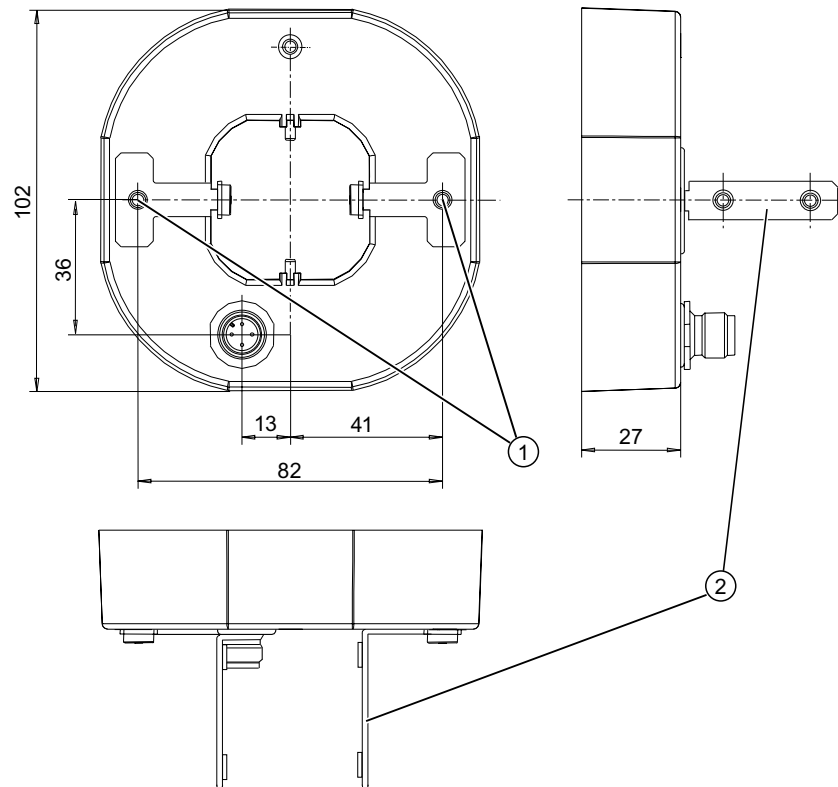

Figure 13-4 Lighting unit

- 1) M4 screw
- 2) Mounting bracket for mounting the sensor head

Scope of delivery/Spares/Accessories

14.1 Components

Full package

The full SIMATIC VS120 package comprises:

- Sensor head with CCD sensor chip for acquiring specimens
- LED ring light red, diffuse for SIMATIC VS, degree of protection IP65 (not included in every full package)
- Processing unit for image processing, output of results, attachment to PROFIBUS DP and Ethernet, and parameter assignment
- Cables to connect the individual components
- Documentation package

Documentation package

The SIMATIC VS120 documentation package comprises:

- Operating Instructions (compact) for SIMATIC VS120 as hard copy version in the languages
 - German
 - English
 - Spanish
 - Italian
 - French
- Documentation CD SIMATIC VS120 with:
 - Operating Instructions for SIMATIC VS120 in the languages German, English, Spanish, Italian and French
 - Operating Instructions (compact) for SIMATIC VS120 in the languages German, English, Spanish, Italian and French
 - Online Help
 - Function block FB1 and data block DB10 for PROFIBUS DP and PROFINET IO data exchange
 - Example programs for FB1
 - Example program for archiving of diagnostic information

14.2 Full packages

- SIMATIC S7-300 Automation System, Installation Manual
- Device master data file SI0180ED.GSD with the corresponding bitmap file VS1X0__N.DIB for PROFIBUS DP
- Device master data file GSDML-V2.0-Siemens-002A-VS100-20060208.XML with corresponding bitmap file VS100.BMP for PROFINET IO

You will find an overview of the complete range of components in the section *Complete Packages*.

Note

If you want to use C- or CS-mount sensors under IP65 conditions, use a lens protective housing.

14.2 Full packages

The following tables list the order numbers (MLFB) of the full packages and the individual components.

6GF1 120-1AA	SIMATIC VS120 full package, field of view 70 x 50 mm, cable 2.50 m
6GF1 018-2AA10	SIMATIC VS120 processing unit
6GF2002-8DA01	Sensor head with mounting plate (A5E00190326), degree of protection IP 65, field of view 70 x 50 mm
6GF7 021-1AA10	Documentation package for SIMATIC VS120
6GF9002-8CA	Cable for power supply, 10 m
6GF9002-8CB	Cable for connecting digital I/O devices, 10 m
6GF9002-8CD	Cable between processing unit and sensor head, 2.5 m
6GF9002-8CE	Cable between illumination and processing unit, 2.5 m
6GF9004-8BA	LED ring light red, diffuse with mounting bracket (A5E00200046) for SIMATIC VS, degree of protection IP65

6GF1 120-1AA01	SIMATIC VS120 full package, field of view 70 x 50 mm, cable 10 m
6GF1 018-2AA10	SIMATIC VS120 processing unit
6GF2002-8DA01	Sensor head with mounting plate (A5E00190326), degree of protection IP 65, field of view 70 x 50 mm
6GF7 021-1AA10	Documentation package for SIMATIC VS120
6GF9002-8CA	Cable for power supply, 10 m
6GF9002-8CB	Cable for connecting digital I/O devices, 10 m
6GF9002-8CF	Cable between processing unit and sensor head, 10 m
6GF9002-8CG	Cable between illumination and processing unit, 10 m
6GF9004-8BA	LED ring light red, diffuse with mounting bracket (A5E00200046) for SIMATIC VS, degree of protection IP65

6GF1 120-2AA	SIMATIC VS120 full package, field of view 40 x 30 mm, cable 2.50 m
6GF1 018-2AA10	SIMATIC VS120 processing unit
6GF2002-8EA01	Sensor head with mounting plate (A5E00190326), degree of protection IP 65, field of view 40 x 30 mm
6GF7 021-1AA10	Documentation package for SIMATIC VS120
6GF9002-8CA	Cable for power supply, 10 m
6GF9002-8CB	Cable for connecting digital I/O devices, 10 m
6GF9002-8CD	Cable between processing unit and sensor head, 2.5 m
6GF9002-8CE	Cable between illumination and processing unit, 2.5 m
6GF9004-8BA	LED ring light red, diffuse with mounting bracket (A5E00200046) for SIMATIC VS, degree of protection IP65

6GK1 120-2AA01	SIMATIC VS120 full package, field of view 40 x 30 mm, cable 10 m
6GF1 018-2AA10	SIMATIC VS120 processing unit
6GF2002-8EA01	Sensor head with mounting plate (A5E00190326), degree of protection IP 65, field of view 40 x 30 mm
6GF7 021-1AA10	Documentation package for SIMATIC VS120
6GF9002-8CA	Cable for power supply, 10 m
6GF9002-8CB	Cable for connecting digital I/O devices, 10 m
6GF9002-8CF	Cable between processing unit and sensor head, 10 m
6GF9002-8CG	Cable between illumination and processing unit, 10 m
6GF9004-8BA	LED ring light red, diffuse with mounting bracket (A5E00200046) for SIMATIC VS, degree of protection IP65

6GF1 120-3AB	SIMATIC VS120 full package, field of view variable, cable 2.50 m
6GF1 018-2AA10	SIMATIC VS120 processing unit
6GF2002-8CB	Sensor head with mounting plate (A5E00190326), degree of protection IP 65, field of view variable
6GF7 021-1AA10	Documentation package for SIMATIC VS120
6GF9002-8CA	Cable for power supply, 10 m
6GF9002-8CB	Cable for connecting digital I/O devices, 10 m
6GF9002-8CD	Cable between processing unit and sensor head, 2.5 m

6GF1 120-3AB01	SIMATIC VS120 full package, field of view variable, cable 10 m
6GF1 018-2AA10	SIMATIC VS120 processing unit
6GF2002-8CB	Sensor head with mounting plate (A5E00190326), degree of protection IP 65, field of view variable
6GF7 021-1AA10	Documentation package for SIMATIC VS120
6GF9002-8CA	Cable for power supply, 10 m
6GF9002-8CB	Cable for connecting digital I/O devices, 10 m
6GF9002-8CF	Cable between processing unit and sensor head, 10 m

14.3 Accessories

Machine-Readable Product Code	Designation
6XV1 850-2HH20	Ethernet RJ-45 x RJ-45 (send and receive line crossed over), 2 m long
6XV1 850-2GH20	Ethernet RJ-45 = RJ-45 (send and receive line not crossed over), 2 m long

Supported Sensors				
Machine-Readable Product Code	Lens	Max. resolution	Distortion factor	Light
6GF2002-8AA	Fixed focus 6.5mm	640 × 480 pixels	50	Infrared with infrared band filter
6GF2002-8BA	Fixed focus 8mm	640 × 480 pixels	5	Infrared with infrared band filter
6GF2002-8CB	C-mount suitable for tube	640 × 480 pixels	0	Daylight
6GF2002-8DA01	Fixed focus 6.5mm	640 × 480 pixels	130	Daylight
6GF2002-8EA01	Fixed focus 8mm	640 × 480 pixels	50	Daylight
6GF2002-8FA01	Fixed focus 16 mm	640 × 480 pixels	0	Daylight

Note

For other accessories such as IP65 lens protective housing, protective housing, LED ring light, sensor head holder, and sensor head holder and sensor head holder (solid), refer to:

- **Simatic Sensors** catalog, order number E86060-K8310-A111-A2SIMATIC SENSORS;
- On the Internet at <http://www.automation.siemens.com/simatic-sensors> or <http://www.siemens.com/automation/mall>.

14.4 C-mount lens and inspection window size

Note

From the following table, you can select the lens suitable for your application by selecting the best distance and inspection window.

Distance lens front edge – object in m	Lens		Inspection window	
	Image width in mm	Image height in mm	Order no.(MLFB)	Focal distance in mm, light intensity
0,30	91	68	6GF9 001-1BL01	12, 1:1,4
0,40	121	90	6GF9 001-1BL01	12, 1:1,4
0,40	92	69	6GF9 001-1BF01	16, 1:1,4
0,50	115	85	6GF9 001-1BF01	16, 1:1,4
0,50	72	54	6GF9 001-1BG01	25, 1:1,4
0,60	87	65	6GF9 001-1BG01	25, 1:1,4
0,70	101	75	6GF9 001-1BG01	25, 1:1,4
0,80	115	86	6GF9 001-1BG01	25, 1:1,4
0,80	85	63	6GF9 001-1BH01	35, 1:1,6
0,90	95	71	6GF9 001-1BH01	35, 1:1,6
1,00	105	79	6GF9 001-1BH01	35, 1:1,6
1,10	116	86	6GF9 001-1BH01	35, 1:1,6
1,20	126	94	6GF9 001-1BH01	35, 1:1,6
1,20	81	60	6GF9 001-1BJ01	50, 1:2,8
1,30	88	65	6GF9 001-1BJ01	50, 1:2,8
1,40	95	71	6GF9 001-1BJ01	50, 1:2,8
1,50	102	76	6GF9 001-1BJ01	50, 1:2,8
1,60	109	81	6GF9 001-1BJ01	50, 1:2,8
1,70	116	87	6GF9 001-1BJ01	50, 1:2,8
1,70	79	59	6GF9 001-1BK01	75, 1:2,8
1,80	84	63	6GF9 001-1BK01	75, 1:2,8
1,90	89	66	6GF9 001-1BK01	75, 1:2,8
2,00	94	70	6GF9 001-1BK01	75, 1:2,8
2,10	99	73	6GF9 001-1BK01	75, 1:2,8
2,20	103	77	6GF9 001-1BK01	75, 1:2,8

14.4 C-mount lens and inspection window size

Distance lens front edge – object in m	Lens		Inspection window	
2,30	108	81	6GF9 001-1BK01	75, 1:2,8
2,40	113	84	6GF9 001-1BK01	75, 1:2,8
2,50	118	88	6GF9 001-1BK01	75, 1:2,8
2,60	122	91	6GF9 001-1BK01	75, 1:2,8
2,60	88	66	6GF9 001-1BJ01 and 6GF9 001-1BV	50 and extender
2,70	92	69	6GF9 001-1BJ01 and 6GF9 001-1BV	50 and extender
2,80	96	71	6GF9 001-1BJ01 and 6GF9 001-1BV	50 and extender
2,90	99	74	6GF9 001-1BJ01 and 6GF9 001-1BV	50 and extender
3,00	103	77	6GF9 001-1BJ01 and 6GF9 001-1BV	50 and extender

Service & Support

15.1 A&D Mall / Interactive Catalog (CA01)

In the online catalog CA01 of the Automation & Drives group, you will find details on the following and can place orders:

- Products
- Systems

Internet address:

<http://mall.ad.siemens.com>

15.2 Service and support

Technical support

You can reach the technical support team for all A&D projects at:

- Telephone: ++49 (0) 180 5050 222
- Fax: ++49 (0) 180 5050 223

Internet

- Visit our site on the Internet at:
<http://www.siemens.com/automation/service&support>
- You can send a support query to:
<http://www.siemens.de/automation/support-request>
- The online catalog and the online ordering system is available at:
www.siemens.de/automation/mall
- For further information on factory automation sensors, visit
<http://www.siemens.de/simatic-sensors>

Directives and declarations

CE Label

SIMATIC VS120 meets the requirements and protective aims of the following EU directive.

EMC Directive

The devices meet the requirements of the EC directive "89/336/EEC Electromagnetic Compatibility" (modified by 91/263/EEC, 92/31/EEC and 93/68/EEC) and are designed according to the CE marking for use in an industrial environment.

Area of application	Requirements	
	Emitted interference	Immunity to interference
Industry	EN 61000-6-4: 2001	EN 61000-6-2: 2001

Declaration of conformity

The EC Declaration of Conformity and the corresponding documentation are available for the responsible authorities according to the above-mentioned EC Directive at the following address:

Siemens AG
Automation and Drives
Factory Automation Sensors
P.O.Box 4848
90437 NUREMBERG
GERMANY

Your sales representative can provide these on request.

Observance of installation guidelines

The installation guidelines and safety instructions in this documentation must be followed during commissioning and operation.

DIN ISO 9001 certificate

The quality assurance system for the entire product process (development, production, and marketing) at Siemens fulfills the requirements of ISO 9001 (corresponds to EN29001: 1987).

This has been certified by DQS (the German society for the certification of quality management systems).

EQ-Net certificate no.: 1323-01

Software license agreement

The device ships with preinstalled software. Please observe the corresponding license agreements.

EMC

USA	
Federal Communications Commission Radio Frequency Interference Statement	This equipment has been tested and found to comply with the limits for a Class A digital device, pursuant to Part 15 of the FCC Rules. These limits are designed to provide reasonable protection against harmful interference when the equipment is operated in a commercial environment. This equipment generates, uses, and can radiate radio frequency energy and, if not installed and used in accordance with the instruction manual, may cause harmful interference to radio communications. Operation of this equipment in a residential area is likely to cause harmful interference in which case the user will be required to correct the interference at his own expense.
Shielded Cables	Shielded cables must be used with this equipment to maintain compliance with FCC regulations.
Modifications	Changes or modifications not expressly approved by the manufacturer could void the user's authority to operate the equipment.
Conditions of Operations	This device complies with Part 15 of the FCC Rules. Operation is subject to the following two conditions: (1) this device may not cause harmful interference, and (2) this device must accept any interference received, including interference that may cause undesired operation.

CANADA	
Canadian Notice	This Class B digital apparatus complies with Canadian ICES-003.
Avis Canadien	Cet appareil numérique de la classe b est conforme à la norme NMB-003 du Canada.

AUSTRALIA	
	This product meets the requirements of the AS/NZS 3548 standard (Class A).

Glossary

Actuator

Component at the output section of a controlled system, which intervenes in energy or mass flows and thereby causes changes.

Adjustment support

Software Web server application, in which most operator actions are performed on the PC screen using a mouse and keyboard. The software processes and displays models.

ASCII

American Standard Code for Information Interchange.

Automation system

An automation system is a programmable logic controller consisting of at a central processing unit, a variety of input and output modules as well as operator control and monitoring (HMI) devices.

BF

Bus fault

Bit

Binary digit

Bus

A cable or conductor system used for data transfer among the components of a computer system. Buses are characterized by the number of bits they can transfer at any one time. There are serial bus systems (one bit after the other) and parallel bus systems (multiple bits simultaneously over several lines).

Byte

Binary term

CCD

Charge Coupled Device

Com server

A Com server represents the communication center between a serial DTE (machine, measuring device, controller...) and the TCP/IP computer network.

Contour

Closed line that completely runs along the edge of an object, i.e. it encompasses the border points.

Counter

A counter registers the status transitions (edges) of a digital signal. With each status transition, the counter increases (increments) or decreases (decrements) a value that is then evaluated by SIMATIC S7 or a PLC.

CPU

Central Processing Unit

Crossover cable

A crossover cable can only be used for a direct connection between two PCs or devices. Due to the crossing of the send and receive wires, the PCs/devices can communicate without additional components (HUB, switch).

Both the PC and processing unit must have an Ethernet RJ-45 port.

CSV

Character Separated Values -> A CSV file (can be read with Microsoft Excel, for example) is a text file for saving or exchanging simply structured data.

DB

Data block

Debouncing

Permanent electrical contact does not occur immediately when electrical switching or key contacts are closed; the connection opens and closes several times within a fraction of a second. With digital input devices (computer keyboards, input controllers on keypads, etc.), this bouncing effect causes each occurrence of the contact to be registered as a separate input (multiple input). Since the discovery of the phenomenon, various hardware and software solutions have been developed. Counteracting this effect is known as debouncing (debouncing circuit or routine).

DHCP client

Each device with network capability that supports communication with a DHCP server to obtain dynamically leased IP configurations and other optional parameter information.

DHCP server

A computer on which the Microsoft DHCP service runs. This provides active DHCP clients with dynamic configuration of IP addresses and related information.

DHCP: Dynamic Host Configuration Protocol

A TCP/IP service protocol that allows dynamic configurations of host IP addresses for a certain time and distributes related configuration parameters to authorized network clients. DHCP provides safe and simple-to-use configuration of TCP/IP networks, prevents address conflicts and helps to restrict the number of IP addresses required in the network. DHCP uses a client/server model in which the DHCP server takes over central management of IP addresses used in the network. Clients with DHCP support can then request and obtain the lease of an IP address from a DHCP server when the network starts up.

DI/DO

Digital Input /Digital Output

DIN

Deutsches Institut für Normung - German institute for standardization

Distortion: Distortion

Image error that becomes evident in the image of a rectangular grid where the straight lines are bent inwards or outwards.

DNS server Domain Name System server

A hierarchically distributed database containing assignments of DNS domain names to various data types, such as IP addresses. DNS allows computers and services to be found based on user-friendly names and also allows other information stored in the database to be found.

Download

In communications, to transfer a data copies from a remote computer to the requesting computer, for example, to send the operating system from a PC to a controller.

DP

Distributed Peripheral I/O

D-sub

Type identification for a connector.

EEPROM

Electrically Erasable Programmable Read Only Memory

EMC

ElectroMagnetic Compatibility

Endian

The data are partly saved with different byte sequences in various computer architectures. Intel-based computers, for example, save the data differently than the controllers from Siemens (S7), namely, in reverse sequence. The byte sequence from Intel, termed **Little Endian**, is therefore the reverse S7 byte sequence, **Big Endian**. The following applies to these two forms:

- Little Endian: The most significant byte is located at the right end of a word.
- Big Endian: The most significant byte is located at the left end of a word.

Ethernet

This is a specific type of local network that works according to a standard defined by Intel, DEC and Xerox.

FB

Function Block

FDB

A **Function Block Diagram** is a graphic representation of control functions. Each control task (function) has a corresponding symbol.

Firmware

Software routines stored in the Read-Only Memory (ROM). Startup routines and local machine I/O commands are stored in firmware. In terms of user friendliness, firmware takes an intermediate position between software and hardware.

Gateway

This is a device that is connected to more than one physical TCP/IP network and can forward or distribute IP packets. A gateway translates various transport protocols or data formats (for example IPX and IP) and is included in networks mainly because of this translation function.

Gateways are also known as IP routers.

Gnd

Ground

GSD

Device master data file

Handshake

Method for synchronizing transfer of data at irregular intervals. The sender signals when it can send new data and the recipient signals when it is ready to receive new data.

HF

High Frequency

Host name

The DNS name of a device on a network. These names are used to locate a computer in the network. Before a computer can be located, its host name must be listed in the host file or be known to a DNS server. On most computers running Windows, the host name and computer name are identical.

HTML

HyperText Markup Language -> plain text language for structuring text and hypertext

HTTP

HyperText Transfer Protocol -> protocol used mainly by Internet browsers on the World-Wide Web.

IEC

International Electrotechnical Commission

IP

Internet Protocol

IP address

A 32-bit address to identify a node in an IP network. Each node in the IP network must be assigned a unique IP address. This consists of the network ID and a unique host ID. This address is typically represented with the decimal value of each octet separated by a period (for example, 192.168.7.27). In this version of Windows, you can configure a static IP address or have it assigned dynamically by DHCP.

LAD

Ladder Diagram -> Graphic representation of controller functions based on a circuit diagram from protection technology. The current paths, however, are not arranged horizontally in relation to one another and the symbols deviate.

LAN

Local Area Network, for example, Ethernet network within a building.

LCD

Liquid Crystal Display

LEDs

Light Emitting Diode.

LF

Low Frequency

MAC

Media Access Control

MAC address

The MAC address is the hardware address for each network device (network card, switch , etc.) and is used for unique identification of the device in the network. The MAC address is burned into a chip and cannot normally be modified.

Machine-Readable Product Code

German **M**aschinenlesbare **F**abrikatebezeichnung ->The MLFB is the order number of a product and at the same time the type/system identifier.

Main ROI or ROI

Region of Interest The main ROI is the area with characteristics of the specimens relevant for image processing.

Master

The device configured as master in a communications system passes on data to the device configured as slave. The master is always the active partner.

PC

Personal Computer.

PELV

Protective **Extra Low Voltage** = extra low voltage with safe isolation

Persistence

Persistence is the ability to store data structures (or objects) in non-volatile memory such as file systems or databases. In other words, on the SIMATIC VS120 processing unit, data is stored and retained if there is a power outage.

PG

Programming device

Ping

A utility for checking connections to one or more remote hosts. The "ping" command uses the echo packets and echo replies of ICMP to check connectivity with an IP system in a network. Ping is useful in troubleshooting the IP network or the router.

PLC

Programmable **Logic Controller**.

Port or port address

Address for a channel for data transfer between an input or output device and the processor. From the CPU's perspective, a port represents one or more memory addresses to which it can send data or from which it can receive data. Special hardware such as expansion boards places data from a device in the memory address and sends data from these addresses to the device. Some ports are only for input and some only for output.

Processing unit

SIMATIC VS120 hardware unit for the recognition of models and test specimens. Operator control is interactive using operator buttons and a display field or controlled by signals over an automation system.

PROFIBUS

Process **Field Bus**-> International fieldbus standard to EN 50170/IEC 61158

PROFIBUS DP

PROFIBUS-DP (distributed peripheral I/O) is used for controlling sensors and actuators using a central controller in production engineering. It is also used in connection with "distributed intelligence", i.e. connecting multiple controllers to form a network. It provides data transmission up to 12 Mbps on twisted-pair cables and data transmission over sliding contacts for mobile subscribers in exceptional cases or optical data transmission in unobstructed space.

PROFINET device

A PROFINET IO system is assembled from the following devices:

- An IO controller is a controller or PC that controls automation tasks.
- An IO device is a field device that is configured and controlled by an IO controller. An IO device consists of several modules and submodules.
- IO Supervisor is an engineering tools typically based on a PC that is used to configure and perform diagnostics on individual IO devices, and to configure the complete plant. The controller gets its data from the Supervisor and configures the device based on this.

An application relation (AR) is formed between an IO controller and an IO device. Communication relations (CR) with varying properties are specified for the transfer of parameters, cyclical data communication and alarm handling based on this AR.

The properties and options of an IO device are described in a Generic System Description (GSD) file. This file is written in GSDML (GSD Markup Language) - an extension of XML - and is used as a planning tool to create a base configuration for PROFINET IO systems for planning.

PROFINET IO

PROFINET IO (Input Output) is used for controlling sensors and actuators using a central controller in production engineering.

Proxy

A computer that responds to name query broadcasts and answers to names that do not go to the local subnet. To evaluate the names, the proxy communicates with a WINS server and then retains the names in the cache for a certain time.

RS-232: Recommended Standard 232

RS is an accepted industrial standard for serial data communication. For cable lengths shorter than 15 m. No differential evaluation. Sending and receiving on different lines.

SELV

Safety extra low voltage

Sensor

In electrical engineering, a sensor is a component that can qualitatively measure not only specific physical or chemical properties (such as heat radiation, temperature, humidity, pressure, excess pressure, sound, luminance, magnetism, acceleration, force) as well as the physical condition of its surroundings or register them as measured variables.

Server

Network station that provides services and resources for other stations, for example, a computer that manages data and passes this on to other computers as needed.

SF

General fault

Shutter speed: Shutter speed

The shutter speed decides how long the CCD sensor of a camera is exposed. When more light is available, the operator can select a faster shutter speed and vice versa. At slow shutter speeds, there is greater risk that the image will suffer from "camera shake"

SIMATIC S7

Siemens automation system with the controller families SIMATIC S7-300 and SIMATIC S7-400.

SIMATIC VS120 Vision Sensor

Hardware and software: Full package consisting of the components: Sensor, LED overhead lighting, processing unit, connecting cable, installation instructions, CD with adjustment support and documentation.

Slave

The device configured as slave in a communications system receives data from the device configured as master. The slave is always the passive partner.

SNTP: Simple Network Time Protocol

SNTP is a simplified version of NTP and NTP is one of the oldest TCP/IP protocols still in use.

SP1

Service Pack 1 -> Additional software for the Windows XP Professional operating system and Internet Explorer 6.0.

STEP 7

STEP 7 is programming software for the S7-300 and S7-400 controller families

STL

STatement List -> User program in which control functions are listed in the form of statements.

Sub-ROI

The area in the main ROI with characteristics of the specimens of special relevance for image processing. Sub-ROIs are created when the characteristics of the main ROI are not adequate for evaluation.

Switch: English: switch

A switch is an electronic device for connecting several computers or network segments in a local network (LAN) - similar to a hub. Switches are also known as intelligent hubs. In its original form, the switch operates at layer 2 (Data Link layer) of the OSI model. The switch processes 48-bit MAC addresses and creates an SAT (Source Address Table).

The switch has properties similar to a bridge and is also known as a multi-port bridge. Ethernet switch is the shortened form, of *switching hub* and indicates the ability to operate switched Ethernet.

TCP

Transmission Control Protocol -> Connection-oriented protocol for reliable data transmission.

TCP/IP

Collective term for a family of protocols.

Trigger

A trigger is a switch that is activated by a specific event.

URL: Uniform Resource Locator

An address uniquely identifying a location on the Internet. A URL for a WWW page is preceded by `http://`. A URL can contain other details such as the name of a hypertext page identified by the file name extension HTML or HTM.

VDE

Association of Electrical Engineering, Electronics and Information Technology (Germany)

WAN

Wide Area Network -> For example the Internet.

XML

Extensible Markup Language ->XML is a standard for definition of formats for data exchange on the Internet.

Index

A

- A&D Mall, 15-1
- Adjust
 - Display, 9-2
- Adjustment support, 8-16
 - Operator control, 9-19
- Administrator privileges
 - Test, 8-1
- Assigning permissions, 9-41
- Assigning Permissions, 9-41
- Atmospheric pressure, 12-3

B

- BF LED
 - For PROFIBUS DP, 11-10
 - For PROFINET IO, 11-10
- Bit pattern
 - Creating, 10-9
- Brightness, 4-2
- Button
 - Change password, 9-41

C

- Cable connection, 7-3
- CE Label, 16-1
- Checking connections, 8-14
- Climatic ambient conditions, 12-3
- Climatic Conditions
 - Atmospheric pressure, 12-2
 - Temperature, 12-2
- Colors, 9-35
- Com server, 5-6
- Components
 - Documentation package, 14-1
 - Full package, 14-1
- Configuration
 - Avoiding interference, 7-1
- Configuration
 - PC / PG, 8-6
 - Processing unit, 8-6, 8-8

- Proxy, 8-13
- Configuration example, 10-2, 10-4
- Configuration guidelines, 7-1
- Connect
 - Menu, 9-2
- Connection
 - Sensor head, 7-1
- Connection variants
 - Ethernet connection, 8-5
- csv file
 - Size, 10-23

D

- Data block DB10, 10-16
- Data blocking, 10-14
- Data transmission
 - PROFIBUS DP, 10-10
 - PROFINET IO, 10-10
- Declaration of conformity, 16-1
- Device Info, 9-48
- Device names
 - Assigning, 10-6
- Devices
 - Information, 9-48
- DHCP client, 8-7, 8-9
- DHCP server, 8-6
- Diagn. & Monitoring, 9-42
 - Options, 9-42
- Diagnostic buffer, 11-11
- Diagnostics, 9-47, 11-10
 - For PROFIBUS DP, 11-12
 - For PROFINET IO, 11-15
 - Information, 9-47
 - Read out, 11-11
- Digital I/O
 - System configuration, 5-2
- DISA bit, 9-50, 10-19
- Display
 - Adjust, 9-2
- Distortion, 4-7

E

- Edge lines
 - Unwanted, 4-3
- Edges, 9-35
 - Recognition principle, 3-3
 - Training, 9-31
- EMC Directive, 16-1, 16-2
- Erasure function, 4-4
- ERRCODE, 10-20
- Error display, 9-22
- Error Information, 10-20
- Error information FB1, 11-8
- Error Message
 - Description, 11-1
- Error messages
 - Acknowledge, 11-1
 - Remedies, 11-1
- Errors
 - Automatic acknowledgement, 11-6
 - Manual acknowledgement, 11-6
- Ethernet
 - System configuration, 5-5
- Ethernet connection
 - Connection variants, 8-5
- Evaluation results
 - For part recognition, 9-37
 - In normal mode, 9-35
- Example
 - Archiving diagnostic information on PC / PG, 10-21
 - Link with FB1, 10-21
- Example 1
 - Integrating the FB1, 10-22
 - Linking to the SIMATIC controller, 10-21
 - Process interfacing, 10-22
- Example 2
 - Adjustment support, 10-23
 - Process interfacing, 10-23
- Exposure time, 4-2
- Extras, 9-43
 - Options, 9-43

F

- Faults, 7-1
- Firmware updates, 9-49
- Fixing screws, 13-1
- Fluctuations in size, 4-7
- Function block FB1, 10-16
- Fuse, 12-1

G

- General fault, 11-1
- GSD file, 10-1, 10-4

H

- Handshaking, 10-14
- Hardware, 3-5
- HW Config
 - Module catalog, 10-1

I

- I/O interface
 - DI/DO, 10-7
- Incorrect response
 - due to interference signals, 7-1
- Information
 - Device Info, 9-43
 - Devices, 9-48
 - Diagnostics, 9-43, 9-47
 - Model, 9-43, 9-46
 - Statistics, 9-43, 9-44
- initial start-up, 8-3
- Inrush current, 12-1
- Interface assignments
 - Ethernet interface, 12-8
 - Lighting unit, 12-8
 - Power supply, 12-8
 - PROFIBUS DP interface, 12-8
- Interfaces, 3-7
 - Communication, 9-25
 - Illumination control, 12-6
 - Load power supply, 12-6
 - Parameters, 9-25
 - Sensor head interface, 12-6
- Interference, 4-4
- Internet, 15-1
- IP setting, 8-8
- IP65 protective lens housing, 14-4

J

- JAVA JIT Compiler, 8-2

K

- Keypad, 3-7

L

- Language setting
 - Change, 9-22
- LCD display, 11-6
- LCD display, 3-7
- LED ring flash, 14-4
- LED ring flash, 3-8
- Linking
 - PROFIBUS DP device, 10-1
 - PROFINET IO device, 10-4
- Localization
 - of parts, 3-3

M

- MAC address, 8-9
- Main ROI, 4-8
- Maintain
 - Menu, 9-18
- Maintain, 9-49
- Menu
 - Connect, 9-2, 9-4
 - Integrate, 9-6
 - Maintain, 9-18
 - Options, 9-15
 - Output, 9-8
 - Port, 9-4
 - RUN, 9-9
- Model, 9-46
 - Information, 9-46
 - Loading, 9-49
 - Select, 9-34
 - Test, 3-3
- Model selection, 10-8
- Model set
 - Example, 4-20
 - Features, 4-19
 - Select, 9-34
- Model sets, 3-3
- Models, 9-49
 - Deleting, 9-49
 - Restoring, 9-49
 - Save, 9-49
- Module catalog
 - HW Config, 10-4
- Module fault, 10-20
- Mounting
 - LED ring flash, 6-1
 - Processing unit, 6-1
 - Sensor head, 6-1
- Mounting bracket, 13-3
- Mounting plate, 13-2

N

- Normal mode, 8-3

O

- OB86, 11-6
- Object detection, 4-6
- Online catalog, 15-1
- Operating status
 - Stop, 9-51
- Operating system, 3-5
- Operator control
 - Adjustment support, 9-1
 - Model selection, 10-19
 - Processing unit, 9-1
 - Reading and transferring result data, 10-19
 - Reset, 10-19
 - Transferring the delay time, 10-19
 - Triggering, 10-19
- Options
 - Diagn. & Monitoring, 9-42
 - Diagnostics & Monitoring, 9-37
 - Extras, 9-37, 9-43
 - Menu, 9-15
 - Security, 9-37, 9-39
 - Training, 9-37, 9-38
- Overexposure, 4-2
 - Manual, 4-4

P

- Parameters, 9-2, 10-17
 - Diagnostics, 9-16
 - Example, 4-13
 - Find, 4-13
 - Identify, 4-13
 - Image capture, 9-24
 - Image processing, 9-24
 - Integrate, 9-6
 - Light, 9-16
 - Maintain, 9-18
 - Options, 9-16
 - Output, 9-8
 - Port, 9-4
 - Precision, 4-5
- Part recognition, 9-36
- Part recognition with classification mode, 9-45
- Parts
 - Localization, 3-3
- Password, 9-41
- Performance Features, 3-2
- Pixel size, 4-8

- Power consumption, 12-1
- Power supply, 12-1
- Precision, 4-5
- Processing precision, 4-7
- Processing unit
 - Connecting manually, 8-5, 8-7
 - DHCP client, 8-5, 8-9
 - DHCP server, 8-5
 - Indicators, 11-6
 - Integrating, 8-9
 - Warnings, 11-6
- PROFIBUS DP
 - Address, 10-3
 - System configuration, 5-3
 - Transmission rate, 10-3
- PROFIBUS DP Error, 11-6
- PROFIBUS DP slave
 - Linking, 10-1
- PROFIBUS DP slaves
 - Linking, 10-1
- PROFINET IO
 - System setup, 5-4
 - Transmission rate, 10-6
- PROFINET IO device, 8-10
 - Linking, 10-4
- PROFINET IO devices
 - Linking, 10-4
- PROFINET IO Error, 11-6
- PROFINET IO network, 8-11
- Proxy
 - Configuration, 8-13
 - Server, 8-12
- Purpose
 - Manual, 1-1

Q

- Quality value, 4-10

R

- Recognition principle
 - of edges, 3-3
- Relative humidity, 12-3
- Resolution, 4-8
- ROI, 4-8, 9-29
 - Changes, 9-30
 - Colors, 9-30
 - Example, 4-9
 - Main, 9-30
 - Names, 9-30
 - Parameter assignment, 4-9
 - Sub, 9-30

- Training, 9-29
- RS232
 - System configuration, 5-6
- Run, 9-33
 - Normal mode, 9-34
- RUN
 - Menu, 9-9

S

- Save
 - Training, 9-33
- Scope of validity
 - Manual, 1-1
- Security, 9-39
 - Options, 9-39
- Selection
 - Training, 9-28
- Sensor head, 3-8
 - Adjusting, 8-17
 - Connection, 7-1
 - Degree of protection, 12-5
 - Field of vision, 12-5
 - Resolution, 12-5
- Sensor head holder, 14-4
- Server
 - Proxy, 8-12
- SFB 54, 11-13
- SFB52, 11-16
- Slave diagnostics, 11-11
- Software, 3-5
- Sorting functions, 3-3
- Specimens, 4-11
- Statistics, 9-44
 - Information, 9-44
- Status byte, 10-7
- Status LEDs, 3-6
- Stop, 9-51
- Sub-ROI, 4-8
- System components, 3-4
- System configuration, 3-4, 5-1
 - Digital I/O, 5-2
 - PROFIBUS DP, 5-3
 - with digital I/O, 5-2
 - With Ethernet, 5-5
 - with PROFINET IO:, 5-4
 - with RS-232, 5-6
- System expansion, 2-1
- System requirements, 3-5

T

- Tab

- Edges, 9-31
 - ROI, 9-29
 - Save, 9-33
 - Test, 9-32
- Technical support, 15-1
- Temperature, 12-3
- Temporary error, 11-9
- Test
 - of a model, 3-3
 - Training, 9-32
- Traffic Light, 9-21
- Training, 9-27, 9-38
 - Edges, 9-31
 - of a model, 9-27
 - Options, 9-38
 - ROI, 9-29
 - Save, 9-33
 - Selection, 9-28
 - Test, 9-32

U

- Underexposure, 4-3
- User, 9-40
- User data interface
 - Errors, 10-15
 - Faults, 10-15
- User data structure, 10-13
- User interface, 9-20
- User name, 9-23

W

- Warnings
 - Description, 11-6
 - Remedies, 11-6
- Warranty, 2-1

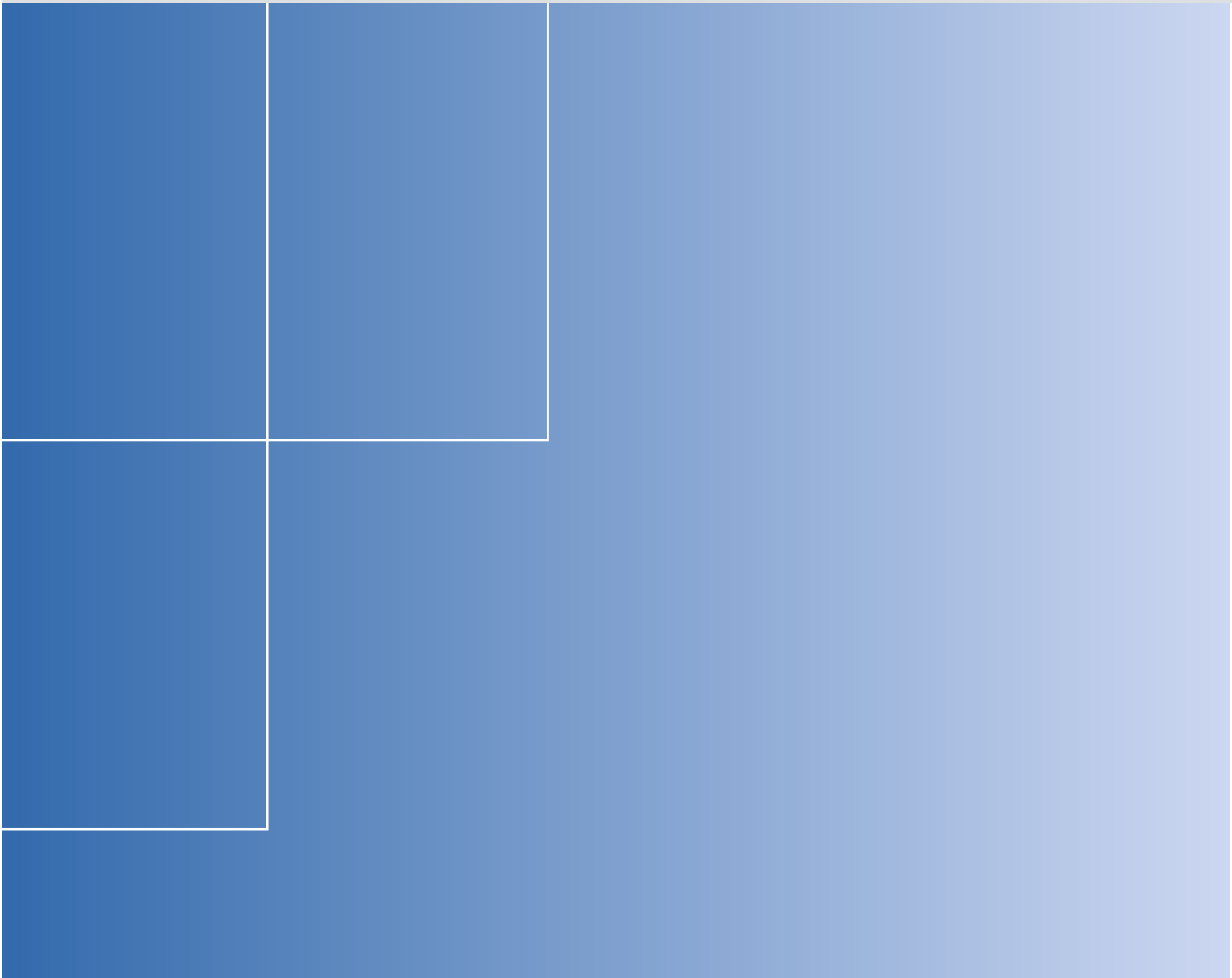

Siemens AG

Automation and Drives
Industrial Automation Systems
Postfach 4848
90437 NUERNBERG
Federal Republic of Germany

www.siemens.com/automation

ID: A5E00757507-01