

SIMATIC HMI

HMI device
TP 170micro, TP 170A, TP 170B,
OP 170B (WinCC flexible)

Operating Instructions



The following supplement is part of this documentation:

No.	Designation	Drawing number	Edition
1	Product information	A5E00702577-01	10/2005

Order number 6AV6691-1DB01-0AB0

Edition 03/2004

A5E00280550-01

Preface

Overview

1

Safety instructions and general notes

2

Planning use

3

Installation and connection

4

Operator control elements and displays

5

Operating system and configuration

6

Preparing and backing up a project

7

Runtime functionalities of a project

8

Operating a project

9

Operating recipes

10

Maintenance/Service

11

Specifications

12

Appendix

A

Abbreviations

B

Glossary

C

Safety Guidelines

This manual contains notices which you should observe to ensure your own personal safety as well as to avoid property damage. The notices referring to your personal safety are highlighted in the manual by a safety alert symbol, notices referring to property damage only have no safety alert symbol.



Danger

indicates an imminently hazardous situation which, if not avoided, will result in death or serious injury.



Warning

indicates a potentially hazardous situation which, if not avoided, could result in death or serious injury.



Caution

used with the safety alert symbol indicates a potentially hazardous situation which, if not avoided, may result in minor or moderate injury.

Caution

used without safety alert symbol indicates a potentially hazardous situation which, if not avoided, may result in property damage.

Notice

used without the safety alert symbol indicates a potential situation which, if not avoided, may result in an undesirable result or state.

When several danger levels apply, the notices of the highest level (lower number) are always displayed. If a notice refers to personal damages with the safety alert symbol, then another notice may be added warning of property damage.

Qualified Personnel

The device/system may only be set up and operated in conjunction with this documentation. Only qualified personnel should be allowed to install and work on the equipment. Qualified persons are defined as persons who are authorized to commission, to earth, and to tag circuits, equipment and systems in accordance with established safety practices and standards.

Intended Use

Please note the following:



Warning

This device and its components may only be used for the applications described in the catalog or technical description, and only in connection with devices or components from other manufacturers approved or recommended by Siemens.

This product can only function correctly and safely if it is transported, stored, set up and installed correctly, and operated and maintained as recommended.

Trademarks

All designations marked with ® are registered trademarks of Siemens AG. Other designations in this documentation might be trademarks which, if used by third parties for their purposes, might infringe upon the rights of the proprietors.

Copyright Siemens AG, 2004. All rights reserved

Reproduction, transmission or use of this document or its contents is not permitted without express written authority. Offenders will be liable for damages. All rights, including rights created by patent grant or registration of a utility model or design, are reserved.

Disclaimer of Liability

We have checked the contents of this manual for agreement with the hardware and software described. Since deviations cannot be precluded entirely, we cannot guarantee full agreement. However, the data in the manual are reviewed regularly, and any necessary corrections will be included in subsequent editions. Suggestions for improvement are welcomed.

Siemens AG
Automation and Drives Group
P.O. Box 4848, D-90327 Nuremberg (Germany)

© Siemens AG 2004
Technical data subject to change

Preface

Purpose of this manual

This manual provides information based on the requirements defined by DIN 8418 regarding mechanical engineering documentation. This information relates to the device, its place of use, transport, storage, installation, use and maintenance.

This manual is intended for the following target groups:

- Users
- Commissioning engineers
- Service technicians
- Maintenance technicians

Please read carefully the section "Safety information and general notes".

The help integrated in WinCC flexible, the WinCC flexible Information System, contains detailed information. The Information System contains instructions, examples and reference information in electronic form.

Basic knowledge required

A general knowledge of automation technology and process communication is necessary in order to understand the manual.

It is assumed users have good basic knowledge on the use of personal computers and MS Windows operating systems.

Scope of the manual

The manual applies to the SIMATIC TP 170micro, TP 170A, TP 170B and OP 170B used in connection with the WinCC flexible 2004 software packet.

Placement in the information landscape

This manual is part of the SIMATIC HMI documentation. The information below presents an overview of the information landscape of SIMATIC HMI.

User manual

- WinCC flexible Micro:
 - Describes basic principles of configuration using the WinCC flexible Micro Engineering System.
- WinCC flexible Compact/Standard/Advanced:
 - Describes basic principles of configuration using the WinCC flexible Compact Engineering System/WinCC flexible Standard/WinCC flexible Advanced
- WinCC flexible Runtime:
 - Describes how to commission and operate your Runtime project on a PC.
- WinCC flexible Migration:
 - Describes how to convert an existing ProTool project to WinCC flexible.
 - Describes how to convert an existing WinCC project to WinCC flexible.
 - Describes the conversion of ProTool projects together with changing the HMI device from OP7 to OP 77B.
 - Describes the conversion of ProTool projects with a change in the HMI device from a graphics device to a Windows CE device.
- Communication:
 - Communication Part 1 describes the connection of the HMI device to SIMATIC PLCs.
 - Communication Part 2 describes the connection of the HMI device to third-party PLCs.

Operating instructions

- Operating instructions for the SIMATIC OP 77B, TP 170micro/TP 170A/TP 170B/OP 170B, SIMATIC Mobile Panel 170, SIMATIC TP 270/OP 270/MP 270B, and SIMATIC MP 370 HMI devices.
- Quick reference manuals for the SIMATIC OP 77B and SIMATIC Mobile Panel 170 HMI devices.

Getting started

- WinCC flexible for first time users:
 - Based on a sample project, this is a step-by-step introduction to the basics of configuring screens, alarms, and recipes, and screen navigation.
- WinCC flexible for advanced users:
 - Based on a sample project, this is a step-by-step introduction to the basics of configuring logs, project reports, scripts, user management, and multilingual projects, and integration into STEP 7.
- WinCC flexible options:
 - Based on a sample project, this is a step-by-step introduction to the basics of configuring the WinCC flexible Sm@rtServices, Sm@rtAccess and OPC Server options.

Online availability

The following links provide direct access to technical documentation on SIMATIC products and systems in English, German, French, Italian, and Spanish.

- SIMATIC Guide Technische Dokumentation in Deutsch:
http://www.ad.siemens.de/simatic/portal/html_00/techdoku.htm
- SIMATIC Guide for Technical Documentation in English:
http://www.ad.siemens.de/simatic/portal/html_76/techdoku.htm

Conventions

The following applies with regard to the designation of the configuration and runtime software:

- "WinCC flexible 2004" refers to the configuration software.
- "Runtime" designates the runtime software which can run on the HMI device. The term "runtime" is also used during operation for projects on MS Windows CE HMI devices.
- "WinCC flexible Runtime" designates the visualization product for use on standard PCs or panel PCs.

The term "WinCC flexible" is used in the general context. A version name such as "WinCC flexible 2004" is used whenever it is necessary to distinguish it from other versions.

The following formatting is used to facilitate reading of the manual:

Notation	Scope
"Add screen"	<ul style="list-style-type: none"> • Terminology that occurs in the user interface, e.g., dialog names, tabs, buttons, menu commands. • Inputs required, e.g., limit values, tag values. • Path information
"File > Edit"	Operational sequences, e.g., menu commands/shortcut menu commands.
<F1>, <Alt+P>	Keyboard inputs

Please observe notes labeled as follows:

Note

A note contains important information about the product, about the handling of the product, or about a specific section of the documentation to which particular attention should be paid.

Registered trademarks

All names designated with an ® are registered trademarks of Siemens AG.

HMI®
SIMATIC®
SIMATIC HMI®
SIMATIC ProTool®
SIMATIC WinCC®
SIMATIC WinCC flexible®
SIMATIC TP 170micro®
SIMATIC TP 170A®
SIMATIC TP 170B®
SIMATIC OP 170B®

The other designations in this manual may be trademarks whose use by third parties for their own purposes could violate the rights of the owner.

Representatives and offices

If you have any further questions relating to the products described in this manual, please contact your local representative at the SIEMENS branch nearest you.

Your local representative can be found under:

<http://www.siemens.com/automation/partner>

Training center

To familiarize you with automation systems, we offer a variety of courses. Please contact your regional training center, or the central training center in D-90327 Nuremberg.

Phone: +49 (911) 895-3200

Internet: <http://www.sitrain.com>

Service & support in the Internet

Service & Support offers comprehensive information on SIMATIC products online at "<http://www.siemens.com/automation/service&support>":

- The newsletter keeps you up-to-date with information relating to your products.
- Our Service & Support search engine provides you with abundant documentation.
- A bulletin board where users and experts exchange their knowledge worldwide.
- Current product information, FAQs and downloads.
- Your local contact for Automation & Drives.
- Information about on-site services, repairs, spare parts and much more is available on our "Services" pages.

A&D Technical Support and Authorization

Available 24 hours worldwide:

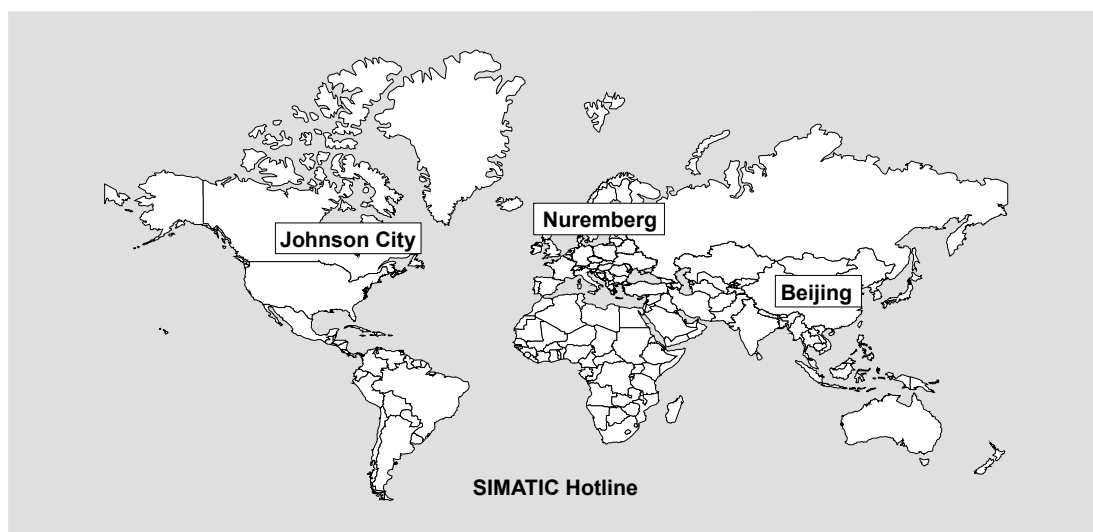

Worldwide (Nuremberg)

Technical Support (Free Contact)

Local time:
Mo.–Fr. 7:00 to 17:00

Telephone:
+49 (0) 180 5050-222

Fax:
+49 (0) 180 5050-223

E-Mail:
adsupport@siemens.com

GMT: +1:00

Worldwide (Nuremberg)

Technical Support (fee-based, only with Automation Value Card)

Local time:
0:00 to 24:00, 365 days

Telephone:
+49 (911) 895 -7777

Fax:
+49 (911) 895-7001

E-mail: –

GMT: +1:00

Europe/Africa (Nuremberg)

Authorization

Local time:
Mo.–Fr. 7:00 to 17:00

Telephone:
+49 (911) 895-7200

Fax:
+49 (911) 895-7201

E-Mail:
adauthorisierung@siemens.com

GMT: +1:00

America (Johnson City)

Technical Support and Authorization

Local time:
Mon.–Fri. 8:00 a.m. to 7:00 p.m.

Telephone:
+1 423 461-2522

Fax:
+1 423 461-2289

E-Mail:
simatic.hotline@sea.siemens.com

GMT: –5:00

Asia/Pacific (Beijing)

Technical Support and Authorization

Local time:
Mon.–Fri. 8:30 a.m. to 5:30 p.m.

Telephone:
+86 (10) 64 75 75 75

Fax:
+86 (10) 64 74 74 74

E-mail:
adsupport.asia@siemens.com

GMT: +8:00

Information is available in German and English.

Table of contents

	Preface	i
1	Overview.....	1-1
1.1	Design of the TP 170micro HMI device	1-1
1.2	Design of the TP 170A HMI device.....	1-2
1.3	Design of the TP 170B HMI device.....	1-3
1.4	Design of the OP 170B HMI device	1-4
1.5	Accessories.....	1-6
1.6	Miscellaneous	1-6
1.7	Functional scope of WinCC flexible on TP 170micro and TP 170A	1-7
1.8	Functional scope of WinCC flexible on TP 170B and OP 170B	1-9
1.9	Communication using TP 170micro.....	1-11
1.10	Communication using the TP 170A, TP 170B and OP 170B	1-11
2	Safety instructions and general notes.....	2-1
2.1	Safety instructions.....	2-1
2.2	General notes.....	2-2
3	Planning use.....	3-1
3.1	Installation notes	3-1
3.2	Installation position and fixation	3-2
3.3	Installation cut-out.....	3-4
3.4	Transport.....	3-8
4	Installation and connection	4-1
4.1	Checking the shipment	4-1
4.2	Installation of the HMI device.....	4-1
4.3	Connecting the HMI device.....	4-3
4.3.1	Interfaces on the TP 170micro, TP 170A and TP 170B	4-4
4.3.2	Interfaces on the OP 170B.....	4-5
4.3.3	Connecting the lines	4-5
4.3.4	Connecting the equipotential bonding	4-5
4.3.5	Connecting the PLC.....	4-8
4.3.6	Connecting the configuration computer.....	4-12
4.3.7	Connecting a TP 170B or OP 170B to peripheral equipment.....	4-14
4.3.8	Connecting the power supply.....	4-15
4.3.9	Switch on and test the HMI device.....	4-17

5	Operator control elements and displays.....	5-1
5.1	Operating elements and indicators on the front of the TP 170micro, TP 170A and TP 170B ...	5-1
5.2	Other operator controls on the TP 170A and TP 170B.....	5-2
5.2.1	Using the memory card with the TP 170B	5-2
5.2.2	Unplugging the memory card.....	5-3
5.2.3	Setting the DIL switch	5-3
5.3	Front side operating elements and indicators on the OP 170B	5-4
5.4	Other operating elements on the OP 170B.....	5-5
5.4.1	Using the memory card with the OP 170B.....	5-6
5.4.2	Labeling the OP 170B softkeys.....	5-7
5.4.3	Setting the DIL switch	5-9
6	Operating system and configuration	6-1
6.1	Configuring the TP 170micro and TP 170A operating system.....	6-1
6.1.1	Operating by touch.....	6-2
6.1.2	"Control Settings" dialog	6-3
6.2	Configuring the operating system for TP 170B and OP 170B	6-5
6.2.1	Operating by touch.....	6-6
6.2.2	Navigating and operating	6-6
6.2.2.1	Operating and navigating in Control Panel	6-7
6.2.2.2	Operating and navigating in a dialog	6-10
6.2.3	Backup/Restore.....	6-13
6.2.4	Communications Properties	6-14
6.2.5	Date/Time.....	6-15
6.2.6	InputPanel	6-16
6.2.7	Keyboard.....	6-20
6.2.8	Mouse.....	6-21
6.2.9	OP	6-23
6.2.10	Password	6-26
6.2.11	Printer.....	6-28
6.2.12	Regional Settings.....	6-30
6.2.13	Screen Saver	6-33
6.2.14	System	6-34
6.3	Touchscreen calibration.....	6-35
6.4	Configuring transfer mode for the TP 170A	6-37
6.5	Configuring transfer mode for the TP 170B and OP 170B	6-40
6.5.1	S7-Transfer Settings	6-40
6.5.2	Transfer	6-42
6.6	Runtime.....	6-45
7	Preparing and backing up a project	7-1
7.1	Transferring a project to an HMI device.....	7-1
7.1.1	Overview	7-1
7.1.2	Initial commissioning.....	7-2
7.1.3	Recommissioning.....	7-3
7.1.4	Setting the operating mode.....	7-3
7.2	Transfer	7-4
7.2.1	Information and overview.....	7-4
7.2.2	Start transfer	7-6
7.2.3	Testing project.....	7-8
7.2.4	Transferring a project back using the TP 170B and OP 170B.....	7-10

7.3	Backup and restore project for TP 170B and OP 170B on memory card.....	7-12
7.3.1	Overview	7-12
7.3.2	Backup and restore project	7-13
7.4	ProSave	7-15
7.4.1	Overview	7-15
7.4.2	Backup project	7-16
7.4.3	Restore project.....	7-18
7.4.4	Updating the operating system	7-19
8	Runtime functionalities of a project	8-1
8.1	Screen objects	8-1
8.2	Alarms	8-2
8.3	Tags	8-3
8.4	System functions.....	8-3
8.5	Safety	8-4
8.6	Other operating functions.....	8-7
9	Operating a project	9-1
9.1	Basic principles of operation	9-1
9.1.1	Basics for operation in Runtime	9-1
9.1.2	Operating the touch screen device	9-3
9.1.2.1	Operating touch objects	9-3
9.1.2.2	Input of values.....	9-4
9.1.2.3	Inputting numeric values	9-5
9.1.2.4	Inputting alphanumeric values	9-6
9.1.2.5	Opening an operator note (TP 170B and OP 170B only)	9-7
9.1.3	Operating a keyboard device	9-8
9.1.3.1	Functions of the system keys.....	9-8
9.1.3.2	Functions of the key combinations.....	9-9
9.1.3.3	Calling the operator note.....	9-11
9.1.4	Close the project.	9-12
9.2	Operating graphic objects	9-12
9.2.1	Button	9-12
9.2.1.1	Description	9-12
9.2.1.2	Touch control	9-13
9.2.1.3	Keyboard control	9-13
9.2.2	Switch.....	9-13
9.2.2.1	Description	9-13
9.2.2.2	Touch control	9-14
9.2.2.3	Keyboard control	9-14
9.2.3	IO field	9-14
9.2.3.1	Description	9-14
9.2.3.2	Touch control	9-15
9.2.3.3	Keyboard control	9-15
9.2.4	Graphic IO field	9-16
9.2.4.1	Description	9-16
9.2.4.2	Touch control	9-17
9.2.4.3	Keyboard control	9-17
9.2.5	Symbolic IO field	9-18
9.2.5.1	Description	9-18
9.2.5.2	Touch control	9-18
9.2.5.3	Keyboard control	9-19
9.2.6	Alarm indicator (TP 170B and OP 170B only)	9-19

9.2.6.1	Description	9-19
9.2.6.2	Touch control	9-20
9.2.7	Alarm view (TP 170B and OP 170B only).....	9-20
9.2.7.1	Description	9-20
9.2.7.2	Touch control	9-21
9.2.7.3	Keyboard control.....	9-21
9.2.8	Simple alarm view	9-22
9.2.8.1	Description	9-22
9.2.8.2	Touch control	9-23
9.2.8.3	Keyboard control.....	9-23
9.2.9	Bar	9-24
9.2.10	Trend view (TP 170B and OP 170B only).....	9-25
9.2.10.1	Description	9-25
9.2.10.2	Touch control	9-26
9.2.10.3	Keyboard control.....	9-26
9.2.11	Date/time field	9-27
9.2.11.1	Description	9-27
9.2.11.2	Touch control	9-27
9.2.11.3	Keyboard control.....	9-28
9.2.12	User view (TP 170B and OP 170B only).....	9-28
9.2.12.1	Description	9-28
9.2.12.2	Touch control	9-29
9.2.12.3	Keyboard control.....	9-30
9.2.13	Simple user view (TP 170B and OP 170B only).....	9-30
9.2.13.1	Description	9-30
9.2.13.2	Touch control	9-31
9.2.13.3	Keyboard control.....	9-31
10	Operating recipes	10-1
10.1	Structure of a recipe.....	10-1
10.2	Structure of a recipe data record	10-2
10.3	Recipe in the project	10-3
10.4	Display recipes.....	10-5
10.4.1	Display and edit recipe.....	10-5
10.4.2	Behavior of the recipe view.....	10-7
10.5	Recipe view (TP 170B and OP 170B only).....	10-7
10.5.1	Description	10-7
10.5.2	Touch control	10-8
10.5.3	Keyboard control.....	10-9
10.6	Simple recipe view (TP 170B and OP 170B only).....	10-10
10.6.1	Description	10-10
10.6.2	Touch control	10-11
10.6.3	Keyboard control.....	10-11
10.7	Operating recipe data record	10-12
10.7.1	Recipe data record administration	10-12
10.7.2	Synchronizing a recipe data record	10-14
10.7.3	Read recipe data record from PLC	10-14
10.7.4	Transfer recipe record to PLC.....	10-15
10.7.5	Exporting and importing recipe data records	10-15

11	Maintenance/Service	11-1
11.1	Maintenance and service	11-1
11.1.1	Clean screen	11-2
11.1.2	Protective foil and protective cover	11-2
11.2	Servicing and spare parts	11-6
12	Specifications	12-1
12.1	Dimensioned drawings of the TP 170micro, TP 170A and TP 170B.....	12-1
12.2	Dimensioned drawings of the OP 170B.....	12-2
12.3	Technical data, TP 170micro, TP 170A and TP 170B.....	12-2
12.4	Technical data, OP 170B.....	12-4
12.5	Ambient conditions.....	12-5
12.6	EMC requirements	12-7
12.7	Description of interfaces	12-8
12.7.1	Power supply.....	12-8
12.7.2	RS 422/RS 485 (IF 1B).....	12-8
12.7.3	RS 232 (IF 1A)	12-9
12.7.4	RS 232 (IF 2).....	12-9
A	Appendix.....	A-1
A.1	Certificates and guidelines.....	A-1
A.1.1	Approvals	A-1
A.1.2	ESD guidelines	A-2
A.2	System alarms	A-4
B	Abbreviations.....	B-1
C	Glossary	C-1
	Index	

Tables

Table 1-1	Functional scope of alarms using TP 170micro and TP 170A.....	1-7
Table 1-2	Functional scope of tags, values, lists and calculation functions using the TP 170micro and TP 170A.....	1-7
Table 1-3	Functional scope of screens using TP 170micro and TP 170A.....	1-8
Table 1-4	Functional scope of supplementary functions using TP 170micro and TP 170A	1-8
Table 1-5	Functional scope of alarms using TP 170B and OP 170B.....	1-9
Table 1-6	Functional scope of tags, values, lists and calculation functions using the TP 170B and OP 170B.....	1-9
Table 1-7	Functional scope of screens and recipes using TP 170B and OP 170B	1-10
Table 1-8	Functional scope of operator notes using TP 170B and OP 170B	1-10
Table 1-9	Additional functions using TP 170B and OP 170B	1-10
Table 1-10	Number of connectable PLCs	1-11
Table 1-11	Connectable Siemens PLCs and available profiles	1-11
Table 1-12	Number of connectable PLCs	1-11
Table 1-13	Connectable Siemens PLCs and available reports or profiles.....	1-11
Table 1-14	Connectable PLCs from other manufacturers and protocols for use.....	1-12
Table 4-1	DIL switch settings on the TP 170A, TP 170B and OP 170B	4-11
Table 6-1	Keys for navigating in the Control Panel at the OP 170B	6-8
Table 6-2	Keys for the navigation in a dialog of the "Control Panel" using the OP 170B	6-11
Table 12-1	Permissible ambient conditions	12-5
Table 12-2	Permissible mechanical ambient conditions	12-6
Table 12-3	Testing mechanical ambient conditions	12-6
Table A-1	HMI device approvals.....	A-1

Overview

1.1 Design of the TP 170micro HMI device

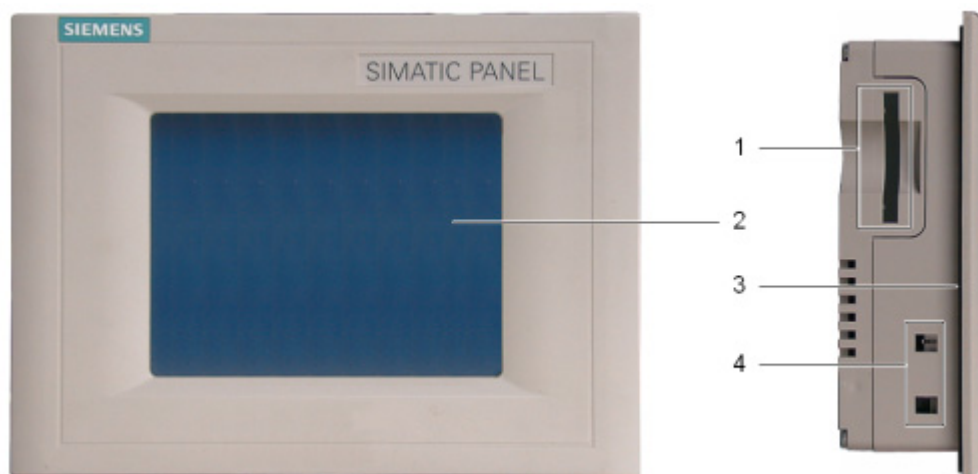

Figure 1-1 Front view and side view

- 1 Construction-related opening – not a slot for a memory card
- 2 Display / Touchscreen
- 3 Installation seal
- 4 Recess for spring terminal

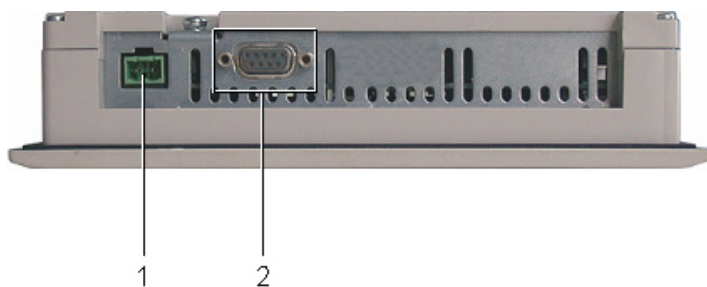

Figure 1-2 Bottom view

- 1 Connection for the power supply
- 2 Data interface

1.2 Design of the TP 170A HMI device

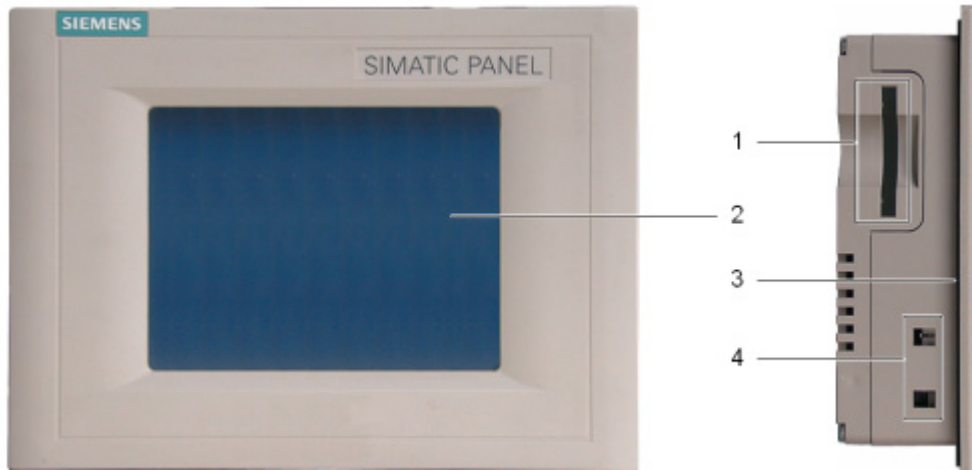

Figure 1-3 Front view and side view

- 1 Construction-related opening – not a slot for a memory card
- 2 Display / Touchscreen
- 3 Installation seal
- 4 Recess for spring terminal

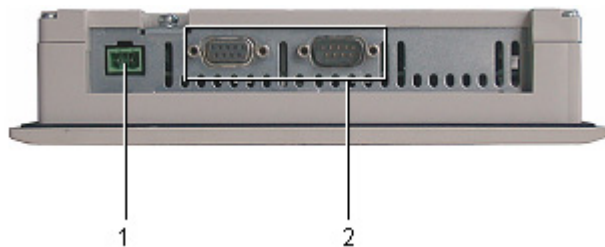

Figure 1-4 Bottom view

- 1 Connection for the power supply
- 2 Data interfaces

1.3 Design of the TP 170B HMI device

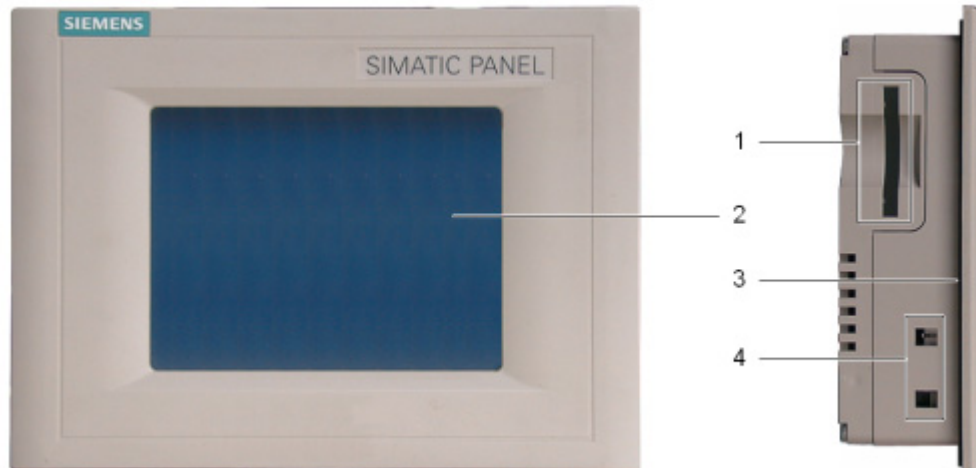

Figure 1-5 Front view and side view

- 1 Memory card slot for a CF card
- 2 Display / Touchscreen
- 3 Installation seal
- 4 Recess for spring terminal

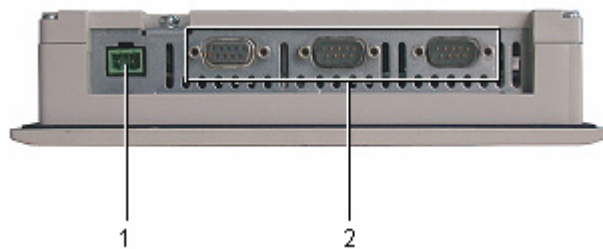

Figure 1-6 Bottom view

- 1 Connection for the power supply
- 2 Data interfaces

1.4 Design of the OP 170B HMI device

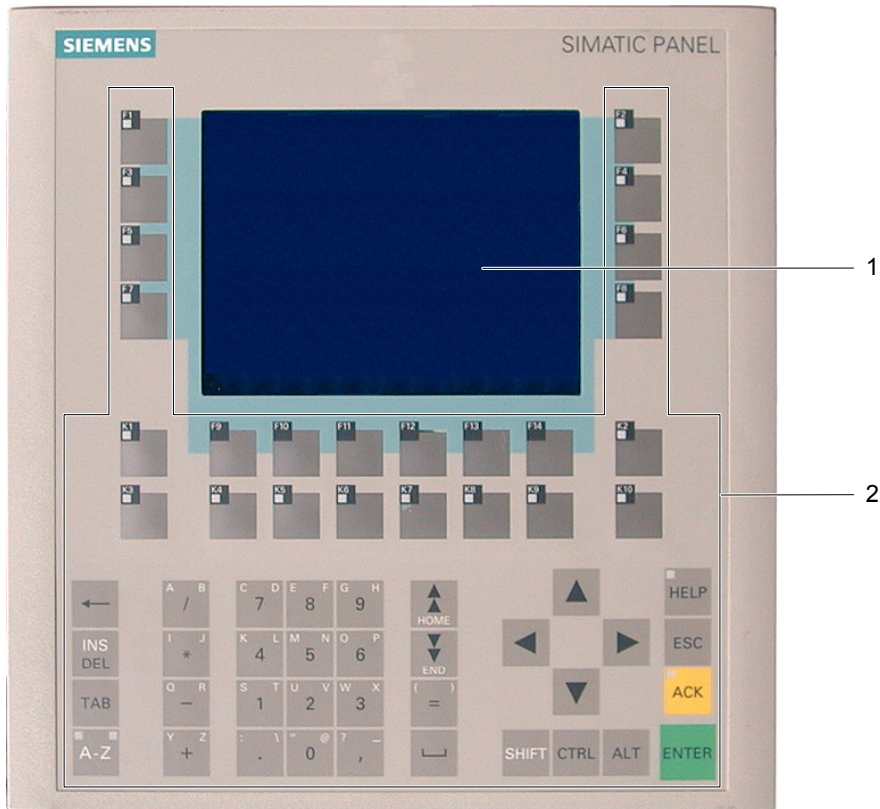

Figure 1-7 Front view

- 1 Display
- 2 Membrane keyboard

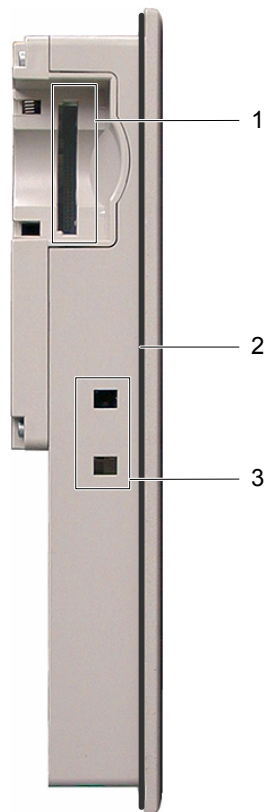

Figure 1-8 Side view

- 1 Memory card slot for a CF card
- 2 Installation seal
- 3 Recess for spring terminal

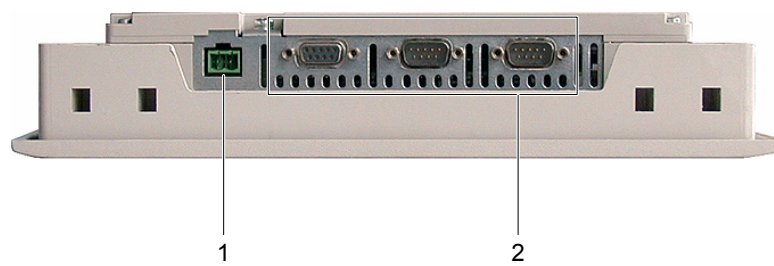

Figure 1-9 Bottom view

- 1 Connection for the power supply
- 2 Data interfaces

1.5 Accessories

Accessory kit

The accessory kit contains the following:

- A terminal block for the power supply
- Four spring terminals for installing the TP 170micro, TP 170A and TP 170B
- Six spring terminals for installing an OP 170B

Memory card

For the TP 170B and OP 170B:

The memory card is an option.

A commercially available CF memory card (Compact Flash, Type 1) can be used as an external storage medium. A CF card which has been tested and approved is available from Siemens AG.

1.6 Miscellaneous

PC-PPI adapter

For TP 170micro:

To enable RS 485/RS 232 switching, the PC-PPI adapter, Order No.: 6ES7 901-3CB30-0XA0, can be ordered from Siemens AG.

Protective foil and protective cover

A protective foil is available for the HMI devices TP 170micro, TP 170A and TP 170B, order no.: 6AV6 574-1AD00-4AX0 and a protective cover, order no.: 6AV6 574-1AE00-4AX0 available.

Labeling strips

For the OP 170B:

Labeling strips are available as an optional accessory. They can also be made from a supplied template. The template is available for use after installing WinCC flexible on the installation computer and on the "WinCC flexible" installation CD under ...Documents\slide170b.doc.

See also

Labeling the OP 170B softkeys (Page 5-7)

1.7 Functional scope of WinCC flexible on TP 170micro and TP 170A

General

The following tables show the objects which can be integrated in a project for a TP 170micro and TP 170A. Each object is categorized according to the maximum number the HMI device can manage or its method of operation.

Alarms

Table 1-1 Functional scope of alarms using TP 170micro and TP 170A

Object	Specification	TP 170micro	TP 170A
Alarm	Number of discrete alarms	500	1000
	Length of alarm text per line	80	
	Number of tags in an alarm	8	
	Display	Alarm view, alarm window	
	View all pending alarms	Alarm view	
	Acknowledge single error alarms	Yes	
	Acknowledge several error alarms simultaneously (group acknowledgement)	Yes	
	Edit alarm	Yes	
ALARM_S	Display S7 alarms	No	
Volatile alarm buffer	Alarm buffer capacity	128 alarm events	
	Simultaneously queued alarm events	Max.16	
	View alarm	Yes	
	Delete alarm	Yes	

Tags, values, lists and calculation functions

Table 1-2 Functional scope of tags, values, lists and calculation functions using the TP 170micro and TP 170A

Object	Specification	TP 170micro	TP 170A
Tag	Number ¹⁾	250	500
Limit-value monitoring	Input/output	Yes	

- 1) Maximum total number for PowerTags and internal tags

Screens

Table 1-3 Functional scope of screens using TP 170micro and TP 170A

Object	Specification	TP 170micro	TP 170A
Screen	Number	250	
	Fields per screen	20	
	Tags per screen	20	
	Complex objects per screen (e.g. bars)	5	
	Templates	Yes	

The functional scope is also restricted by the size of the internal Flash memory.

Additional functions

Table 1-4 Functional scope of supplementary functions using TP 170micro and TP 170A

Object	Specification	TP 170micro	TP 170A
Display settings	Contrast	Yes	
	Touchscreen calibration	Yes	
Language switching	Number of languages	5	
Trend	Number	No	
Graphic object	Number	500	1000
Text object	Number	500	1000
Password protection	Number of passwords	1	
Scheduler	Trigger functions cyclically or once	No	

1.8 Functional scope of WinCC flexible on TP 170B and OP 170B

General

The following tables contain objects that can be integrated in a project for a TP 170B and OP 170B. Each object is specified according to the maximum number the TP 170B or the OP 170B can manage or its method of operation.

Alarms

Table 1-5 Functional scope of alarms using TP 170B and OP 170B

Object	Specification	TP 170B	OP 170B
Alarm	Number of discrete alarms	2000	
	Number of analog alarms	50	
	Length of alarm text per line	80	
	Number of tags in an alarm	8	
	Display	Alarm view, alarm window	
	View all pending alarms	Alarm view	
	Acknowledge single error alarms	Yes	
	Acknowledge several error alarms simultaneously (group acknowledgement)	16 acknowledgment groups	
	Edit alarm	Yes	
ALARM_S	Display S7 alarms	Yes	
Alarm reporting	Output to printer	Yes	
Volatile alarm buffer	Alarm buffer capacity	256 alarms	
	Simultaneously queued alarm events	max. 64	
	View alarm	Yes	
	Delete alarm	Yes	
	Print alarm line by line	Yes	

Tags, values, lists and calculation functions

Table 1-6 Functional scope of tags, values, lists and calculation functions using the TP 170B and OP 170B

Object	Specification	TP 170B	OP 170B
Tag	Number ¹⁾	1000	
Limit-value monitoring	Input/output	Yes	
Conversion functions	Input/output	Yes	

- 1) Maximum total number for PowerTags and internal tags

Screens and recipes

Table 1-7 Functional scope of screens and recipes using TP 170B and OP 170B

Object	Specification	TP 170B	OP 170B
Screen	Number	500	
	Fields per screen	50	
	Tags per screen	50	
	Complex objects per screen (e.g. bars)	5	
	Display screen	Yes	
	Print screen as hard copy	Yes	
	Templates	Yes	
Recipe	Number	100	
	Data records per recipe	200	
	Entries per recipe	200	

The functional scope is restricted by the size of the internal Flash memory. In the case of recipes, the number of data records can be increased by using a memory card.

Operator note

Table 1-8 Functional scope of operator notes using TP 170B and OP 170B

Object	Specification	TP 170B	OP 170B
Operator note	Lines/characters	7/35 using font "Tahoma"	
	For alarms	Yes	
	For screens	Yes	
	For screen objects (e.g. buttons)	Yes	

Additional functions

Table 1-9 Additional functions using TP 170B and OP 170B

Object	Specification	TP 170B	OP 170B
Display settings	Contrast	Yes	
	Touchscreen calibration	Yes	No
Language switching	Number of languages	5	
Trend	Number	50	
Graphic object	Number	1000	
Text object	Number	2500	
Password protection	Number of passwords	50	
Scheduler	Trigger functions cyclically or once	10	

1.9 Communication using TP 170micro

A certain number of PLCs can be connected to the HMI device.

Table 1-10 Number of connectable PLCs

Connectable controllers	TP 170micro
Number using a point-to-point connection	1

The HMI device can be connected to the following PLC families.

Table 1-11 Connectable Siemens PLCs and available profiles

Controller	Profile
SIMATIC S7-200	<ul style="list-style-type: none"> • PPI • MPI

1.10 Communication using the TP 170A, TP 170B and OP 170B

A certain number of PLCs can be connected to the HMI device.

Table 1-12 Number of connectable PLCs

Connectable controllers	TP 170A	TP 170B	OP 170B
Number using a point-to-point connection	1		
Number using a bus connection	4 on the same bus		

The following tables list the PLC families that can be connected to the HMI device.

Table 1-13 Connectable Siemens PLCs and available reports or profiles

Controller	Report/Profile	TP 170A	TP 170B	OP 170B
SIMATIC S5	AS 511 via converter ¹⁾	Yes	Yes	Yes
	PROFIBUS DP up to 12 Mbaud	No	Yes	Yes
	PROFIBUS DP up to 1,5 Mbaud	No	Yes	Yes
SIMATIC S7-200	PPI	Yes	Yes	Yes
	MPI	Yes	Yes	Yes
	PROFIBUS DP CPU 215	Yes	Yes	Yes
	PROFIBUS DP standard	Yes	Yes	Yes
SIMATIC S7-300/400	MPI	Yes	Yes	Yes
	PROFIBUS DP up to 12 Mbaud	No	Yes	Yes
	PROFIBUS DP up to 1,5 Mbaud	Yes	Yes	Yes
SIMATIC 500/505	NITP	Yes	Yes	Yes
	PROFIBUS DP up to 12 Mbaud	No	Yes	Yes

1) The converter is optional.

Table 1-14 Connectable PLCs from other manufacturers and protocols for use

Controller	Protocol
Allen-Bradley PLC series SLC500, SLC501, SLC502, SLC503, SLC504, SLC505, MicroLogix	<ul style="list-style-type: none"> • DF1 • DH+ using DF1-Gateway • DH485 using DF1 Gateway • DH485
Allen-Bradley PLC series PLC5/20	<ul style="list-style-type: none"> • DF1 • DH+ using DF1-Gateway
GE Fanuc Automation PLC series 90-30, 90-70, 90-Micro	SNP
LG Industrial Systems (Lucky Goldstar)/IMO PLC series GLOFA-GM/G4, G6, G7M	Dedicated communication
Mitsubishi Electric PLC series MELSEC FX, MELSEC FX0	FX
Mitsubishi Melsec PLC series FX, A, Ans, Q, QnAS	Protocol 4
OMRON PLC series SYSMAC C, SYSMAC CV, SYSMAC CS1, SYSMAC alpha, CP	Hostlink/Multilink (SYSMAC Way)
Schneider Automation (Modicon) PLC series Modicon 984, TSX Quantum, TSX Compact	Modicon Modbus

Safety instructions and general notes

2.1 Safety instructions

Work on the cabinet



Warning**Danger, high voltage**

Opening the cabinet will expose high voltage parts. Contact with these parts could be fatal.

Switch off the power supply to the cabinet before opening it.

High frequency radiation

Notice**Exceptional operating situations**

High frequency emissions, from mobile phones for example, can cause exceptional operating situations.

2.2 General notes

Industrial use

The HMI device is designed for industrial use. The following standards are met:

- Requirements for emitted interference in EN 61000-6-4: 2001
- Requirements for noise immunity in EN 61000-6-2: 2001

Residential use

If the HMI device is used in a residential area, you must take measures to achieve limit class B in accordance with EN 55011 for radio interference emissions.

Suitable measures to achieve limit class B for suppression of radio interference include:

- Installation of the HMI device in a grounded control cabinet
- Use of filters in electrical supply lines

Planning use

3.1 Installation notes

Electromagnetic compatibility

The HMI device fulfills the requirements stipulated in the EMC law of the Federal Republic of Germany as well as the EMC guidelines of the European Union.

Installation in grounded metal cabinets, e.g. 8 MC cabinet complying to Siemens catalog NV21, ensures compliance to EN 61000-4-2.

Further information on EMC requirements can be found under "EMC requirements".

Installing HMI devices conform to EMC requirements

Conditions for error-free operation include a PLC design that conforms to EMC requirements and the use of interference-proof cables. The "guidelines for interference-free construction of PLCs" and the "PROFIBUS network" manual apply for the installation of the HMI device.

Conditions for use

The HMI device is intended for installation in weatherproof, permanent locations. The conditions under which the device can be used exceed the requirements set out in DIN IEC 60721-3-3:

- Class 3M3 (mechanical requirements)
- Class 3K3 (climatic requirements)

Use with additional measures

Examples of applications where the use of the HMI device requires additional measures are:

- In locations with a high degree of ionizing radiation
- In locations with extreme operating conditions resulting from situations such as the following:
 - Corrosive vapors or gases
 - Strong electric or magnetic fields
- In systems which require special monitoring facilities - e.g.:
 - elevator systems
 - In particularly hazardous locations

The HMI device may be installed in a cabinet as an additional measure.

Note

Protective cover

The protective cover provides protection against dust, splashing water and corrosive vapors.

See also

EMC requirements (Page 12-7)

3.2 Installation position and fixation

Installation position

The HMI device is designed for installation in racks, cabinets, front panels and consoles. In the following, all the installation options are referred to by the general term "cabinet".

The HMI device is self-ventilated and approved for vertical and inclined installation in stationary cabinets.

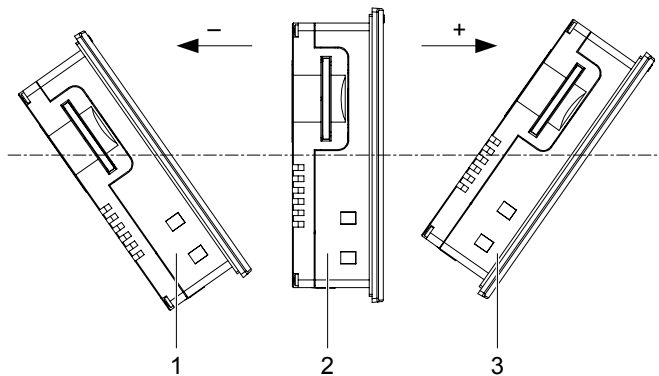

Figure 3-1 Installation locations of the TP 170micro, TP 170A and TP 170B

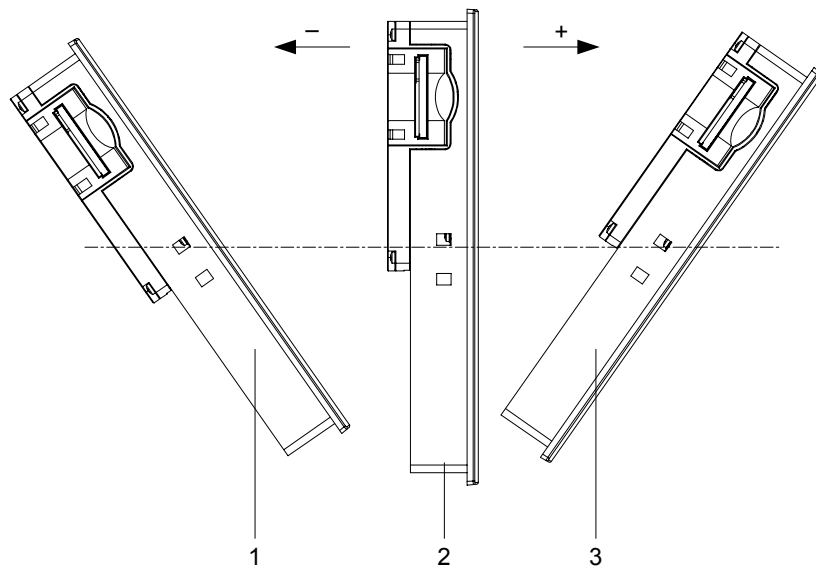

Figure 3-2 Installation locations of the OP 170B

Installation position	Max. permissible ambient temperature
1 Max. -35° installation angle	40 °C
2 vertical	50 °C
3 Max. $+35^{\circ}$ installation angle	40 °C

If the device is installed horizontally and the permissible ambient temperature is exceeded, external ventilation is necessary. In general, ambient temperatures in excess of 50 °C are not permitted.

Caution

If the HMI device is operated above the maximum permissible ambient temperature without external ventilation, the HMI device could be damaged. All the approvals stipulated in the "Approvals" section become void and the terms of warranty are annulled.

Type of fixation

Spring terminals are provided for the installation. These must be hooked into the recesses in the HMI device. The overall HMI device dimensions are not exceeded by this.

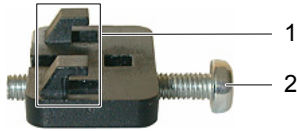

Figure 3-3 View of a spring terminal

- 1 Hook
- 2 Recessed head screw

3.3 Installation cut-out

Consider the following when selecting the installation location:

- The ambient conditions of the installation location must comply to those specified in the section "Ambient conditions".
- The requirements, based on EMC laws and EMC guidelines, must be fulfilled by the installation location.



Danger

Installation location

Not every installation location can be selected without any additional measures. Some installation locations will require additional measures be taken during installation.

Notice

If the HMI device will be exposed to vibration and impacts exceeding the ratings in the specifications, appropriate measures must be taken, for example, installation of shock absorbers.

Selecting installation location

Caution

The HMI device is only approved for operation in closed enclosures.

Observe the following when selecting the location for the installation cut-out:

- Position the HMI device so that the display is not exposed to direct sunlight or other sources of light.
- Position the HMI device so that it is ergonomically favorable for the user. For example, select a suitable installation height.
- Ensure the air vents are not covered following installation.
- Ensure sufficient air flow around the HMI device.
- Observe the permissible installation position when installing the HMI device.

Producing the installation cut-out

Caution

The system's ability to be waterproof and dustproof as per the section "Approvals" is only guaranteed when the following are met:

- Material thickness of installation cut-out: 2 to 6 mm
 - Deviation of the installation cut-out from the horizontal based on the overall dimensions of the HMI device: ≤ 0.5 mm
 - Permissible surface roughness in the area of the seal: ≤ 120 μm ($R_z 120$)
-

The required installation cut-out is illustrated in the following diagram:

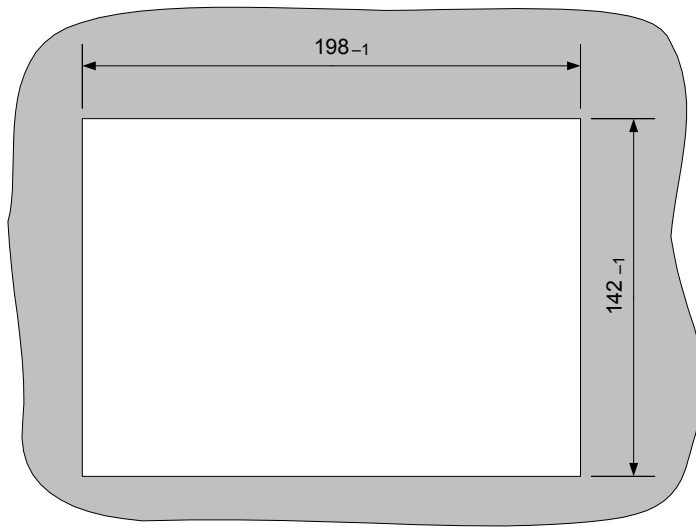

Figure 3-4 Installation cut-out for the TP 170micro, TP 170A and TP 170B

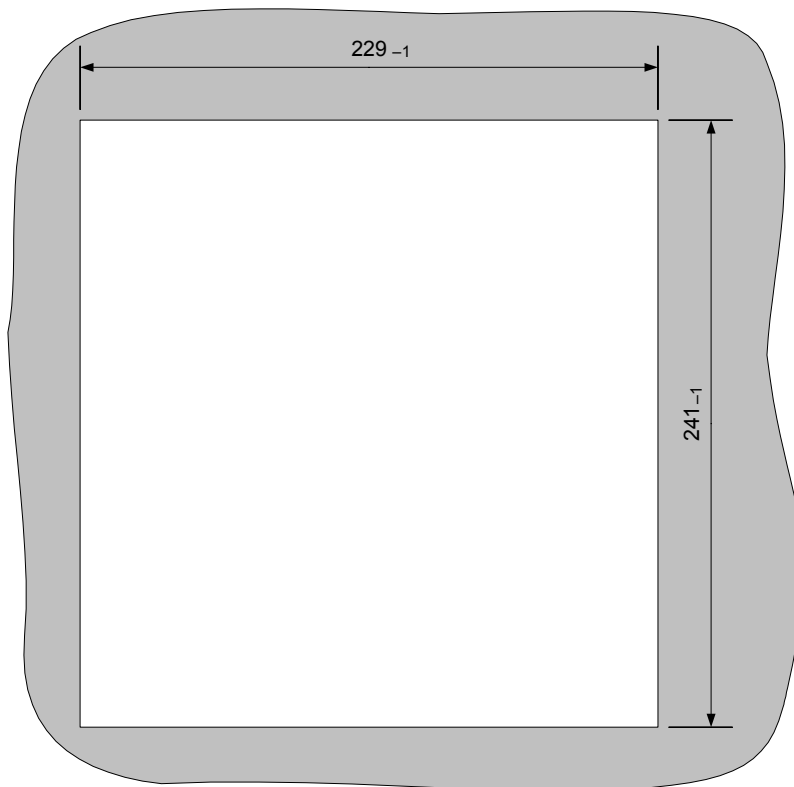

Figure 3-5 Installation cut-out for the OP 170B

Space

The HMI device must have sufficient space surrounding it:

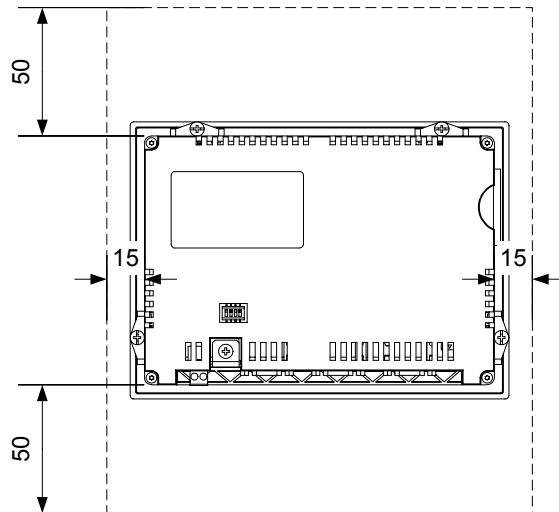

Figure 3-6 Space around the TP 170micro and TP 170A

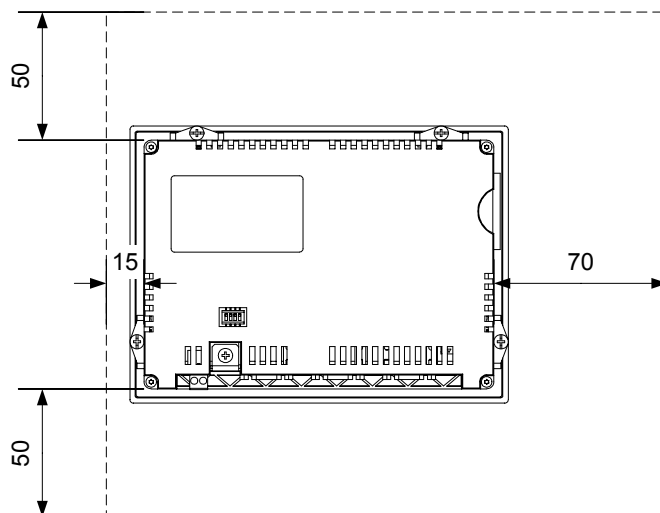

Figure 3-7 Space around the TP 170B

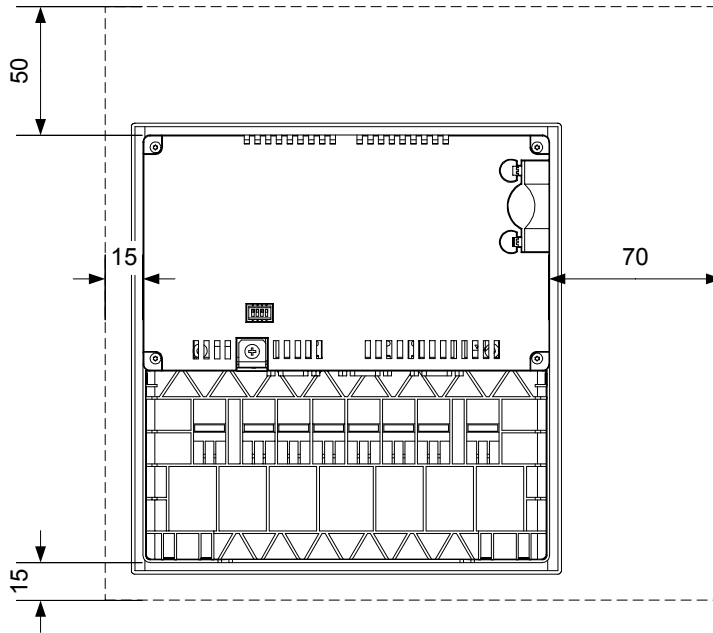

Figure 3-8 Space around the OP 170B

At least 10 mm space is required at the back.

Notice

Ensure there is sufficient air circulation in the cabinet for cooling.

3.4 Transport

Notice

Ensure that no condensation develops on or in the HMI device after it has been transported at low temperatures or it has been exposed to extreme temperature fluctuations.

The HMI device must be at room temperature before it is switched on. When doing so, do not expose the HMI device to direct radiation from a heater. If condensation should occur, only switch on the HMI device after waiting approximately 4 hours.

Conditions for problem-free, reliable operation of the HMI device include proper transport and storage, installation, and assembly as well as careful operation and maintenance.

Failure to meet these requirements voids the rights to claims under the terms of warranty.

Installation and connection

4.1 Checking the shipment

Check the packing contents for visible signs of transport damage and for completeness.

Notice

Do not install parts damaged during shipment. In the case of damaged parts, contact your Siemens representative.

Keep the documentation supplied. This belongs to the HMI device and may be required when commissioning in the future.

4.2 Installation of the HMI device

Requirement

To complete the installation, four spring terminals are required from the accessories for the TP 170micro, TP 170A and TP 170B and six spring terminals are required for the OP 170B. The installation seal must be mounted on the HMI device. If the installation seal is damaged, order a replacement.

Installation

Notice

Only install the HMI devices according to the instructions in this manual.

Proceed as follows:

1. Check that the installation seal is fitted on the HMI device.

Do not mount the installation seal turned inside out. This can lead to gaps in the installation cut-out.

2. Insert the HMI device in the installation cut-out from the front.

3. Insert the spring terminals in the recesses on the side of the HMI device.



Figure 4-1 Inserting the spring terminals in the TP 170micro, TP 170A and TP 170B

Four spring terminals must be installed and secured.

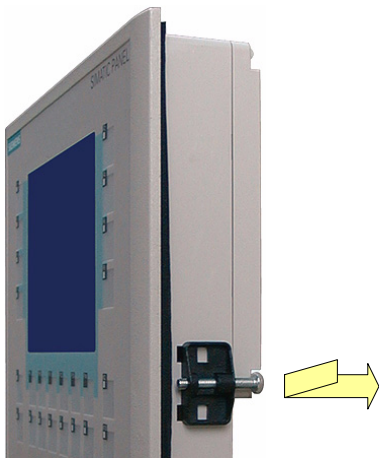

Figure 4-2 Inserting the spring terminals in the OP 170B

Four spring terminals must be installed and secured.

1. Secure the spring terminals by tightening the recessed head screws - 0.4 - 0.45 Nm is the permissible torque.

Notice

Check the fit of the installation seal on the front side. This must not protrude from the HMI device.

Otherwise, repeat steps working steps 1 to 4.

4.3 Connecting the HMI device

Requirement

The following condition must be fulfilled before the HMI device is connected electrically:

- The HMI device must be installed according to the information provided in these operating instructions.

Electrical connections

Connect the HMI device in the following sequence:

1. Potential equalization line
2. Controller
3. Configuration computer as necessary
4. Peripheral equipment as necessary
5. Supply voltage

Notice

Connection sequence

Carefully follow the sequence of HMI device connections. Failure to do so may result in damage to the HMI device.

When disconnecting, it is essential that you follow the sequence in reverse order.

4.3.1 Interfaces on the TP 170micro, TP 170A and TP 170B

The following interfaces are available on the HMI device:

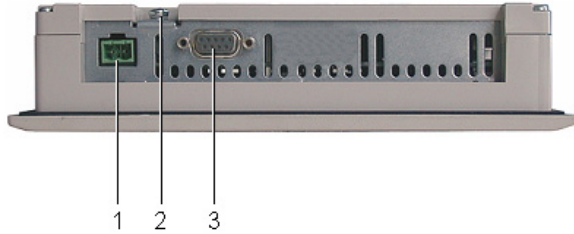

Figure 4-3 Interfaces on the TP 170micro

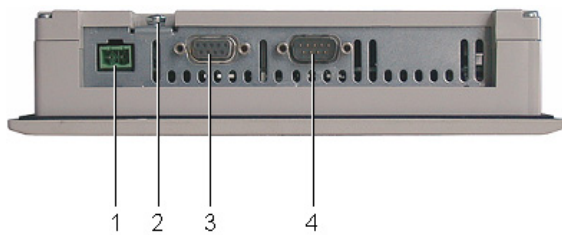

Figure 4-4 Interfaces on the TP 170A

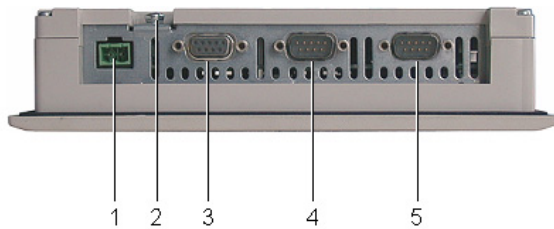

Figure 4-5 Interfaces on the TP 170B

- 1 Connection for the power supply
- 2 Chassis terminal
- 3 RS 422/RS 485 interface (IF 1B)
For TP 170micro: RS 485 interface (IF 1B)
- 4 RS 232 interface (IF 1A)
- 5 RS 232 interface (IF 2)

4.3.2 Interfaces on the OP 170B

The following interfaces are available on the HMI device:

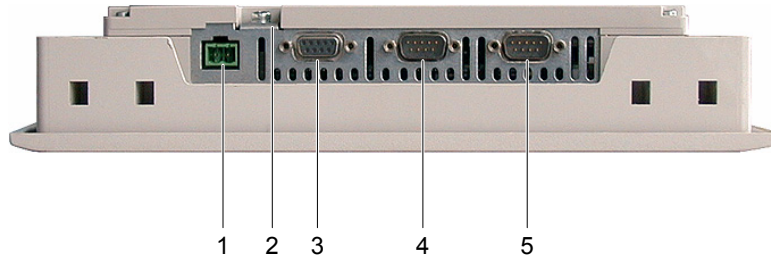

Figure 4-6 Interfaces on the OP 170B

- 1 Connection for the power supply
- 2 Chassis terminal
- 3 RS 422/RS 485 interface (IF 1B)
- 4 RS 232 interface (IF 1A)
- 5 RS 232 interface (IF 2)

4.3.3 Connecting the lines

When connecting the cables, ensure that the contact pins are not bent. Secure the cable plugs with screws.

The pin assignment of the interfaces is described in the Technical Data.

4.3.4 Connecting the equipotential bonding

Potential difference

Differences in potential can occur between separated system parts and result in high equalizing currents. This can happen when line shields are applied on both sides and grounding occurs on different system parts.

The cause of potential differences can be different supply connections.

General requirements for equipotential bonding

Potential differences must be reduced by laying sufficient equipotential bonding cables to ensure problem-free operation of the electronic components concerned. Therefore, the following must be observed when setting up equipotential bonding:

- The effectiveness of the equipotential bonding increases as the the impedance of the equipotential bonding cables decreases (i.e., or as the cross section of the equipotential bonding cable increases).
- If two system parts are connected to each other via shielded data lines with shielding connected to the grounding/protective conductor on both sides, the impedance of the additionally laid equipotential bonding cables must not exceed 10% of the shield impedance.
- The cross-section of an equipotential bonding cable must be selected to accommodate the maximum equalizing current flow. In practice, equipotential bonding cables between control cabinets with a minimum cross-section of 16 mm² have proven sufficient.
- Use equipotential bonding cables made of copper or galvanized steel. Connect the equipotential bonding cables properly to the grounding/protective conductor with the greatest possible surface area and protect them from corrosion.
- Clamp the shielding of the data line on the HMI device flush and as close as possible to the potential equalization rail using cable clips.
- Lay the potential equalization and data lines parallel to each other and within the minimum distance of each other (refer to following Figure, Point 6).

Notice

Equipotential bonding cable

Cable shields are not suitable for equipotential bonding. Use only the prescribed equipotential bonding cables. Potential cable, for example, must have a minimum cross-section of 16 mm². When setting up MPI and PROFIBUS DP networks, ensure cables with a sufficient cross-section are used otherwise the interface modules may be damaged or even destroyed.

Connection configurator

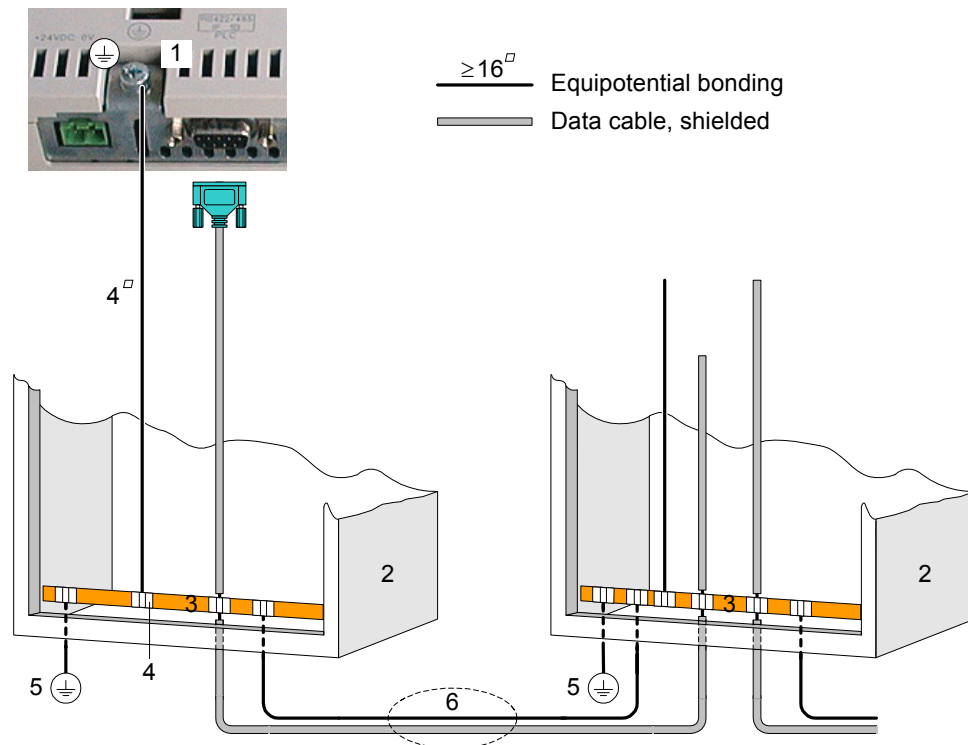

Figure 4-7 Installing equipotential bonding on the TP 170micro, TP 170A, TP 170B or OP 170B

- 1 Grounding connection on the HMI device
- 2 Control cabinet
- 3 Voltage bus
- 4 Cable clip
- 5 Ground connection
- 6 Parallel laying of equipotential bonding cable and data line

4.3.5 Connecting the PLC

Connection configurator

The following diagram illustrates the connection between the HMI device and PLC.

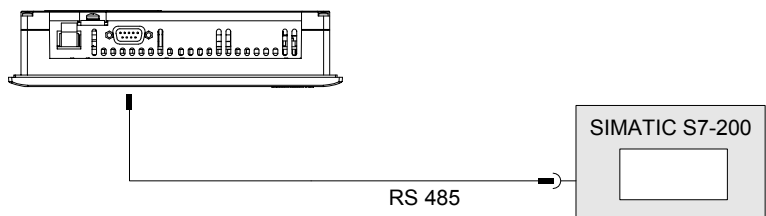

Figure 4-8 Connecting a PLC to the TP 170micro

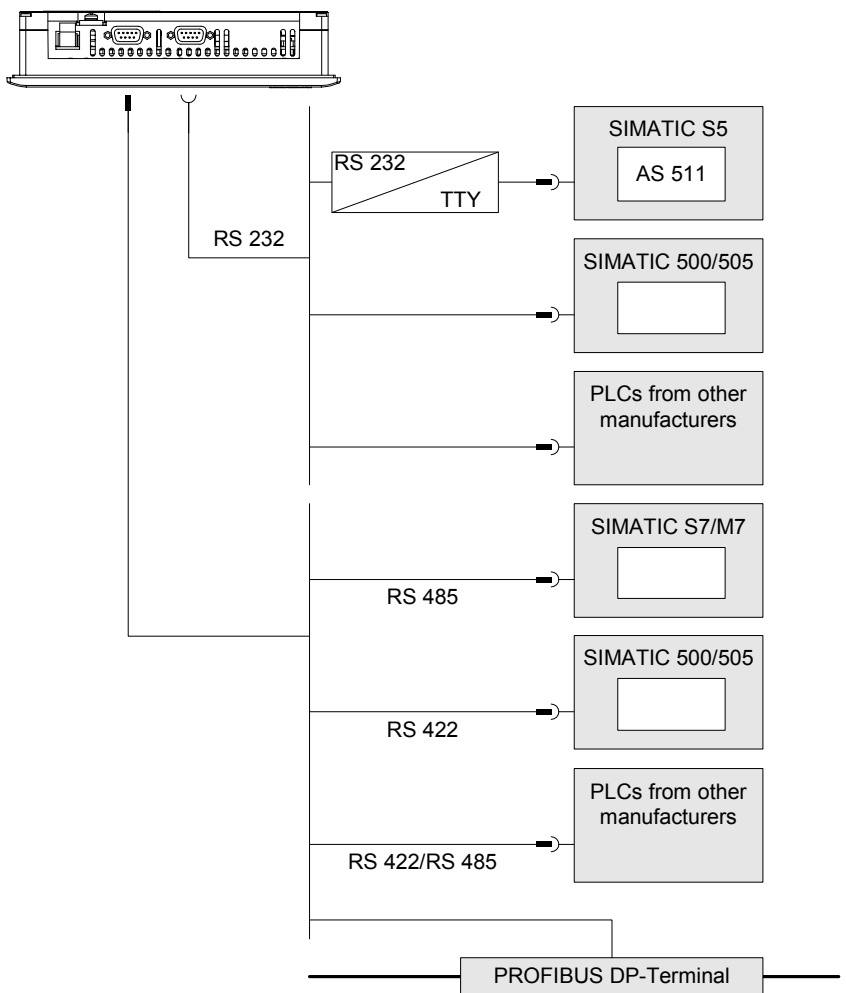

Figure 4-9 Connecting a PLC to the TP 170A

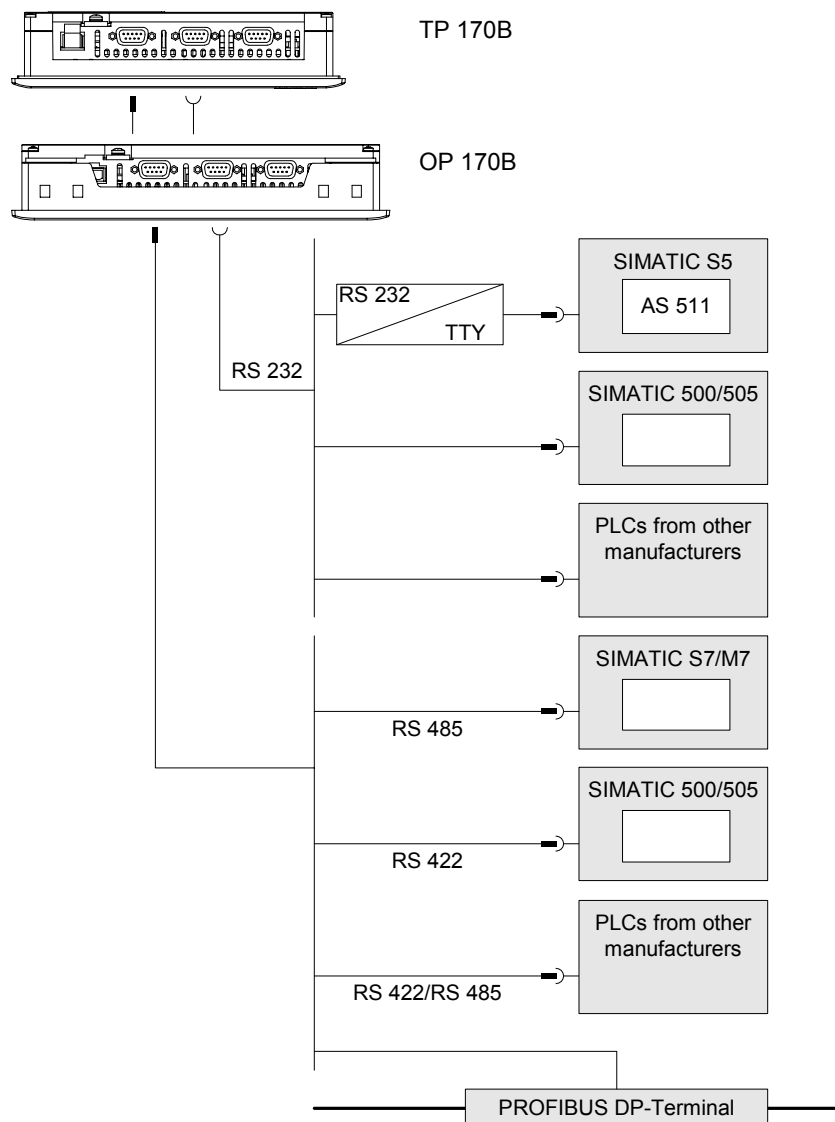

Figure 4-10 Connecting a PLC to the TP 170B or OP 170B

The interfaces are described in the Technical Data.

Note when connecting

Notice

Use only the approved cables for connection to a SIMATIC S7 PLC.

In serial operation, only connect the PLC to one of the two interfaces: RS 232 or RS 422/RS 485.

Standard cables are available for the connection. Refer to SIMATIC HMI Catalog ST80.1.

Configuring the interface

The RS 422/RS 485 interface can be configured by changing the switch settings on the DIL switch. In this case, the RS 422 received data and the RTS signal are interchanged.

By default, the DIL switch is set for the SIMATIC S7 PLC.

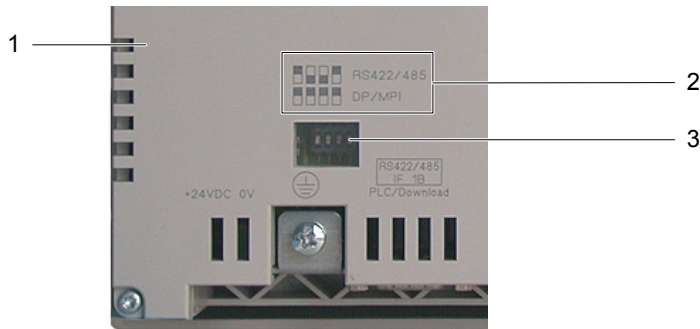

Figure 4-11 Position of the DIL switch on the TP 170A and TP 170B

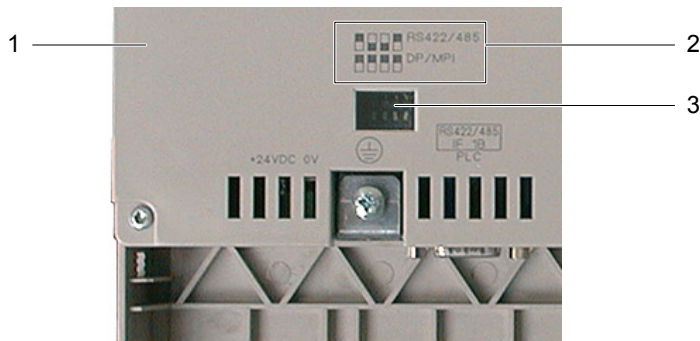

Figure 4-12 Position of the DIL switch on the OP 170B







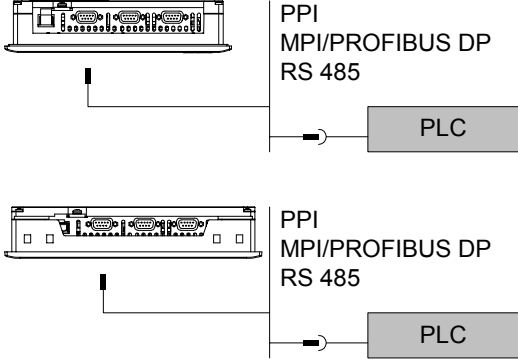

- 1 Rear panel cover
- 2 Illustration of the switch positions
- 3 DIL switch

Note

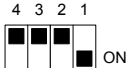
Note the diagrams of the DIL switch settings on the back of the HMI device. Also refer to the above diagram.

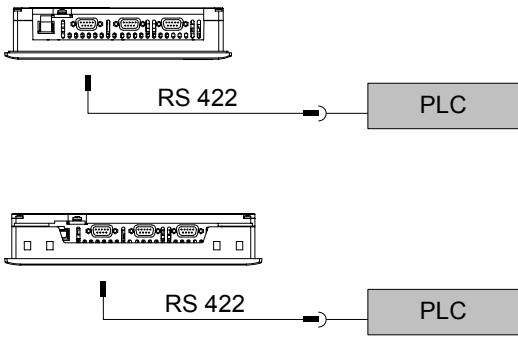
The following table describes the DIL switch settings according to the type of communication to be selected. With RS 485, the transmitting and receiving direction is switched internally with the RTS signal.

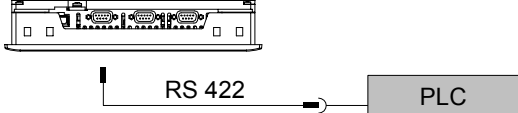
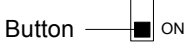
Table 4-1 DIL switch settings on the TP 170A, TP 170B and OP 170B

Communication	Switch setting	Meaning
 <p>PPI MPI/PROFIBUS DP RS 485</p> <p>PLC</p>		RTS on Pin 4 like controller
		RTS on Pin 9 like programming device
		No RTS on connector
 <p>RS 422</p> <p>PLC</p>		RS 422 interface is enabled
	 <p>RS 422</p> <p>PLC</p>	
 <p>Button</p>		State on delivery

Compressing the internal program memory of the SIMATIC S5 controller

Notice

In the case of the SIMATIC S5, compressing the PLC's internal program memory ("Compress" PU function, integrated FB COMPR) is not permitted if an HMI device is connected. When memory is compressed, the absolute addresses of the blocks in the program memory change. Since the HMI device only reads the address list during startup, it does not recognize the address change and accesses the wrong memory areas.

If you cannot avoid compressing memory during operation, turn off the HMI device before running the compress function.

See also

Technical data, TP 170micro, TP 170A and TP 170B (Page 12-2)

Transfer (Page 6-42)

Configuring transfer mode for the TP 170A (Page 6-37)

4.3.6 Connecting the configuration computer

Connection configurator

The following figure depicts the connection between the HMI device and the configuration computer for transferring the image, project and other project data.

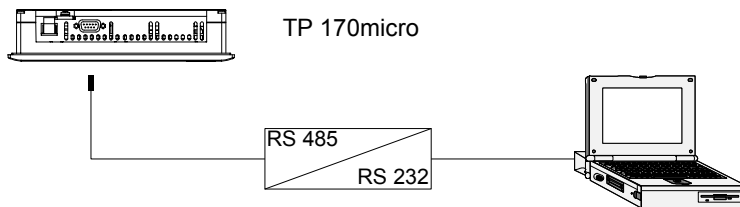

Figure 4-13 Connecting the TP 170micro to the configuration computer

To enable RS 485/RS 232 switching, the PC-PPI adapter, Order No.: 6ES7 901-3CB30-0XA0, can be ordered from Siemens AG.

Set the DIL switch on the PC-PPI adapter as follows:

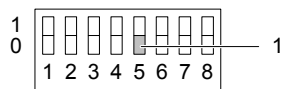

Figure 4-14 Setting PC-PPI adapter

- 1 DIL switch 5 to 0 for PPI/Freeport

The DIL switches 1 to 4 and 5 to 8 are not important when connecting a configuration computer.

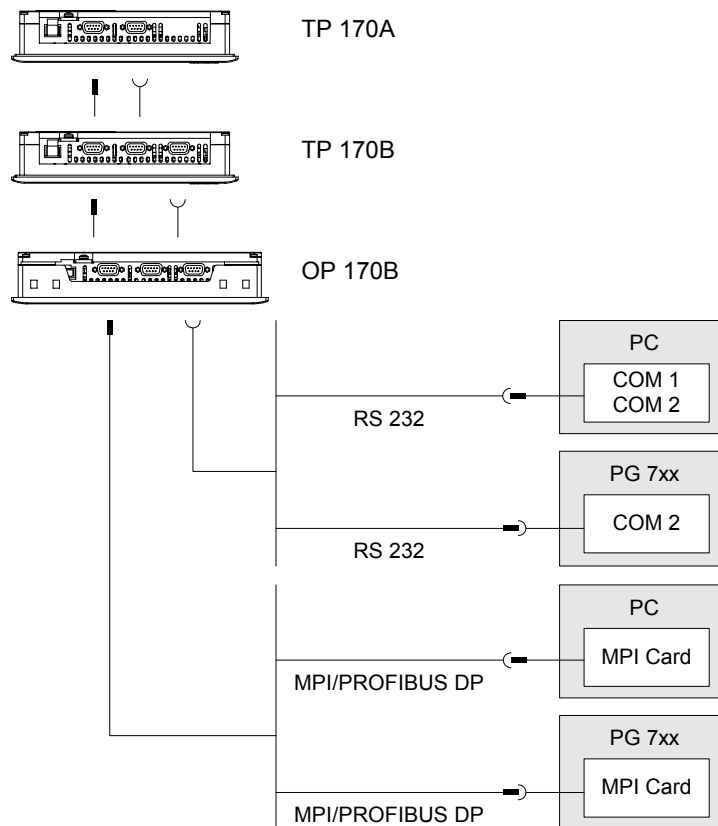

Figure 4-15 Connecting the TP 170A, TP 170B and OP 170B to the configuration computer

The interfaces are described in the Technical Data.

Note when connecting

Data can be transferred via any interface on the HMI device.

Note

Updating the operating system

If no image or no operable image appears on the HMI device, the operating system must be updated via the RS 232 interface.

4.3.7 Connecting a TP 170B or OP 170B to peripheral equipment

Connection configurator

The following diagram illustrates the connection between the HMI device and a printer.

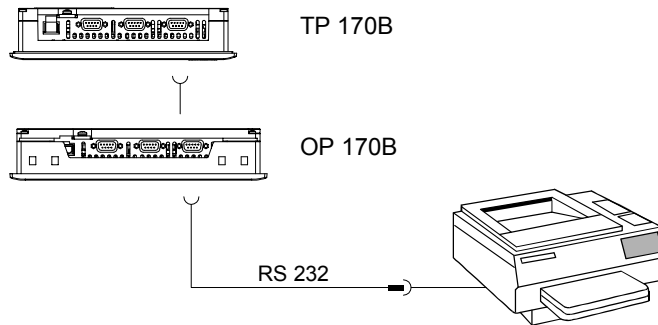

Figure 4-16 Connecting a printer

The interfaces are described in the Technical Data.

Note when connecting

Notice

Use only cables with a braided metal shield grounded at both ends for connecting the HMI device and printer.

Some printers may require that the ASCII character set used in the project is also defined on the printer.

When printing, the HMI device uses the communication protocol XON/OFF. Configure this report on the printer. When connecting a printer, the following settings are also required:

- DIL switch to RS 232, whereby only the RxD, TxD and GND signals are required,
- 8 data bits
- 1 Stop bit
- No parity

Baud rate between 9600 and 57600, printer-dependent

The Siemens Catalog ST 80 contains the printers approved by Siemens AG. A current list of approved printers is available on the Internet under Service & Support.

Note

Documentation on the peripheral equipment

When establishing the connection, always refer to the instruction manuals for the peripheral equipment.

See also

Printer (Page 6-28)

4.3.8 Connecting the power supply

Connection configurator

The following diagram illustrates the connection between the HMI device and power supply.

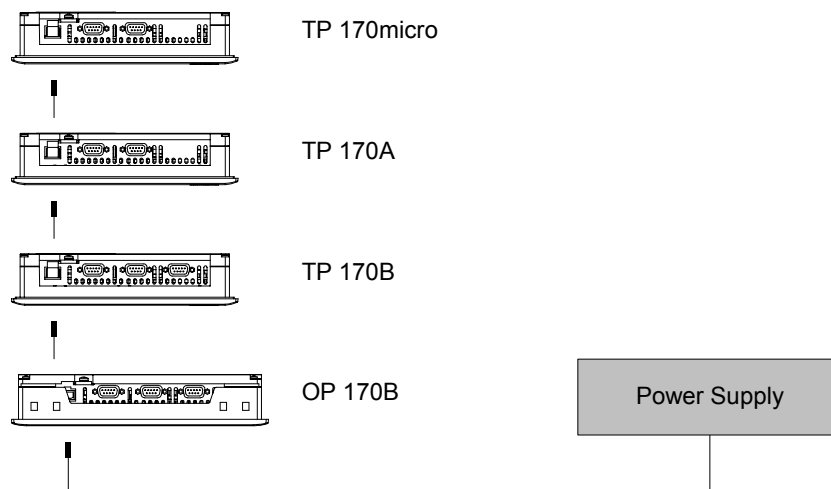

Figure 4-17 Connecting the power supply

The interfaces are described in the Technical Data.

Note when connecting

The plug-in terminal block for connecting the power supply is contained in the accessory kit and designed is for cables with a cross-section of 1.5 mm².

Connecting the terminal block

Notice

Damage

The pressure on the screwdriver can cause the HMI device's socket for the terminal block to lift from the circuit board when the terminal block is plugged into the device.

Only connect the wires when the terminal block has been unplugged.

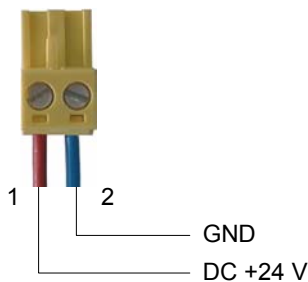

Figure 4-18 Connecting the terminal block

Connect the terminal block to the power supply lines as illustrated in the above diagram. Ensure that the lines are not crossed. Refer to the label for the pin contact on the back of the HMI device.

Reverse battery protection

The HMI device is equipped with reverse battery protection.

Connecting the power supply

Caution

Ensure safe electrical insulation of the power supply. Use only power supply units that conform to IEC 364-4-41 or HD 384.04.41 (VDE 0100, Part 410).

Only use power supply units which comply to SELV (Safety Extra Low Voltage) and PELV (Protective Extra Low Voltage - potential-free low voltage) standards.

The supply voltage must be within the specified range to avoid malfunctions on the HMI device.

Potential equalization line

If the power supply for the HMI device is not grounded, the IF1 interface could be destroyed by the potential difference between the HMI device and CPU.

Therefore, connect the 24 V output of the power supply to the potential equalization.

Refer to the Technical Data section for information on the power supply requirements.

See also

Technical data, TP 170micro, TP 170A and TP 170B (Page 12-2)

Technical data, OP 170B (Page 12-4)

4.3.9 Switch on and test the HMI device

Switching on and testing the TP 170micro and TP 170A

Proceed as follows:

1. Plug the terminal block in the HMI device.
2. Switch on the power supply to the HMI device.

After the power supply is switched on, there is a delay before the display illuminates. The following screen then briefly appears:



Figure 4-19 Startup screen

If the HMI device does not start, it is possible the wires on the terminal block have been crossed. Check the connected wires and change the connections, if necessary.

For TP 170micro:

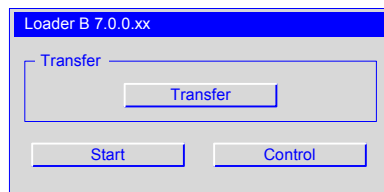

Figure 4-20 Loader on the TP 170micro

For the TP 170A:

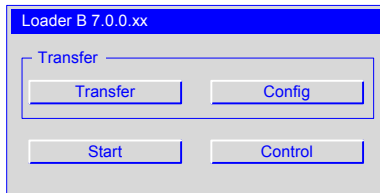

Figure 4-21 Loader on the TP 170A

When no project is available on the HMI device, the device will automatically switch to transfer mode for the initial startup after the operating system is loaded. The following dialog appears:

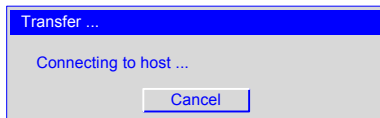

Figure 4-22 Dialog "Transfer ..."

3. Press "Cancel".

Notice

If a project already exists when the HMI device is restarted, the project is started and the transfer mode is not initiated.

Exit from the project by pressing the corresponding operating element.

After cancellation of the transfer or closing a project, the loader is displayed.

Switching on and testing the TP 170micro and TP 170B

Proceed as follows:

1. Plug the terminal block in the HMI device.
2. Switch on the power supply to the HMI device.

After the power supply is switched on, there is a delay before the display illuminates. The following screen then briefly appears:

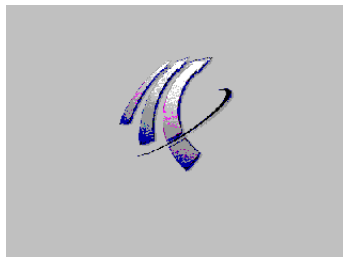

Figure 4-23 Startup screen

If the HMI device does not start, it is possible the wires on the terminal block have been crossed. Check the connected wires and change the connections, if necessary.

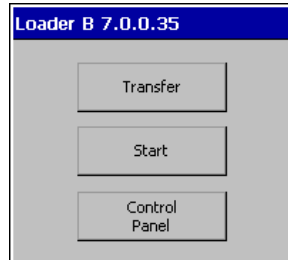

Figure 4-24 Loader

When no project is available on the HMI device, the device will automatically switch to transfer mode for the initial startup after the operating system is loaded. The following dialog appears:

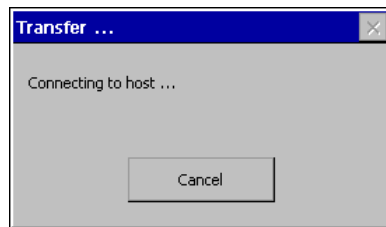

Figure 4-25 Dialog "Transfer ..."

3. Press "Cancel".



Notice

If a project already exists when the HMI device is restarted, the project is started and the transfer mode is not initiated.

Exit from the project by pressing the corresponding operating element.

After cancellation of the transfer or closing a project, the loader is displayed.

Navigation in the loader using the OP 170B

Key	Effect of pressing
 or 	After pressing one of these buttons, the next function is selected in the direction of the cursor key. On pressing and holding the key combination, the next functions are selected in succession in the direction of the cursor key.

Function test

Initiate a function test following commissioning. The HMI device is functional when one of the following conditions occurs:

- The "Transfer" dialog is displayed
- The loader is displayed
- A project is started

Switch off HMI device

Switch off the HMI device in the following ways:

- Switch off the power supply
- Unplug the terminal strip from the HMI device

Operator control elements and displays

5.1 Operating elements and indicators on the front of the TP 170micro, TP 170A and TP 170B



Figure 5-1 Operator controls

1 Display with touchscreen

A touchscreen is the standard input device on the TP 170micro, TP 170A and TP 170B. All the buttons required to operate the monitored system are displayed on the touchscreen after starting the HMI device.

Notice

Touchscreen damage

Operating the touchscreen with hard, sharp or pointed items or in a heavy-handed way can lead to a considerable reduction in its service life and even to complete failure.

Only press the HMI device's touchscreen with your fingers or a touchscreen pen.

See also

Design of the TP 170micro HMI device (Page 1-1)

Design of the TP 170B HMI device (Page 1-3)

Design of the TP 170A HMI device (Page 1-2)

5.2 Other operator controls on the TP 170A and TP 170B

Operating elements on the side and at the back of the HMI device include:

- Memory card slot (TP 170B only)
- DIL switches for the RS 422/RS 485 switch

Operation of these elements is described below.

5.2.1 Using the memory card with the TP 170B

Notice

Insert memory card

When inserting a memory card, ensure that it is parallel to the back of the HMI device. The memory card in the HMI device may be otherwise pushed past the guides and the memory card will fall inside the housing.

Procedure - using a memory card

Proceed as follows:

1. Insert a memory card in the memory card slot as illustrated in the following diagram.

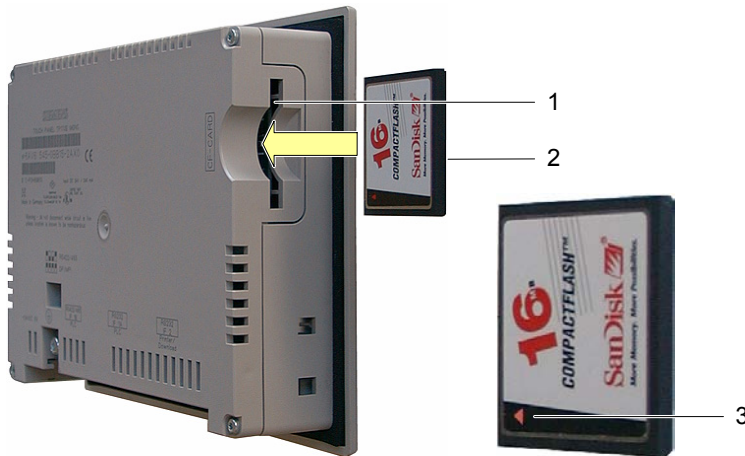

Figure 5-2 Plugging the memory card in the TP 170B

- 1 Memory card slot
- 2 CF card
- 3 Arrow

When inserting the memory card, please note that it can only be inserted into the memory card slot as illustrated in the diagram. The arrow indicates the front side of the memory card and the direction for inserting it. When the memory card is inserted correctly in the memory card slot, it protrudes about 3 mm out of the slot.

5.2.2 Unplugging the memory card

Procedure - unplugging a memory card

Notice

Data loss

If the HMI device accesses the data on the memory card while the card is being removed, the data on the memory card will be destroyed.

Do not remove the memory card when data is being accessed. Note the corresponding alarms on the display.

Proceed as follows:

1. Grasp memory card
2. Pull the memory card from the memory card slot.
3. Store the memory card in a protective case.

5.2.3 Setting the DIL switch

The DIL switches are already configured for connecting the HMI device to a SIMATIC S7.

5.3 Front side operating elements and indicators on the OP 170B

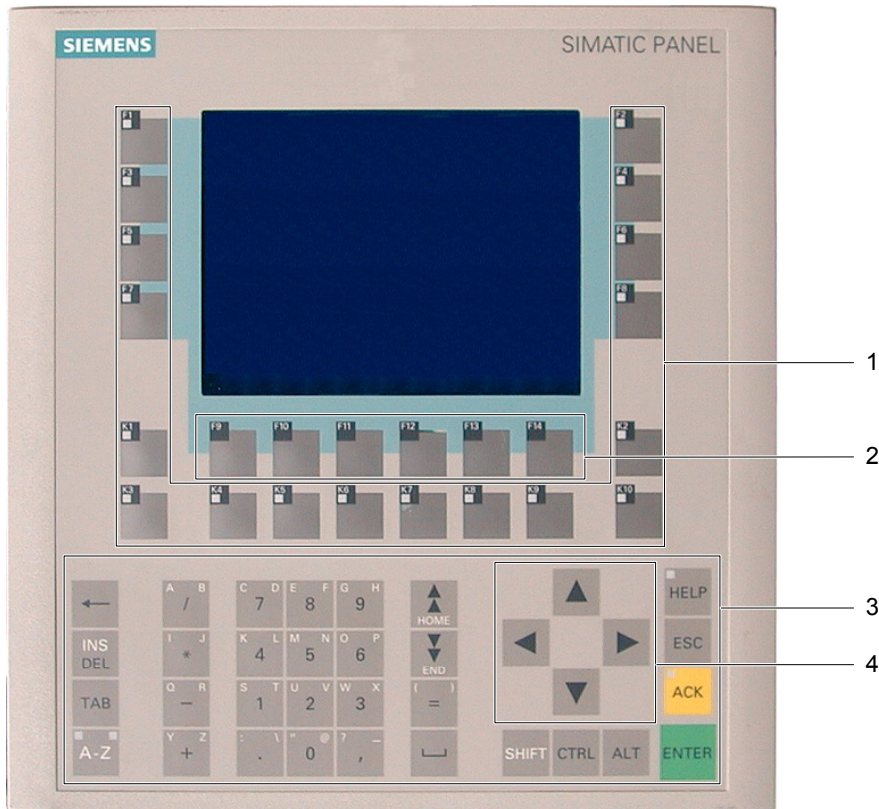

Figure 5-3 Operating elements and indicators

- 1 Softkeys with LEDs
- 2 Softkeys without LEDs
- 3 System keys with digit keypad
- 4 Cursor keys

The standard input device for the OP 170B is the keyboard. This is basically composed of two key groups:

- Function keys
F1 to F14 and K1 to K10

The softkeys can only be assigned in a configuration. They have no function in the loader.

- System keys
The numeric keypad and control keys are system keys.

Notice

Keyboard damage

Operating the keys with hard, pointed or sharp objects or in a heavy-handed way can lead to a considerable reduction of the service life and even to complete failure.

Only use your fingers to operate the HMI device keys.

Note

Unintentional actions can be triggered by a multiple key operation.

No more than two function keys can be activated simultaneously.

See also

Design of the OP 170B HMI device (Page 1-4)

5.4 Other operating elements on the OP 170B

Operating elements on the side and at the back of the HMI device include:

- Guides for the labeling strips
- Memory card slot
- DIL switches for the RS 422/RS 485 switch

Operation of these elements is described below.

See also

Design of the OP 170B HMI device (Page 1-4)

Connecting the PLC (Page 4-8)

5.4.1 Using the memory card with the OP 170B

Notice

Insert memory card

When inserting a memory card, ensure that it is parallel to the back of the HMI device. The memory card in the HMI device may be otherwise pushed past the guides and the memory card will fall inside the housing.

Procedure - using a memory card

Proceed as follows:

1. Insert a memory card in the memory card slot as illustrated in the following diagram.

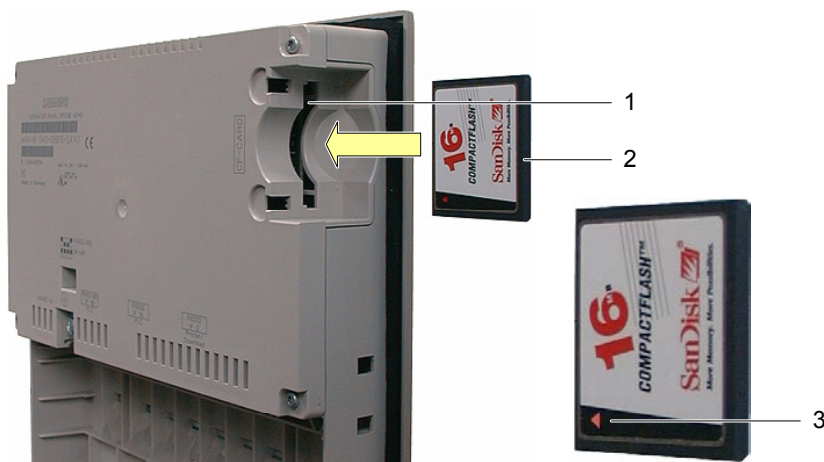

Figure 5-4 Plugging the memory card in the OP 170B

- 1 Memory card slot
- 2 CF card
- 3 Arrow

When inserting the memory card, please note that it can only be inserted into the memory card slot as illustrated in the diagram. The arrow indicates the front side of the memory card and the direction for inserting it. When the memory card is inserted correctly in the memory card slot, it protrudes about 3 mm out of the slot.

Procedure - unplugging a memory card

Notice

Data loss

If the HMI device accesses the data on the memory card while the card is being removed, the data on the memory card will be destroyed.

Do not remove the memory card when data is being accessed. Note the corresponding alarms on the display.

Proceed as follows:

1. Grasp memory card
2. Pull the memory card from the memory card slot.
3. Store the memory card in a protective case.

5.4.2 Labeling the OP 170B softkeys

Labeling the function keys

Label the function keys based according to the project. Use labeling strips for this.

The labelling strips can be inserted before or after installation of the HMI device.

Printing the labeling strips

The templates for the labeling strips are in the "Slide170.doc" file on the "WinCC flexible" installation CD in the "\Support\Documents" folder. The file can be edited with MS Word or Wordpad, for example.

Pay attention to the information provided in the file.

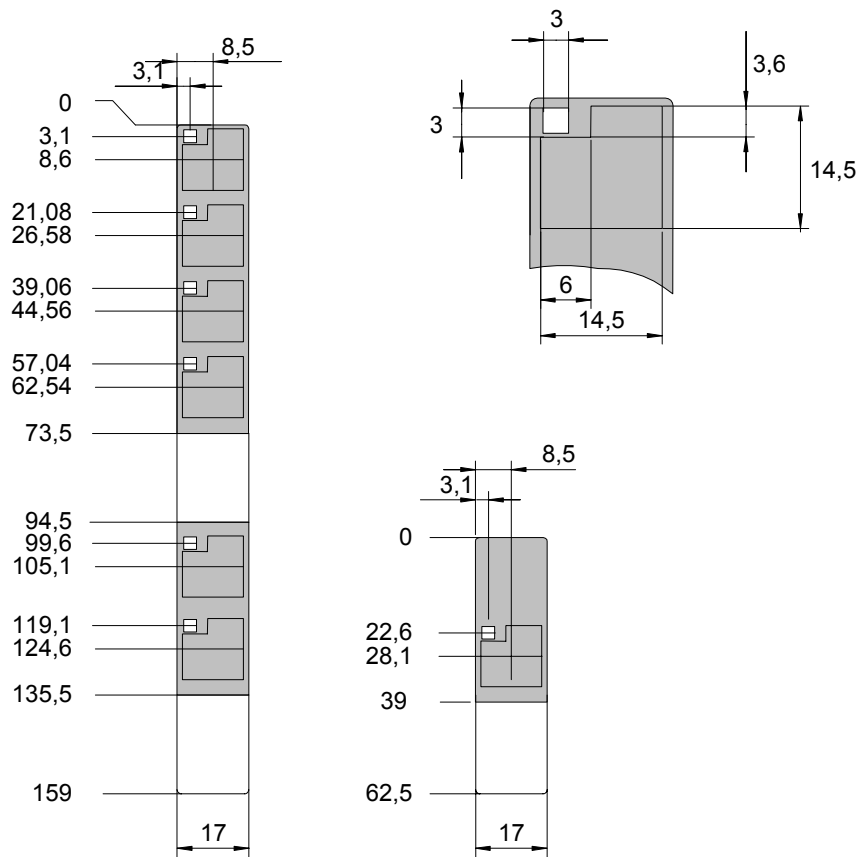

Figure 5-5 Labeling strip dimensions

Printable foil or paper can be used for labeling strips. Use of transparent foil ensures the LEDs on the softkeys remain visible. Permissible thickness of the labeling strip: 0.15 mm.

Proceed as follows

Proceed as follows:

1. Edit and print templates

Another option is to print blank templates and label them afterwards.

Notice

Do not write on the keyboard to label the softkeys.

2. Cut out labeling strips

Ensure that the corners are cut according to the above diagram. It simplifies sliding them in the guide.

3. Remove the existing labeling strips

Note

Wait for the ink to dry before inserting strips wait until the inscription is dry.

4. Slide the labeling strips in the guide

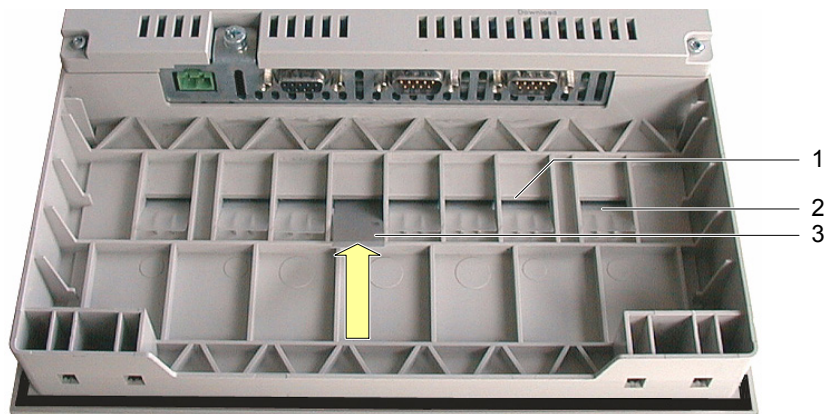

Figure 5-6 Insert the labeling strips.

- 1 Guide
- 2 Inserted labeling strips
- 3 Inserting labeling strips

5. Slide the labeling strips to the end of the guide.

The labeling strip will protrude approximately 1 cm out of the guide. The template is sized so that the labeling is correctly placed behind the softkey fields. A stop for the labeling strips is not necessary.

See also

Transfer (Page 6-42)
Connecting the PLC (Page 4-8)

5.4.3 Setting the DIL switch

The DIL switches are already configured for connecting the HMI device to a SIMATIC S7.

Operating system and configuration

6.1 Configuring the TP 170micro and TP 170A operating system

The HMI device is ready to operate upon delivery. The Microsoft Windows CE operating system is installed.

After switching on the HMI device, the loader appears during the start phase for approx. 3 seconds. If a project is already loaded on the HMI device, it is started. The HMI device otherwise switches to transfer mode.

Loader on the TP 170micro

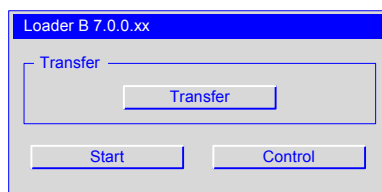

Figure 6-1 Loader on the TP 170micro

The buttons in the loader trigger the following functions:

- "Transfer"
This button switches the HMI device to the transfer mode to enable data transfer.
- "Start"
This button starts a project stored on the HMI device.
- "Control"
This button opens a configuration menu for the HMI device.

Before a project is transferred and started, configure the HMI device according to the specific conditions of use. Press the "Control" button to open the "Control Settings" dialog.

Loader on the TP 170A

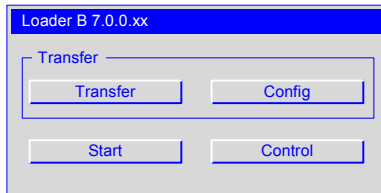

Figure 6-2 Loader on the TP 170A

The buttons in the loader trigger the following functions:

- "Transfer"
This button switches the HMI device to the transfer mode to enable data transfer.
- "Config"
This button opens a configuration menu for data channels of the HMI device.
- "Start"
This button starts a project stored on the HMI device.
- "Control"
This button opens a configuration menu for the HMI device.

Before a project is transferred and started, configure the HMI device according to the specific conditions of use. Press the "Control" button to open the "Control Settings" dialog.

See also

Switch on and test the HMI device (Page 4-17)

Configuring transfer mode for the TP 170A (Page 6-37)

6.1.1 Operating by touch

Operations are carried out exclusively by touching the touchscreen. The pressure-sensitive mask on the screen detects contact. The position of the point of contact is assigned to a control object behind it. This enables a control object or a programmed function is triggered.

See also

Touchscreen calibration (Page 6-35)

6.1.2 "Control Settings" dialog

General procedure - changing settings

Notice

Changing system settings

Changes which affect the transfer only take effect after shutting down and restarting the operating system.

Proceed as follows:

1. Close the project.
2. Open the "Control Settings" dialog.
3. Change the settings for the respective function.
4. Close the "Control Settings" dialog.
5. Switch off HMI device
6. Switching on the HMI device.

Requirement

- The HMI device is switched on.
- "Control" was pressed in the loader.

The following dialog appears:

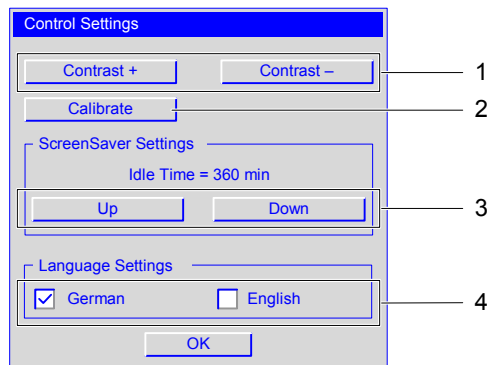

Figure 6-3 "Control Settings" dialog

- | | |
|---|-------------------------------|
| 1 | Buttons for contrast control |
| 2 | Buttons for calibration |
| 3 | Buttons for the screensaver |
| 4 | Language selection checkboxes |

The following can be set in the "Control Settings" dialog:

- Display contrast
- Calibration of the touchscreen
- Duration of screensaver display
- Operating system language

Note

The entry which is currently active is always displayed in a dialog.

Procedure – setting the contrast

The dialog is used to adjust the contrast and thus indirectly controls the brightness of the HMI device display.

Notice

Screen contrast

The screen contrast can be increased and decreased within a wide range. Note that this can lead to the screen content becoming unrecognizable in certain lighting conditions.

The "Contrast +" button increases the contrast. The "Contrast –" button reduces the contrast.

Touchscreen calibration

The procedure is described in the section "Touchscreen calibration".

Procedure – setting the screensaver

To set the delay period for of the screensaver, proceed as follows:

1. Press "Up" to increase the value displayed in "IdleTime".
2. Press "Down" to decrease the value displayed in "IdleTime".

The values can be changed in intervals of 5 minutes.

Valid value range: 0 min to 360 min.

The default setting is "0". The screensaver remains deactivated for the period defined by this value.

Procedure – setting the operating system language

The operating system supports German and English.

Setting the language controls the format used to display the date, time and corresponding separators for the selected country. The decimal separator is either a period or a comma according to the selected language.

Note

If a language used in the project is not supported by the operating system on the HMI device, the national formats specified by the activated "Language Settings" checkbox are used.

6.2 Configuring the operating system for TP 170B and OP 170B

The loader for the TP 170B and OP 170B

The HMI device is ready to operate upon delivery. The Microsoft Windows CE operating system is installed.

After switching on the HMI device, the loader appears during the start phase for approx. 3 seconds. If a project is already loaded on the HMI device, it is started. The HMI device otherwise switches to transfer mode.

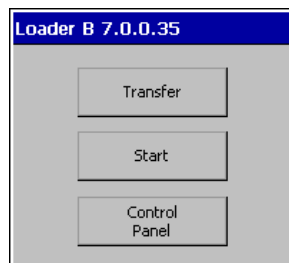







Figure 6-4 Loader, TP 170B and OP 170B

The buttons in the loader trigger the following functions:

- "Transfer"
This button switches the HMI device to the transfer mode to enable data transfer.
- "Start"
This button starts a project stored on the HMI device.
- "Control Panel"
The button opens configuration submenus for the HMI device.

Before a project is transferred and started, configure the HMI device according to the specific conditions of use. Open the Control Panel to do this.

Navigation in the loader using the OP 170B

Key	Effect of pressing
 or 	Pressing one of these keys selects the next menu command. If pressed and held, the menu runs continuously.
 +  or 	Pressing this key selects the previous menu command. If pressed and held, the menu runs continuously.
	The function assigned to the activated button is executed.

See also

Switch on and test the HMI device (Page 4-17)

6.2.1 Operating by touch

Operations are carried out exclusively by touching the touchscreen. The pressure-sensitive mask on the screen detects contact. The position of the point of contact is assigned to a control object behind it. This enables a control object or a programmed function is triggered.

See also

Touchscreen calibration (Page 6-35)

6.2.2 Navigating and operating

Introduction

The functions are available in the Control Panel as icons. Clicking on the icon opens the corresponding dialog. This allows you to adapt the HMI device to the system environment.

Requirement

- The HMI device is switched on.
- The loader is displayed

Note**Cancel transfer**

The "Transfer ..." mode can be cancelled by pressing "Cancel" on the TP 170B and <ESC> on the OP 170B.

6.2.2.1 Operating and navigating in Control Panel

Procedure – open the Control Panel

Proceed as follows to open the Control Panel:

1. Press the "Control Panel" button in the loader.
2. if a project is running, press the control object which is linked to the function for opening the loader.

This procedure can only be performed when a corresponding function has been configured in the project.

The following window opens:



Figure 6-5 Control Panel

Fifteen functions are integrated in the Control Panel. They are described below. The functions "S7 Transfer" and "Transfer" are described in the section "Configuring data channels".

Note

The  button has no function.

Navigation in the Control Panel menu using the OP 170B

The arrangement of the icons in the Control Panel can be changed to faceplate navigation.

















- For the TP 170B: Click on "View."
- For the OP 170B: Open the "View" menu with .

A menu with four commands opens:

- Large Icons
The icons are displayed as depicted in the above diagram.
- Small Icons
The icons are displayed smaller.
- Detail
Smaller icons are displayed and descriptions are also provided.
- Arrange Icons
The icons can be sorted according to name and description.

The following keys can be used to navigate within the Control Panel of the OP 170B:

Table 6-1 Keys for navigating in the Control Panel at the OP 170B

Key	Effect of pressing
 or  or  or 	<p>After pressing one of these buttons, the next icon is selected in the direction of the cursor key.</p> <p>If pressed and held, the next icons are selected in succession in the direction of the cursor key.</p>
 +  or  +  or  +  or  + 	<p>On pressing one of these key combinations, several icons are selected.</p> <p>If pressed and held, the next icons are selected in succession in the direction of the cursor key.</p>
   	<p>The list arrow has no function and therefore cannot be selected.</p>

Procedure – closing the Control Panel on the TP 170B

Proceed as follows to close the Control Panel:

1. Press .

The Control Panel is closed. The loader is displayed again.

The Control Panel can also be closed via the "File" menu.

1. Click on "File".

The following menu opens:



Figure 6-6 "File" menu

2. Press "Close".

Procedure – closing the Control Panel on the OP 170B

Proceed as follows to close the Control Panel:

1. Press .

The following menu opens:

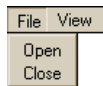



Figure 6-7 "File" menu

2. Select "Close" with  or .

The selected menu option is displayed in reversed colors.

3. Press .

The Control Panel is closed. The loader is displayed again.

6.2.2.2 Operating and navigating in a dialog

Requirement

An icon is selected in the Control Panel.

Procedure - opening a function dialog

Applies to the TP 170B:

1. Double-click on the icon.

The icon becomes darker and the name of the icon is displayed in reversed colors. The associated function then opens.

Applies to the OP 170B:

There are two methods of opening a function:

- Using system keys
- Using the menu bar:

Opening function using system keys

1. Select the icon in the Control Panel.

The icon becomes darker and the name of the icon is displayed in reversed colors.

2. Press .

The function is opened.

Opening function using the menu bar

1. Select the icon in the Control Panel.

2. Open the menu bar by pressing .













3. Select "Open".

4. Press .

The function is opened.

Navigation in a "Control Panel" dialog using the OP 170B.

Table 6-2 Keys for the navigation in a dialog of the "Control Panel" using the OP 170B

Key	Effect of pressing
	<p>On pressing this key, the next field is activated according to the configured tab order setting.</p> <p>On pressing and holding the key, the fields are activated in succession based on the tab order setting.</p>
 + 	<p>On pressing this key combination, the next field is activated in the order of the tab setting.</p> <p>On pressing and holding the key, the fields are activated in succession based on the configured tab order.</p>
 +  or  + 	<p>On pressing one of these key combinations, several functions are selected.</p> <p>On pressing and holding the key combination, the next functions are selected in succession in the direction of the cursor key.</p>
 +  or  + 	<p>On pressing one of these key combinations, several functions are selected.</p> <p>On pressing and holding the key combination, the next functions are selected in succession in the direction of the cursor key.</p>
	<p>On pressing <ESC>:</p> <ul style="list-style-type: none"> • The dialog is closed. • The original values remain valid as long as <ENTER> is not pressed.
	<p>On pressing <ENTER>:</p> <ul style="list-style-type: none"> • The dialog is closed when no the button is activated. • The entered values are valid.

Information is available in the following sections on the content and setting options in the dialogs. The procedure is described using examples of dialogs from OP 170B. The examples also apply to the TP 170B.

Procedure - closing a function dialog

Applies to the TP 170B:

1. Press  in order to discard the entries.

The activation has the same effect as <ESC>.

2. Press  in order to accept the entries





The activation has the same effect as <ENTER>.

Applies to the OP 170B:

1. Press .

The dialog is closed.

If open dialogs cannot be closed, proceed as follows:

1. Open another dialog in the Control Panel.
2. Use  +  to move to another open dialog.
3. Close the dialog with  or .

Repeat steps 2 and 3 as necessary until all the dialogs are closed.

General procedure - changing settings

Notice

Changing system settings

Changes which affect the transfer only take effect after shutting down and restarting the operating system.

Proceed as follows:

1. Close the project.
2. Opening Control Panel
3. Change the settings for the respective function.
4. Close the Control Panel.
5. Switch off HMI device
6. Switching on the HMI device.

6.2.3 Backup/Restore

Requirement

-  was activated in Control Panel.
- For backup:
A memory card with ≥ 16 MB is inserted in HMI device.
- For restoring:
A memory card containing the image to be transferred is inserted in the HMI device.

"Backup/Restore" dialog

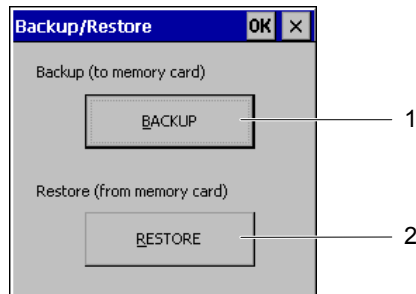

Figure 6-8 "Backup/Restore" dialog

- 1 Button for data backup
- 2 Button for data restore

The "Backup/Restore" dialog contains the "BACKUP" and "RESTORE" buttons. These buttons are used to transfer project data between the HMI device and the memory card.

Note

"Backup/Restore" dialog

After selecting "Backup" or "Restore" and confirming with <ENTER>, the selected action is immediately executed on the HMI device.

If no memory card is inserted in the memory card slot, an alarm appears. Insert the memory card and confirm with <ENTER>. If a memory card card is not inserted, the Control Panel reappears after acknowledging an alarm.

See also

Backup and restore project (Page 7-13)

6.2.4 Communications Properties

Requirement

 was activated in the Control Panel.

"Communications Properties" dialog

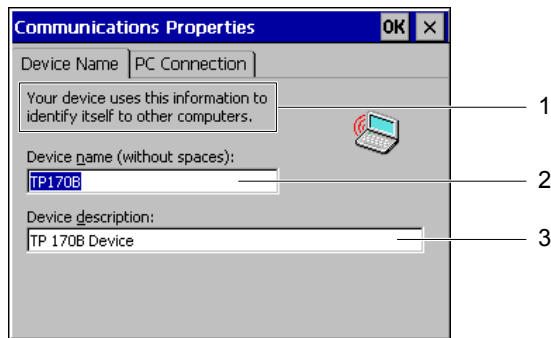

Figure 6-9 "Communications Properties" dialog, "Device Name" tab register

- 1 The HMI device uses this information to identify itself to other computers.
- 2 Name of the HMI device
- 3 Description for the HMI device

Network communication has not been approved for TP 170B and OP 170B. Do not change the settings in this dialog.

6.2.5 Date/Time

Requirement



was activated in the Control Panel.

"Date/Time Properties" dialog

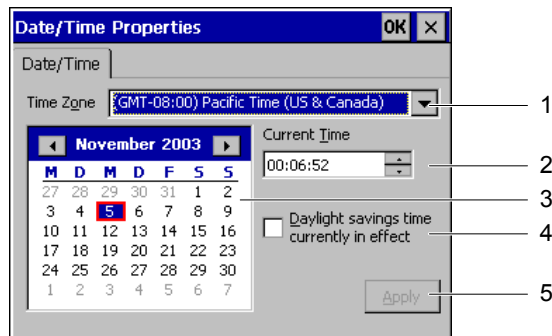

Figure 6-10 "Date/Time Properties" dialog

- 1 Time zone selection box
- 2 Time selection box
- 3 Date selection box
- 4 "Summertime" checkbox
- 5 Button

The "Date/Time Properties" dialog contains the "Date/time" tab.

The "Date/time" tab can be used to:

- Set the time zone
- Select the date
- Correct the set time
- Activate the "Daylight savings time ..." checkbox for switching to summertime

The default settings are:

- "Pacific Time (US & Canada)" for the USA and Canada time zone
- "Not enabled" "Daylight savings time ..." checkbox – switching to summertime is not activated.

Proceed as follows

Proceed as follows:

1. Select the time zone.
2. Press "Apply".

The selected time zone goes into effect when this button is pressed.

3. Correcting date and time

If you activated "Daylight savings ..." and the set date falls within the summertime period, then an hour is added automatically to the set time.

For the TP 170B:

You can also press **OK** instead of "Apply". The entries are applied and the dialog closed.

For the OP 170B:

You can also press <ENTER> instead of "Apply." The changes are applied.

Synchronizing date and time with the PLC

The date and time of the HMI device can be synchronized with the PLC, if this has been configured in the project and the PLC program..

Further information on this subject is available in the "WinCC flexible" system manual.

Notice

Synchronize the date and time when time-controlled responses should be triggered in the PLC by the HMI device.

6.2.6 InputPanel

The "Input Panel" function is used to input alphanumeric and numeric characters in the Control Panel on the TP 170B.

This keyboard cannot be used in a project.

Requirement



was activated in the Control Panel.

"Siemens HMI Input Panel – Options" dialog

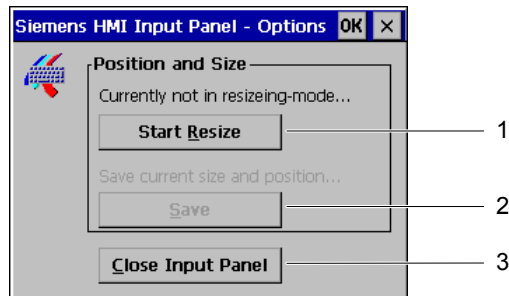

Figure 6-11 "Siemens HMI Input Panel – Options" dialog

- 1 Button for opening the screen keyboard
- 2 Button for saving size and position of the screen keyboard
- 3 Button for closing the screen keyboard

The "Siemens HMI Input Panel – Options" dialog is used to:

- Open the screen keyboard
- Enlarge the screen keyboard
- Fix the keyboard position on the screen

The screen keyboard is provided for input in Control Panel dialogs.

Proceed as follows to open the screen keyboard, save its position on the screen and close the "Siemens HMI Input Panel – Options" dialog:

Procedure - opening the screen keyboard

1. Press "Start Resize".

The screen keyboard is opened and appears as follows.



Figure 6-12 The screen keyboard is in alphanumeric mode.

Procedure - moving the screen keyboard and saving position

- 1. Touch .

The screen keyboard can be moved on the screen. Release the icon when the required position is reached.

- 2. Press "Save".

Note

To save the new size and position of the keyboard, switch on the alphanumeric keyboard before saving it.

The size and position of the screen keyboard on the screen are saved. The next time it is opened, the screen keyboard appears in the same size and position.

The following keys change the display format of the screen keyboard:

- 

Upper case letters appear on the screen keyboard instead of lower case. This format is useful when upper case are primarily being entered.

- 

Only the numeric keys appear on the screen keyboard. The display is useful for entering numbers.



Figure 6-13 The screen keyboard as numeric keypad

Clicking on "Num" again expands the screen keyboard.

- 

The numeric and alphanumeric keys are hidden on the screen keyboard. The display is useful for input using the cursor keys.



Figure 6-14 Screen keyboard for input using the cursor keys

Clicking on "Ctrl" returns the screen keyboard to full display.

- 

All the keys in the screen keyboard are hidden. This format is useful when the open screen keyboard is still needed for further input but a dialog is covered by the screen keyboard.



Figure 6-15 Minimized screen keyboard

Note

This display format is also useful when you want to close the dialog "Siemens HMI Input Panel – Options" using the button "Close Input Panel."

Procedure - closing the "Siemens HMI Input Panel – Options" dialog

1. Press  in the "Siemens HMI Input Panel – Options" dialog.

The "Siemens HMI Input Panel – Options" dialog is closed. The screen keyboard remains open.



Procedure - closing the screen keyboard

For the TP 170B:

1. Double-click on  or press "Close Input Panel".

The screen keyboard is closed. The "Siemens HMI Input Panel – Options" dialog remains open.

For the OP 170B:

1. Press  to select "Close Input Panel".
2. Press .

The "Siemens HMI Input Panel – Options" dialog is closed. The Control Panel is displayed again.

6.2.7 Keyboard

Requirement

 was activated in the Control Panel.

"Keyboard Properties" dialog

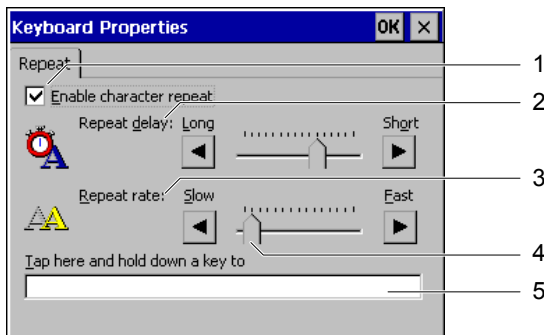

Figure 6-16 "Keyboard Properties" dialog

- 1 Repeat character checkboxes
- 2 Delay until character is repeated
- 3 Rate for repeat character
- 4 Slider control
- 5 Test field

The "Keyboard Properties" dialog contains the "Repeat" tab.

The "Repeat" tab is used to

- Enable repetition of characters
- Set delay time until character repetition
- Set the rate for character repetition and
- Test the set values.

The default setting for enabling the character repetition is "Enabled". When a key is pressed for a long time, the characters are repeated until the respective button is released.

Note

Changing settings

The settings in the "Keyboard Properties" dialog can be changed either by using the cursor keys in the dialog or by moving the slider.

Proceed as follows

Proceed as follows to test set values:

1. Select the test field.

For the TP 170B:

The screen keyboard is opened. Move the screen keyboard as needed.

2. Press any character and hold it down.

Check the implementation of the character repetition and the rate of the character repetition in the test field.

3. Correct the settings if necessary.

6.2.8 Mouse

Requirement



was activated in the Control Panel.

Note

Mouse connection

A mouse connection for the HMI devices TP 170B and OP 170B has not been approved. The operation of the touchscreen on the TP 170B can be set in the dialog.

"Mouse Properties" dialog

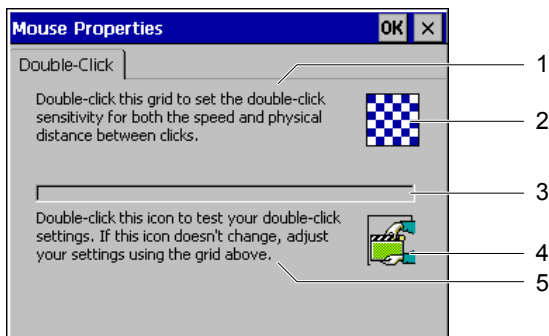

Figure 6-17 "Mouse Properties" dialog

- 1 Touch the input field **2** two times in succession to set the speed and time between contacts on the touchscreen.
- 2 Input box
- 3 No function
- 4 Control field
- 5 Touch the control field **4** two times in succession to control the entries. If the control field does not change, change the entry again.

The "Mouse Properties" dialog contains the "Double Click" tab.

The "Double Click" tab is used to:

- Set the double-click speed.
The time span between two contacts on the entry field is measured.
- Test the double click speed
The time span between two contacts on the control field is measured.

Proceed as follows

To enter the speed and time span between two contacts on the touchscreen, proceed as follows:

1. Touch the entry field two times in quick succession.

On the second contact, the entry field is displayed in reverse colors, as can be seen in the following figure:



2. Touch the control field two times in quick succession as you did on the entry field.

When the control field is touched in this way, it is displayed after the second contact as follows:



If the control field remains unchanged, repeat the setting of the entry field.

Result

The doubleclick on the touchscreen is now set.

6.2.9 OP**Requirement**

was activated in the Control Panel.

"OP Properties" dialog

Figure 6-18 "OP Properties" dialog, "Persistent Storage" tab

- 1 The current tab entries are saved. When the HMI device is restarted, the tab entries are also started automatically.
- 2 Button for saving tab entries
- 3 Button for saving temporary files
- 4 Saves all the files currently in the temporary directories in the Flash memory. These files are written back when the HMI device is started. Files in the \temp directory are not saved.

The "OP Properties" dialog contains the "Persistent Storage", "Display", "Device" and "Touch" tabs.

- The "Persistent Storage" dialog saves the current tab entries and temporary files.
- The "Display" tab defines the screen settings.
- The "Device" tab displays information about the HMI device.
- The "Touch" tab calibrates the touchscreen.

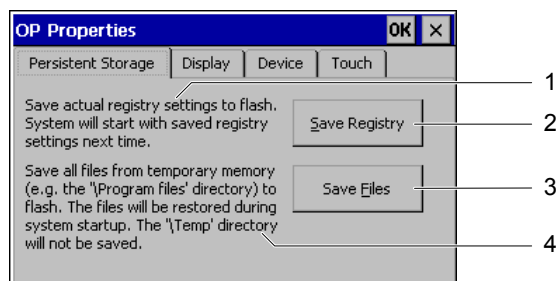
Procedure – saving tab entries and files

The "Persistent Storage" tab contains the "Save Registry" and "Save Files" buttons.

- "Save Registry"

On pressing "Save Registry," the current tab entries are saved in the internal Flash memory. The HMI device uses these saved tab entries the next time it starts.

- "Save Files"

On pressing "Save Files," temporary files are saved in the internal Flash memory. These files are written back during the startup routine. Files in the "Temp" directory are not saved.

Procedure – setting the display

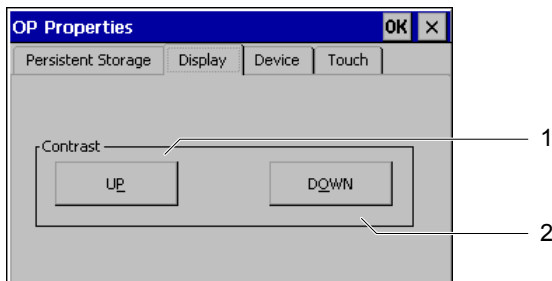

Figure 6-19 "OP Properties" dialog, "Display" tab

- 1 Button for increasing the contrast
- 2 Button for decreasing the contrast

The "Display" tab contains the "Contrast" group with the "UP" and "DOWN" buttons. Proceed as follows to change the screen contrast:

1. Press "UP".

The contrast is increased and the screen becomes darker.

2. Press "DOWN".

The contrast is reduced and the screen becomes lighter.

Procedure – displaying HMI device features

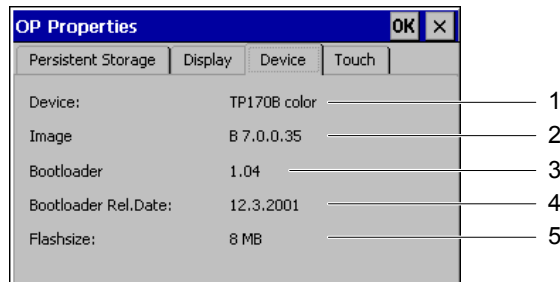

Figure 6-20 "OP Properties" dialog, "Device" tab

- 1 HMI device name
- 2 Version of the image
- 3 Version of the boot loader
- 4 Boot loader release date
- 5 Size of the internal Flash memory

The "Device" tab is used to display HMI device data. There are no input options. The following is displayed in this tab:

- HMI device name
- Version of the image
- Version of the boot loader
- Boot loader release date
- Capacity of the internal Flash memory. This is the memory for saving the image and project with associated recipes.

Note

Version of the image

The version of the image can also be found by starting the loader. The version information is shown in the title line.

You will need this information when contacting A&D Technical Support.

Procedure – calibrating the touchscreen

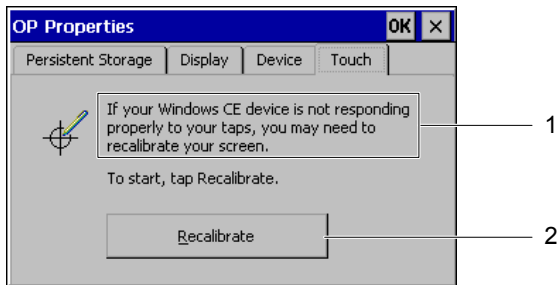

Figure 6-21 "OP Properties" dialog, "Touch" tab

- 1 If the HMI device does not react precisely, the touchscreen may need to be calibrated.
- 2 Buttons for calibrating the touchscreen

See also

Touchscreen calibration (Page 6-35)

6.2.10 Password

Requirement

 was activated in the Control Panel.

"Password Properties" dialog

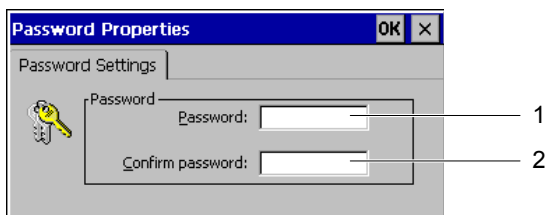

"Password Properties" dialog

- 1 Password input field
- 2 Input field for entering the password a second time

The "Password Properties" dialog contains the "Password Settings" tab.

The "Password Settings" tab protects the functions in the Control Panel.

Procedure – entering a password

Proceed as follows:

1. Enter a password in the "Password" field.

Notice**Style**

Spaces and the special characters * ? are in this entry field. . % / \ ' " are not permitted in this field.

2. Repeat the password in the "Confirm Password" field.

Note**Coding**

Each character entered in the fields is represented by an * .

Result

If a password has been assigned, access to the Control Panel in the loader is only permitted after entering the password. The "Enter Password" dialog opens on pressing the "Control Panel" button.

Note

If the required password is no longer known, the Windows CE image must be reinstalled. The Control Panel can then be accessed again without restriction.

Procedure – deleting a password

Proceed as follows:

1. Open the loader.
2. Press "Control Panel".
3. Enter the password.
4. Select the "Password" function.
5. Enter the password.
The "Password Properties" dialog opens.
6. Delete the entry in "Password:" and "Confirm Password:" deleting
7. Confirm with <ENTER>.
Close the "Password Properties" dialog.

Result

The password protection is canceled.

6.2.11 Printer

Requirement



was activated in the Control Panel.

"Printer Properties" dialog

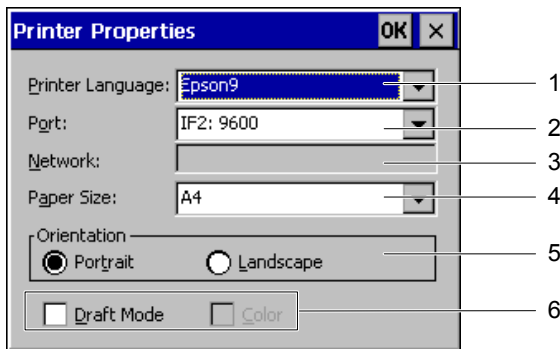

Figure 6-22 "Printer Properties" dialog

- 1 Printer language selection box
- 2 Selection box for the interface to the connected printer
- 3 Data network - not approved
- 4 Paper size selection box
- 5 Option button to define the paper size
- 6 Checkboxes for draft and color printing

Use this dialog to select the printer language for the connected printer and to set up the interface. Settings, such as color or quality of graphic printing, have no effect on the alarm logging.

- Printer language
 - The following printer languages can be set:
 - Epson9
 - PCL Inkjet
 - PCL Laser
 - Stylus Color

In the following selection lists, the available settings depend on the configured printer language.

- Interface
 - IF 2 with Baudrates 9600, 19200, 38400 and 57600
 - Data network
- Data network

The data network for the HMI devices TP 170B and OP 170B has not been approved.
- Paper size
 - DIN A4
 - DIN B5
 - Legal
 - Letter

Option buttons for the page orientation of the printout:

- "Portrait"
- "Landscape"

The following settings can be made with the checkboxes:

- "Draft Mode"
- "Color" for color prints

The following must be set for the printout of hard copies:

- Printer language
- Interface

See also

Connecting a TP 170B or OP 170B to peripheral equipment (Page 4-14)

6.2.12 Regional Settings

Requirement

 was activated in the Control Panel.

"Regional Settings Properties" dialog

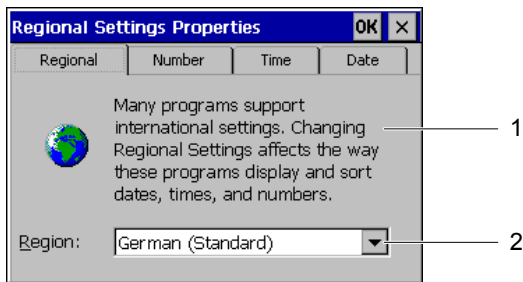

Figure 6-23 "Regional Settings Properties" dialog, "Regional" tab

- 1 Alteration of regionally dependent settings affects the display and the sequence of numbers for date, time and values.
- 2 Region selection box

The "Regional Settings Properties" dialog contains the "Regional", "Number", "Time" and "Date" tabs. These tabs are used to

- Adapt display to regional standards
- Set display format for numerical values
- Set display format of time information
- Set display format of the date

The default settings are:

- "German (Standard)" for the region
- The comma as decimal symbol for numbers
- "hh:mm:ss" for the time display
- "dd.mm.yy" for the abbreviated date format

Procedure – setting the region

Select the region where the HMI device is used from the Region selection box.

Procedure – setting the number format and decimal separator

Figure 6-24 "Regional Settings Properties" dialog, "Number" tab

- 1 Selection box to select the character for defining decimal places
- 2 Selection box to select the number grouping character
- 3 Selection box to select the separator character for number sequences

Notice**Displaying a numeric value**

A numeric format that differs from the local region can cause the misinterpretation of displayed numeric values.

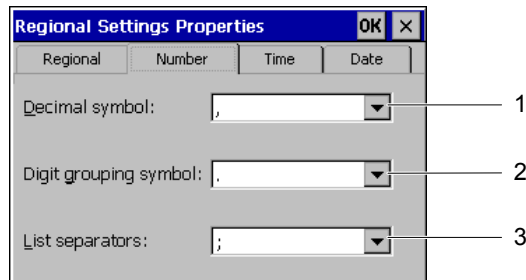
Set the display in the tab "Number" according to the region where the HMI device is used.

These selection boxes are used to:

- Define the character to separate decimal places
- Define a character to separate groups of numbers
- Define a character to separate number sequences in lists

Procedure – setting the time format

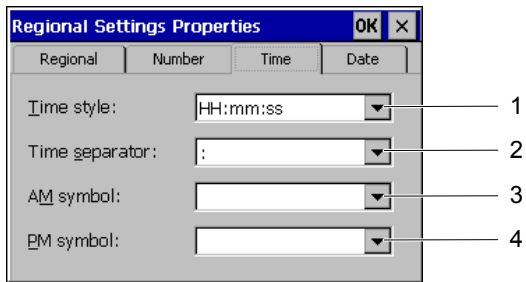

Figure 6-25 "Regional Settings Properties" dialog, "Time" tab

- 1 Selection box for defining the time format
- 2 Selection box for selecting the separator between hours, minutes and seconds
- 3 Selection box for selecting the character indicating the time before noon
- 4 Selection box for selecting the character indicating the time after noon

These selection boxes are used to:

- Select the character for the time format
- Define the separator between hours, minutes and seconds
- Define the characters for indicating morning or afternoon

Procedure – setting the date format

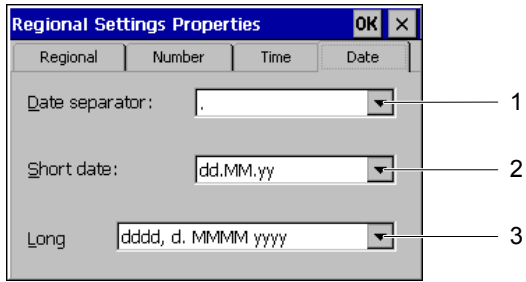

Figure 6-26 "Regional Settings Properties" dialog, "Date" tab

- 1 Selection box for defining the separator in the date
- 2 Selection box for sorting day, month and year
- 3 Selection box for the date in long format

These selection boxes are used to:

- Define the separator in the date
- Define the order in the date
- Set the date to long format

6.2.13 Screen Saver

Requirement



was activated in the Control Panel.

"Screensaver" dialog

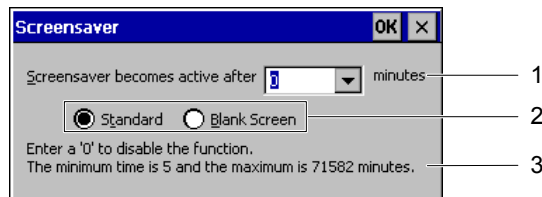

Figure 6-27 "Screensaver" dialog

- 1 Activation time for the screensaver
- 2 Option buttons for displaying the screensaver
- 3 If the value 0 is set, no screensaver is started.

This dialog is used to define the delay period for activating the screensaver. The screen saver is automatically activated if the HMI device is not operated within the specified period of time.

- Valid value range for TP 170B and OP 170B:
5 to 71582 min

Input can be made using the numeric keypad and the cursor keys. All whole numbers can be entered in this range.

On entering the value 0, the screensaver is deactivated permanently.

The screensaver display can be toggled between "Standard" and "Blank Screen" using the option button. If the screensaver is active and the "Standard" option selected, a square moves diagonally across the screen. In the case of "Blank Screen", nothing appears in the display.

For touch operation:

The screensaver is deactivated when the screen is touched.

Note

If an operating element is touched when deactivating the screensaver, the function is not triggered.

For keyboard operation:

The screensaver is deactivated by pressing any key. The function assigned to that key is not triggered.

6.2.14 System

Requirement



was activated in the Control Panel.

"System Properties" dialog

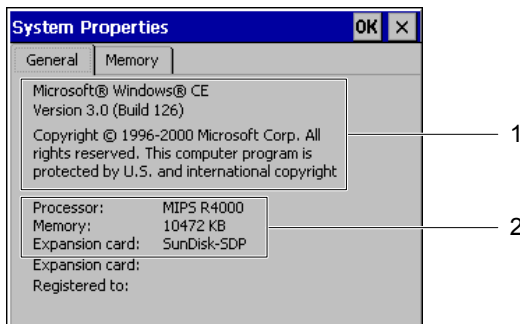

Figure 6-28 "System Properties" dialog, "General" tab

- 1 Copyright to Microsoft Windows CE
- 2 Information about the processor, amount of the internal Flash memory, and capacity of an inserted memory card

The "System Properties" dialog contains the "General" and "Memory" tabs. These tabs are used to

- Display general information about the HMI device
- Define the amount of space for file storage.

The "General" tab contains information on the processor type and memory capacity. In addition, information appears as to whether a memory card is inserted and its type.

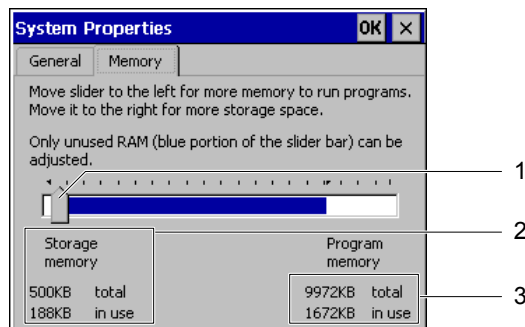

Figure 6-29 "System Properties" dialog, "Memory" tab

- 1 The position of the indicator must not be changed
- 2 Buffer with information about the total and used capacity
- 3 Program memory with information about the total and used capacity

Notice

"Memory" tab

The memory capacity in the "Memory" tab must not be changed.

6.3 Touchscreen calibration

Introduction

It may be necessary to recalibrate the screen if operator controls no longer responds. Environmental influences and natural aging may make a recalibration of the touchscreen necessary.

Requirement

- "Control" was activated in the loader on the TP 170micro and TP 170A.
-  was activated in the Control Panel on the TP 170B and OP170B.

Procedure – calibrating the touchscreen

You can calibrate the touchscreen by pressing the "Calibrate" button in the "Control Settings" dialog on the TP 170micro and TP 170A. Press "Recalibrate" in the "Touch" tab of the "OP Properties" dialog to calibrate the touchscreen on the TP 170B and OP 170B. The following dialog appears for this. Follow the instructions.

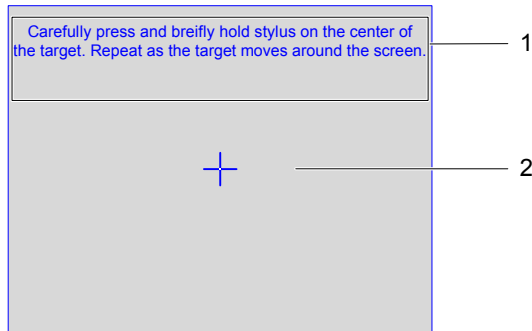

Figure 6-30 "Calibrate touchscreen" dialog

- 1 Press carefully and hold the touch pen briefly on the center of the calibration crosshairs. Repeat the process as long as the calibration crosshairs move on the touchscreen.
- 2 Calibration crosshairs

Note

"Calibrate touchscreen" dialog

The opened "Calibrate touchscreen" dialog can only be exited by completing the following steps.

Proceed as follows:

1. Touch the center of the crosshairs with your finger or touch pen.

Touch the calibration crosshairs for approximately 2 seconds. The calibration crosshairs will then assume the next position.

If you do not hit the center of the calibration crosshairs, the crosshairs nevertheless change their position. Repeat the process from the beginning starting with the first calibration crosshair.

Note

As long as the "Calibrate touchscreen" dialog is open, the screen saver will not be activated.

2. Repeat step 1 four times.

The following dialog appears when calibration is completed:

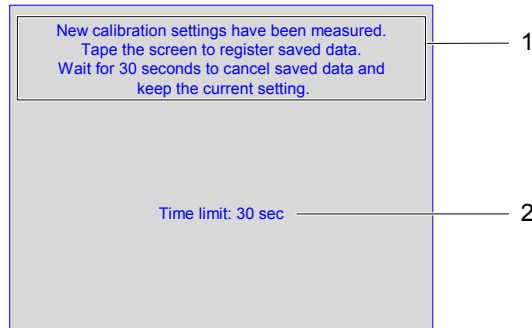

Figure 6-31 "Confirm Calibration" dialog

1 The new calibration values are measured. Touch the touchscreen to save the calibration values. The new calibration values will be discarded if you do not touch the touchscreen within 30 seconds of calibration.

2 Time remaining until the calibration values are discarded.

3. Save calibration

To save the calibration, press the touchscreen within 30 seconds. Otherwise, the calibration is discarded and the old settings remain valid.

6.4 Configuring transfer mode for the TP 170A

"Transfer Settings" dialog

The HMI device data channels must be configured to enable data exchange with the PLC or with the configuration computer.

Select "Transfer > Transfer Settings" in the loader. The following dialog appears:

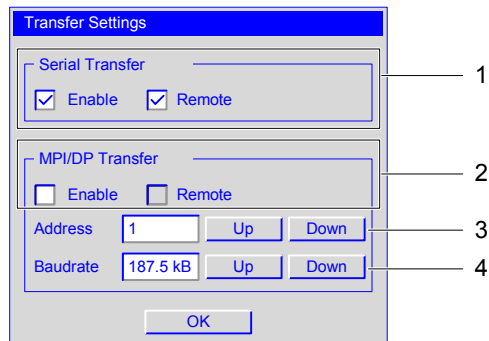

Figure 6-32 "Transfer Settings" dialog

- 1 Group for the serial transfer settings
- 2 Group for the MPI/PROFIBUS DP transfer settings
- 3 Buttons for changing the address
- 4 Buttons for changing the baud rate

Note

Note the default settings in the "Transfer Settings" menu. The MPI/PROFIBUS DP transfer is not activated.

Set serial transfer

The "Serial Transfer" group is used to configure the serial interface for the transfer. The following setting can be made:

- "Enable" checkbox
 - Serial transfer is enabled if this checkbox is activated.
 - Serial transfer is disabled if this checkbox is deactivated.

Set MPI/PROFIBUS DP transfer

The "MPI/DP Transfer" group is used to configure the MPI/PROFIBUS DP interface for the transfer. The following setting can be made:

- "Enable" checkbox
 - The MPI/PROFIBUS DP transfer is enabled if this checkbox is activated.
 - The MPI/PROFIBUS DP transfer is disabled if this checkbox is deactivated.

Setting remote control

During transfer, remote control is used to automatically close a project running on an HMI device.

The following settings are possible:

- "Remote" checkbox
 - Automatic data transfer is enabled if this checkbox is activated.

In this operating mode, a project is automatically closed when a project transfer is triggered on the configuration computer.
 - Automatic data transfer is inhibited if this checkbox is deactivated.

In this operating mode, a project is not automatically closed when a project transfer is triggered on the configuration computer.

A transferred project is started automatically after the transfer.

The default settings for "Remote" are:

- Serial transfer "enabled"
- MPI/PROFIBUS DP transfer "disabled"

Set MPI/PROFIBUS DP address

Use the "Address" input field to enter the value for the MPI/PROFIBUS DP address for the HMI device. A value in the range from 0 to 126 is permissible. This value range can be restricted by a project which has already been transferred. Values outside of the range are rejected, an error message appears and new values can be reentered.

Note

MPI/PROFIBUS DP address

During data transfer via MPI/PROFIBUS DP, note the addresses of the subscribers in the network. If a project is already loaded on the HMI device, the MPI/PROFIBUS DP address of the project is used.

The entry can be made using "Up" and "Down".

The default setting is "1".

Set Baudrate

Use the "Baud rate" input field to enter the baud rate value for the MPI/PROFIBUS DP transfer. The following settings can be made using "Up" and "Down":

- 19.2 KB
- 187,5 KB
- 1.5 MB
- 3 MB
- 6 MB
- 12 MB

If the HMI device subscriber is in an MPI/PROFIBUS DP network, the value to be entered is determined by the configuration of the MPI/PROFIBUS DP network. Select the corresponding value.

The default setting is "187.5 KB".

Notice

Address in MPI/PROFIBUS DP network

The value assigned in the "Address" input field may only be used once in a MPI/PROFIBUS DP network.

6.5 Configuring transfer mode for the TP 170B and OP 170B

6.5.1 S7-Transfer Settings

"S7-Transfer Settings" dialog

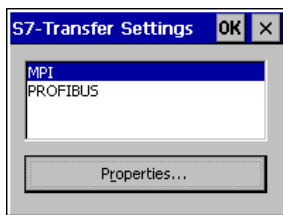

Figure 6-33 "S7-Transfer Settings" dialog

The "S7-Transfer Settings" dialog is used to set the following:

- Parameters for the HMI device
- Parameters for the MPI/PROFIBUS DP transfer
- Bus parameters

The available network connections are listed in the dialog.

Proceed as follows

After selecting one of the network connections listed, the associated parameters can be set. To view the parameters currently set, press "Properties." One of the following dialogs appears according to the network connection selected:

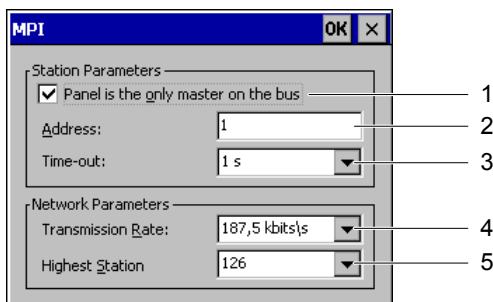

Figure 6-34 "MPI" dialog

- 1 The HMI device is the only master on the bus.
- 2 Bus address
- 3 Time out
- 4 Data transmission rate
- 5 Maximum number of subscribers

Activate the "Panel is the only ..." checkbox if no other device is defined as a master in the MPI/PROFIBUS DP network. Deactivate the checkbox if another device, e.g. a SIMATIC S7-400 PLC, is defined as master.

The default settings are displayed in the "MPI" dialog.

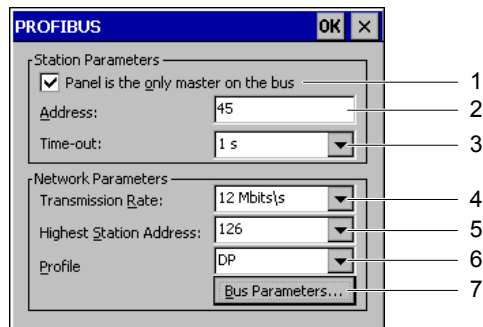

Figure 6-35 "PROFIBUS" dialog

- 1 The HMI device is the only master on the bus.
- 2 Bus address
- 3 Time out
- 4 Data transmission rate
- 5 Maximum number of subscribers
- 6 Bus profile
- 7 Button for opening the "Profile" dialog

Notice

Address in MPI/PROFIBUS DP network

The value assigned in the "Address" input field may only be used once in a MPI/PROFIBUS DP network.

To view the bus parameters currently set, press "Bus parameters." The following dialog opens:

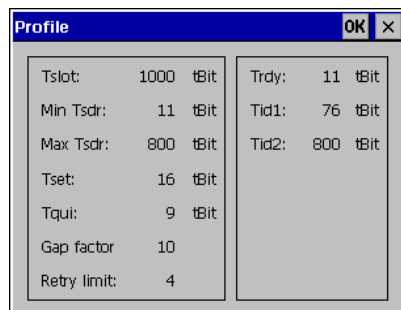

Figure 6-36 "Profile" dialog

The contents of the dialog cannot be changed. The values set for the transfer are displayed.

6.5.2 Transfer

"Transfer Settings" dialog

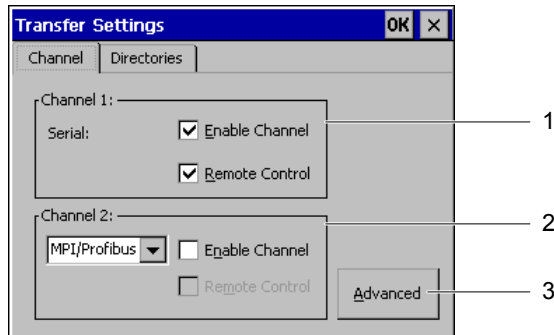

Figure 6-37 "Transfer Settings" dialog, "Channel" tab

- 1 Group for the data channel 1
- 2 Group for the data channel 2
- 3 Button for the "S7 Transfer Settings" dialog. See section "S7 Transfer Settings".

The "Transfer Settings" dialog contains the "Channel" and "Directories" tabs.

The "Channel" tab is used to configure data channels 1 and 2.

Set serial transfer

The "Channel 1" group is used to configure the serial interface for the transfer. The following settings are possible:

- "Enable Channel" checkbox
 - Serial transfer is enabled if this checkbox is activated.
 - Serial transfer is disabled if this checkbox is deactivated.

Notice

Deactivate the "Enable Channel" checkbox in the "Transfer Settings" dialog if a serial printer is connected to the IF2 interface of the HMI device.

Set MPI/PROFIBUS DP transfer

The "Channel 2" group is used to configure the interface MPI/PROFIBUS DP and Ethernet for the transfer. The following settings are possible:

- "Enable Channel" checkbox for MPI/PROFIBUS DP transfer and for Ethernet transfer
 - The channel is enabled if this checkbox is activated.
 - The channel is disabled if this checkbox is deactivated.

Setting Ethernet transfer

Ethernet transfer for the HMI devices TP 170B and OP 170B has not been approved.

Setting remote control

- "Remote Control" checkbox
 - Automatic data transfer is enabled if this checkbox is activated.
In this operating mode, a project is automatically closed when a project transfer is triggered on the configuration computer.
 - Automatic data transfer is inhibited if this checkbox is deactivated.
In this operating mode, a project is not automatically closed when the project transfer is triggered on the configuration computer.

A transferred project is started automatically after the transfer.

The default setting for "Enable Channel" and "Remote Control" is "deactivated".

Press the "Advanced" to access the "S7 Transfer Settings" dialog described in the section "S7 Transfer Settings". Settings can be made in the "S7-Transfer Settings" dialog regardless of whether data channels 1 and 2 are enabled.

Notice

Settings in "Project File" and "Path"

Do not change the settings in the "Project File" and "Path" fields when working with a project. The project may not open at the next start of the HMI if changes are made here.

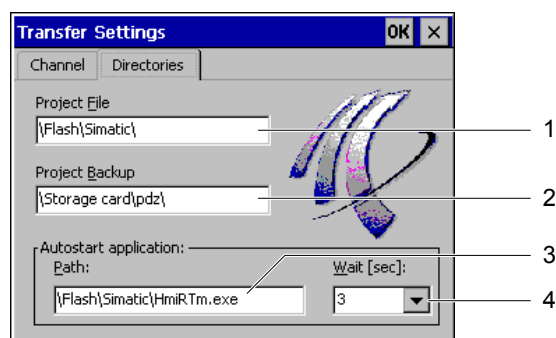

Figure 6-38 "Transfer Settings" dialog, "Directories" tab

- 1 Storage directory for the project file
- 2 Storage directory for the backup of the project file
- 3 Autostart directory for the runtime software
- 4 Delay period before the project starts

The "Directories" tab can be used to modify the preassigned storage location for a project file.

- "Project File"
Set the storage location for a project file here. The internal Flash memory and external memory card are available as storage locations. During the next transfer process, the project file is stored in the storage location specified.
- "Project Backup"
The predefined storage location for your project's source file can be changed here. The external memory card or the network connection can be defined as the storage location. During the next backup process, the project's source file is stored in the storage location specified.
- "Autostart application"
Use "Path" to define the storage location in the HMI device for the runtime software.

Use "Wait" to define how long the Start menu should be displayed or whether it should be displayed continuously before the project is started. Possible selections are 1 s, 3 s, 5 s, 10 s or constant. If no project is available, the unit automatically switches to transfer mode.

Proceed as follows

Proceed as follows to change the transfer settings:

1. Select the "Directories" tab.
2. Modify the entries
3. Discard or confirm the changes
4. Close the dialog

The Control Panel is displayed.

Note

Change during active transfer mode

If the HMI device is in transfer mode while changes are made to the transfer settings, the settings only go into effect after the transfer function is restarted. This can occur when the Control Panel is opened on the HMI device in order to modify the transfer properties.

See also

Runtime (Page 6-45)

6.6 Runtime

The program parts required to run a project must be present on the HMI device. The transfer is performed via

- the Windows CE Image for TP 170micro and TP 170A
- and via the project for TP 170B and OP 170B

Therefore:

- No installation is needed on the HMI device.
- The HMI device is immediately ready for use.

With a newer WinCC flexible version, it may be necessary to update the operating system.

See also

Transfer (Page 6-42)

Updating the operating system (Page 7-19)

Preparing and backing up a project

7.1 Transferring a project to an HMI device

7.1.1 Overview

Overview

Three procedures are available to transfer a project to the HMI device:

- Transfer

During the transfer, it is possible to specifically select whether to transfer recipes, passwords and compressed source files in addition to the project.

- Restoring on the HMI device

During a restore process, a project stored on a memory card is transferred to the internal Flash memory of the HMI device. A password list is not restored during the process.

- Restoring from PC using ProSave

The backup project is transferred from a PC on line. This transfer includes recipes if any have been saved. A password list is not restored during the process.

The procedures are the same both for the initial commissioning as well as recommissioning of a project.

Transfer and back transfer - backup and restore

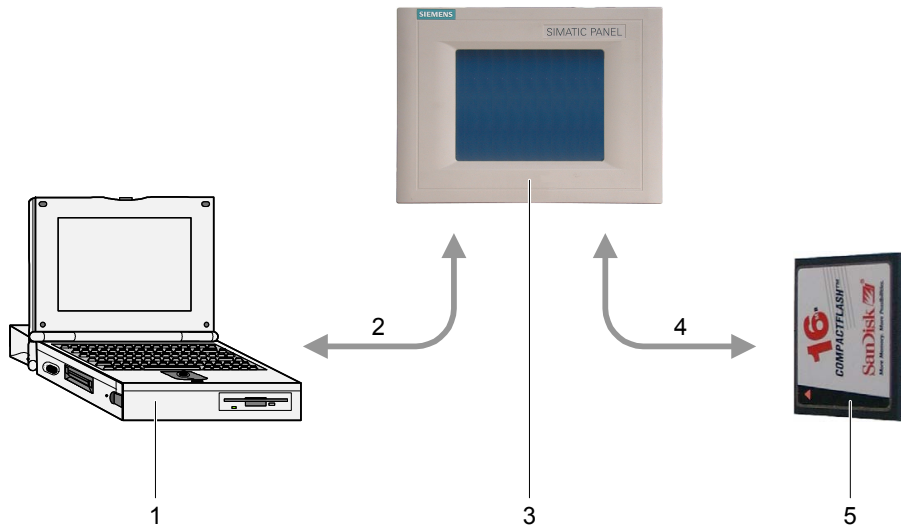

Figure 7-1 Schematic display of transfer and back transfer or backup and restore

- 1 Configuration computer with source file *.hmi
- 2 Downloading and uploading
- 3 HMI device with project file *.fwx
- 4 Backup and Restore
- 5 Memory card with compressed source file *.pdz

See also

- Start transfer (Page 7-6)
- Backup and restore project (Page 7-13)
- Restore project (Page 7-18)

7.1.2 Initial commissioning

Introduction

When commissioning for the first time, there is no project on the HMI device.

The procedure for transferring a project from the configuration computer to the HMI device, is described in the sections "Transfer", "Backup and restore project for TP 170B and OP 170B on memory card" and "Restore project".

7.1.3 **Recommissioning**

Introduction

When recommissioning, you replace an existing project on the HMI device with another. You can transfer a project from the configuration computer to the HMI device to accomplish this. The transfer is described in the section "Transfer."

The following options are available for switching the HMI device to transfer mode:

- During the startup phase of the HMI device
Manual start of the transfer mode is activated by pressing "Transfer" in the loader.
- During operation
Manual start of the transfer mode is activated by pressing an operator control in the project.
- During operation
Transfer mode is started automatically on the configuration computer.

The same project transfer options as those for initial commissioning are available.

See also

Transfer (Page 6-42)

7.1.4 **Setting the operating mode**

Conditions for changing operating modes

In order to switch between the operating modes described below on the HMI device, the relevant function must be configured and linked to an operating element.

Operating modes

The HMI device is designed for the following operating modes:

- Offline mode
- Online mode
- Transfer mode

An operating element in the project can be used to set "Offline" and "Online" operating modes on both the configuration computer and the HMI device.

Transfer mode must have been configured as an operating element.

Offline mode

In this mode, there is no communication connection between the HMI device and PLC. The HMI device can be operated but data cannot be transmitted to the PLC or received from the PLC.

Online mode

In this mode, a communication connection between the HMI device and PLC exists. When using this mode, processes in progress can be operated and visualized without restriction.

Transfer mode

In this mode, you can transfer a project from the configuration computer to the HMI device.

7.2 Transfer

7.2.1 Information and overview



Warning
Inadvertent transfer mode

Inadvertent transfer can trigger unwanted reactions on the system being monitored.

After the commissioning phase, deactivate the "Remote" or "Remote Control" checkbox in the "Transfer Settings" dialog to prevent an inadvertent transfer on the HMI device.



Warning
Changes to the bus parameters

In the case of PROFIBUS DP, changes to the bus parameters in the loader under "S7-Transfer Settings" should only be made for commissioning purposes. After activating transfer mode on the HMI device, the HMI device only defines a standard bus parameter set. In unfavorable conditions, this can lead to faults on the PROFIBUS DP bus.

In order to calculate the bus parameters exactly, the entire bus topology must be known.

Correct definition of the bus parameters for the project in the HMI device is automatically ensured by the integrated operation of WinCC flexible in SIMATIC STEP 7.

Notice

Transfer mode using MPI/PROFIBUS DP

For MPI/PROFIBUS DP transfer, the bus parameters, such as the MPI/PROFIBUS DP address and baud rate, are read from the project currently active on the HMI device.

The settings for the MPI/PROFIBUS DP transfer should not be changed. The project must first be stopped and the settings then changed via menu options "Control Panel > S7-Transfer Settings". Then switch back to transfer mode.

When the project is restarted, the bus parameters for the selected profile "MPI" or "PROFIBUS DP" are overwritten by the values in the project configuration.

Transfer settings

A project can only be transferred from the configuration computer to the HMI device when the "Enable Channel" checkbox is activated in the "Transfer Settings" dialog.

If an interface is assigned to other programs, transfer cannot take place via this interface.

Transferable data

The following data can be optionally transferred to the HMI device:

- the project, whereby a delta transfer is necessary.
- Recipe data
- the password list
- Project source file for the TP 170B and OP 170B

Transferred data is written directly to the HMI device's Flash memory. The project source file can also be transferred to the HMI device for processing a project later. Due to memory capacity, the source file is not transferred to the internal Flash memory but to the memory card.

To save transfer time, a delta transfer option is available for Windows CE HMI devices. In the case of a delta transfer, only project data that has changed relative to the data on the HMI device is transferred.

7.2.2 Start transfer

Introduction

There are two different options for the transfer:

- Manual transfer

Manual transfer means that the transfer mode must be started by the operator on the HMI device. The manual transfer can also be started when the checkbox "Remote" or "Remote control" is activated in the "Transfer Settings" dialog.

The HMI device can be switched to transfer mode manually while it is running. Manual start is particularly advantageous when inadvertent activation of automatic transfer must be ruled out.

- Automatic transfer

Automatic transfer means that the transfer mode need not be started by the operator on the HMI device.

The HMI device can be switched automatically to transfer mode during normal operation as soon as transfer is started on the configuration computer connected. Automatic startup is particularly suited for the test phase of a new project since transfer is completed without interfering with the HMI device.

Note

A project running on the HMI device is always closed before a transfer begins.

Requirement

- The HMI device is connected to a configuration computer.

Proceed as follows

Proceed as follows:

1. Switching on the HMI device.

The loader opens when the HMI device starts.

The following applies to manual transfer but not to automatic transfer:

2. Press "Transfer".

The "Transfer ..." dialog is displayed.

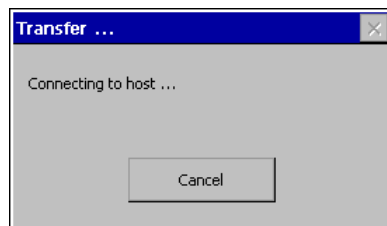

Figure 7-2 Dialog "Transfer ..."

Proceed as follows on the configuration computer:

Notice

Remote control of the HMI device

When the checkbox "Remote" or "Remote Control" is activated in the "Transfer Settings" dialog on the HMI device and the transfer is started on the configuration computer, a project running on the HMI device will be closed.

3. Start transfer

The configuration computer checks the connection to the HMI device. If there is no connection or the connection is faulty, an alarm appears on the configuration computer. If the connection is correct, the selected data is transferred to the HMI device.



Warning

Inadvertent transfer mode

Inadvertent transfer can trigger unwanted reactions on the system being monitored.

After the commissioning phase, deactivate the "Remote" or "Remote Control" checkbox in the "Transfer Settings" dialog to prevent an inadvertent transfer on the HMI device.

Result

When the transfer is successfully completed, the data is on the HMI device. The transferred project is then started automatically.

7.2.3 Testing project

Introduction

There are two options on the HMI device for testing a new project:

- Test project offline

Testing offline means that communication between the HMI device and PLC is interrupted while the test is being carried out.

- Test project online

Testing online means that the HMI device and PLC communicate with each other during the test.

It is advisable to perform both tests starting with the "Offline test" followed by the "Online test."

Note

Testing on a configuration computer

A project can also be tested on a configuration computer using the Simulator. Detailed information on this is available in the "WinCC flexible" user guide and in the WinCC flexible online help.

You should always test the project afterwards on the HMI device where the project will be used.

Check the following:

1. Check that configured screens are displayed correctly
2. Check screen hierarchy
3. Test input objects
4. Test softkeys
5. Tag data can be entered

The test increases the certainty that the project will run error-free on the HMI device.

Requirements for the offline test

- The project is on the HMI device.
- The project is offline.

To do this, open the project concerned on the configuration computer. Select "Communication > Connections" and switch to "Online: Off". Transfer the project to the HMI device.

Alternatively, the operating mode can be changed by means of an operating element in the project. Use the operating element to switch the project offline.

Note

During the test phase, it is recommended that the transfer operation be started during operation.

Procedure

Use "Offline" mode to test the individual project functions on the HMI device without them being affected by the PLC. PLC tags are, therefore, not updated.

Test the project operating elements and displays to the extent possible without connecting to the PLC. Procedure:

1. Check configured object are displayed correctly
2. Check screen hierarchy
3. Check input fields
4. Test softkeys

Conditions for the online test

- The project is on the HMI device.
- The project is online.

To do this, open the project concerned on the configuration computer. Select "Communication > Connections" and switch to "Online: On". Transfer the project to the HMI device.

Alternatively, the operating mode can be changed by means of an operating element in the project. Use the operating element to switch the project online.

Note

During the test phase, it is recommended that the transfer operation be started during operation.

Procedure

Use "Online" mode to test the individual project functions on the HMI device with influence being exerted by the PLC. PLC tags are updated in this case.

Test the project operating elements and displays. If offline testing has not yet been performed, proceed as follows:

1. Check configured object are displayed correctly
2. Check screen hierarchy
3. Check input fields
4. Test softkeys

Test all of the objects in the loaded project for which communication with the PLC is necessary:

- Alarms
- Alarm logging
- Recipes
- Screen selection by PLC through PLC job
- Print functions

See also

S7-Transfer Settings (Page 6-40)

Setting the operating mode (Page 7-3)

Configuring transfer mode for the TP 170A (Page 6-37)

7.2.4 Transferring a project back using the TP 170B and OP 170B

Introduction

If the "Enable BackTransfer" checkbox is activated on the configuration computer for transferring a project, the associated compressed source file is transferred during the transfer process. The back transfer from the HMI device to the configuration computer can then be performed.

After transferring a compressed source file back, it can be analyzed and modified when run. This is of particular importance if

- The original configuration computer cannot be accessed.
- the project source file is no longer available.

Requirement

The following are requirements for the HMI device in order to transfer a project back:

- The HMI device is connected to a configuration computer.
- The compressed source file associated with a project must be available on a memory card which is inserted in the HMI device.
- No project is open in WinCC flexible.

Back transfer

Following the back transfer onto the configuration computer, the compressed source file is decompressed by the WinCC flexible configuration software. The project is then available in *.hmi format on the configuration computer and can be edited.

Notice

Version number

Once transferred back, the compressed source file can only be opened in the configuration software when the following requirement is met:

The version number of the configuration software currently used is higher than or equal to the version number of the configuration software used to create the project.

Test source file

There is not text on the HMI device or by WinCC to check if the project file on the HMI device and the compressed source file on the memory card belong to the same project. If a transfer is performed when the "Enable BackTransfer" option deactivated, only the project file is transferred. Any source file on the memory card must therefore be from a previously transferred project.

Proceed as follows

Proceed as follows on the configuration computer:

1. Select the menu options "Project > Transfer > Communication Settings" in WinCC flexible.

The "Communication Settings" dialog box is opened.

2. Select the required connection type between the HMI device and configuration computer.
3. Define the connection parameters.
4. Select "Restore".

Proceed as follows on the HMI device:

1. Start the transfer mode in the loader.

Proceed as follows on the configuration computer:

1. On the configuration computer, use WinCC to start the back transfer using the "Project > Transfer > Back Transfer" menu options.

This starts the back transfer.

Result

The uploaded project is opened on the configuration computer.

7.3 Backup and restore project for TP 170B and OP 170B on memory card

7.3.1 Overview

Introduction

Backup and restore for a project on the TP 170B and OP 170B can be made to a memory card.

Data located on the HMI device can be saved and restored on the memory card of the HMI device. Backup and restore can be performed even when there is no online connection to a configuration computer.

The following data in the internal Flash memory can be saved and restored:

- Project
- Windows CE image
- Password lists and recipe data lists, if these were saved in the internal Flash memory

In order to make a copy of a project or restore a saved project on the HMI device, open the Control Panel and select the "Backup/Restore" dialog.

General notes

Notice

Power failure

If the restoring process is interrupted by a power failure on the HMI device, its operating system is deleted. In this case, the operating system must be transferred again. Refer to the "Update operating system" section.

Compatibility conflict

If a notification of a compatibility conflict appears on the HMI device during the restoring process, the operating system must be updated.

See also

Loader (Page 6-5)

Configure operating system (Page 6-1)

7.3.2 Backup and restore project

Introduction

During a backup, the data is copied from the HMI device's Flash memory to a memory card. The content of the memory card is overwritten following a system prompt.

When data is restored, the HMI device internal Flash card is deleted following a system prompt. After deletion, the backup content of the memory card is copied onto the internal Flash memory.

Notice

Password list

The password list is not saved during the backup.

Requirement

A memory card is required with a minimum memory capacity of 16 MB.

Procedure - backup

Proceed as follows:

1. Insert the memory card into the memory card slot.
2. Select "Backup/Restore" in the Control Panel
The "Backup/Restore" dialog opens.
3. Select "Restore".

If a memory card is not inserted to the HMI device, the "No storage card detected" alarm appears. Begin the procedure again from step 1.

Otherwise, the data backup will be started. If a data backup is already present on the memory card, the alarm "You may have an old backup on the storage card" Do you want to delete it?" is displayed..

Select "YES" to overwrite the existing data backup. Selecting "NO" terminates the procedure.

Following the data backup, the message "Backup successfully completed" appears. Press OK ...".

4. Press "OK".
5. Remove the memory card, if necessary.
This completes the backup.

Result

When the backup is successfully completed, a copy of the data on the HMI device is on the memory card.

Note

Label the memory card (with date and version) and keep the memory card in a safe place.

Procedure - restore

Proceed as follows:

1. Insert the memory card into the memory card slot.
2. Select "Backup/Restore" in the Control Panel

The "Backup/Restore" dialog opens.

3. Select "Restore".

If a memory card is not inserted to the HMI device, the "No storage card detected" alarm appears. Begin the procedure again from step 1.

Otherwise, a data analysis is performed. In the meantime, the message "Checking data" is displayed.

Following the data check, the following message appears: "You are starting RESTORE now. All installed ...". This message warns you that all existing data, including the registration data on the HMI device, will be deleted.

Selecting "YES" overwrites the data on the HMI device. Selecting "NO" terminates the procedure.

4. Press "YES".

When the data restore process is completed, the following message appears: "Restore of CE Image finished. The device ...". This informs you that the restore process is completed although the memory card cannot yet be removed.

5. Press "OK".

The HMI device starts. Otherwise, another data analysis is performed. Following the data check, the following message appears "Restore successfully finished. Press OK, remove ...".

6. Removing the memory card

7. Press "OK".

The HMI device starts.

Result

When the restore is successfully completed, the data of the memory card is available on the HMI device.

See also

Backup/Restore (Page 6-13)

7.4 ProSave

7.4.1 Overview

ProSave service tool

The ProSave service tool is supplied on "WinCC flexible" installation CD. ProSave provides all the functions which are necessary to transfer data between the configuration computer and HMI device.

The following data can be backed up and restored like during the transfer:

- Project
- Recipe data
- the password list
- Project source file for the TP 170B and OP 170B

ProSave can operate integrated in WinCC flexible or as a standalone tool on the configuration computer.

ProSave In WinCC flexible

ProSave is installed on the configuration computer together with WinCC flexible. The entire range of ProSave functions is then available in WinCC and ProSave dialogs can be opened in the opened project.

All the necessary specifications, e.g. HMI device and transfer settings, are taken from the project.

Standalone ProSave

ProSave can also be installed as a standalone application. In this case, information relating to the HMI device and the transfer must be set in the user interface of ProSave. Ensure that these settings agree with those in the HMI device.

The advantage of standalone ProSave is that backup and restore can be performed without WinCC flexible via the following transfer channels:

- Serial
- MPI/PROFIBUS DP

General notes

Notice

Power failure

If the restore process is interrupted by a power failure on the HMI device, its operating system is deleted. In this case, the operating system must be transferred again. Refer to the "Update operating system" section.

Compatibility conflict

If an alarm appears on the HMI device during the restore process indicating a compatibility conflict, the operating system needs to be transferred again. Refer to the section "Update operating system".

7.4.2 Backup project

Introduction

In the case of a backup process, the data to be saved is transferred from the HMI device Flash memory to a configuration computer. The following procedures are possible using ProSave:

- Backup using standalone ProSave
- Backup using WinCC flexible

The procedure for the backup differs in terms of the steps performed on the configuration computer.

Requirement

- The HMI device is connected to a configuration computer.
- ProSave is installed on the configuration computer.
- All applications are closed on the configuration computer.

Procedure - backup using standalone ProSave

Proceed as follows on the configuration computer:

1. Start ProSave.
2. Use the "General" tab register to select the HMI device and connection type with connection parameters.
3. Use the "Backup" tab to select the data to be saved:
 - "Recipes"
 - "Passwords"
 - "Complete Backup"

Only "Complete backup" is possible for the TP 170micro and TP 170A.

4. Select the folder in which the *.psb backup file should be saved.

Define the required transfer channel on the HMI device and switch the HMI device to transfer mode. Refer to the "Transfer" section.

Proceed as follows on the configuration computer:

1. Start the Backup process in ProSave with "Start Backup".

A status display appears indicating the progress of the backup process.

Procedure - backup using ProSave in WinCC flexible

Proceed as follows on the configuration computer:

1. Use "Project > Transfer > Transfer Settings" in WinCC flexible window "Select HMI devices for transfer" to select the corresponding connection type with related connection parameters.

2. Open the "Backup Settings" window in WinCC flexible using the menu commands "Project > Transfer > Backup".

3. Select the data to be copied:

- "Recipes"
- "Passwords"
- "Complete Backup"

Only "Complete backup" is possible for the TP 170micro and TP 170A.

4. Select the folder in which the *.psb backup file should be saved.

Define the required transfer channel on the HMI device and switch the HMI device to transfer mode. Refer to the "Transfer" section.

Proceed as follows on the configuration computer:

1. Start the backup process in WinCC flexible with "OK".

A status display appears indicating the progress of the backup process.

Result

When the backup is successfully completed, an alarm appears. The project is copied on the configuration computer.

7.4.3 Restore project

Introduction

During a restore process, a project data from the configuration computer is transferred to the internal Flash memory of the HMI device. The following procedures are possible using ProSave:

- Restore using standalone ProSave
- Restore using ProSave in WinCC flexible

The procedure for the restore process differs in terms of the steps performed on the configuration computer.

Notice

Data loss

The data in the internal Flash memory of the HMI device is deleted during restore.

Requirement

- The HMI device is connected to a configuration computer.
- ProSave is installed on the configuration computer.
- All applications are closed on the configuration computer.

Procedure - restore using standalone ProSave

Proceed as follows on the configuration computer:

1. Start ProSave.
2. Use the "General" tab register to select the HMI device and connection type with connection parameters.
3. In the the "Restore" tab, select the directory containing the source file to be restored.
"Content" indicates the HMI device is involved and the type of backup data contained in the selected file.

Define the required transfer channel on the HMI device and switch the HMI device to transfer mode. Refer to the "Transfer" section.

Proceed as follows on the configuration computer:

1. Start the restore process in ProSave with "Start Restore".

A status display appears indicating the progress of the restore process.

Procedure - restore using ProSave in WinCC flexible

Proceed as follows on the configuration computer:

1. In WinCC flexible use the menu command "File > Transfer > Settings" in the "Transfer Settings" window to select the connection type with corresponding connection parameters.
2. Open "Restore" in WinCC using the menu command "File > Transfer > Restore".
3. In the the "Restore" tab, select the directory containing the file to be restored.
"Content" indicates the HMI device is involved and the type of backup data contained in the selected file.

Define the required transfer channel on the HMI device and switch the HMI device to transfer mode. Refer to the "Transfer" section.

Proceed as follows on the configuration computer:

1. Start the restore process in WinCC flexible with "OK".
A status display appears indicating the progress of the restore process.

Result

When the restore is successfully completed, a message appears. The project is restored on the HMI device.

7.4.4 Updating the operating system

Introduction

When a new project is transferred to the HMI device, a compatibility conflict can arise due to the different versions of the configuration software and the image on the HMI device. In such a case, transfer of the project is stopped by the configuration computer and a message indicating a compatibility conflict appears. The operating system on the HMI device must then be updated. For this purpose, a current image must be transferred to the HMI device. The necessary operating system is transferred together with the image.

The service tool ProSave can be used for the update if the HMI device has no operating system or no functioning operating system - and even when there is an operating system.

Note

Version of the image

For the TP 170B and OP 170B, refer to the Control Panel "System Properties" dialog to see the version of the image loaded on the HMI device.

Requirement

- The HMI device is connected to a configuration computer.
- The associated data channel is configured.
- ProSave is installed on the configuration computer.

Notice

Data loss

When an operating system is updated, all of the data on the HMI device is deleted. Data on a memory card in the HMI device remains unaffected.

Updating the operating system

If no image or no operable image appears on the HMI device, the operating system must be updated via the RS 232 interface.

Procedure – update operating system without booting

When the operating system is updated without booting, the configuration computer communicates with the HMI device using its operating system.

Proceed as follows on the configuration computer:

1. Start WinCC flexible via the Windows Start menu and open a project or start ProSave via the Windows Start menu.
2. In WinCC flexible, select the menu options "Project > Transfer > Transfer Settings" or select the HMI device available on the "General" tab in ProSave.
3. Select a connection.
4. Enter the connection parameters.
5. In WinCC flexible, select the menu options "Project > Transfer > Update Operating System" or select the "OS Update" tab in ProSave.
6. Deactivate the "Booting" checkbox if it is already activated.
7. In "Imagepath", select the directory containing the image file, *.img, for the HMI device.
"Drive:\...\Siemens\SIMATIC WinCC flexible\WinCC flexible Images\Mobile_OP_TP170B"
8. Select "Open".

When the image file has been opened successfully, various information related to the version appears in a window.

Define the required transfer channel on the HMI device and switch the HMI device to transfer mode. Refer to the "Transfer" section.

Proceed as follows on the configuration computer:

1. Start the operating system transfer with "Update OS".

This process takes a different length of time, depending on the data channel selected. A status display monitors the progress of the transfer.

Procedure – update operating system with booting

When updating the operating system with "bootstrapping", ProSave communicates with the boot loader of the HMI device.

Notice

An operating system update with "bootstrapping" is only possible via the serial interface.

After starting the operating system transfer, the HMI device must be rebooted for the HMI device to establish contact via the serial interface.

Switch off the HMI device.

Proceed as follows on the configuration computer:

1. In WinCC flexible, select the menu options "Project > Transfer > Transfer Settings" or select the HMI device available on the "General" tab in ProSave.
2. Select a connection.
3. Enter the connection parameters.
4. In WinCC flexible, select the menu options "Project > Transfer > Update Operating System" or select the "OS Update" tab in ProSave.
5. Activate the "Booting" checkbox if it is deactivated.
6. In "Imagepath", select the directory containing the image file, *.img, for the HMI device.
"Drive:\...\Siemens\SIMATIC WinCC flexible\WinCC flexible Images\Mobile_OP_TP170B"
7. Select "Open".
When the image file has been opened successfully, various information related to the version appears in a window.
8. Start the operating system transfer with "Update OS".

Switch on the HMI device. This starts the transfer. A status display monitors the progress of the transfer.

Result

When the operating system update is successfully completed, a message appears. There is no longer a project on the HMI device.

See also

OP (Page 6-23)

Connecting the configuration computer (Page 4-12)

Runtime functionalities of a project

8.1 Screen objects

Overview

Runtime offers the following objects for operator control and display:

Screen object	TP 170micro, TP 170A	TP 170B, OP 170B
Button	Yes	Yes
Switch	Yes	Yes
IO field	Yes	Yes
Graphic IO field	Yes	Yes
Symbolic IO field	Yes	Yes
Alarm indicator	-	Yes
Alarm view	-	Yes
Simple alarm view	Yes	Yes
Alarm window	Yes	Yes
Recipes view	-	Yes
Simple recipe view	-	Yes
Bar	Yes	Yes
Trend view	-	Yes
Date/time field	Yes	Yes
User view	-	Yes
Simple user view	-	Yes

8.2 Alarms

Alarm classes

Alarms indicate events and states in the control process on the HMI. WinCC flexible distinguishes between the following alarm classes:

- Operation
Warning alarms indicate a process status, e.g. motor is ON. Warning alarms are configured.
- Error
Error alarms indicate operational malfunctions such as excess motor temperature. Error alarms are configured. Because of their importance, error alarms must be acknowledged.
- System
System alarms are triggered by the HMI device. They are not configured. System alarms provide information on occurrences such as operator errors or communication faults.
- STEP 7 alarm classes
The alarm classes configured in STEP 7 are also available for the HMI device.
- Custom alarm classes
It is possible to configure additional alarm classes.

Alarm buffer

All incoming, outgoing, and acknowledged alarm events are stored in an internal volatile buffer. The size of this alarm buffer depends on the type of HMI device.

Alarm report (TP 170B and OP 170B only)

If alarm reporting is activated, alarm events are sent directly to the connected printer.

It is possible to individually configure each alarm to specify whether it is to be reported (sent to the printer).

Alarm view

Events stored in the alarm buffer and the alarm log can be displayed in the alarm view in Runtime.

The alarm view is used to display alarms providing information on events that have occurred in a process. Whether alarm events have to be acknowledged or not is specified in your configuration.

Alarm window

If configured, an alarm window shows all pending alarms or alarms awaiting acknowledgement of a particular alarm class. The alarm window is displayed as soon as a new alarm occurs.

You can configure the order in which the alarms are displayed. You can choose to display the alarms in ascending or descending order of their occurrence. The alarm window can also be set to indicate the exact location of the fault, including the date and time of the alarm event.

Alarm indicator (TP 170B and OP 170B only)

An alarm indicator is a graphical symbol that is displayed on the screen if at least one error alarm is still pending on the HMI device.

The alarm indicator flashes as long as unacknowledged alarms are pending. The displayed number indicates the number of pending alarms.

8.3 Tags

Definition

Tags represent defined memory areas on the HMI device, to which values are written and/or from which values are read. This action can be initiated on the controller, or by the operator at the HMI device.

8.4 System functions

Application

System functions are used in Runtime for the following purposes:

- To control the process
- To utilize the properties of the HMI device
- To make system settings on the HMI device online

In WinCC flexible, all system functions and scripts are linked to an object, such as a button, key, or screen, and an event. As soon as the event occurs, the system function is triggered.

System functions

System functions are predefined functions that are used to implement many tasks in Runtime, such as:

- Calculations, e.g. increase of a tag value by a specific or variable amount
- Settings, such as changing the PLC or setting a bit in the PLC.
- Alarms, for instance after logon of a different user.

Events

The object and the selected function determine what events can be defined as triggers for executing a system function.

For example, the events "Change value", "BelowLowerLimit" and "AboveUpperLimit" belong to the "Tag" object. The "Loaded" and "Cleared" events are associated with the "Screen" object.

8.5 Safety

Overview

Operation in Runtime is protected by the use of user groups, passwords, and log-off times. After Runtime starts, you enter the user name and password in the logon dialog.

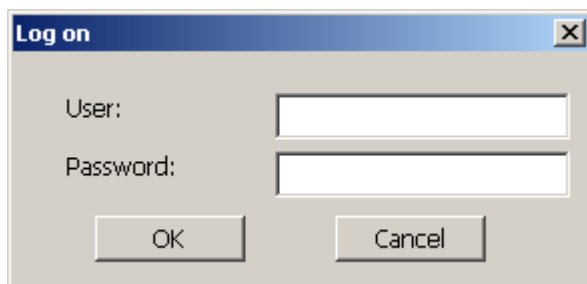

Figure 8-1 Logon dialog (TP 170B and OP 170B only)

Note

No default logon dialog is available for TP 170micro and for TP 170A.

For these HMI devices, use a screen created by the project engineer for logging on and off. The system functions "Logon" and "Logoff" are used for this.

User groups

The security concept of WinCC flexible has multiple levels for TP 170B and OP 170B: It is based on authorizations, user groups, and users.

- User groups are created for specific projects by the configuring engineer. The "Administrators" group is included in all projects by default. User groups are assigned authorizations. The authorization level required for an operation is specifically defined for each individual object and function in the project.
- User accounts are created by the configuring engineer and in Runtime by the administrator, or by a user with the same rights, and are always assigned to one group only.

Users belonging to a user group with "Administration" authorization may create further user accounts and assign these to a group.

Note

Except for the user "Admin" and the group "Administrators," no other users or user groups may be used for TP 170micro and for TP 170A.

Passwords

Only registered users may log on to Runtime by entering their user name and password. The passwords can be assigned by the configuring engineer, by the "Admin" user (or by users who have "Administration" authorization), or by the user himself.

Which functions a user may execute after he/she logs on depends on his/her user group assignment.

After the project is transferred, only the administrator is authorized to create user accounts, make user group assignments, and change passwords. Any other users who are subsequently assigned to the "Administrator" group by the administrator may also carry out these tasks.

The list will be encrypted and saved on the HMI device to protect it from loss due to a power failure.

Note

Depending on the transfer settings, changes to the password list are overwritten when the project is transferred again.

Logoff times

A logoff time is specified in the system for each user. If the time between any two user actions, e.g. entering a value or pressing a key, exceeds this logoff time, the user is automatically logged off. The user must then log on again to continue to operate Runtime.

User view (TP 170B and OP 170B only)

Use the User view to display the users present on the HMI device.

User	Password	Group	Logoff time
Administrator	*****	Administrators	5
Miller	*****	Programmer	5
Smith	*****	Operators	5

Export and import

All users, passwords, group assignments and logoff times furnished on the HMI device can be exported and reimported on another HMI device, when the configuration is suitable. This allows you to avoid entering all of the data again on another HMI device.

Notice

The currently valid passwords are overwritten during an import. The imported passwords are valid immediately.

8.6 Other operating functions

Printing functions (TP 170B and OP 170B only)

The following print functions are available on the HMI device:

- Hardcopy

You can print the content of the currently displayed screen if you utilize the "Print screen" system function in your configuration.

- Alarm report

Each alarm event that occurs (incoming, outgoing, acknowledgment) is also sent to a printer.

Note

Special, non-European characters

When printing non-West European alarms, some characters are not printed under certain circumstances. The printing results depend on the character set of the printer used.

LED control

The light-emitting diodes (LED) in the function keys of the SIMATIC HMI devices can be controlled from the PLC. For example, an illuminated or flashing LED can signal the operator to press a specific function key on the device.

Operating a project

9.1 Basic principles of operation

9.1.1 Basics for operation in Runtime

Introduction

The process control features are defined by the project configuration and the options available on the HMI device. This section contains general information on the settings for Runtime and for operation of predefined screen objects.

Screen objects provide general system functions. Screen objects can be used and configured in screens in the project.

Runtime can be controlled with the keys, using the touch screen, or via the keyboard and mouse, depending on the HMI device used.

Multiple key operation

Unintentional actions can be triggered by a multiple key operation.

- When you use a key device, you may not press more than two function keys simultaneously.
- If you are using a touch screen device, you may only operate one touch object at a time.

Language switching

WinCC flexible allows a multilingual project configuration. Up to five of these project languages can be loaded on the HMI device simultaneously.

Runtime allows you to change the languages, provided this function is configured. Language-specific objects such as texts or formats are localized. The following objects may contain language-relevant texts, for example:

- Alarms
- Screens
- Text lists
- Operator notes
- Recipes
- Date/time
- Static texts

Objects in the template screen

Objects that should be available on each screen are configured in the template by the configuring engineer, e.g., important process values or date and time.

An operating element that is present in the template is available in every screen. In the case of touch screen devices, for example, a button in the template screen simulates a globally effective function key.

Pictograms

In the case of keyboard devices, pictograms can be configured along the bottom and sides of the screen.

Pictograms highlight the screen-specific functions of the function keys. Activating the associated function key initiates the function symbolized by the pictogram.

9.1.2 Operating the touch screen device

9.1.2.1 Operating touch objects

Operation

Touch objects are touch-sensitive operating objects on the HMI screen, e.g. buttons, I/O fields and alarm windows. The operation of these is basically no different than the operation of conventional keys. You operate these objects by touching them with the finger.



Caution

Always touch only one object on the screen. Do not touch several touch objects simultaneously. You may trigger an unintended action.

Caution

Do not use any pointed or sharp objects when operating the touch screen in order to avoid damaging the plastic surface.

Direct keys

With a PROFIBUS DP connection, it is also possible to configure buttons for operation as direct keys in order to allow rapid operator inputs using keys. Rapid button operation is conditional for jog mode, for example.

PROFIBUS-DP direct keys place bits directly from the HMI device in the I/O area of a SIMATIC S7.

Note

With touch operation, direct keys are triggered independent of any configured password protection. Therefore, do not use password protection for direct keys.

Notice

Direct keys are still active when the HMI device is in the "offline" mode.

Button action feedback

The HMI device outputs an acoustic and optical signal as soon as it detects the operation of a touch object. This feedback is always output, irrespective of communication with the PLC. Therefore, this feedback does not indicate whether the relevant action is actually executed or not.

Visual feedback

The type of visual feedback depends on the operated touch object:

- Buttons

The HMI outputs different indications of the "Touched" and "Not touched" states, provided the programmer has configured a 3D effect:



Touched Untouched

The programmer defines the layout of a selected field (line width and color of the focus.)

- Hidden buttons

The focus of hidden buttons is not set after marking (focus width value is 0, default.) In Runtime, the outline of a touched button is indicated as a line when you modify the focus with value in the configuration data. This outline remains visible until the focus is set on another operating object.

- I/O fields

After you touch an I/O field, a screen keyboard appears as a feedback signal.

Operating screen objects with buttons

Screen objects with predefined buttons can also be operated with external buttons. The requires the programmer to have linked the relevant system functions to these buttons.

In WinCC flexible, these system functions are organized in the "Keyboard actions for screen objects" group.

9.1.2.2 Input of values

On-screen keyboard

The HMI device automatically opens the screen keyboard when you touch an input object such as an I/O field. This screen keyboard is also displayed to input of passwords for access to protected functions. The keyboard is automatically hidden again when input is complete.

Based on the configuration of the input object, the HMI device shows a screen keyboard only for the input of numeric or alphanumeric values.

The screen keyboard is activated by selecting an input object in runtime.

9.1.2.3 Inputting numeric values

Numeric screen keyboard

The HMI device automatically opens the numeric screen keyboard for the input of numeric values when you touch an I/O field on the screen. The HMI automatically hides the keyboard again when input is complete.

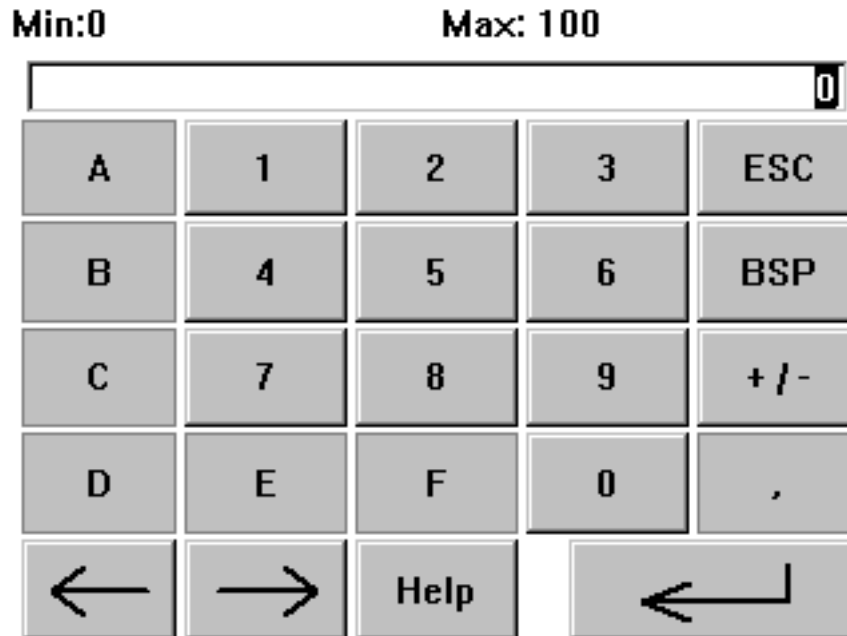

Figure 9-1 Example of on-screen keyboard for numeric inputs

The <Help> button is only active if an operator note is configured for the I/O field.

The <BSP> key corresponds to the <Backspace> key; it deletes the character to the left of the current cursor position.

On the on-screen keyboard, you can only operate the keys shown in the 3D display. Operability of keys is dependent on the type of value that is to be input.

Procedure

You enter numeric and hexadecimal values character-by-character using the on-screen keyboard buttons. You confirm the value entered by pressing <Enter> or cancel it by pressing <ESC>. Both functions will close the screen keyboard.

Note

The numeric input fields may be assigned limits. In this case, the system accepts only the values which lie within the configured range. The system rejects any values which are out of these limits and restores the original value. In this case, the HMI outputs a system alarm.

When the on-screen keyboard is displayed, the upper and lower limit values are displayed, if configured.

Note

When the on-screen keyboard is open, PLC job 51, "Select Screen" has no function.

9.1.2.4 Inputting alphanumeric values

Alphanumeric screen keyboard

The HMI automatically opens an alphanumeric keyboard for the input of strings and numeric values in hex format when you touch an input object on the screen. The HMI automatically hides the keyboard again when input is complete.

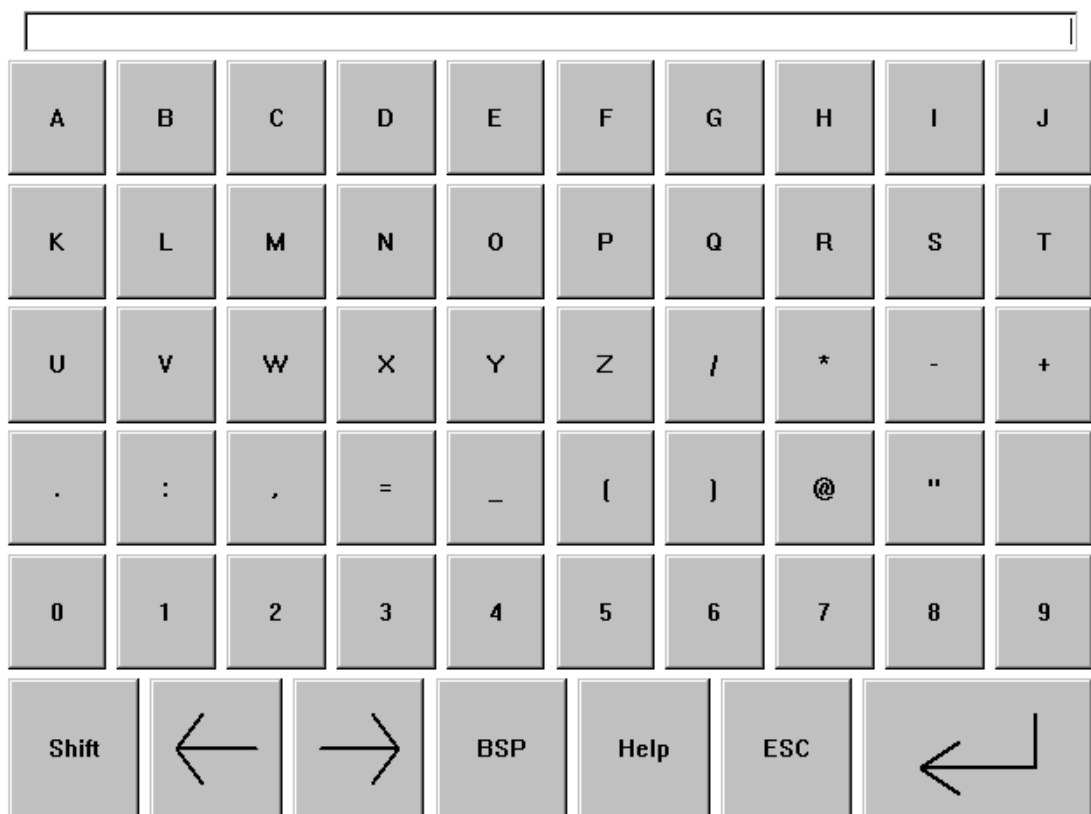

Figure 9-2 Screen keyboard for alphanumeric input

The <Help> is only active if an operator note is programmed for the input object.

The <BSP> key corresponds to the <Backspace> key; it deletes the character to the left of the current cursor position.

Keyboard layers

The alphanumeric keyboard is organized in several layers:

- Standard layer (refer to figure)
- <Shift> layer

Procedure

You use the screen keyboard buttons to input the characters of alphanumeric values. You confirm the value entered by pressing <Enter> or cancel it by pressing <ESC>. Both functions will close the screen keyboard.

Note

When the on-screen keyboard is open, PLC job "Select Screen" has no function.

9.1.2.5 Opening an operator note (TP 170B and OP 170B only)

Purpose

The operator notes provide additional information and operating instructions with respect to alarms, screen and operable screen objects to the programmer. A operator note may contain information about the permissible range of values for an I/O field, or information on the causes of alarm events and their elimination.

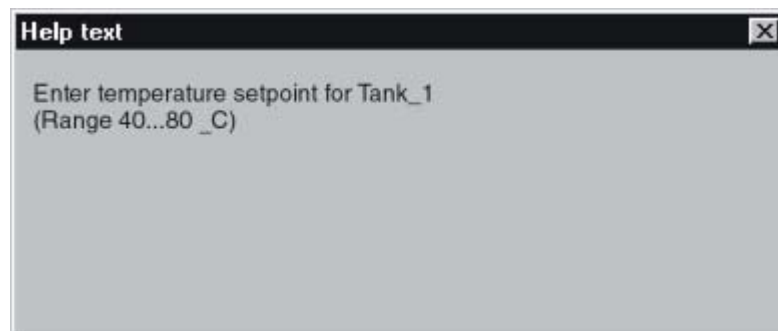



Figure 9-3 Operator note for an I/O field (Example)

Help on messages

Actuate the  button on the alarm screen or in the alarm view

Help on input objects

Touch the <Help> button on the screen keyboard. This button is only available if you configured an operator note.

Help on the current screen

Call the operator note for the current screen









Note









To view a new operator note, you first need to close the window showing the current operator note.

9.1.3 Operating a keyboard device

9.1.3.1 Functions of the system keys

Overview of system key functions













Key	Function	Purpose
	Shift (digits/letters)	<p>Toggles the assignment from numbers to letters.</p> <ul style="list-style-type: none"> No LED is lit: The number assignment is enabled. One actuation of the button toggles to letter assignment. One LED is lit: The left or right letter assignment is enabled. <p>Each time the key is pressed, the system toggles between the right letter assignment and number assignment.</p>
	Deleting characters	<ul style="list-style-type: none"> Deletes the character at the current cursor position.
	Cancel	<ul style="list-style-type: none"> Deletes the input characters of a value and restores the original value. Closes the active window.
	Acknowledge	<p>Acknowledges the currently displayed error alarm or all alarms of an acknowledgement group (group acknowledgement.)</p> <p>The LED is lit as long as unacknowledged error alarms are queued.</p>
	Display operator notes	<p>Opens the configured operator note for the selected object (e.g. a alarm, I/O field.) The LED signals an that an operator note exists for the selected object.</p>
	Enter	<ul style="list-style-type: none"> Applies and closes the input Opens a drop-down list for symbolic I/O fields Triggers buttons
	Tabulator	<p>Selects the next available screen object in the configured tab sequence.</p>
	Deleting characters	<p>Deletes the character to the left of the current cursor position.</p>

Key	Function	Purpose
   	Moving the cursor	<ul style="list-style-type: none"> Selects the next operable screen object on the right or left, above or below the current screen object. Navigates in the screen object.
	Scrolling back	Scrolls one page down.
	Scrolling up	Scrolls one page up.
	Shift (upper/lower case)	Use in key combinations, for example, for switching to uppercase letters.
	General control functions	Used in key combinations, for example, for navigating through trend views.
	General control functions	Used in key combinations, for example, for the "Status force" screen object.





9.1.3.2 Functions of the key combinations

General operation



Navigation

Shortcut keys	Function
 + 	Selects the previously available screen object in the configured tab sequence.
 +   +   +   + 	Positions the cursor within a screen object, for example, in an I/O field.
 + 	Opens a selection list.







Monitor screen settings

Shortcut keys	Function
 + 	Reduces the screen contrast.
 + 	Increases the screen contrast.

In the startup phase

Shortcut keys	Function
 + 	Toggles the HMI device to "transfer" mode. You can always exit transfer mode provided the unit is currently not transferring any data.

Dialogs

Shortcut keys	Function
	Jumps to the next field.
 + 	Jumps to the previous field.
	Opens the next tab if the focus is set on the name of this tab.
	Opens the previous tab if the focus is set on the name of this tab.
	Closes the dialog without saving.

Operating screen objects with softkeys

You may also operate screen objects with buttons, e.g. the alarm view, trend view, recipe view or status force, using softkeys. The programmer must have linked the corresponding system function to the softkey.

In WinCC flexible, these functions are organized in the "Keyboard actions for screen objects" group.

9.1.3.3 Calling the operator note

Purpose

The configuring engineer uses operator notes to provide additional information and operating instructions with respect to alarms, screens, and operable screen objects. An operator note may contain information about the permissible range of values for an I/O field (refer to figure below) or, in the case of an alarm, information on the causes of an alarm event and its elimination.

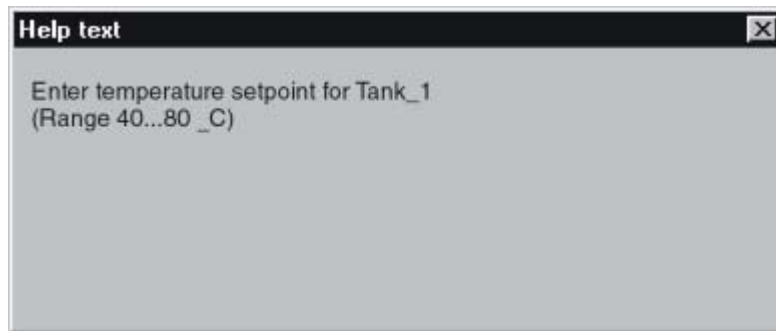



Figure 9-4 Operator note for an I/O field (Example)

Procedure

To display the operator note configured for an I/O field:

1. Select the I/O field, e.g. .

The I/O field is selected. The LED signal of the  key indicates that an operator note is available.

2. Press  to display the operator note.

The operator note is shown in the language currently set on the HMI device. Any operator note configured for the current screen is shown when you press the key again.

3. Close the Help window with the  key or by pressing the  key again.

Note

To view a new operator note, you first need to close the window showing the current operator note.

9.1.4 Close the project.

Proceed as follows

Notice

Data loss

If a memory card is inserted in the HMI device, close the project before switching off the power supply for the HMI device.

Proceed as follows:

1. Close the project using the operator control configured for this purpose.
Wait until the loader is displayed after runtime is stopped.
2. Switch off the power supply to the HMI device.

If the HMI device is inadvertently switched off during operation, the memory card is checked when it restarts. The defect memory areas on the card are repaired during the process.

9.2 Operating graphic objects

9.2.1 Button

9.2.1.1 Description

Purpose

A button is a virtual key on the screen of the HMI device that can have one or more functions.



You can initiate separate, independent functions with the following button operations:

- Press
- Release
- Activate the button in the tab sequence
- Deactivate the button in the tab sequence

Layout

A button can be labeled, use a graphic symbol or be hidden.

The operation may be followed with a visual feedback. However, note that the optical feedback only indicates a completed operation and not whether the configured functions were actually executed.

9.2.1.2 Touch control



Procedure

Touch the button on the touch screen of the HMI device.

9.2.1.3 Keyboard control

Procedure

To operate a button with a keyboard:

- Use the cursor to select the button, e.g. 
- Then press  or .

9.2.2 Switch

9.2.2.1 Description

Purpose

The switch is an control object and display object with two states: "pressed" and "released." Switches can signal the state of a system component that cannot be seen from the HMI device, e.g. a motor. You can also change the status of that system components at the HMI device.

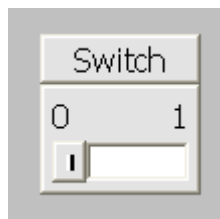

A switch has two stable states: When you actuate the switch, it changes to the other state. The switch retains this status until the next operation.

Layout

A switch can be labeled with a descriptive name, e.g. "Motor 2" and/or the names of its two states, e.g. "ON" and "OFF". The switch can be positioned vertically or horizontally.

9.2.2.2 Touch control

Procedure



Touch operation of a switch differs depending on the switch type:

- If a slider is displayed for the switch:
Move the slider on the touch screen of the HMI device to the new position, or double-click the slider area.
- If only a text or a graphic is displayed for the switch:
Touch the switch on the touch screen of the HMI device.

9.2.2.3 Keyboard control

Procedure

To operate a switch with a keyboard:

- Select the switch with a cursor key, e.g. 
- Then press  or .

9.2.3 IO field

9.2.3.1 Description

Purpose

You enter numeric or alphanumeric values in an IO field. An example of a numerical value is the number 80 as setpoint for a temperature. An alphanumeric value is the text "Service" as user name.



Layout

The layout of an IO field depends on its configuration in WinCC flexible, e.g.:

- Numeric IO field
For input of numbers in decimal, hexadecimal or binary format.
- Alphanumeric IO field
For input of character chains
- IO field for date and time
For input of calendar dates or time information. The format depends on the language set on the HMI device.
- IO field for password input
For concealed input of a password. The input character string is displayed with placeholders (*).

Behavior

If limit values are configured for the tag that is linked to the IO field, the input value is only applied if the value is within the configured limits.

Any input values which are out of range are rejected. The original value is displayed on the IO field instead, and a system alarm is output on the HMI device.

9.2.3.2 Touch control

Procedure

Press the IO field on the touch screen of the HMI device. The screen keyboard automatically appears. Enter the desired value using the screen keyboard. Confirm your input with <Enter> or cancel it with <Esc>. After the input has been confirmed or canceled, the screen keyboard is automatically closed.





9.2.3.3 Keyboard control

Procedure

Enable the I/O field with one or several  according to the configured tab sequence. The selection is signaled by the colored field content.

You now have two options:

- Position the cursor with  and a cursor key. The selection of the field content is cancelled. Type in the relevant value.

- Press . The object changes to the specific editing mode. Now, only one character will be marked in the field.
 - You can use the  /  cursor keys to scroll the character table.
 - The  /  cursor keys can be used to move to the next or previous input position.

Confirm your entry with  or cancel it with .

Note

To enter the hexadecimal characters "A" to "F" for numerical values, toggle the input keys using  to activate the letter assignment.

9.2.4 Graphic IO field

9.2.4.1 Description

Purpose

In a graphic IO field, select a predefined image from a selection list. The graphic represents the value of a tag. This can be an internal tag or a tag with a connection to a PLC.

The graphic IO field can also be used merely to output a pure graphic depending on the value of a tag. In this case, you cannot then operate the graphic IO field.

Layout

If the graphic IO field shows a cactus icon, you have not defined the graphic output of a specific value in your project.



9.2.4.2 Touch control

Procedure

Touch the graphic I/O field on the touch screen of the HMI device. Selection mode is activated.









Select the desired graphic using the scroll bar.

Apply the required graphic by touching it, or reject the selection by touching another screen object.

9.2.4.3 Keyboard control

Procedure

Operating a graphic I/O field on a keyboard device:

Step		Procedure	
1	Select the graphic I/O field	e.g. 	The graphic I/O field is marked.
2	Activate selection mode		The selection mode is activated.
3	Select the entry	   	Moves the cursor by lines.
4	Accept the selection		The selected entry is now valid. The selection mode is closed.
	or Cancel the selection		The function restores the original value.

9.2.5 Symbolic IO field

9.2.5.1 Description

Purpose

In a symbolic IO field select a predefined entry from a selection list. The entry represents the value of a tag. This can be an internal tag or a tag with a connection to a PLC.



The symbolic IO field can also be used to merely output an entry depending on the value of a tag. In this case, the symbolic IO field can no longer be operated.

Layout

If the symbolic IO field contains a blank text line in the drop-down list, you have not defined a relevant entry in the project.

9.2.5.2 Touch control

Procedure

Touch the symbolic IO field on the touch screen of the HMI device. The predefined entries are displayed in the selection list.









If the selection list has a scroll bar: Touch the scroll bar on the touch screen of the HMI device. Touch the touch screen continuously to move the scroll bar in the desired direction.

Select the desired entry and apply the associated tag value by touching the entry on the touch screen. The selection list is closed and the entry is displayed. The symbolic IO field continues to have the focus.

9.2.5.3 Keyboard control

Procedure

To operate a symbolic I/O field with a keyboard:

Step	Procedure		
1	Select the symbolic I/O field	e.g. 	The symbolic I/O field is marked.
2	Opens the selection list.		The drop-down list opens.
3	Select the entry	   	Moves the cursor by lines.
4	Accept the selection		The selected entry is now valid. The drop-down list is closed.
	or Cancel the selection		The function restores the original value. The drop-down list is closed.

9.2.6 Alarm indicator (TP 170B and OP 170B only)

9.2.6.1 Description

Purpose

The alarm indicator is a configurable graphic icon that is displayed on the screen as long as at least one alarm belonging to the specified alarm classes is pending on the HMI device.



Behavior

The alarm indicator flashes as long as unacknowledged alarms are pending. The displayed number indicates the number of pending alarms.

Note

The icons from the symbol library can only be operated by touch screen.

9.2.6.2 Touch control

Procedure

Touch the alarm indicator. An alarm window opens depending on the configuration.

Use the Close icon to close the Alarm window and be able to operate the screens. The alarm window can be opened again by touching the alarm indicator.

9.2.7 Alarm view (TP 170B and OP 170B only)

9.2.7.1 Description

Purpose

The Alarm view shows alarms or alarm events selected by the planner from the alarm buffer or, if supported by the HMI device, from the alarm log.



Layout



To be able to distinguish between different alarms classes, they are identified in the first column of the Alarm view:

Icon	Alarm class
!	Error
(empty)	Operation
(depending on configuration)	Custom alarm classes
\$	System

In Runtime you can configure the column order and the sorting order of each column.

Operator controls

The buttons have the following functions:

Button	Function
	Use this button to call the configured operator note for the selected alarm.
	This button triggers the function assigned to the "Edit" event for the selected alarm.
	This button is used to acknowledge an unacknowledged alarm.

9.2.7.2 Touch control

Procedure

Touch the desired operating element in the Alarm view on the touch screen of the HMI device.

Changing column sequence and sorting sequence

In Runtime you can configure the column order and the sorting order of each column.





- Change column sequence
To reverse the "Time" and "Date" columns, for example, touch the "Date" header on the HMI device touchscreen. Continue to press the touchscreen and drag the column heading to the "Time" heading.
- Change sorting order
To change the chronological order of the alarms, touch the column heading, "Time" or "Date" on the HMI device's touchscreen.



9.2.7.3 Keyboard control

Procedure

There is also a tab order in the alarm view for the list showing displayed alarms and all configured buttons.

Proceed as follows to acknowledge an alarm using the keys.

1. Activate the alarm view using , according to the tab order.
2. Select the alarm to be acknowledged. The , ,  and  keys can be used for this.

3. Press and hold the  key until the button to be acknowledged is selected.
4. Press the  key.

9.2.8 Simple alarm view

9.2.8.1 Description

Purpose

On an HMI device with a small display, the simple alarm view is used to display and edit alarms.

Layout



The display of the simple alarm view depends on the configuration.

- The display shows all current, departed or acknowledged alarms of the selected alarm classes.
- The number of lines per alarm and the visible lines.



Operator controls

The buttons have the following functions:

Button	Function
	This button is used to acknowledge an unacknowledged alarm.
	This button triggers the function assigned to the "Edit" event for the selected alarm.
	Use this button to call the configured operator note for the selected alarm.

9.2.8.2 Touch control

Procedure







Touch the desired control object in the alarm view on the touch screen of the HMI device.

9.2.8.3 Keyboard control

Procedure

The simple alarm view also has a tab order for the list showing displayed alarms and all configured buttons.

Proceed as follows to acknowledge an alarm using the keys.

1. Activate the simple alarm view using , according to the tab order.
2. Select the alarm to be acknowledged. The , ,  and  keys can be used for this.
3. Press and hold the  key until the button to be acknowledged is selected.
4. Press the  key.

9.2.9 Bar

Purpose

The bar is a dynamic display object. The bar displays a value from the PLC as a rectangular area. The operator at the HMI device can thus see immediately how far the current value is from the configured limit value or whether a setpoint value has been reached. The bar can display values such as fill levels or batch counts.

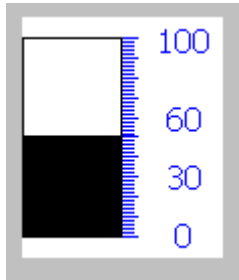

Layout

The layout of the bar is set in the user program. In the bar, for example, lines can identify the configured limit values. Color changes can signal when a limit value has been exceeded or not been met.

Operation

The bar is for display only and cannot be controlled by the operator.

9.2.10 Trend view (TP 170B and OP 170B only)

9.2.10.1 Description

Purpose

The trend view is a dynamic display object. The Trend view can display actual process data and process data from a log continuously when it is supported by the HMI device.

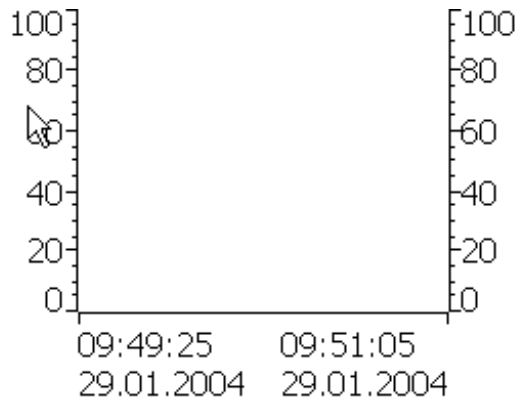



Layout







The layout of the trend view is based on the configuration. A trend view can show multiple curves simultaneously to allow the user, for example, to compare different process sequences. If the displayed process value exceeds or falls below the configured limit values, the violation of the limit can be displayed by a change of color in the curve.

A ruler can also simplify the reading of the process values from the trend view. The ruler displays the Y-value that belongs to an X-value.

Operator controls

The trend view is operated by the configured trend display buttons. If no buttons have been configured for the trend view, you can operate the trend view using the keyboard or the function keys of the HMI device. Prerequisite is that the project engineer has configured and documented this type of operation.

Operator control element	Function
	Scrolls back to the beginning of the trend recording. The start values of the trend recording are displayed there.
	Zooms the displayed time section

Operator control element	Function
	Zooms out of the displayed time section
	Moves the ruler backward (to the left).
	Moves the ruler forward (to the right).
	Scrolls one display width backward (to the left).
	Scrolls one display width forward (to the right).
	Shows or hides the ruler. The ruler displays the X-value associated with a Y-value.
	Stops or continues trend recording

9.2.10.2 Touch control

Procedure



Touch the desired control object in the trend view on the touch screen of the HMI device.



9.2.10.3 Keyboard control

Procedure

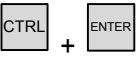
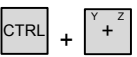
Activate the trend view with  using the tab order configured.

The table below shows the available shortcut keys.

Keys	Function
	Scrolls back to the beginning of the trend recording. The start values of the trend recording are displayed there.
	Zooms the displayed time section.
	Zooms out of the displayed time section.

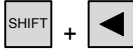
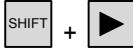
Keys	Function
	Moves the ruler backward (to the left).
	Moves the ruler forward (to the right).
	Scrolls one display width backward (to the left).
	Scrolls one display width forward (to the right).

9.2.11 Date/time field

9.2.11.1 Description

Purpose

The date / time field indicates the system time and data. In Runtime, you may change the system time and data in accordance with the configuration.

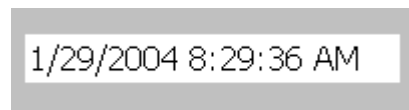

Layout

The layout in the date/time field depends on the language set in the HMI device.

Behavior

An input values other than the date and system time are rejected. Instead, the original values (plus the time that has elapsed in the meantime) will appear in the date/time field and a system alarm will be displayed on the HMI device.

9.2.11.2 Touch control

Procedure





Touch the date/time field on the touch screen of the HMI device. The screen keyboard automatically appears. Enter the desired value using the screen keyboard. Confirm your input with <Enter> or cancel it with <Esc>. After the input has been confirmed or canceled, the screen keyboard is automatically closed.

9.2.11.3 Keyboard control

Procedure

Enable the date/time field with one or several , according to the configured tab sequence. The selection is signaled by the colored field content.

You now have two options:

- Use the cursor keys to position the cursor and then enter your value.
- Press . The object changes to the specific editing mode. Now, only one character will be marked in the field.
 - You can use the  /  cursor keys to scroll the character table.
 - The  /  cursor keys can be used to move to the next or previous input position.

Confirm your entry with  or cancel it with .

9.2.12 User view (TP 170B and OP 170B only)

9.2.12.1 Description

Purpose

The user view is used by the administrator to manage user accounts, group assignments and user passwords.

Users can change their passwords and logoff times.

User	Password	Group	Logoff time
Administrator	*****	Administrators	5
Miller	*****	Programmer	5
Smith	*****	Operators	5

Layout

The user view contains four columns for the user, password, group and log-off time. The passwords are encrypted by means of asterisks.

- The users in the "Administrators" group can view all existing users in the user view, change all entries and create new user accounts.
- Other users only see a single line in the user view showing their own user name.

If the name or password of a logged on user is entered, a system alarm is output.

Export and import

A user view contains all users, passwords, group assignments and logoff times set up on the HMI device. To eliminate the necessity of reentering all data again on another HMI device, you can export the user view, and then import it to another device. However, this is only possible if this function has been configured.

Note

Do not export the password list immediately after changing it. Exit the "User view" object after making changes and wait until the changes have been written to the internal Flash memory before performing the export.

Notice

The currently valid passwords are overwritten during an import. The imported passwords are valid immediately.

9.2.12.2 Touch control

Procedure

To create a new user, touch an empty line. Then use the screen keyboard to type in the user name and confirm your entry with <Enter>. Assign a password and a logoff time in the same way and then select the group.

To change user data, touch the relevant field and make the change.

9.2.12.3 Keyboard control

Procedure

Select the user view with  according to the configured tab sequence.

- To create a new user, select an empty line using the cursor keys and press .

Enter the user name and press . Use  to go to the next field and repeat the procedure.

- To change the user data, select the desired line using the cursor keys and press .

Make the desired changes and complete the action by pressing .

9.2.13 Simple user view (TP 170B and OP 170B only)

9.2.13.1 Description

Purpose

On HMI devices with a small display, the simple user view is used to display users on the HMI device.

Layout

Users in the "Administrators" group see all existing users in the user view.

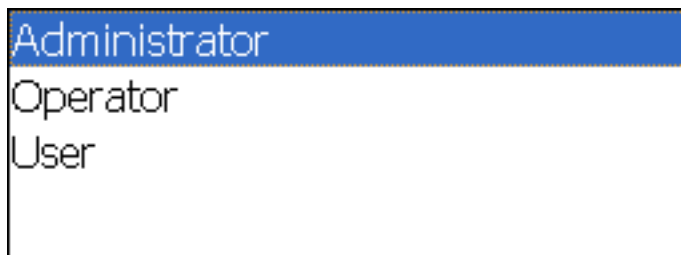

Other users only see a single line in the user view showing their own user name.

9.2.13.2 Touch control

Procedure



Touch the relevant entry in the simple user view on the touch screen of the HMI device.
Use the screen keyboard to input data.

9.2.13.3 Keyboard control





Entering custom user data

Custom user data (name, password, group, logoff time) is entered sequentially in several dialogs.

Procedure

Select the simple user view with , using the tab order configured. Select one of the users displayed using the cursor keys and press .

The following table shows the available key operations for entering custom user data in the dialogs:

Key	Function
 	Selects the previous/next user
	Selects the next element in the dialog
	Opens the next dialog

Operating recipes

10.1 Structure of a recipe

Introduction

A product often has several variants. For example, product variants can differ with respect to size or quality. This condition is accurately reflected in a recipe.

Principle

A recipe consists of recipe data records containing values. The structure of a recipe is explained using the example of a filing cabinet.

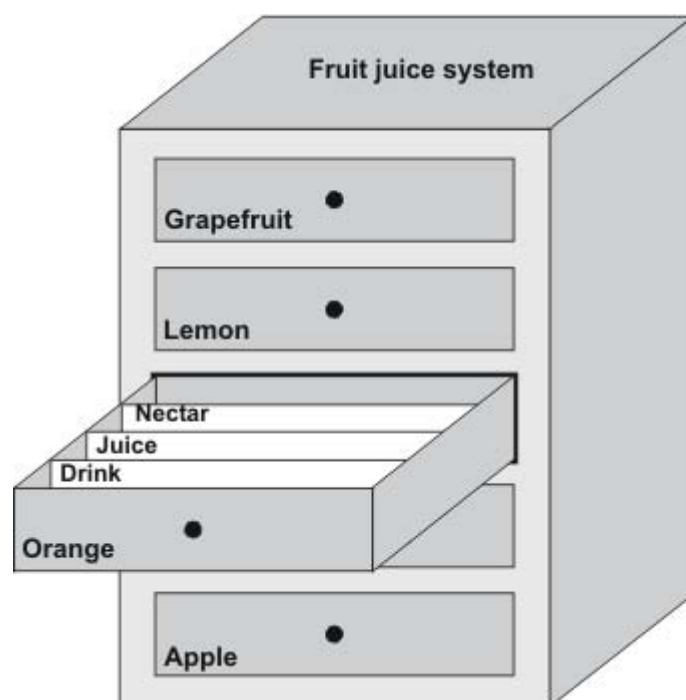

Each recipe represents a drawer of the file cabinet shown, and thus precisely one product. If the fruit juice mixing plant is producing orange, apple, and tropical fruit flavors, you would then configure one recipe for each flavor.

You define the recipe elements in the recipe. A recipe element consists of the display name and a tag. The display names are indicated in the recipe data records and on the HMI device in the recipe view. In Runtime, the appropriate tag value is read from the controller or transferred to the controller.

10.2 Structure of a recipe data record

Introduction

A recipe data record corresponds to a file card in an individual drawer and thus to a single product variant. If the fruit juice mixing plant is producing juice, nectar, and fruit drinks, you would then create a recipe data record in the recipe for each product variant. In this case, the product variants consist of the different mixing ratios for the ingrediants.

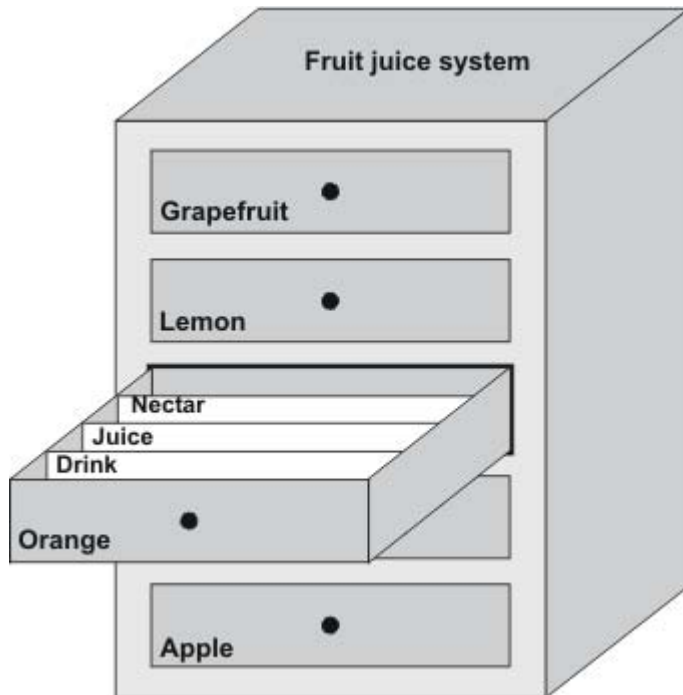

A recipe data record is a set of values for the tags defined in the recipe. You enter the values in the input fields. You can enter the values either during configuration or during runtime on the HMI device or the machine.

Elements		Data records					
	Name	Display name	Numb...	Water	Concentrate	Sugar	Aroma
☰	Beverage	Beverage	1	30	70	45	600
☰	Nektar	Nektar	2	50	50	10	300
☰	Juice	Juice	3	5	95	3	100

To produce a product, you transfer the appropriate recipe data record from the HMI device to the connected controller. The values in the recipe data record cannot be changed on the HMI device unless the configuring engineer has provided for this.

Editing recipe data records

You can edit recipe data records during configuration or in runtime on the HMI device.

- During configuration, you can define recipes in the "Recipes" editor in the "Elements" tab. You can enter values in the recipe data records in the "Data records" tab.
- During runtime, you have the option of entering recipe data record values directly on the HMI device or importing them via a CSV file. You can also export the recipe data records to a CSV file.

10.3 Recipe in the project

Overview

Recipes are a collection of associated data, e.g. machine configuration or production data. You can transfer these data, for example, from the HMI device to the controller in a single step in order to change the production variant. If you have programmed directly at the machine, for example, you can transfer the data to your HMI device and write these to the recipe.

Operating recipes in Runtime

WinCC flexible offers two options of viewing and editing recipes and the corresponding recipe data records in Runtime on the HMI device:

- Recipe views
- Recipe screen

Recipe views

The recipe view is a screen object that is configured in the "Screens" editor. For example, you can specify what operating function the recipe view will have in Runtime:

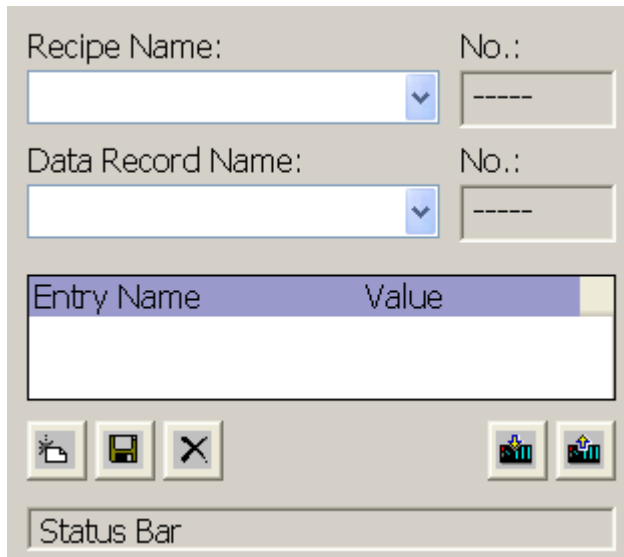

The screenshot shows a configuration dialog box for a recipe view. It contains the following elements:

- Recipe Name:** A text input field with a dropdown arrow.
- No.:** A numeric input field with a dashed line indicating a range.
- Data Record Name:** A text input field with a dropdown arrow.
- No.:** A numeric input field with a dashed line indicating a range.
- Table:** A table with two columns: "Entry Name" and "Value". The table is currently empty.
- Buttons:** A set of icons for file operations (New, Open, Save, Close) and a set of icons for data visualization (Bar chart, Line chart).
- Status Bar:** A text input field at the bottom.

The recipe view shows recipe data records in tabular form. The Recipe view is particularly useful if data records are small in size or only a few values are to be modified.

Recipe screen

A recipe screen represents a process screen which you configured as individual input screen form by means of an individual layout of IO fields and other screen objects in the "Screens" editor. This makes it possible for you to input parameter data in the context of machine visualization. The I/O fields for a recipe can be distributed over multiple recipe screens, with topical organization of recipe elements, for example. The operating functions for the recipe screens must be configured explicitly in the process screens.

10.4 Display recipes

10.4.1 Display and edit recipe

Introduction

The WinCC flexible ES offers you two configuration options of viewing and editing recipes and their corresponding data records in Runtime on the HMI device:

- Recipe views
- Recipe screen

Recipe views

The recipe view is a screen object that is configured in the "Screens" editor. For example, you can specify what operating function the recipe view will have in Runtime:

The screenshot shows a configuration dialog box for a recipe view. It has the following elements:

- Recipe Name:** A text input field with a dropdown arrow.
- No.:** A text input field containing "-----".
- Data Record Name:** A text input field with a dropdown arrow.
- No.:** A text input field containing "-----".
- Table:** A table with two columns: "Entry Name" and "Value". The table is currently empty.
- Buttons:** A row of icons for file operations: a folder icon, a floppy disk icon, a close icon (X), a bar chart icon, and a pie chart icon.
- Status Bar:** A text input field at the bottom containing the text "Status Bar".

The recipe view shows recipe data records in tabular form. The Recipe view is particularly useful if data records are small in size or only a few values are to be modified.

Simple recipe view

On HMI devices which have a display smaller than 6" (e.g. OP 77B), the simple Recipe view is used to display and edit recipes.

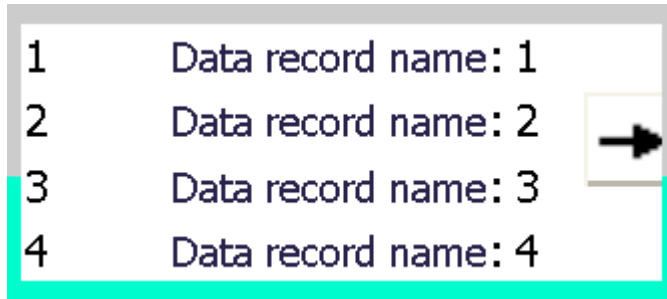

The simple recipe view consists of three areas:

- Recipe selection
- Recipe data record selection
- Recipe entries

In the simple recipe view, each area is shown separately on the HMI device. The simple recipe view always begins with the recipe selection.

Recipe screen

A recipe screen is a process screen with a customized input screen form that you create by setting up input/output fields and other screen objects in the "Screens" editor. This makes it possible for you to input parameter data in the context of machine visualization. The I/O fields for a recipe can be distributed over multiple recipe screens, which allows you a topical organization of recipe elements. The operating functions for the recipe screens must be configured explicitly in the process screens.

Litre Water	50	Recipe name	No.:
Litre Concentrate	50	Orange	1
Kilo Sugar	30	Data record name	No.:
Gram Aroma	50	Nectar	2
		Save	Data to PLS
		Load	Data from PLS

10.4.2 Behavior of the recipe view

Screen change

If you change to another screen and have not yet saved changes to the recipe data in the recipe view, you will be prompted to save the recipe data. The recipe name and the name of the recipe record are displayed to show which recipe data have not been saved yet.

If you change to a process screen that contains a recipe view with loaded recipe data, the recipe data will be automatically updated.

Operating the recipe view with softkeys

The Recipe view can be operated with function keys, e.g. when the HMI device does not have touch functionality. System functions allow you to assign functions such as "Save data record" to the function keys of the HMI device.

10.5 Recipe view (TP 170B and OP 170B only)

10.5.1 Description

Purpose

The recipe view is a screen object that is used in runtime to display and edit recipe records.

Layout

The functions of the recipe view can be configured. To use the Recipe view on small panels, a simple view is also available, for example.

Different settings are also possible for whether the recipes available in the recipe view can only be selected or can also be changed.









Behavior

If you change to another screen and have not yet saved changes to the recipe data in the recipe view, you will be prompted to save the recipe data. The recipe name and the name of the recipe record are displayed to show which recipe data have not been saved yet.

When you change to a screen that contains a recipe view loaded with recipe data, the recipe data is automatically updated.

Operator controls

The following operator controls can be configured in the recipe view:

Operator control element	Function
	Displays the configured operator notes of the given recipe view.
	Creates a new recipe record in the recipe that is displayed in the specified recipe view. The recipe record values are preset with the values that were specified as "Default value" when the recipe was configured.
	Saves the recipe data record which is currently displayed in the recipe view. The storage location is determined during configuration in the properties view for the recipe.
	Saves the recipe record currently being displayed in the recipe view under a new name. The storage location is determined during configuration in the properties view for the recipe.
	Deletes the recipe record that is displayed in the recipe view from the data medium of the HMI device.
	Synchronizes the values of the recipe record that is currently displayed in the recipe view with the associated tags. During synchronization, all values of the recipe record are written to the associated tags. Then the values are read from the tags and used to update the values in the recipe view.
	Transfers the recipe record, which is currently displayed in the recipe view, to the connected PLC.
	Transfers the recipe record, which is currently loaded in the PLC, to the HMI device and displays it in the recipe view.

10.5.2 Touch control

Procedure

Touch the desired operating element in the Recipe view on the touchscreen of the HMI device.















Use the screen keyboard to enter values.

10.5.3 Keyboard control

Procedure

Activate the recipe view using , according to the configured Tab order.

The table below shows the shortcut keys used to control the recipe view.

Shortcut keys	Function
 + 	Creates a new recipe record in the recipe that is displayed in the specified recipe view. The recipe record values are preset with the values that were specified as "Default value" when the recipe was configured.
 + 	Saves the recipe data record which is currently displayed in the recipe view. The storage location is determined during configuration in the properties view for the recipe.
 + 	Saves the recipe record currently being displayed in the recipe view under a new name. The storage location is determined during configuration in the properties view for the recipe.
 + 	Deletes the recipe record that is displayed in the recipe view from the data medium of the HMI device.
 + 	Synchronizes the values of the recipe record that is currently displayed in the recipe view with the associated tags. During synchronization, all values of the recipe record are written to the associated tags. Then the values are read from the tags and used to update the values in the recipe view.
 + 	Transfers the recipe record, which is currently displayed in the recipe view, to the connected PLC.
 + 	Transfers the recipe record, which is currently loaded in the PLC, to the HMI device and displays it in the recipe view.

10.6 Simple recipe view (TP 170B and OP 170B only)

10.6.1 Description

Purpose

On an HMI device with a small display, the simple recipe view is used to display and edit recipes.

Layout

The simple recipe view consists of three areas:

- Recipe selection
- Recipe data record selection
- Recipe entries

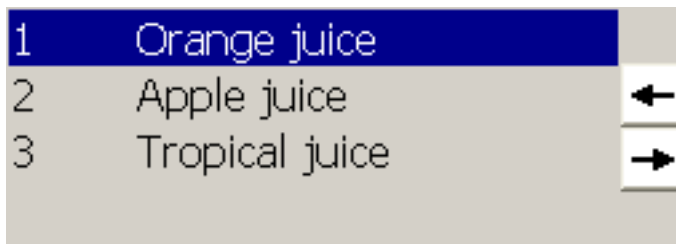



In the simple recipe view, each area is shown separately on the HMI device. The simple recipe view always begins with the recipe selection.

Behavior

A command option selection can be called in for each display area by pressing the  button. The command selection lists those commands that are available in the current display area. Each command is assigned a number which you can use to select it directly from the list (without using the <Enter> key).

Operator controls

The buttons have the following functions:

Button	Function
	Returns to the previous selection
	Calls up the shortcut menu commands.

10.6.2 Touch control

Procedure





Touch the desired control object or list entry in the simple recipe view on the touch screen of the HMI device.



10.6.3 Keyboard control

Procedure

Each command for processing recipes and recipe records is assigned a number that is shown in the command selection. You can select the command directly by pressing the corresponding number key on the HMI device.

The following table lists the key combinations for controlling the simple recipe view:

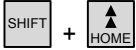
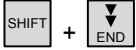
Shortcut keys	Function
	Calls the shortcut menu commands.
 + 	Selects the previous/next entry.
 	Scrolls one page up or down and selects the corresponding entry.

Shortcut keys	Function
 + 	Selects the first/last entry.
	Returns to the previous selection
	Displays the recipe data records or recipe elements according to the selection.

10.7 Operating recipe data record

10.7.1 Recipe data record administration

Recipe data record administration

In Runtime you can, based on the configuration

- Create new recipe data records
- Copy recipe data records
- Edit recipe data records
- Delete recipe data records

That is, you can either edit recipe data records in the recipe view or screen, or import recipe data records from a CSV file.

Creating new recipe records

1. Select the recipe on the HMI device in which you want to create a new recipe data record.
2. Use the "Add data record" button in the recipe view or the corresponding button on the HMI device that has this function.

A new data record with the next available number will be created. If you change the new data record number of an existing data record number, the data record is overwritten.

3. Enter a name for the recipe data records.
4. Enter the values for the recipe data records.
The configuration data may already contain default values for the recipe data record.
5. Use the "Save" button in the recipe view or the corresponding button on the HMI device that has this function.

Result

The new recipe data records will be saved to the selected recipe. If the recipe data records already exists, a system alarm will be output to the screen.

Copying a recipe data record

You copy a recipe record by saving it under a new name.

1. Select the recipe on the HMI device in which you want to edit an existing recipe data record.
2. Select the recipe data record that you want to edit on the HMI device.
3. Assign a new name to the recipe data record.

As soon as you close the "Recipe data record" input field, the next free recipe data record number will be automatically assigned to the recipe data record. You may change the recipe data record number.

4. Use the "Save" button in the recipe view or the corresponding button on the HMI device that has this function.

Result

The recipe data record is stored under the new name.

Modify recipe record

1. Select the recipe on the HMI device in which you want to edit an existing recipe data record.
2. Select the recipe data record that you want to edit on the HMI device.
3. Replace the old values with new ones.
4. Use the "Save" button in the recipe view or the corresponding button on the HMI device that has this function.

Result

The modified values are applied to the recipe data record.

Delete recipe data record

1. Select the recipe on the HMI device in which you want to delete an existing recipe data record.
2. Select the recipe data record that you want to delete on the HMI device.
3. On the recipe view, select "Delete data record", or use the relevant HMI device button which is assigned this function.

Result

The recipe data record is deleted from the data medium of the HMI device.

10.7.2 Synchronizing a recipe data record

Introduction

In Runtime, differences between the indicated values and the actual values of the recipe tags may arise as a result of data input in recipe views or modification of recipe tags. Depending on the configuration, you can synchronize the values displayed in the recipe view with the recipe tags and values of the PLC. This synchronization is performed for each one of the recipe tags contained in the recipe data record.

Requirements

A recipe data record is displayed in the recipe view. The value of recipe tags can be changed, for example by teach-ins.

Procedure

1. Use the "Synchronization with controller" button in the recipe view or the corresponding button that has this function.

Result

- The system always updates the current value of the recipe view with the up-to-date recipe tag value.
- When the value shown in the recipe view is more recent than the current recipe tag value, the system writes this value to the recipe tag.

10.7.3 Read recipe data record from PLC

Introduction

You can read values from the PLC and write them to a recipe data record. For example, you can do this in machine teach-in mode in order to save the positioning data of axes as a recipe data record.

The read values are written to the recipe record that is currently displayed on the HMI device.

Procedure

1. Select the recipe on the HMI device.
2. On the HMI device, select the recipe data record of which you want to fetch the values from the PLC.
3. Use the "Read from PLC" button in the recipe view or the corresponding button on the HMI device that has this function.
4. Use the "Save" button in the recipe view or the corresponding button on the HMI device that has this function.

Result

The values are read from the PLC, visualized on the HMI device and saved to the recipe data record.

10.7.4 Transfer recipe record to PLC

Introduction

You can edit recipes offline or online.

- Offline: The data are transferred to the PLC after the relevant command is executed.
- Online: The data are transferred immediately to the PLC

In the recipe view, data are always edited offline. The configuration of the recipe screen determines whether the recipe data are edited offline or online.

When you edit data offline, you have to transfer the changed data to the PLC.

Procedure

1. Select the recipe on the HMI device.
2. On the HMI device, select the recipe data record of which you want to transfer the values to PLC.
3. Use the "Write to PLC" button in the recipe view or the corresponding button on the HMI device that has this function.

Result

The values of the recipe record are transferred to the PLC.

10.7.5 Exporting and importing recipe data records

Introduction

Based on your configuration, you can either export recipe data records to a CSV file for editing in MS Excel, for example, or import these from a CSV file. The extent to which you can influence these processes is determined by the project configuration. Various input boxes may be configured on the user interface:

- Input of the path to the CSV file
- Selection of the recipe data records for export
- Overwriting an existing CSV file

Export recipe data record

Requirements

Export functions are configured.

Procedure

1. Customize the export settings on the user interface of the HMI device, for example, by setting the path to the CSV file.
2. Press the button or the key on the HMI device configured with the "Export recipe records" function.

Result

The recipe data record are exported to a CSV file.

Note

New data records created in Runtime can be exported to an external file.

Importing recipe records

Requirements

Import functions are configured.

Procedure

1. Customize the import settings on the user interface of the HMI device, for example, by setting the path to the CSV file.
2. Use the button or the key on the HMI device which is assigned the "Import recipe records" function.

Result

The recipe data record are imported. If the structure of the CSV file is different from the recipe structure, deviations are treated as follows:

- Any additional values in the CSV file will be rejected.
- If the CSV file contains values of the wrong data type, the configured default value is set in the recipe record.

Example:

The CSV file contains values that show the tank contents and were input as floating point numbers. However, the corresponding recipe tag expects an integer value. In this case, the system discards the imported value and uses the configured default.

- The system also applies the configured default value to the recipe data record if the CSV file contains an insufficient number of values.

Maintenance/Service

11.1 Maintenance and service

Scope of maintenance

The HMI device is designed for maintenance-free operation. However, the touchscreen or keyboard foil and display should be cleaned at regular intervals.

Preparation



Caution**Inadvertent operation**

Only clean the HMI device after it has been switched off. This ensures that functions are not inadvertently triggered by touching the keys or the touch screen.

Use a cloth dampened with a cleaning agent to clean the equipment. Only use water with a little liquid soap or a screen cleaning foam as cleaning agents.

Proceed as follows

Never spray the cleaning agent directly onto the HMI device. Apply it to a cloth. Never use aggressive solvents or scouring powder.

Caution

Do not clean the HMI device with compressed air or steam jet blowers.

11.1.1 Clean screen

Clean screen

Only applies to HMI devices with a touchscreen.

The HMI device touchscreen can be cleaned when switched on and when operating normally if touchscreen input has been locked by means of an appropriately configured operator control (Clean Screen). After the Clean Screen function has been activated, all input via the touchscreen operating elements is deactivated for a defined period of time. The time remaining until the end of operating suppression is indicated by a progress bar.



Warning

Suppressing operating elements

During operation, clean the touchscreen only when Clean Screen is activated or switch off the HMI device!

Pay attention to the end of operating suppression by the Clean Screen. Failure to heed this instruction can lead to malfunction.

11.1.2 Protective foil and protective cover

Protective membrane

A protective foil is available for the touchscreens on HMI devices. The necessary ordering information is provided in the Siemens Catalog ST 80. The protective foil is not part of the material supplied with the HMI device.

The self-adhesive foil prevents the screen being scratched and soiled. The matte surface of the foil reduces reflections in poor lighting conditions.

The protective foil can be removed as necessary without leaving any adhesive residue on the screen.

Caution

Remove protective foil

Never use sharp or pointed tools, such as a knife, to remove the protective foil. This may damage the touchscreen.

Protective cover

The cover serves to protect the front of the TP 170micro, TP 170A and TP 170B. The cover protects the screen and the frame of the HMI device from dirt, scratches and chemicals. This allows the HMI devices to also be used in environments with a higher level of harmful substances.

When the cover is used, the protective class NEMA4 is achieved.

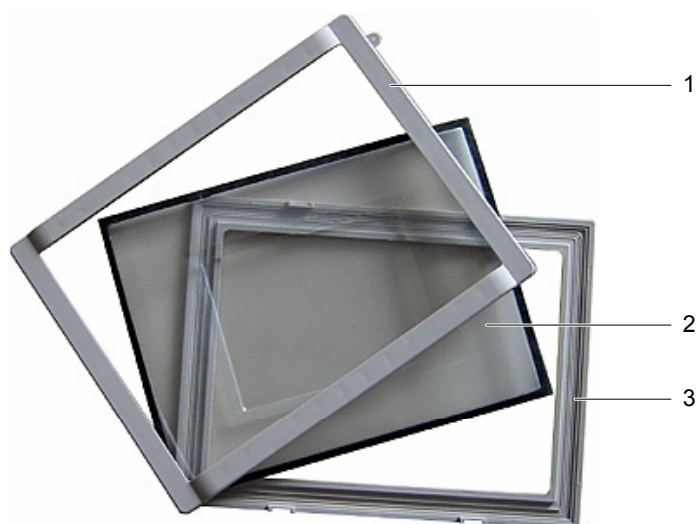

Figure 11-1 Components of the cover

- 1 Cover frame
- 2 Protective cover
- 3 Base frame



Figure 11-2 TP 170micro, TP 170A and TP 170B with cover attached

- 1 Protective cover
- 2 Touchscreen of the HMI device
- 3 Eyelet for securing the touchscreen pen

Requirement

- The HMI device is removed.

Procedure - installation

Proceed as follows to perform the installation:

1. Place the HMI device with its front down.

Set the HMI device down in such a way that the touchscreen cannot be damaged during the work to follow.

2. Remove installation seal on the HMI device.

Do not damage the installation seal.



1 Installation seal

3. Place base frame onto the HMI device.

Place the frame so that the writing field is visible.

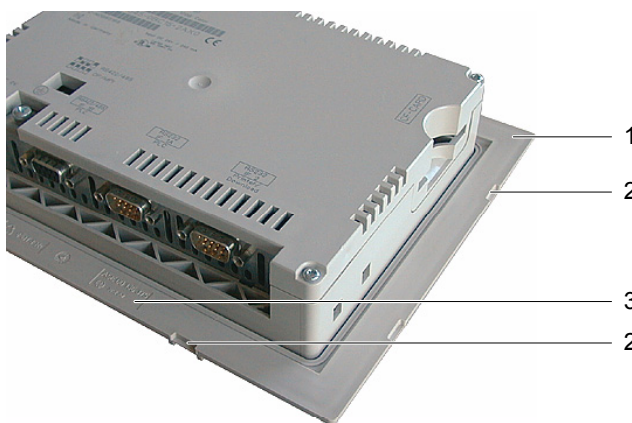

1 Base frame
2 Recesses for the cover frame
3 Writing field on the base frame

4. Insert the installation seal.

Make sure the installation seal is not twisted when inserting.



- 1 Installation seal

5. Turn the HMI device over and place it on its back.

Note

Layout of the front

In order to adapt the front of the HMI device to special requirements, a template for a customized layout, "protective cover_Schutzhaube_TPx70_Word97-2000.doc", is provided on the installations CD under ...\\documents\\

6. Put on the cover.

Check to see that the cover and the seal are completely stuck together. Use only a faultless cover.



- 1 Protective cover

7. Place cover on the base frame and press securely.

The base frame has eight recesses. Press the base frame and cover frame together at these points until they click into place.



8. Insert the HMI device in the installation cut-out.
9. Secure the HMI device as described in these operating instructions

Procedure - dismantling

In order to remove the base frame from the cover frame, insert a suitable screwdriver into a slit on the base frame. The cover frame can then be pried from the base frame.

11.2 Servicing and spare parts

Service pack

A service pack can be ordered for servicing purposes. It contains the following spare parts:

- Installation sealing
- Labeling strips: 2 sets for the OP 170B
- Spring terminals: 7 pieces
- Terminal block: 1 piece

The Service Pack can be ordered from your Siemens representative.

Specifications

12.1 Dimensioned drawings of the TP 170micro, TP 170A and TP 170B

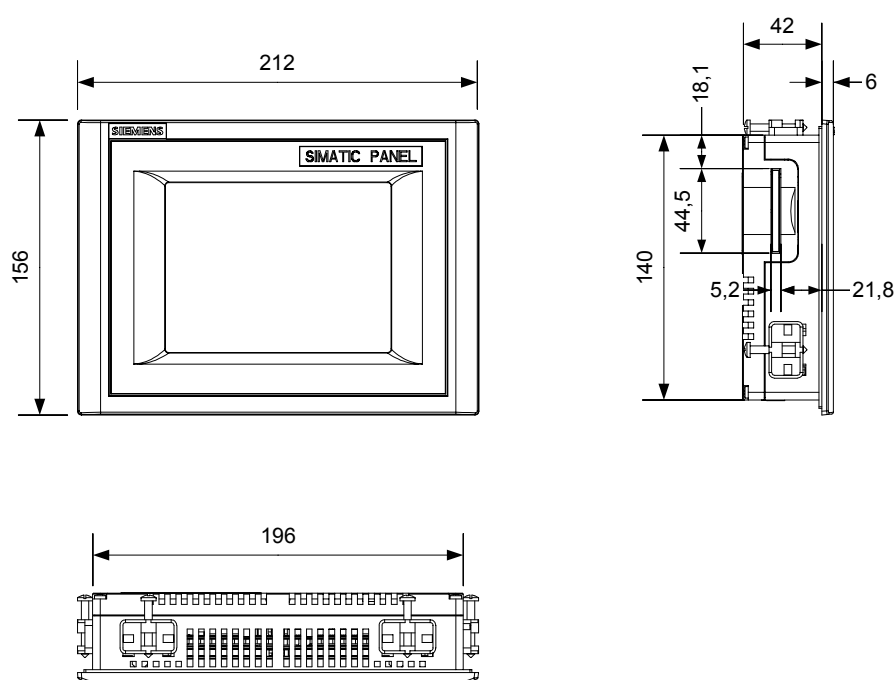

Figure 12-1 Basic dimensions of the TP 170micro, TP 170A and TP 170B

12.2 Dimensioned drawings of the OP 170B

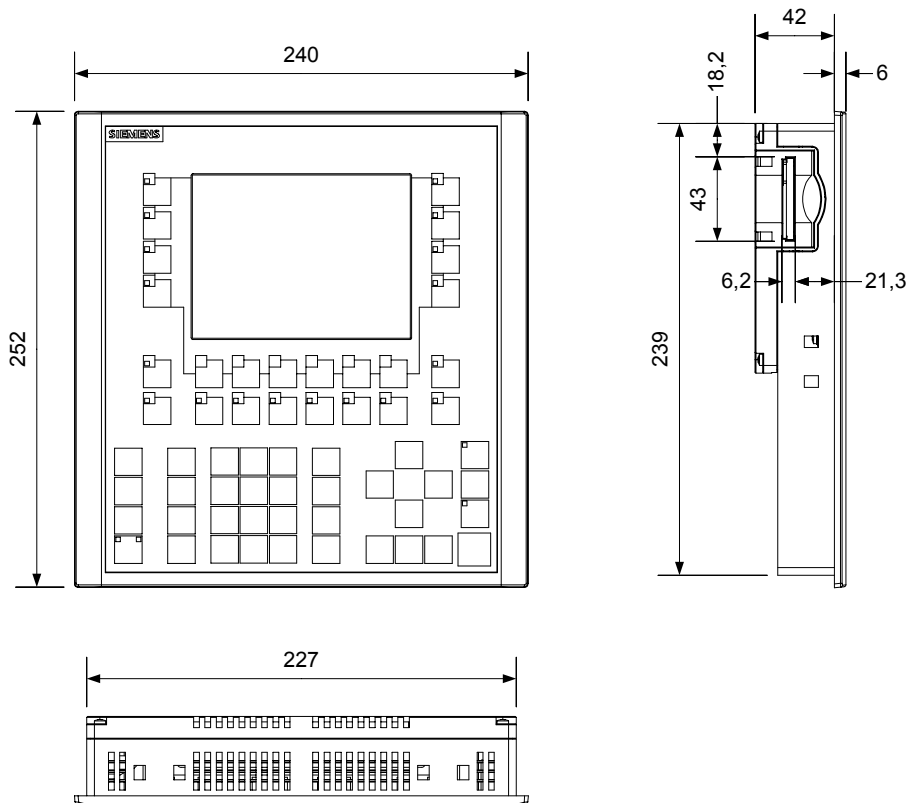

Figure 12-2 Overall dimensions of the OP 170B

12.3 Technical data, TP 170micro, TP 170A and TP 170B

Housing

	TP 170micro	TP 170A	TP 170B
Degree of protection	IP65 (NEMA 12, NEMA 4x with protective cover)		
• Front panel	IP65 (NEMA 12, NEMA 4x with protective cover)		
• Rear panel	IP20		
Weigh without packing	Approximately 700 g		

Display

	TP 170micro	TP 170A	TP 170micro
Type		STN LCD	
Screen area, active		116 x 87 mm (5.7")	
Resolution		320 x 240 pixels	
Colors, possible	4 Blue Mode	4 Blue Mode	4 Blue Mode or 16 colors
Back-lighting		CCFL tubes	
Half Brightness Life, typical		50 000 h	

Keyboard

	TP 170micro	TP 170A	TP 170B
Type		Touch screen	

Memory

	TP 170micro	TP 170A	TP 170B
Working memory	256 KB	320 KB	768 KB
Memory card	–	–	CF card, Type 1

Supply voltage

	TP 170micro	TP 170A	TP 170B
Rated voltage		24 V DC	
Range, permissible		+20 %/-15 %; +28.8 V to +20.4 V	
Transients, maximum permissible		35 V (500 msec)	
Time between two transients, minimum		50 s	
Power consumption			
• Typical			
– Color	–	–	Approx. 290 mA
– Monochrome	Approx. 240 mA	Approx. 240 mA	Approx. 250 mA
• Constant current, maximum	Approx. 900 mA	Approx. 900 mA	Approx. 900 mA
• Power on current surge I ² t	Approx. 0,2 A ² s	Approx. 0,2 A ² s	Approx. 0.1 A ² s
Fuse, internal		Electronic	

12.4 Technical data, OP 170B

Housing

Degree of protection	
• Front panel	IP65
• Rear panel	IP20
Weight without packing	Approximately 1 kg

Display

Type	STN LCD
Screen area, active	116 × 87 mm
Resolution	320 × 240 pixels
Colors, possible	4 Blue Mode
Brightness, typical	20 cd/m ²
Back-lighting	CCFL tubes
Half Brightness Life, typical	50 000 h

Keyboard

Type	Matrix membrane keyboard
System keys with dedicated functions	35, of which 3 with LED
Softkeys with configurable functions	24, of which 18 with LED
Configurable as softkeys	14
Labeling strips	8 for the keys: F1 to F14 and K1 to K10

Memory

Working memory	768 KB
Memory card	CF card, Type 1

Supply voltage

Rated voltage	24 V DC
Range, permissible	+20 %/-15 %; +28.8 V to +20.4 V
Transients, maximum permissible	35 V (500 msec)
Time between two transients, minimum	50 s
Power consumption	
• Typical	Approx. 250 mA
• Constant current, maximum	Approx. 900 mA
• Power on current surge I ² t	Approx. 0.1 A ² s
Fuse, internal	Electronic

12.5 Ambient conditions

Storage and transport conditions

Table 12-1 Permissible ambient conditions

Test	Test standard
Low temperatures, high temperatures, humidity and temperature change for storage and transport	IEC 61131, Part 2 DIN EN 60721
Cold	DIN EN 60068-2-1 Test Ab
Dry heat	DIN EN 60068-2-2 Test Bb
Temperature, alternating	DIN EN 60068-2-14 Test Nb
Moist heat, cyclic	DIN EN 60068-2-30 Test Db, Variant 2
Cold, heat, humidity and temperature change during operation	IEC 61131, Part 2 DIN EN 60721
Cold	DIN EN 60068-2-1 Test Ab
Dry heat	DIN EN 60068-2-2 Test Bb
Moist heat	DIN EN 60068-2-3 Test Ca
Temperature change, gradual (alternative to the three mentioned above)	DIN EN 60068-2-14 Test Nb
Barometric pressure	DIN EN 60068-2-13
Barometric pressure during operation	IEC 68-2-13 (8.85)
Barometric pressure during storage	IEC 68-2-13 (8.85)
Resistance to harmful substances	
Gases endangering functionality	DIN IEC 60721-3-3

Test	Test standard
	DIN IEC 60068-2-42
	DIN IEC 60068-2-43
Dust endangering functionality	DIN IEC 60721-3-3

Table 12-2 Permissible mechanical ambient conditions

Test	Test standard
Vibrations	IEC 60068, Part 2-6 (sinusoidal)
Shock	IEC 60068, Part 2-29

Testing mechanical ambient conditions

The following table contains information on the type and scope of the tests relating to mechanical ambient conditions.

Table 12-3 Testing mechanical ambient conditions

Test	Test standard	Approval values
Vibrations	IEC 60068, Part 2-6 (sinusoidal)	$10 \text{ Hz} \leq f \leq 58 \text{ Hz}$ constant: 0.0375 mm, constant amplitude occasional: 0.0375 mm, constant amplitude: $58 \text{ Hz} \leq f \leq 150 \text{ Hz}$ constant: 0.5 g, constant acceleration occasional: 1 g, constant acceleration
Vibration type: Frequency cycles with a modification speed of 1 octave/min.		
Vibration duration: 10 frequency cycles per axis in each of the three axes vertical to each other		
Shock	IEC 60068, Part 2-29	15 g maximum value, 11 ms duration
Shock type Half-sinus		
shock direction: 3 shocks in \pm direction of axis in each of the three axes vertical to each other		

Reduction of vibrations

If the HMI device will be exposed to vibration and shocks in excess of that specified in the above table, appropriate measures must be taken to reduce the acceleration and amplitude of the vibrations.

Use vibration absorbing materials, for example.

12.6 EMC requirements

EMC requirements

The electromagnetic compatibility (EMC) is the capacity of an electrical device to operate satisfactorily in its electromagnetic environment without affecting the environment.

	Standards	
EMC requirements	EN 61000-6-4 EN 61000-6-2	
Radio frequency interference	EN 55011	Class A, Group 1
<ul style="list-style-type: none"> • Interference immunity (bursts) • Interference immunity on power lines • Interference immunity on data and signal lines <30 m • Interference immunity on data and signal lines >30 m (process data lines) 	EN 61000-4-4	DC 24 V; 2.0 kV, Interference criterion B 1,0 kV, interference criterion B 2.0 kV, interference criterion B
Interference immunity (surge)	EN 61000-4-5	on DC 24–500 V 1 kV symmetric 2 kV asymmetric with upstream Dehnrail 24 FML, Order number: 901 104
Interference immunity against static electricity (ESD)	EN 61000-4-2	8 kV with air discharge 6 kV on contact, direct/indirect Interference criterion B
Interference immunity against radiated, radio-frequency, electromagnetic field	EN 61000-4-3	80–1000 MHz: 10 V/m Modulation: 80% AM with 1 kHz Interference criterion A
	EN 61000-4-3	900 MHz, ±5 MHz, 10 V/m test duration 1 Minute Pulse modulation: 50% pulse-duty factor 50% at 200 Hz Interference criterion A
RF conduction on lines and line shielding	EN 61000-4-6	on DC 24 V on signal/data lines 150 kHz to 80 MHz: 10 V/m Modulation: 80% AM with 1 kHz Interference criterion A
Interference immunity against magnetic fields	IEC 61000-4-8	50/60 Hz, 30 A/m effective value

Additional measures

If the HMI device is to be connected to the public power supply network, limiting Class B must be maintained in accordance with EN 55022.

12.7 Description of interfaces

12.7.1 Power supply

Plug connector, 2-pin



Figure 12-3 Power supply pin assignment

PIN	Allocation
1	+24 V DC
2	GND

12.7.2 RS 422/RS 485 (IF 1B)

Sub-D socket, 9-pin, secured by screws

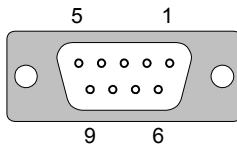

Figure 12-4 Pin assignment of interfaces RS 485 and RS 422

PIN	Assignment with RS 422	Assignment with RS 485
1	n. c.	n. c.
2	M	M
3	TxD+	LTG-B
4	RxD+	RTS-AS
5	GND, potential-free	GND, potential-free
6	DC +5 V, potential-free	DC +5 V, potential-free
7	DC 24 V in	DC 24 V in
8	TxD-	LTG-A
9	RxD-	RTS-AS

12.7.3 RS 232 (IF 1A)

Sub-D plug, 9-pin, secured by screws

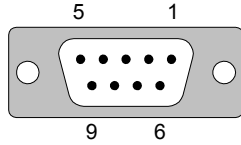

Figure 12-5 Pin assignment of RS 232 interface (only applies for TP 170micro)

PIN	Allocation
1	DCD
2	RxD
3	TxD
4	DTR
5	GND
6	DSR
7	RTS
8	CTS
9	n. c.

12.7.4 RS 232 (IF 2)

Sub-D plug, 9-pin, secured by screws

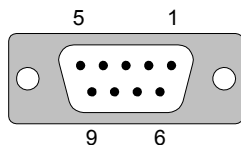

Figure 12-6 Pin assignment of RS 232 interface (only applies for TP 170micro and TP 170A)

PIN	Allocation
1	DCD
2	RxD
3	TxD
4	DTR
5	GND
6	DSR
7	RTS
8	CTS
9	n. c.

Appendix

A.1 Certificates and guidelines

A.1.1 Approvals

The following approvals are available for the HMI device:

Table A-1 HMI device approvals

Approvals	Standards
CE EMC guidelines	EN 61000-6-4 EN 50082-2 EN 61000-6-2
cULus General safety and fireproofing USA/Canada	UL 508
Environmental Rating Type 4x/12 System of protection, USA	NEMA PB 250
IP 65 Front System of protection	EN 60529
C-Tick EMC interference irradiation, Australia	AS/NSZ 2064

Note

The applicable approvals for the HMI device are indicated on the rear side of the device by the corresponding symbol. The applicable approvals for the HMI device are also indicated in the Internet at <http://www.siemens.com/automation>.

A.1.2 ESD guidelines

What does ESD mean?

Virtually all present-day, electronic modules incorporate highly integrated MOS devices or components. For technological reasons, these electronic components are very sensitive to overvoltages and, consequently, to electrostatic discharge. Therefore, they are identified as follows:

- **ESD** – **E**lectrostatically **S**ensitive **D**evelopments
- **ESD** – **E**lectrostatic Sensitive Devices

The following symbol on plates on cabinets, mounting racks or packages draws attention to the use of ESD and, thus, to the contact sensitivity of the assemblies concerned:



Figure A-1 Symbol for ESD

ESDs may be destroyed by voltages and energies well below the perception threshold of persons. Voltages of this kind occur as soon as a device or an assembly is touched by a person who is not electrostatically discharged. ESDs exposed to such overvoltages cannot immediately be detected as defective in the majority of cases since faulty behavior may occur only after a long period of operation.

Precautions against electrostatic discharge

Most plastics are capable of carrying high charges and it is therefore imperative that they be kept away from ESDs.

When working with electrostatically sensitive components, make sure that the person, the workstation and the packaging are properly grounded.

Handling ESD assemblies

A general rule is that ESDs should be touched only when this cannot be avoided owing to the work that has to be performed on them.

Only touch devices if

- you are grounded by permanently wearing an ESD wrist strap or
- you are wearing ESD shoes or ESD shoe-grounding protection straps in conjunction with an ESD floor.

Before you touch an electronic assembly, your body must be discharged. The simplest way of doing this is to touch a conductive, grounded object immediately beforehand, e.g. bare metal parts of a cabinet, water pipe etc.

ESDs should not be brought into contact with charge-susceptible and highly insulating materials such as plastic films, insulating table tops and items of clothing etc. containing synthetic fibers.

Assemblies should be deposited only on conductive surfaces, e.g. tables with an ESD coating, conductive ESD cellular material, ESD bags, ESD shipping containers.

Do not place ESDs near visual display units, monitors or television sets (minimum distance to screen > 10 cm).

Never touch ESDs so that contact is made with module connections or conductor rails.

Measuring ESD assemblies

Perform measurements on ESD assemblies only when

- the measuring instrument is grounded, e.g. by means of a grounded conductor or
- the measuring head has been briefly discharged before measurements are made with a potential-free measuring instrument, e.g. by touching a bare metal control cabinet.

When soldering, use only grounded soldering irons.

Shipping ESD assemblies

Always store and ship ESD assemblies and devices in conductive packing, e.g. metallized plastic boxes, metal boxes.

- Packing ESD

If packing is not conductive, ESDs must be conductively wrapped before they are packed. Use conductive foam rubber, ESD bags, domestic aluminum foil or paper, for example; never use plastic bags or foils.

- ESD with fitted battery

With assemblies containing fitted batteries, make sure that the conductive packing does not come into contact with or short-circuit battery connectors. If necessary, cover the connectors beforehand with suitable insulating material.

A.2 System alarms

Introduction

System alarms on the HMI device provide information about internal conditions of the HMI device and controller.

The following is an overview of when system alarms occur, their causes and the remedies available.

Note

System alarms are only displayed if an alarm window was configured. System alarms are output in the language currently set on the HMI device.

System alarm parameters

System alarms may contain encrypted parameters which are relevant for error tracking, because they provide a reference to the source code of the Runtime software. These parameters are output after the text "Error code:".

Meaning of the system alarms

Number	Effect/cause	Remedy
10000	The print job cannot be started or was canceled due to an unknown cause. The printer is not correctly configured. Or: There is no authorization for a network printer. The power supply failed during data transfer.	Check the printer settings, cable connections and the power supply. Set up the printer once again. Obtain a network printer authorization. If the error persists, contact the Hotline!
10001	No printer is installed or a default printer has not been set up.	Install a printer and/or select it as the default printer.
10002	The graphics buffer for printing is full. Up to two images are buffered.	Allow sufficient intervals between successive print jobs.
10003	Images can now be buffered again.	-
10004	Overflow of the buffer for printing lines in text mode (e.g.alarms). Up to 1000 lines are buffered.	Allow sufficient intervals between successive print jobs.
10005	Text lines can now be buffered again.	-
10006	The Windows printing system reports an error. Refer to the output text and the error ID to determine the possible causes. Nothing is printed or the print is faulty.	Repeat the action if necessary.
20010	An error has occurred in the specified script line. The execution of the script was therefore aborted. Note the system alarm that may have occurred prior to this.	Select the specified script line in the configuration. Ensure that the tags used are of the allowed types. Check system functions for the correct number and types of parameters.

Number	Effect/cause	Remedy
20011	An error has occurred in a script that was called by the specified script. The execution of the script was therefore aborted in the called script. Take the system event that may have occurred prior to this into account.	In the configuration, select the script that has been called directly or indirectly by the specified script. Ensure that the tags used are of the allowed types. Check the system functions for the correct number and type of parameters.
20012	The configuration data are inconsistent. The script could therefore not be generated.	Recompile the configuration.
20013	The scripting component of WinCC flexible Runtime is not correctly installed. Therefore, no scripts can be executed.	Reinstall WinCC flexible Runtime.
20014	The system function returns a value that is not written in any return tag.	Select the specified script in the configuration. Check whether the script name has been assigned a value.
20015	Too many successive scripts have been triggered in short intervals. When more than 20 scripts are queued for processing, any subsequent scripts are rejected. In this case, the script indicated in the alarm is not executed.	Find what is triggering the scripts. Extend the times, e.g. the polling time of the tags which trigger the scripts.
30010	The tag could not accept the function result, e.g. when it has exceeded the value range.	Check the tag type of the system function parameter.
30011	A system function could not be executed because the function was assigned an invalid value or type in the parameter.	Check the parameter value and tag type of the invalid parameter. If a tag is used as a parameter, check its value.
40010	The system function could not be executed since the parameters could not be converted to a common tag type.	Check the parameter types in the configuration.
40011	The system function could not be executed since the parameters could not be converted to a common tag type.	Check the parameter types in the configuration.
50000	The HMI device is receiving data faster than it is capable of processing. Therefore, no further data are accepted until all current data have been processed. Data exchange then resumes.	-
50001	Data exchange has been resumed.	-
60000	This alarm is generated by the "DisplaySystemEvents" function. The text to be displayed is transferred to the function as a parameter.	-
60010	The file could not be copied in the direction defined because one of the two files is currently open or the source/target path is not available. It is possible that the Windows user has no access rights to one of the two files.	Restart the system function or check the paths of the source/target files. Using Windows NT/2000/XP: The user executing WinCC flexible Runtime must be granted access rights for the files.
60011	An attempt was made to copy a file to itself. It is possible that the Windows user has no access rights to one of the two files.	Check the path of the source/target file. Using Windows NT/2000/XP with NTFS: The user executing WinCC flexible Runtime must be granted access rights for the files.

Number	Effect/cause	Remedy
70010	The application could not be started because it could not be found in the path specified or there is insufficient memory space.	Check whether the application exists in the specified path or close other applications.
70011	The system time could not be modified. The error message only appears in connection with area pointer "Date/time controller". Possible causes: <ul style="list-style-type: none"> An invalid time was transferred in the job mailbox. The Windows user has no right to modify the system time. If the first parameter in the system event is displayed with the value 13, the second parameter indicates the byte containing the incorrect value.	Check the time which is to be set. Using Windows NT/2000/XP: The user executing WinCC flexible Runtime must be granted the right to change the system time of the operating system.
70012	An error occurred when executing the function "StopRuntime" with the option "Runtime and operating system". Windows and WinCC flexible Runtime are not closed. One possible cause is that other programs cannot be closed.	Close all programs currently running. Then close Windows.
70013	The system time could not be modified because an invalid value was entered. Incorrect separators may have been used.	Check the time which is to be set.
70014	The system time could not be modified. Possible causes: <ul style="list-style-type: none"> an invalid time was transferred. the Windows user has no right to modify the system time. Windows rejects the setting request. 	Check the time which is to be set. Using Windows NT/2000/XP: The user executing WinCC flexible Runtime must be granted the right to change the system time of the operating system.
70015	The system time could not be read because Windows rejects the reading function.	-
70016	An attempt was made to select a screen by means of a system function or job. This is not possible because the screen number specified does not exist. Or: a screen could not be generated due to insufficient system memory.	Check the screen number in the function or job with the screen numbers configured. Assign the number to a screen, if necessary.
70017	Date/Time is not read from the area pointer because the address set in the controller is either not available or has not been set up.	Change the address or set up the address in the controller.
70018	Acknowledgment that the password list has been successfully imported.	-
70019	Acknowledgment that the password list has been successfully exported.	-
70020	Acknowledgment for activation of alarm reporting.	-
70021	Acknowledgment for deactivation of alarm reporting.	-
70022	Acknowledgment to starting the Import Password List action.	-

Number	Effect/cause	Remedy
70023	Acknowledgment to starting the Export Password List action.	-
70024	The value range of the tag has been exceeded in the system function. The calculation of the system function will not be performed.	Check the desired calculation and correct it if necessary.
70025	The value range of the tag has been exceeded in the system function. The calculation of the system function will not be performed.	Check the desired calculation and correct it if necessary.
70026	No other screens are stored in the internal screen memory. No other screens can be selected.	-
70027	The backup of the RAM file system has been started.	-
70028	The files from the RAM have been copied in the Flash memory. The files from the RAM have been copied in the Flash memory. Following a restart, these saved files will be copied back to the RAM file system.	-
70029	Backup of the RAM file system has failed. No backup copy of the RAM file system has been made.	Check the settings in the "Control Panel > OP" dialog and save the RAM file system using the "Save Files" button in the "Persistent Storage" tab.
70030	The parameters configured for the system function are faulty. The connection to the new controller was not established.	Compare the parameters configured for the system function with the parameters configured for the controllers and correct them as necessary.
70031	The controller configured in the system function is not an S7 controller. The connection to the new controller was not established.	Compare the S7 controller name parameter configured for the system function with the parameters configured for the controller and correct them as necessary.
70032	The object configured with this number in the tab order is not available in the selected screen. The screen changes but the focus is set to the first object.	Check the number of the tab order and correct it if necessary.
70033	An e-mail cannot be sent because a TCP/IP connection to the SMTP server no longer exists. This system event is generated only at the first attempt. All subsequent unsuccessful attempts to send an e-mail will no longer generate a system event. The event is regenerated when an e-mail has been successfully sent in the meantime. The central e-mail component in WinCC flexible Runtime attempts, in regular intervals (1 minute), to establish the the connection to the SMTP server and to send the remaining e-mails.	Check the network connection to the SMTP server and re-establish it if necessary.
70034	Following a disruption, the TCP/IP connection to the SMTP server could be re-established. The queued e-mails are then sent.	-

Number	Effect/cause	Remedy
70035	The e-mail queue of the central component in WinCC flexible Runtime responsible for sending e-mails is full. The e-mail could therefore not be entered into the queue and therefore not sent. The cause may be a broken connection to the SMTP server or an overload resulting from too much e-mail traffic. This system event is generated only at the first attempt. The next system event is only generated when at least one e-mail has been successfully sent to the queue in the meantime.	Check if <ul style="list-style-type: none"> the network connection still exists or the connection is overloaded (for example, due to reoccurring system events resulting from disruptions).
70036	No SMTP server for sending e-mails is configured. An attempt to connect to an SMTP server has failed and it is not possible to send e-mails. WinCC flexible Runtime generates the system alarm after the first attempt to send an e-mail.	Configure an SMTP server: In WinCC flexible Engineering System using "Device settings > Device settings" In the Windows CE operating system using "Control Panel > Internet Settings > E-mail > SMTP Server"
70037	An e-mail cannot be sent for unknown reasons. The contents of the e-mail are lost.	Check the e-mail parameters (recipient etc.).
70038	The SMTP server has rejected sending or forwarding an e-mail because the domain of the recipient is unknown to the server or because the SMTP server requires authentication. The contents of the e-mail are lost.	Check the domain of the recipient address or deactivate the authentication on the SMTP server if possible. SMTP authentication is currently not used in WinCC flexible Runtime.
70039	The syntax of the e-mail address is incorrect or contains illegal characters. The contents of the e-mail are discarded.	Check the e-mail address of the recipient.
70040	The syntax of the e-mail address is incorrect or contains illegal characters.	-
80001	The log specified is filled to the size defined (in percent) and must be stored elsewhere.	Store the file or table by executing a 'move' or 'copy' function.
80002	A line is missing in the specified log.	-
80003	The copying process for logging was not successful. In this case, it is advisable to check any subsequent system events, too.	-
80006	Since logging is not possible, this causes a permanent loss of the functionality.	In the case of databases, check whether the corresponding data source exists and start up the system again.
80009	A copying action has been completed successfully.	-
80010	Since the storage location was incorrectly entered in WinCC flexible, this causes a permanent loss of the functionality.	Configure the storage location for the respective log again and restart the system when the full functionality is required.
80012	Log entries are stored in a buffer. If the values are read to the buffer faster than they can be physically written (using a hard disk, for example), overloading may occur and recording is then stopped.	Archive fewer values. Or: Increase the logging cycle.
80013	The overload status no longer applies. Archiving resumes the recording of all values.	-

Number	Effect/cause	Remedy
80014	The same action was triggered twice in quick succession. Since the process is already in operation, the action is only carried out once.	-
80015	This system event is used to report DOS or database errors to the user.	-
80016	The logs are separated by the system function "CloseAllLogs" and the incoming entries exceed the defined buffer size. All entries in the buffer will be deleted.	Reconnect the logs.
80017	The incoming entries exceed the defined buffer size. This can be caused, for example, by several copying actions being activated at the same time. All copy jobs will be deleted.	Stop the copy action.
80018	All connections between WinCC flexible and the logs have been reestablished, for example, after executing the system function "OpenAllLogs". Entries will be written into the logs again.	-
80019	All connections between WinCC flexible and all logs have been severed, for example, after executing the system function "CloseAllLogs". Entries will be written to the buffer and written into the logs when a connection is re-established. There is no connection to the storage location and the data medium may be being exchanged.	-
80020	The maximum number of simultaneously activated copy actions has been exceeded. Copying is not executed.	Wait until the current copying actions have been completed and restart the last copy action.
80021	An attempt was made to delete a log which is still involved with a copy action. Deletion has not been executed.	Wait until the current copying actions have been completed and restart the last action
80022	An attempt was made to start a sequence log, which is not a sequence log, from a log using the system function "StartSequenceLog". No sequence log is created.	Check the project for the following: <ul style="list-style-type: none"> • Was the system function "StartSequenceLog" configured correctly? • Were the tag parameters being supplied correctly on the HMI device?
80023	An attempt was made to copy a log to itself. The log is not copied.	Check the project for the following: <ul style="list-style-type: none"> • Was the system function "CopyLog" configured correctly? • Were the tag parameters being supplied correctly on the HMI device?
80024	The system function "CopyLog" is configured not to permit copying when the target log already contains data (Parameter: "Mode"). The log is not copied.	Modify the system function "CopyLog" in the project, if necessary. Before initiating the system function, delete the target log.
80025	You have interrupted the copy process. Data written up to this point is retained. Deletion of the target log (if configured) is not executed. The cancellation is documented by an error entry \$RT_ERR\$ at the end of the target log.	-

Number	Effect/cause	Remedy
80026	This notification is issued after all the logs have been successfully initialized. Values are written to the logs from this moment on. Prior to this, no entries are written to the logs even though WinCC flexible Runtime is running.	-
80027	The internal Flash memory has been specified as the storage location for a log. This is not permissible. No values will be logged for this log and the log will not be created.	Configure "Storage Card" or a network path as the storage location.
80028	The event serves as a status acknowledgment that initialization of the logs is currently running. No values are logged until system event 80026 is issued.	-
80029	The number of logs specified in the event could not be initialized. Initialization of the logs has been completed. The faulty logs are not available for logging jobs.	Evaluate the additional system event, related to this alarm which is also generated. Check the configuration, the ODBC (Open Database Connectivity) and the specified drive.
80030	The structure of existing log does not match the expected log structure. The logging process is stopped for this log.	Delete the existing log data manually, in advance.
80031	The log in CSV format is corrupted. The log cannot be used.	Delete the corrupt file.
80032	Logs can be configured with events. These are triggered as soon as the log is full. If WinCC flexible Runtime is started and the log is already full, the event will not be triggered. The log specified no longer logs data because it is full.	Stop the WinCC flexible Runtime, delete the log and restart the WinCC flexible Runtime again. Or: Configure a button which contains the same actions as the event and press it.
80033	"System Defined" is selected in the data log as the data source name. This results in an error. No logging is made to the database log whereas the logging to the CSV logs works.	Install MSDE again.
80034	An error has occurred in the initialization of the logs. An attempt has been made to create tables as a backup. This did not work. A backup has been made of the tables of the corrupt log and the log has been newly started (empty)	No action is necessary. However, it is recommended to save the backups or delete them to free up memory.
80035	An error has occurred in the initialization of the logs. An attempt has been made to create backups of the tables and this has failed. No logging or backup has been performed.	It is recommended to save the backups or delete them to free up memory.
110000	The operating mode has been changed. The operating mode is now 'offline'.	-
110001	The operating mode has been changed. The operating mode is now "online".	-
110002	The operating mode cannot be changed.	Check the connection to the controllers. Check whether the address area for the area pointer 88 "Coordination" in the controller is available.

Number	Effect/cause	Remedy
110003	The operating mode of the specified controller has been changed by the system function "SetConnectionMode". The operating mode is now "offline".	-
110004	The operating mode of the specified controller has been changed by the system function "SetConnectionMode". The operating mode is now "online".	-
110005	An attempt was made to use the system function SetConnectionMode to switch the specified controller to the online operating mode although the entire system is in the offline mode. This switch-over is not permissible. The controller remains in operating mode "offline".	Switch the complete system to operating mode "online" and execute the system function again.
110006	The content of the area pointer "User version" does not match the user version configured in WinCC flexible. WinCC flexible Runtime is therefore closed.	Check: <ul style="list-style-type: none"> the user version entered on the controller the user version entered in WinCC flexible
120000	The trend is not displayed because an incorrect axis to the trend, or incorrect trend, has been configured.	Change the configuration.
120001	The trend is not displayed because an incorrect axis to the trend, or incorrect trend, has been configured.	Change the configuration.
120002	The trend is not displayed because the tag assigned tries to access an invalid controller address.	Check whether the data area for the tag exists in the controller, the configured address is correct or the value range for the tag is correct.
130000	The action was not executed.	Close the other programs. Delete files no longer required from the hard disk.
130001	The action was not executed.	Delete files no longer required from the hard disk.
130002	The action was not executed.	Close the other programs. Delete files no longer required from the hard disk.
130003	No data medium is inserted. The process is stopped.	Check, for example, if <ul style="list-style-type: none"> the correct data medium is being accessed the data medium is inserted
130004	The data medium is write-protected. The process is stopped.	Check whether access has been made to the correct data carrier. Remove any write protection.
130005	The file is write-protected. The process is stopped.	Check whether access has been made to the correct file. Modify the file attributes, if necessary.
130006	No access to file is possible. The process is stopped.	Check, for example, if <ul style="list-style-type: none"> the correct file is being accessed the file exists another action is preventing simultaneous access to the file
130007	The network connection is interrupted. Data records cannot be saved or read over the network connection.	Check the network connection and correct the reason for the disruption.
130008	The storage card is not available. Data records cannot be saved or read to the storage card.	Insert the storage card.

Number	Effect/cause	Remedy
130009	The specified directory is not on the storage card. The files that are saved in this directory are not saved when the HMI device is switched off.	Insert the storage card.
130010	The maximum nesting depth can be exhausted when, for example, a value change in a script results in the call of another script and the second script in turn has a value change that results in the call of another script etc. The configured functionality is not provided.	Check the configuration.
140000	Online connection to the controller has been successfully established.	-
140001	Online connection to the controller has been disconnected.	-
140003	No tag updating or writing is executed.	Check the connection and whether the controller is switched on. Check the parameter definitions in the Control Panel using "Set PG/PC interface". Restart the system.
140004	No tag updating or writing is executed because the access point or the module configuration is faulty.	Verify the connection and check whether the controller is switched on. Check the access point or the module configuration (MPI, PPI, PROFIBUS) in the Control Panel with "Set PG/PC interface". Restart the system.
140005	No tag updating or writing is executed because the address of the HMI device is incorrect (possibly too high).	Use a different HMI device address. Verify the connection and check whether the controller is switched on. Check the parameter definitions in the Control Panel using "Set PG/PC interface". Restart the system.
140006	No tag updating or writing is executed because the baud rate is incorrect.	Select a different baud rate in WinCC flexible (according to module, profile, communication peer, etc.).
140007	Tag are not updated or written because the bus profile is incorrect (see %1). The following parameters cannot be entered in the registry: 1: Tslot 2: Tqui 3: Tset 4: MinTsdr 5: MaxTsdr 6: Trdy 7: Tid1 8: Tid2 9: Gap Factor 10: Retry Limit	Check the user-defined bus profile. Check the connection and whether the controller is switched on. Check the parameter definitions in the Control Panel using "Set PG/PC interface". Restart the system.

Number	Effect/cause	Remedy
140008	No tag updating or writing is executed because baud rate is incorrect. The following parameters cannot be entered in the registry: 0: General error 1: Incorrect version 2: Profile cannot be entered in the registry. 3: Subnet type cannot be entered in the registry. 4: Target rotation time cannot be entered in the registry. 5: Highest address (HSA) incorrect.	Check the connection and whether the controller is switched on. Check the parameter definitions in the Control Panel using "Set PG/PC interface". Restart the system.
140009	No tag updating or writing is executed because the module for the S7 communication was not found.	Reinstall the module in the Control Panel using "Set PG/PC interface".
140010	No S7 communication peer could be found because the controller is switched off. DP/T: The option "Is not active as the only master" is set in the Control Panel under "Set PG/PC interface".	Switch the controller on. DP/T: If only one master is connected to the network, deactivate the option "Is not active as the only master" in "Set PG/PC interface". If there is more than one master connected to the network, activate them. Do not change any settings otherwise the bus will be disrupted.
140011	No tag updating or writing is executed because the communication is interrupted.	Check the connection and that the communication peer is switched on.
140012	There is an initialization problem (e.g. when WinCC flexible Runtime has been terminated in the Task Manager). Or: another application (e.g. STEP7) is active with different bus parameters and the driver cannot be started with the new bus parameters (e.g. baud rate).	Restart the HMI device. Or: Start WinCC flexible Runtime first and then the other applications.
140013	The MPI cable is not plugged in and, thus, there is no power supply.	Check the connections.
140014	"Configured bus address already assigned."	Modify the HMI device address in the configuration in controller.
140015	Incorrect baud rate Or: incorrect bus parameter (e.g. HSA) Or: OP address > HSA or: incorrect interrupt vector (interrupt does not arrive at the driver)	Correct the incorrect parameters.
140016	Configured interrupt is not supported by the hardware.	Change the interrupt number.
140017	Configured interrupt in use by another driver.	Change the interrupt number.
140018	The consistency check was deactivated by SIMOTION Scout. Only one appropriate note appears.	Activate the consistency check with SIMOTION Scout again and load the configuration in the project once more.
140019	SIMOTION Scout downloads a new project to the controller. Connection to the controller is interrupted.	Wait until the end of the reconfiguration.

Number	Effect/cause	Remedy
140020	The version in the PLC and that in the configuration (FWX file) do not match. Connection to the PLC is interrupted.	The following remedies are available: Download the current version to the controller using SIMOTION Scout. Regenerate the project using WinCC flexible ES, close WinCC flexible Runtime and restart with a new configuration.
150000	No more data are read or written. Possible causes: <ul style="list-style-type: none"> • The cable is defective. • The controller does not respond, is defective, etc. • The connection is established via the wrong interface. • The system is overloaded. 	Check that the cable is plugged in, the controller is operational, the correct interface is being used. Restart the system if the system event is displayed persistently.
150001	Connection is reestablished because the cause of the interruption has been eliminated.	-
160000	No more data are read or written. Possible causes: <ul style="list-style-type: none"> • The cable is defective. • The controller does not respond, is defective, etc. • Connection has been established via the wrong interface. • The system is overloaded. 	Check that the cable is plugged in, the controller is operational, the correct interface is being used. Restart the system if the system event is displayed persistently.
160001	Connection is reestablished because the cause of the interruption has been eliminated.	-
160010	There is no connection to the server because the server identification (CLS-ID) cannot be established. Values cannot be read or written.	Check the access rights.
160011	There is no connection to the server because the server identification (CLS-ID) cannot be established. Values cannot be read or written.	Check, for example, if <ul style="list-style-type: none"> • the server name is correct • the computer name is correct • the server is registered
160012	There is no connection to the server because the server identification (CLS-ID) cannot be established. Values cannot be read or written.	Check, for example, if <ul style="list-style-type: none"> • the server name is correct • the computer name is correct • the server is registered Note for experienced users: Interpret the value from HRESULT.
160013	The specified server was started as InProc Server. This has not been released and may possibly lead to incorrect behavior because the server is running in the same process area as the WinCC flexible Runtime software.	Configure the server as OutProc Server or Local Server.

Number	Effect/cause	Remedy
160014	Only one OPC server project can be started on a PC/MP. An error message appears when an attempt is made to start a second project. The second project has no OPC server functionality and cannot be located as an OPC server from external sources.	Do not start a second project with OPC server functionality on the computer.
170000	S7 diagnostics events are not displayed because it is not possible to log on to the S7 diagnostics with this unit. The service program is not supported.	-
170001	The S7 diagnostics buffer cannot be displayed because communication with the controller has been switched off.	Switch the controller online.
170002	The S7 diagnostics buffer cannot be displayed because reading in the diagnostics buffer (SSL) was terminated due to an error.	-
170003	The display of an S7 diagnostics event is not possible. An internal error %2 has been reported.	-
170004	The display of an S7 diagnostics event is not possible. An internal error with error class %2, error number %3 has been reported.	-
170007	It is not possible to read in the S7 diagnostics buffer (SSL) because it was terminated with an internal error class %2 and error code %3.	-
180000	A component/OCX receives configuration data with a version identification which is not supported.	Install a newer component.
180001	The system is overloaded because too many actions have been activated simultaneously. Not all the actions can be executed, some are rejected.	Several remedies are available: <ul style="list-style-type: none"> • Increase the configured cycle times or basic clock. • Generate the alarms slower (polling). • Trigger the scripts and functions at greater intervals. If the alarm appears more frequently: Restart the HMI device.
180002	The on-screen keyboard could not be activated. Possible cause: The file "TouchInputPC.exe" was not registered due to an incorrectly executed Setup.	Reinstall WinCC flexible Runtime.
190000	It is possible that the tag will not be updated.	-
190001	The tag is updated following an error status after the cause of the last error state has been eliminated (return to normal operation).	-
190002	The tag is not updated because communication with the controller has been terminated.	Switch on communication via the system function "SetOnline".
190004	The tag is not updated because the configured address is not available for this tag.	Check the configuration.
190005	The tag is not updated because the configured controller type does not exist for this tag.	Check the configuration.
190006	The tag is not updated because it is not possible to map the controller type in the data type of the tag.	Check the configuration.

Number	Effect/cause	Remedy
190007	The tag values are not modified because the connection to the controller has been terminated or the tag is offline.	Switch to online mode or re-establish connection to the controller.
190008	The threshold values configured for the tag have been violated, e.g. by <ul style="list-style-type: none"> • an entered value • a system function • a script 	Observe the configured or current threshold value of the tag.
190009	An attempt has been made to assign a value to a tag which is outside the value range permitted for this data type. E.g., a value of 260 entered for a byte tag or a value of -3 for a word tag without a sign.	Observe the value range for the data type of the tags.
190010	The tag is described with values too often (e.g. in a loop triggered by a script). Values are lost because the maximum of 100 actions have been stored in the buffer.	Increase the time interval between the multi-writing tasks.
190011	Possible cause 1: The value entered could not be written to the configured controller tag because it was either above or below the value range. The input is rejected and the original value is reset. Possible cause 2: The connection to the controller has been terminated.	Make sure that the value entered is within the value range of the controller tags. Check the connection to the controller.
190012	It is not possible to convert a value from a source format to a target format, e.g.: An attempt is being made to assign a value to a counter that is outside the valid, controller-dependent value range. A tag of the type Integer should be assigned a value of the type String.	Check the value range or the data type of the tags.
190100	The area pointer is not updated because the configured address for this area pointer is not available. Type 1 System events 2 Alarms 3 Controller acknowledgment 4 HMI device acknowledgment 5 LED mapping 6 Trend request 7 Trend transfer 1 8 Trend transfer 2 No.: is the consecutive number displayed in WinCC flexible ES.	Check the configuration.
190101	The area pointer is not updated because it is not possible to map the controller type in the area pointer type. Parameter type and no.: see alarm 190100	-

Number	Effect/cause	Remedy
190102	The area pointer is updated following an error status after the cause of the last error state has been eliminated (return to normal operation). Parameter type and no.: See alarm 190100.	-
200000	Coordination is not executed because the address configured in the controller does not exist/has not been set up.	Change the address or set up the address in the controller.
200001	Coordination is not executed because the address configured in the controller does not exist/has not been written.	Change the address or set up the address in the controller in an area which can be written.
200002	Coordination is not carried out at the moment because the address format of the area pointer does not match the internal storage format.	Internal error
200003	Coordination can be executed again because the last error status has been eliminated (return to normal operation).	-
200004	The coordination may not be executed.	-
200005	No more data are read or written. Possible causes: <ul style="list-style-type: none"> • The cable is defective. • The controller does not respond, is defective, etc. • The system is overloaded. 	Check that the cable is plugged in and the controller is operational. Restart the system if the system event is displayed continuously.
200100	Coordination is not executed because the address configured in the controller does not exist/has not been set up.	Change the address or set up the address in the controller.
200101	Coordination is not executed because the address configured in the controller does not exist/has not been written.	Change the address or set up the address in the controller in an area which can be written.
200102	Coordination is not carried out at the moment because the address format of the area pointer does not match the internal storage format.	Internal error
200103	Coordination can be executed again because the last error status has been eliminated (return to normal operation).	-
200104	The coordination may not be executed.	-
200105	No more data are read or written. Possible causes: <ul style="list-style-type: none"> • The cable is defective. • The controller does not respond, is defective, etc. • The system is overloaded. 	Check that the cable is plugged in and the controller is operational. Restart the system if the system event is displayed continuously.
210000	Jobs are not processed because the address configured in the controller does not exist/has not been set up.	Change the address or set up the address in the controller.
210001	Jobs are not processed because the address configured in the controller cannot be written to/read from.	Change the address or set up the address in the controller in an area that can be written to/read from.
210002	Commands are not executed because the address format of the area pointer does not match the internal storage format.	Internal error

Appendix

A.2 System alarms

Number	Effect/cause	Remedy
210003	The job mailbox is processed again because the last error status has been eliminated (return to normal operation).	-
210004	It is possible that the job mailbox is not processed.	-
210005	A job mailbox with an illegal number was triggered.	Check the controller program.
210006	An error occurred while attempting to execute the job mailbox. As a result, the job mailbox will not be executed. Observe the subsequent/previous system event, if appropriate.	Check the parameters in the job mailbox. Recompile the configuration.
220001	The tag is not downloaded because the associated communication driver / HMI device does not support downloading the data type oolean/bit.	Change the configuration.
220002	The tag is not downloaded because the associated communication driver / HMI device does not support the data type byte when writing.	Change the configuration.
220003	The communication driver cannot be loaded. The driver may not be installed.	Install the driver by reinstalling WinCC flexible Runtime.
220004	Communication is terminated and no update is executed because the cable is not connected or is defective etc.	Check the connection.
220005	Communication is running.	-
220006	The connection is established to the specified controller on the specified interface.	-
220007	The connection to the specified controller on the specified interface is disrupted.	Check if <ul style="list-style-type: none"> • the cable is plugged in • the controller is OK • the correct interface is used • the configuration is OK (interface parameters, protocol settings, controller address). Reboot the system if the system event is displayed persistently.
220008	The communication driver cannot access the specified interface or open it. It is possible that another program is using this interface or an interface is being used which is not available on the target device. There is no communication with the controller.	Close all the programs which access the interface and restart the computer. Use another interface available in the system.
230000	The value entered could not be accepted. The entered value is rejected and the previous value is restored. Either the value range has been exceeded or impermissible characters were entered.	Enter a permissible value.
230002	Since the user currently logged on does not have the proper authorization, the input is rejected and the previous value is restored.	Log on as a user with sufficient rights.
230003	Changeover to the specified screen is not executed because the screen is not available/configured. The current screen remains selected.	Configure the screen and check the selection function.

Number	Effect/cause	Remedy
230005	The value range of the tag has been exceeded in the I/O field. The original value of the tag is retained.	Take the value range of the tag into consideration when entering value.
230100	During navigation in the web browser, a message which may be of interest to the user is issued. The web browser continues to run, but may not (fully) display the new page but it.	Navigate to another page.
230200	The connection to the HTTP channel was interrupted due to an error. This error is explained by another system event. Data are no longer exchanged.	Check the network connection. Check the configuration of the server.
230201	The connection to HTTP channel has been reestablished. Data are exchanged.	-
230202	WININET.DLL has detected an error. This error usually occurs when it is not possible to make a connection to the server or the server rejects the attempt to make a connection because the client lacks the authorization. An unknown server certificate can also be the cause when the connection is encoded through SSL. The text of the error message provides more information. This text is always in the language of the Windows installation since it originates from Windows. Process values are no longer exchanged.	Depending on the cause: When a connection cannot be made or a timeout occurs: <ul style="list-style-type: none"> • Check the network connection and the network. • Check the server address. • Check if the web server is actually running on the target computer. In the absence of an authorization: <ul style="list-style-type: none"> • Configured user name and/or password do not match those on the server. Match them. When the server certificate is rejected: Certificate signed by an unknown CA (): <ul style="list-style-type: none"> • Either set the configuration to ignore this point or • install a certificate that has been signed with a root certificate known to the client computer. If the date of the certificate is invalid: <ul style="list-style-type: none"> • Either set the configuration to ignore this point or • Install a certificate with a valid date on the server. If there is an invalid CN (Common Name or Computer Name): <ul style="list-style-type: none"> • Either set the configuration to ignore this point or • Install a certificate with a name that corresponds to that of the server address.
230203	Although a connection can be made to the server, the HTTP server rejects the connection because <ul style="list-style-type: none"> • WinCC flexible Runtime is not running on the server or • The HTTP channel is not supported (503 Service unavailable). Other errors may occur if the web server does not support the HTTP channel. The language of the error text depends on the web server. Data are not exchanged.	For error 503 Service unavailable: Check if: WinCC flexible Runtime is running on the server The HTTP channel is supported.

Number	Effect/cause	Remedy
230301	An internal error has occurred. An English text explains the error somewhat more specific. One possible cause is insufficient memory, for example. OCX does not work.	-
230302	The name of the remote server cannot be determined. No connection can be established.	Check the configured server address. Check if the DNS service of the network is activated.
230303	The remote server is not running on the addressed computer. The server address is incorrect. No connection can be established.	Check the configured server address. Check if the remote server is running on the target computer.
230304	The remote server on the addressed computer is incompatible to VNCOCX. No connection can be established.	Use a compatible remote server.
230305	The authentication has failed because the password is incorrect. No connection can be established.	Configure the correct password.
230306	The connection to the remote server has been interrupted. This may occur during network problems. No connection can be established.	Check if <ul style="list-style-type: none"> • the cable is plugged in • there are network problems.
230307	The connection to the remote server was ended because <ul style="list-style-type: none"> • the remote server was shut down or • the user instructed the server to close all connections. The connection is closed.	-
230308	This notification informs you about the establishment of the connection. A connection has just been established.	-
240000	WinCC flexible Runtime is operating in demo mode. You have no authorization or your authorization is corrupt.	Load the authorization.
240001	WinCC flexible Runtime is operating in demo mode. Too many tags are configured for the installed version.	Load an adequate authorization / powerpack.
240002	WinCC flexible Runtime is operating with a time-limited standby authorization.	Restore the full authorization.
240003	Authorization cannot be executed. Without authorization, WinCC will run in demo mode.	Restart WinCC flexible Runtime or reinstall it.
240004	Error while reading the standby authorization. WinCC flexible Runtime is operating in demo mode.	Restart WinCC flexible Runtime, install the authorization or repair the authorization (see Commissioning Instructions Software Protection).
250000	The tag in the specified line in "Status/Control" is not updated because the address configured for this tag is not available.	Check the set address and then check that the address has been set up in the controller.
250001	The tag in the specified line in "Status/Control" is not updated because the controller type configured for this tag does not exist.	Check the set address.

Number	Effect/cause	Remedy
250002	The tag in the specified line in "Status/Control" is not updated because it is not possible to map the controller type in the tag type.	Check the set address.
250003	No connection could be established to the controller. The tags will not be updated.	Check the connection to the controller. Check that the controller is switched on and is online.
260000	An unknown user or an unknown password has been entered in the system. The current user is logged off from the system.	Log on to the system as a user with a valid password.
260001	The logged on user does not have sufficient authorization to perform the protected functions on the system.	Log on to the system as a user with sufficient authorization.
260002	This notification is triggered by the system function "TrackUserChange".	-
260003	The user has logged off from the system.	-
260004	The user name entered into the user display already exists in the user administration.	Select another user name because user names have to be unique in the user administration.
260005	The entry is rejected.	Use a shorter user name.
260006	The entry is rejected.	Use a shorter or longer password.
260007	The log-off time you entered is outside the valid range of 0 to 60 minutes. The entered value will be discarded and the original value is retained.	Enter a value between 0 and 60 minutes for the log-off time.
260008	An attempt was made to read a PTProRun.pwl file created with ProTool V 6.0 in WinCC flexible. Reading the file was interrupted due to incompatibility of the format.	-
270000	A tag is not displayed in the alarm because it attempts to access an invalid address in the controller.	Check whether the data area for the tag in the controller exists, whether the configured address is correct and whether the value range for the tag is correct.
270001	There is a unit-dependent limit as to how many alarms may be queued simultaneously in order to be displayed (see GHB). This limit has been exceeded. The display no longer contains all the alarms. However, all the alarms are recorded in the alarm buffer.	-
270002	Alarms are displayed from a log, for which there is no data in the current project. Placeholders are issued for the alarms.	Delete older log data, if necessary.
270003	The service cannot be set up because too many devices want to set up this service. A maximum of four devices may execute this action.	Connect fewer HMI devices which want to use the service.
280000	Connection is reestablished because the cause of the interruption has been eliminated.	-

Number	Effect/cause	Remedy
280001	No more data are read or written. Possible causes: <ul style="list-style-type: none"> • The cable is defective. • The controller does not respond, is defective, etc. • Connection has been established via the wrong interface. • The system is overloaded. 	Check if <ul style="list-style-type: none"> • the cable is plugged in • the controller is OK • the correct interface is used. Reboot the system if the system event is displayed persistently.
280002	A connection is being used that requires a function module in the controller. The function block has replied. Communication can now proceed.	-
280003	A connection is used that requires a function module in the controller. The function block has not replied.	Check if: <ul style="list-style-type: none"> • the cable is plugged in • the controller is OK • the correct interface is used. Restart the system if the system event is displayed persistently. Remedy depends on the error code: <ol style="list-style-type: none"> 1: The function block must set the COM bit in the response container. 2: The function block must not set the ERROR bit in the response container. 3: The function block must respond within the specified time (timeout). 4: Establish an online connection to the controller.
280004	The connection to the controller is interrupted. There is no data exchange at present.	Check the connection parameters in WinCC flexible. Check that the cable is plugged in, the controller is operational, the correct interface is being used. Restart the system if the system event is displayed persistently.
290000	The recipe tag could not be read or written. It is assigned the start value. The alarm can be entered in the alarm buffer for up to four more failed tags, if necessary. After that, the alarm number 290003 is issued.	Check in the configuration that the address has been set up in the controller.
290001	An attempt has been made to assign a value to a recipe tag which is outside the value range permitted for this type. The alarm can be entered in the alarm buffer for up to four more failed tags, if necessary. After that, the alarm number 290004 is issued.	Observe the value range for the tag type.
290002	It is not possible to convert a value from a source format to a target format. The alarm can be entered in the alarm buffer for up to four more failed recipe tags, if necessary. After that, the alarm number 290005 is issued.	Check the value range or type of the tag.
290003	This alarm is issued when alarm number 290000 is triggered more than five times. In this case, no further individual alarms are generated.	Check in the configuration that the tag addresses have been set up in the controller.

Number	Effect/cause	Remedy
290004	This alarm is issued when alarm number 290001 is triggered more than five times. In this case, no further individual alarms are generated.	Observe the value range for the tag type.
290005	This alarm is issued when alarm number 290002 is triggered more than five times. In this case, no further individual alarms are generated.	Check the value range or type of the tag.
290006	The threshold values configured for the tag have been violated by values entered.	Observe the configured or current threshold value of the tag.
290007	There is a difference between the source and target structure of the recipe currently being processed. The target structure contains an additional data recipe tag which is not available in the source structure. The data recipe tag specified is assigned its start value.	Insert the specified data recipe tag in the source structure.
290008	There is a difference between the source and target structure of the recipe currently being processed. The source structure contains an additional data recipe tag which is not available in the target structure and therefore cannot be assigned. The value is rejected.	Remove the specified data recipe tag in the specified recipe from the project.
290010	The storage location configured for the recipe is not permitted. Possible causes: Impermissible characters, write protected, data medium full or does not exist.	Check the configured storage location.
290011	The data record with the specified number does not exist.	Check the source for the number (constant or tag value).
290012	The recipe with the specified number does not exist.	Check the source for the number (constant or tag value).
290013	An attempt was made to save a data record under a data record number which already exists. The action is not executed.	The following remedies are available: <ul style="list-style-type: none"> • Check the source for the number (constant or tag value). • First, delete the data record. • Change the "Overwrite" function parameter.
290014	The file specified to be imported could not be found.	Check the following: <ul style="list-style-type: none"> • Check the file name. • Ensure that the file is in the specified directory.
290020	Acknowledgment that downloading of data records from HMI device to controller has started.	-
290021	Acknowledgment that downloading of data records from HMI device to controller was completed without errors.	-
290022	Acknowledgment that downloading of data records from HMI device to controller was aborted due to an error.	Check in the configuration whether: <ul style="list-style-type: none"> • The tag addresses are configured in the controller • The recipe number exists • The data record number exist? • The "Overwrite" function parameter is set

Number	Effect/cause	Remedy
290023	Acknowledgment that downloading of data records from the controller to the HMI device has started.	-
290024	Acknowledgment that downloading data records from the controller to the HMI device was completed without errors.	-
290025	Acknowledgment that downloading of data records from the controller to the HMI device was aborted due to an error.	Check in the configuration whether: <ul style="list-style-type: none"> • The tag addresses are configured in the controller • The recipe number exists • The data record number exist? • The "Overwrite" function parameter is set
290026	An attempt has been made to read/write a data record although the data record is not free at present. This error may occur in the case of recipes for which downloading with synchronization has been configured.	Set the data record status to zero.
290027	No connection to the controller can be established at present. As a result, the data record can neither be read nor written. Possible causes: No physical connection to the controller (no cable plugged in, cable is defect) or the controller is switched off.	Check the connection to the controller.
290030	This alarm is issued after reselecting a screen that contains a recipe display in which a data record is already selected.	Reload the data record from the storage location or retain the current values.
290031	While saving, it was detected that a data record with the specified number already exists.	Overwrite the data record or cancel the action.
290032	While exporting data records it was detected that a file with the specified name already exists.	Overwrite the file or cancel the process.
290033	Confirmation request before deleting data records.	-
290040	A data record error with error code %1 that cannot be described in more detail occurred. The action is canceled. It is possible that the data record was not installed correctly on the controller.	Check that the storage location, the data record, the "Data record" area pointer and, if necessary, the connection to the controller. Start the action again after waiting a short period. If the error persists, contact Customer Support. Provide them with the error code that occurs.
290041	A data record or file cannot be saved because the storage location is full.	Delete files no longer required.
290042	An attempt was made to execute several recipe actions simultaneously. The last action was not executed.	Trigger the action again after waiting a short period.
290043	Confirmation request before storing data records.	-
290044	The data store for the recipe has been destroyed and will be deleted.	-
290050	Acknowledgment that the export of data records has started.	-
290051	Acknowledgment that the export of data records was completed successfully.	-

Number	Effect/cause	Remedy
290052	Acknowledgment that the export of data records was aborted due to errors.	Ensure that the structure of the data records at the storage location and the current recipe structure on the HMI device are identical.
290053	Acknowledgment that the import of data records has started.	-
290054	Acknowledgment that the import of data records was completed successfully.	-
290055	Acknowledgment that the import of data records was aborted due to errors.	Ensure that the structure of the data records at the storage location and the current recipe structure on the HMI device are identical.
290056	The value in the specified line/column could not be read/written without errors. The action was cancelled.	Check the specified line/column.
290057	The tags of the recipe specified were switched from operating mode "offline" to "online". Each modification of a tag in this recipe is now immediately transferred to the controller.	-
290058	The tags of the recipe specified were switched from operating mode "online" to "offline". Modifications to tags in this recipe are no longer immediately transferred to the controller but must be transferred there explicitly if necessary, by downloading a data record.	-
290059	Acknowledgment that the specified data record was stored successfully.	-
290060	Acknowledgment that the data record memory was cleared successfully.	-
290061	Acknowledgment that clearing the data record memory was aborted due to errors.	-
290062	The data record number is above the maximum of 65536. This data record cannot be created.	Select another number.
290063	This occurs with the system function "ExportDataRecords" when the parameter "Overwrite" is set to No. An attempt has been made to save a recipe with a file name that already exists. The export is cancelled.	Check the system function "ExportDataRecords".
290068	Request to confirm whether all data records in the recipe should be deleted.	-
290069	Request to confirm whether all data records of all recipes should really be deleted.	-
290070	The data record specified is not in the import file.	Check the source of the data record number or data record name (constant or tag value).
290071	During the editing of data record values, a value was entered that was below the lower limit of the recipe tag. The entry is rejected.	Enter a value within the limits of the recipe tag.

Number	Effect/cause	Remedy
290072	During the editing of data record values, a value was entered that was above the upper limit of the recipe tag. The entry is rejected.	Enter a value within the limits of the recipe tag.
290073	An action (e.g. saving a data record) was not possible due to an unknown reason. The error corresponds to the status alarm IDS_OUT_CMD_EXE_ERR in the large recipe view.	-
290074	While saving, it was detected that a data record with the specified number already exists but under another name.	Overwrite the data record, change the data record number, or cancel the action.
290075	A data record with this name already exists. The data record will not be saved.	Please select a different data record name.
300000	Process monitoring (e.g. using PDiag or S7-Graph) has been incorrectly programmed: More alarms are queued than specified in the technical data of the CPU. No further ALARM_S alarms can be managed by the controller and reported to HMI devices.	Change the controller configuration.
300001	The registration for ALARM_S will not be made on this controller.	Select a controller that supports the ALARM_S service.
310000	An attempt is being made to print too many reports simultaneously. Since only one report can be printed at a time, the print job is rejected.	Wait until the printout of the previous active report has finished. Repeat the print job if necessary.
310001	An error occurred on triggering the printer. The report is either not printed or printed with errors.	Evaluate the additional system event, related to this alarm which is also generated. Repeat the print job if necessary.
320000	The movements have already been indicated by another device. The movements can no longer be controlled.	Select the movements on the other display units and select the movement screen on the required display unit.
320001	The network is too complex. The defective operands cannot be displayed.	Display the network in STL.
320002	No diagnostics-capable alarm have been selected. The units related to the alarm could not be selected.	Select a diagnostics-capable alarm in the screen ZP_ALARM.
320003	No alarms exist in respect of the selected unit. No network can be displayed in the detail view.	Select the defective unit in the general view screen.
320004	The required signal statuses could not be read by the controller. The defective operands cannot be determined.	Check the consistency between the configuration on the display unit and the controller program loaded.
320005	The project contains ProAgent partitions which are not installed. No ProAgent diagnostics can be performed.	In order to run the project, install the ProAgent option packet.
320006	You have attempted to execute a function that is not possible with the current configuration.	Check the type of the selected unit.
320007	No operands causing a fault have been found in the networks. ProAgent cannot display any blocked operands.	Switch the Detail Screen to STL display mode and check the status of the operands and exclusion operands.

Number	Effect/cause	Remedy
320008	The diagnostic data saved in the configuration is not synchronized with that in the controller. ProAgent can only display the diagnostic units.	Recompile the project and download it to the HMI device again.
320009	The diagnostic data saved in the configuration is not fully synchronized with that in the controller. The diagnostic screens can be operated normally. ProAgent may be unable to display all diagnostic texts.	Recompile the project and download it to the HMI device again.
320010	The diagnostic texts saved in the configuration are not synchronized with that in the STEP7. The ProAgent diagnostics data are not up-to-date.	Recompile the project and download it to the HMI device again.
320011	There is no unit with the DB number and FB number concerned. The function cannot be executed.	Check the parameters of function "SelectUnit" and the units selected in the project.
320012	The "Step sequence mode" dialog box is no longer supported.	Use Step Sequence Screen ZP_STEP from the appropriate standard project for your project. Instead of calling function Overview_Step_Sequence_Mode, call the function "FixedScreenSelection" using ZP_STEP as the screen name.
320014	The selected controller cannot be evaluated for ProAgent. The alarm display configured with the system function "EvaluateAlarmDisplayFault" could not be found.	Check the parameters of the system function "EvaluateAlarmDisplayFault".

Abbreviations

CPU	Central Processing Unit
CSV	Comma Separated Values
CTS	Clear To Send
DC	Direct Current
DCD	Data Carrier Detect
DIL	Dual-in-Line (electronic chip housing design)
DP	Distributed I/Os
DSN	Data Source Name
DSR	Data Set Ready
DTR	Data Terminal Ready
EMC	Electromagnetic Compatibility
EN	European standard
ES	Engineering System
ESD	Electrostatic Discharge, the components and modules endangered by such.
ESD	Electrostatic Sensitive Device
GND	Ground
HF	High Frequency
HMI	Human Machine Interface
IEC	International Electronic Commission
IF	Interface
LED	Light Emitting Diode
MMC	Multi-Media Card
MOS	Metal Oxide Semiconductor
MPI	Multipoint Interface (SIMATIC S7)
MS	Microsoft
MTBF	Mean Time Between Failures
n. c.	Not connected
OP	Operator Panel
PC	Personal Computer
PG	Programming device
PLC	Programmable Logic Controller
PPI	Point to Point Interface (SIMATIC S7)
RAM	Random Access Memory
RTS	Request To Send
RxD	Receive Data
SELV	Safety Extra Low Voltage
SP	Service pack

Abbreviations

STN	Super Twisted Nematic
Sub-D	Subminiature D (plug)
TAB	Tabulator
TCP/IP	Transmission Control Protocol/Internet Protocol
TFT	Thin Film Transistor
TxD	Transmit Data
UL	Underwriter's Laboratory

Glossary

Acknowledge

Acknowledgement of an alarm confirms that it has been noted.

AG

Is a PLC in the SIMATIC S5 series, the AG S5-115U for example

Alarm, acknowledging

Acknowledgement of an alarm confirms that it has been noted.

Alarm, arriving

Moment at which an alarm is triggered by the PLC or HMI device.

Alarm, departing

Moment at which the triggering of an alarm by the PLC is reset.

Alarm logging

Is the printout of user-defined alarms parallel to output on the HMI device screen.

Alarm, user-defined

A user defined alarm can be assigned to one of the following alarm classes:

- Error
- Operation
- User-defined alarm classes

A user-defined alarm makes reference to a certain operating status of the system being monitors which is connected to the HMI device via the PLC.

AS

Is a PLC in the SIMATIC S7 series, the SIMATIC S7-300 for example

AS 511

Is the protocol of the programming unit interface to the PLC SIMATIC S5

Booting

Also refer to Starting

Bootloader

Used to start up the operating systems and is automatically started when the HMI device is switched on. A start graphic is displayed during startup. Once the operating system is loaded, the loader or the Control Panel is displayed, depending on the HMI device.

Bootstrapping

An option for updating the operating system. When a functional operating system is available, updating can be carried out without booting. Otherwise, updating with booting is necessary. In this case, the configuration computer communicates with the HMI device via the bootloader.

Configuration computer

Is the general term for programming units and PCs on which projects are created, using a configuration software, for use monitoring a system.

Configuration software

Is a software to create projects which serves for process visualization – also refer to project, process visualization and runtime software.

Controller

Is a general term for devices and systems with which the HMI device communicates, e.g. SIMATIC S7.

Display duration

Defines whether and how long a system event is displayed on the HMI device.

Event

Functions are triggered by the arrival of defined events. Events can be configured. Events which can be configured for a button include 'press button' and 'release button'.

Fault time

This relates to the time interval between the arrival and departure of an alarm.

Field

Is an area reserved in configured screens for entering input and output values.

Flash memory

Is a memory with non-volatile memory chips which is used as a mobile storage medium in the form of a memory card or installed permanently on the main board. The mobile storage medium market is determined by Flash memories: CompactFlash and SmartMedia are predominant.

CompactFlash and SmartMedia differ in their basic, inner design. In the case of CF cards, the control electronics is in the card whereby, with SM cards, the control electronics is installed in the associated device.

Function

A function is linked to an icon in the Control Panel or an operating element in the project.

Function key / Softkey

Is a key on the HMI device which can be configured as required. A function is assigned to the key during the configuration. The assignment of the function keys may be dependent on the screen being displayed or independent of the screen displayed.

Half brightness life

Time period after which the brightness of the lighting tube only achieves 50% of its original value, for example. The specified value is dependent on the operating temperature.

Hardcopy

Represents a printout of the current screen content on a connected printer.

Image

Is a file which can be transferred from the configuration computer to the HMI device. The Image contains the operating system for the HMI device and parts of WinCC flexible runtime required to run a project.

IO field

The I/O field enables values to be entered or output on the HMI device which are then transferred to the PLC.

Job mailbox

This triggers a function via the PLC.

Notation

Is a system of characters, symbols and rules - particularly used in data processing when defining how the programming language should be written.

Object

Is a component part of a project, e.g. a screen or alarm. Objects serve to display or enter texts and values on the HMI device.

Operating element

Is a component part of a project to enter values and trigger functions. A button, for example, is an operating element.

Operator note

Configurable information on objects in a project. The operator note concerning an alarm can, for example, contain information on the cause of the fault and methods of elimination.

Process visualization

Is the representation of processes from the areas of production, logistics and services using texts and graphics. Configured elements enable the data to be read from and written to processes running on systems being monitored and, thus, to actively intervene in them.

Project

Is the result of a configuration using a configuration software. The project contains system-specific objects, basic settings and alarms in the form of screens. The project is saved in the project file with the file name extension *.hmi if it has been configured with WinCC flexible.

It is necessary to distinguish between the project on the configuration computer and that on an HMI device. A project on the configuration computer can be available in more several languages than can be managed on the HMI device. The project on the configuration computer can be set up for different HMI devices. Only the project set up for a particular HMI device can be transferred to that HMI device.

Project file

Is the compiled file which is created after the configuration from a source file for a specific HMI device. The project file is transferred to the associated HMI device and serves for operating and monitoring the system to be monitored. Refer to Source file.

Recipe

A combination of tags to a fixed data structure. The data structure configured can be assigned data on the HMI device and is then referred to as a data record. The use of recipes ensures that when a data record is downloaded, all the assigned data is transferred to the PLC together and synchronously.

Remote on/off

Is an option in the "Loader" menu which enables and disables remote control of the HMI device from the PLC.

Runtime

Instantiation for a project on an HMI device. Refer to project file.

Runtime software

Is a software for process visualization with which a project on a configuration computer can be tested – also refer to project and configuration software.

Screen

A screen displays all the logically related process data on the HMI device. The display of the process data can be supported by graphic objects.

Screen object

Is a configured object for displaying or operating the system being monitored, e.g. a rectangle, an I/O field or Recipe View.

Source file

Is the file from which various project files can be created, depending on the configuration. The source file is not transferred and remains on the configuration computer.

The file extension of a source file is *.hmi. Refer to Source file, compressed and Project file.

Source file, compressed

Is the compressed form of the source file. It can be transferred, in addition to the project file, to the associated HMI device. "Enable BackTransfer" must be activated in the project on the configuration computer. The file extension of a compressed source file is *.pdz. The standard memory location for a compressed source file is the external memory card. Refer to Source file.

To restore a source file, it is necessary to use the same WinCC flexible version which was used to configure the project.

Start

A project can be called in by means of a button in the Loader. This procedure is referred to as "starting".

STEP 7

Programming software for SIMATIC S7, SIMATIC C7 and SIMATIC WinAC.

Symbolic IO field

Is a field for the input/output of a parameter. I.e. it contains a list of predefined entries from which one can be selected.

System alarms

Is assigned to the "System" alarm class. A system event makes reference to internal states in the HMI device and the PLC.

System, to be monitored

Is a general term for machines, processing centers, systems and plants as well as processes which are to be operated and observed by an HMI device.

Tab order

Is defined during the configuration to set the sequence in which objects are focused on pressing the <TAB> key.

Transfer

The transfer of a run-capable project to the HMI device.

Transfer mode

Is an operating mode on the HMI device used for transferring a run-capable project from the configuration computer to the HMI device. Refer to Transfer mode.

Activates Transfer mode. Setting the HMI device to Transfer mode is a condition for transferring data from the configuration computer to the HMI device and vice versa. A logical connection via the data line does not exist. Refer to Transfer mode.

Tag

Is a defined memory location in which values can be written to and read from. This can be done from the PLC or via the HMI device. Depending on whether the tags have a connection to the PLC or not determines the difference between "external" tags (process tags) and "internal" tags.

Index

A

- Accessories
 - Accessory kit, 1-6
 - Memory card, 1-6
- Accessory kit, 1-6
- ACK
 - Key, 9-9
- Acknowledge
 - Key, 9-9
- Alarm, 1-7, 1-8
- Alarm buffer
 - In Runtime, 8-2
- Alarm indicator
 - Behavior, 9-19
 - In Runtime, 8-2
 - Purpose, 9-19
- Alarm report, 8-2, 8-6
- Alarm view
 - In Runtime, 8-2
 - Layout, 9-20
 - Operator controls, 9-20
 - Purpose, 9-20
- Alarm window
 - In Runtime, 8-2
- Alarms
 - In Runtime, 8-1
- Alphanumeric key assignment, 9-9
- Alphanumeric screen keyboard, 9-6
- ALT
 - Key, 9-10
- Ambient conditions
 - Ambient, 12-5
 - Mechanical, 12-5
- application
 - In industrial sector, 2-1
 - In residential areas, 2-2
- Approvals, A-1
- Authorization, vi
 - In Runtime, 8-4
- Automatic transfer, 7-6

B

- Back transfer, 7-9
 - Execute, 7-10
 - Requirement, 7-10
- Back up..., 7-12
- Backspace
 - Key, 9-9
- Backup, 6-12, 7-11, 7-12, 7-15, 7-17
- Bar
 - Layout, 9-24
 - Operation, 9-24
 - Purpose, 9-23
- Barometric pressure, 12-5
- Basic dimensions of the TP 170micro, 12-1
- Behavior
 - Alarm indicator, 9-19
 - IO field, 9-15
 - Recipe view with screen change, 10-6
 - Simple recipe view, 10-9
- Brightness
 - Setting, 9-10
 - TP 170A, 6-4
 - TP 170B, 6-4
 - TP 170micro, 6-4
- bus parameter
 - modify, 7-4
- Button
 - Layout, 9-13
 - Purpose, 9-13
- Button action feedback, 9-3

C

- Cable cross-section, 4-14
- Cables
 - Connecting, 4-5
- Calculation functions, 1-7, 1-9
- Calibrating
 - Touch screen, 6-23, 6-32

- Calling
 - Operator note:keyboard device, 9-11
 - Operator note:System function, 9-7
 - Operator note:touch panel, 9-7
- Cancel
 - Key, 9-9
 - Transfer, 6-6
- Certificates
 - ESD, A-1
- Clean screen, 11-1
- Cleaning agents, 11-1
- Close
 - Dialog, 9-11
- Closing
 - Control Panel, 6-8
 - Function, 6-10
 - On-screen keyboard, 6-17
- Combo box
 - open, 9-10
- Communications Properties, 6-13
- Compatibility conflict, 7-11
- Compressing the program memory, 4-10
- Configuring the interface, 4-9
- Connectable controller
 - other manufacturers, 1-11
- Connectable controllers
 - SIMATIC, 1-10, 1-11
- Connecting
 - Cables, 4-5
 - Configuration computer, 4-11
 - Controller, 4-7
 - HMI device, 4-3
 - Periphery, 4-12
 - Plug-in terminal block, 4-14
 - Potential equalization line, 4-5
 - Power supply, 4-15
- Connecting peripheral equipment
 - Connection configurator, 4-12
- Connecting the configuration computer
 - Connection configurator, 4-11
- Connecting the PLC
 - Configuring the interface, 4-9
 - Connection configurator, 4-7
- Connecting the terminal block, 4-14
- Connection
 - Cable cross-section, 4-14
 - Electrical, 4-3, 4-4
 - Order, 4-3
- Connection configurator
 - Configuration computer, 4-11
 - Controller, 4-7
 - Periphery, 4-12
 - Potential equalization line, 4-6
 - Power supply, 4-14

- Contrast
 - TP 170A, 6-4
 - TP 170B, 6-4
 - TP 170micro, 6-4
- Control Panel
 - Closing, 6-8
 - Navigation, 6-7
 - open, 6-7
- Control Settings
 - Dialog, 6-4
- Controller
 - Number of connectable, 1-10
 - Number of connectible, 1-11
- Copy
 - Recipe data record in Runtime, 10-11
- create
 - Recipe record on the HMI device, 10-11
- Cross-section
 - Connection cables, 4-14
- CSV file, 10-2
- CTRL
 - Key, 9-9
- Cursor
 - Key, 9-9

D

- Data loss, 5-3, 5-6, 7-17
- Data record
 - exporting, 10-14
 - importing, 10-14
 - reading, 10-13
 - Transfer, 10-13
- Date / time field
 - Behavior, 9-27
 - Layout, 9-26
 - Purpose, 9-26
 - Touch control, 9-27
- Date and time
 - synchronizing, 6-14
- Date/time field
 - Keyboard control, 9-27
- Date/time properties, 6-13
- Delete
 - Key, 9-9
- deleting
 - Recipe data record in Runtime, 10-12

- Dialog
 - Backup/Restore, 6-12
 - Closing, 9-11
 - Closing function, 6-10
 - Communications Properties, 6-13
 - Control Settings, 6-4
 - Date/time properties, 6-13
 - Keyboard properties, 6-18
 - Mouse properties, 6-19
 - OP properties, 6-21
 - Opening a function, 6-9
 - Password properties, 6-24
 - Printer properties, 6-26
 - Regional Settings properties, 6-27
 - S7-Transfer Settings, 6-37
 - Screen Saver, 6-30
 - Setting Ethernet transfer, 6-40
 - Siemens HMI Input Panel – Options, 6-15
 - System properties, 6-31
 - Transfer Settings, 6-34, 6-39
- DIL switch, 5-2, 5-5
 - Position on OP 170B, 4-9
 - Position on TP 170A, 4-9
 - Position on TP 170B, 4-9
 - Setting on the OP 170B, 4-10
 - Setting on the TP 170A, 4-10
 - Setting on the TP 170B, 4-10
 - Setting on the TP 170micro, 4-10
- DirectKey, 9-3
- Display, 12-2, 12-4
 - Setting, 6-22
- Displaying
 - HMI device features, 6-22
- E**
- Editing, 10-2
 - Recipe data record in WinCC flexible, 10-3
 - Recipe record, 10-2
- Electrostatic charge
 - Precautions, A-2
- EMC
 - Correct installation, 3-1
 - Guidelines, 3-1
 - Requirements, 12-6
 - Standards, 12-6
- Enabling
 - TP 170B and OP 170B, 4-17
 - TP 170micro and TP 170A, 4-16
- END
 - Key, 9-9
- Enter
 - Key, 9-9
- ENTER
 - Key, 9-9
- ESC
 - Key, 9-9
- ESD, A-1
 - Handling, A-2
 - Measuring, A-3
 - Shipping, A-3
- exporting
 - Recipe, 10-14
 - Recipe record, 10-14
 - User data, 8-5
- F**
- Feedback
 - visual, 9-3
 - with touch control, 9-3
- File:
 - Saving, 6-21
- Function
 - Additional, 1-8, 1-10
- Function keys, 5-4
 - Labeling, 5-7
- Function test, 4-18
- Functional scope
 - TP 170B, OP 170B, 1-8
 - TP 170micro, TP 170A, 1-7
- G**
- General operation
 - Keyboard unit, 9-8
 - Touch panel, 9-2
- Graphic IO field
 - Purpose, 9-17
- Group acknowledgement, 9-9
- Guidelines
 - ESD, A-1

H

High frequency radiation, 2-1

HMI device

- Connecting, 4-3
- Enabling, 4-16, 4-17
- Initial commissioning, 7-2
- installation, 3-2
- Recommissioning, 7-3
- Securing, 3-3
- Set parameters, 6-34
- Switch off, 4-19
- Transfer mode, 7-3

HMI device features

- Displaying, 6-22

HOME

- Key, 9-9

Housing, 12-2, 12-3

I

IF 1A, 12-8

IF 1B, 12-8

IF 2, 12-9

Image, 6-42

- Version, 6-23, 7-18

Immunity to interference

- EMC Guidelines, 3-1

importing

- Recipe, 10-14
- Recipe record, 10-14
- User data, 8-5

Initial commissioning

- HMI device, 7-2

Input

- Alphanumeric values, 9-6

Input of alphanumeric values, 9-6

Input panel - options, 6-15

installation

- HMI device, 3-2

Installation cut-out

- Dimensions, 3-5
- Making, 3-5
- OP 170B, 3-6
- Selecting, 3-4
- Space, 3-6
- TP 170micro, TP 170A, TP 170B, 3-5

Installation of the HMI device

- Installation position, 3-2
- Type of fixation, 3-2

Installation position, 3-2

Interfaces

- OP 170B, 4-4
- TP 170A, 4-4
- TP 170B, 4-4
- TP 170micro, 4-4

Interference immunity, 12-6

IO field

- Behavior, 9-15
- Keyboard control, 9-16
- Layout, 9-15
- Purpose, 9-15
- Touch control, 9-16

K

Keyboard, 12-3, 12-4

- Setting, 6-18

Keyboard control

- Date/time field, 9-27
- IO field, 9-16

Keyboard damage, 5-1

Keyboard layers, 9-6

Keyboard properties, 6-18

L

Labeling strips, 1-6, 5-5

- Inserting, 5-8
- Printing, 5-7
- Template file, 5-7

Language settings, 6-4

Language switching, 9-1

Layout

- Alarm view, 9-20
- Bar, 9-24
- Button, 9-13
- IO field, 9-15
- Recipe views, 10-6
- Simple alarm view, 9-22
- Simple recipe view, 10-8
- Simple user view, 9-29
- Switch, 9-14
- Trend view, 9-25
- User view, 9-28

LED control, 8-6

Light emitting diode

- Acknowledge, 9-9
- Operator note, 9-9
- Toggle, 9-9

List, 1-7, 1-9

Load
 Recipe data record in Runtime, 10-11

Loader, 4-16, 4-18
 Menu, 6-5
 OP 170B, 6-5
 TP 170A, 6-1
 TP 170B, 6-5
 TP 170micro, 6-1

Locking
 Operating element, 11-2

Logoff time
 Exporting/importing, 8-5
 In Runtime, 8-5

M

Maintenance, 11-1

Making
 Installation cut-out, 3-5

Manual
 Range of validity, iii

Manual transfer, 7-5

Memory, 12-3, 12-4

Memory card, 1-6
 Insert, 5-2, 5-6
 Restoring, 7-13
 Saving, 7-12
 Using, 5-2, 5-6

Memory card slot, 5-5

Menu
 Navigation, 6-5, 6-7, 6-10

modify
 Recipe data record in Runtime, 10-11
 Settings in the dialog, 6-11

Mouse properties, 6-19

Moving
 On-screen keyboard, 6-16

MPI/PROFIBUS DP address
 Setting, 6-36

Multiple key operation, 9-1

N

Navigating
 In Control Panel, 6-7, 6-10
 in the loader, 6-5

Note
 General, 2-1
 Safety, 2-1
 Transfer mode, 7-4

Numeric keyboard assignment, 9-9

O

Object
 Alarms, 1-7, 1-8
 Operator note, 1-10
 Screens, 1-8
 Screens, recipes, 1-9
 Tags, values, lists and calculation functions, 1-7, 1-9

Objects in Runtime
 Overview, 8-1

Offices, vi

Offline test, 7-8

Online test, 7-8

On-screen keyboard
 Saving the position, 6-16

On-screen keyboard, 9-4
 Closing, 6-17
 Moving, 6-16
 open, 6-15

OP 170B
 Functions, 1-8

OP properties, 6-21

open
 Control Panel, 6-7
 Function, 6-9
 On-screen keyboard, 6-15

Open
 Combo box, 9-10
 Tab, 9-11

Operating a keyboard device, 9-8

Operating element
 Locking, 11-2

Operating elements and indicators
 Front side, 5-1, 5-4

Operating mode
 Changing, 7-3
 Offline mode, 7-4
 Online mode, 7-4
 Transfer mode, 7-4

Operating mode switchover, 7-8

Operating recipes
 Copying a recipe data record, 10-11
 Creating recipe records, 10-11
 Data record transfer, 10-13
 Delete recipe data record, 10-12
 Exporting data records, 10-14
 Import a data record, 10-14
 Load recipe data record, 10-11
 Modify recipe record, 10-11
 Read recipe data record, 10-13
 Synchronizing recipe tags, 10-12

- Operating system, 6-42
 - Configuring, 6-1, 6-5
 - Load, 4-16, 4-18
 - Updating, 7-19
- Operating the touch panel (TP), 9-2
- Operation
 - Bar, 9-24
 - Keyboard unit, 9-8
 - Touch objects, 9-2
 - Touch panel, 9-2
- Operator controls, 5-2, 5-5
 - Alarm view, 9-20
 - DIL switch, 5-2, 5-5
 - Labeling strips, 5-5
 - Memory card slot, 5-3, 5-5, 5-6
 - Recipe views, 10-6
 - Simple alarm view, 9-22
 - Simple recipe view, 10-9
 - Trend view, 9-25
- Operator note, 1-10
 - Calling:keyboard device, 9-11
 - Calling:system function, 9-7
 - Calling:Touch panel, 9-7
 - viewing (key), 9-9
- Order
 - The connections, 4-3
- Overall dimensions of the OP 170B, 12-2
- Overall dimensions of the TP 170A, 12-1
- Overall dimensions of the TP 170B, 12-1

P

- Password
 - Exporting/importing, 8-5
 - In Runtime, 8-5
- Password properties, 6-24
- PC-PPI adapter, 1-6
- Pin assignment
 - Power supply, 12-7
 - RS 485, 12-8
 - RS-232, 12-8, 12-9
 - RS-422, 12-8
- PLCs from other manufacturers
 - Reports, 1-11
- Potential difference, 4-5
- Potential equalization cable, 4-6
- Potential equalization line
 - Connecting, 4-5
 - Connection configurator, 4-6
 - Potential difference, 4-5
 - Potential equalization cable, 4-6
 - Requirements, 4-5
 - Setting up, 4-6

- Power supply
 - Connecting, 4-15
 - Connecting the terminal block, 4-14
 - Connection configurator, 4-14
 - Reverse battery protection, 4-15
- Power supply network, 12-7
- Printing
 - Runtime, 8-6
 - Screen, 8-6
- Project
 - Back transfer, 7-9
 - Replacing, 7-3
 - Stop, 9-12
 - Test, 7-8
 - Test offline, 7-8
 - Test online, 7-9
 - Transfer, 7-1
- ProSave, 7-14
 - In WinCC flexible, 7-14
 - Restoring, 7-17
 - Saving, 7-15
 - Standalone, 7-14
- Protective cover, 1-6, 11-2
- Protective membrane, 1-6, 11-2
- Purpose
 - Alarm indicator, 9-19
 - Alarm view, 9-20
 - Bar, 9-23
 - Button, 9-13
 - IO field, 9-15
 - Recipe views, 10-6
 - Simple alarm view, 9-22
 - Simple recipe view, 10-8
 - Simple user view, 9-29
 - Switch, 9-14
 - Trend view, 9-24

R

- Radio frequency interference, 12-6
- Recess, 3-3
- Recipe, 1-9, 10-1, 10-2
 - Basic principles, 10-1
 - Data record, 10-2
 - Design, 10-1
 - Display in Runtime, 10-3, 10-4
 - exporting, 10-14
 - importing, 10-14

- Recipe record, 10-2
 - Copy, 10-11
 - Create on the HMI device, 10-11
 - deleting, 10-12
 - Design, 10-1
 - Editing in WinCC flexible, 10-3
 - exporting, 10-14
 - importing, 10-14
 - Load, 10-11
 - modify, 10-11
 - synchronizing, 10-12
- Recipe screen, 10-5
 - Overview, 10-5
- Recipe views, 10-4
 - Behavior with screen change, 10-6
 - Layout, 10-6
 - Operation with function keys, 10-6
 - Operator controls, 10-6
 - Overview, 10-4
 - Purpose, 10-6
- Recommissioning
 - HMI device, 7-3
- Regional Settings properties, 6-27
- Remote control
 - HMI device, 7-6
 - Setting, 6-35
- Removing
 - Protective membrane, 11-2
- Representatives, vi
- Requirements
 - EMC, 12-6
- Resistance
 - Harmful substances, 12-5
- Restore, 6-12, 7-11, 7-12
- Restore..., 7-12
- Restoring
 - Memory card, 7-13
 - ProSave, 7-17
- Reverse battery protection, 4-15
- RF conduction, 12-7
- RS 232 (IF 1A), 12-8
- RS 232 (IF 2), 12-9
- RS 422 (IF 1B), 12-8
- RS 485 (IF 1B), 12-8
- Runtime, 6-42
 - Language switching, 9-1
 - Multiple key operation, 9-1
 - Operation, 9-1
 - Pictograms, 9-2

S

- S7-Transfer Settings, 6-37
- Safety
 - In Runtime, 8-4
- Safety instructions
 - High frequency radiation, 2-1
 - Work on the cabinet, 2-1
- saving
 - Screen keyboard position, 6-16
- Saving
 - File:, 6-21
 - Memory card, 7-12
 - ProSave, 7-15
 - Tab entry, 6-21
- Schematic diagram
 - Back transfer, 7-2
 - Backup, 7-2
 - Recovery, 7-2
 - Transfer, 7-2
- Scope of maintenance, 11-1
- Screen, 1-8, 1-9
 - Printing, 8-6
 - Set brightness, 9-10
 - Templates, 9-2
- Screen keyboard
 - Alphanumeric, 9-6
- Screen objects
 - In Runtime, overview, 8-1
- Screen saver, 6-30
- Screen Saver, 6-30
- ScreenSaver settings, 6-4
- Scrolling back
 - Key, 9-9
- Scrolling up
 - Key, 9-9
- Securing
 - HMI device, 3-3
- Serial transfer
 - Setting, 6-35
- Service
 - In the Internet, vi
- Service pack, 11-6
- Servicing, 11-6
- Set Baudrate, 6-36
- Set region, 6-28
- Set time format, 6-29

Setting

- Baud rate, 6-36
- Date, 6-13
- Date format, 6-29
- Digit separation, 6-28
- Display, 6-22
- Ethernet transfer, 6-40
- Keyboard, 6-18
- MPI/PROFIBUS DP address, 6-36
- Number format, 6-28
- Region, 6-28
- Remote control, 6-35, 6-40
- Screen saver, 6-30
- Serial transfer, 6-35
- Time, 6-13
- Time format, 6-29
- Setting digit separation, 6-28
- Setting number format, 6-28
- Setting remote control, 6-40
- Setting the date, 6-13
- Setting the date format, 6-29
- Setting the time, 6-13
- Settings
 - Brightness, 9-10
- Settings in the dialog, 6-11
- SHIFT
 - Key, 9-9
- SIMATIC PLC
 - Profile, 1-10
 - Reports, 1-11
- SIMATIC S5
 - Compressing the program memory, 4-10
- Simple alarm view
 - Layout, 9-22
 - Operator controls, 9-22
 - Purpose, 9-22
- Simple recipe view
 - Behavior, 10-9
 - Layout, 10-8
 - Operator controls, 10-9
 - Purpose, 10-8
- Simple user view
 - Layout, 9-29
 - Purpose, 9-29
- Source file
 - Testing, 7-10
- Space
 - OP 170B, 3-7
 - TP 170B, 3-7
 - TP 170micro, TP 170A, 3-6
- Special characters, 6-24
- Spring terminal, 3-3
- Standards
 - EMC, 12-6

- Startup screen, 4-16, 4-17
- Stop
 - Project, 9-12
- Storage conditions, 12-5
- Style, 6-24
- Supply voltage, 12-3, 12-4
- Support
 - In the Internet, vi
- Switch
 - Layout, 9-14
 - Purpose, 9-14
- Switch off
 - HMI device, 4-19
- Symbolic IO field
 - Purpose, 9-18
- synchronizing, 6-14
- Synchronizing
 - Recipe record, 10-12
- Synchronizing recipe tags, 10-12
- System alarms, A-3
 - Meaning, A-4
 - Parameter, A-3
- System keys, 5-4
- System properties, 6-31

T

- TAB
 - Key, 9-9
- Tab entry
 - Saving, 6-21
- Tabulator
 - Key, 9-9
- Tag, 1-7, 1-9
- Tags
 - in Runtime, 8-3
- Technical specifications
 - Display, 12-2, 12-4
 - Housing, 12-2, 12-3
 - Keyboard, 12-3, 12-4
 - Memory, 12-3, 12-4
 - Power supply, 12-7
 - RS 485, 12-8
 - RS-232, 12-8, 12-9
 - RS-422, 12-8
 - Storage and transport conditions, 12-5
 - Supply voltage, 12-3, 12-4
- Technical Support, vi, 6-23
- Test
 - Project, 7-8
- Testing
 - TP 170B and OP 170B, 4-17
 - TP 170micro and TP 170A, 4-16

Toggle
 Key, 9-9
 Touch control
 Date / time field, 9-27
 IO field, 9-16
 Touch objects
 operating, 9-2
 Touch screen
 Calibrating, 6-23
 Touchscreen calibration, 6-32
 TP 170A
 Functions, 1-7
 TP 170A front view, 1-2
 TP 170A side view, 1-2
 TP 170B
 Functions, 1-8
 TP 170B front view, 1-3
 TP 170B side view, 1-3
 TP 170micro
 Functions, 1-7
 TP 170micro front view, 1-1
 TP 170micro side view, 1-1
 TP 170micro view from below, 1-1
 Trademarks, registered, v
 Training center, vi
 Transfer
 Cancel, 6-6
 inadvertent, 7-4
 Proceed as follows, 7-6
 Start automatically, 7-6
 Starting manually, 7-5
 Transfer mode, 9-10
 modify, 6-41
 MPI/PROFIBUS DP, 7-5
 Transfer settings, 7-5
 Transfer Settings
 Dialog, 6-34, 6-39
 Transferring the project
 Overview, 7-1
 Transport conditions, 12-5
 Trend view
 Layout, 9-25
 Operator controls, 9-25
 Purpose, 9-24
 Type of fixation, 3-3

U

Unplug
 Memory card, 5-3, 5-6
 Unplugging the memory card, 5-3, 5-6

Updating
 Operating system, 4-12
 With booting, 7-19
 Without booting, 7-19
 Updating the operating system, 4-12
 Upkeep, 11-1
 Use
 Conditions, 3-1
 with additional measures, 3-1
 User data
 Exporting/importing, 8-5
 User group
 In Runtime, 8-4
 User view, 9-27
 Export, 9-28
 Import, 9-28
 Layout, 9-28
 Purpose, 9-27
 Users
 In Runtime, 8-4

V

Value, 1-7, 1-9
 Version
 Image, 6-23, 7-18
 Version number, 7-10
 Vibrations
 Reduction of, 12-6
 View
 OP 170B front view, 1-4
 OP 170B side view, 1-5
 OP 170B view from below, 1-5
 TP 170A front view, 1-2
 TP 170A side view, 1-2
 TP 170A view from below, 1-2
 TP 170B front view, 1-3
 TP 170B side view, 1-3
 TP 170B view from below, 1-3
 TP 170micro front view, 1-1
 TP 170micro side view, 1-1
 TP 170micro view from below, 1-1
 Visual feedback, 9-3

W

Windows
 Transfer, 4-17, 4-18
 With booting
 Updating, 7-19
 Without booting
 Updating, 7-19
 Work on the cabinet, 2-1

SIMATIC HMI

Product information on the operating instructions TP 170micro, TP 170A, TP 170B, OP 170B, Edition 03/2004

The product information contains important notes. It supplements chapter 12.5 on the operating instructions TP 170micro, TP 170A, TP 170B, OP 170B, edition 03/2004.

If there are discrepancies, this product information can be considered more up-to-date than the operating instructions, release notes and online help.

The product information is a component of the operating instructions TP 170micro, TP 170A, TP 170B, OP 170B, edition 03/2004.

12.5 Environmental Conditions

Permissible ambient conditions

Environmental Conditions	TP 170micro, TP 170A, TP 170B, OP 170B
Mounting position	Vertical
Max. permissible angle of inclination without external ventilation	±35°
Max. permissible ambient temperature	
Operation	
Vertical installation	0 ... +50 °C
Installation angled from the perpendicular to max. 35°	0 ... +35 °C
Shipping, storage	-20 ... +60 °C
Shock load	
Operation	15 g / 11 ms
Shipping, storage	25 g / 6 ms
Vibration	
Operation	0,075 mm (10 ... 58 Hz); 1 g (58 ... 150 Hz)
Shipping, storage	3,5 mm (5 ... 9 Hz); 1 g (9 ... 500 Hz)
Air pressure	
Operation	1080 ... 795 hPa (corresponds to an altitude of -1000 m to 2000 m)
Shipping, storage	1080 ... 660 hPa (corresponds to an altitude of -1000 m to 3500 m)
Relative atmospheric humidity	
Operation, transport, storage	10 ... 85%, no condensation
Contaminant concentration	SO ₂ : <0,5 ppm RH <60 %, non-condensing H ₂ S: <0,1 ppm RH <60 %, non-condensing