

DE	Koordinatenschalter	ES	Manipulador	TR	Koordinat Şalteri
EN	Coordinate Switch	IT	Interruttore a coordinate	PY	Координатный переключатель
FR	Manipulateur	PT	Comutador de barras cruzadas	中文	坐标开关

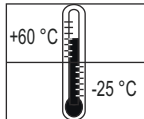

EN 1088 (5.7)



IEC 60947-5-1 / IEC 60947-5-5 / IEC 61508, EN ISO 13849-1

Betriebsanleitung	DE
Operating Instructions	EN
Instructions de service	FR
Instructivo	ES
Istruzioni operative	IT
Instruções de Serviço	PT
İşletme Kılavuzu	TR
Руководство по эксплуатации	PY
使用说明	中文

### Technical Assistance:

Telephone: +49 (911) 895-5900 (8° - 17° CET)

Fax: +49 (911) 895-5907

E-mail: [technical-assistance@siemens.com](mailto:technical-assistance@siemens.com)

Internet: [www.siemens.com/industrial-controls/technical-assistance](http://www.siemens.com/industrial-controls/technical-assistance)

**SIEMENS AG**  
**Technical Assistance**  
**Würzburger Str. 121**  
**D-90766 Fürth**













MLFB		MLFB		MLFB	
3SB1201-7FV01	0 / T / K	3SB1201-7DV01	0 / T / K	3SB1208-7JV01	0 / T / K
3SB1201-7FV20	0 / T / M	3SB1201-7DV20	0 / T / M	3SB1208-7JV20	0 / T / M
3SB1201-7FW01	1 / T / K	3SB1201-7DW01	1 / T / K	3SB1208-7JW01	1 / T / K
3SB1201-7FW20	1 / T / M	3SB1201-7DW20	1 / T / M	3SB1208-7JW20	1 / T / M
3SB1201-7GV01	0 / R / K	3SB1201-7EV01	0 / R / K	3SB1208-7KV01	0 / R / K
3SB1201-7GV20	0 / R / M	3SB1201-7EV20	0 / R / M	3SB1208-7KV20	0 / R / M
3SB1201-7GW01	1 / R / K	3SB1201-7EW01	1 / R / K	3SB1208-7KW01	1 / R / K
3SB1201-7GW20	1 / R / M	3SB1201-7EW20	1 / R / M	3SB1208-7KW20	1 / R / M









	0	1	T	R	K	M
DE	ohne mechanische Verriegelung in der 0-Stellung	mit mechanischer Verriegelung in der 0-Stellung	tastend	verrastend	Kunststoff-Frontring	Metall-Frontring
EN	without mechanical zero interlock	with mechanical zero interlock	momentary contact	latching	plastic front ring	metal front ring
FR	sans accrochage mécanique en position zéro	avec accrochage mécanique en position zéro	sans maintien	avec maintien	colletette plastique	colletette métal
ES	sin enclavamiento mecánico en el cero	con enclavamiento mecánico en el cero	contacto momentáneo	contacto permanente	aro frontal de plástico	aro frontal de metal
IT	senza blocco meccanico nella posizione zero	con blocco meccanico nella posizione zero	ad impulso	permanente	con ghiera in plastica	con ghiera in metallo
PT	sem fecho mecânico na posição neutra	com fecho mecânico na posição neutra	pressionável	encaixável	anel frontal em plástico	anel frontal em metal
TR	Sifir pozisyonda mekanik kilitlemesiz	Sifir pozisyonda mekanik kilitlemeli	Yaylı geri dönüş	Kilitlemeli	Plastik halka	Metal halka
PY	без механического блокирования в нулевом положении	с механическим блокированием в нулевом положении	зондирование	фиксирование	пластмассовое фронтальное кольцо	металлическое фронтальное кольцо
中文	零位上无机械闭锁	零位上有机械闭锁	弹簧复位型	锁定	塑料前置垫圈	金属前置垫圈











[www.siemens.de/industrial-controls/manuals](http://www.siemens.de/industrial-controls/manuals)

3ZX1012-0SB10-2AA1

DE		<b>GEFAHR</b> <b>Gefährliche Spannung. Lebensgefahr oder schwere Verletzungsgefahr.</b> Vor Beginn der Arbeiten Anlage und Gerät spannungsfrei schalten.
EN		<b>DANGER</b> <b>Hazardous voltage. Will cause death or serious injury.</b> Turn off and lock out all power supplying this device before working on this device.
FR		<b>DANGER</b> <b>Tension dangereuse. Danger de mort ou risque de blessures graves.</b> Mettre hors tension avant d'intervenir sur l'appareil.
ES		<b>PELIGRO</b> <b>Tensión peligrosa. Puede causar la muerte o lesiones graves.</b> Desconectar la alimentación eléctrica antes de trabajar en el equipo.
IT	 	<b>PERICOLO</b> <b>Tensione pericolosa. Può provocare morte o lesioni gravi.</b> Scolligare l'alimentazione prima di eseguire interventi sull'apparecchiatura.
PT		<b>PERIGO</b> <b>Tensão perigosa. Perigo de morte ou ferimentos graves.</b> Desligue a alimentação elétrica e proteja contra o religamento, antes de iniciar o trabalho no equipamento.
TR		<b>TEHLİKE</b> <b>Tehlikeli gerilim. Ölüm tehlikesi veya ağır yaralanma tehlikesi.</b> Çalışmalara başlamadan önce, sistemin ve cihazın gerilim beslemesini kapatınız.
PY		<b>ОПАСНО</b> <b>Опасное напряжение. Опасность для жизни или возможность тяжелых травм.</b> Перед началом работ отключить подачу питания к установке и к устройству.
中文		<b>危险</b> <b>危险电压。可能导致生命危险或重伤危险。操作设备时必须确保切断电源。</b>

DE		<b>VORSICHT</b> Eine sichere Gerätefunktion ist nur mit zertifizierten Komponenten gewährleistet.
EN		<b>CAUTION</b> Reliable functioning of the equipment is only ensured with certified components.
FR		<b>PRUDENCE</b> La sécurité de fonctionnement de l'appareil n'est garantie qu'avec des composants certifiés.
ES		<b>PRECAUCIÓN</b> El funcionamiento seguro del aparato sólo está garantizado con componentes certificados.
IT		<b>CAUTELA</b> Il funzionamento sicuro dell'apparecchiatura è garantito soltanto con componenti certificati.
PT		<b>CUIDADO</b> O funcionamento seguro do aparelho apenas pode ser garantido se forem utilizados componentes certificados!
TR		<b>ÖNEMLİ DİKKAT</b> Cihazın güvenli çalışması ancak sertifikalı bileşenler kullanılması halinde garanti edilebilir.
PY		<b>ОСТОРОЖНО</b> Безопасность работы устройства гарантируется только при использовании сертифицированных компонентов.
中文		<b>小心</b> 只有认证的部件才能保证设备可靠发挥作用。

DE		<b>Warnung</b> Für Spannungen über Schutzkleinspannung ist Erdung erforderlich!
EN		<b>Warning</b> Grounding is required for voltages above safety extralow voltage.
FR		<b>Attention</b> Les tensions supérieures à la très basse tension de protection exigent une mise à la terre !
ES		<b>Advertencia</b> ¡Si se usan tensiones superiores al límite de pequeña tensión de protección es obligatorio poner a tierra!
IT		<b>Avvertenza</b> Per tensioni superiori alla tensione ridotta di sicurezza è necessaria la messa a terra!
PT		<b>Advertência</b> Para tensões que excedam a baixa tensão de proteção é necessário fazer aterramento!
TR		<b>Uyarı</b> Koruyucu küçük gerilim üzerinden gerilimler için topraklama gereklidir!
PY		<b>СТОРОЖНО</b> Для напряжений выше защитного заниженного напряжения предохранительного необходимо заземление!
中文		<b>警告</b> 只有认证的部件才能保证设备可靠发挥作用。

DE	<b>Hinweis</b>	Es wird keine Haftung für Schäden oder Verletzungen bei nichtbestimmungsgemäßem Umgang bzw. unsachgemäßem Zerlegen über entsprechend vorgesehenes Öffnen hinaus, übernommen. Jegliche unsachgemäße Handhabung kann schwerwiegende körperliche Verletzungen bewirken.
EN	<b>Note</b>	Siemens is not responsible for damage or injury in the event of improper usage or inappropriate dismantling other than opening in the intended manner. Any improper handling can cause serious physical injury.
FR	<b>Remarque</b>	Nous dégageons toute responsabilité pour les blessures et dommages résultant de la manipulation non conforme à l'usage prévu ou du démontage incorrect allant au-delà de l'ouverture normale prévue. Une manipulation incorrecte peut entraîner des blessures graves.
ES	<b>Nota</b>	No nos responsabilizamos por daños materiales o lesiones en caso de manipulación no conforme o de un despiece antirreglamentario de los paratos y componentes que supere su apertura prevista para las operaciones de montaje y mantenimiento normales. Cualquier manipulación no reglamentada puede provocar lesiones graves.
IT	<b>Avvertenza</b>	Si declina ogni responsabilità per danni o lesioni a seguito di operazioni non conformi alle prescrizioni o di smontaggi impropri, che non rispettano quanto previsto per l'apertura degli apparecchi. Un trattamento inadeguato può essere causa di gravi lesioni personali.
PT	<b>Indicação</b>	Não nos responsabilizamos por danos resultantes do manuseio inadequado, assim como, da desmontagem inadequada que exceda a abertura descrita do dispositivo. Qualquer manuseio inadequado pode provocar ferimentos graves.
TR	<b>Açıklama</b>	Usulüne uygun olmayan kullanımdan ve öngörülen açma işleminin dışına çıkan parçalardan doğacak hasar ve yaralanmalardan sorumluluk kabul edilmez. Her tür usulsüz kullanım, ağır yaralanmalara yol açabilir.
PY	<b>Указание</b>	За нанесенный ущерб и травмирование из-за использования приборов не по назначению или непрофессиональный демонтаж, выходящий за пределы предусмотренного допустимого открывания, мы не несем никакой ответственности. Любое непрофессиональное обращение может привести к тяжелым травмам.
中文	<b>提示</b>	除非按照规定打开，否则我们对没有按照预期使用目的操作以及不正确拆卸时产生的损失和伤害不承担责任。任何不正确的操作都会对身体造成严重的危害。

DE	Bohrbild Befestigungsbohrungen	ES	Esquema de agujeros de fijación	TR	Delik şablonu Montaj delikleri
EN	Drilling pattern of mounting holes	IT	Dima di foratura Fori di fissaggio	PY	Схема сверления крепежных отверстий
FR	Plan de perçage des trous de fixation	PT	Gabarito de furos Orifícios de fixação	中文	固定孔 钻孔图

	E	F		
	a.....b			
0 → C; ...D	75 x 30	89 x 30	---	---
0 → A; ...B	50 x 75	---	50 x 89	---
0 → A; ...B 0 → C; ...D	75 x 75	---	---	89 x 89

	E	F
DE	ohne Schildträger	mit Schildträger
EN	without label support	with label support
FR	sans porte-étiquette	avec porte-étiquette
ES	sin portaplaquita	con portaplaquita
IT	senza portatarghetta	con portatarghetta
PT	sem suporte de placa	com suporte de placa
TR	Levha taşıyıcısız	Levha taşıyıcılı
PY	без основания таблички	с основанием таблички
中文	无铭牌架	带铭牌架

mm

DE	Montage / Demontage	ES	Montaje / Desmontaje	TR	Montaj / Demontaj
EN	Assembly / Disassembly	IT	Montaggio / Smontaggio	PY	Монтаж / Демонтаж
FR	Monteage / Démontage	PT	Montagem / Desmontagem	中文	安装 / 拆卸

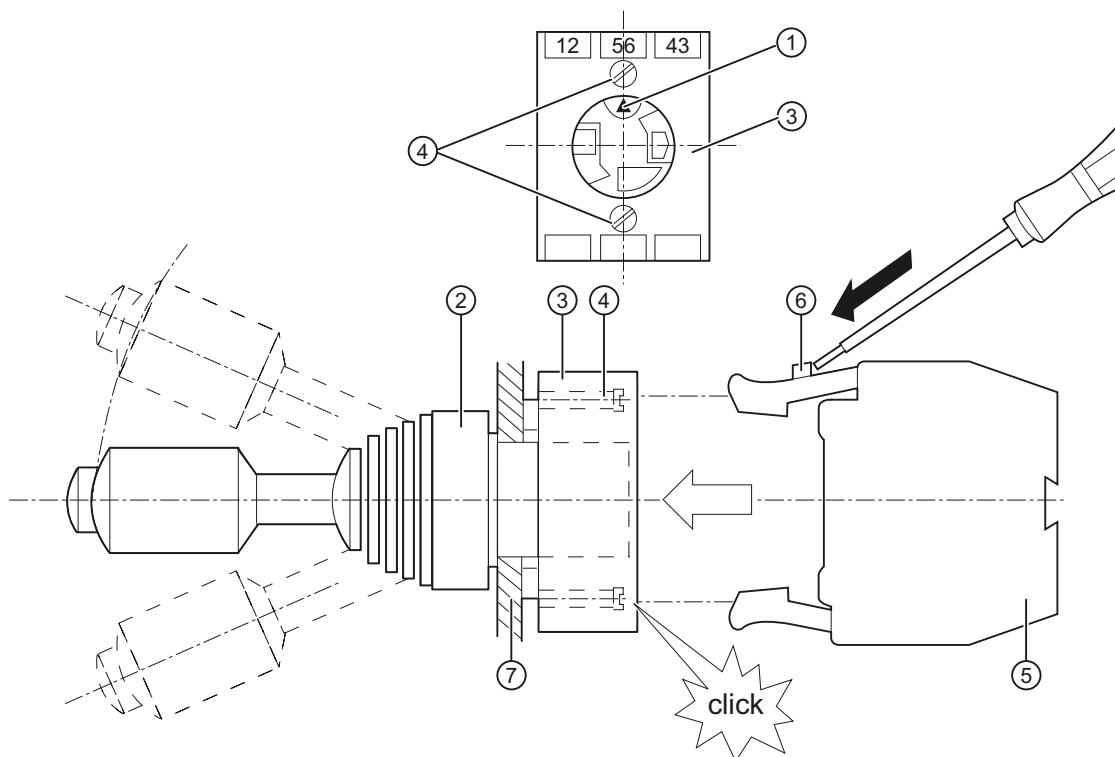



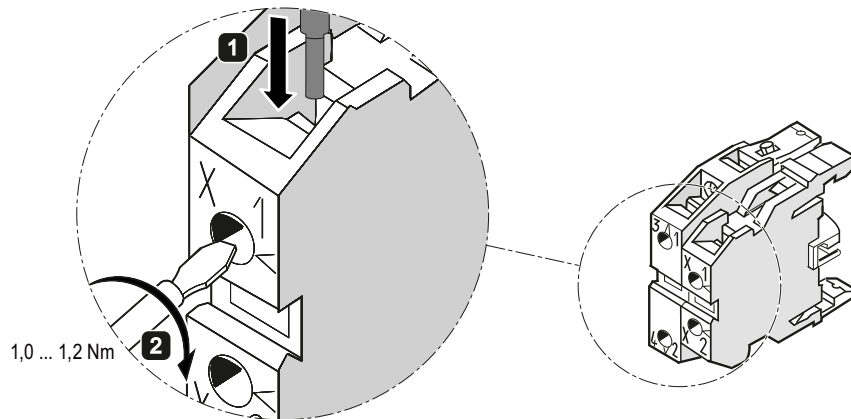

DE	<p>Beim Einbau des Betätigungselementes auf die richtige Stellung des Markierungspfeiles achten, siehe ①.</p> <p>Betätigungselement ② von vorne durch die Einbauöffnung stecken und mit dem Halter ③, dem Träger der Schaltelemente durch eine Rechtsdrehung verriegeln.</p> <p>Von hinten mit zwei Druckschrauben ④ des Halters ③ rüttelfest und verdrehsicher befestigen. dabei beträgt das maximale Drehmoment 0,8 Nm.</p> <p>Schaltelemente ⑤ in Pfeilrichtung auf den Halter ③ aufschnappen.</p> <p>Bei Schalttafelstärken ⑦ &gt; 3 mm, Druckschrauben ④ vor der Montage zurückdrehen.</p> <p>Zum Austausch der Schaltelemente ⑤ Entriegelungselement ⑥ kräftig in Pfeilrichtung drücken, bis es sich zwischen die Schnappbefestigung schiebt und diese entrastet.</p>
EN	<p>When mounting the actuating element, make sure the marking arrow is in the correct position, see ①.</p> <p>Push the actuating element ② through the opening from the front and interlock with the holder ③, the support of the contact blocks, by clockwise rotation.</p> <p>Fix from behind using two clamping bolts ④ of the holder ③ to ensure resistance to vibration and torsion, the maximum tightening torque being 0,8 Nm.</p> <p>Snap the contact blocks ⑤ onto the holder ③ in the direction indicated by the arrow.</p> <p>At panel thicknesses ⑦ &gt; 3 mm, loosen the clamping bolts ④ prior to installation.</p> <p>To replace the contact blocks ⑤, press the unlocking element ⑥ firmly to release the latch in the direction indicated by the arrow.</p>
FR	<p>Lors du montage de la tête de commande, veiller à la bonne orientation de la tête de commande, voir ①.</p> <p>Engager la tête de commande ② de l'avant à travers le trou dans le panneau et la verrouiller sur le support ③, du bloc de contact par une rotation vers la droite.</p> <p>De l'arrière, serrer les 2 vis de pression ④ pour immobiliser le manipulateur ③ en rotation et le fixer contre les secousses. Le couple de serrage de ces vis ne doit pas excéder 0,8 Nm.</p> <p>Encliqueter le bloc de contact ⑤ sur le support ③ dans le sens de la flèche.</p> <p>Pour des panneaux d'épaisseur ⑦ &gt; 3 mm, desserrer un peu les vis de pression ④ avant le montage.</p> <p>Pour déposer le bloc de contact ⑤, appuyer fermement sur l'élément de déverrouillage ⑥ dans le sens de la flèche afin de libérer l'encliquetage.</p>
ES	<p>Al montar la cabeza de mando atender a la posición correcta de la flecha, ver ①.</p> <p>Insertar desde el frente la cabeza de mando ② por la abertura y, girándola en sentido horario, acoplarla al soporte ③, que sostiene el bloque de contactos.</p> <p>Para protección antivibraciones y antigiro, apretar (con un par de 0,8 Nm) desde atrás los dos tornillos ④ del soporte ③.</p> <p>Enclicar, en el sentido de la flecha, el bloque de contactos ⑤ en el soporte ③.</p> <p>En caso de paneles con espesor ⑦ &gt; 3 mm, antes del montaje desatornillar una cierta distancia los tornillo de apriete ④.</p> <p>Para reemplazar los bloques de contactos ⑤, apretar con fuerza el elemento desbloqueador ⑥ en el sentido de la flecha hasta que ceda y libere la fijación por clic.</p>
IT	<p>Prestare attenzione durante il montaggio dell'elemento di comando alla corretta posizione della freccia, vedere ①.</p> <p>Inserire l'elemento di comando ② dal davanti attraverso l'apertura di montaggio e bloccarlo con il supporto ③ del blocchetto di contatti ruotando verso destra.</p> <p>Da dietro serrare con le due viti a pressione ④ del supporto ③, bloccandolo contro vibrazioni e torsioni. La coppia massima è di 0,8 Nm.</p> <p>Agganciare il blocchetto di contatti ⑤ sul supporto ③ in direzione della freccia.</p> <p>Nel caso di pannelli di comando con spessore ⑦ &gt; 3 mm, allentare le viti a pressione ④ prima del montaggio.</p> <p>Per sostituire il blocchetto di contatti ⑤, premere con forza l'elemento di sblocco ⑥ in direzione della freccia, fino a fare sbloccare il meccanismo di fissaggio a scatto.</p>

PT	<p>Na montagem do elemento de operação, certifique-se de que a seta de marcação se encontra na posição correta, ver ①.</p> <p>Encaixar o elemento de operação ② pela frontal, através da abertura de montagem e com o suporte ③, bloquear o portador dos elementos de comutação girando-o para a direita.</p> <p>Fixar a partir de trás com dois parafusos de pressão ④ do suporte ③ para evitar vibrações e rotações. O torque máximo é de 0,8 Nm.</p> <p>Encaixar os elementos de comutação ⑤ no suporte ③, no sentido da seta.</p> <p>Em painéis de distribuição com espessuras ⑦ &gt; 3 mm, desapertar os parafusos de pressão ④ antes da montagem.</p> <p>Para repor os elementos de comutação ⑤, pressionar o elemento de desbloqueio ⑥ com força no sentido da seta, de forma que este deslize entre a fixação de encaixe e desencaixe.</p>
TR	<p>Çalıştırma elemanının montajında işaret okunun doğru pozisyonunda olmasına dikkat edin, bkz. ①.</p> <p>Çalıştırma elemanını ② ön taraftan montaj deliğinin içinden geçirerek yerleştirin ve sağa döndürerek anahtarlama elemanlarını taşıyan tutucu ③ ile kilitleyin.</p> <p>Arka taraftan tutucunun ③ iki baskı civatası ④ ile sarsıntıya dayanıklı ve dönmeyecek şekilde sabitleyin. Burada maksimum tork 0,8 Nm'dir.</p> <p>Anahtarlama elemanlarını ⑤ ok yönünde tutucunun ③ üzerine geçirin.</p> <p>Kalınlığı 3 mm'den büyük olan anahtarlama panellerinde ⑦ montajdan önce baskı civatalarını ④ döndürerek geriye getirin.</p> <p>Anahtarlama elemanlarını ⑤ değiştirmek için kilit açma elemanını ⑥ yaylı sabitlemenin arasına girip sabitlemenin kilidini açınca kadar ok yönünde kuvvetlice bastırın.</p>
py	<p>При монтаже элемента срабатывания следить за правильным положением стрелки, см. ①.</p> <p>Вставить элемент срабатывания ② спереди через монтажное отверстие и заблокировать держателем ③, носителем коммутационных элементов посредством вращения вправо. Сзади виброустойчиво и для предотвращения проворачивания закрепить двумя установочными винтами ④ держателя ③. При этом максимальный момент вращения составляет 0,8 Нм. Коммутационные элементы ⑤ закрепить в направлении стрелки на держателе ③.</p> <p>При толщине коммутационной панели ⑦ &gt; 3 мм перед монтажом установочные винты ④ чуть открутить. Для замены коммутационных элементов ⑤ с усилием нажать разблокировочный элемент ⑥ в направлении стрелки, чтобы он вошел в элемент быстрого крепления и разблокировал его.</p>
中文	<p>安装操作元件时，注意标记箭头的正确位置，参见 ①。</p> <p>通过安装开口从正面插入操作元件 ②，顺时针旋转，与夹具 ③ 和开关元件的支架锁紧。</p> <p>在背面使用夹具 ③ 的两个压紧螺栓 ④ 抗震、抗扭转地固定，最大扭矩 0.8 Nm。</p> <p>按照箭头方向将开关元件 ⑤ 扣接在夹具 ③ 上。</p> <p>配电板 ⑦ 厚度 &gt; 3 mm 时，在安装前旋回压紧螺栓 ④。</p> <p>更换开关元件 ⑤ 时，用力向箭头方向压解锁元件 ⑥，直到其滑向扣接固定装置之间，并卡出。</p>

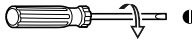
DE	Verdrahtung Schraubklemme	ES	Cableado en bornes de tornillo	TR	Vidalı terminal kablolaması
EN	Wiring of screw terminal	IT	Cablaggio del morsetto a vite	py	Присоединение к винтовому зажиму
FR	Raccordement bornes à vis	PT	Cabeamento terminal de parafuso	中文	螺旋接线夹的布线



	3SB1..0-..
	
	1,0 ... 1,2 Nm
	2 x (1,0 ... 1,5) mm <sup>2</sup>
	0,5 ... 0,75 mm <sup>2</sup>
	—
	2 x (0,50 ... 1,5) mm <sup>2</sup>
<b>AWG</b>	18 to 14

DE	Schaltwegdiagramme	ES	Diagramas carrera-posición de contactos	TR	Anahtarlama yolu diyagramları
EN	Operating travel diagrams	IT	Diagramma corsa di commutazione	PY	Диаграммы хода контактов
FR	Chronogramme	PT	Diagrama do percurso de comutação	中文	换向行程图

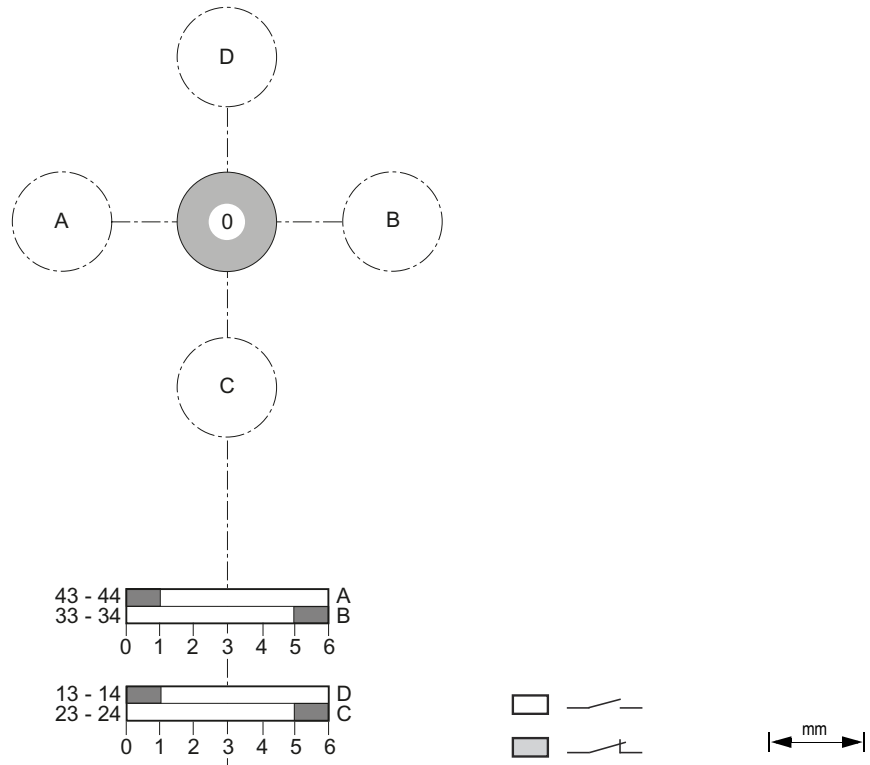

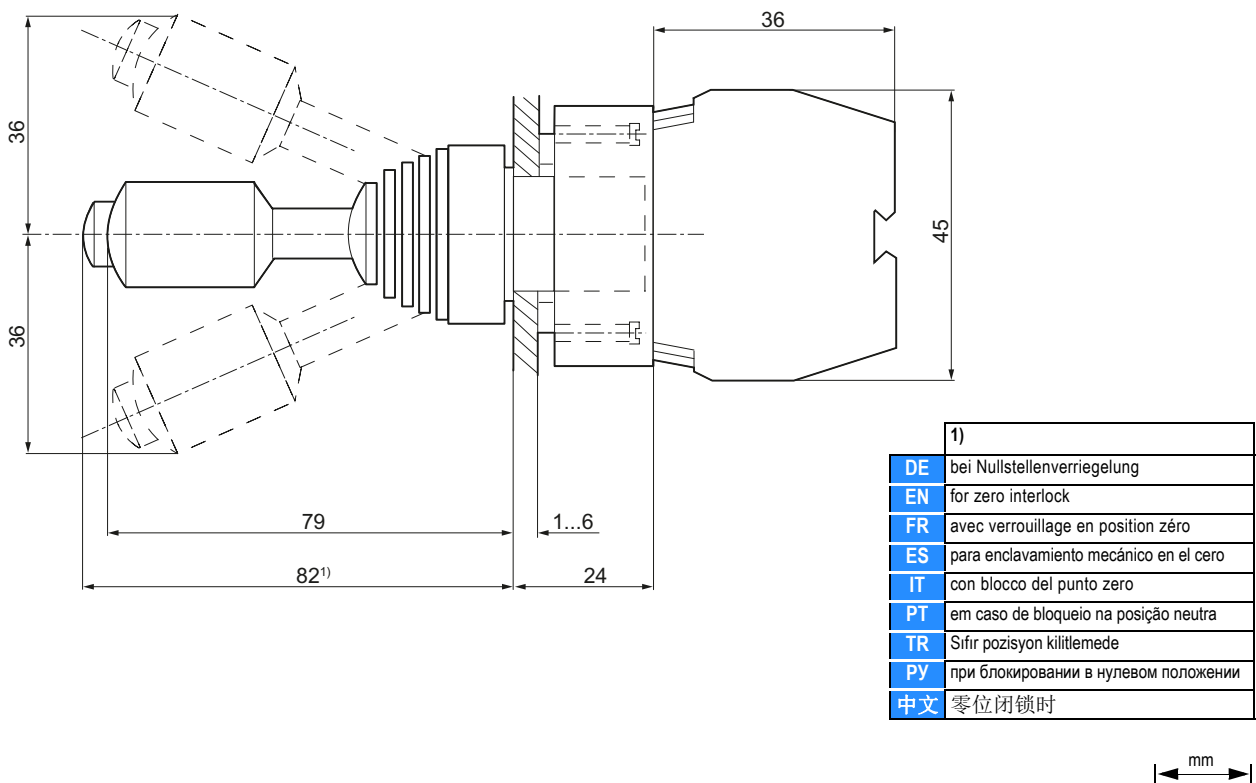

DE	Maßzeichnungen	ES	Dibujos dimensionales	TR	Ölçü çizimleri
EN	Dimension drawings	IT	Disegni quotati	PY	Чертежи с размерами
FR	Dessins cotés	PT	Esquemas dimensionais	中文	比例图

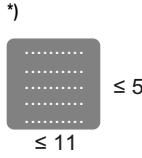
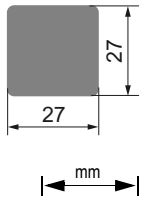
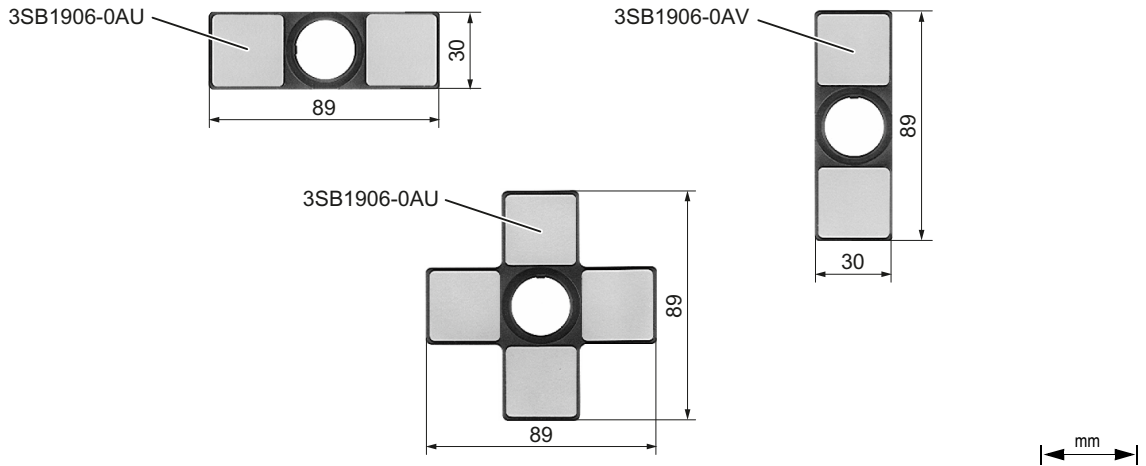



MLFB	3SB1906-2AA	3SB1906-2XZ K0Y	3SB1906-2XZ K1Y	3SB1906-2XZ K2Y	3SB1906-2XZ K3Y	3SB1906-2XZ K4Y
DE	ohne Beschriftung	mit Beschriftung Groß- / Kleinschreibweise	mit Beschriftung Großschreibweise	mit Beschriftung Kleinschreibweise	mit Beschriftung Bildzeichen	mit Beschriftung gemäß BZ-Anlage *)
EN	without inscription	with inscription in upper/lower case	with inscription in upper case	with inscription in lower case	with inscription graphical symbols	with inscription as per order form *)
FR	sans marquage	avec marquage majuscules / minuscules	avec marquage majuscules	avec marquage minuscules	avec marquage symboles	avec marquage selon pièce jointe lors de la commande *)
ES	sin inscripción	con inscripción mayúsculas/ minúsculas	con inscripción mayúsculas	con inscripción minúsculas	con inscripción símbolo gráfico	con inscripción especificada en el anexo al pedido *)
IT	senza scritta	con scritta in maiuscolo/ minuscolo	con scritta in maiuscolo	con scritta in minuscolo	con scritta simboli grafici	con scritta secondo modulo di ordinazione *)
PT	sem inscrição	com inscrição escrita em letra maiúscula/ minúscula	com inscrição escrita em letra maiúscula	com inscrição escrita em letra minúscula	com inscrição figura	com inscrição de acordo com o equipamento BZ *)
TR	Yazısız	Yazılı Büyük harf/Küçük harf	Yazılı Büyük harf	Yazılı Küçük harf	Yazılı Sembol	Yazılı Sembol eki uyarınca *)
PY	без надписи	с надписью прописные/ строчные	с надписью прописные	с надписью строчные	с надписью символы на рисунке	с надписью согласно приложе- нию BZ *)
中文	无文字说明	带文字说明 大 / 小写	带文字说明 大写	带文字说明 小写	带文字说明 图标	带文字说明 符合 BZ 设备 *)

DE	Technische Daten	ES	Datos técnicos	TR	Teknik verileri
EN	Technical data	IT	Dati tecnici	PY	Технические данные
FR	Caractéristiques techniques	PT	Dados técnicos	中文	技术参数

		3SB12...-7....	
			
$U_i$	V	660	
$I_{th}$	A	10	
$I_e @ U_e$ , AC-15			
• @ $U_e = 24\text{ V}$	A	6	
• @ $U_e = 125\text{ V}$	A	6	
• @ $U_e = 230\text{ V}$	A	6	
• @ $U_e = 400\text{ V}$	A	4	
• @ $U_e = 500\text{ V}$	A	2,5	
• @ $U_e = 600\text{ V}$	A	1,2	
$I_e @ U_e$ , DC-12			
• @ $U_e = 24\text{ V}$	A	10	
• @ $U_e = 110\text{ V}$	A	2	
• @ $U_e = 230\text{ V}$	A	0,5	
$I_e @ U_e$ , DC-13			
• @ $U_e = 24\text{ V}$	A	5	
• @ $U_e = 110\text{ V}$	A	0,5	
• @ $U_e = 230\text{ V}$	A	0,2	
 (IEC 60947-5-1)			
• DIAZED, gG, IEC 60269-3-1	A	TDz 10	
• DIAZED, ff, DIN VDE 0635	A	Dz 16	
• IEC 60898	A	1000	