

SIEMENS

SIMATIC

Industrial PC SIMATIC Panel PC 677B

Operating Instructions

<u>Preface</u>	1
<u>Safety</u>	2
<u>Description</u>	3
<u>Application planning</u>	4
<u>Mounting</u>	5
<u>Connecting</u>	6
<u>Integration into an automation system</u>	7
<u>Commissioning</u>	8
<u>Operation and configuration</u>	9
<u>Operation</u>	10
<u>Functions</u>	11
<u>Maintenance and service</u>	12
<u>Alarm, error, and system messages</u>	13
<u>Troubleshooting/FAQs</u>	14
<u>Specifications</u>	15
<u>Dimensional drawings</u>	16
<u>Detailed descriptions</u>	17
<u>Appendix</u>	A
<u>List of Abbreviations/Acronyms</u>	B

Safety Guidelines

This manual contains notices you have to observe in order to ensure your personal safety, as well as to prevent damage to property. The notices referring to your personal safety are highlighted in the manual by a safety alert symbol, notices referring only to property damage have no safety alert symbol. These notices shown below are graded according to the degree of danger.

⚠ DANGER
indicates that death or severe personal injury will result if proper precautions are not taken.
⚠ WARNING
indicates that death or severe personal injury may result if proper precautions are not taken.
⚠ CAUTION
with a safety alert symbol, indicates that minor personal injury can result if proper precautions are not taken.
CAUTION
without a safety alert symbol, indicates that property damage can result if proper precautions are not taken.
NOTICE
indicates that an unintended result or situation can occur if the corresponding information is not taken into account.

If more than one degree of danger is present, the warning notice representing the highest degree of danger will be used. A notice warning of injury to persons with a safety alert symbol may also include a warning relating to property damage.

Qualified Personnel

The device/system may only be set up and used in conjunction with this documentation. Commissioning and operation of a device/system may only be performed by **qualified personnel**. Within the context of the safety notes in this documentation qualified persons are defined as persons who are authorized to commission, ground and label devices, systems and circuits in accordance with established safety practices and standards.

Prescribed Usage

Note the following:

⚠ WARNING
This device may only be used for the applications described in the catalog or the technical description and only in connection with devices or components from other manufacturers which have been approved or recommended by Siemens. Correct, reliable operation of the product requires proper transport, storage, positioning and assembly as well as careful operation and maintenance.

Trademarks

All names identified by ® are registered trademarks of the Siemens AG. The remaining trademarks in this publication may be trademarks whose use by third parties for their own purposes could violate the rights of the owner.

Disclaimer of Liability

We have reviewed the contents of this publication to ensure consistency with the hardware and software described. Since variance cannot be precluded entirely, we cannot guarantee full consistency. However, the information in this publication is reviewed regularly and any necessary corrections are included in subsequent editions.

(A)

가

Table of contents

1	Preface	9
2	Safety	11
2.1	Safety guidelines	11
2.2	General Information	13
2.3	ESD directives	16
3	Description	19
3.1	Panel PC 677B design	19
3.2	Features	21
3.3	Panel PC 677B accessories	23
4	Application planning	25
4.1	Overview	25
4.2	Unpacking and checking the delivery	26
4.3	Device identification data	27
4.4	Mounting positions and fastening	28
4.4.1	Installation guidelines	28
4.4.2	Installation information stainless steel front	29
4.4.3	Permitted mounting positions	30
4.4.4	Type of fixation	30
4.4.5	Stainless steel front type of fixation	31
4.4.6	Protection against dust and water	31
4.5	Mounting cut-out	33
4.5.1	Preparing the mounting cut-out	33
4.5.2	Mounting depth of the device	35
4.6	EMC Guideline	36
5	Mounting	37
5.1	Securing the device with clamps	37
5.2	Securing with screws	38
5.3	Fix the device with stainless steel front using clamps	40
6	Connecting	43
6.1	Connection elements and operator controls	43
6.2	Connecting the 120 V / 240 V Ac power supply	45
6.3	Connecting the (24 V) DC power supply	48
6.4	Connecting the Equipotential Bonding Circuit	49
6.5	Equipotential bonding with stainless steel front	49

6.6	Connecting Ethernet strain relief.....	50
6.7	Connecting the power plug locking mechanism.....	50
7	Integration into an automation system	51
7.1	Overview	51
7.2	Device in SIMATIC S7 network.....	52
7.2.1	MPI/PROFIBUS-DP network.....	52
7.2.2	Connecting an S7 automation system	53
7.3	Transferring authorizations	54
7.4	Networking via Industrial Ethernet	54
7.5	PROFINET	55
8	Commissioning.....	57
8.1	Overview	57
8.2	Switching on the device	58
8.3	Windows XP, Vista Security Center.....	58
8.4	Setting up the Microsoft Windows operating system	59
8.5	Additional applications	59
8.5.1	Touch Panel set-up	61
8.5.2	Key Panel adjustment	63
8.5.3	RAID1 system (optional)	64
8.5.3.1	Replacing a defective drive in the RAID system.....	66
8.6	BIOS settings	70
8.7	USB.....	71
9	Operation and configuration.....	73
9.1	Normal operation.....	73
9.1.1	Switching on the device	73
9.1.2	Logging on to the operating system using the on-screen keyboard	74
9.1.3	Switching off the device	75
9.2	Additional drivers and applications	75
9.2.1	Touch screen calibration.....	76
9.2.2	Activate touch functionality.....	77
9.2.3	Deactivate touch functionality	77
9.2.4	Windows Security Center (Windows XP Professional / Windows XP Embedded).....	78
9.2.5	KeyTools (for key panel devices).....	80
9.2.6	On-screen keyboard (for touch panel device).....	81
9.2.7	Panel PC Tools	81
9.2.8	CheckLanguageID	83
9.2.9	Multilingual settings for the operating system	84
9.2.10	DVD burner	85
9.2.11	USB keyboard controller	85
10	Operation.....	87
10.1	Status indicators.....	87
10.2	General control elements.....	89
10.3	Device with key panel	90
10.3.1	Safety	90

10.3.2	Overview	91
10.3.3	Keys	92
10.3.3.1	Control keys	92
10.3.3.2	Alphanumeric and numeric keys.....	93
10.3.3.3	Cursor keys	94
10.3.4	External keyboards	94
10.3.5	Using the direct control key module.....	95
10.3.6	Labelling function keys and softkeys	97
10.3.7	Using the integrated mouse	99
10.4	Device with touch panel	99
10.4.1	Operating a touch panel.....	100
11	Functions.....	101
11.1	Overview	101
11.2	Safecard on Motherboard (SOM).....	101
11.3	Temperature monitoring.....	103
11.4	Watchdog (WD).....	103
11.5	Fan monitoring	104
12	Maintenance and service.....	105
12.1	Maintenance.....	105
12.2	Maintenance and care of devices with stainless steel front.....	106
12.3	Chemical resistance of stainless steel fronts	108
12.4	Handling of stainless steel surfaces	109
12.5	Spare parts.....	110
12.6	Separating the control unit from the computer unit.....	111
12.7	Removing and installing hardware components	114
12.7.1	Repairs	114
12.7.2	Opening the Device	115
12.7.3	Removing/Installing Memory Module.....	117
12.7.4	Installing PCI / PCI express cards	120
12.7.4.1	Notes on the modules	120
12.7.4.2	Installing / removing expansion modules.....	120
12.7.5	Installing drives	122
12.7.5.1	Options of installing disk drives.....	122
12.7.5.2	Installing/removing a drive bay module	124
12.7.5.3	Removing / installing an optical drive	125
12.7.5.4	Installing / removing hard disks.....	126
12.7.6	Installing/removing an on-board Compact Flash card	127
12.7.7	Installing/removing an additional Compact Flash card	130
12.7.8	Replacing the Backup Battery.....	133
12.7.9	Removing/Installing the Power Supply	135
12.7.10	Installing / removing the bus board	137
12.7.11	Installing / removing the motherboard	138
12.7.12	Installing / removing the equipment fan	140
12.7.13	Installing / removing the power supply fan.....	141
12.7.14	Installing / removing the processor	143
12.8	Reinstalling the operating system	147
12.8.1	Windows XP Embedded	147

12.8.1.1	General installation procedure	147
12.8.1.2	Restoring the software to factory state using the Restore DVD	147
12.8.2	Windows XP Professional / Windows 2000 Professional	148
12.8.2.1	General installation procedure	148
12.8.2.2	Restoring the Software to Factory State Using the Restore DVD	149
12.8.2.3	Setting up the operating system via the Recovery DVD	150
12.8.3	Recovery of Windows Vista	154
12.9	Partitioning the hard disk.....	157
12.9.1	Setting up the partitions under Windows XP Embedded	157
12.9.2	Setting up partitions under Windows XP Professional / Windows 2000 MUI	157
12.10	Installing drivers and software	158
12.10.1	Installing drivers and software	158
12.10.2	Driver installation under Windows XP Embedded	158
12.11	Installing the RAID Controller software	159
12.12	Installing the burner software	159
12.13	Installing updates	159
12.13.1	Updating the operating system	159
12.13.2	Installing or updating application programs and drivers	160
12.14	Data backup	160
12.14.1	Creating an image.....	160
12.15	CP 1616 onboard	160
13	Alarm, error, and system messages	161
13.1	Boot error messages.....	161
13.2	Introduction to the BIOS beep codes	163
13.3	BIOS beep codes	164
14	Troubleshooting/FAQs.....	167
14.1	General problems.....	167
14.2	Problems when Using Modules of Third-party Manufacturers.....	168
14.3	Temperature limits	169
15	Specifications	171
15.1	General specifications.....	171
15.2	Technical data for device with stainless steel front.....	177
15.3	Power requirements of the components	178
15.4	Device with AC voltage supply.....	179
15.5	Device with DC voltage supply	180
15.6	Keyboard table	181
16	Dimensional drawings.....	189
16.1	Dimensional drawings Panel PC 677B	189
16.2	Dimensional drawings for the installation of expansion modules	191
17	Detailed descriptions	193
17.1	Motherboard.....	193

17.1.1	Structure and functions of the motherboard	193
17.1.2	Technical features of the motherboard	194
17.1.3	Position of the interfaces on the motherboard	195
17.1.4	External ports	196
17.1.5	Front ports	202
17.1.6	Internal interfaces	206
17.2	Bus board	210
17.2.1	Layout and principle of operation	210
17.2.2	PCI slot pin assignment	211
17.2.3	Pin assignment 12 V power supply connection for WinAC module	212
17.2.4	PCI Express slot x4 pin assignment	213
17.3	System resources	214
17.3.1	Currently allocated system resources	214
17.3.2	System resources used by the BIOS/DOS	214
17.3.2.1	I/O address allocation	214
17.3.2.2	Interrupt Assignments	216
17.3.2.3	Exclusive PCI hardware interrupt	219
17.3.2.4	Memory address assignments	219
17.4	BIOS Setup	220
17.4.1	Overview	220
17.4.2	Starting BIOS Setup	221
17.4.3	BIOS Setup menus	222
17.4.4	Main menu	223
17.4.5	Advanced menu	234
17.4.6	Security menu	239
17.4.7	Boot Menu	240
17.4.8	Version Menu	241
17.4.9	Exit menu	242
17.4.10	BIOS Setup default settings	243
17.5	CP 1616 onboard communications processor	246
17.5.1	Introduction	246
17.5.1.1	Network connections	246
17.5.1.2	Typical Communication Partners	247
17.5.2	Firmware loader	249
17.5.2.1	Loading firmware	250
17.5.3	Further actions in STEP 7/NCM PC	251
A	Appendix	253
A.1	Certificates and guidelines	253
A.1.1	Guidelines and declarations	253
A.1.2	Certificates and approvals	255
A.1.3	Service and support	257
B	List of Abbreviations/Acronyms	259
B.1	Abbreviations	259
	Glossary	263
	Index	269

Preface

Purpose of this manual

These operating instructions contain all the information you need for commissioning and using the SIMATIC Panel PC 677B.

It is intended both for programming and testing personnel who commission the device and connect it with other units (automation systems, programming devices), as well as for service and maintenance personnel who install add-ons or carry out fault/error analyses.

Basic knowledge required

A solid background in personal computers and Microsoft operating systems is required to understand this manual. General knowledge in the field of automation control engineering is recommended.

Scope of this manual

This manual applies to devices with order numbers 6AV780....

Approvals

For more information, please refer to the chapter "Certificates and Guidelines" in the appendix.

CE marking

For more information, please refer to "Directives and Declarations" in the "Certificates and Guidelines" section of the appendix.

Standards

Please refer to sections "Application planning" and "Technical data".

Position in the information landscape

The documentation for the Panel PC includes the following sections:

- SIMATIC Panel PC 677B, Operating Instructions (compact) with the following information:
 - Commissioning
 - Legal information
- SIMATIC Panel PC 677B, Operating Instructions

The documentation is supplied with the Panel PC in electronic form as a PDF file on the "Documentation and Drivers" CD. The documentation is available in German, English, French, Italian, Spanish, and Chinese.

Conventions

Representation	Validity
"File"	<ul style="list-style-type: none"> • Terminology that appears in the user interface, for example menu commands, tabs, buttons • Required input, for example limit values, tag values • Path information
"File > Edit"	Operational sequences, for example, menu commands, shortcut menu commands
<F1>, <Shift>+<F1>	Keys and key combinations

The term "Panel PC 677B", "control unit" and "computer unit" is uniformly referred to as the "device" in these operating instructions. The full term is only used when a concrete reference is necessary.

Furthermore, the "CP 1616 onboard" is referred to as "CP" and "Windows Vista Ultimate" is referred to as "Vista".

Note

A note is important information about the product, handling the product or a reference to specific sections of the documentation that require special consideration.

Trademarks

All names labeled with ® symbol are registered trademarks of Siemens AG. Other names used in this documentation may be trademarks, the use of which by third parties for their own purposes could violate the rights of the owner.

HMI®
SIMATIC®
SIMATIC HMI®
SIMATIC WinCC®
SIMATIC WinCC flexible®
Panel PC 677B®

2.1 Safety guidelines

 WARNING
Emergencies In the event of a device fault, interrupt the power supply immediately. Inform the customer service personnel responsible. Malfunctions can occur when the operator controls or power cable are damaged or when liquids or foreign objects penetrate the device.

 WARNING
Following the results of a risk analysis, additional protection equipment on the machine or the system is necessary to avoid endangering persons. With this, especially the programming, configuration and wiring of the inserted I/O modules have to be executed, in accordance with the safety performance (SIL, PL or Cat.) identified by the necessary risk analysis. The intended use of the device has to be ensured. The proper use of the device has to be verified with a function test on the system. This test can detect programming, configuration and wiring errors. The test results have to be documented and, if necessary, entered into the relevant documents that verify safety.

Note

This device corresponds to the regulations of the EU low-voltage directive and the GPSG, verified by conformity with national and international standards (DIN EN, IEC) by a UL approval (cULuc). Please comply with all the information in these operating instructions when assembling the device.

Electrical connection

 WARNING
Disconnect the device from the mains before every intervention. Do not touch power lines or data transmission lines during electrical storms and do not connect any cables.

System expansions

Only install system expansion devices designed for this device. If you install other expansions, you may damage the system or violate the safety requirements and regulations for radio frequency interference suppression. Contact your technical support team or where you purchased your PC to find out which system expansion devices may safely be installed.

CAUTION
If you install or exchange system expansions and damage your device, the warranty becomes void.

High frequency radiation

CAUTION
Unintentional operating situations High frequency radiation, from cell phones for example, can cause unintentional operating situations under some circumstances. Further information is available in the section "EMC requirements" of the "Technical data" chapter.

Handling and disposal of lithium batteries

 WARNING
Danger of explosion and the release of harmful substances! Do not throw lithium batteries into fire, do not solder onto the cell body, do not open, do not short circuit, do not reverse pole, do not heat above 100 °C, dispose of according to regulations, and protect from direct sunlight, moisture and condensation. Replace lithium batteries with the same brand or a brand recommended by the manufacturer. Dispose of used lithium batteries as hazardous waste, individually, in accordance with the local regulations.

Repairs

Only authorized personnel are permitted to repair the device.

 WARNING
Unauthorized opening of and improper repairs to the device may result in substantial damage to equipment or risk of personal injury to the user.

2.2 General Information

Overview

CAUTION

The device must only be operated in closed rooms. Failure to comply nullifies the warranty

Operate the device only in accordance with the ambient conditions specified in the technical specifications. Protect the device against dust, moisture and heat. Do not place the device in direct sunlight.

Transport

Unpack the device at its installation location. Transport the device only in the original packaging. Do not transport the device when it is mounted.

NOTICE

Adhere to these stipulations each time the device is transported, otherwise the guarantee is void.

CAUTION**Condensation**

When transporting the device at low temperatures, ensure that no moisture gets on or into the device. This also applies if the device is subjected to extreme changes in temperature.

Commissioning

Allow the device to slowly adjust to room temperature before commissioning the device. Do not place the device near heat radiation. If moisture condensation occurs, wait at least 12 hours before you switch on the device.

Vibration

Optical drives are sensitive to vibration. Inadmissible vibration during operation may result in loss of data or damage to the drive or data medium.

Before transporting the device, wait at least 20 seconds to allow the drive to stop completely.

Tools & downloads

Please check regularly if updates and hotfixes are available for download to your device.

Downloads are available on the Internet at <http://www.siemens.com/asis> under "Support".

Click "Overview of Panel PCs" under "Tools & Downloads". Using the global search function, you can then also search for any downloads you require.

Optical drive

NOTICE
An optical drive should only be operated in a mechanically undisturbed environment without vibrations and shock.

Safety-relevant applications

 WARNING
Maloperation Do not perform safety-relevant functions of the user software with the touch screen.

Resistance to chemicals

CAUTION
Adhere to the information regarding chemical resistance of the panel front. You can find information on the Internet under "Tools & Downloads > Downloads > Product > Support > Industrial PC": http://www.siemens.com/asis Enter the article ID 22591016 as the search term. The available articles are displayed.

Sources of light

NOTICE
Position the screen so that it is not subject to direct sunlight or other strong sources of light.

Defective pixels in the display

At present, the manufacturing process of modern displays does not guarantee that all pixels of the display will be perfect. A small number of defective pixels in the display is therefore unavoidable. This does not present a functional problem as long as the defective pixels are not bunched in one location.

Further information is available in the section "General technical data" of the "Technical data" chapter.

Burn-in effect on TFT displays

A permanent picture with bright images can lead to a burn-in effect on the TFT LCD.

If a screen saver is activated, please observe the following:

- The liquid crystals in screen savers which actuate active black when the backlighting is on, e.g. flying stars "starfield simulation," renew themselves. Pay attention to the length of time the backlighting is activated
- The following applies to screen savers that turn off the backlighting: Each time the backlighting is turned on, its life is reduced by 50 minutes.

Consider the following carefully:

- Screen saver
- Switch off the backlighting regularly
- Permanent display of the customer application

2.3 ESD directives

What does ESD mean?

Almost all electronic modules are equipped with highly integrated components and elements in MOS technology. For technological reasons, these electronic components are very sensitive to overvoltages and, consequently, to electrostatic discharge. These components are therefore marked as follows:

- **ESD: Electrostatically Sensitive Devices**
- **ESD:** Internationally recognized marking for components and modules susceptible to electrostatic discharge

The following symbols on switch cabinets, module carriers or packaging indicate their susceptibility to electrostatic discharge:



ESD components are destroyed by voltage and energy far below the limits of human perception. Voltages of this kind occur as soon as a device or an assembly is touched by a person who is not electrostatically discharged. ESD components which were subject to such voltage are usually not recognized immediately as being defective, because the malfunction does not occur until after a longer period of operation.

Note

More information is located on the rating label. The rating label is described in the chapter "Planning use."

Precautions against electrostatic discharge

Most plastics can be charged easily. Therefore, keep plastics away from ESD components!

When working with electrostatically sensitive components, make sure that the person, the workstation and the packaging are properly grounded. Conduct the electrostatic charge away from your body by touching the mounting plate for the interfaces, for example.

Handling ESD modules

As a rule: Only touch ESD components if unavoidable due to necessary tasks.

Only touch the components when the following holds true:

- You are permanently grounded by means of an ESD armband.
- You are wearing ESD shoes or ESD shoes grounding protective strips in connection with ESD floors.

Before you touch an electronic assembly, your body must be discharged. Touch a conductive object immediately beforehand, e.g. a bare metal part of a switch cabinet or the water pipe.

Do not allow chargeable, highly insulated materials, e.g. plastic films, insulating tabletops, synthetic clothing fibers, to come into contact with ESD components.

Place ESD components only on conductive surfaces (work surfaces with ESD surface, conductive ESD foam, ESD packing bag, ESD transport container).

Do not expose ESD components to visual display units, monitors or televisions. Maintain a distance of at least 10 cm to screens.

Handle flat components only by their edges. Do not touch component connectors or conductors. This prevents charges from reaching and damaging sensitive components.

Measuring and modifying ESD components

Measure the ESD component under the following conditions only:

- The measuring device is grounded with a protective conductor, for example.
- The probe on the potential-free measuring device has been discharged, e.g. by touching the bare metal of a part of the switch cabinet.
- Your body is discharged. To do so, touch a grounded metallic object.

Solder only with grounded soldering irons.

Shipping ESD modules

Always store or ship ESD components in conductive packaging, e.g. metallized plastic boxes or metal cans. Leave the components and parts in their packaging until installation.

If the packaging is not conductive, wrap the ESD component in a conductive material, e.g. rubber foam, ESD bag, household aluminum foil, or paper, before packing. Do not wrap the ESD component in plastic bags or plastic film.

In ESD components containing installed batteries, make sure that the conductive packaging does not touch the battery connectors or short circuit. Insulate the connectors with suitable material.

Description

3.1 Panel PC 677B design

Design

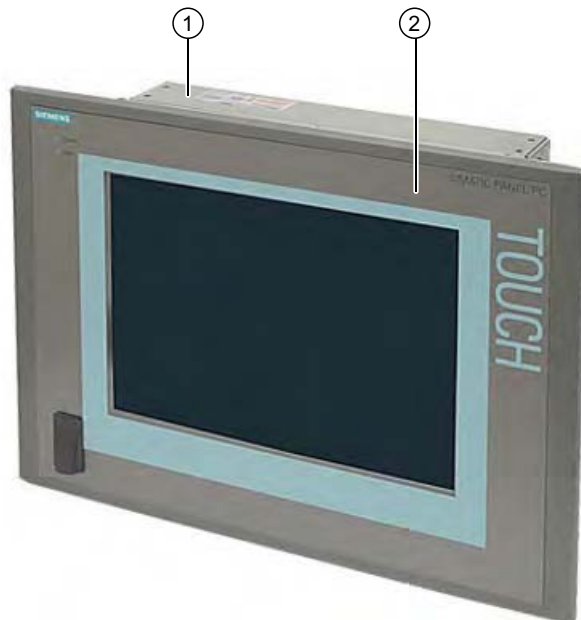

Figure 3-1 PPC 677B

- (1) Computer unit
- (2) Control unit

Product Brief

The device is available with different control units which are distinguished by the size of the display and by the key or touch panel.

Key panel variants

- Color display with backlighting:
 - 12" TFT technology with 800 x 600 resolution
 - 15" TFT technology with 1024 x 768 resolution
- Membrane keyboard with alphanumeric keys, numeric keys, cursor keys and control keys
- Function keys and softkeys
- Integrated mouse
- LEDs for power supply, temperature, softkeys, <Shift> and <ACK> function keys and buttons
- Front-mounted USB 2.0 interface for connecting external I/O devices. All fronts are also available without USB interfaces accessible from the front

Key panel variants

- Color display with backlighting
 - 12" TFT technology; 800 x 600 resolution
 - 15" TFT technology; 1024 x 768 resolution
 - 17" TFT technology; 1280 x 1024 resolution
 - 19" TFT technology; 1280 x 1024 resolution
- LEDs for power supply and temperature
- Front-mounted USB 2.0 interface for connecting external I/O devices. All fronts are also available without USB interfaces accessible from the front

Refer to the "Specifications" section for more information.

3.2 Features

Basic data	
Design	Panel mounting device, computer unit
Processor	<ul style="list-style-type: none"> Intel © Celeron M 440 1.86 GHz 533 MHz Front Side Bus (FSB), 1024 KB Second Level Cache Intel © Core 2 Duo 1.66 GHz T5500 667 MHz Front Side Bus 2048 KB Second Level Cache Intel © Core 2 Duo 2.16 GHz T7400 667 MHz Front Side Bus, 4096 KB Second Level Cache
RAM	<ul style="list-style-type: none"> 512 MB SDRAM (DDR2) Expandable up to 4 GB SDRAM (DDR2)
Slots for add-ons	<ul style="list-style-type: none"> 1x PCI 265 mm long and 1x PCI 175 mm long 1x PCI 265 mm long and 1x PCI Express x4 175 mm long
Graphics	<ul style="list-style-type: none"> Graphics memory 8 to 128 MB SDRAM, partially using dynamic sharing of system RAM VGA: 1600 x 1200 / 32-bit color depth / 85 Hz DVI-I: 1600 x 1200 / 32-bit color depth / 60 Hz
Power supply	<ul style="list-style-type: none"> 120 V / 230 V AC, 190 W; varying voltage 24 V DC, 210 W <p>Both with bridging of transient loss of voltage according to NAMUR: Max. 20 ms at 0.85 rated voltage</p>
Drives and storage media	
Hard disk drives	<ul style="list-style-type: none"> 1 x 3.5" hard disk 2 x 2.5" hard disk or RAID1 system Capacity see order forms
DVD drive	DVD burner
Flash drive	Slot for Compact Flash card
Interfaces	
Ethernet	2x 10/100/1000 Mbps (RJ45)
PROFIBUS/MPI	12 Mbps (isolated potential, compatible to CP 5611), optional
PROFINET	10/100 Mbps (CP 1616 onboard), three RJ45s; optional
USB	<ul style="list-style-type: none"> External: 4 x USB 2.0 on the interface side (max. 2 can be simultaneously operated as high current) Front panel interfaces: USB 2.0 high current
COM	Serial V.24 interface
Monitor	1x DVI-I (VGA monitors can be operated with a DVI/VGA adapter)

Monitoring and safety functions	
Temperature	<ul style="list-style-type: none"> • When permitted temperature range is exceeded • Warning messages from application program that can be analyzed: local, via LAN (DiagMonitor, optionally available)
Fans	<ul style="list-style-type: none"> • Failure of device and power supply fans • Warning messages from application program that can be analyzed: local, via LAN (DiagMonitor, optionally available)
Watchdog	<ul style="list-style-type: none"> • Monitoring function for program execution • Restart can be parameterized in the event of a fault • Warning messages from application program that can be analyzed: local, via LAN (DiagMonitor, optionally available)
Transient voltage interruption	Up to 20 ms buffer time with full load
Buffer memory	Battery-buffered SRAM

Optional accessories	
Book mounting bracket	For space optimizing installation in switch cabinet

Optional expansions	
SIMATIC PC DiagMonitor software ≥ V 3.1	Software tool for monitoring local and remote SIMATIC PCs: <ul style="list-style-type: none"> • Watchdog • Temperature • Fan speed • Hard disk monitoring (SMART) Communication: <ul style="list-style-type: none"> • Ethernet interface (SNMP protocol) • OPC for integration in SIMATIC software • Client server architecture • Layout of log files
SIMATIC PC Image Creator software	Software tool for saving data locally
PCI Multi-I/O module	Provides one parallel and one serial interface

Software	
Operating systems	<ul style="list-style-type: none"> • Without • Preinstalled / supplied on Restore DVD: <ul style="list-style-type: none"> – Windows 2000 Professional SP4 MUI – Windows XP Professional SP2 MUI – Windows XP embedded SP2 English on Compact Flash – Windows Vista Ultimate

3.3 Panel PC 677B accessories

Accessories	Comment	Order No.
Direct control key module		6AV7671-7DA00-0AA0
Foil for protecting the touch panel against dirt and scratches for the 12" touch panel variant for the 15" touch panel variant for the 17" touch panel variant for the 19" touch panel variant		6AV7671-2BA00-0AA0 6AV7671-4BA00-0AA0 6AV7672-1CF00-0AA0 6AV7672-1CE00-0AA0
Film for labeling the function keys (slide-in labels)	You can find print templates for the slide-in labels are available on the "Documentation and Drivers" CD.	6AV7672-0DA00-0AA0
DVI / VGA adapter		6ES7648-3AB00-0XA0
Backing plate for screw fixing of the 17" and 19" touch panel		6AV7672-8KE00-0AA0
External USB disk drive	1 m connecting cable	6FC5235-0AA05-1AA1
PCI multi-I/O module	Provides one parallel and one serial interface	6ES7648-2CA00-0AA0
SIMATIC PC DiagMonitor software ≥ V 3.1	Software tool for monitoring local and remote SIMATIC PCs: <ul style="list-style-type: none"> • Watchdog • Temperature • Fan speed • Hard disk monitoring (SMART) • System / Ethernet monitoring (Heart Beat) Communication: <ul style="list-style-type: none"> • Ethernet interface (SNMP protocol) • OPC for integration in SIMATIC software • Client server architecture • Layout of log files 	6ES7648-6CA02-2YX0
SIMATIC PC Image Creator software	Software tool for saving data locally	6ES7648-6AA03-0YX0
Module for DDR2 RAM expansion	512 MB 1 GB 2 GB	6ES7648-2AG30-0HA0 6ES7648-2AG40-0HA0 6ES7648-2AG50-0HA0
Remote Kit order variant Remote Kit, 24 V DC, 5 m Remote Kit, 24 V DC, 10 m Remote Kit, 24 V DC, 20 m Remote Kit, 24 V DC, 30 m Remote Kit, 100/240 V AC, 5 m Remote Kit, 100/240 V AC, 10 m Remote Kit, 100/240 V AC, 20 m Remote Kit, 100/240 V AC, 30 m	You can find ordering information in the Internet at: http://www.siemens.com/automation/mall	
You can find additional accessories in the catalog or in the Internet under: http://www.siemens.com/automation/mall		

Description

3.3 Panel PC 677B accessories

Application planning

4.1 Overview

Introduction

This section describes the first steps after unpackaging, the permitted mounting positions and the fixation. This section describes the necessary considerations for EMC.

Field of application

The Panel PC is an industry-standard PC platform for demanding tasks in the field of PC-based automation. The Panel PC is designed for on-site use on the machine, installed for example in:

- Control cabinet installation
- Swivel arm mounting
- Rack mounting

Note

In the following, the term "switchgear cabinet" also refers to rack, mounting rack, switchboard, operator panel and console. The term "device" represents the Panel PC and its variants.

4.2 Unpacking and checking the delivery

Procedure

1. Please check the packaging material for transport damage upon delivery.
2. If any transport damage is present at the time of delivery, lodge a complaint at the shipping company in charge. Have the shipper confirm the transport damage immediately.
3. Unpack the device.

CAUTION

Do not lie the device on its back. This will avoid any damage to an optical drive which may be present. Lie the front side on a soft surface to avoid damaging the front panel USB port.
--

4. Keep the packaging material in case you have to transport the unit again.

NOTICE

The packaging protects the device during transport and storage. Therefore, never dispose of the original packaging material!
--

5. Please keep the enclosed documentation in a safe place. You will need the documentation when you start up the device for the first time.
6. Check the package contents for completeness and any visible transport damage. Check for completeness using the enclosed scope of delivery list.
7. Should the contents of the package be incomplete or damaged, please inform the responsible supply service immediately and fax us the enclosed form "SIMATIC IPC/PG quality control report".

 WARNING
--

Make sure that a damaged device is not installed nor put into operation.
--

8. Note the identification information as described in the chapter "Identification data of the device".

4.3 Device identification data

The device can be clearly identified with the help of this identification data in case of repairs or theft.

Enter the following data in the table below:

- Serial number: The serial number (S VP...) is found on the rating plate.

Rating plate



- Order number of the device
- Ethernet addresses: The Ethernet addresses of the device can be viewed in the BIOS Setup (F2) under "Main > Hardware Options > Onboard Ethernet Address".
- Microsoft Windows "Product Key" on the "Certificate of Authenticity" (COA). The COA label is bonded to the device. The Product Key is always required to reinstall the operating system.

COA label



Serial number:	S VP ...
Order No.	6AV787.....
Microsoft Windows Product Key	
Ethernet address 1	
Ethernet address 2	

4.4 Mounting positions and fastening

4.4.1 Installation guidelines

Before installing the device, read the following general notes relating to installation.

 WARNING
--

Danger, high voltage

Isolate the power supply to the switchgear cabinet before opening it. Ensure that the power to the switchgear cabinet cannot be turned on accidentally.

CAUTION

The device is approved for operation in closed rooms only.
--

- Ensure that the protective contact socket of the building installation is easily accessible and that there is a mains disconnect switch in switchgear cabinet installations.
- Position the screen in an ergonomic position favorable to the user. Choose a suitable installation height.
- Position the screen so that it is not subject to direct sunlight or other strong sources of light.
- Optical drives are susceptible to shock. Shocks during operation can lead to the loss of data or damage to the drive or data carrier. Optical drives are not only suitable for continuous operation.
- Applies to devices which are installed in swivel arm housings: Avoid rapid or jerky movements of the swivel arm during operation. The ensuing forces could lead to possible irreversible damage of the hard disk.
The stops of the swivel arm must be damped in order to avoid any mechanical shock effect to the Panel PC on attachment.
- Applies to devices which are installed in cabinet doors: Prevent the doors being slammed shut. The ensuing forces could lead to possible irreversible damage of the hard disk.
- The device with DC power supply applies in the area of the computer unit and above all the power supply connection in accordance with the UL approval as "open type" or "open equipment". For this reason, the device must be installed in a control cabinet or housing that complies with fire-proofing requirements

Note

The computer unit with AC power supply satisfies fire protection requirements to EN 60950-1. It may therefore be installed without additional fire-proofing measures.

- Provide adequate volume in the switchgear cabinet for air circulation and heat transport. Keep at least 10 cm distance between the device and switchgear cabinet.
- Ensure that the maximum air intake temperature, measured 10 cm before the air intake opening on the fan, does not exceed 45°C. The maximum air intake temperature must be accounted for especially when sizing closed switchgear cabinets.
- The minimum distance between the device and the housing is 10 cm on the air output side at the fan.
- Position the device in such a way that the air vents of the housing are not covered up following mounting.
- Ensure there is enough free space in the switchgear cabinet to allow the sheet metal cover to be removed. You will otherwise have to remove the device from the switchgear cabinet or swivel arm when replacing memory or the battery.
- Equip the switchgear cabinet with struts for stabilizing the mounting cut-out. Install struts where necessary.
- Avoid extreme environmental operating conditions. Protect your device against dust, moisture and heat.
- Install the device in such a way that it poses no danger, e.g. by falling over (see Chapter "Specifications").
- During assembly, please comply with the approved installation positions.

NOTICE

If you mount the device in an impermissible installation position or you do not observe the environmental conditions (see Chapter "Specifications"), you endanger the product safety provided by the UL-approval and compliance with the low-voltage directive (via EN 60950-1). In addition, the functionality of the device is no longer guaranteed.

For additional information, refer to the dimension diagrams in the appendix.

4.4.2 Installation information stainless steel front

Before you install the device, read the additional installation guidelines below:

- Make sure that you can access the device from the rear.
- The mounting cut-out should be deburred.
- When operating the device in a switch cabinet, ensure compliance with permitted ambient conditions and, in particular, that permitted ambient temperatures are not exceeded. Make allowances for the fact that the thermal conductivity of control cabinets made of stainless steel is not as good as that of an aluminum cabinet, for example.
- Check the seal on the device. Always install the device with this seal.
- Always use the included clamping frame and clamps to mount the device.

4.4.3 Permitted mounting positions

Approval

Only certain mounting positions are approved for the device.

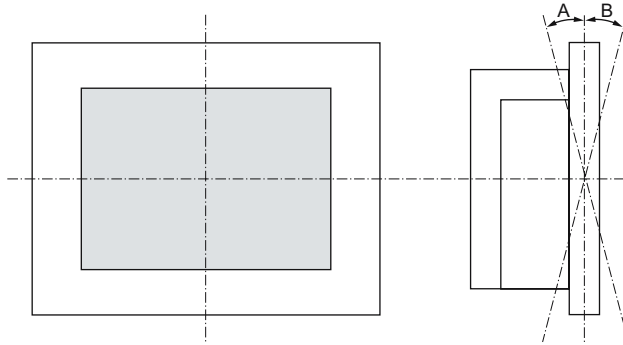

Figure 4-1 Mounting position

Table 4-1 Permissible deviations from the vertical mounting position

Temperature	Angle A	Angle B
to 45°C	20°	20°

Note

When mounting the device at an angle, note the following.

- Do not subject the device to mechanical stress.
- Operation of a DVD drive is not permitted.

4.4.4 Type of fixation

The computer unit is secured in the mounting cut-out either with clamps or screws.

NOTICE
Securing with screws is not possible with the 12" touch screen variant.

Select the type of fixation suitable to your requirements for the degree of protection (see section "Protection against dust and water") .

4.4.5 Stainless steel front type of fixation

Type of fixation

The device is fastened with the included clamps. Additional fastening bore holes or threaded bolts are not required for the control panel.

Degree of protection

CAUTION

Degree of protection IP66 is only ensured if the seal of the device is correctly positioned and evenly pressed on the control panel. Refer to the "Installation" section for more information.

4.4.6 Protection against dust and water

Principle

With the relevant installation, the device is protected on the front against the ingress of dust and water. The "degree of protection" is in accordance with IEC 60529: On the front, the device has degree of protection IP65, the rear of the operator section and the computer unit have degree of protection IP20.

CAUTION

Ensure that the material strength at the mounting cut-out is a minimum of 2 mm and a maximum of 6 mm. Please follow the specifications for the dimensions in the "Mounting cut-out" section.

The degrees of protection IP65, IP54 and NEMA 4, are only guaranteed when the following conditions are met:

- The surface plane deviation of the mounting cut-out in relation to the external dimensions of the control unit amounts to ≤ 0.5 mm when the control unit is mounted.

Degree of protection IP65 and NEMA 4

IP65 degree of protection and compliance with the NEMA 4 regulations are only ensured when clamp mounting together with a ring seal.

IP54 degree of protection

The IP54 degree of protection is applicable for the following conditions:

	Key panel		Touch panel		
	12"	15"	15"	17"	19"
Screw mounting	X	X	X	-	-
Screw mounting with backing plate	-	-	-	X	X

Note

A backing plate is available as an accessory for screw mounting the 17" and 19" touch panel. You can find additional information under: <http://www.siemens.com/automation/mall>

4.5 Mounting cut-out

4.5.1 Preparing the mounting cut-out

The following illustration shows the dimensions for the mounting cut-out.

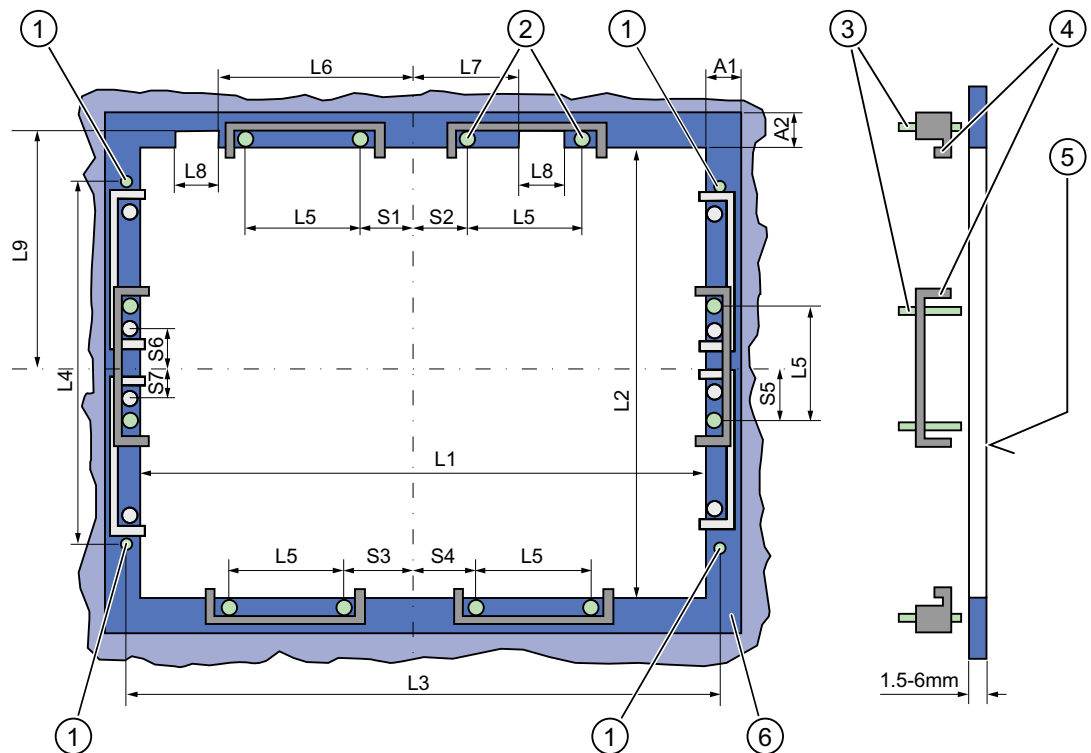

Figure 4-2 Drill holes for the screws and pressure points for the clamp screws

- | | |
|-------------------------------------|-----------------------------|
| (1) Drill hole for screw attachment | (4) Clamp |
| (2) Pressure points for clamp | (5) Rz 120 in the seal area |
| (3) Setscrews | (6) Seal area |

Note

Mounting dimensions can be read from the dimension overview or they can be transferred to the cabinet from the mounting template supplied.

4.5 Mounting cut-out

Table 4-2 Dimensions for the mounting cut-out in mm

Control unit	L1	L2	L3 ¹⁾	L4 ¹⁾	L5	L6 ²⁾	L7 ²⁾	L8 ²⁾	L9 ²⁾	A1	A2	S1	S2 S3 S4	S5 ³⁾	S6 ³⁾ S7 ³⁾
Tolerance	±1	+1	±0,2	±0,2	±0,5	±0,5	±0,5	±0,5	+1	±1	±1	±1	±1	±1	±1
Key panel															
12" TFT	450	290	465	235	112	—	—	—	—	16	10	78	78	56	—
15" TFT	450	321	465	279	112	186	135	25	165	16	17	51	51	56	—
Touch panel															
12" TFT	368	290	—	—	112	—	—	—	—	16	10	19	35	56	—
15" TFT	450	290	465	235	112	—	—	—	—	16	10	81	81	56	—
17" TFT	450	380	465	235	112	—	—	—	—	16	10	46	46	—	33
19" TFT	450	380	465	235	112	—	—	—	—	16	10	46	46	—	33

1) M6 thread or drill holes with a diameter of 7 mm

2) Cut-outs for the shafts of the insert strips are only necessary for 15" key panels.

3) Two clamps necessary for vertically securing clamps for 17" and 19" touch panels only.

Preparing the mounting cut-out

Steps for preparing the mounting cut-out	
1	Select a location suitable for mounting, taking into account the mounting position.
2	On the basis of the dimensions, check whether the required screw and pressure points on the rear and the seal area are easily accessible after the completion of the mounting cut-out. Otherwise the mounting cut-out is useless.
3	Complete the mounting cut-out in accordance with the dimensions.

4.5.2 Mounting depth of the device

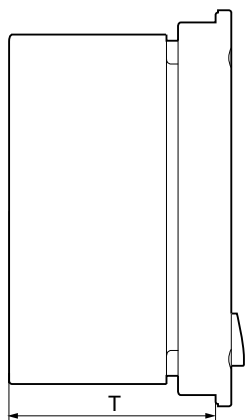

Panel PC with operator control units	Depth D
Key panel with 12" TFT	105 mm
Key panel with 15" TFT	124 mm
Touch panel with 12" TFT	123 mm
Touch panel with 15" TFT	121 mm
Touch panel with 17" TFT	130 mm
Touch panel with 19" TFT	130 mm

Note

Additional mounting depth with optical drive

The installation depth increases by 21 mm when an optical drive is installed in the device.

4.6 EMC Guideline

Electromagnetic compatibility

The device fulfills the requirements of the EMC law of the Federal Republic of Germany as well as the EMC directive of the Single European Market.

The device is designed as a built-in device. You can ensure compliance with the EN 61000-4-2 (ESD) EMC standard by installing the device in grounded metal cabinets (for example, 8 MC cabinets, Siemens catalog NV21).

Note

For additional information about EMC requirements, refer to the Specifications section.

Installing the device according to EMC directive

Basics for interference-free operation:

- Install the controller according to EMC directive
- Use interference immune cable

Note

The instructions "Guidelines for the assembly of interference immune programmable logic controllers" with the article ID 1064706 and the manual "PROFIBUS networks" with the article ID 1971286, which also applies to the installation of the device, is located on the "Documentation and Drivers" CD.

Mounting

5.1 Securing the device with clamps

Requirement

Accessories	Display			
	12"	15"	17"	19"
Clamp	6 x	6 x	8 x	8 x
	The clamps are provided with the control unit.			
Tool	2.5 mm hexagonal spanner			

Procedure



Figure 5-1 Clamp assembly

1. Disconnect the device from the power supply.
2. Working from the front, insert the device into the 19" rack on the swivel arm or in the mounting cut-out.
3. Fasten the control unit from the rear using the clamps.
4. Tighten the setscrews to a torque of 0.4 - 0.5 Nm.

IP65 degree of protection

The plant builder is responsible for the correct installation of the device. The degree of protection IP65 is only guaranteed for the front of the device if the ring seal is properly applied with the correct size of cutout, the unit has been clamped in place, and the instructions below are observed.

NOTICE
Control cabinet installation: Material strength at the mounting cut-out
Ensure that the material strength at the mounting cut-out is a minimum of 2 mm and a maximum of 6 mm. Please follow the specifications for the dimensions in the "Preparing the mounting cut-out" section.
The degrees of protection are only guaranteed when the following is observed:
<ul style="list-style-type: none"> The surface plane deviation of the mounting cut-out in relation to the external dimensions of the control unit amounts to ≤ 0.5 mm when the control unit is mounted.

5.2 Securing with screws

Note

Securing with screws is not possible with the 12" touch panel variant. To secure the 17" and 19" touch panel with screws, backing plates with order number 6AV7672-8KE00-0AA0 are required on the front.

Drill holes in the control unit

Steps for drilling holes	
1	Drill holes (\varnothing approx. 2.5 mm) from the rear in the four recesses of the control unit
	
2	Drill these holes with a diameter of \varnothing 5.5 mm for M5 and a \varnothing 6.5 mm for M6.
3	Deburr the holes from the front of the control unit

NOTICE**Risk of damage**

Ensure that no metal cuttings enter the device when the holes are drilled. Cover the device with film or when drilling, use removal by suction.

Drill holes in the mounting unit

1. Drill the holes at the prepared mounting cut-out according to the information for L3 and L4. (see Chapter "Mounting cut-out")
2. Working from the front, insert the device into the 19" rack on the swivel arm or in the mounting cut-out of the control cabinet.
3. Secure the control unit by inserting suitable screws and nuts

IP54 degree of protection

The IP54 degree of protection is guaranteed for mounting together with the ring seal.

 CAUTION**Observe the panel seal when mounting**

Ensure you do not damage the panel seal when mounting the device.

NOTICE**Control cabinet installation: Material strength at the mounting cut-out**

Ensure that the material strength at the mounting cut-out is a minimum of 2 mm and a maximum of 6 mm. Please follow the specifications for the dimensions in the "Preparing the mounting cut-out" section.

The degrees of protection are only guaranteed when the following is observed:

- The surface plane deviation of the mounting cut-out in relation to the external dimensions of the control unit amounts to ≤ 0.5 mm when the control unit is mounted.

5.3 Fix the device with stainless steel front using clamps

Introduction

This section describes how to mount the device in a control panel.

CAUTION

Mount the device as intended. This will avoid damage to the device and loss of warranty. Follow the installation instructions.
--

Procedure

1. Ensure that the seal does not become twisted during mounting, otherwise the mounting cut-out may not be correctly sealed.
2. Working from the front, insert the device into the prepared and deburred mounting cut-out. Take the necessary precautions to ensure the device cannot drop out of the control panel before it has been secured in place.
3. Place the clamping frame with the centering bore holes onto the device. Make sure that the flat side of the frame makes contact with the back of the control panel.



Figure 5-2 Clamping frame with seal

4. Insert the fastening hooks (1) of the clamps into the recesses (2) of the device. Make sure that the centering points (4) of the clamps are inserted into the corresponding centering bore holes (3) of the clamping frame.

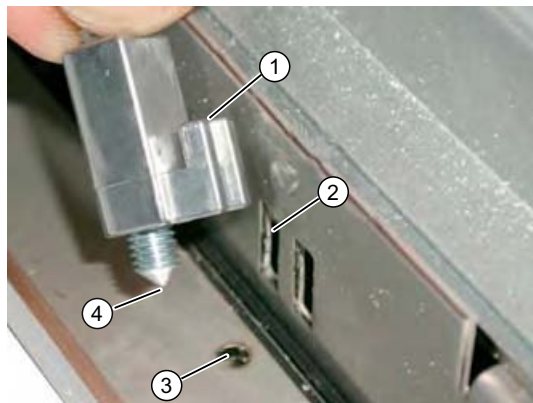

Figure 5-3 Inserting the clamps

5. Tighten the screws of the clamps.



Figure 5-4 Proper positioning of the clamp

Use a hexagonal head torque wrench set to a maximum tightening torque of 0,6 N/m in order to achieve an optimal sealing effect.

CAUTION

Any higher torque may warp the control panel or the switchboard panel. The specified degree of protection is not ensured otherwise.

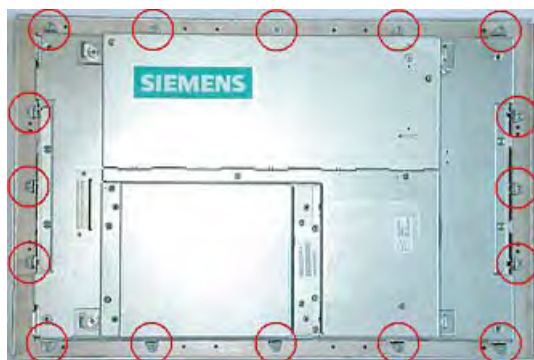

Figure 5-5 Position of the clamps

Check the proper seating of the seal on the front side. If it is not seated properly, repeat the installation.

Connecting

6.1 Connection elements and operator controls

Connection and Operator Control Components of the Computer Unit

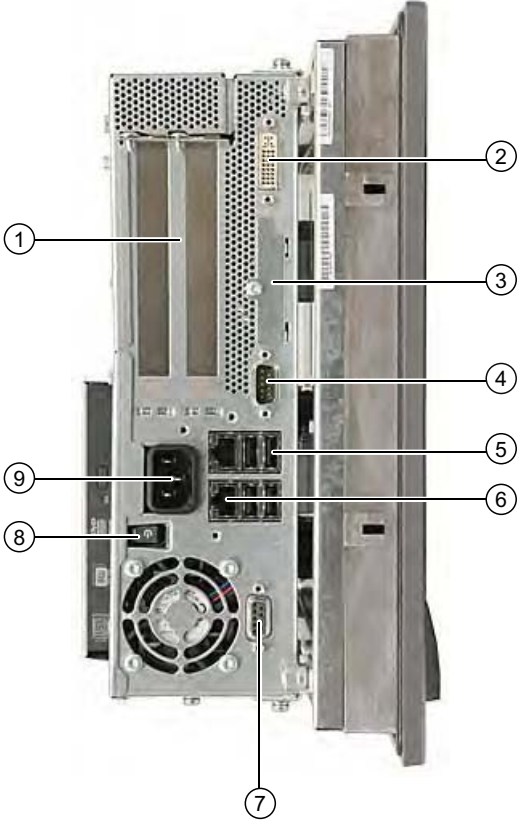
Locations of connection and operator control components			
	Pos	Name	Description
	(1)	PCI (e)	2 slots for PCI expansion module
	(2)	DVI/VGA	DVI/VGA socket for CRT or LCD monitor with DVI interface or VGA monitor via DVI/VGA adapter
	(3)	Compact Flash	Slot for Compact Flash card
	(4)	COM 1	Serial interface (RS232) 9-pin D-sub connector
	(5)	USB	4 USB 2.0 interfaces (2 interfaces can be simultaneously used as high current (500 mA) outputs)
	(6)	Ethernet	2 RJ45 connections for 10/100 Mbps
	(7)	PROFIBUS DP/MPI	MPI interface (RS485, electrically isolated), 9-pin D-sub plug
	(8)	On / Off switch	-
	(9)	100 - 240 V AC or 24 V DC	Connection for AC or DC power supply (depending on the product variant, the figure shows the AC power plug) The relevant angle is included with the device for interlocking the connector.

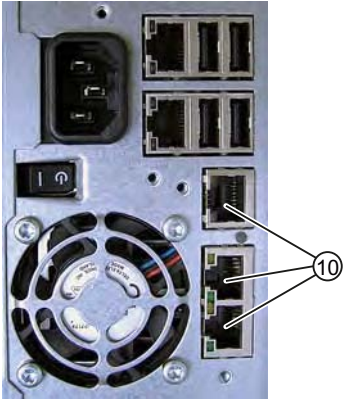
Locations of connection and operator control components			
	(10)	PROFINET	CP 1616 onboard interface, three RJ45 sockets (optional product version)

<p>NOTICE</p>
<p>On / Off switch</p> <p>The On / Off switch does not disconnect the device from the mains. When the switch is in the 0 position, the device is still connected to the auxiliary voltage.</p>

Connection components of the control unit

USB connection control unit			
	Pos	Name	Description
	(1)	USB	1 connection USB 2.0 high current / 500 mA under sealed cover (not available with every product variant).

<p>NOTICE</p>
<p>Ensuring degree of protection P65</p> <p>When the sealed cover over the USB interface is removed in order to connect a USB component, the IP65 degree of protection for the device is no longer guaranteed.</p>

Note**Use of USB devices**

- Wait at least ten seconds between removal and reconnection of USB devices. This also applies to control units with touch screen panels, especially for touch operation.
- When using standard USB peripherals, bear in mind that their EMC immunity level is frequently designed for office applications only. These devices may be used for commissioning and servicing. However, only industry-standard devices are allowed for industrial operation.
- Peripherals are developed and marketed by individual vendors. The respective manufacturers offer support for the peripherals. Moreover, the terms of liability of the individual vendors or suppliers apply here.

6.2 Connecting the 120 V / 240 V Ac power supply

Note before connecting the device**Note**

The varying voltage power supply module is designed for operation on 120 / 240 V AC networks. The setting of the voltage range takes place automatically.

 WARNING

Do not connect or disconnect power and data cables during thunderstorms.

 WARNING

The device is designed for operation on grounded power supply networks (TN networks to VDE 0100, Part 300, or IEC 60364-3).

Operation on ungrounded or impedance-grounded power networks (IT networks) is prohibited.

 WARNING

The permitted nominal voltage of the device must conform with local mains voltage.

CAUTION

The mains connector must be disconnected to fully isolate the device from the mains. Ensure easy access to this area.

A master mains disconnect switch must be installed if the device is mounted in a switch cabinet.

Always ensure free and easy access to the power inlet on the device or that the safety power outlet of the building installation is freely accessible and located close to the device.

Note

The power supply contains an active PFC (Power Factor Correction) circuit to conform to the EMC guidelines.

Uninterruptible AC power systems (UPS) must supply a sinusoidal output voltage in the normal and buffered mode when used with SIMATIC PCs with an active PFC.

UPS characteristics are described and classified in the standards EN 50091-3 and IEC 62040-3. Devices with sinusoidal output voltage in the normal and buffered mode are identified with the classification "VFI-SS-...." or "VI-SS-....".

Localized information

For countries other than the USA and Canada:

240 V supply voltage

This device is equipped with a safety-tested power cable which may only be connected to a grounding outlet. If you choose not to use this cable, you must use a flexible cable of the following type: Min 18 AWG conductor cross-section and 15-A / 250-V shockproof connector. The cable set must be compliant with the safety regulations and stipulated IDs of the country where the system is to be installed.

For the USA and Canada:

For the United States and Canada, a CSA or UL-listed power cord must be used.

The connector must be compliant with NEMA 5-15.

120 VAC power supply

Use a flexible power cord which is approved to UL and CSA, and which has the following features: Type SJT with three leads, min. 18 AWG conductor cross-section, max. 4.5 m in length and parallel ground contact connector 15 A, min. 125 V.

240 VAC power supply

Use a flexible power cord which is approved to UL and CSA, and which has the following features: Type SJT with three conductors, min. 18 AWG conductor cross-section, max. length 4.5 m, and tandem grounded connector 15 A, min. 250 V.

Connecting

How to connect the device to the 120 V AC / 240 V AC power supply		
1	Ensure that the On/Off switch is in '0' position (Off) when you plug in the power cord in order to avoid unintentional startup of the device.	
2	Connect the equipotential bonding.	
3	Insert the power cable in the electrical socket.	
4	Fasten the cable with the supplied power plug latch, if necessary.	

Power consumption

Depending on the size of the display and taking into account 15 W per PCI slot, the power consumption for devices with 12" and 15" operator control units is max. 140 W, and with 17" and 19" operator control units it is max. 163 W.

6.3 Connecting the (24 V) DC power supply

Note before connecting the device

<p>⚠ WARNING</p> <p>Only connect the device to 24 V DC power supply systems which meet the requirements of a safe extra-low voltage (SELV); in addition, a protective conductor must be connected. The conductors must withstand the short-circuit current of the 24 V DC power source, so that a short-circuit will not damage the cable. Only connect cables with a minimum cross-section of 1.3 mm² (AWG16) and a maximum cross-section of 3.3 mm² (AWG12).</p>

<p>NOTICE</p> <p>The 24 V DC power supply must match the power consumption of the device (see Specifications).</p>

Connecting

Steps for connecting the device to the 24 V DC power supply	
1	Ensure that the On/Off switch is in the '0' (OFF) position to prevent unintentional startup of the device when connecting it to the 24 V power supply.
2	Switch off the 24 V DC power supply.
3	<p>Attach the DC connector.</p> <p>(1) 24 V DC</p> <p>(2) ground</p> <p>(3) protective conductor</p>



The image shows the rear panel of a SIMATIC Panel PC 677B. A DC power connector is highlighted with three callouts: (1) points to the positive terminal, (2) points to the ground terminal, and (3) points to the protective earth terminal. Other features on the panel include a power switch, a fan, and various communication ports.

6.4 Connecting the Equipotential Bonding Circuit

A low-resistance ground connection ensures that interference signals generated by external power supply cables, signal cables or cables to the I/O modules are safely discharged to ground.

The equipotential bonding connection of the device is located underneath the device and is identified by the following symbol:



Figure 6-1 Equipotential Bonding

Connecting the Equipotential Bonding Circuit

You require a TORX T20 screwdriver to connect the equipotential bonding conductor.

Steps for connecting the equipotential bonding	
(1)	<p>Connect the equipotential bonding connection (M4 thread) (1) on the device (large surface, large-area contact) with the central grounding point of the control cabinet. The minimum permissible cross-section is 5 mm².</p>

6.5 Equipotential bonding with stainless steel front

Information on devices with stainless steel front

CAUTION
<p>Ensure proper electrical contact between the enclosure of the device and the switchboard. The conductive surfaces of the clamping frame and of the switchboard should have proper contact.</p>

6.6 Connecting Ethernet strain relief

The Ethernet strain relief provided in the package is used to prevent accidental removal of the Ethernet cable with Industrial EthernetFastConnect connector from the device. Two cable ties (not included in the package) are needed to use this accessory.

To fix the Ethernet strain relief with Industrial EthernetFastConnect connector, you will need a TORX T20 screwdriver.

Steps for connecting the Ethernet strain relief	
1	Fasten the Ethernet strain relief (1) to the device enclosure with two oval-head screws (M4 thread).
2	Connect the power cable and secure it with the cable tie (2).

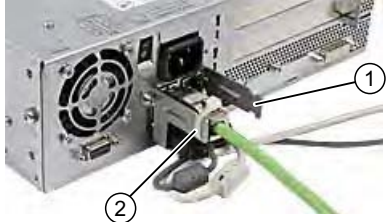

6.7 Connecting the power plug locking mechanism

The power plug locking mechanism is part of the scope of supply and prevents the power plug from being pulled out accidentally. The power plug locking mechanism is a metal bracket that is screwed onto the computer housing.

You require a TORX T20 screwdriver for attaching it to the housing.

The power plug locking mechanism is a safety-relevant part. Read the information in the chapter "Connecting the (120 V / 240 V AC) power supply".

Integration into an automation system

7.1 Overview

Introduction

The following options are available for integrating the device in existing or planned system environments and networks.

Ethernet

The integrated Ethernet interface can be used for communication and for data exchange with automation devices such as SIMATIC S7.

You require suitable software for this: STEP 7, WinCC, WinCC flexible, WinAC, SIMATIC NET.

PROFIBUS/MPI

The isolated PROFIBUS interface can be used to connect distributed field devices or to link with SIMATIC S7.

You require suitable software for this: STEP 7, WinCC, WinCC flexible, WinAC, SIMATIC NET.

PROFINET

The CP 1616 onboard enables Panel PCs to be connected to Industrial Ethernet. Only one CP 1616 can be installed in a PC. Detailed information can be found in the next section or in the chapter *Detailed descriptions > CP 1616 onboard communications processor*.

Device driver CP16xx.sys

The device driver enables the Windows network protocols to be connected to the Ethernet PROFINET controller "CP 1616 onboard" which is optional on the SIMATIC PCs. The PROFINET interface will act like a 100 Mbit Ethernet interface with a MAC address when you use this driver. The three RJ45 sockets are connected with each other via a switch.

The driver and the documentation can be found in the supplied Documentation and Drivers CD.

PROFINET IO application

You can create, run or configure PROFINET IO applications with the "Development Kit DK-16xx PN IO". It must be installed in addition to the device driver CP 16xx.sys. You can download this kit and the documentation free of charge at the following Internet address: (http://www.automation.siemens.com/net/html_76/produkte/040_cp_1616_devlopkit.htm)

SIMATIC NET

You can create, run and configure the SIMATIC installation with this software package. Information on this can be found on the SIMATIC NET Manual Collection CD. The software package and the documentation are not included in the package.

Additional information

You can find additional information in the catalog and in the Internet of Siemens A&D.

<http://www.siemens.com/automation/mall>

7.2 Device in SIMATIC S7 network

7.2.1 MPI/PROFIBUS-DP network

You can connect the device to a SIMATIC S7 automation system or a PROFIBUS DP network via the MPI/DP interface. You can connect up to 32 PC, PG, or AS devices to one network segment. The use of repeaters allows you to interconnect several MPI/PROFIBUS DP network segments. The complete MPI/PROFIBUS DP network consists of a maximum of 127 stations.

The device is physically connected to the MPI/PROFIBUS DP network via an electrically isolated RS485 interface on the PC motherboard. The potential is isolated within the safety low voltage circuit (SELV).

The transmission rate is limited to 187.5 Kbps with the 5-meter MPI cable for connecting to the SIMATIC S7-CPU. To achieve baud rates over 1.5 Mbps, you require a 12 Mbps PROFIBUS cable with the order number 6ES7901-4BD00-0XA0. In the PROFIBUS DP MPI network, you can achieve data transmission rates of 9.6 Kbps to 12 Mbps.

7.2.2 Connecting an S7 automation system

Coupling

The device is coupled via the MPI/DP interface as follows:

- With MPI networks S7-200, S7-300, and S7-400
- PROFIBUS DP networks with DP components

Hardware requirements

You can use the following components for coupling or networking with PROFIBUS:

- RS 485 interface, MPI/DP interface, onboard
- PROFIBUS cable

Note

Refer to the SIMATIC Net catalog IK PI for more information about SIMATIC Net expansion cards.

Procedure

1. Disconnect the device from the mains.

CAUTION
Risk of damage to the device!
Neutralize the static charge of your body, the device, and the connecting cables. You can do this by briefly touching the metal housing with the cable in your hand.

2. Insert the PROFIBUS cable in the MPI/DP socket.
3. Reconnect the device to the electrical power system.

7.3 Transferring authorizations

Note

The device has no floppy disk drive. Therefore, where necessary, transfer the authorizations for SIMATIC HMI software from a USB floppy disk drive.

The following devices have been tested:

SINUMERIK floppy disk drive, order number 6FC5235-0AA05-1AA2

CAUTION
The USB floppy disk drive is only suitable when mounted in a control cabinet.

7.4 Networking via Industrial Ethernet

You can establish a network between the device and other computers via Industrial Ethernet. The on-board LAN interface is a twisted-pair (TP) interface for data transfer rates of 10/100/1000 Mbps.

NOTICE
A category 6 Ethernet cable is required for 1000 Mbps operation.

7.5 PROFINET

CP 1616 onboard

The basic characteristics of the CP 1616 onboard are:

- Optimized for PROFINET IO
- With Ethernet-Real-Time-ASIC ERTEC 400
- Three RJ45 sockets for connecting terminal devices or addition network components
- Integrated 3-port real-time switch
- Automatic hardware detection

CAUTION

Only one CP 1616 can be installed in a PC. If you want to use an additional CP 1616 module, the "CP 1616 onboard" option must be disabled in the BIOS Setup.

Additional documentation on PROFINET

Get an overview of the information available on the topic of PROFINET.

Document designation	What is contained in this document?
This documentation is not included in the product package:	
Getting Started PROFINET IO Getting Started: Manual Collection	The documents use concrete examples to provide step-by-step instructions on how to commission a fully functional application.
Manual PROFINET System Description	This gives you the basic knowledge about the PROFINET IO topics: Network components, data exchange and communication, PROFINET IO, Component Based Automation, application example of PROFINET IO and Component Based Automation.
Manual From PROFIBUS DP to PROFINET IO	Read this document if you want to convert an installed PROFIBUS system to a PROFINET system.
Readme file for CP 1616/CP 1604 and DK-16xx PN IO	This provides the latest information about the SIMATIC NET products CP 1616/CP 1604, CP 1616 onboard, the developer kit.
Configuration Manual Commissioning PC Stations	This provides you with all the information necessary for commissioning and configuring a PC as a PROFINET IO Controller or IO Device.
Manual SIMATIC NET Industrial Communication with PG/PC: Volume 1 - Basics SIMATIC NET Industrial Communication with PG/PC: Volume 2 - Interfaces	This manual introduces you to industrial communication and explains the available communication protocols. It also describes the OPC interface as an alternative to the IO-based user programming interface.
S7 CPs for Industrial Ethernet Configuring and Commissioning	This provides the following support: - For commissioning S7 stations - For establishing effective communication

Document designation	What is contained in this document?
Manual SIMATIC NET - Twisted Pair and Fiber-Optic Networks	Configure and build your Industrial Ethernet networks based on this document.
This documentation is part of the supplied Documentation and Drivers CD:	
Operating Instructions CP 1616/CP 1604/CP 1616 onboard	This provides you with all information required for operation.
Installation guide Device Driver CP16xx.sys	Read this guide if you want to install the NDIS device driver, CP16xx.sys.

Further information

You can find the information on specific products in the Internet at the address:
<http://www.siemens.com/simatic-net>

Commissioning

8.1 Overview

Check list

Before starting up the device for the first time, go through the following checklist:

- Have you taken into account the proper ambient and environmental conditions for the device, as described in the specifications?
- Have you connected the equipotential bonding if required?
- Have you checked that the power supply is connected correctly and that the values are appropriate?
- Read over this information in the respective "Connecting" chapter of the operating instructions. Please follow all guidelines.

CAUTION

Condensation

When transporting the device at low temperatures, ensure that no moisture gets on or into the device. This also applies if the device is subjected to extreme changes in temperature. Wait 12 hours before switching the device on.

Allow the device to slowly adjust to room temperature before commissioning the device. Do not subject the device to direct heat radiation from devices such as heaters.

Requirement

- The equipotential bonding is connected.
- The cables are correctly plugged in.
- A USB keyboard and a USB mouse are connected.

8.2 Switching on the device

Procedure

1. Switch on the external AC or DC supply.
2. Connect the external keyboard and mouse.
3. Switch on the equipment using the switch next to the supply connector.
4. The "POWER" LED will light up: The device starts up and boots.

Self-test

After switching on, the device performs a self test. During the self test, the message "Press <F2> to enter SETUP" appears briefly. Do not press this key during this first start up.

When the self-test is finished, the operating system will be loaded. You will see this from the screen display.

5. Before you install additional hardware in the SIMATIC Panel PC, such as a PCI card, please start up the equipment once without it.

8.3 Windows XP, Vista Security Center

Warning from the Windows Security Center

A warning from the Windows Security Center appears the first time you switch on your device. The Security Center checks the status of the device in regard to the three important security aspects listed below. If a problem is detected (an outdated antivirus program, for example), the Security Center issues a warning and makes recommendations on how you can better protect the device.

- **Firewall:** The Windows Firewall adds protection to the device by blocking network or Internet access to the device by unauthorized users. Windows checks if the device is protected by a software firewall.
The firewall is enabled in the factory state.
- **Antivirus software:** Antivirus programs add protection to the device by searching for and eliminating viruses and other security threats. Windows checks if a full-range, up-to-date antivirus program is running on the device.
No antivirus software is installed in the factory state.
- **Automatic updates:** Using the Automatic Update feature allows Windows to regularly search for the latest critical updates for the device and to install them automatically. This feature is disabled in the factory state.
- **Realtime protection (Vista only):** Windows Defender displays warnings if spyware or possibly unwanted software is installed or executed on the computer. You will also receive a warning if programs attempt to modify important Windows settings.

Configure the Security Center according to your requirements.

8.4 Setting up the Microsoft Windows operating system

Introduction

The setup wizard appears immediately following the startup of the device. The wizard is used to set the parameters of the operating system.

Note

The dialogs of the setup wizards differ slightly in some places for the Windows 2000 Professional and Windows XP Professional operating systems.

In order to change to the next dialog, click on the ">>" button. In order to change the entry in the previous dialog, click on the "<<" button.

Procedure

1. Accept the Microsoft licensing agreement.
2. Leave the regional settings of the operating system unchanged. If required, adjust the regional settings of the operating system only after commissioning.
3. Enter the company names and user names.
4. If this PC name is already in use as you attempt to connect the device to a network: Enter a new PC name for identification.

The operating system will restart automatically.

The system settings are updated. The desktop is set up. The setup of the operating system is complete.

8.5 Additional applications

First commissioning

- The "Panel Wizard" program is automatically started up once during first commissioning.
- The Panel Wizard implements the specific settings for the Panel PC during the initial start-up of the operating system.
- During the first start-up of the Panel PC, different dialogs appear on the screen based on which the drivers and applications can be set.

NOTICE

Start up the Panel PC for the first time exactly as it was delivered and complete all of the installation dialogs, otherwise malfunctions can occur.
--

Procedure

During the hardware detection, device-specific drivers are set.



Figure 8-1 Start screen

Select the panel type.



Figure 8-2 Panel type

8.5.1 Touch Panel set-up

1. Select the desired screen size.

Note

The screen size data can be found on the rating plate of the Touch Panel. The screen resolution is adapted accordingly.

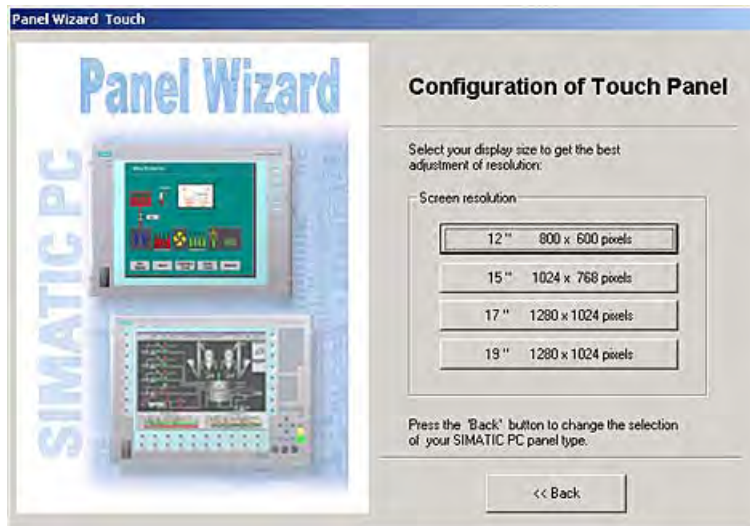

Figure 8-3 Touch Panel; selection of the screen size

Note

During the hardware recognition, the Touch Controller is detected again and entered.



Figure 8-4 Touch Panel; exiting the Panel Wizard

2. Click on the button "Finish".
A hardware detection symbol is displayed.



Figure 8-5 Panel Wizard, hardware detection

Note

Soft keyboard

- If the checkbox "enable" is activated, at every program start of **MS Windows** the **Windows** soft keyboard is displayed for log-in. This keyboard can be used, for example, to enter the administrator password. An external keyboard is then not necessary.
 - If you deactivate the checkbox, the soft keyboard does not appear when logging in.
-

Touch screen calibration

After concluding the "Panel Wizard" dialog, the touch controller is installed.

1. Calibrate the touch screen.

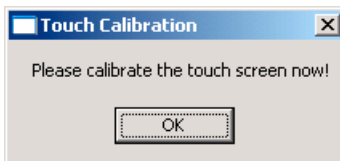

Figure 8-6 Start touch screen calibration

2. Confirm with "OK".

8.5.2 Key Panel adjustment

1. Select the desired screen size.

Note

The screen size data can be found on the rating plate of the Key Panel.



Figure 8-7 Key Panel; selection of the screen size



Figure 8-8 Key Panel; exiting the program

2. Click on the button "Finish".

8.5.3 RAID1 system (optional)

This is a RAID1 system configuration (mirroring with two hard disks). This configuration enhances system availability as the system is able to continue operation if a hard drive fails, or if there is a cable problem at a channel.

The two hard disks are configured as follows in the factory state of the device:

RAID1 system
Partition C: System, NTFS, 20 GB
Partition D: Data, NTFS, remaining capacity

Note

You can find information regarding Intel RAID controllers in the RAID documentation on the included "Documentation and Drivers" CD in the Drivers\RAID\Intel directory.

```
Intel(R) Matrix Storage Manager option ROM v5.6.2.1002 ICH7R wRAID5
Copyright(C) 2003-06 Intel Corporation. All Rights Reserved.

RAID Volumes:
ID Name Level Strip Size Status Bootable
0 Volume0 RAID1(Mirror) N/A 149.1GB Normal Yes

Physical Disks:
Port Drive Model Serial # Size Type/Status(Vol ID)
0 ST3160815AS 5RA01YJT 149.1GB Member Disk(0)
2 ST3160815AS 5RA01YHY 149.1GB Member Disk(0)

Press <CTRL-I> to enter Configuration Utility...
```

Figure 8-9 Example

RAID system management functions

The pre-installed RAID system software offers enhanced functionality for RAID system operation and management. Start the SW by selecting the "Start > Programs > Intel Matrix Storage Manager" command.

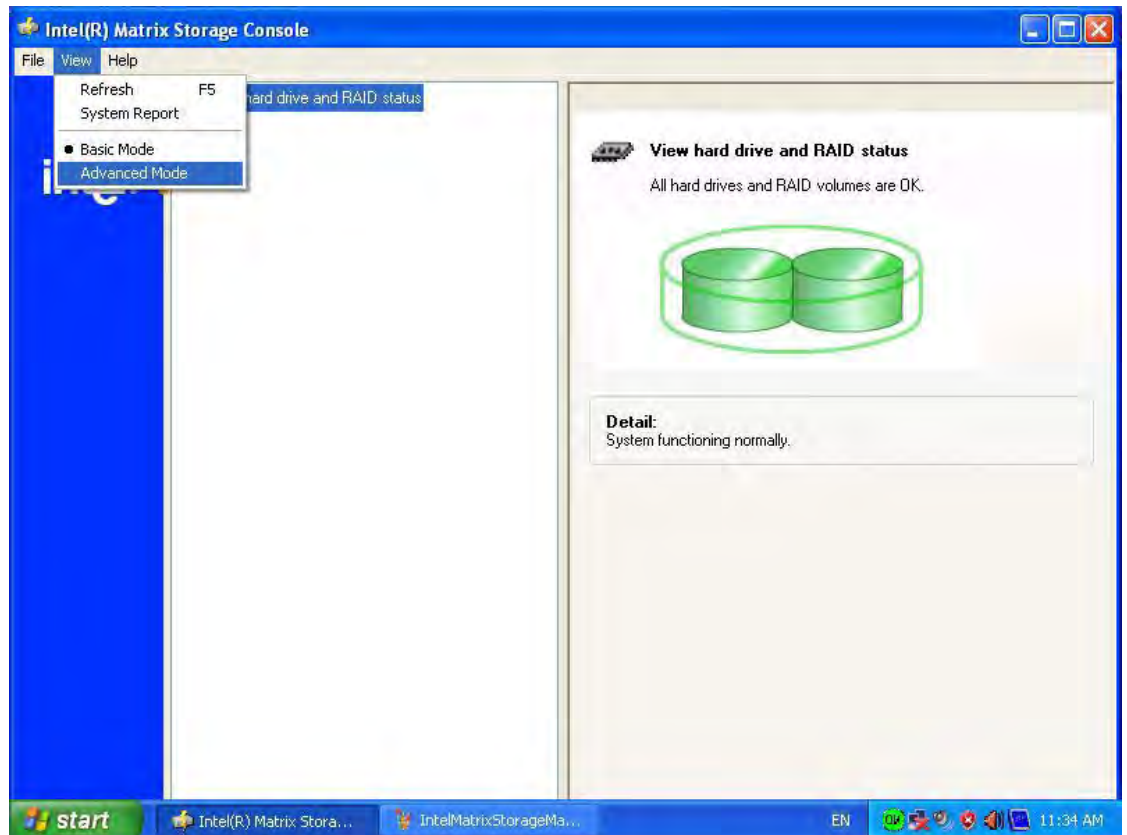

Figure 8-10 Example

The "View -> Advanced Mode" command returns details of the RAID volumes.

The command "View -> System Report" can be used to create a report with details of the RAID volumes.

NOTICE

The RAID status entries are returned by default in the Windows event view and in the log file of the program.

A hard drive can be synchronized at operating system level if a fault is detected. It may take up to several hours to synchronize a new disk in the background, depending on the size of the hard disk and on the system load.

The redundant system state RAID 1 is reached again only after synchronization is completed.

Comments about faults

NOTICE
Input delay System load may briefly increase due to synchronization when a hard disk has failed, depending on processor load and current hard disk activity. In extreme cases, input from the keyboard and touch screen may be delayed for a brief period.

8.5.3.1 Replacing a defective drive in the RAID system

Replace defective RAID drives with a new drive in order to recover secure RAID1 state. The RAID software reports the defective drive and returns details of the operable hard drive.

The functioning hard drive is indicated in BIOS by its port number, or by the RAID software by its device port number.

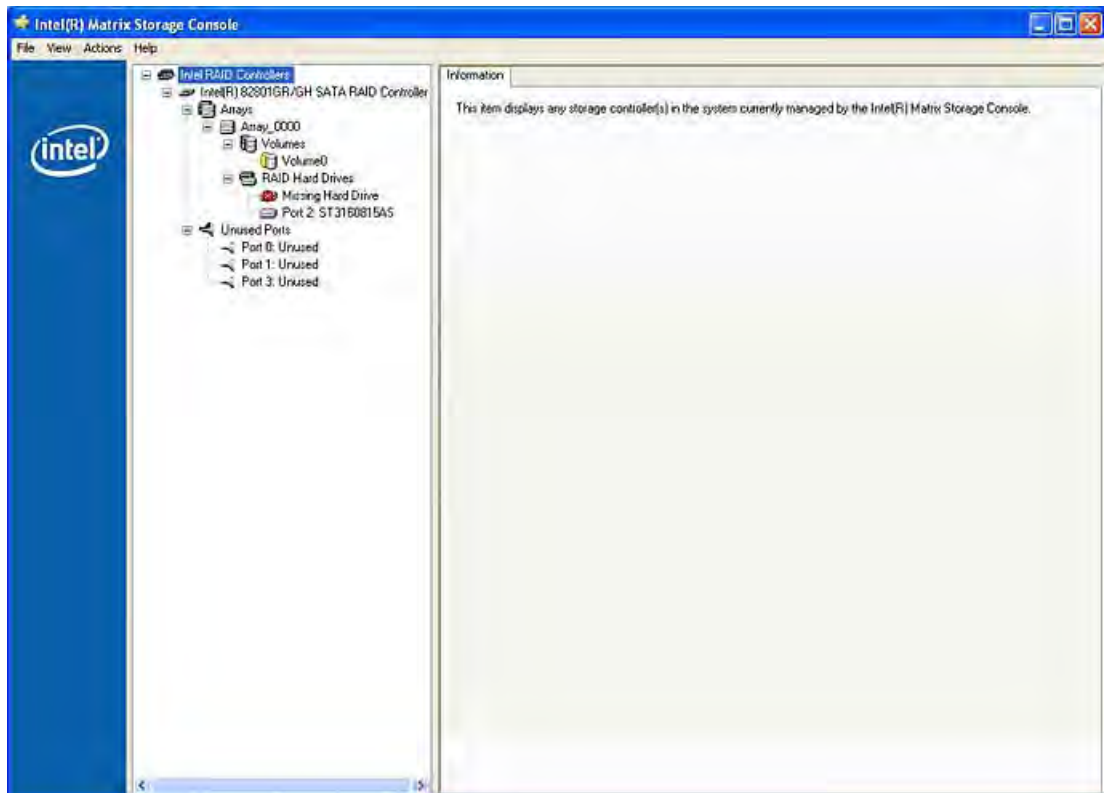

Figure 8-11 Example

Always replace the defective drive with a new one of the same type and capacity.

To be able to boot from the RAID system, you must place this first in the list of bootable sources in the BIOS "Boot" setup menu. Otherwise the system will boot from the hard disk you have just installed and the message "Operating system not found" will be displayed.

NOTICE

The new HDD can be integrated into the RAID system at operating system level by means of the RAID software. Synchronization may take several hours, depending on system load.

Integrating a new hard drive

Select the "Rescan for Plug and Play Devices" command to find and indicate the new HDD. You can also choose to reboot the device. In this case, the RAID software automatically integrates the new HDD and synchronizes the RAID system.

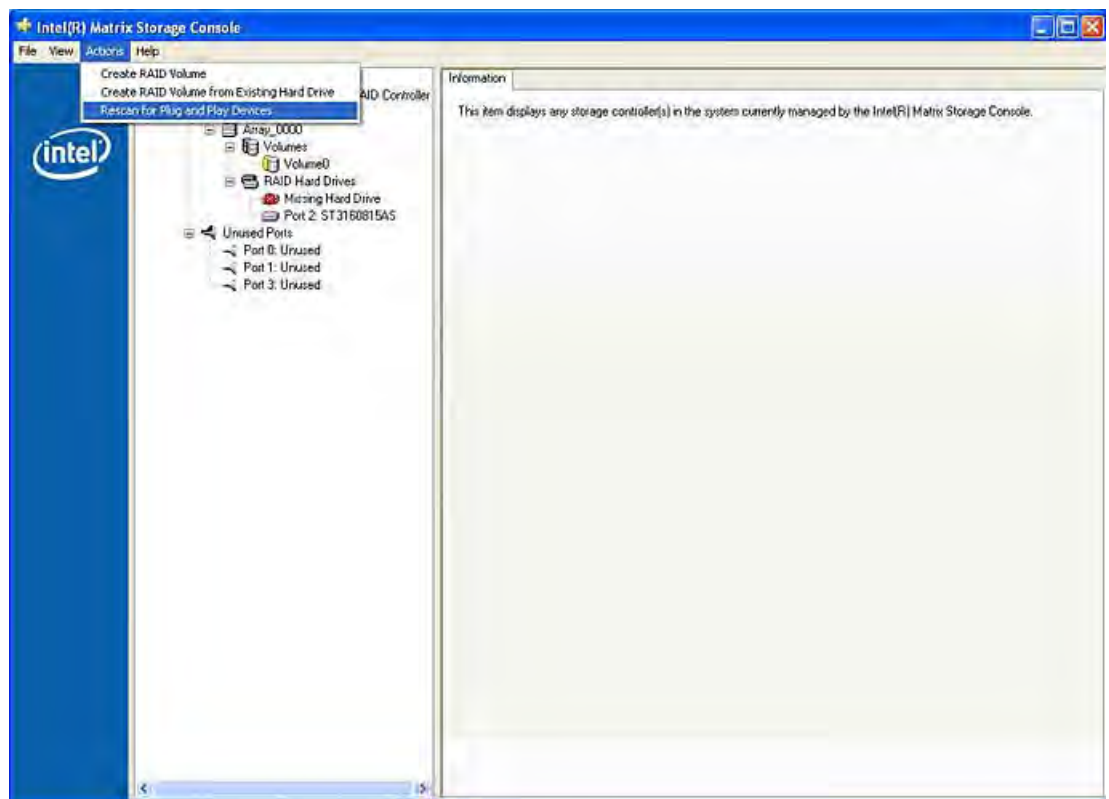

Figure 8-12 Example

NOTICE

BIOS messages during startup

At the first restart / cold start following a hard disk failure or installation of a new hard disk (servicing), the RAID BIOS reports that the RAID functionality is no longer available and offers the appropriate operator options.

The "Rebuild to this Hard drive" command initiates synchronization of the RAID1 system.

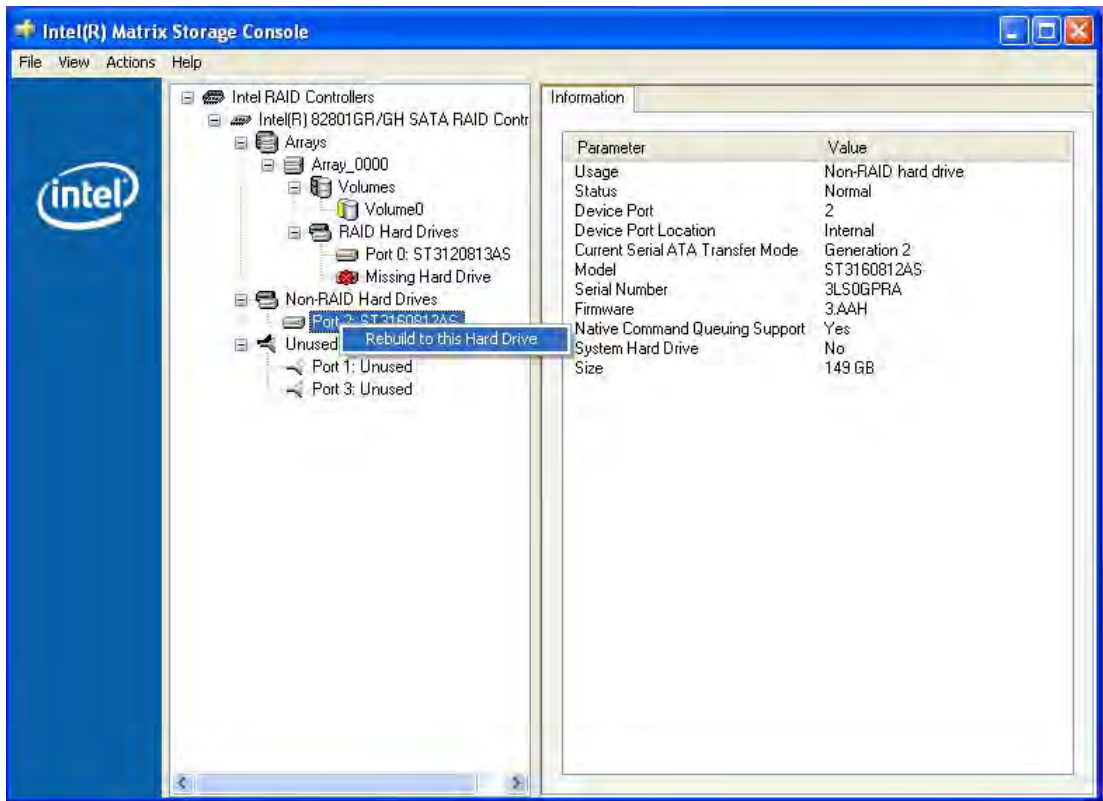

Figure 8-13 Example

NOTICE

The "SIMATIC PC DiagMonitor" diagnostics and alarm software also provides information about the RAID status. This software only needs to be installed once - logons are not required. The diagnostics and alarm software "SIMATIC DiagMonitor " is available as an accessory.

Notes for RAID configuration with installed SIMATIC PC DiagMonitor software

When creating a RAID-system where SIMATIC PC DiagMonitor software is being used, the Intel Matrix Storage Console may abort the process with the following error message:

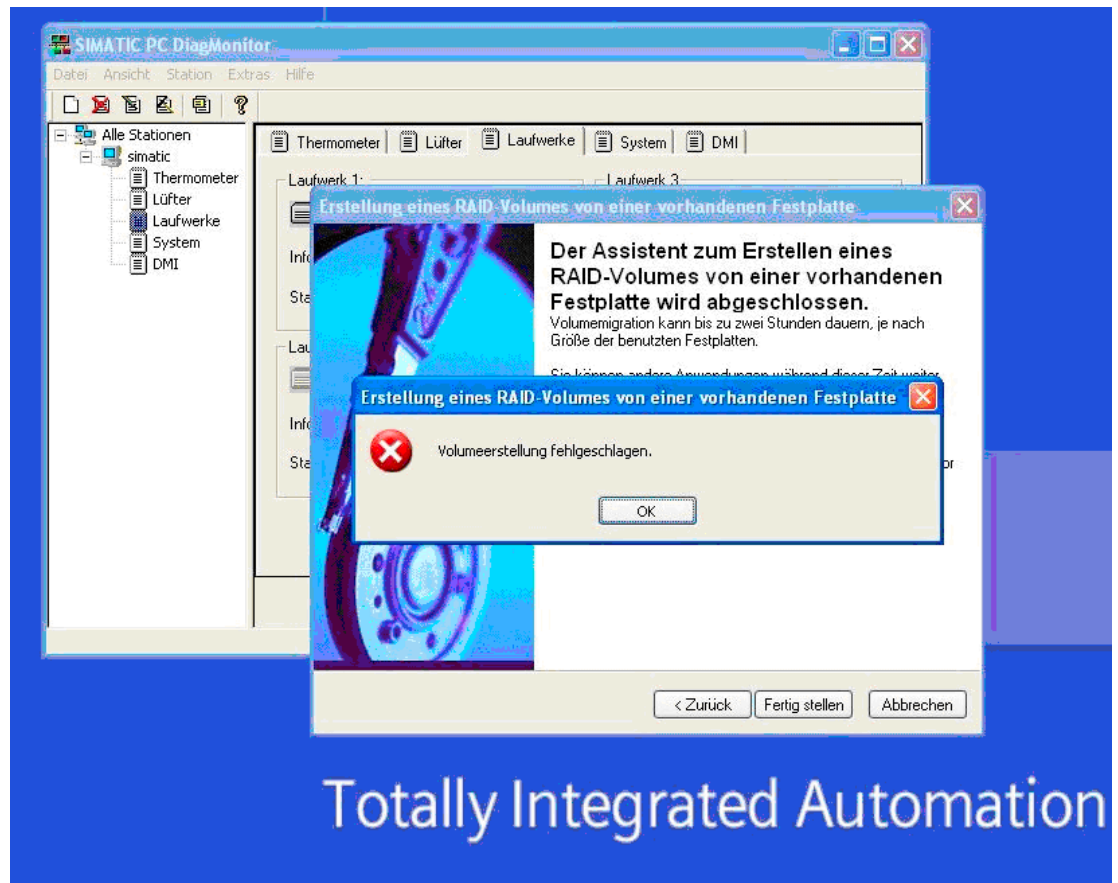

Figure 8-14 Example

Solution:

Before performing a RAID commissioning, the SIMATIC PC DiagMonitor should be deactivated. Subsequently, it can be reactivated.

Measures:

If the DiagMonitor Management Station is in operation on your device:

- Close all applications, also the Management Station.
- Afterwards, stop the DiagMonitor SNMP Agent (SOL-Agent). In order to do so, select **Start > Run** and enter `cmd` in the field.
- Afterwards, enter `Net stop snmp` and confirm with the Enter key.

If your device is remotely monitored with SIMATIC PC DiagMonitor:

In this case you need **only** stop the DiagMonitor SNMP Agent (SOL-Agent).

- In order to do so, select **Start > Run** and enter `cmd` in the field.
- Afterwards, enter `Net stop snmp` and confirm with the Enter key.

NOTICE

If you do not adhere to the procedure described above, a correct RAID configuration cannot be guaranteed.

8.6 BIOS settings

The BIOS setting "USB legacy Support" is enabled by default. Thus, the complete functionality of a USB keyboard is available prior to starting up Windows. You can also adjust the BIOS settings with the USB keyboard.

Note

To edit the BIOS on an operator device equipped with a touch screen, connect a USB keyboard.

8.7 USB

Introduction

Commercially available USB peripherals can be easily and flexibly connected via the USB interface. For example, you can connect an external USB keyboard and a USB mouse. If the USB keyboard has a USB interface, you can connect other USB peripherals, such as a USB mouse, directly to the keyboard.

USB interface

There are several types of USB peripherals:

- Low power devices: maximum 100 mA power consumption, e.g. mouse and keyboard
- High power devices: maximum 500 mA power consumption, e.g. hard disk with a separate power supply and floppy drive

Note

The general USB specifications apply to the USB interfaces on the computer unit.

The USB interface on the control panel has been approved for a maximum of one additional USB hub.

Using USB peripherals

NOTICE
When installing a USB device for the first time, make sure you have the required device driver. Before removing an intelligent USB device, deactivate the device in the operating system using the dialog "Unplug or Eject Hardware". For additional information, refer to the documentation for the operating system.

Operation and configuration

9.1 Normal operation

9.1.1 Switching on the device

Requirement

- The peripheral devices are connected.

CAUTION

To comply with the EMC guideline of the device with I/O, ensure that the manufacturer or supplier of the components used guarantees compliance with the regulations. Connect the I/O devices via shielded cables with metal connectors. In doing so, the shield must be connected over a wide area with the metal connector and the connector must be firmly connected with the device housing.

- The operating system and the service packs have been installed and set up on the hard disk of the device. Refer to the "Commissioning" chapter for more information.
- The pre-installed drivers and applications have been set up appropriately. Further information is available in the "Operation and configuration" chapter in the section, "Additional drivers and applications."
- The proper ambient and environmental conditions according to the specifications for the device and the connected I/O modules have been observed.

Procedure

WARNING

Danger of incorrect operations!

The following applies to external input devices or combinations of external input devices and control units with key panels: Ambiguous key codes can cause serious malfunctions of the application program.

Always activate the "Security features" of "KeyTools." Please note the applicable safety information in the "Operation and configuration" chapter in the section, "Additional drivers and applications."

CAUTION

The device must not be switched on if there is condensation. Switch it on only after it has been stored in a (heated) room for at least 12 hours for temperature adjustment.

1. Connect the AC device to a socket with protective conductor with a cable suitable for the application. You connect the DC device to your 24 V DC power supply using the supplied special connector.
2. Switch on the power switch of the device.

The "POWER" LED will light up. The device is now in operation and booting.

CAUTION

Risk of data loss!

Do not switch off the power supply when the device is in operation. Disconnect the power only after the device has been correctly shut down.

After switching on the power supply, the device performs a self-test. During the self-test, the message "Press <F2> to enter SETUP" appears briefly.

When the self-test is finished, the operating system will be loaded and the desktop will be displayed.

The booting process has been completed successfully.

9.1.2 Logging on to the operating system using the on-screen keyboard

The logon dialog is displayed when you have assigned an administrator password.

Note

An on-screen keyboard (OSK) appears for devices with touch screen panels. You can enter the administrator password directly on the touch screen using the screen keyboard or using the mouse. For additional information, refer to the Microsoft help on screen keyboards.

9.1.3 Switching off the device

Procedure

1. Shut down the operating system.

CAUTION
When using the operating systems Windows 2000 Professional, Windows XP Professional or Windows XP Embedded, wait until the display has turned dark.

2. Switch the device off using the On/Off switch.
3. In order to isolate the power supply completely, turn off the power at the power supply switch and pull out the plug from the device.

 WARNING
Always pull out the plug to isolate the device from the mains. In the case of the direct key module, make sure the keys of the membrane keyboard that are configured as direct control keys remain operable until the voltage of the entire device has been switched off.

9.2 Additional drivers and applications

The necessary drivers and applications are available on the supplied "Documentation and Drivers" CD.

Note

The supplied drivers and applications have been system-tested and are approved for this device. No warranty can be provided for other software.

Press the "Help" button to obtain information concerning the buttons of a dialog.

9.2.1 Touch screen calibration

Procedure

1. Select "Start > Programs > UPDD > Settings".
The "UPDD Console" dialog box opens.

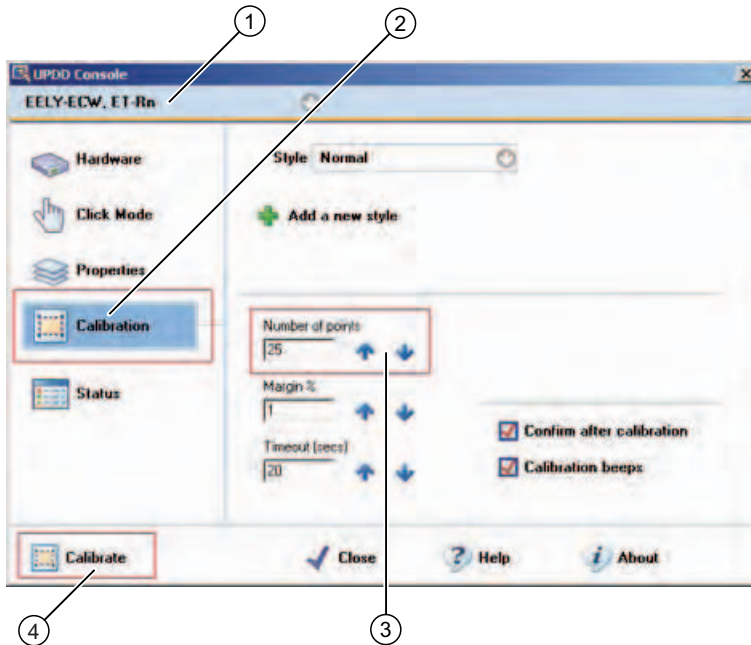

Figure 9-1 Point calibration

2. Select the screen (1) you wish to calibrate.
3. Click on "Calibration" (2).
4. Activate "25-point calibration" (3).
5. Click on "Calibrate" (4).
The calibration mask is output on the selected display.
6. Touch the blue arrow.
The input is confirmed by a tick, and the next arrow is displayed.
7. Confirm all input prompts (arrows, or crosses in the center) until the complete screen has been calibrated.

Note

If the touch screen does not react as expected when touched, repeat the calibration.
Only an active screen can be calibrated. An active screen is displayed in black, and a deactivated screen in red.

9.2.2 Activate touch functionality

Procedure

1. Select "Start > Programs > UPDD > Settings".
The "UPDD Console" dialog box opens.

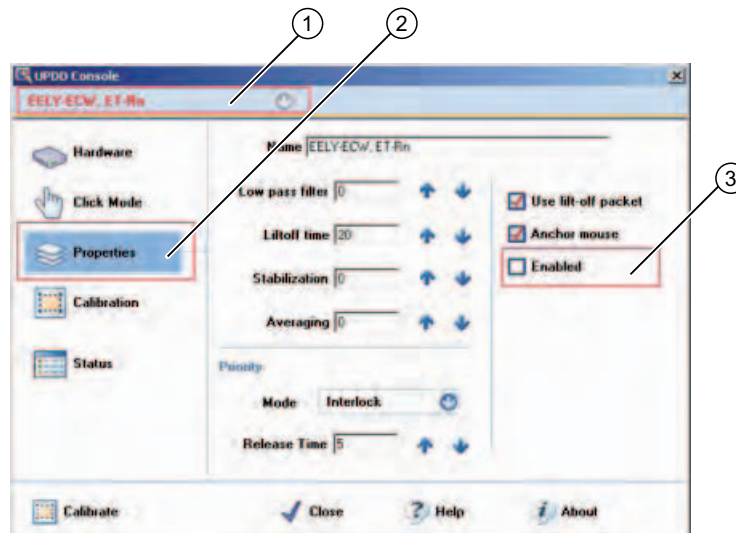

Figure 9-2 Activate touch functionality

2. Select the corresponding screen ①.
3. Set a tick in the "Enabled" ③ option box in the "Properties" ② tab.
The screen is activated.

9.2.3 Deactivate touch functionality

Description

It is possible to deactivate the touch functionality, e.g. if you wish to clean the screen.

Procedure

1. Select "Start > Programs > UPDD > Settings".
The "UPDD Console" dialog box opens.

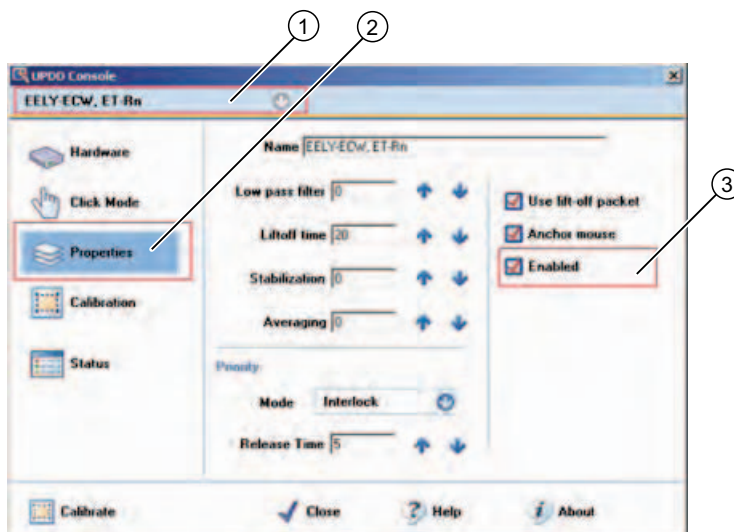

Figure 9-3 Deactivate touch functionality

2. Select the screen ① you wish to deactivate ①.
3. Remove the tick in the "Enabled" ③ option box in the "Properties" ② tab.
The screen is deactivated.

Note

If you only require the screen for a short time, leave the dialog box open.
If you close the dialog box using "Close", the functionality remains deactivated.

9.2.4 Windows Security Center (Windows XP Professional / Windows XP Embedded)

Call

Select "Start > Settings > Control Panel > Security Center".

Function

The Windows Security Center has the following functions with the corresponding defaults:

Function	Default setting
Firewall	on
Automatic updates	Off
Virus protection	Off
Alarms	on

The default settings can be activated and deactivated.



Figure 9-4 Windows Security Center

Alarms

Click on "Change the way Security Center alerts me" to switch off security alarms upon switching on the device. The "Alert Settings" dialog appears. Deactivate the desired alarms.



Figure 9-5 "Alert Settings" dialog

9.2.5 KeyTools (for key panel devices)

SIMATIC KeyTools is one selection of the applications for your Panel PC. These applications allow you to adapt key codes that are sent by the key panel of the control unit. SIMATIC KeyTools consists of the following applications:

- Key code table: Loading and editing of key code tables
- WinCC hotkey function: WinCC hotkey function activation and deactivation
- Security features: Lock function that prevents two function keys from being activated simultaneously. This prevents incorrect operations and undefined states of the user program.

Note

For a detailed description of the SIMATIC KeyTools, refer to the help menu and the application description on the "Documentation and Drivers" CD.

Calling up KeyTools

1. Select "Start > Settings > Control Panel > SIMATIC KeyTools".
2. Select the desired application and follow the instructions on the screen.

NOTICE
Malfunctions of the user software
For security reasons always use the "Security features". If you deactivate it nevertheless, serious malfunctions of the user software may occur when the additional function keys and softkeys F11 to F20 and S1 to S16 are used or if own key code tables are used.

9.2.6 On-screen keyboard (for touch panel device)

You can operate the device by means of a virtual screen keyboard. You can use it to enter the characters directly on the touch panel or with an externally connected mouse.

Call "Touch input"

Start the "Touch input" application on the desktop. The screen keyboard is displayed.



(1) Button for language selection: German, English, Italian, Spanish, French

9.2.7 Panel PC Tools

The program installs program interfaces for the Panel PC. It covers three software applications:

Controlling backlit display



Controlling backlit display using the screen saver



Controlling LEDs on the key control panel

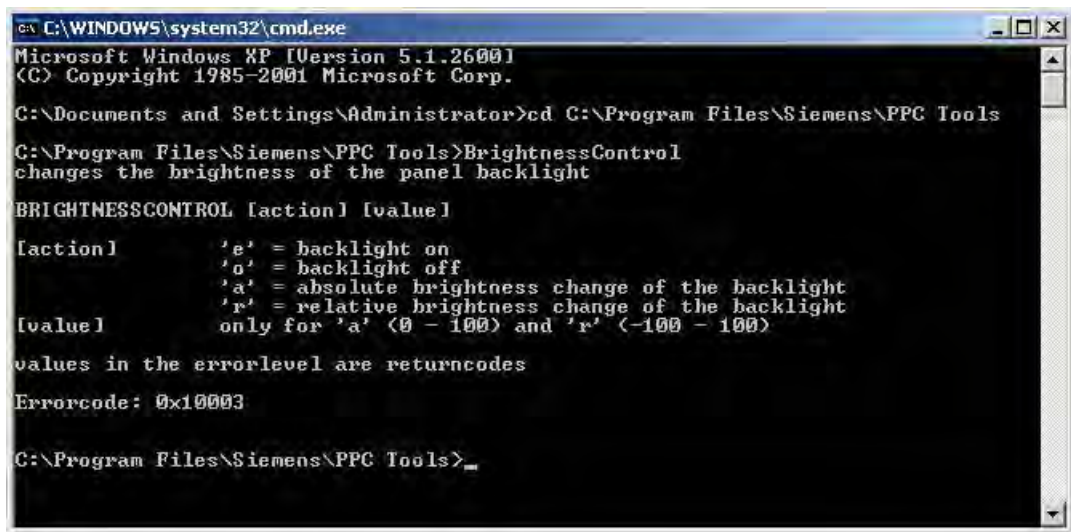

9.2.8 CheckLanguageID

Scope

The following applies to Windows 2000 Professional MUI and Windows XP Professional MUI.

Call

"c:\drivers\checklang\checklangid.exe" or reinstallation from the "Documentation and Drivers" CD.

Function

"CheckLanguageID" displays the currently installed languages.



Figure 9-6 CheckLanguageID

- SystemDefaultLangID: System language
- UserDefaultLangID: Standard language
- UserDefaultUILangID: User interface language

NOTICE

All three languages displayed should have the same ID assigned.

9.2.9 Multilingual settings for the operating system

Windows MultiLanguage MUI operating system enables users to set the language of the GUI to their individual preference. Some elements are not localized, however, and remain in the original language of the system - English.

You should therefore always install English language service packs. Further information about the language of the GUI, regional settings and inputs is available in the Internet at <http://support.microsoft.com>.

Setting up the language selection for Windows 2000 Professional

The Multilanguage User Interface (MUI) allows you to set up the Windows 2000 Professional menus and dialogs for additional languages.

To set the required languages for the Windows 2000 Professional menus, dialogs and keyboard layout, select:

"Start > Settings > Control Panel > Regional Options", "General" tab, "Menus and dialogs" field and "Language settings for the system" field and the "Keyboard layout" field in the "Input Locales" tab.

In addition to the menu and dialog language settings, you also need to set the default language for the region by selecting "Set default..." from the regional options.

The default language setting of your Windows 2000 Professional installation is English and a US keyboard layout. To change to another language and keyboard layout, open the Control Panel and select:

Start > Settings > Control Panel > Regional Options > "General" tab, "Menus and dialogs" field and "Language settings for the system" field and the "Input language" field in the "Input Locales" tab.

Setting up the language selection for Windows XP Professional

The Multilanguage User Interface (MUI) allows you to set up the Windows XP Professional menus and dialogs for additional languages.

Default language of your Windows XP Professional MUI installation is English and a US keyboard layout. You can change the language in the Control Panel.

"Start > Control Panel > Date, Time, Language, and Regional Options > Add other languages" "Languages" tab, "Language used in menus and dialogs" field.

For the "Date, Time, Language, Regional Options" set the default as "non-Unicode programs" under "Advanced" in addition to the language for menus and dialogs.

9.2.10 DVD burner

The drive of the DVD burner is installed optionally. Recording methods supported by the disk drive: "Disc at once", "Track at once", "Session at once", "Packet writing", whereby "Disc at once" and "Track at once" are recommended due to their compatibility to other optical drives.

Software

In order to utilize full functionality of the DVD drive, you need to install additional software. This software is included on the CD supplied with the device. Insert the CD in the drive, run setup and follow the instructions on the screen.

Information on burning CDs or DVDs

CAUTION
Danger of data errors when burning CDs or DVDs
Burning is permissible only in an undisturbed environment, i.e. shock and vibration stress must be avoided. Because of heavy fluctuation in the quality of CD-Rs, data may be corrupted in a burning session, even if no error message is initially displayed. The written data can only be verified by comparing these with the source. To be on the safe side, data should be verified after every burning session. When backing up an image, the data should be restored to the hard disk and the system should be rebooted from the hard disk.

9.2.11 USB keyboard controller

The USB keyboard controller supports the following additional functions for key models:

- Keyboard programming with the "KeyTools" application
- Adjustment of the backlighting brightness with the application "SetBrightness."
- Control of the key LEDs

The USB keyboard controller must be installed before this function can be used. You can find details about the installation on the "Documentation and Drivers" CD.

Operation

10.1 Status indicators

Operating status

The two LEDs on the upper left hand side of the control panel display the operating status:

- LED "POWER" green: Active voltage
- LED "TEMP" orange: Temperature threshold exceeded. The maximum temperature threshold is preset and cannot be changed.

Refer to the "Functions" chapter for more information.

PROFINET

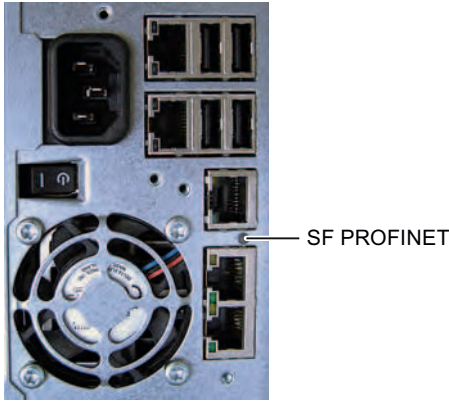
PROFINET status display			
			
Display	Meaning	LED	Description
SF PROFINET (optional)	Status display for CP 1616 onboard	OFF	<ul style="list-style-type: none"> CP not available CP disabled No error, communication established Charging in progress
		Flashes slowly	<ul style="list-style-type: none"> Link status error IO Controller: IO Device cannot be addressed IO Controller: Duplicate IP address
		Flashes rapidly	Exception error: diagnostics via web or SNMP is no longer possible
		AN	<ul style="list-style-type: none"> Diagnostics information available No communication established.

Virtual status displays			
The two "virtual" CP 1616 LEDs are only visible in the SIMATIC software and can be read via SNMP.			
PROFINET	Virtual LEDs	RUN	CP is active
		STOP	CP is in the stop state
		Flashes	The states "flashes slowly" or "flashes rapidly" do not exist.

10.2 General control elements

On / Off switch

On / Off switch	Description
 <p>The image shows the rear panel of a SIMATIC Panel PC 677B. A red circle highlights the On/Off switch, which is a small, rectangular component located below the 'COM1' and 'COM2' ports. Other visible components include a fan, various ports (Ethernet, USB, DP), and a 'BY/TOG' switch.</p>	<p>The On/Off switch does not disconnect the device from supply voltage. When the switch is in 0 position (Off), the device is still connected to the auxiliary voltage.</p>

⚠ WARNING

The On/Off switch does not disconnect the device from supply voltage.

10.3 Device with key panel

10.3.1 Safety

NOTICE
Maloperation If you activate several keys simultaneously, a malfunction on the device cannot be excluded. Activate function keys and softkeys only in sequence!
Malfunctions of the user software For security reasons, always use "Security features" of the KeyTools. If you deactivate it nevertheless, serious malfunctions of the user software may occur when the additional function keys and softkeys F13 to S16 are used or if own key code tables are used.
Risk of damage Activating a key using a hard or pointed object, for example a screwdriver, reduces the life of the key or can damage it.

10.3.2 Overview

Overview

The number of keys, their labeling and function is the same on all key panels. The various panel types differ in the arrangement of the keys and in the size and type of the display.

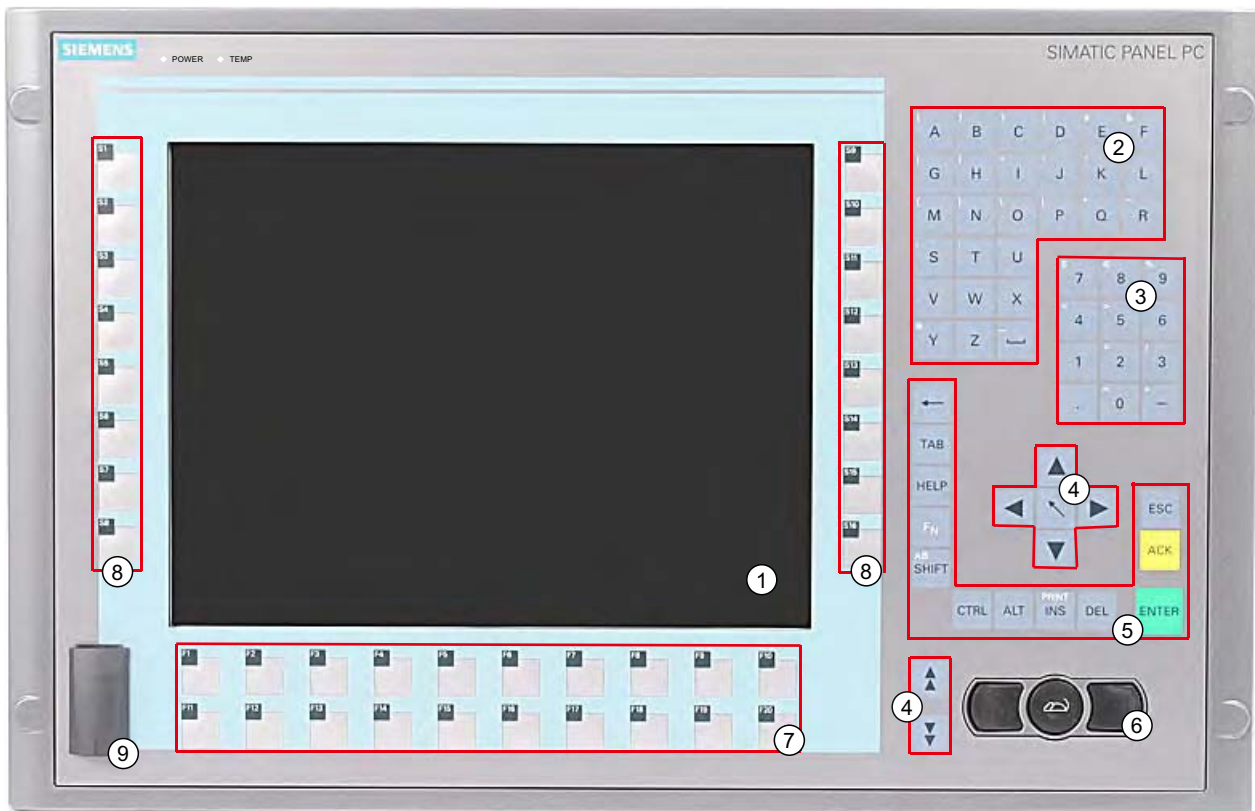

Figure 10-1 Example of a 12" key panel

- (1) Display
- (2) Alphanumeric keys
- (3) Numeric keys
- (4) Control keys
- (5) Cursor keys
- (6) Integrated mouse
- (7) Function keys
- (8) Softkeys
- (9) USB ports (optional)

10.3.3 Keys

10.3.3.1 Control keys

Control keys

The control keys activate editing functions and control functions in different applications:

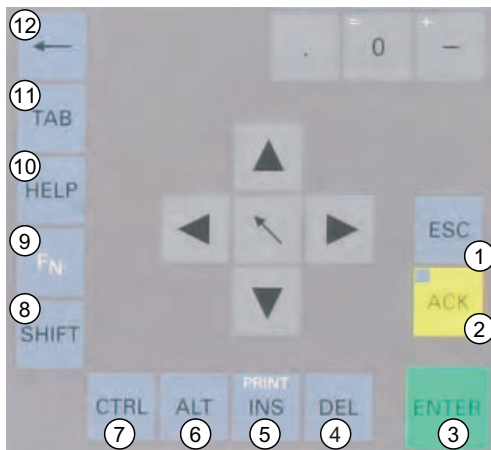

Figure 10-2 Control keys

- (1) Cancel
- (2) Acknowledge
- (3) Enter
- (4) Delete
- (5) Insert/Print screen (in combination with FN)
- (6) Application-specific function key codes (see key code table in appendix)
- (7) Application-specific function key codes (see key code table in appendix)
- (8) Toggling between lower-case letters and upper-case letters
- (9) Function key
- (10) Call Help
- (11) Tabulator
- (12) Backspace

10.3.3.2 Alphanumeric and numeric keys

Alphanumeric keys

Enter letters, special characters, blank spaces and underline using the alphanumeric keys.

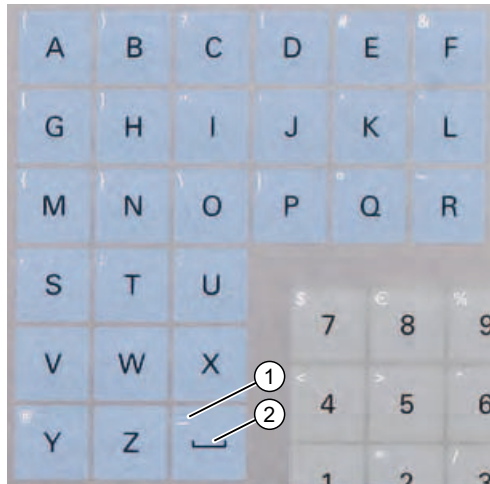

Figure 10-3 Alphanumeric keys 2

- (1) Underline
- (2) Space character

toggling between lower-case and upper-case letters

Enter the lower-case letters using the pre-defined assignment of the alphanumeric keys. To enter an upper-case letter, proceed as follows:

1. Hold down the <Shift> key.
2. Activate the desired alphanumeric key at the same time. The displayed upper case letter will be entered.
3. To enter lower case letters, release the <Shift> key.
4. You can, however, also activate the Caps Lock function using the <FN> and <Shift> keys. The LED on the <Shift> key is then also lit.

Numeric keys

Enter the numerals "0" to "9" and special characters, e.g. the decimal point, using the pre-defined assignment of the numeric keys.

Enter special characters, arithmetic signs and signs

Special characters, arithmetic signs and signs are also assigned to most of the alphanumeric and numeric keys. These signs are indicated by white symbols on the top left of the keys. To enter such a sign, proceed as follows:

1. Hold down the <FN> control key.
2. Activate the desired alphanumeric or numeric key at the same time. The displayed special character, arithmetic sign or signs will be entered.
3. To enter the signs of the pre-defined assignment again, release the <FN> key.

10.3.3.3 Cursor keys

Navigate, scroll or move the writing mark using the cursor keys. The cursor keys correspond to the usual keys of the PC keyboard.



Figure 10-4 Cursor keys

- (1) <Left> key
- (2) <Up> key
- (3) <Right> key
- (4) <Down> key
- (5) Position 1 key (Home)
- (6) <Page up> key
- (7) <Page down> key

10.3.4 External keyboards

The keyboard layout has been set to "English/USA international." If you use a keyboard with a layout other than the "English/USA international" layout, the key codes of the internal and external keyboards might no longer correspond.

10.3.5 Using the direct control key module

The direct control key module is a module that is intended for use with the SIMATIC Panel PC 677B (exclusively for variants with an integral membrane keyboard). Digital events can be assigned to the function keys and softkeys (F1 to F20 and S1 to S16) of the membrane keyboard via this module. This means that a digital input of a PLC can be activated at the press of a key over PROFIBUS. The module is implemented as a PROFIBUS DP slave.

Functionality

The direct control key module is used to expand the functional scope of the SIMATIC Panel PC 677B with the following features:

- Up to 32 function keys/softkeys on the membrane keyboard of the Panel PC can be scanned over PROFIBUS as direct keys.
- Up to 16 additional keys from an external control panel can be connected if required.
- There are 16 digital outputs for activating checkback signal lamps (by the PLC over PROFIBUS DP) in external control panels.

All direct control keys can be scanned over PROFIBUS DP from the PLC.

Software control

The direct control keys on the Panel PC are programmed using the "Key pad" software tool. The codes for all keys of the Panel PC 677B can be changed using this tool. It can also be used to assign the direct control key functionality to all function keys and softkeys of the Panel PC. The "Key Pad" software for the direct control key module is supplied on a floppy disk and on the "Documentation and Drivers" CD for the Panel PC 677B.

Assembly

The direct control key module can be ordered separately from the Panel PC. It can be retrofitted in the immediate vicinity of the Panel PC: Either on a standard mounting rail (the mounting equipment required is included in the package with the direct control key module) or directly using four screws on a wall /front panel / control panel. Detailed mounting instructions are included with every direct control key module on paper and with every Panel PC 677B on the "Documentation and Driver" CD.

Example:

The keyboard codes, that are sent when any key is operated, are stored in a code table. The initial status of the table is as follows:

Table 10-1 Keyboard codes

Keys:	Keyboard code:
All standard PC keys	"English international"
Additional keys for Panel PC 677B	
F13 to F20	SHIFT+F1 ... SHIFT+F8
S1 ... S4	SHIFT+F9 ... SHIFT+F12
S5 ... S16	CTRL+F1 ... CTRL+F12

This default setting for additional function keys corresponds to the specifications required for using the keys (for example, from the HMI software package SIMATIC WinCC flexible).

Changing the defaults

The program "KeyPad.exe" can be used to assign each key individually with special key codes.

After starting the "keypads15.exe" program, the following layout of the 15" key panel is displayed on the Panel PC:

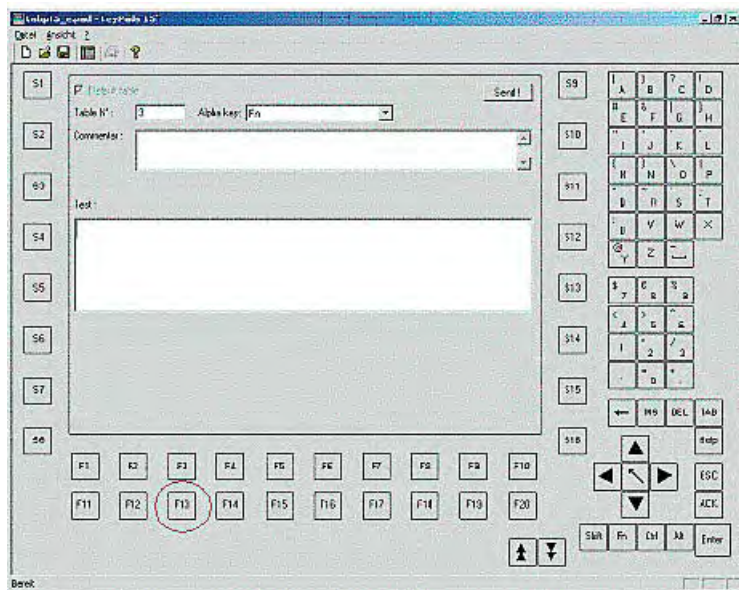

Figure 10-5 Keypad

The individual key fields can be clicked to open a configuration form for the respective key. In the example, the form for standard assignment of the F13 key is shown:

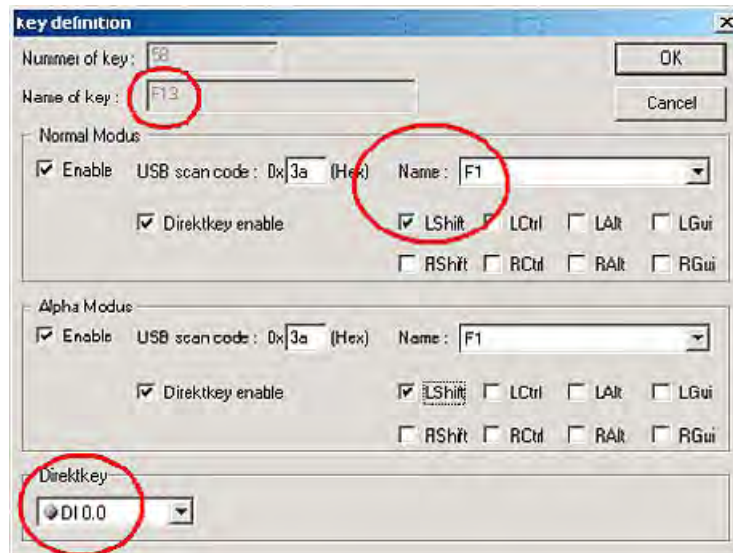

Figure 10-6 Standard assignment of the F13 key

Explanation:

The key labeled <F13> outputs the key code <LSHIFT+F1> and sets digital input DI 0.0 when the direct key module is used.

Refer to the following Internet site for more details about the use of the tool. Enter "Keypad" as the search term under "download".

<http://www.siemens.com/asis>

You can find more comprehensive information about using the additional function keys in German and English in the file "F_KEY_Total.exe".

10.3.6 Labelling function keys and softkeys

Scope

This section applies only to control units with key panels.

Introduction

The control unit has two horizontal and two vertical keypads. Assign user specific functions to the keys as needed. Label the keys with labelling strips from the accessories.

Note

The device is supplied with a sheet of labeling strips.

⚠ CAUTION
Labeling Label the function keys and softkeys to conform with the project. Labeling without reference to a project leads to incorrect operations on the system to be observed.

Procedure

1. Label the DIN A4 film with a laser printer, for example, using the print format templates for MS Word on the "Documentation and Drivers" CD.
2. Cut the labeling strips along the pre-printed lines.

Note

Do not insert handwritten labeling strips until the ink has dried.

3. Insert the labeling strips into the slots provided from the rear side of the control unit.

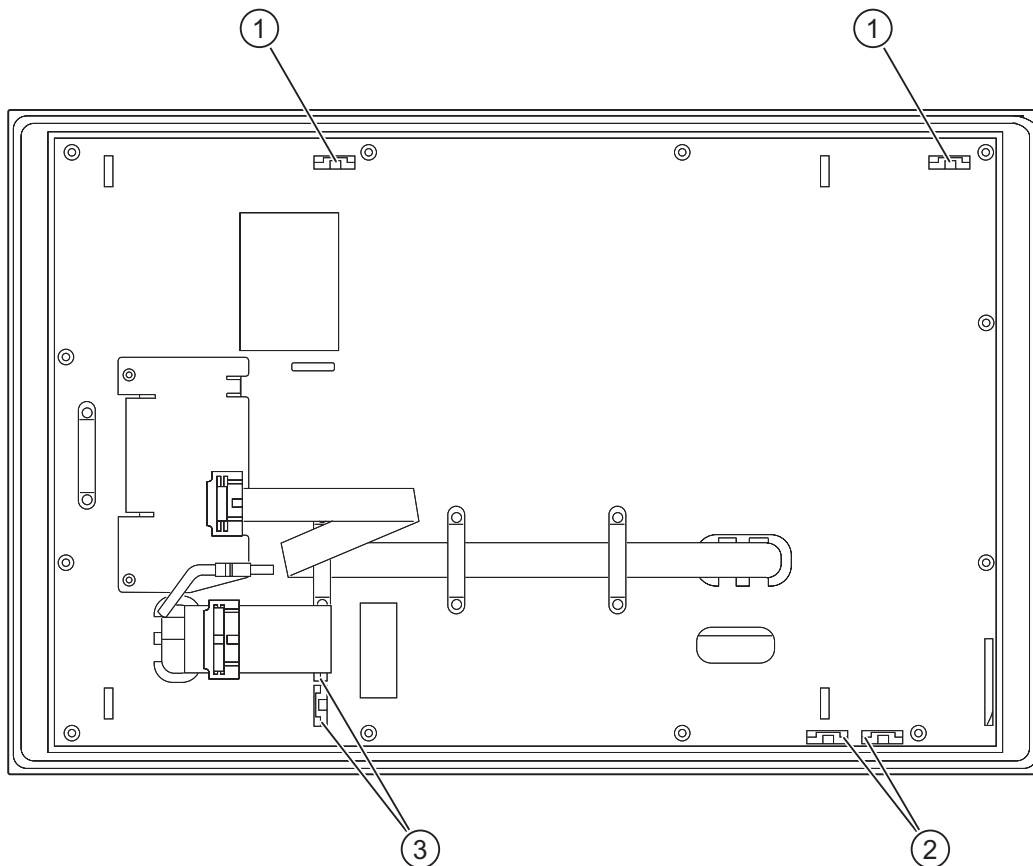

Figure 10-7 Rear side of the control unit with connections and slots for the labeling strips for the example of a 12" touch panel front.

- (1) Slots for long labeling strips, vertical keypads
- (2) Slots for short labeling strips, horizontal keypads
- (3) Slots for labeling strips, horizontal keypads

10.3.7 Using the integrated mouse

The position on which you press the middle round button of the integrated mouse determines the direction in which the cursor moves. The amount of pressure determines the speed of the cursor.

Alternatively to using the integrated mouse you can also connect an external mouse to the front USB port.



Figure 10-8 Integrated mouse

10.4 Device with touch panel

The individual variants differ in their dimensions and size of the display.

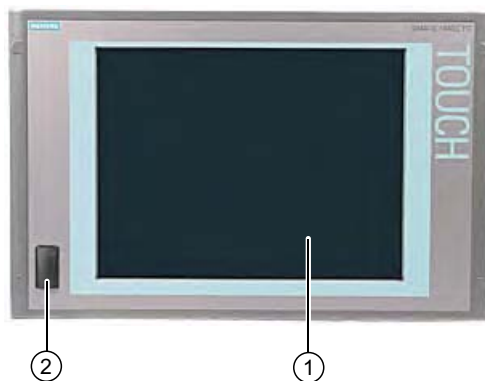

Figure 10-9 Example of a 15" touch panel

- (1) Display with touch panel
- (2) USB ports (optional)

10.4.1 Operating a touch panel

On the display that is touch-sensitive due to the touch sensor, application-specific user interface elements, for example buttons, are displayed. When you tap the command button with your finger, the function assigned to the button is activated.

The following types of pressure are permissible:

- Using a plastic pen with a 1 mm radius at the point: 25 g.
- Using a silicone finger with a diameter of 1.6 cm: 50 g.

CAUTION
Only touch one point on the touch panel and not several points at one time. You may otherwise trigger unintended reactions. Do not touch the screen in the following situations: - During the booting process - When plugging or unplugging USB components - While Scandisk is running

CAUTION
Damage to device from incorrect operation. Operate the touch panel with a finger or an approved pen. Never use hard or pointed objects.

Functions

11.1 Overview

Functions implemented:

- Temperature monitoring and over/under-temperature display
- Watchdog
- Fan monitoring

Messages of the monitoring modules can be transferred to applications.

The SOM software (Safecard On Motherboard) and DiagMonitor software on CD (optional) can be used to handle this functionality.

The DiagMonitor software CD contains the monitoring software, the software for the stations to be monitored, and a library for creating user-specific applications.

The description of the driver and the SOM program are available on the "Documentation and Drivers" CD.

11.2 Safecard on Motherboard (SOM)

Safecard on Motherboard (SOM)

This application is used to monitor PC hardware (temperature, watchdog and fans) and to display the current measured values. You can also configure the temperature and fan monitoring functions, and the watchdog function.

Your device is equipped with three temperature sensors, which are automatically detected by the application.

11.2 Safecard on Motherboard (SOM)

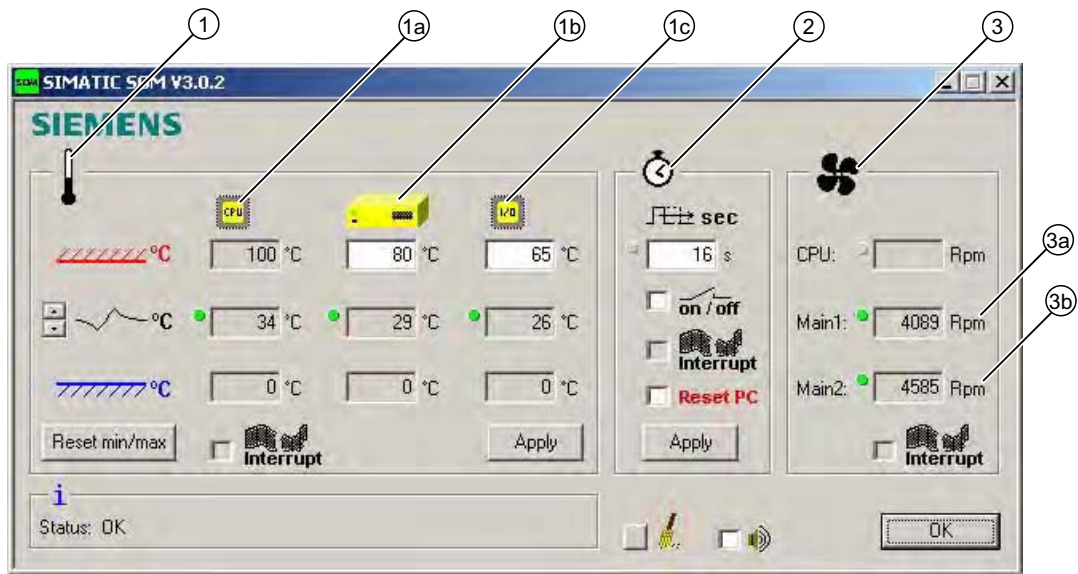

Figure 11-1 Safecard on Motherboard

(1)	Temperature range	Here the current temperature and limit values are shown. You can toggle the temperature display mode to indicate either the current temperature, or the min./max. values measured since the start of the application.	
		(1a)	Internal processor temperature
		(1b)	Device temperature beneath the power supply: upper threshold can be set from 40° to 80°C
		(1c)	Cooling air temperature surrounding the DVI connector: - depending on device 3°to 5°C higher than the ambient temperature - upper threshold can be set from 25°to 65°C
(2)	Watchdog range	Here, you can configure the watchdog function in your monitoring application. You can specify the watchdog time, activate a PC reset and activate / deactivate the watchdog.	
(3)	Fan area	You can read the current fan speed in this area.	
		(3a)	Fan speed in the area close to the processor
		(3b)	Fan speed on the power supply

For information on the SOM software, refer to the documentation on the "Documentation and Drivers" CD.

11.3 Temperature monitoring

The temperature is recorded by means of three thermocouples. One thermocouple monitors the processor temperature, another the temperature in the area near the power supply, and a third the air intake temperature next to the DVI port.

The following fault reactions are triggered if one of the temperature values exceeds the set temperature threshold:

Response	Option
Device and CPU fans accelerate to maximum speed.	None
SOM or DiagMonitor software is activated	None

The temperature error is retained in memory until temperatures have fallen below the thresholds and are reset by one of the following measures:

- Error acknowledgement in the SOM program (manually by means of the broom icon)
- Restart of the device

11.4 Watchdog (WD)

Function

The watchdog monitors program execution and reports a program crash to the user by means of various reactions.

The watchdog is idle when the PC is switched on or after a HW-RESET(cold restart), i.e., no reaction of the WD is triggered.

WD reactions

If the WD is not retriggered within the set time (by the driver or in the SOM program), the following reactions are triggered:

Response	Option
WD acknowledgement	None
Trigger a PC reset	Selectable
SOM or DiagMonitor software is activated	None

WD monitoring times (TWD)

The monitoring times can be set in increments of one second within a range from 3 to 255 seconds.

Note

The watchdog is retriggered if the monitoring time is changed at the active watchdog (that is while the watchdog is running)!

11.5 Fan monitoring

The function monitors operation of the enclosure and power supply fans. When a fan fails, the following reactions are triggered:

Response	Option
SOM or DiagMonitor software is activated	None

The temperature error is retained until the cause of the fan failure has been rectified and the error is reset in one of the following ways:

- Acknowledgement of the error message by means of the SOM program
- Restart of the device

Maintenance and service

12.1 Maintenance

Scope of maintenance

The device is largely maintenance-free. If the functioning of components, such as the backup battery, has been impaired after a limited period of operation, they must be replaced. Please see the relevant chapters of these operating instructions for detailed information.

When working in areas where there is dust that may be hazardous to functionality, the device must be operated in a control cabinet with a heat exchanger or with suitable supply air.

Note

Dust deposits must be removed at regular intervals.

Maximum dust content in the air circulating in the cabinet	
Suspended component	0.2 mg/m ³
Deposits	1.5 mg/m ³ /h

Repairs

Only authorized personnel are permitted to repair the device.

 WARNING
<p>Unauthorized opening of and improper repairs to the device may result in substantial damage to equipment or risk of personal injury to the user.</p>

Cleaning agents

Use dish soap or foaming screen cleaner only as cleaning agents for the front.

The rear side of the operator unit and the housing of the computer unit must only be dry-cleaned.

CAUTION

Do not clean the device with aggressive solvents or scrubbing agents or with pressurized air or steam cleaner.
--

Procedure for cleaning the device (front)

1. Switch off the device. This prevents the accidental triggering of functions when the front is touched.
2. Dampen the cleaning cloth.
3. Spray the cleaning agent on the cloth and not directly on the device.
4. Clean the device with the cleaning cloth.

Resistance to chemicals

CAUTION

Adhere to the information regarding chemical resistance of the panel front. You can find information on the Internet at:
--

http://www.siemens.com/asis

Enter article ID 22591016 as a search term under "Tools & Downloads > Downloads > Product Support > Industrial PC". The available articles are displayed.

12.2 Maintenance and care of devices with stainless steel front

Scope of maintenance

The device is designed for low-maintenance operation. You should nonetheless clean the screen and the control panel at regular intervals. These measures and proper handling of the device increase the useful life of the front membrane and of the stainless steel front panel.

General information on cleaning

CAUTION

Do not clean the device using aggressive cleaners or detergents, greasing or abrasive detergents, concentrated acids or caustic solutions, leather, scratching or rough rags or other objects. For further information, refer to the section "Resistance to chemicals."

Do not clean the device with chlorine or chloride, for example, active chlorine, with laser or ultrasonic equipment, or with cardice.

You will damage the control panel if you clean it with high pressure equipment. If you thermally disinfect the device, for example, using hot steam equipment, you will damage the control panel and, in particular, the touch sensor.

The front panel is protected in accordance with the degree of protection against the ingress of water which is directed towards the device at a defined jet force.

Observe the permitted ambient temperatures. For additional information, refer to the chapters:

- *Application planning, Section Mounting positions and fastening*
- *Technical data, Section General technical data and Permissible temperature ranges depending on the type of installation*

Cleaning the front membrane

Clean the front membrane using the equipment described below:

- Soft, non-abrasive window wipers or a soft, clean rag
- Rubber window wipers
- Liquid glass cleaners
- Kitchen or household paper

For further information, refer to the section *Chemical resistance of stainless steel fronts*.

Cleaning the stainless steel front

For information, refer to the section "Handling of stainless steel surfaces."

Procedure

WARNING

Always switch off the device before you clean the front panel, or set it to a defined state, for example, by activating a clean screen. This avoids the risk of triggering unwanted functions when you touch the screen or when a water jet contacts the screen.

CAUTION

Do not rub the front membrane when it is dry.
Make sure that foodstuff does not splash back into the production process.
Follow the general cleaning guidelines.

1. Switch off the device. When the system is in operation, you can also activate a clean screen on the touch screen.
2. Always dilute glass cleaners with water before you apply these. Use clean water.
3. Use a window wiper or a cloth to wipe off the front membrane. Work from top to bottom. Rinse off the dirt particles when doing so.
4. Rinse the window wiper or cloth several times.
5. Clean the edges with a cloth or household paper.
6. Moisten the front membrane once again.
7. Remove the moisture with the window wiper, working from top to bottom and without leaving any streaks. After each pass, wipe off the window wiper with soft household paper. Wipe off any water accumulating on the bottom edge of the front membrane using soft household paper.
8. Wipe off the edges using household paper.
9. Clean the stainless steel surface with a neutral, alkaline cleaner or, if necessary, with a caustic cleaner which does not contain active chlorine. For further information, refer to the section *Handling of stainless steel surfaces*.

12.3 Chemical resistance of stainless steel fronts

Front membrane

The resistance of the front membrane to various chemicals was tested to DIN 42 115, section 2. The front membrane is resistant to the chemicals listed below:

- Alcohol
- Diluted acids
- Diluted caustic solutions
- Ester
- Hydrocarbons
- Household cleaners

12.4 Handling of stainless steel surfaces

Resistance

Information on the resistance of stainless steel:

- The stainless steel surface is not fully resistant to the chemicals listed below:
 - Hydrochloric acid
 - Sulphuric acid
 - Caustic soda
 - Chlorine
 - Chloride

Do not clean the stainless steel surface with these chemicals or with similar acids or caustic solutions.

- Acid steam develops, for example, when tiles are cleaned with hydrochloric acid, and is also harmful to the stainless steel. If the stainless steel parts are unintentionally contaminated with hydrochloric acid, rinse these off immediately with plenty of water.
- Clean the stainless steel surface with a neutral, alkaline cleaner or, if necessary, with a caustic cleaner which does not contain active chlorine.

Cleaning guidelines

Further information on stainless steel surfaces:

- The surface should be properly ventilated.
- Keep the surface clean. Remove cleaners and food residue immediately. Make sure that foodstuff does not splash back into the production process.
- If mechanical cleaning is necessary, do not use cleaning equipment made of metal.
 - Use brushes made of plastic or natural materials, or a microfiber pad.
 - Use plenty of water to clean the surface.
 - Remove cleaners without leaving any residue, including corners and confined areas.
- Make sure surface is not damaged: Do not damage the device during operation, or by cleaning or repairing it using hard objects, in particular objects made of non-stainless steel material.
- Avoid contact of the surface with corrosive parts: Extraneous rust from water lines, file chips, residue of wire brushes or steel wool and rust films have a corrosive effect on parts made of stainless steel.
 - Remove any stains or extraneous rust immediately.
 - Remove new rust spots with a mild abrasive detergent in order to prevent any further corrosion.
 - Rinse the part thoroughly after you cleaned it.

12.5 Spare parts

Replacement part	Order No.
Key panel	
12" TFT	6AV7672-1AB11-0AA0
15" TFT	6AV7672-1AD11-0AA0
Touch panel	
12" TFT	6AV7672-1AA11-0AA0
15" TFT	6AV7672-1AC11-0AA0
17" TFT	6AV7672-1AF11-0AA0
19" TFT	6AV7672-1AE11-0AA0
Key panel, without front USB port ^{*)}	
12" TFT	6AV7672-1AB11-0AA0
15" TFT	6AV7672-1AD11-0AA0
Touch panel, without front USB port ^{*)}	
12" TFT	6AV7672-1AA11-0AA0
15" TFT	6AV7672-1AC11-0AA0
17" TFT	6AV7672-1AC22-2AA0
19" TFT	6AV7672-1AF11-0AA0 6AV7672-1AE11-0AA0
Set of clamps	6FC5248-0AF06-0AA0
Plastic cap USB interface	A5E00378392
Lithium battery	A5E00331143

^{*)} For more information, refer to the chapter "Description."

Use only Siemens spare parts or spare parts released by Siemens, otherwise the warranty, CE declaration of conformity and UL approval will be invalidated.

12.6 Separating the control unit from the computer unit

The control unit is separated from the computer unit to carry out repairs or to replace the control unit, for example.

Procedure

1. Disconnect the device from the mains.
2. Open the switchgear cabinet. The device is now accessible from the back.
3. To swing away the computer unit (1): Loosen the four knurled screws (2) which attach the computer unit to the rear of the control unit (3).

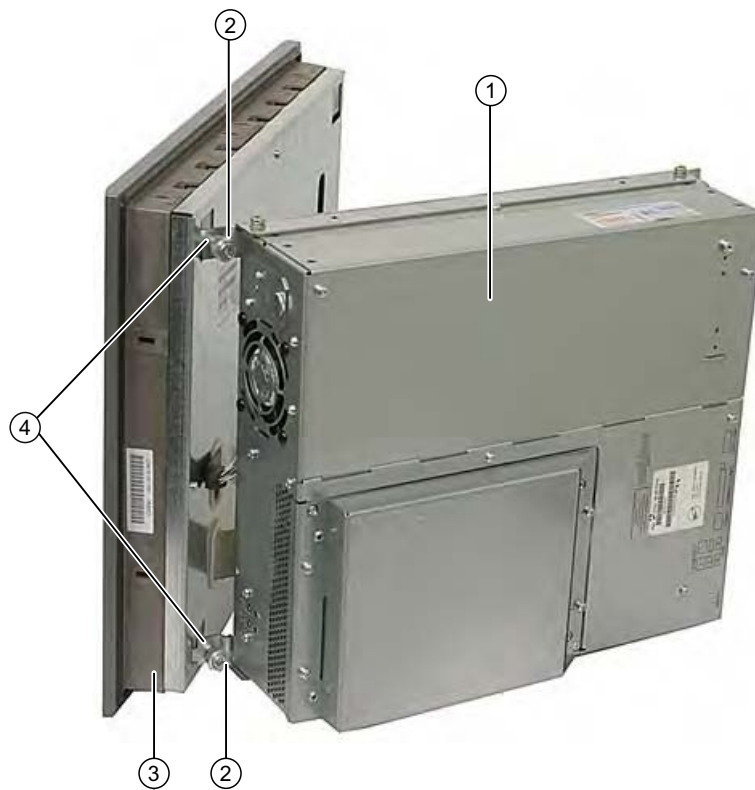

Figure 12-1 Separating the control unit from the computer unit

4. Swing the computer unit (1) away. The connectors on the back of the control unit (3) are now accessible.
5. Loosen cables and the USB cable between the computer unit and the control unit
6. Two mounting rails are screwed onto the computer unit whose angled clips (4) are located in the corresponding recesses in the computer unit. Lift the computer unit vertically out of these recesses
7. Put the computer unit down carefully.

8. If required, remove the control unit as follows:
 - Screw mounting: Secure the control unit against falling out and unscrew it.
 - Clamp fastening: Remove the clamps that secure the control unit to the mounting wall.

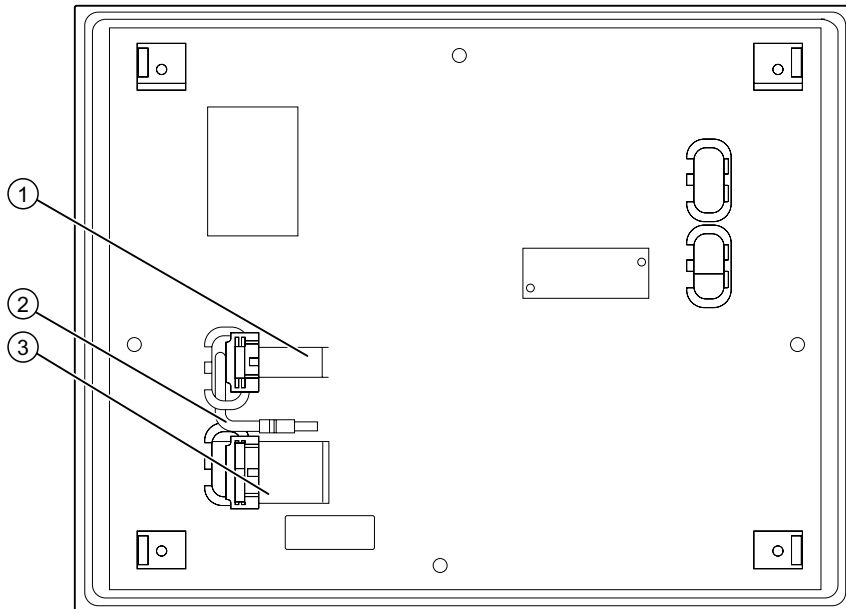

Figure 12-2 Other interfaces on the computer unit

- (1) Display cable (for 17" and 19" touch panels 2 pieces)
- (2) USB cable
- (3) IO USB cable

Separating the device in an uninstalled state

As an alternative, dismount the device completely and separate the control unit and computer unit from one another in an uninstalled state. So that the processing unit, which is swung away from the control unit, does not bend the lugs (4), place a surface under the processing unit.

Mounting operator control unit on computer unit

To mount the operator control unit on the computer unit, perform the steps in reverse:

CAUTION

When you swing the control unit and processing unit together, make sure that the flatband cables are correctly folded together and do not get squished.

In order to do this, fold the flatband cables gently with specific spacing, as shown. The bend dimensions are specified in the following table. The USB cable does not have to be folded because it is stored as a loop in the computer unit.



Figure 12-3 Example for folding of the cable

Position	Bend dimension
A	4.5 cm
B	4 cm

12.7 Removing and installing hardware components

12.7.1 Repairs

Repairing components

Only authorized personnel are permitted to repair the device.

 WARNING
--

Unauthorized opening and improper repairs may lead to material damage and hazards to users.

- Always disconnect the power connector before you open the device.
- Install only system expansions which are designed for this computer. The installation of other expansions can damage the system and violate the radio-interference suppression regulations. Contact Technical Support or your local sales department to find out which system expansions are suitable for installation.

If you install or exchange system expansions and damage your device, the warranty becomes void.

NOTICE

Observe the ESD instructions.

Disclaimer of liability

All technical data and approvals apply only to expansion units which are released by SIEMENS.

Siemens disclaims any liability for impairment of functions caused by the use of third-party devices or components.

Tools

You can perform all installation tasks on the device using Torx T6, T10, and T15 screwdrivers and a Philips screwdriver.

12.7.2 Opening the Device

CAUTION

Work on the open device may only be carried out by authorized and qualified personnel. Within the warranty time, you are only allowed to install expansions for memory and expansion card modules.

CAUTION

The device contains electronic components which may be destroyed by electrostatic charge.

You therefore need to take precautionary measures before you open the device. Refer to the ESD directives on handling components which are sensitive to electrostatic charge.



Disclaimer of liability

All specifications and approvals apply only to expansion units which are released by SIEMENS.

Siemens disclaims any liability for impairment of functions caused by the use of third-party devices or components.

Observe the installation instructions for the components. UL approval of the device only applies when the UL-approved components are used according to their "Conditions of Acceptability".

Open the device up

Steps for opening the device	
1	Disconnect the device from the mains.
2	Loosen the screws (1).
	
3	Swing the cover up and remove it.
	

12.7.3 Removing/Installing Memory Module

Memory expansion options

The motherboard is equipped with 2 slots for memory modules. For 184-pin DDR2 RAM chips, unbuffered, no ECC. This allows you to expand device memory up to 4 GB, of which you can use approx. 3.2 GB for the operating system and applications. You can install one or two modules.

Combination	Slot X1	Slot X2	Maximum expansion
1	512 MB / 1 GB / 2 GB		2 GB
2	512 MB / 1 GB / 2 GB	512 MB / 1 GB / 2 GB	4 GB

Preparation

Disconnect the device from mains and unplug all cables.

CAUTION

The electronic components on the PCBs are highly sensitive to electrostatic discharge. Always take appropriate precautionary measures when handling these components. Refer to the ESD directives on handling electrostatic sensitive components.

NOTICE

We highly recommend using memory modules approved by Siemens. Siemens disclaims any liability for impairment of functions caused by the use of third-party memory modules.

Removing a memory module

How to remove a memory module	
1	Open the device.
2	Release the locking mechanism on the left and right.
3	Pull the memory module out of the slot.
4	Close the device.

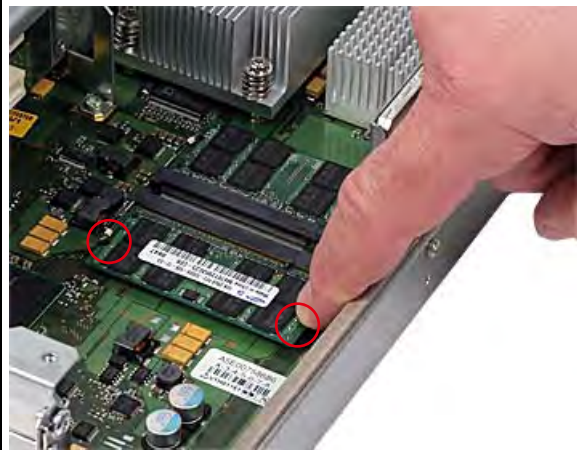

Display of the current memory configuration

A new memory module is automatically detected. The allocation of the "base memory and extended memory" is automatically displayed when you switch on the device.

Installing a memory module

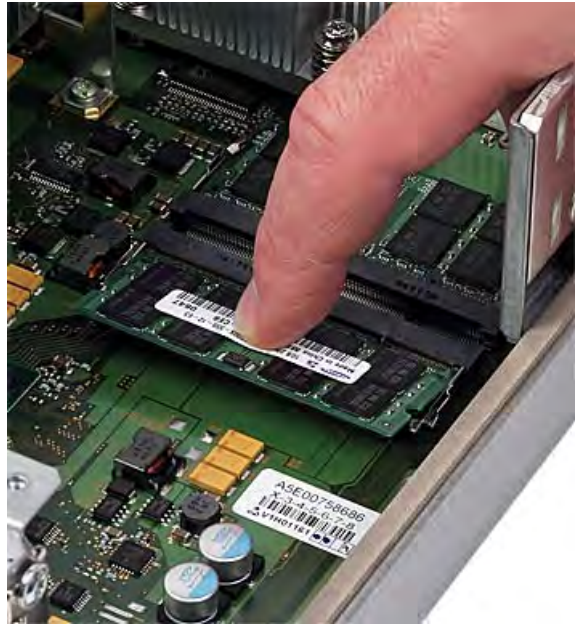
How to install a memory module		
1	Open the device.	
2	<p>Note where the (polarized) cutout is on the pin side of the RAM chip before inserting it.</p> <p>Note: The modules can be installed in any slot.</p>	
3	<p>Insert the module downwards, applying slight pressure and press it until the locking snaps into place.</p>	
4	Close the device.	

12.7.4 Installing PCI / PCI express cards

12.7.4.1 Notes on the modules

The device is designed for use with modules conforming to PCI specifications V 2.2. PCI modules with 5 V and 3.3 V supply voltage and PCI Express x4 modules can be used. The permissible module dimensions are specified in the "Dimensional drawings" section.

12.7.4.2 Installing / removing expansion modules

Preparation

Disconnect the device from the mains.

Installing expansion modules

How to install an expansion module (PCI / PCI express card):	
1	Open the device.
2	Remove the screws (1) and remove the mount (2).
3	Remove the slot cover (5) from the intended slot.
4	Insert the expansion module (4) into the relevant slot. When using long PCI cards, pay attention to the guide rail (6).
5	Install the mount (2) and insert the card retainer (3).
6	Screw down the steel slot cover (5) for the expansion module.
7	Close the device.

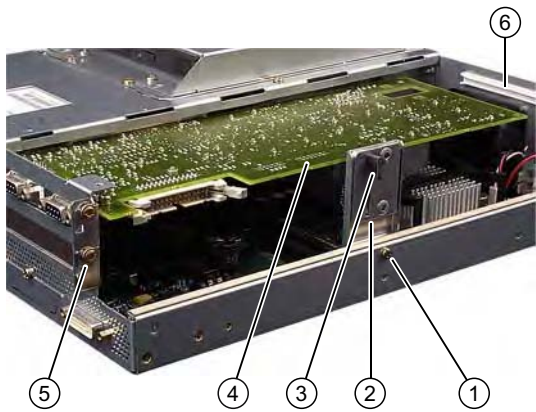

Inserting the card retainer

How to install the card retainer	
1	<p>Insert the card retainer through the guide slot of the mount. The card retainer must be solidly on the module. Insert the module in the notch.</p>

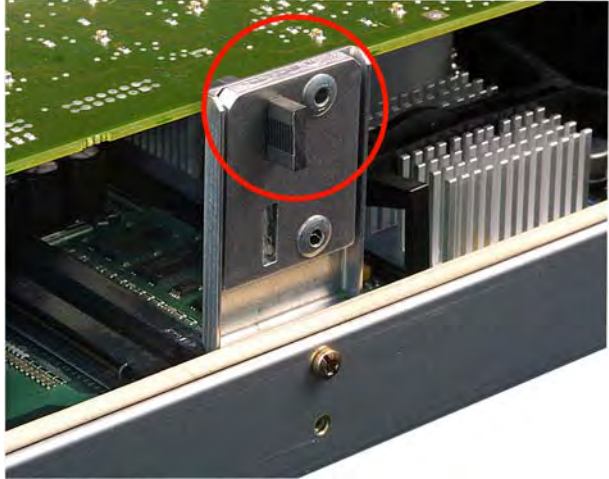
**CAUTION**

Do not put pressure on the module! Do not apply excessive force to the card retainer when you push it onto the module.

2	<p>Remove any excess part from the card retainer.</p>
---	---

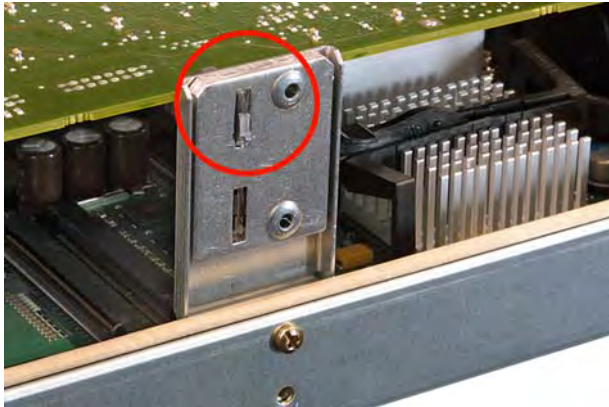

Notes on the allocation of resources

The two slots for the PCI cards each have an exclusive interrupt. Information on the assignment of PCI IRQs to the PCI slots is available in the "Advanced menu" or "Bus board" section.

12.7.5 Installing drives

12.7.5.1 Options of installing disk drives

Drive bay module for hard disk drives and optical drives

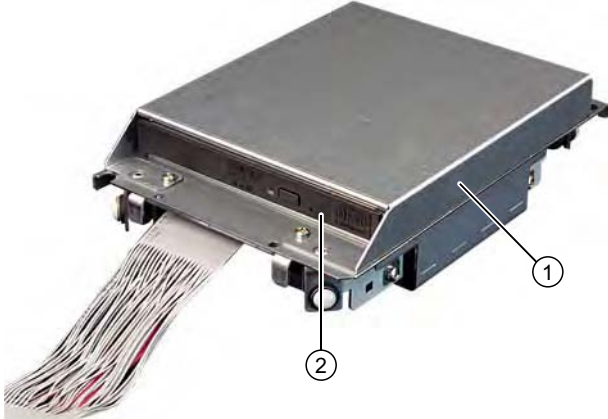
DVD burner drive bay mount	Item	Description
	(1)	DVD burner drive bay mount
	(2)	Slot for DVD burner drive

A 3.5" hard disk drive	Item	Description
	(1)	Hard disk drive bay for one 3.5" drive
	(2)	Slot for one 3.5" drive

Two 2.5" hard disks	Item	Description
	(1)	Hard disk drive bay for 2.5" hard disks
	(2)	Two slots for 2.5" hard disks

12.7.5.2 Installing/removing a drive bay module

Preparations

Isolate the device from mains and disconnect all connection cables.

Removing a drive bay module for hard disks and optical drives

Steps for removing the drive bay	
1	Loosen the four screws (1).
2	Lift out the drive bay module for hard disks and the optical drive.

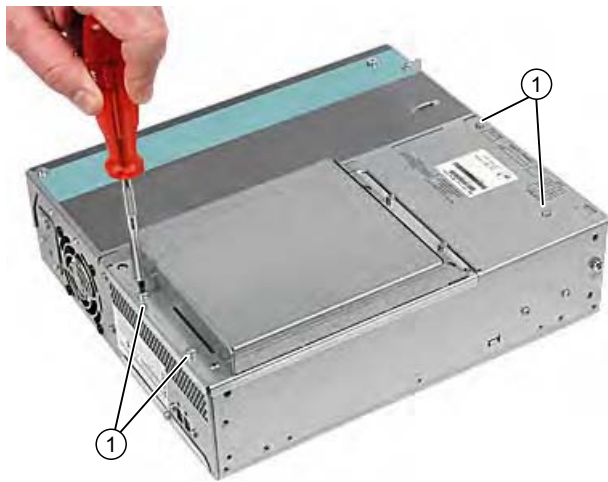

12.7.5.3 Removing / installing an optical drive

Preparations

Isolate the device from mains and disconnect all connection cables.

Required tools

You need a Torx 6 screwdriver to remove the the DVD burner.

Removing the DVD burner drive

How to remove a DVD burner drive	
1	Remove the drive bay module.
2	Loosen the screws (1) on the DVD burner drive bay.
3	Loosen the screws (2) on the drive.
4	Loosen the screws (3) of the adapter board.
5	Disconnect the adapter board.
6	Lift the drive out.

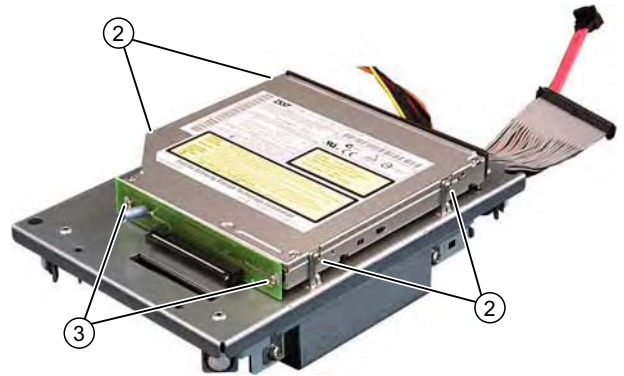

12.7.5.4 Installing / removing hard disks

Removing 2.5" drives

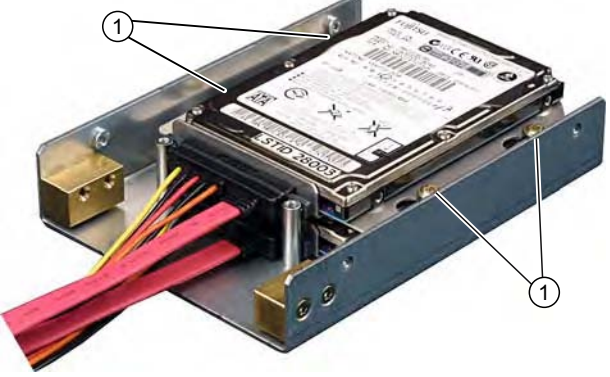
How to remove a 2.5" drive		
1	Remove the drive bay module.	
2	Loosen the screw (1) of the drive.	
3	Remove the hard disk drive and the steel mounting bracket from the bay.	
4	Disconnect the power supply and the data cable from the drive.	

Removing a 3.5" drive

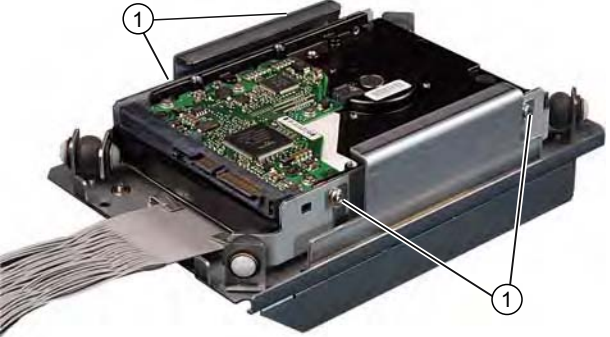
How to remove a 3,5" drive		
1	Remove the drive bay module.	
2	Disconnect the power supply and the data cable from the drive.	
3	Loosen the screws (1) on the drive.	
4	Remove the hard disk drive from the bay.	

Note

Note that special screws with inch threads (6-32 x 3/16" St G3E) are used!

12.7.6 Installing/removing an on-board Compact Flash card

NOTICE

We highly recommend that use use approved SIMATIC Compact Flash cards. Siemens disclaims any liability for impairment of functions caused by the use of third-party cards.

Memory expansion options

The device features a slot for Compact Flash cards types I / II.

NOTICE

This slot is not hot-plug capable. The Compact Flash card must be installed before the PC is switched on and should only be removed when the device is switched off.



Preparation

Disconnect the device from the mains.

 **CAUTION**

The electronic components on the PCBs are highly sensitive to electrostatic discharge. Always take appropriate precautionary measures when handling these components. Refer to the ESD directives on handling electrostatic sensitive components.

Opening the board slot

How to install a Compact Flash card	
<p>1 Remove the screws.</p>	
<p>2 Slide the cover plate of the module slot towards the DVI connection and lift it out.</p>	

Installing the Compact Flash card

How to install a Compact Flash card	
1	Open the board slot.
2	Insert the Compact Flash card in the slot with the connector facing in until it locks into place.
	
3	Open the module slot.

Note

The Compact Flash slot is coded against reversed insertion. Insert the Compact Flash card so that its label side is facing the front panel of the PC.

CAUTION

If the Compact Flash card meets resistance, flip it over. Never insert the Compact Flash card with force.

Removing the Compact Flash card

How to remove a Compact Flash card	
1	Open the board slot.
2	Press the eject button, for example with the cover of the module slot, and remove the Compact Flash card.
	
3	Open the module slot.

12.7.7 Installing/removing an additional Compact Flash card

NOTICE

We highly recommend that use use approved SIMATIC Compact Flash cards. Siemens disclaims any liability for impairment of functions caused by the use of third-party cards.



Preparation



Disconnect the device from the mains.

Note

The use of the Compact Flash adapter excludes the simultaneous use of a hard disk.

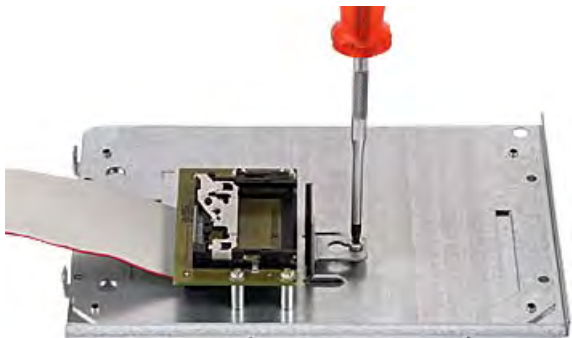
Installing the additional Compact Flash card

How to install the Compact Flash card in the Compact Flash adapter	
1	Remove the hard disk cover. 
2	Lift out the Compact Flash adapter module and lay it on the device. 
3	Open the Compact Flash latch. 

How to install the Compact Flash card in the Compact Flash adapter	
4	<p>Insert the Compact Flash card in the adapter with the connector facing in until it locks into place.</p> 
5	<p>Close the Compact Flash latch.</p> 
6	<p>Mount the hard disk cover.</p>

12.7.8 Replacing the Backup Battery

Note

Batteries are wearing parts and should be replaced every five years in order to ensure proper functioning of the PC.

To be noted before you replace the battery

CAUTION

Risk of damage!

The lithium battery may only be replaced with an identical battery or with a type recommended by the manufacturer (Order No.: A5E00331143).

WARNING

Risk of explosion and release of harmful substances!

For this reason, do not burn lithium batteries, do not solder on the cell body, do not open, do not short circuit, do not reverse polarity, do not heat above 100°C, dispose of correctly, and protect against direct sunlight, dampness and dew.

Disposal

CAUTION

Batteries must be disposed of in accordance with local regulations.

Preparation

Note

For the BIOS setting "Profile: Standard" the configuration data of the device is deleted when the battery replacement takes more than 30 seconds.

For the BIOS setting "Profile: User" the configuration data of the device is retained; only the date and time has to be reconfigured.

The content of the SRAM is lost if the battery replacement takes more than 30 seconds.

1. Note down the current settings of the BIOS Setup.
A list in which you can note down this information is found in the BIOS manual.
2. Isolate the device from mains and disconnect all connection cables.

NOTICE

You can also replace the battery while the device is running; do not touch anything with the device in this case. We recommend switching off the device beforehand.

Replacing the battery

Follow the steps outlined below:

Steps for replacing the battery		
1	Open the battery compartment.	
2	Remove the battery holder.	
3	Detach the cable.	
4	Remove the old battery.	
5	Fasten the new battery and reinsert the battery holder.	
6	Close the battery compartment.	

Reconfiguring the BIOS setup

If the battery replacement took longer than 30 seconds, the configuration data of the device have been deleted and you need to reconfigure these in the BIOS Setup.

12.7.9 Removing/Installing the Power Supply

WARNING

Only authorized trained personnel are allowed to replace the power supply unit.



Preparations

1. Isolate the device from mains and disconnect all connection cables.
2. Open the device.

Removing the power supply unit

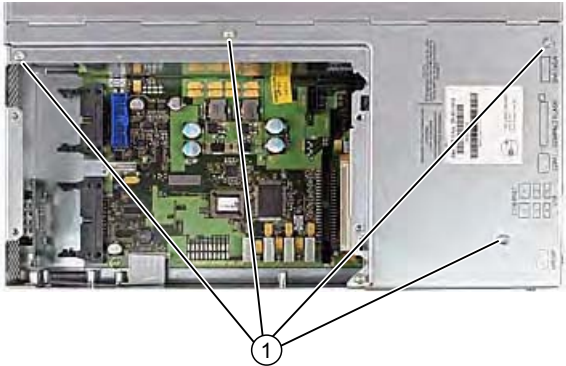
How to remove the power supply module	
1	Remove the drive bay module for the hard disk and DVD burner.
2	Loosen the screws (1) and remove the power supply cover.

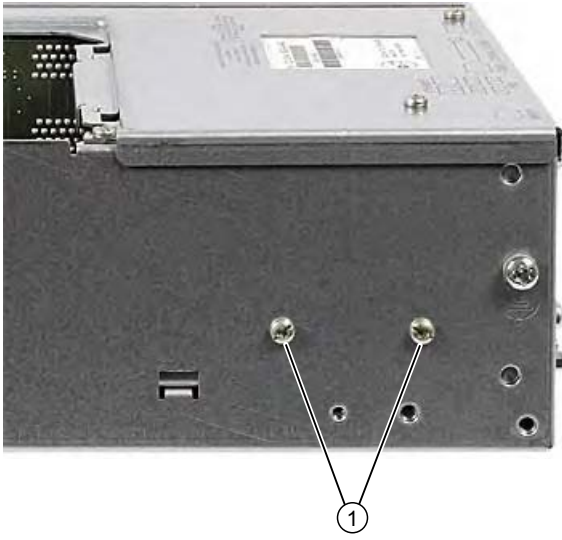

How to remove the power supply module		
3	Remove the screws (1) (Torx T10).	
4	Detach the power plug (1) from the power supply module.	
6	Lift out the power supply module.	

12.7.10 Installing / removing the bus board

Preparation

1. Isolate the device from mains and disconnect all connection cables.
2. Open the device.

Removing the bus board

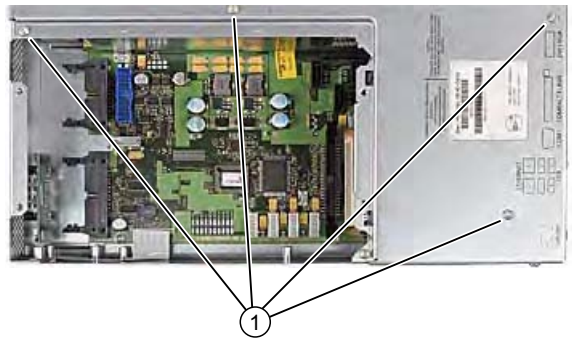
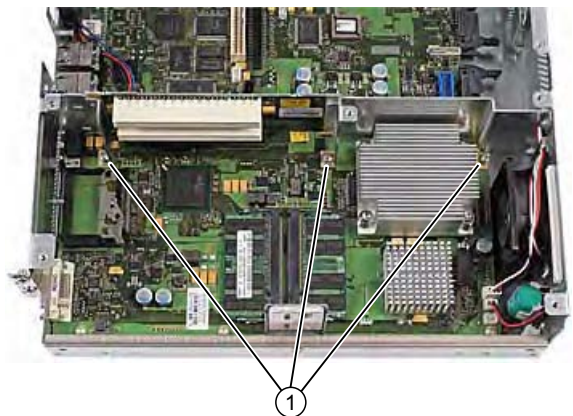
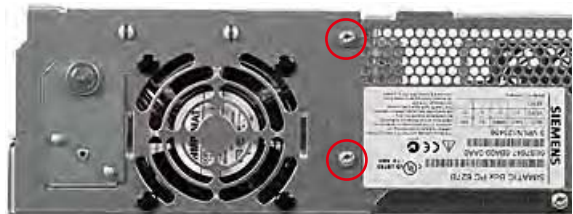
How to remove the bus board		
1	Remove all modules from the slots.	
2	Lift out the drive bay module for hard disks and the DVD burner.	
3	Loosen the screws (1) and remove the power supply cover.	
4	Remove the power supply.	
5	Remove the screws (1) on the bus board.	
6	Loosen the screws (1) on the enclosure.	
7	Pull the bus board from the motherboard.	

12.7.11 Installing / removing the motherboard

Preparation

1. Isolate the device from mains and disconnect all connection cables.
2. Open the device.

Removing the motherboard

How to remove the motherboard	
1	Remove the drive bay module for the hard disk and DVD burner.
2	Loosen the screws (1). Remove the module bracket (2).
	
3	Remove the power supply cover.
4	Remove the bus board.
5	Remove the power supply.
6	Disconnect all cables from the motherboard, noting down their positions while doing so.

How to remove the motherboard

7 Remove the screws (1) (6 pieces) and then the screws (2) (4 pieces). Remove the processor heat sink.

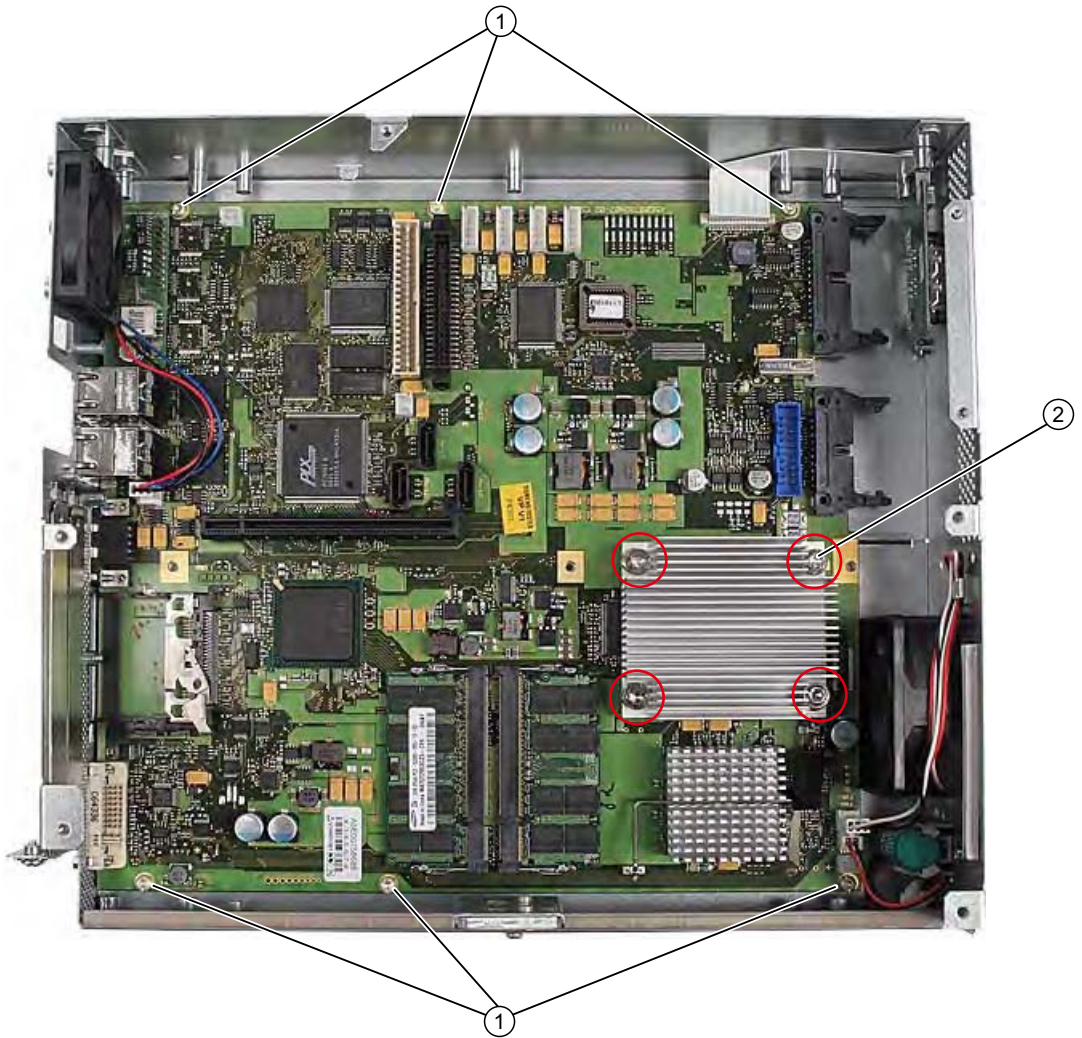

8 Remove the hexagon bolts (6 pieces) from the ports.

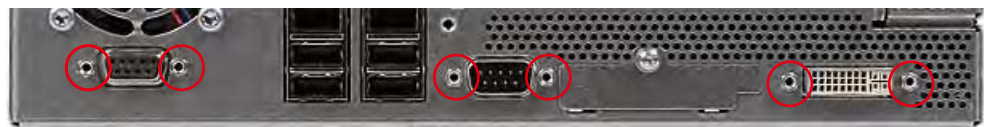



9 Remove the motherboard.

12.7.12 Installing / removing the equipment fan

Preparations

1. Disconnect the device from the mains.
2. Open the device.

Removing the fan

How to remove the fan	
1	Pull the fan plug from the motherboard.
	2
2	Loosen the four two plastic rivets on the enclosure.
	3
3	Take the fan out of the enclosure.

Installing the fan

NOTICE

Always install a fan of the same type!

Fan mounting position

The figure shows the correct fan mounting position.
Pay attention to the direction of the arrow on the fan enclosure!

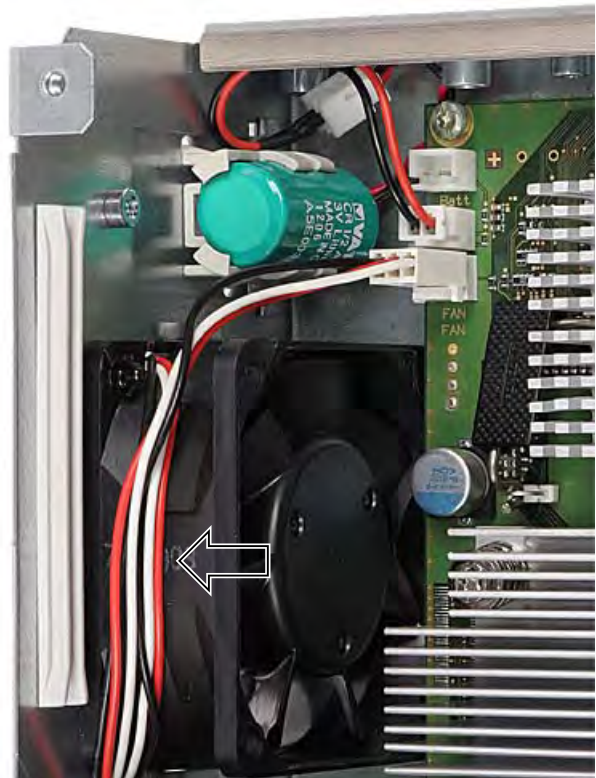



12.7.13 Installing / removing the power supply fan

Preparations

1. Disconnect the device from the mains.
2. Open the device.
3. Remove the power supply.

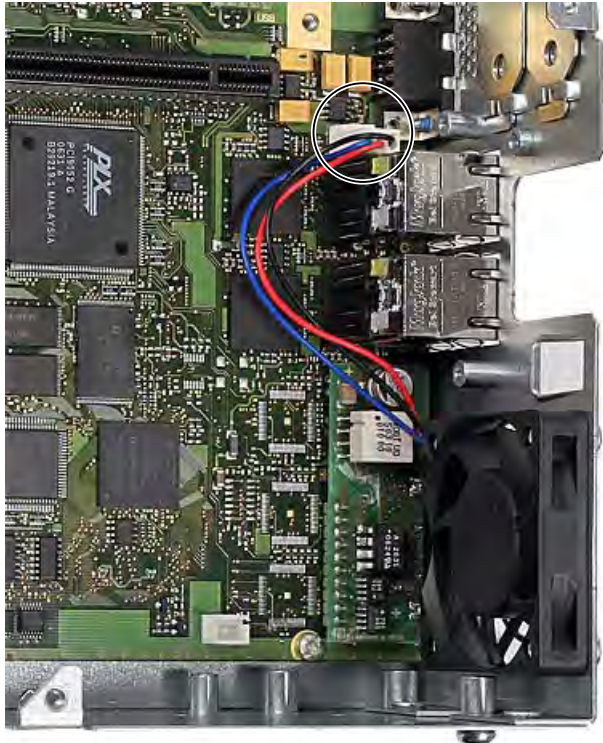
Removing the fan

How to remove the fan	
1 Pull out the fan connector.	 A photograph showing the internal components of the SIMATIC Panel PC 677B. The motherboard is visible, with a fan connector highlighted by a white circle. The connector is a small, rectangular component with three pins, and it is connected to a fan cable with red, blue, and black wires. The fan is located on the right side of the enclosure.
2 Loosen the four screws on the enclosure.	 A photograph showing the external view of the SIMATIC Panel PC 677B. The fan enclosure is visible, and four screws are highlighted by white circles. The enclosure is a rectangular metal plate with a fan cutout. The fan is located in the center of the enclosure. The screws are located at the corners of the fan cutout.
3 Take the fan out of the enclosure.	

Installing the fan

NOTICE

Always install a fan of the same type!

Fan mounting position

The diagram shows the correct mounting position of the fan (1). Pay attention to the direction of the arrow on the fan enclosure!



12.7.14 Installing / removing the processor

CAUTION

The processor replacement may only be carried out by authorized qualified personnel.

Preparation

1. Disconnect the device from the mains.
2. Open the device.
3. Remove the drive bay module.
4. Remove the power supply cover.

Removing the processor

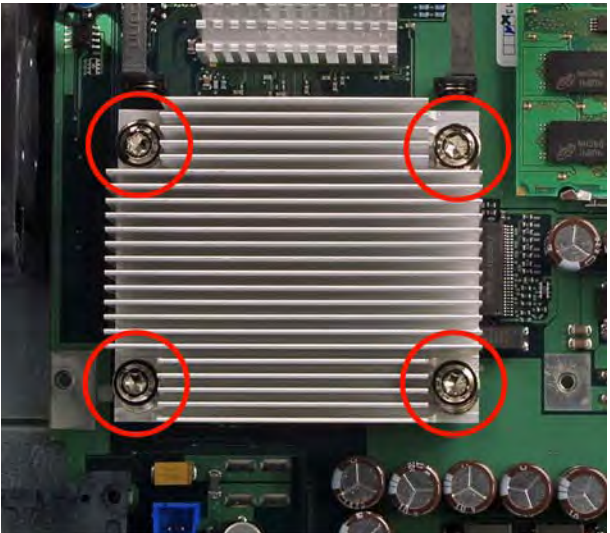
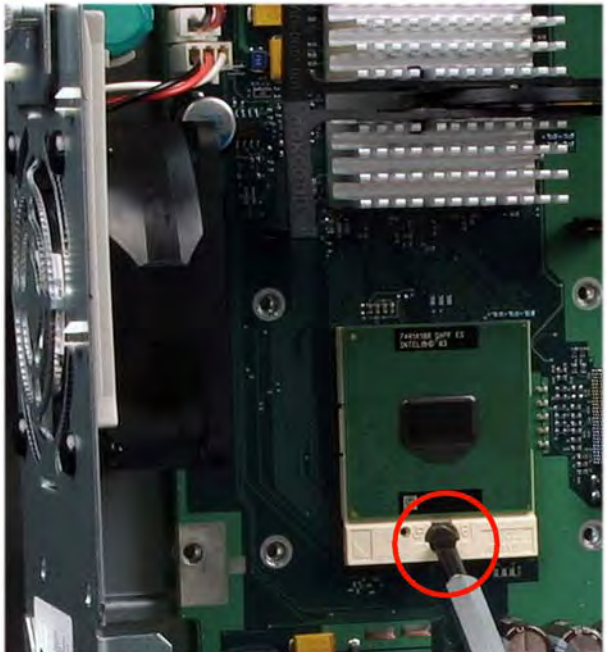
How to remove the processor	
1 Remove the four screws from the processor heat sink and remove the heat sink.	 A close-up photograph of a silver aluminum heat sink mounted on a green printed circuit board (PCB). Four screws are visible, one in each corner of the heat sink, and each is circled with a red circle. The PCB has various components, including capacitors and integrated circuits, visible around the heat sink.
2 Loosen the processor latch.	 A close-up photograph of the processor latch mechanism on the PCB. A screwdriver is shown inserted into the latch, which is circled in red. The processor is visible in the background, mounted on the PCB. The latch is a small metal component that secures the processor in its socket.

How to remove the processor	
3 Remove the processor.	

Installing the processor

Note

When you insert the processor, make sure the markings on the processor and on the socket match up.

NOTICE

The processor may overheat when the system is in operation! Apply the heat-conductive paste very evenly, as a thin film!

How to install the processor

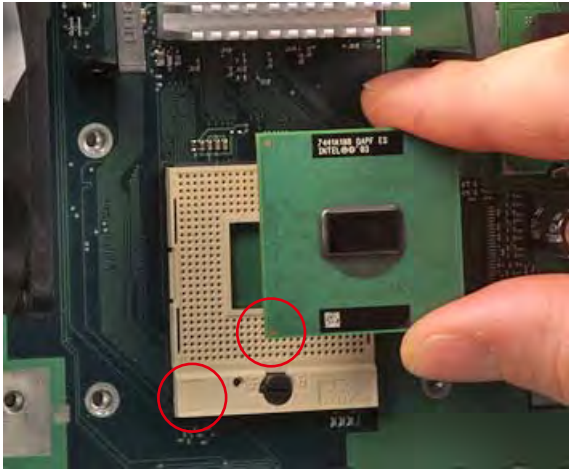
1	Insert the processor.	
2	Close the processor latch.	
3	Apply the heat-conductive paste on the processor.	
4	Secure the processor heat sink with the four screws. To do so, insert the screws diagonally and tighten them evenly, working diagonally in order to avoid tilting of the fan unit. Tighten the screws down to the mechanical stop.	

Required tools

You need a Torx 10 screw driver for removing the processor.

12.8 Reinstalling the operating system

12.8.1 Windows XP Embedded

12.8.1.1 General installation procedure

If your software becomes corrupt for any reason, you can return it to the factory state using the Restore DVD. The Restore DVD contains a image file for the Compact Flash card with the original software (operating system with installed hardware drivers) and is included in the Windows XP Embedded package variant.

Note

You require a USB keyboard in order to reinstall the operating system and a USB CD-ROM drive.

12.8.1.2 Restoring the software to factory state using the Restore DVD

You can reinstall the original factory software using the Restore DVD (included in the product package). The DVD contains the necessary images and tools for transferring the factory software to the Compact Flash card of your PC. The following options are available for restoring software:

- Restoring the factory state with drive C and drive D
- or only drive C:. This allows you to retain any user data on drive D:.

CAUTION
With the option "Restore system partition only", all data on drive C: (system partition) will be deleted. All data, user settings and all authorizations or license keys on drive C: are lost! All data on drive C: of your hard disk drive will be deleted. Setup formats the hard disk partition and reinstalls the original factory software.
When you select the "Restore entire hard disk" option, ALL the data, user settings and authorizations or license keys will be lost on the Compact Flash card.

Restoring factory state

To restore the factory state, proceed as follows:

1. If the device does not have an optical drive, connect a USB DVD-ROM drive to the device.
2. Insert the Restore DVD in the drive and reboot the device. When the BIOS message

Press <F2> to enter Setup or <ESC> to show Boot menu
--

appears, press the F2 key.

3. Select the Boot menu and move the entry "DVD Drive" to the first position.
4. Close the BIOS setup with the "Save Changes & Exit" option.
5. Follow the on-screen instructions.

CAUTION

All existing data, programs, user settings, authorizations or license -keys on the drives will be deleted and are therefore lost.

For information on the functions, refer to the README.TXT file on the Restore DVD.

Note

The "Legacy USB Support" option has to be set to "Enabled" in the Advanced menu of the BIOS so that the device can address a USB DVD-ROM drive.

12.8.2 Windows XP Professional / Windows 2000 Professional

12.8.2.1 General installation procedure

If your software becomes corrupt for any reason, you have two possibilities:

- **Restoring the factory state of the software with the Restore DVD**
The Restore DVD contains an image file of the original supplied software (operating system with installed drivers) and is included in the Windows XP Professional variant.
- **Setting up the operating system with the Windows 2000 Professional Recovery CD**
The recovery CD contains the tools required to set up the hard disk as well as the operating system. After the required data have been copied to the hard disk, you can run Windows XP professional Setup to install the operating system.

Note

You will need a USB keyboard in order to reinstall the operating system.

12.8.2.2 Restoring the Software to Factory State Using the Restore DVD

You can reinstall the original factory software (included in the Windows XP Professional supply variant) using the Restore DVD. The DVD contains the necessary images and tools for transferring the factory software to the hard disk of your PC. The following options are available for restoring software:

- You can restore the entire hard disk with drive C: (system) and drive D:
- Or only drive C:. This allows you to retain any user data on drive D:.

CAUTION

With the option "Restore system partition only", all data on drive C: (system partition) will be deleted. All data, user settings and all authorizations or license keys on drive C: are lost! All data on drive C: of your hard disk drive will be deleted. Setup formats the hard disk partition and reinstalls the original factory software.

When you select the "Restore entire hard disk" option, ALL the data, user settings and authorizations or license keys will be lost on the hard disk.

Restoring factory state

To restore the factory state, proceed as follows:

1. If the device does not have an optical drive, connect a USB DVD-ROM drive to the device.
2. Insert the Restore DVD in the drive and reboot the device. When the BIOS message

Press <F2> to enter Setup or <ESC> to show Boot menu

appears, press the F2 key.

3. Select the Boot menu and move the entry "CD-ROM Drive" to the first position.
4. Close the BIOS setup with the "Save Changes & Exit" option.
5. Follow the on-screen instructions.

CAUTION

All existing data, programs, user settings, authorizations and license keys on the drives will be deleted and are therefore lost.

For information on the functions, refer to the "README.TXT" file on the Restore DVD.

Note

The "Legacy USB Support" option has to be set to "Enabled" in the Advanced menu of the BIOS so that the device can address a USB DVD-ROM drive.

Setting up the language selection for Windows XP Professional

The Multilanguage User Interface (MUI) allows you to set up the Windows XP Professional menus and dialogs for additional languages.

Default language of your Windows XP MUI installation is English and a US keyboard layout. You can change the language in the Control Panel. Select:

"Start > Control Panel > Regional and Language Options" "Languages" tab, "Language used in menus and dialogs" field.

For the "Regional and Language Options" set the default as "non-Unicode programs" under "Advanced" in addition to the language for menus and dialogs.

Setting up the language selection for Windows 2000 Professional

The Multilanguage User Interface (MUI) allows you to set up the Windows 2000 menus and dialogs for additional languages.

The dialog language for Windows 2000 menus and for the keyboard layout are set in the corresponding Control Panel dialog:

"Start > Settings > Control Panel > Regional Options" "General" tab, "Menus and Dialogs" field and "Language Settings" field for the system and in the "Input locales" tab, "Keyboard layout" field.

The default language setting of your Windows 2000 installation is English with US keyboard layout. To change to another language and keyboard layout, open the Control Panel and select:

Start > Settings > Control Panel > Regional Options > "General" tab, "Menus and dialogs" field and "Language settings for the system" field and the "Input language" field in the "Input Locales" tab.

In addition to the menu and dialog language settings, you also need to set the default language for the region by selecting "Set default..." from the "Regional Options" dialog box.

12.8.2.3 Setting up the operating system via the Recovery DVD

Use the Recovery DVD to install Windows to suit your particular requirements. The operating system used is Windows Preinstall Environment (WinPE). You also need the "Documentation and Drivers" CD supplied in the package.

Booting with the Recovery DVD

1. Insert the Recovery DVD in your drive and reboot the device. When the BIOS message Press <F2> to enter Setup or <ESC> to show Boot Menu appears, press the <ESC> key. The "Boot Menu" is displayed when initialization is completed.
2. Select the optical drive using the cursor keys.
3. Please follow the on-screen instructions until the "Siemens SIMATIC Recovery" window appears.

Partition setup

Set up the hard disk partitions after having installed a new hard disk, or to repair faulty partitions, or to change the partitioning.

CAUTION

When you delete or create partitions or logical DOS partitions, you lose all data on the hard disk. All partitions on the hard disk will be deleted.

With Windows XP/2000 operating systems, the factory state features two partitions with an NTFS file system on the hard disk. To restore the partitions to factory state, proceed as follows:

1. Boot from the Recovery DVD and then follow the on-screen instructions until the "Recovery Functions" window is displayed.
2. Start the "DiskPart" tool in the "Siemens SIMATIC Recovery" window. Enter the following commands in the displayed command interface:

list disk	Displays all available hard disks.
select disk 0	Selects the disk where you wish to change the configuration. 0 selects the first hard disk.
list partition	Displays all partitions on the selected hard disk.
clean	Completely wipes the selected hard disk. All information stored there is lost.
create partition primary size=n	Creates a primary partition with the n MB on the selected hard disk. Factory state values: n = 10000 for Windows 2000 or XP
select partition 1	Select the primary partition
active	Activates the selected partition
exit	Closes DiskPart.

Additional DiskPart functions:

Help	Shows all available DiskPart commands. When a command is supplemented with other parameters, the command is described with additional information. Example: create partition help
------	--

Note

Once you have change the configuration of your hard disk with DiskPart, you will need to reboot the PC for the changes to go into effect.

Boot again from the Recovery DVD to format the partitions.

Format primary partition

1. Boot from the Recovery DVD to format the partitions. Follow the screen instructions until the Recovery functions window is displayed.
2. Select "Start command prompt" in the Recovery functions window. In the command interface that opens, enter the following command:
`format DL:/FS:File System`
DL = Drive letter of the partition to be formatted. Valid values: C, D, E, F etc.
File system = Specifies the type of file system. Valid values: FAT, FAT32, NTFS.

NTFS is the factory setting for all Windows operating systems.

Example for a master hard disk on the IDE bus

```
format C:/FS:NTFS
```

`format /?` Shows all parameters of the command.

Installation of the operating system.

The recovery DVD contains encrypted data that can only be transferred to this system.

1. Boot from the Recovery DVD and then follow the on-screen instructions until the "Recovery Functions" window is displayed.
2. Select "Recovery Windows ..." in the "Siemens SIMATIC Recovery" window.
3. Follow the instructions on the screen.

Note

Note that the following available space is required on the drive after transfer of the selected recovery data:
500 MB for Windows 2000
1500 MB for Windows XP

4. Select "Start command prompt" in the "Recovery Functions" window.
5. Enter the following command in the displayed command prompt interface:
Drive:
`cd \I386`
`Winnt32.bat`
Drive: Drive letter of the folder containing the I386 directory.
6. The preparation of the Windows installation is displayed.
7. When this is completed, close the command prompt with the "exit" command.
8. Close the "Siemens SIMATIC Recovery" window by clicking the "Finish" button.
9. Setup automatically restarts the system and completes the installation of Windows.
10. Follow the instructions on the screen.

Note

If you want to use Windows XP as a professional you should have the following manual (not included in the scope of delivery) available:
Microsoft Windows XP Professional, the technical reference" (MSPress Nr 934)
this manual contains special information for administrators involved in installing, managing and integrating Windows in networks or multi-user environments.

Setting up the language selection for Windows XP Professional

The Multilanguage User Interface (MUI) allows you to set up the Windows XP Professional menus and dialogs for additional languages.

To install the MUI, start the "MUISETUP.EXE" program on the "MUI-english" Recovery DVD under the folder

CD_DR:\MUI

or in the root directory of the "MUI Windows XP" Recovery DVD. Follow the on-screen instructions, in order to install the required languages.

Default language of your Windows XP MUI installation is English and a US keyboard layout. You can change the language in the Control Panel. Select:

"Start > Control Panel > Regional and Language Options", "Languages" tab, "Language used in menus and dialogs" field.

For the "Regional and Language Options" set the default as "non-Unicode programs" under "Advanced" in addition to the language for menus and dialogs.

Setting up the language selection for Windows 2000 Professional

The Multilanguage User Interface (MUI) allows you to set up the Windows 2000 menus and dialogs for additional languages.

To install the MUI, start the "MUISETUP.EXE" program in directory

CD_DR:\SOURCE\MUI

on the Recovery DVD. Follow the on-screen instructions, in order to install the required languages.

The dialog language for Windows 2000 menus and for the keyboard layout are set in the corresponding Control Panel dialog:

"Start > Settings > Control Panel > Regional Options", "General" tab, "Menus and dialogs" field and "Language settings for the system" field and the "Keyboard layout" field in the "Input Locales" tab.

The default language setting of your Windows 2000 installation is English with US keyboard layout. To change to another language and keyboard layout, open the Control Panel and select:

Start > Settings > Control Panel > Regional Options > "General" tab, "Menus and dialogs" field and "Language settings for the system" field and the "Input language" field in the "Input Locales" tab.

In addition to the menu and dialog language settings, you also need to set the default language for the region by selecting "Set default..." from the "Regional Options" dialog box.

12.8.3 Recovery of Windows Vista

To recover Windows Vista, there is a full graphical user interface available. It may take several minutes before the first input window appears. In this window, you can set the time and currency formats and select the required keyboard language.

English is the basic language and other languages can be installed later with the MUI. The MUI is on the Recovery DVD.

Now follow the on-screen instructions. It may take several minutes before the next prompt for the product key is displayed.

Note

Due to the previous activation, you do not need to enter the product key (COA number). This is entered automatically during the installation.

Setting up and formatting partitions

After you have installed a new hard disk, or if partitions are faulty, or when you wish to change the partitioning on your hard disk, you need to create or reconfigure partitions on the hard disk.

In the next dialog box, you can set up the hard disk according to your requirements and add controllers that are not yet known to the system.

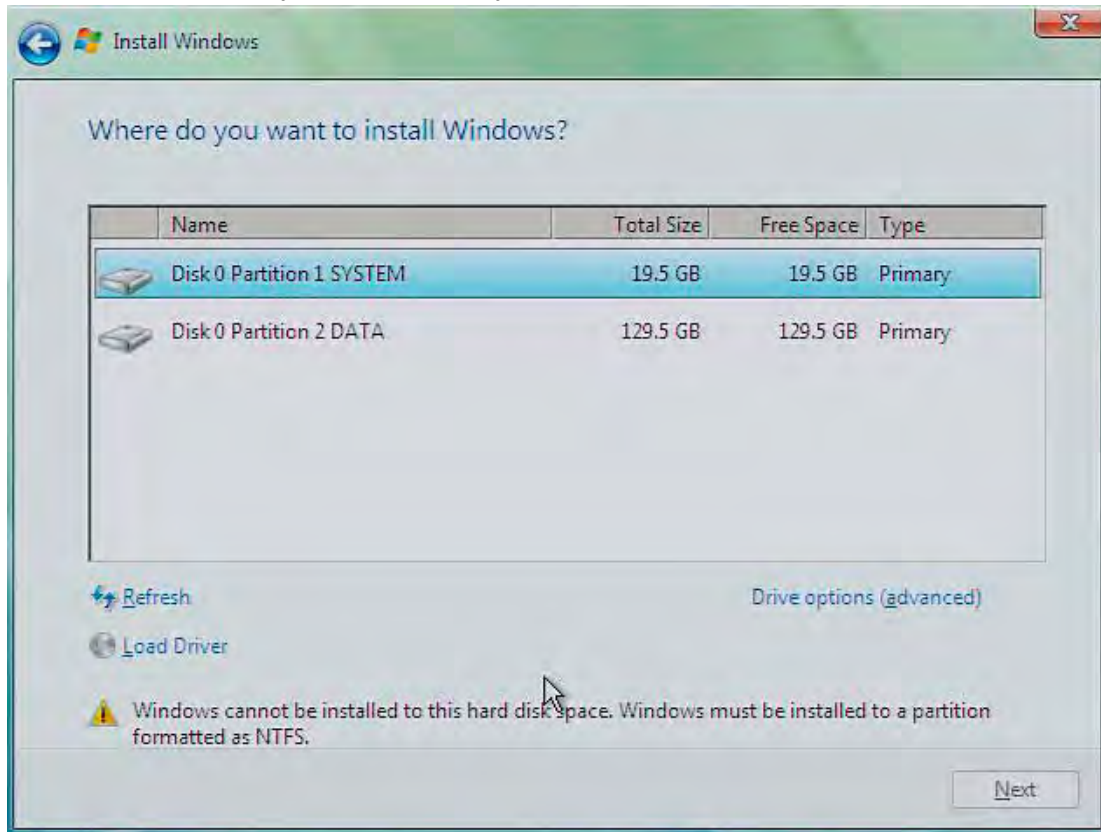

Options	Meaning
Drive options (advanced)	Further functions are displayed with which you can set up the hard disk.
Load Driver	To add new drivers, for example the driver for RAID.

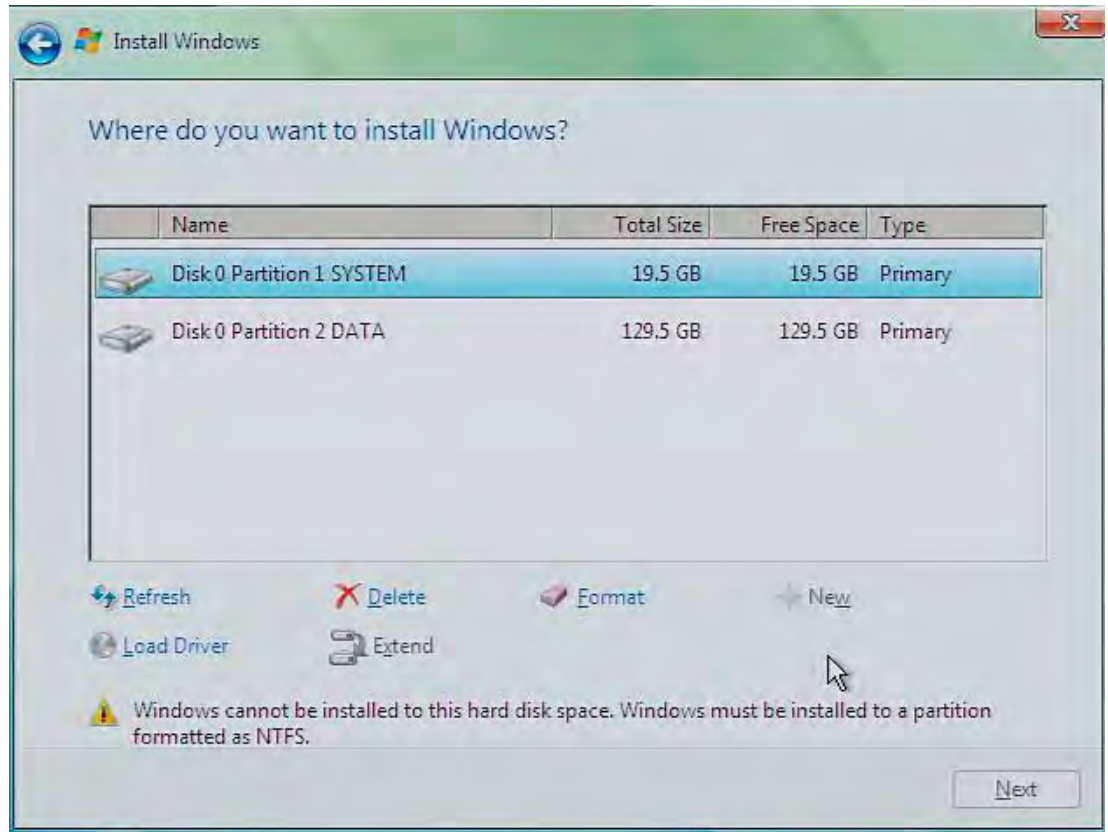

Options	Meaning
Refresh	Updating
Delete	Deleting a partition
Format	Formatting a partition
New	Creating new partitions
Load Driver	To add new drivers, for example the driver for RAID
Extend	Changing the partition size
	Any error messages that occur are displayed behind this icon, for example if the hard disk was not formatted in the required "NTFS" format.

The first partition should be at least 25 GB. The operating system must be installed on this partition. You can use the rest of the hard disk as a data partition. Both partitions must be installed as the NTFS file system.

When shipped, the partitions are set up as follows:

Partition	Operating system	Name	Size	File system
First	Windows Vista	SYSTEM	25 GB	NTFS not compressed
Second	Windows Vista	DATA	Remainder	NTFS not compressed

Following a reboot, Windows Vista is installed on the hard disk. This process takes at least 20 minutes.

Now follow the instructions on the screen.

Note

If you want to reinstall drivers from the integrated floppy disk drive, select Floppy Drive (A:).
If you want to reinstall drivers from a USB floppy disk drive, select Floppy Drive (B:).

Note

If you want to use Microsoft Windows as a professional user, you will need the following manual (not supplied):
Windows Vista Inside Out (MS Press No. 5913)

This manual contains information specifically for administrators involved in installing, managing and integrating Windows in networks or multi-user environments.

Setting up language options in Windows Vista

With the Multilanguage User Interface (MUI), you can set up the Windows menus and dialogs for additional languages. When shipped, Windows Vista is installed with English menus and dialogs. You can change this in the Control Panel with the "Regional and Language options" or "Time and Date" dialogs.

Here, you can change all system formats:

Start > Control Panel > Clock, Language, and Region > Change display language > Regional and Language options

Here, you can only change the date and time formats:

Start > Control Panel > Clock, Language, and Region > Change display language > Time and Date

If you want to install additional languages, you can install these later in the Control Panel, as follows. You will find the necessary files on the Recovery DVD in the "Languagepacks" folder.

Start > Control Panel > Clock, Language, and Region > Change display language > Regional and Language options > Keyboards and Languages

Additional languages can be integrated through Windows Update.

12.9 Partitioning the hard disk

12.9.1 Setting up the partitions under Windows XP Embedded

You need to set up the partitions on the Compact Flash card after installed a new Compact Flash card or to repair corrupt partitions or to change the partitioning.

Partitioning the Compact Flash card

The factory state of the Compact Flash card includes the following partitions:

Partition	Name	Size of card 2 GB	File system
1. Partition	SYSTEM	867 MB	NTFS (compressed)
2. Partition	DATA	Remainder *	NTFS (compressed)

* Due to partitioning/formatting, the actual capacity of the Compact Flash card does not match the memory size specified on the Compact Flash card.

In order to revert to the original factory state partitions, we recommend using the software tool "SIMATIC PC/PG Image Creator". Detailed information about using this tool is available in the manufacturer documentation.

12.9.2 Setting up partitions under Windows XP Professional / Windows 2000 MUI

Set up the hard disk partitions after having installed a new hard disk, or to repair faulty partitions, or to change the partitioning.

Partitioning the hard disk

The factory state of the hard disk with Windows XP/2000 includes the following partitions:

Partition	Name	Size	File system
1. Partition	SYSTEM	20 GB	NTFS (not compressed)
2. Partition	DATA	Remainder	NTFS (not compressed)

In order to revert to the original factory state partitions, we recommend using the software tool "SIMATIC PC/PG Image Creator". Detailed information about using this tool is available in the manufacturer documentation.

12.10 Installing drivers and software

12.10.1 Installing drivers and software

NOTICE

Before you install new drivers or updates for multilingual operating systems, (MUI versions), reset the regional settings for menus and dialogs and the default language to US English.

Install the drivers and software from the included "Documentation and Drivers" CD.
Procedure:

1. Place the CD into the drive.
2. Start the program with "START".
3. Select "Drivers / Tools" from the index.
4. Select the desired driver.
5. Install the required driver.

NOTICE

For new Windows 2000 / XP installations, the chipset driver must be installed before you install any other drivers.

12.10.2 Driver installation under Windows XP Embedded

The driver installation under Windows XP Embedded is conducted in the same way as under XP Professional. Pay attention to the installation instructions of the driver manufacturer.

When drivers are being installed under Windows XP Embedded, you may see a message that the Windows XP Installation CD or SP2 CD is required.

In this case, insert the Restore DVD. The required files are in the \Drivers_XPE folder.

12.11 Installing the RAID Controller software

Note

You find the procedure for installing the RAID controller software in the RAID user manual on the supplied "Documentation and Drivers" CD.

Windows 2000 Professional / XP Professional

You need to select the Intel 82801GR/GH SATA RAID Controller from the provided list when installing Windows 2000 Professional /XP Professional for the first time.

12.12 Installing the burner software

The supplied CD provides information about installation of the burner software.

12.13 Installing updates

12.13.1 Updating the operating system

Windows

The latest updates for Windows operating systems are available on the Internet at <http://www.microsoft.com>

NOTICE

Before you install new drivers or operating system updates for Windows MUI versions, set the default language to US English in the regional settings for menus and dialogs.

other operating systems

Please contact the corresponding manufacturer.

12.13.2 Installing or updating application programs and drivers

In order to install software from a CD and/or floppy disc under Windows XP Embedded / Windows XP Professional, the corresponding drive must be installed or connected.

For information about installation of SIMATIC software packages, refer to the respective manufacturer documentation.

For updates of drivers and application programs from third-party manufacturers, contact the respective manufacturer.

NOTICE

Before you install new drivers or operating system updates for Windows XP Professional MUI versions, set the default language to US English in the regional settings for menus and dialogs.

12.14 Data backup

12.14.1 Creating an image

Data backup under Windows XP Embedded/Windows XP Professional

To back up data under Windows XP Embedded / Windows XP Professional, we recommend the software tool "SIMATIC PC/PG Image Creator". This tool provides comfortable and efficient functions for backup and restoring the full content of Compact Flash cards, HDDs and individual partitions (images.)

Image Creator only supports burning to DVD media.

The software can be ordered from the Siemens A&D online ordering system. For detailed information about SIMATIC PC/PG Image Creator, please refer to the corresponding product documentation.

12.15 CP 1616 onboard

NDIS device driver

Read the information in the Device_Driver_CP16xx.pdf document on the supplied Documentation and Drivers CD.

PROFINET I/O

Please observe the information on the SIMATIC devices and SIMATIC NET documentation listed in the chapter "Integration".

Alarm, error, and system messages

13.1 Boot error messages

BIOS first performs a **Power On Self Test (POST)** within the boot routine to verify proper operation of certain functional units of the PC. If an error is detected within this phase, BIOS outputs a beep code based on the current test result. The boot sequence is interrupted immediately if fatal errors occur.

If the POST does not return an error, the BIOS initializes and tests further functional units. In this startup phase, the graphics controller is initialized and any error messages are output to the screen.

The error messages output by the system BIOS are listed below. For information on error messages output by the operating system or programs, refer to the corresponding manuals.

On-screen error messages

On-screen error message	Meaning / suggestions
Address conflict	Plug and Play problem. Contact your technical support team.
Combination not supported	Plug and Play problem. Contact your technical support team.
IO device IRQ conflict	Plug and Play problem. Contact your technical support team.
Invalid System Configuration Data	Plug and Play Problem <ul style="list-style-type: none"> • Set the RESET CONFIGURATION DATA option in the "Advanced" menu of Setup. • Contact your technical support team.
Allocation Error for ...	Plug and Play problem <ul style="list-style-type: none"> • Please undo the last hardware change. • Contact your technical support team.
System battery is dead. Replace and run SETUP	The battery on the CPU module is defective or dead. Contact your technical support team.
System CMOS checksum bad Run SETUP	Call up SETUP, adjust settings and save. If this message appears during each startup, contact your technical support team.
Failure Fixed Disk	Error accessing the hard drive. Check the SETUP settings. Contact your technical support team.
Keyboard error	Check whether the keyboard is properly connected.
Key seizure	Check whether a key on the keyboard has seized.

13.1 Boot error messages

On-screen error message	Meaning / suggestions
System RAM Failed at offset:	Memory error. Contact your technical support team.
Shadow RAM Failed at offset:	Memory error. Contact your technical support team.
Extended RAM Failed at offset:	Memory error. Contact your technical support team.
Failing Bits:	Memory error. Contact your technical support team.
Operating system not found	Possible causes: <ul style="list-style-type: none"> • No operating system present • Wrong drive addressed (disk in drive A/B) • Incorrect active boot partition • Wrong boot drive settings in SETUP • Hard disk is not connected / defective
Previous boot incomplete Default configuration used	Abort of the previous BOOT procedure, for example, due to a power failure. Adjust the settings in SETUP.
System cache error Cache disabled	Error in the CPU's cache module. Contact your technical support team.
Monitor type does not match CMOS Run SETUP	The monitor does not match the SETUP entries. Adapt the SETUP entries to the monitor.
System time-out	Hardware error. Contact your technical support team.
Real-time clock error	Clock chip error. Contact your technical support team.
Keyboard controller error	Keyboard error. Contact your technical support team.

13.2 Introduction to the BIOS beep codes

The device performs a self-test when it is switched on. If an error is detected during the POST (Power On Self-Test), a series of beep signals are issued. The beep tones are a code for errors and are composed of 2 x 2 sequences.

Table 13-1 Converting the beep codes in a Hex display

Beep tones		Hex code
B	B	0
B	BB	1
B	BBB	2
B	BBBB	3
BB	B	4
BB	BB	5
BB	BBB	6
BB	BBBB	7
BBB	B	8
BBB	BB	9
BBB	BBB	A
BBB	BBBB	B
BBBB	B	C
BBBB	BB	D
BBBB	BBB	E
BBBB	BBBB	F

Example

Tone sequence	B	BBB	BBB	B
Hex code	2		8	
Meaning	Determine RAM size			

13.3 BIOS beep codes

The following section lists the POST codes relevant to users in the sequence in which they occur: Contact Customer Support for information on all other POST codes.

Display (hex)	Meaning	Description	Remedy
16H	TP_CHECKSUM	BIOS checksum test	Service event
28H	TP_SIZE_RAM	Determine DRAM size	Replace the memory modules
2AH	TP_ZERO_BASE	Set base RAM 64KB to 0	Replace the memory modules
2CH	TP_ADDR_TEST	Check address busses	Replace the memory modules
2EH	TP_BASERAML	BaseRam Low	Replace the memory modules
30H	TP_BASERAMH	BaseRam High	Replace the memory modules
38H	TP_SYS_SHADOW	BIOS is copied to DRAM	Replace the memory modules
3AH	TP_CACHE_AUTO	Determine CPU cache	Exchange CPU
22H	TP_8742-TEST	Test keyboard controller	Check if keyboard is connected or defective
3CH	TP_ADV_CS_CONFIG	Configure the advanced chipset	Test by switching off the hardware components in Setup
49H	TP_PCI_INIT	Initialize the PCI interface	Run a test by disabling the hardware components in Setup, or by removing the expansion modules installed on the bus module
55H	TP_USB_INIT	Activation of the USB hardware	Removal of USB devices
4AH	TP_VIDEO	Initialize the video interface	
5CH	TP_MEMORY_TEST	Test of the system memory	Replace the memory modules
60H	TP_EXT_MEMORY	Test of the complete memory	Replace the memory modules
62H	TP_EXT_ADDR	Test of the address busses	Replace the memory modules
90H	TP_FDISK	Initialization and test of the hard disk hardware	Disconnect hard disk, replace if necessary
95H	TP_CD	Initialization and test of the CD hardware	Disconnect CD ROM, replace if necessary
98H	TP_ROM_SCAN	Search for BIOS expansions	Run a test by disabling the hardware components in Setup, or by removing the expansion modules installed on the bus module
BCH	TP_PARITY	Test of the memory modules	Replace the memory modules
00H		BIOS Power On Self Test completed. Loading operating system	

Special codes

The following special code are provided in addition to the beep codes:

Special code	Meaning
3x short	The <Ins> key is pressed during the system start: The on-board device installation is skipped. The on-board graphic controller is used as the default display.
1x long 8x short	Error reading the MPI system information. Contact customer service.
4x short	MPI-EPROM programmed for the first time.
1x long 5x short	Ethernet error Contact customer service.
2x short	Error in checksum test of the BIOS: This can occur following a battery replacement or when the battery is empty.

Troubleshooting/FAQs

14.1 General problems

This chapter provides you with tips on how to localize and troubleshoot frequently occurring problems.

Problem	Possible causes	Remedy
The device is not operational	There is no power supply to the device.	<ul style="list-style-type: none"> • Check the power supply, the network cable and the power plug. • Check if the On/Off switch is in the correct position.
	Device is being operated outside the specified ambient. conditions	<ul style="list-style-type: none"> • Check the ambient conditions. • After transport in cold weather, wait approximately 12 hours before switching on the device.
Windows no longer boots	Settings in the BIOS Setup are incorrect	<ul style="list-style-type: none"> • Check the setting in the BIOS Setup "SATA/PATA Configuration" submenu • Check the setting in the BIOS Setup Boot menu
The external monitor remains dark.	The monitor is switched off.	Switch on the monitor.
	The monitor is in "power save" mode.	Press any key on the keyboard.
	The brightness button has been set to dark.	Increase the screen brightness. For detailed information, refer to the monitor operating instructions.
	The power cord or the monitor cable is not connected.	<ul style="list-style-type: none"> • Check whether the power cord has been properly connected to the monitor and to the system unit or to the grounded shockproof outlet. • Check whether the monitor cable has been properly connected to the system unit and to the monitor.
		If the monitor screen still remains dark after you have performed these checks, please contact your technical support team.
The mouse pointer does not appear on the screen.	The mouse driver is not loaded.	Check if the mouse driver is correctly installed.
	The mouse is not connected.	<p>Check whether the mouse lead is connected to the system unit. If you are using an adapter or extension for the mouse lead, check the connectors.</p> <p>Should the mouse cursor still not be visible on-screen after completing these checks and measures, contact technical support.</p>
Wrong time and/or date on the PC.		<ol style="list-style-type: none"> 1. Press <F2> during the boot sequence to open BIOS Setup. 2. Set the time and date in the setup menu.

14.2 Problems when Using Modules of Third-party Manufacturers

Problem	Possible causes	Remedy
Although the BIOS setting is OK, the time and data are still wrong.	The backup battery is dead.	Replace the backup battery.
USB device not responding.	The USB ports are disabled in your BIOS.	Use a different USB port or enable the port.
	USB 2.0 device connected but USB 2.0 is disabled.	Enable USB 2.0.
	Operating system does not support the USB port.	Enable USB Legacy Support for the mouse and keyboard. For other devices you need the USB drivers for the respective operating system.
DVD: The front loader does not open.	The device is switched off or the open/close button is disabled by a software application.	Emergency removal of the data medium: <ol style="list-style-type: none"> 1. Switching off the device 2. Insert a pointed object, a pin for example, or an opened paper clip into the emergency extraction opening of the drive. Apply slight pressure to the contact until the front loader opens. 3. Pull the loader further out.

14.2 Problems when Using Modules of Third-party Manufacturers

Problem	Possible cause	Remedy
The PC crashes during startup	<ul style="list-style-type: none"> • Double allocation of I/O addresses • Double allocation of hardware interrupts and/or DMA channels • Signal frequencies or signal levels are incorrect. • Connector assignments deviate. • No "Reset Configuration" in BIOS Setup 	Check your computer configuration: <ul style="list-style-type: none"> • If the computer configuration corresponds with factory state, please contact your technical support team. • If the computer configuration has changed, restore the original factory settings. Remove all third-party modules, then restart the PC. If the error no longer occurs, the third-party module was the cause of the fault. Replace this module with a Siemens module or contact the module supplier. • Force a "Reset Configuration" using the BIOS Setup. If the PC still crashes, contact your technical support team.
	<ul style="list-style-type: none"> • If the performance of the external 24 V power supply is insufficient 	<ul style="list-style-type: none"> • use a larger power supply.

14.3 Temperature limits

Cause

If the device is used for its intended purpose, the temperature threshold values are not exceeded or fallen below. When the LED "Temp" on the upper left side of the operator control unit lights up, check the following:

- Are the fan apertures covered?
- Has the fan failed (check speed display in the SOM or on the DiagMonitor)?
- Is the ambient temperature higher than the allowed value (see "Technical data")?
- Is the total output of the power supply within the specified limit?
- Are the heatsinks inside the PC covered with dust?

Remedy

The temperature error is retained until the temperatures have fallen below the thresholds and you have acknowledged the error alarm in the SOM program. Click on the button with the "small broom" icon. When the error alarm has been acknowledged, the "TEMP" LED on the devices goes off and the title bar and "SOM" icon in the status bar of the SOM program changes from red to green. If you have not installed the SOM program or DiagMonitor, you must restart the PC.

Specifications

15.1 General specifications

Electrical specifications	
Supply voltage AC	Nominal 100 - 240 V AC (-15% / +10%), autorange
Supply voltage DC	Nominal 24 V DC (-15% / + 20%), SELV
AC device: Frequency	50 to 60 Hz, 47 to 63 Hz
Input current AC	Continuous current to 2.3 A (to 50 A for 1 ms at startup)
Input current DC	Continuous current to 9 A (to 14 A for 30 ms at startup)
Line voltage frequency	50 to 60 Hz (47 to 63 Hz)
Transient voltage interruption Namur	Max. 20 ms to (93 to 264 V) Max. 10 events per hour, min. recovery time 1 s
Maximum power consumption AC and DC	Effective power 190 W / 210 W Apparent power 250 VA / 275 VA
Maximum current	16.5 A (peak 18.5 A) at +5 V 8.5 A at +3.3 V The total power of the +5 V and 3.3 V voltage is 90 W maximum. 6.5 A (peak 8 A) at +12 V 0.3 A at -12 V The total power of all voltages is 150 W maximum.

Degree of protection	
Complete unit, rear	IP20
Degree of protection on front, screw mounted and backing plate (17" and 19") (does not apply to 12" touch panel)	IP54
Degree of protection on front, clamp mounted	IP65

Specifications

15.1 General specifications

Electromagnetic compatibility (EMC)	
AC device: Emitted interference	EN 55011 Class A, EN 61000-3-2 Class D EN 61000-3-3
DC device: Emitted interference	EN 55022 Class A
Noise immunity: Mains borne disturbance variables on supply lines	± 2 kV, according to IEC 61000-4-4, burst ± 1 kV, according to IEC 61000-4-5, surge sym. ± 2 kV, according to IEC 61000-4-5, surge asym.
Noise immunity on signal lines	± 1 kV, according to IEC 61000-4-4, burst, length < 5 m ± 2 kV, according to IEC 61000-4-4, burst, length > 5 m ± 2 kV, according to IEC 61000-4-5, surge, length > 30 m
Immunity to discharges of static electricity	± 6 kV contact discharge according to IEC 61000-4-2 ± 8 kV air discharge according to IEC 61000-4-2
Immunity to RF interference	10 V/m 80–1000 MHz, 80% AM according to IEC 61000-4-3 10 V/m 900 MHz and 1.89 GHz, 50% ED according to IEC 61000-4-3 10 V/m 9 KHz-80 MHz according to IEC 61000-4-6
Magnetic field	30 A/m, 50 Hz according to IEC 61000-4-8

Climatic conditions	
Temperature <ul style="list-style-type: none"> • During operation^{1) 2)} • Installed in cabinet: <ul style="list-style-type: none"> – With outside temperature of 40° C – With outside temperature of 45° C • Storage, transportation • Gradient 	Tested to IEC 60068-2-1, IEC 60068-2-2, IEC 60068-2-14 <ul style="list-style-type: none"> • +5° to +45° C (with maximum configuration) • Inside temperature max. 50° C (with total load of the slots with max. 15 W) • Inside temperature max. 45° C • -20° to +60° C • Maximum 10° C / h in operation, 20° C / h storage, no condensation
¹⁾ When DVD burner is in operation, an ambient temperature of +5° to +40° C is applicable.	
Relative humidity <ul style="list-style-type: none"> • During operation²⁾ • Storage, transportation • Gradient 	Tested to IEC 60068-2-78, IEC 60068-2-30 <ul style="list-style-type: none"> • 5 to 80% at 25° C (no condensation) • 5 to 95% at 25° C (no condensation) • Maximum 10° C / h, no condensation
²⁾ Under extreme environmental conditions such as high air humidity and temperature, bubbles can form on the touch surface in rare cases. This only affects the appearance and does not represent any functional restriction.	

Mechanical environmental conditions	
Vibration <ul style="list-style-type: none"> • Operation • Storage, transportation 	Tested to DIN IEC 60068-2-6 <ul style="list-style-type: none"> • 10 to 58 Hz: 0.075 mm, 58 to 500 Hz: 9.8 m/s² = 1 g (10 cycles) • 5 to 9 Hz: 3.5 mm, 9 to 500 Hz: 9.8 m/s² = 1 g (10 cycles)
Shock resistance <ul style="list-style-type: none"> • Operation • Storage, transportation 	Tested to IEC 60068-2-27, IEC 60068-2-29 <ul style="list-style-type: none"> • 50 m/s² approx. 5 g, 30 ms (3 cycles per axis) • 250 m/s² approx. 25 g, 6 ms (3 cycles per axis)
Noise emission	< 55 dB(A) according to DIN 45635-1

Motherboard	
Chipset	Intel 945 GM and ICH7R
Processor	<ul style="list-style-type: none"> • Intel © Celeron M 440 1.86 GHz 533 MHz Front Side Bus (FSB), 1024 KB Second Level Cache • Intel © Core 2 Duo 1.66 GHz T5500 667 MHz Front Side Bus 2048 KB Second Level Cache • Intel © Core 2 Duo 2.16 GHz T7400 667 MHz Front Side Bus, 4096 KB Second Level Cache
RAM	2 sockets maximum 2 GB SDRAM DDR2 533 MHz See order documentation for expansion memory
Buffer memory	512 KB SRAM 128 KB can be buffered over time
Free expansion slots	<ul style="list-style-type: none"> • 1 x PCI 265 mm long and 1x PCI 175 mm long • 1 x PCI 265 mm long and 1 x PCI express x4 174 mm long
Maximum permissible current consumption per PCI slot	<ul style="list-style-type: none"> • 5 V / 2 A or 3.3 V / 2 A, • 12 V / 0.3 A, • -12 V / 0.05 A <p>The total consumption (all slots) may not exceed 30 W.</p>

Disk drives	
Hard disks	2.5" or 3.5" Serial ATA, hard disk capacity see order documentation 3 Gbps data transfer rate Supports NCQ (Native Command Queuing) SATA II property
DVD burner	ATA 33, See order documentation for features

Specifications

15.1 General specifications

Interfaces	
DVI-I	Interface for external CRT / LCD monitor
USB	<ul style="list-style-type: none"> External: 4 x USB 2.0 on the interface side (max. 2 can be simultaneously operated as high current) Front panel interfaces: USB 2.0 high current
PROFIBUS/MPI interface <ul style="list-style-type: none"> Transmission rate Operating mode <ul style="list-style-type: none"> Physical interface <ul style="list-style-type: none"> Memory address area Interrupts 	9-pin sub-D socket <ul style="list-style-type: none"> 9.6 Kbps to 12 Mbps, configured per software Electrically isolated: <ul style="list-style-type: none"> Data channels A, B Control lines RTS AS, RTS_PG 5 V supply voltage (maximum 90 mA) Grounded: <ul style="list-style-type: none"> Shielding of the DP12 connection line <ul style="list-style-type: none"> RS485, electrically isolated (within SELV) <ul style="list-style-type: none"> Configured automatically Configured automatically
PROFINET ²⁾	3x RJ45 connection, CP 1616 compatible onboard interface based on ERTEC 400, 10/100 Mbps isolated
²⁾ For unambiguous labeling, the LAN interfaces are numbered on the enclosure. The operating system numbering may deviate from this.	
Ethernet	2x Ethernet interface (RJ45) 10/100/1000 Mbps Intel 82573 L
COM1	Serial interface, 9-pin Cannon plug
Compact Flash	Slot for Compact Flash card

Status displays	
Control unit	<ul style="list-style-type: none"> Power LED Temperature LED
Computer unit	<ul style="list-style-type: none"> Ethernet LEDs Optical drive LED

Display						
Graphics controller			Intel			
Graphics memory			Graphics memory; 8 to 132 MB, taken from RAM.			
Resolutions, frequencies, color depth			VGA: 1600 x 1200, 32-bit color depth, 85 Hz DVI-I: 1600 x 1200 / 32-bit color depth, 60 Hz LCD: 1280 x 1024, 18-bit color depth			
Color display ^{*)}	12" TFT Key panel	15" TFT Key panel	12" TFT Touch panel	15" TFT Touch panel	17" TFT Touch panel	19" TFT Touch panel
Resolution	800 x 600	1024 x 768	800 x 600	1024 x 768	1280 x 1024	1280 x 1024
Contrast ratio, typ.	600:1	450:1	450:1	450:1	800:1	700:1
Max. light density cd/m ² , typ.	350	250	350	250	300	300
Horizontal viewing angle right/left/typ./min.	70° / 60°	60° / 50°	70° / 60°	60° / 50°	typically 80°	typically 80°
Vertical viewing angle I above / typ. / min.	45° / 35°	40° / 30°	45° / 35°	40° / 30°	typically 80°	typically 80°
Vertical viewing angle I below / typ. / min.	55° / 45°	60° / 35°	55° / 45°	60° / 35°	typically 80°	typically 80°
*) A small number of faults in the display is unavoidable. However, the displays do comply with the described quality standards of the ISO standard 13406-2, class 2.						
*) Bad pixels			Permissible number			
<ul style="list-style-type: none"> • Permanently bright, dark pixels • Permanently bright, green pixels 			<ul style="list-style-type: none"> • ≤ 12 • ≤ 5 			

Front						
	12" TFT Key panel	15" TFT Key panel	12" TFT Touch panel	15" TFT Touch panel	17" TFT Touch panel	19" TFT Touch panel
Service life of backlighting	50,000 h for 24 h continuous operation, temperature dependent, remaining brightness 50%					
Membrane keyboard with alphanumeric and numeric keys	X		—			
Function keys	36 with LED		—			
Direct control key module	optional		—			
Actuating force (test pen with 3 mm radius)	Maximum 3 N		—			
Cycles (operation)	> 1 million		—			
Resistive analog touch screen	—		X			
Touch force (with test pen 2 mm diameter)	—		5 N			

Specifications

15.1 General specifications

Front						
	12" TFT Key panel	15" TFT Key panel	12" TFT Touch panel	15" TFT Touch panel	17" TFT Touch panel	19" TFT Touch panel
Slide-in labels for function keys	X		—			
Front-mounted integrated mouse	X		—			

Power loss *)						
	12" TFT Key panel	15" TFT Key panel	12" TFT Touch panel	15" TFT Touch panel	17" TFT Touch panel	19" TFT Touch panel
Efficiency of the power supply 86%						
Control unit	30 W	30 W	30 W	30 W	50 W	53 W
Computer unit	75 W	75 W	75 W	75 W	75 W	75 W
PCI cards (17.5 W each)	35 W	35 W	35 W	35 W	35 V	35 W
Panel PC 677B	105 W	105 W	105 W	105 W	125 W	128 W
Panel PC with 2 PCI plug-in cards	140 W	140 W	140 W	140 W	160 W	163 W
*) The specified values apply to the maximum configuration of the device						

Weight						
Panel PC 677B	12" TFT Key panel	15" TFT Key panel	12" TFT Touch panel	15" TFT Touch panel	17" TFT Touch panel	19" TFT Touch panel
Weight of complete unit	11.89 kg	16.01 kg	12.51 kg	14.44 kg	17.2 kg	16.8 kg
Control unit	4.89 kg	9.01 kg	5.51 kg	7.44 kg	10.2 kg	9.8 kg

Safety	
Protection class	Protection class I to IEC 60536, i.e.: Device with PE ground terminal
Standards	IEC 60950-1, EN 60950-1, DIN EN 60950-1, EN 61131-2
Approvals	AC device: cULus in accordance with UL 60950-1 DC device: cULus in accordance with UL 508
Conformity	CE
Degree of protection	<ul style="list-style-type: none"> With clamp mount, encircling seal and pressed-on plastic cap for USB interface*)
	<ul style="list-style-type: none"> With screw mount
Liability of product nonconformance	24 months
Quality assurance	According to ISO 9001
*) The front USB interface cannot be used in some devices.	

Permissible temperature ranges depend on the type of installation

Panel PC 677B			
Complete unit	Temperature in cabinet	Ambient temperature Cabinet	Comment
Installed in cabinet, different temperatures	50 °C	40 °C	<ul style="list-style-type: none"> Maximum PCI load 15 W Optical drives may not be operated with a temperature > 40° C.
Installed in cabinet, same temperature inside and outside	45 °C	45 °C	<ul style="list-style-type: none"> Complete configuration, maximum PCI load 30 W (2 slots)
Computer unit and control unit separated, using Remote Kit			
12" control unit	50° C	45° C	
15" control unit	50° C	45° C	
17" control unit	50° C	45° C	
19" control unit	50° C	45° C	The US interface of the Remote Kit (rear USB interface) may not be used when the 19" panel is operated in an enclosure with an inside temperature between 45° and 50° C.
Computer unit 677B, Intel © Core 2 Duo	55° C	-	<ul style="list-style-type: none"> No PCI modules plugged. Optical drives may not be operated with a temperature > 40° C.
These values are applicable for vertical installation and when air is flowing through the cabinet.			

15.2 Technical data for device with stainless steel front

Additional information for devices with stainless steel front

Outer dimensions W x H x D	483 x 310 x 155 mm
Mounting cut-out (W x H)	450 x 290 mm
Exterior dimensions of the clamping frame W x H	495 x 322 mm
Mounting depth	150 mm
Degree of protection <ul style="list-style-type: none"> Front panel Back page 	<ul style="list-style-type: none"> IP66 K IP20
Control panel panel thickness	Min. 1.5 mm Max. 5,0 mm
Weight	Approx. 15 kg

15.3 Power requirements of the components

Basic device

Components	Voltage			
	+5 V	+3.3 V	+12 V	-12 V
Motherboard	3 A	5.8 A	0.01 A	0.02 A
Core 2 Duo or Celeron M processor	7 A			
Hard diskdrive; 1x 3.5" or Hard disk-drive; 2x 2.5" ¹⁾	0.6 A		0.8 A	
DVD burner drive ¹⁾	0.8 A			
Device fan			0,4 A	
Power supply fan			0,15 A	
Total (base device)	11.4 A	5.8 A	1.36 A	0.02 A
PCI / PCIexpress slots (total)	4 A	²⁾	0.6 A	0.20 A
Front panel port	1.05 A	0.1 A	3.5 A	
Single lines of current (max. permissible)	16.5 A ³⁾	8.5 A ³⁾	6.5 A	0.3 A

Total power (max. permissible)	150 W
---------------------------------------	-------

¹⁾ Depends on the selected device configuration

²⁾ The PCI slots can be operated both 5 V and on 3.3 V at the same power loss.

³⁾ The max. permitted accumulated power of the +5 V and + 3.3 V is 90 W

15.4 Device with AC voltage supply

Specifications

Input voltage	100 V - 240 V AC (85 V - 265 V) autorange
Input current	Continuous current up to 2.3 A, starting current 23 A < 5 ms
Frequency	50 to 60 Hz, 47 to 63 Hz
Power consumption	Max. 140 W for 12" and 15" control unit ¹⁾ Max. 163 W for devices with 17" and 19" control unit ¹⁾
Power failure buffering	20 ms
Maximum continuous output power	150 Watts
Degree of protection	IP20 (in installed state)
Protection class	VDE 0106

¹⁾ 15 W per PCI slot included

Output voltages

Voltage	Max. current
+ 12 V	6.5 A peak 8 A
- 12 V	0.3 A
+ 5 V	16.5 A ²⁾ Peak 18.5 A
+ 3.3 V	8.5 A ²⁾

²⁾ The max. permitted accumulated power of the +5 V and + 3.3 V is 90 W.

Power Good Signal of the AC power supply

Power-Good-Signal:

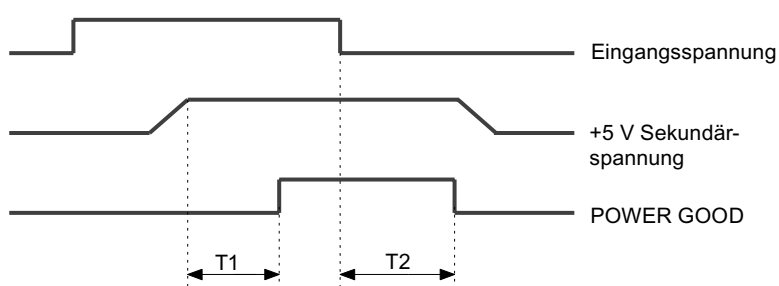

T1: preset time 50 ... 500 ms
T2: hold-up time 20 ms minimum

15.5 Device with DC voltage supply

Specifications

Input voltage	24 V DC (20.4 to 28.8 V DC)
Input current	Continuous current to 9 A (to 14 A for 30 ms at startup)
Power consumption	Max. 140 W for 12" and 15" control unit ¹⁾ Max. 163 W for devices with 17" and 19" control unit ¹⁾
Power failure buffering	20 ms at nominal voltage
Maximum continuous output power	150 Watts
Degree of protection	IP20 (in installed state)
Protection class	VDE 0106

¹⁾ 15 W per PCI slot included

Output voltages

Voltage	Max. current
+ 12 V	6.5 A peak 8 A
- 12 V	0.3 A
+ 5 V	16.5 A ¹⁾ Peak 18.5 A
+ 3.3 V	8.5 A ¹⁾

¹⁾ The max. permitted accumulated power of the +5 V and + 3.3 V is 90 W.

Power Good Signal of the DC power supply

Power-Good-Signal:

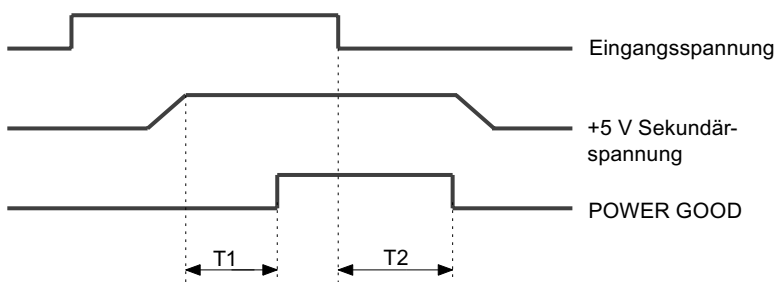

T1: preset time 50 ... 500 ms
T2: hold-up time 20 ms minimum

15.6 Keyboard table

Key codes

The following table applies only to control units with key panels. It contains all characters that can be entered in SIMATIC KeyTools in the "Key code table" area and under "User specific". The character that is triggered by pressing a specific key is listed in the "Display/function" column. Further information is available in the documentation for SIMATIC KeyTools on the "Documentation and Drivers" CD.

Name	Code (Hex) 0x	Check-box	Display/function
a A	4	—	a
		L Shift/R Shift	A
		R Alt	á
		R Alt+L Shift/R Shift	Á
b B	5	—	b
		L Shift/R Shift	B
c C	6	—	c
		L Shift/R Shift	C
		R Alt	©
		R Alt+L Shift/R Shift	ç
		L Ctrl/R Ctrl	Copy
d D	7	—	d
		L Shift/R Shift	D
		R Alt	ð
		R Alt+L Shift/R Shift	Ð
e E	8	—	e
		L Shift/R Shift	E
		R Alt	é
		L Shift/R Shift	É
		L Gui/R Gui	Start Windows Explorer
f F	9	—	f
		L Shift/R Shift	F
		L Gui/R Gui	Find folder and file
g G	0A	—	g
		L Shift/R Shift	G
h H	0B	—	h
		L Shift/R Shift	H
i I	0C	—	i
		L Shift/R Shift	I
		R Alt	í
		R Alt+L Shift/R Shift	Í
j J	0D	—	j
		L Shift/R Shift	J

Name	Code (Hex) 0x	Check-box	Display/function
k K	0E	—	k
		L Shift/R Shift	K
l L	0F	—	l
		L Shift/R Shift	L
		R Alt	ø
		R Alt+L Shift/R Shift	Ø
m M	10	—	m
		L Shift/R Shift	M
		R Alt	μ
		L Gui/R Gui	Minimize all windows
n N	11	—	n
		L Shift/R Shift	N
		R Alt	ñ
		R Alt+L Shift/R Shift	Ñ
o O	12	—	o
		L Shift/R Shift	O
		R Alt	ó
		R Alt+L Shift/R Shift	Ó
		L Ctrl/R Ctrl	Open
p P	13	—	p
		L Shift/R Shift	P
		R Alt	ö
		R Alt+L Shift/R Shift	Ö
		L Ctrl/R Ctrl	Printing
q Q	14	—	q
		L Shift/R Shift	Q
		R Alt	ä
		R Alt+L Shift/R Shift	Ä
r R	15	—	r
		L Shift/R Shift	R
		R Alt	®
		L Gui/R Gui	Display "Run" dialog
s S	16	—	s
		L Shift/R Shift	S
		R Alt	ß
		R Alt+L Shift/R Shift	§
		L Ctrl/R Ctrl	Save
t T	17	—	t
		L Shift/R Shift	T
		R Alt	þ
		R Alt+L Shift/R Shift	Þ

Name	Code (Hex) 0x	Check-box	Display/function
u U	18	—	u
		L Shift/R Shift	U
		R Alt	ú
		R Alt+L Shift/R Shift	Ú
v V	19	—	v
		L Shift/R Shift	V
		L Ctrl/R Ctrl	Paste
w W	1A	—	w
		L Shift/R Shift	W
		R Alt	â
		R Alt+L Shift/R Shift	Â
x X	1B	—	x
		L Shift/R Shift	X
		L Ctrl/R Ctrl	Cut
y Y	1C	—	y
		L Shift/R Shift	Y
		R Alt	ÿ
		R Alt+L Shift/R Shift	ÿ
z Z	1D	—	z
		L Shift/R Shift	Z
		R Alt	æ
		R Alt+L Shift/R Shift	Æ
		L Ctrl/R Ctrl	
1 !	1E	—	1
		L Shift/R Shift	!
		R Alt	¡
		R Alt+L Shift/R Shift	¡
2 @	1F	—	2
		L Shift/R Shift	@
		R Alt	²
3 #	20	—	3
		L Shift/R Shift	#
		R Alt	³
4 \$	21	—	4
		L Shift/R Shift	\$
		R Alt	¤
		R Alt+L Shift/R Shift	£
5 %	22	—	5
		L Shift/R Shift	%
		R Alt	€
6 ^	23	—	6
		L Shift/R Shift	^

Name	Code (Hex) 0x	Check-box	Display/function
		R Alt	¼
7 &	24	—	7
		L Shift/R Shift	&
		R Alt	½
8 *	25	—	8
		L Shift/R Shift	*
		R Alt	¾
9 (26	—	9
		L Shift/R Shift	(
		R Alt	'
0)	27	—	0
		L Shift/R Shift)
		R Alt	'
Return	28	—	Return
Escape	29	—	Escape
Backspace	2A	—	Backspace
Tab	2B	—	Tab
Space	2C	—	Space
- _	2D	—	-
		L Shift/R Shift	_
		R Alt	¥
= +	2E	—	=
		L Shift/R Shift	+
		R Alt	×
		R Alt+L Shift/R Shift	÷
[{	2F	—	[
		L Shift/R Shift	{
		R Alt	«
] }	30	—]
		L Shift/R Shift	}
		R Alt	»
\	31	—	\
		L Shift/R Shift	
		R Alt	¬
		R Alt+L Shift/R Shift	¡
Europe 1	32	—	Europe 1
; :	33	—	;
		L Shift/R Shift	:
		R Alt	¶
		R Alt+L Shift/R Shift	°
' "	34	—	'
		L Shift/R Shift	"

Name	Code (Hex) 0x	Check-box	Display/function
		R Alt	'
		R Alt+L Shift/R Shift	''
' ~	35	—	'
		L Shift/R Shift	~
, <	36	—	,
		L Shift/R Shift	<
		R Alt	ç
		R Alt+L Shift/R Shift	Ç
. >	37	—	.
		L Shift/R Shift	>
/ ?	38	—	/
		L Shift/R Shift	?
		R Alt	ı
Caps Lock	39	—	Caps Lock
F1	3A	—	F1
		L Shift/R Shift	F13
		L Ctrl/R Ctrl	S5
F2	3B	—	F2
		L Shift/R Shift	F14
		L Ctrl/R Ctrl	S6
F3	3C	—	F3
		L Shift/R Shift	F15
		L Ctrl/R Ctrl	S7
F4	3D	—	F4
		L Shift/R Shift	F16
		L Ctrl/R Ctrl	S8
F5	3E	—	F5
		L Shift/R Shift	F17
		L Ctrl/R Ctrl	S9
F6	3F	—	F6
		L Shift/R Shift	F18
		L Ctrl/R Ctrl	S10
F7	40	—	F7
		L Shift/R Shift	F19
		L Ctrl/R Ctrl	S11
F8	41	—	F8
		L Shift/R Shift	F20
		L Ctrl/R Ctrl	S12
F9	42	—	F9
		L Shift/R Shift	S1
		L Ctrl/R Ctrl	S13
F10	43	—	F10

15.6 Keyboard table

Name	Code (Hex) 0x	Check-box	Display/function
		L Shift/R Shift	S2
		L Ctrl/R Ctrl	S14
F11	44	—	F11
		L Shift/R Shift	S3
		L Ctrl/R Ctrl	S15
F12	45	—	F12
		L Shift/R Shift	S4
		L Ctrl/R Ctrl	S16
Print Screen, FN+INS	46	—	Print Screen, FN+INS
Scroll Lock	47	—	Scroll Lock
Break, Ctrl+Pause	48	—	Break, Ctrl+Pause
Pause	48	—	Pause
Insert	49	—	Insert
Home	4A	—	Home
Page Up	4B	—	Page Up
Delete	4C	—	Delete
End	4D	—	End
Page Down	4E	—	Page Down
Right Arrow	4F	—	Right Arrow
Left Arrow	50	—	Left Arrow
Down Arrow	51	—	Down Arrow
Up Arrow	52	—	Up Arrow
Num Lock	53	—	Num Lock
Keypad /	54	—	Keypad /
Keypad *	55	—	Keypad *
Keypad -	56	—	Keypad -
Keypad +	57	—	Keypad +
Keypad Enter	58	—	Keypad Enter
Keypad 1 End	59	—	Keypad 1 End
Keypad 2 Down	5A	—	Keypad 2 Down
Keypad 3 PageDn	5B	—	Keypad 3 PageDn
Keypad 4 Left	5C	—	Keypad 4 Left
Keypad 5	5D	—	Keypad 5
Keypad 6 Right	5E	—	Keypad 6 Right
Keypad 7 Home	5F	—	Keypad 7 Home
Keypad 8 Up	60	—	Keypad 8 Up
Keypad 9 PageDn	61	—	Keypad 9 PageDn
Keypad 0 Insert	62	—	Keypad 0 Insert
Keypad . Delete	63	—	Keypad . Delete
Europe 2	64	—	Europe 2
App	65	—	App
Keyboard Power	66	—	Keyboard Power

Name	Code (Hex) 0x	Check-box	Display/function
Keypad =	67	—	Keypad =
F13	68	—	F13
F14	69	—	F14
F15	6A	—	F15
F16	6B	—	F16
F17	6C	—	F17
F18	6D	—	F18
F19	6E	—	F19
F20	6F	—	F20
F21	70	—	F21
F22	71	—	F22
F23	72	—	F23
F24	73	—	F24
Left Control	E0	—	Left Control
Left Shift	E1	—	Left Shift
Left Alt	E2	—	Left Alt
Left GUI	E3	—	Left GUI
Right Control	E4	—	Right Control
Right Shift	E5	—	Right Shift
Right Alt	E6	—	Right Alt
Right GUI	E7	—	Right GUI

Dimensional drawings

16.1 Dimensional drawings Panel PC 677B

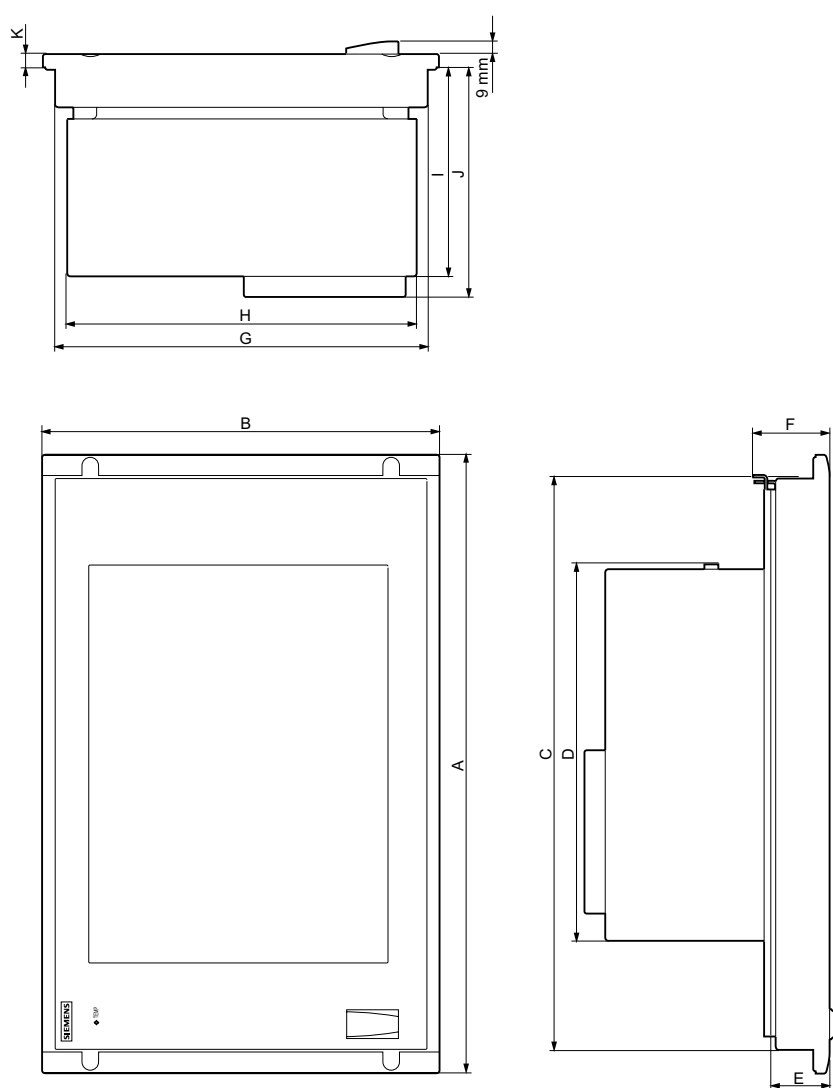

Figure 16-1 Dimensional drawings Panel PC 677B

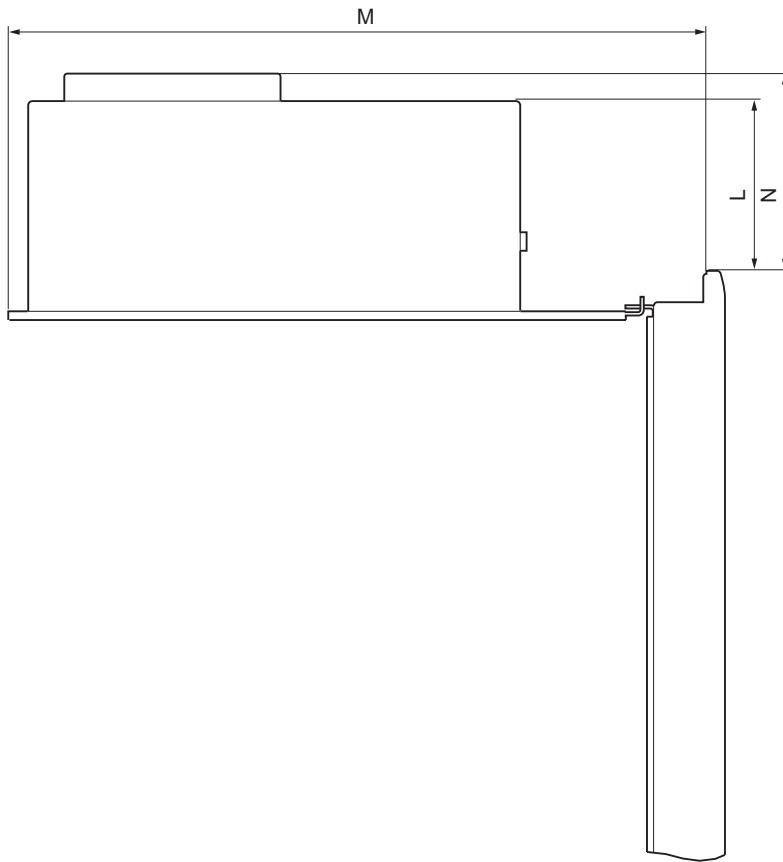

Figure 16-2 Panel PC 677B dimensional drawing, computer unit swung away from control unit

Table 16-1 Panel PC 677B dimensions in mm

Control unit	Key panel		Touch panel		
	12" TFT	15" TFT	12" TFT	15" TFT	17" TFT 19" TFT
A	482,6	482,6	400,0	482,6	482,6
B	310,3	354,8	310,3	310,3	400,0
C	447,2	447,2	366,0	450,0	450,0
D	314,9	314,9	314,9	314,9	314,9
E	30,8	49,8	37,8	46,6	56,1
F	39,8	59,8	48,3	58,6	68,1
G	288,3	324,4	288,3	288,3	378,0
H	270,4	270,4	270,4	270,4	270,4
I	104,5	123,5	123,0	120,3	129,5
J	121,9	140,9	141	138	147
K	10,5	10,5	10,5	10,5	10,8
L	41,9	30,0	53,4	24,4	18,4
M	350,6	369,0	369,1	366,5	375,6
N	59,3	48,1	70,8	41,8	35,8

16.2 Dimensional drawings for the installation of expansion modules

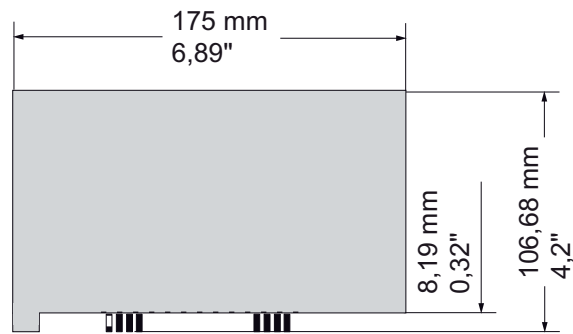

Figure 16-3 Short PCI module (5V)

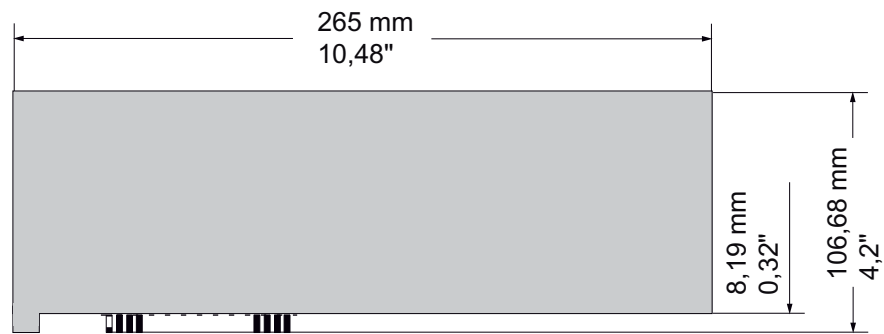

Figure 16-4 Maximum size of PCI module

Detailed descriptions

17.1 Motherboard

17.1.1 Structure and functions of the motherboard

The essential components of the motherboard are the processor and the chip set, two slots for memory modules, internal and external interfaces and the Flash BIOS.

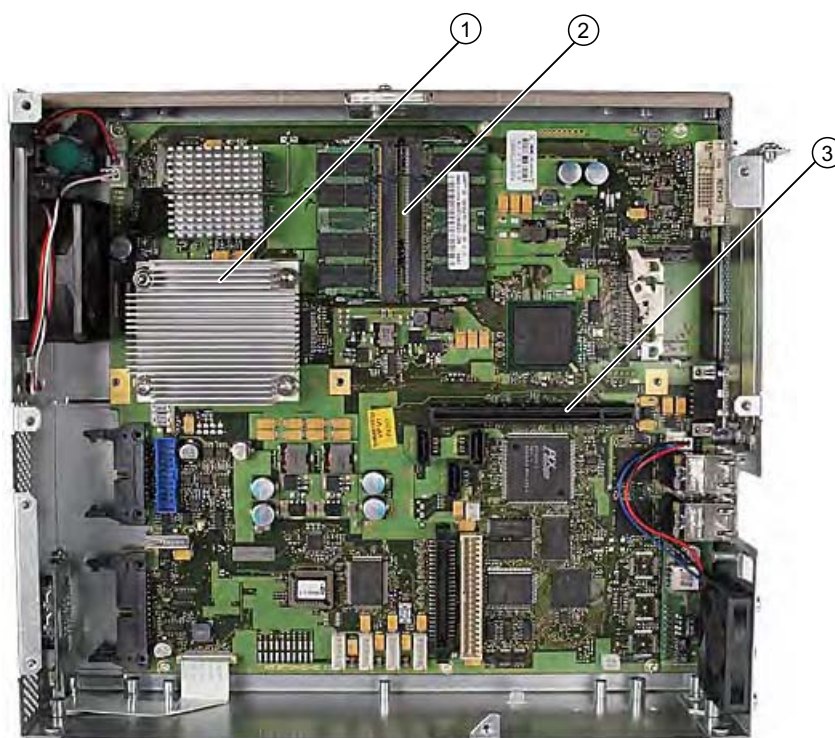

(1)	Processor heat sink
(2)	Two memory module slots
(3)	Slot for the bus board

17.1.2 Technical features of the motherboard

Component / interface	Description	Characteristics
Chip set	Single chip set	<ul style="list-style-type: none"> Intel 945 GM and ICH7R
BIOS	Update by means of software	<ul style="list-style-type: none"> Phoenix BIOS V05.01.xx (with Profibus)
CPU	Intel © Core 2 Duo / Intel © Celeron M	<ul style="list-style-type: none"> On-board L2 cache with 4096/2048/1024 KB
Memory	2 DIMM module slots, max. 2 GB/DIMM	<ul style="list-style-type: none"> 64-bit data bus width 3.3 V SDRAM DDR2 Up to 2048 Mbit chip size on the module 533/667 MHz bus clock (depending on CPU type) 512 MB to 2 GB/DIMM variable
Graphics	integrated in chip set	<ul style="list-style-type: none"> Mobile Intel 945GM Express Chipset Family, compatible with Graphics Media Accelerator 950 VGA: 1600x1200/32-bit color depth/85 Hz DVI-I: 1600x1200/32-bit color depth/60 Hz LCD: 1280x1024/18 bit colors Graphics memory: 8-128 MB, uses dynamic sharing of system RAM
Hard disk	2 channels, Serial ATA	<ul style="list-style-type: none"> Serial ATA 3 Gbps
RAID	On-board Serial ATA	<ul style="list-style-type: none"> Intel 82801 FR SATA RAID controller RAID 0, 1, 0+1
DVD burner (depends on the selected device configuration)	Master on parallel ATA interface	<ul style="list-style-type: none"> UDMA-capable, ATA33
PROFIBUS/MPI optional	Communication interface SIMATIC S7	<ul style="list-style-type: none"> Electrically isolated ¹ CP 5611 compatible 12 Mbps ¹⁾ Electrically isolated within SELV
PROFINET optional	Communications interface for PROFINET IO applications and SIMATIC installations	<ul style="list-style-type: none"> 10/100 Mbps, isolated; isolation within the SELV CP 1616 compatible 3-port interface
USB	Universal Serial Bus	<ul style="list-style-type: none"> External: 4 x USB 2.0 on the interface side (max. 2 can be simultaneously operated as high current) Front panel interfaces: USB 2.0 high current
Ethernet	2x 10BaseT/100Base-TX / 1000Base-TX	<ul style="list-style-type: none"> 10/100/1000 Mbit, isolated; isolation within the SELV

17.1.3 Position of the interfaces on the motherboard

Ports

The motherboard of the device features the following interfaces:

- Interfaces for the connection of external devices
- Interfaces for internal components (drives, bus boards etc.)

The figure below shows the location of the internal and external interfaces on the motherboard.

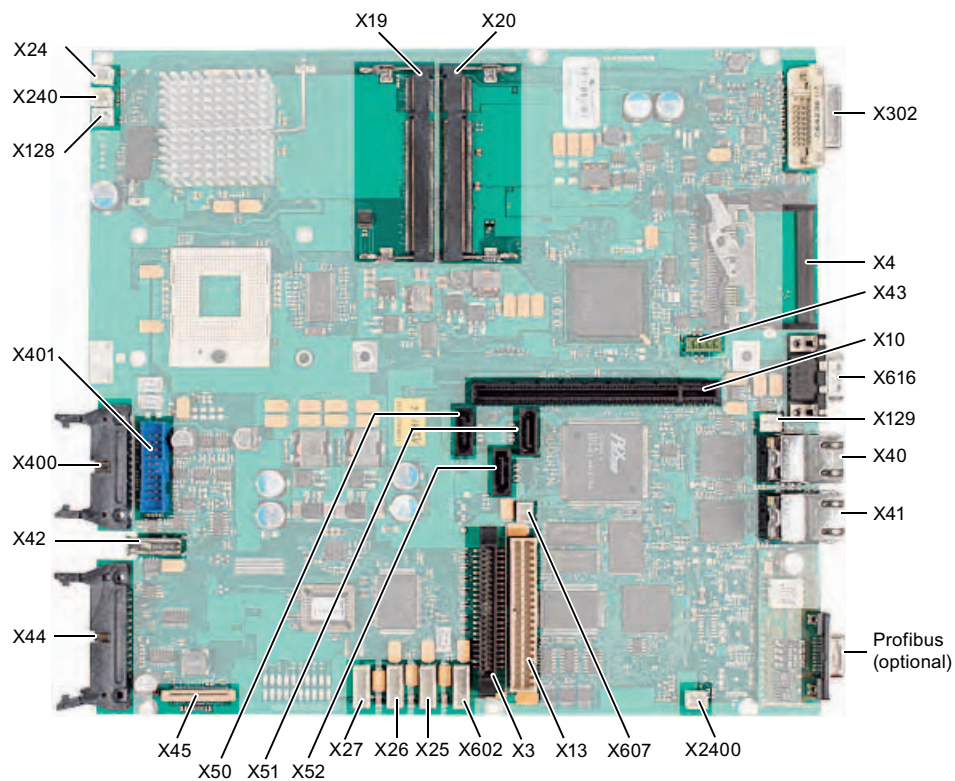

Figure 17-1 Interfaces on the motherboard

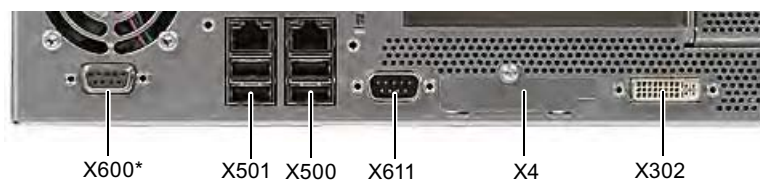

Figure 17-2 Connector pin assignment on the port

* Optional product variant

17.1.4 External ports

Interface	Position	Connector	Description
USB 2.0	external	X40 X41	Lower USB channel 0, upper USB channel 2 Lower USB channel 4, upper USB channel 5
PROFIBUS/MPI	external		9-pin, standard socket, electrically isolated interface
PROFINET	External		Three RJ45 ports
Ethernet	external	X40 X41	First RJ45 port Second RJ45 port
DVI-I	external	X302	26-pin socket
Compact Flash	external	X4	50-pin CF socket, types I / II
COM1	external	X616	Serial port

USB ports, X40, X41

The Universal Serial Bus interfaces have the following pinout:

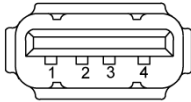
USB interface			
			
Pin no.	Short description	Meaning	Input / output
1	VCC	+ 5 V (fused)	Output
2	- Data	Data channel	Input / output
3	+ Data	Data channel	Input / output
4	GND	Ground	-

The connectors are of type A.

All ports are designed as high current USB (500 mA), you can only use a maximum of 2 simultaneously as high current, however.

CAUTION
No USB devices can be connected which feed back voltage to the Box PC.

PROFIBUS/MPI interface

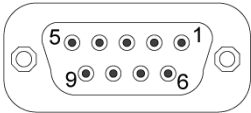
PROFIBUS/MPI interface ¹			
			
Pinno.	Short description	Meaning	Input / output
1	–	Unassigned	–
2	–	Unassigned	–
3	LTG_B	Signal line B of MPI module	Input/output
4	RTS_AS	RTSAS, control signal for received data stream. The signal is "1" when the directly connected AS is sending.	Input
5	M5EXT	M5EXT return line (GND) of 5 V supply. The current load of an external consumer connected between P5EXT and M5EXT may not exceed the 90 mA.	Output
6	P5 EXT	P5EXT power supply (+5 V) of the 5 V power supply. The current load of an external consumer connected between P5EXT and M5EXT may not exceed the 90 mA.	Output
7	–	Unassigned	–
8	LTG_A	Signal line A of the MPI module	Input/output
9	RTS_PG	RTS output signal of the MPI module. The control signal is "1" when the programming device is sending.	Output
Shield		on connector casing	

¹ Optional product variant

PROFINET LAN X1 Port P1, P2, P3

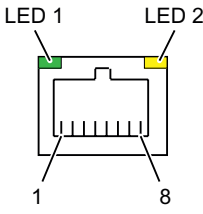
PROFINET interface			
			
Pinno.	Short description	Meaning	Input / output
1	RD+	Receive data *	Input
2	RD-	Receive data *	Input
3	TD+	Transmit data *	Output
4, 5 ¹⁾	SYMR	Internal with 75 Ohm terminating resistor	–
6	TD-	Receive data *	Output
7, 8 ¹⁾	SYMT-	Internal with 75 Ohm terminating resistor	–
S		Shield	
	LED 1	Lit green: link	
	LED 2	Lights up yellow: activity	
* Auto negotiation and auto crossover supported			

Ethernet RJ45 connection, X40, X41

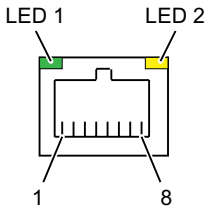
Ethernet RJ45 connection			
 <p>The diagram shows a top-down view of an Ethernet RJ45 connector. It features two LEDs: LED 1 is green and located on the left side, while LED 2 is orange and located on the right side. Below the LEDs, the connector has eight pins, with pin 1 on the left and pin 8 on the right. The connector is shown in a perspective view, highlighting its rectangular shape and the internal contacts.</p>			
Pinno.	Short description	Meaning	Input / output
1	BI_DA+	Bi-directional data A+	Input / output
2	BI_DA-	Bi-directional data A-	Input / output
3	BI_DB+	Bi-directional data B+	Input / output
4	BI_DC+	Bi-directional data C+	Input / output
5	BI_DC-	Bi-directional data C-	Input / output
6	BI_DB-	Bi-directional data B-	Input / output
7	BI_DD+	Bi-directional data D+	Input / output
8	BI_DD-	Bi-directional data D-	Input / output
S		Shield	–
	LED 1	Off: 10 Mbps Lit in green color: 100 Mbps Lit in orange color: 1000 Mbps	–
	LED 2	Lit: Active connection (to a hub, for example) Flashing: Activity	–

DVI-I port, X302

DVI-I port			
Pinno.	Short description	Meaning	Input / output
S	GND	Ground	–
S1	GND	Ground	–
C1	R	Red	Output
C2	G	Green	Output
C3	B	Blue	Output
C4	HSYNC	Horizontal synchronizing pulse	Output
C5	GND	Ground	–
CSA	GND	Ground	–
1	TX2N	TDMS data 2-	Output
2	TX2P	TDMS data 2+	Output
3	GND	Ground	–
4	NC	Unassigned	–
5	NC	Unassigned	–
6	DDC CLK	DDC clock	Input / output
7	DDC CLK	DDC data	Input / output
8	VSYNC	Vertical synchronizing pulse	Output
9	TX1N	TDMS data 1-	Output
10	TX1P	TDMS data 1+	Output
11	GND	Ground	–
12	NC	Unassigned	–
13	NC	Unassigned	–
14	+5 V	+5 V	Output
15	GND	Ground	–
16	MONDET	Hotplug detect	Input
17	TX0N	TDMS data 0-	Output
18	TX0P	TDMS data 0+	Output
19	GND	Ground	–
20	NC	Unassigned	–
21	NC	Unassigned	–
22	GND	Ground	–
23	TXCP	TDMS clock +	Output
24	TXCN	TDMS clock -	Output

Compact Flash card, X4

Compact Flash card port		
Pin no.	Short description	Meaning
41	RESET#	Reset (output)
7	CS0#	Chip select 0(output)
32	CS1#	Chip select 1(output)
34	IORD#	I/O read (output)
35	IOWR#	I/O write (output)
20, 19, 18,	A0-A2	Address bit 0-2 (output)
17, 16, 15, 14, 12, 11, 10, 8	A3-A10	Address bit 3-10 (output) to ground
21, 22, 23, 2, 3, 4, 5, 6, 47, 48, 49, 27, 28, 29, 30, 31	D0-D15	Data bits 0-15 (in/out)
37	INTRQ	Interrupt request (input)
9	OE# /ATA SEL#	Enables True IDE mode
24	IOCS16#	I/O-chip select 16 (input)
39	CSEL#	Cable select (output)
42	IORDY	I/O ready (input)
46	PDIAG#	Passed diagnostic
45	DASP#	Drive active/slave present (not connected)
26, 25	CD1#, CD2#	Card detect (not connected)
33, 40	VS1#, VS2#	Voltage sense (not connected)
43	DMARQ	DMA request (input)
44	DMACK#	DMA acknowledge (output)
36	WE#	Write enable
1, 50	GND	Ground
13, 38	VCC	+ 3.3V power

Serial port COM 1, X616

The COM1 serial port has the following pin assignment:

Serial interface COM1			
Pinno.	Short description	Meaning	Input / output
1	DCD (M5)	Receive signal (carrier)	Input
2	RxD (D2)	Receive data	Input
3	TxD (D1)	Transmit data	Output
4	DTR (S1)	Data terminal ready	Output
5	GND (E2)	Functional ground (reference potential)	–
6	DSR (M1)	Ready for operation	Input
7	RTS (S2)	Request to send	Output
8	CTS (M2)	Clear to send	Input
9	RI (M3)	Incoming call	Input

17.1.5 Front ports

Overview

Port	Position	Connector	Description
Display (LVDS)	Internal	X400	Connection of LCD displays with LVDS interface (channel 1)
Display (LVDS)	Internal	X401	Connection of LCD displays with LVDS interface (channel 2)
I/O front	Internal	X44	Ports for front I/O, including USB channel 1
USB	Internal	X42	Internal USB 2.0 interface (USB channel 3)

Display interfaces

TFT displays with an LVDS interface can be connected to this interface. You can connect 18-bit displays with a resolution up to 1024 x 768 pixels on X400 only (single-channel LVDS), and of 1280 x 1024 pixels on X400 and X401 (dual-channel LVDS). On the X401, there is also +12 V as supply voltage for the backlight inverter (max. 4.2 A) for 19" / Dual Channel LVDS displays. The permitted display clock rate is 20 MHz to 66 MHz. The display is selected automatically based on the code of the display select inputs.

The display power supply voltages 3.3 V and 5 V are switched via the graphic controller depending on the requirements of the connected display units. The maximum cable length is 50 cm at a transmission rate of 455 MHz. Special cable properties are required for the differential cable pairs specified by the LVDS specification.

Display interface (1st LVDS channel), X400

Pin no.	Short description	Meaning	Input / output
1	P5V_D_fused	+5V (fused) display VCC	Output
2	P5V_D_fused	+5V (fused) display VCC	Output
3	RXIN0-	LVDS output signal bit 0 (-)	Output
4	RXIN0+	LVDS output signal bit 0 (+)	Output
5	P3V3_D_fused	+3.3V (fused) display VCC	Output
6	P3V3_D_fused	+3.3V (fused) display VCC	Output
7	RXIN1-	LVDS output signal bit 1 (-)	Output
8	RXIN1+	LVDS output signal bit 1 (+)	Output
9	GND	Ground	-
10	GND	Ground	-
11	RXIN2-	LVDS output signal bit 2 (-)	Output
12	RXIN2+	LVDS output signal bit 2 (+)	Output
13	GND	Ground	-
14	GND	Ground	-
15	RXCLKIN-	LVDS clock signal (-)	Output
16	RXCLKIN+	LVDS clock signal (+)	Output
17	GND	Ground	-
18	GND	Ground	-
19	NC	Unassigned	-
20	NC	Unassigned	-

Display interface (2nd LVDS channel), X401

Pin no.	Short description	Meaning	Input / output
1	GND	Ground	-
2	GND	Ground	-
3	RXIN10-	LVDS input signal bit 0 (-)	Output
4	RXIN10+	LVDS input signal bit 0 (+)	Output
5	GND	Ground	Output

Detailed descriptions

17.1 Motherboard

Pin no.	Short description	Meaning	Input / output
6	GND	Ground	Output
7	RXIN11-	LVDS input signal bit 1 (-)	Output
8	RXIN11+	LVDS input signal bit 1 (+)	Output
9	GND	Ground	-
10	GND	Ground	-
11	RXIN12-	LVDS input signal bit 2 (-)	Output
12	RXIN12+	LVDS input signal bit 2 (+)	Output
13	GND	Ground	-
14	GND	Ground	-
15	RXCLKIN1-	LVDS clock signal (-)	Output
16	RXCLKIN1+	LVDS clock signal (+)	Output
17	GND	Ground	-
18	P12VF	+12V fused	Output
19	P12VF	+12 V fused	Output
20	P12VF	+12 V fused	Output

Assignment of the display to the display select pins

One of the 15 available displays is configured automatically via the display select inputs. The display select inputs are connected to pull-up resistors, i.e. if these inputs are not interconnected, they are high level. The input must be connected to ground to generate a low level.

Pin no.	LCD_SEL3	LCD_SEL2	LCD_SEL1	LCD_SEL0	Display type
0	low	low	low	low	reserved
1	low	low	low	high	1280 x 1024 (SXGA), TFT, 2 x 18-bit, LVDS channel 1 and 2
2	low	low	high	low	DVI LCD 640 x 480
3	low	low	high	high	DVI LCD 800 x 600
4	low	high	low	low	640 x 480 (VGA), TFT, 18 bits, LVDS channel 1
5	low	high	low	high	reserved
6	low	high	high	low	1024 x 768 (XGA), TFT, 18 bits, LVDS channel 1
7	low	high	high	high	800 x 600 (SVGA), TFT, 18 bits, LVDS channel 1
8	high	low	low	low	reserved
9	high	low	low	high	reserved
10	high	low	high	low	reserved
11	high	low	high	high	reserved
12	high	high	low	low	1024 x 768 (XGA), TFT, 2 x 18-bit, LVDS channel 1 and 2
13	high	high	low	high	DVI LCD 1024 x 768
14	high	high	high	low	DVI LCD 1280 x 1024
15	high	high	high	high	No LVDS display or DVI LCD with automatic DDC ID

I/O front port for operator panels, X44

This port carries all signals required for connecting operator panels in addition to the display interface. The maximum cable length is 50 cm at a USB data rate of 12 Mbps.

Pin no.	Short description	Meaning	Input / output
1	GND	Ground	-
2	P12V	Inverter voltage supply	Output
3	BL_ON	Backlight on (5 V = On)	Output
4	P5V_fused	+5 V (fused)	Output
5	GND	Ground	-
6	P3V3_fused	+3.3 V VCC (fused)	Output
7	Reserved	Reserved	-
8	Reserved	Reserved	-
9	Reserved	Reserved	-
10	Reserved	Reserved	-
11	P5V_fused	+5 V (fused)	Output
12	USB_D1M	USB data channel 1	Input / output
13	USB_D1P	USB data+, channel 1	Input / output
14	GND	Ground	-
15	LCD_SEL0	Display Type-Select Signal 0	Input
16	LCD_SEL1	Display Type-Select Signal 1	Input
17	LCD_SEL2	Display Type-Select Signal 2	Input
18	LCD_SEL3	Display Type-Select Signal 3	Input
19	RESET_N	Reset signal (active low)	Input
20	reserved	Reserved	-
21	HD_LED	HD LED, anode with 1 kOhm in series on the motherboard	Output
22	DP_LED	MPI/DP LED, anode via 1 kOhm in series on the motherboard	Output
23	Ethernet_LED	Ethernet LED, anode with 1 kOhm in series on the motherboard	Output
24	TEMP_ERR	Temperature error LED, anode with 1 kOhm in series on the motherboard	Output
25	RUN_R	Watchdog error LED, anode with 1 kOhm in series on the motherboard	Output
26	RUN_G	Watchdog OK LED, anode with 1 kOhm in series on the motherboard	Output

Pin Assignment of the USB 2.0 interface, X42

Pin no.	Short description	Meaning	Input / output
1	VCC	+ 5 V, fused	Output
2	USB5	USB5_M	Input / output
3	USB5	USB5_P	Input / output
4	GND	Ground	-
S1	S	Shield	-
S2	S1	Shield	-

Note

For detailed information on the pin assignments of the interfaces, please contact Customer Support or the Repair Center.

17.1.6 Internal interfaces

Pin assignment of the internal ports

Interface	Position	Connector	Description
Memory	Internal	X19, X20	2 DIMM sockets, 64-bit
Processor	Internal	X1	Socket for FCPGA processor
Bus expansion	Internal	X10	Socket for bus expansion, assigned PCI bus signals
Power supply	Internal	X13	20-pin connector plug for power supply
Hard disk drive Serial ATA	Internal	X50, X51	Serial ATA, max. 2 drives operable
Optical drive Serial ATA	Internal	X52	Serial ATA, max. 1 drive operable
Connection for PS serial ATA	Internal	X25, X26, X27, X602	Voltage supply for serial ATA
Optical drive Parallel ATA	Internal	X3	44-pin, 2 mm male connector
Connection for PS fan	Internal	X129	Voltage supply for CPU fan, 3-pin male connector
Connection for equipment fan	Internal	X128	Voltage supply for equipment fan, 3-pin male connector
Backup battery	Internal	X24	Voltage supply for backup battery, 2-pin male connector
Tap for backup battery	Internal	X240, X2400	Voltage tap (= 3V) of the backup battery, 2-pin, male connector
USB interface	Internal	X43	USB channel 6 and 7

Connection for optical drive, X3

Pin no.	Short description	Meaning	Input / Output
1	Reserved	Reserved	-
2	Reserved	Reserved	-
3	Reserved	Reserved	-
4	GND	Ground	-
5	Reset	Reset signal	Input / Output
6	D8	Data signal D8	Input / Output
7	D7	Data signal D7	Input / Output
8	D9	Data signal D9	Input / Output
9	D6	Data signal D6	Input / Output
10	D10	Data signal D10	Input / Output
11	D5	Data signal D5	Input / Output
12	D11	Data signal D11	Input / Output
13	D4	Data signal D4	Input / Output
14	D12	Data signal D12	Input / Output
15	D3	Data signal D3	Input / Output
16	D13	Data signal D13	Input / Output
17	D2	Data signal D2	Input / Output
18	D14	Data signal D14	Input / Output
19	D1	Data signal D1	Input / Output
20	D15	Data signal D15	Input / Output
21	D0	Data signal D0	Input / Output
22	DREQ	DMA request	Input
23	GND	Ground	-
24	IOR_N	Read signal	Output
25	IOW_N	Write signal	Output
26	GND	Ground	-
27	IORDY	Ready signal	Input
28	DACK_N	DMA acknowledgment	Output
29	IRQ15	Interrupt signal	Input
30	AD_1	Address 1	Output
31	AD_0	Address 0	Output
32	AD_2	Address 2	Output
33	CS_N	Chip select signal	Output
34	HDACT_N	Activity	Input
35	CS1_N	Chip select 1	-
36	CSEL	Chip select signal	-
37	GND	Ground	-
38	P5V	+5 V voltage supply	Output
39	P5V	+5 V voltage supply	Output
40	P5V	+5 V voltage supply	Output
41	P5V	+5 V voltage supply	Output

Pin assignment of the equipment fan, X128

Pin no.	Short description	Meaning	Input / output
1	GND	Ground	-
2	+12 V	Switched voltage supply	Output
3	CPU FAN_CLK	Clock signal	Input

Pin assignment of the supply for the power supply fan, X129

Pin no.	Short description	Meaning	Input / output
1	GND	Ground	-
2	+12 V	Switched voltage supply	Output
3	PG1 FAN_CLK	Clock signal	Input

Connection for backup battery, X24 (BATT)

A battery for buffering the CMOS RAM is connected to this connector. This is a 3 V Lithium battery with a capacity of 750 mAh.

Pin no.	Short description	Meaning	Input / output
1	+	Plus pole	Input
2	-	Minus pole	-

Tap of the backup battery, X240, X2400 (OUT)

This connection is intended for expansion modules with on-board CMOS-RAM. The voltage of the backup battery can be tapped here to backup the CMOS RAM data of the expansion module.

Pin no.	Short description	Meaning	Input / output
1	+	Plus pole	Output
2	-	Minus pole	-

NOTICE
No battery should be connected to this connection.

Pin assignment of the supply for the serial ATA drives X25, X26, X27, X602

Pin no.	Short description	Meaning	Input / output
1	+12 V	Voltage supply	Output
2	GND	Ground	–
3	GND	Ground	–
4	+5 V	Voltage supply	Output
5	+3.3 V	Voltage supply	Output

Pin assignment of the internal USB interface connector, X43

Pin no.	Short description	Meaning	Input / output
1	VCC 3.3V	+3.3V, fused	Output
2	VCC 5V	+ 5 V, fused	Output
3	USB3	USB3_M	Input / output
4	USB5	USB5_M	Input / output
5	USB3	USB3_P	Input / output
6	USB5	USB5_P	Input / output
7	GND	Ground	–
8	GND	Ground	–
9	GND	Ground	–
10	GND	Ground	–

17.2 Bus board

17.2.1 Layout and principle of operation

The bus board is designed as a link between the motherboard and the expansion modules. It is secured with two screws.

Two models of the bus board are available:

Variant 1 has two PCI slots (1x short, 1x long). It can host expansion modules conforming to PCI specification (Rev. 2.2) for 5 V and 3.3 V modules. All PCI slots are master compatible. The expansion modules are supplied with power via the bus board to motherboard connection.

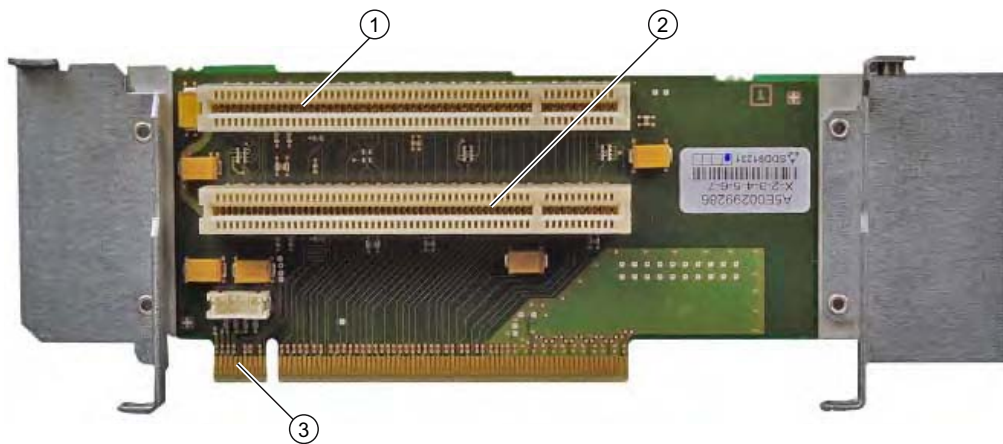

(1)	Slot 1
(2)	Slot 2
(3)	12V power supply connection for WinAC module

Variant 2 has one PCI and one PCI Express slot.

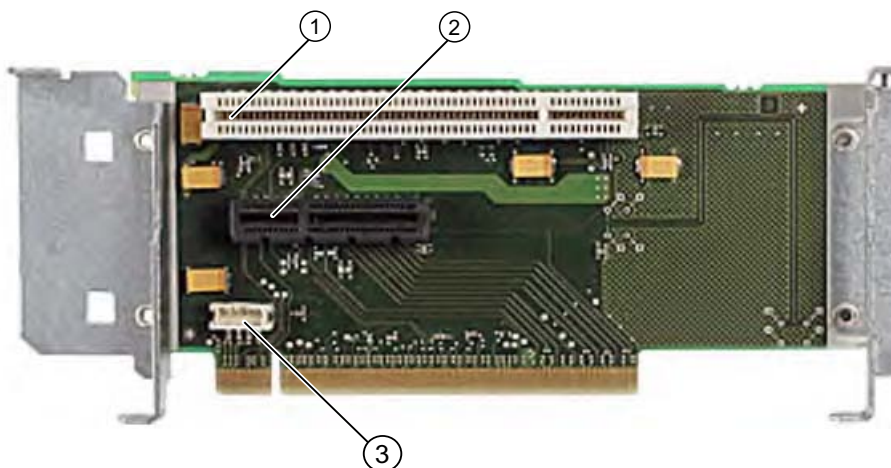

(1)	Slot 1 PCI
(2)	Slot 2 PCI Express x4
(3)	12V power supply connection for WinAC module

17.2.2 PCI slot pin assignment

	5V System Environment	
	Side B	Side A
1	-12V	TRST#
2	TCK	+12V
3	Ground	TMS
4	TDO	TDI
5	+5V	+5V
6	+5V	INTA#
7	INTB#	INTC#
8	INTD#	+5V
9	PRSNT1#	Reserved
10	Reserved	+5 V (I/O)
11	PRSNT2#	Reserved
12	Ground	Ground
13	Ground	Ground
14	Reserved	Reserved
15	Ground	RST#
16	CLK	+5 V (I/O)
17	Ground	GNT#
18	REQ#	Ground
19	+5 V (I/O)	Reserved
20	AD[31]	AD[30]
21	AD[29]	+3.3V
22	Ground	AD[28]
23	AD[27]	AD[26]
24	AD[25]	Ground
25	+3.3V	AD[24]
26	C/BE[3]#	IDSEL
27	AD[23]	+3.3V
28	Ground	AD[22]
29	AD[21]	AD[20]
30	AD[19]	Ground
31	+3.3V	AD[18]
32	AD[17]	AD[16]
33	C/BE[2]#	+3.3V
34	Ground	FRAME#
35	IRDY#	Ground
36	+3.3V	TRDY#
37	DEVSEL#	Ground
38	Ground	STOP#
39	LOCK#	+3.3V

5V System Environment		
40	PERR#	SDONE
41	+3.3V	SBO#
42	SERR#	Ground
43	+3.3V	PAR
44	C/BE[1]#	AD[15]
45	AD[14]	+3.3V
46	Ground	AD[13]
47	AD[12]	AD[11]
48	AD[10]	Ground
49	Ground	AD[09]
50	CONNECTOR KEY	
51	CONNECTOR KEY	
52	AD[08]	C/BE[0]#
53	AD[07]	+3.3V
54	+3.3V	AD[06]
55	AD[05]	AD[04]
56	AD[03]	Ground
57	Ground	AD[02]
58	AD[01]	AD[00]
59	+5 V (I/O)	+5 V (I/O)
60	ACK64#	REQ64#
61	+5V	+5V
62	+5V	+5V

17.2.3 Pin assignment 12 V power supply connection for WinAC module

Pin	Short description	Meaning	Input /Output
1	+12 V ¹	12 V voltage	Output
2	GND	Ground	-
3	GND	Ground	-
4	+5 V ¹	5 V voltage	Output

1) max. permissible current: 1 A; with this power demand the total power demand for the PCI slots are not allowed to be exceeded.

17.2.4 PCI Express slot x4 pin assignment

	5V System Environment	
	Side B	Side A
1	P12V	PRSNT1_N
2	P12V	GND
3	P12V	P12V
4	GND	GND
5	SMBCLK	PTCK
6	SMBDAT	PTDI
7	GND	PTDO
8	P3V3	PTMS
9	PTRST_N	P3V3
10	Aux_3V3	P3V3
11	PCIE_Wake_N	PCI RST_N
12	Reserved	GND
13	GND	GND
14	PCIE_TX_P(1)	GND
15	PCIE_TX_N(1)	GND
16	M	PCIE_RX_P(1)
17	PRSNT2_N	PCIE_RX_N(1)
18	GND	GND
19	PCIE_TX_P(2)	Reserved
20	PCIE_TX_N(2)	GND
21	GND	PCIE_RX_P(2)
22	GND	PCIE_RX_N(2)
23	PCIE_TX_P(3)	GND
24	PCIE_TX_N(3)	GND
25	GND	PCIE_RX_P(3)
26	GND	PCIE_RX_N(3)
27	PCIE_TX_P(4)	GND
28	PCIE_TX_N(4)	GND
29	GND	PCIE_RX_P(4)
30	GND	PCIE_RX_N(4)
31	PRSNT2_N	GND
32	GND	Reserved

17.3 System resources

17.3.1 Currently allocated system resources

All system resources (hardware addresses, memory configuration, allocation of interrupts, DMA channels) are assigned dynamically by the Windows OS, depending on the hardware configuration, drivers and connected external devices. You can view the current configuration of system resources or possible conflicts with the following operating systems:

Windows 2000/XP	Start > Run : In the Open dialog, enter <i>msinfo32</i> and confirm with OK
Windows Vista	Start > Enter "cmd" in the search function, then enter "msinfo32" in the input box

17.3.2 System resources used by the BIOS/DOS

The following table describes the system resources for the factory state of the device.

17.3.2.1 I/O address allocation

I/O address (hex)		Size (bytes)	Description of the basic function	Possible alternative function
from	to			
0000	000F	16	DMA controller	
0010	001F	16	Motherboard resources	
0020	0021	2	Programmable interrupt controller	
0022	003F	30	Motherboard resources	
0040	0043	4	System timer	
0044	005F	28	Motherboard resources	
0060	0060	1	Keyboard controller	
0061	0061	1	System loudspeaker	
0062	0063	2	Motherboard resources	
0064	0064	1	Keyboard controller	
0067	006F	9	Motherboard resources	
0070	0075	6	System CMOS/real-time clock	
0076	0080	11	Motherboard resources	
0081	008F	15	DMA controller	
0090	009F	16	Motherboard resources	
00A0	00A1	2	Programmable interrupt controller	
00A2	00BF	30	Motherboard resources	
00C0	00DF	32	DMA controller	
00E0	00EF	16	Motherboard resources	
00F0	00FE	15	Numeric data processor	

I/O address (hex)				
0110	016F	96	Not used	
0170	0177	8	Secondary EIDE channel	
0178	01EF	120	Not used	
01F0	01F7	8	Primary EIDE channel	Switchable in Setup, then free
01F8	01FF	8	Not used	
0200	0207	8	Reserved for game port	
0208	02E7	224	Not used	
02E8	02EF	8	Reserved	
02F8	02FF	8	COM2	Switchable in Setup, then free
0300	031F	32	Not used	
0320	032F	16	Not used	
0330	033F	16	Not used	
0340	035F	32	Not used	
0360	0367	8	Not used	
0370	0371	2	SOM	
0372	0375	4	Not used	
0376	0376	1	Secondary EIDE channel	
0378	037F	8	LPT 1	Switchable in Setup, then free
0380	03AF	48	Not used	
03B0	03BB	12	Graphics	
03BC	03BF	4	Reserved	
03C0	03DF	16	Graphics	
03E0	03E7	8	Not used	
03E8	03EF	6	Reserved	
03F0	03F5	6	Standard floppy disk controller	
03F6	03F6	1	Primary EIDE channel	
03F7	03F7	1	Standard floppy disk controller	
03F8	03FF	8	COM1	Switchable in Setup, then free
Dynamic range; resources are managed by means of Plug and Play functionality				
0400	0777	888	Not used	
0778	077F	8	ECP LPT 1	
0780	07FF	128	Not used	
0800	080F	16	ACPI communications range	Fixed
0810	0CFB	1260	PCI configuration index	Fixed
0CFC	0CFF	4	PCI configuration data	Fixed
0D00	0EFF	512	Not used	
0F00	0F4F	80	Super IO	
0F50	0FFF	176	Not used	
1000	10FF	256	Used internally	

I/O address (hex)				
1180	11FF	128	Used internally	
1800	187F	128	Used internally	
8800	8BFF	1023	SATA RAID Controller	
8C00	FEFF	29288	Not used for SATA RAID	
8870	8897	39	PATA RAID Controller	
8898	FEFF	30311	Not used for PATA RAID	
1880	886F	28655	Not used	
FF00	FF0F	16	EIDE bus master register	

17.3.2.2 Interrupt Assignments

The functions are assigned different interrupts, depending on the operating system. A distinction is made between the PIC and APIC modes.

X = Interrupt in PIC and APIC mode, Y = Interrupt in APIC mode, Z = BIOS default interrupt in PIC mode (e.g. DOS)

Function	IRQ number																Comment									
	0	1	2	3	4	5	6	7	8	9	10	11	12	13	14	15		16	17	18	19	20	21	22	23	
IRQ (APIC mode)	0	1	2	3	4	5	6	7	8	9	10	11	12	13	14	15	16	17	18	19	20	21	22	23		
IRQ (PIC mode)	0	1	2	3	4	5	6	7	8	9	10	11	12	13	14	15	16	17	18	19	20	21	22	23		
Host PCI IRQ line																	A	B	C	D	E	F	G	H	1)	
Function																										
Timer output 0	X																									Fixed
Keyboard		X																								Fixed
Cascaded (IRQ9)			X																							Fixed
Serial port 2																										Unassigned
Serial port 1			X																							Can be switched off
FD controller					X																					Only free in ACPI-PIC mode
Parallel port 1																										Unassigned
Real-time clock (RTC)								X																		Fixed
PS/2 mouse											X															Used by mouse emulation
Numeric processor												X														Fixed
HD controller 1 (primary)													X													Can be switched off
HD controller 2 (secondary)															X											Can be switched off
SATA																										Can be switched off
USB PORT 0/1								Z																	Y	Can be switched off
USB Port 2/3								Z																	Y	Cannot be disabled
USB Port 4/5								Z															Y			Cannot be disabled
USB 2.0 Controller										Z													Y			Cannot be disabled
Ethernet 1						Z											Y									Can be switched off
Ethernet 2																		Y								Can be switched off
VGA																										Can be switched off
Profibus or Profinet						Z															Y					Can be switched off

1) Host PCI IRQs A to H are assigned fixed IRQs 16-23 in APIC mode.
Host PCI IRQs A to H are automatically assigned IRQs 0-15 in PIC mode by BIOS; a specified order cannot be forced.

Figure 17-3 Interrupt assignment in PIC mode

Y = Interrupt in APIC mode, Z = BIOS default interrupt in PIC mode (e.g. DOS)

Function	IRQ number																							Comment	
	0	1	2	3	4	5	6	7	8	9	10	11	12	13	14	15	16	17	18	19	20	21	22		23
ACPI IRQ																									
Host PCI IRQ line																									
Slot 1 PCI																									
PCI IRQ line A											Z									Y					
PCI IRQ line B										Z											Y				
PCI IRQ line C										Z												Y			
PCI IRQ line D										Z													Y		
Slot 2 PCI																									
PCI IRQ line A											Z											Y			
PCI IRQ line B										Z												Y			
PCI IRQ line C									Z														Y		
PCI IRQ line D									Z												Y				
Slot 2 PCIexpress																									
PCI IRQ line A																						Y			
PCI IRQ line B											Z											Y			
PCI IRQ line C											Z												Y		
PCI IRQ line D											Z												Y		

1) Host PCI IRQs A to H are assigned fixed IRQs 16-23 in APIC mode.
 Host PCI IRQs A to H are automatically assigned IRQs 0-15 in PIC mode by BIOS; a specified order cannot be forced.

Figure 17-4 Interrupt assignment of the slot connectors on the bus board

17.3.2.3 Exclusive PCI hardware interrupt

Applications demanding a high-performance interrupt require a high-speed hardware interrupt reaction. The PCI hardware interrupt should be used only by one resource in order to ensure high-speed reaction of the hardware.

Exclusive interrupt in APIC mode

	IRQ assignments for Windows XP Professional, Windows XP Embedded and Windows 2000 Professional (APIC mode)
Ethernet 1	16 ^{1) 2)}
Ethernet 2	17 ¹⁾
Profibus/MPI	19 ¹⁾
PCI slot 1	20 ¹⁾
PCI slot 2	21 ¹⁾
PCI Express slot	16 ^{1) 3)}

¹⁾ Requirement: The modules in the PCI slots each require only one interrupt

²⁾ Requirement: VGA and PCI Express do not require an interrupt

³⁾ Requirement: VGA does not require an interrupt and Ethernet1 is disabled

Exclusive interrupt in PIC mode

The interrupts are automatically assigned to the slots at system startup due to the default settings in system BIOS.

Several slots may share the same interrupt, depending on the system configuration. This functionality is known as interrupt sharing. Exclusive interrupts are not available in PIC mode. Disable specific system resources in order to obtain exclusive interrupts. BIOS assigns the PIC interrupts at random during restart of the system.

17.3.2.4 Memory address assignments

PCI VGA modules can be operated with expansion ROM up to 48K.

Address		Size	Description of the basic function	Possible alternative function
from	to			
0000 0000	0007 FFFF	512K	Conventional system memory	
0008 0000	0009 F7FF	127K	Conventional system memory extended	
0009 F800	0009 FFFF	2K	XBDA, extended Bios Data Area	
000A 0000	000A FFFF	64K	VGA graphics refresh memory	Shared SMM for power management
000B 0000	000B 7FFF	32K	Software graphics / text refresh memory	Not used
000B 8000	000B FFFF	32K	VGA graphics/text refresh memory	

Address				
000C 0000	000C BFFF	48K	VGA BIOS expansion	
000C 0000	000C E9FF	59K ¹⁾	VGA BIOS	Always occupied
000C F000	000D FFFF	68K ¹⁾	Not used (no RAID, no PXE)	via EMM High DOS Memory
000C F000	000C FFFF	4K ¹⁾	PXE	
000D 0000	000D FFFF	64K ¹⁾	Not used (no RAID, with PXE)	via EMM High DOS Memory
000C F000	000D 37FF	18K ¹⁾	RAID	
000D 3800	000D FFFF	50K ¹⁾	Not used (RAID, no PXE)	via EMM High DOS Memory
000C F000	000D 47FF	22K ¹⁾	RAID and PXE	
000D 4800	000D FFFF	46K ¹⁾	Not used	
000E 0000	000E 1FFF	8K	USB	
000E 2000	000E 3FFF	8K	DMI data	
000E 4000	000F FFFF	112K	System BIOS	
0010 0000	CFFF FFFF	3,2GB	System memory 4 GB memory configuration	Depends on memory configuration
D000 0000	FFEF FFFF	767 MB	Configuration space	
FFF0 0000	FFFF FFFF	1 MB	Firmware HUB	

¹⁾ Optional memory allocation, depending on settings in BIOS Setup

17.4 BIOS Setup

17.4.1 Overview

BIOS Setup program

BIOS Setup program is stored in ROM BIOS. Information about the system configuration is stored in the battery-backed memory of the device.

SETUP can be used to define the hardware configuration (for example, the hard disk type) and system properties. SETUP is also used to set the time and date of the realtime clock.

Changing the device configuration

Your device configuration is preset for operating with the included software. You should only change the default values if you have modified the technical configuration your device, or if a fault occurs when the unit is powered up.

17.4.2 Starting BIOS Setup

Starting BIOS Setup

1. Start the setup program as follows:
2. Reset the device (warm or cold restart).

In the figures shown, the default settings differ based on the device versions. With the default setting of the Box PC, the display shown below appears following power-on, for example:

```
PhoenixBIOS 4.0 Release 6.0 cME FirstBIOS Desktop Pro -A5E00929013-ES0x
Copyright 1985–2004 Phoenix Technologies Ltd.
All Rights Reserved.
Siemens SIMATIC Box PC 627B / Panel PC 677B Version Vxx.xx.xx
CPU = 1 Processors Detected, Cores per Processor = 2
Intel® Core™2 CPU T7400 @ 2.16GHz
2048M System RAM Passed
496K Cache SRAM Passed
System BIOS shadowed
Video BIOS shadowed
ATAPI CD-ROM: Optiarc DVD RW AD-7540A
Fixed Disk 0: ST3160815AS
Mouse initialized
```

On completion of the POST, the BIOS gives you the opportunity of starting the SETUP program. The following message appears on the screen:

```
Press < F2 > to enter SETUP or <ESC> to show boot menu
```

3. Press the F2 key as long as the BIOS prompt appears on the screen.

17.4.3 BIOS Setup menus

The various menus and submenus are listed on the next pages. You can obtain information on the selected SETUP item from the "item-specific help" part of the respective menu.

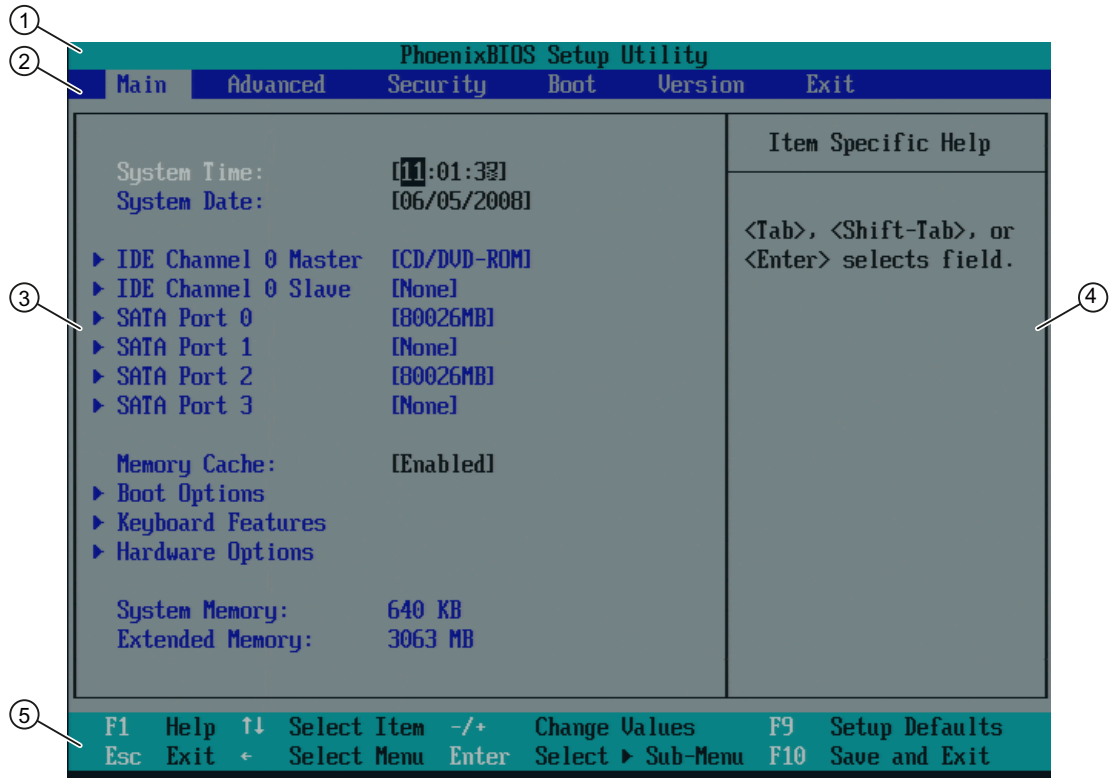

Figure 17-5 SETUP Main menu (example)

(1) Header	(4) Help view
(2) Menu line	(5) Input line
(3) Selectable submenu	

Menu layout

The screen is divided into four sections. In the top part (2), you can select the menu forms [Main], [Advanced], [Security], [Boot], [Version], [Exit]. In the left of the center section (3) you can select various settings or submenus. Brief help texts appear on the right (4) for the currently selected menu entry. The bottom section contains information for operator input.

The figures below represent examples of specific device configurations. The screen content changes based on the supplied equipment configuration.

Yellow stars to the left of the interface designation (for example, Internal COM 1) indicate a resource conflict between the interfaces managed by the BIOS. In this case you should select the default settings (F9) or eliminate the conflict.

You can move between the menu forms using the cursor keys [←] left and [→] right.

Menu	Meaning
Main	System functions are set here
Advanced	An extended system configuration can be set here
Security	This is where setting security functions such as the password are set.
Boot	This is where the boot priority is specified.
Version	This shows device-specific information (such as the release version).
Exit	Used for terminating and saving.

17.4.4 Main menu

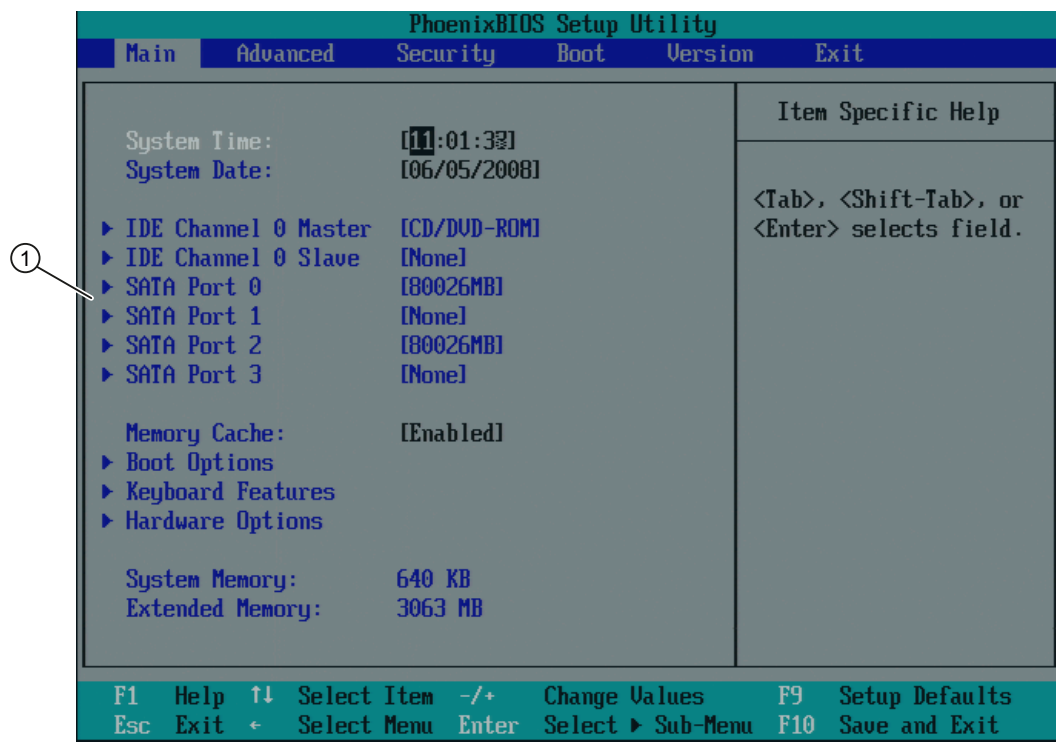

Figure 17-6 Main menu (example)

(1) Selectable submenu

Settings in the main menu

In the main menu, you can move up and down to select the following system configuration boxes by means of the [↑] up and [↓] down cursor keys:

Field	Meaning
System Time	For viewing and setting the current time
System Date	For viewing and setting the current date
Memory Cache	Used for setting the cache options
by submenus	
IDE Channel 0 Master	Type of installed disk drives
IDE Channel 0 Slave	Type of installed disk drives
SATA Port 0	Type of installed disk drives
SATA Port 1	Type of installed disk drives
SATA Port 2	Type of installed disk drives
SATA Port 3	Type of installed disk drives
Boot options	Used for setting the boot options
Keyboard Features	Used for setting of keyboard interface (for instance, NUM-LOCK, typematic rate)
Hardware Options	Used for setting the hardware options

System time and date

System Time and System Date indicate the current values. Once you have selected the appropriate option, you can use the [+] and [-] keys to modify the time setting

Hour: Minute: Second

and for the date

Month/Day/Year

You can navigate between the entries in the date and time fields (for example, from hour to minute) using the tab key.

IDE Channel 0 Master, IDE Channel 0 Slave

The system jumps to the following submenu when you select this type of menu field:

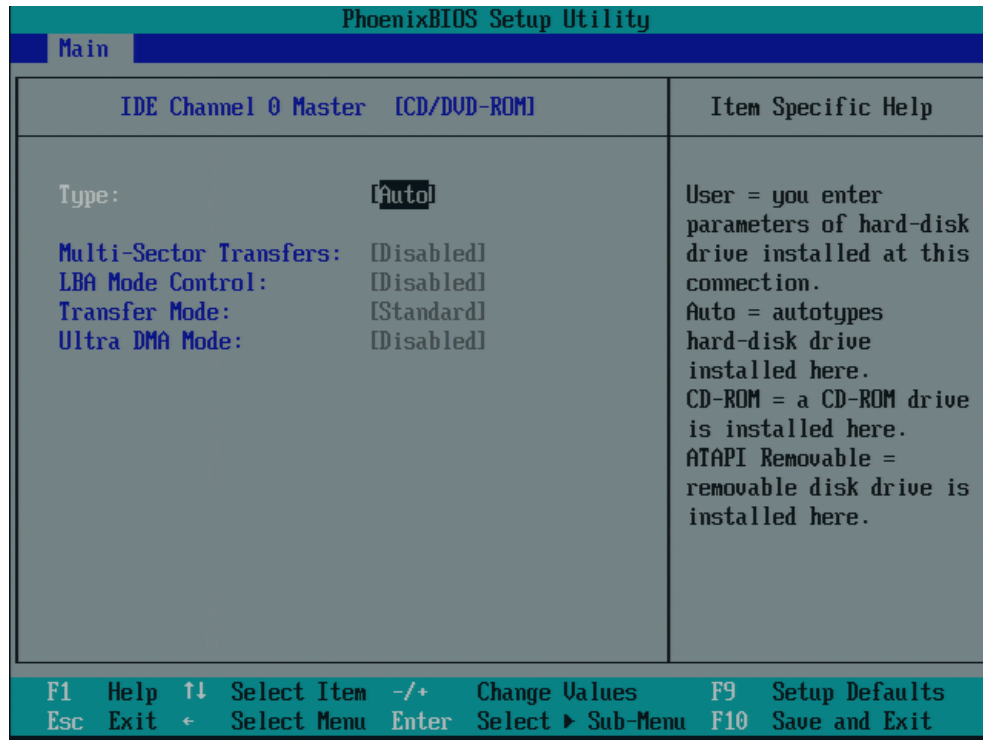

Figure 17-7 IDE Channel 0 Master (example)

Type	[User]	Select "User" to enter a user-specific definition of the hard disk type. Configure all the other options, for example, Cylinder, Heads, Sectors/Track, or other properties of the hard disk drive.
	[Auto]	The parameters which you can select in this dialog are usually saved to the respective IDE drive. The "Auto" setting in the "Type" field means that these values are automatically read from the drive and written to memory. If Type is selected for a drive that does not exist, a timeout is triggered within approximately 1 minute and the entries remain unchanged. It makes sense only to set "Auto" for interfaces to which a drive is connected.
	[CD/DVD-ROM]	CD/DVD-ROM is connected
	ATAPI Removable	A removable data volume is connected
	None	Select "None" if you have not connected a disk drive. This setting reduces system waiting time.
Multi-Sector Transfer		The number of blocks (sectors) transferred per interrupt are defined at the "Multi-Sector Transfer" option. The value depends on the drive and should only be set by way of "Auto" setting at the "Type" field.
	Disabled	2, 4, 8, 16 sectors

LBA Mode Control	The "Enabled" setting at the "LBA Mode Control" (enabled, disabled) option means that hard disk capacities greater than 528 MB are supported. The value depends on the drive and should only be set by way of "Auto" setting at the "Type" field.	
32-bit I/O	The type of access to the drive is determined in the 32-bit I/O field	
	Disabled	16-bit access
	Enabled	32-bit access (default)
Transfer Mode or Ultra DMA Mode	Define the data transmission rate of the interface in these fields. The value depends on the drive and should only be set by way of "Auto" setting at the "Type" field. Exit the submenu by pressing ESC.	

SATA Port 0, SATA Port 1, SATA Port 2, SATA Port 3

The system jumps to the following submenu when you select this type of menu field:

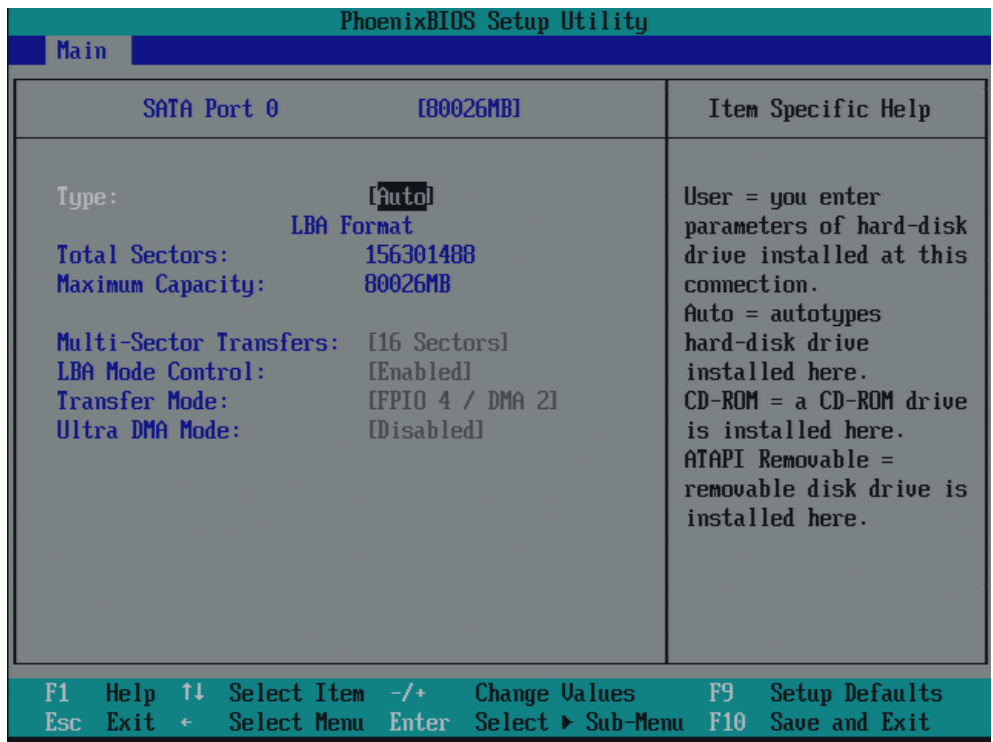

Figure 17-8 SATA Port 0 (example)

Type	[User]	Select "User" to enter a user-specific definition of the hard disk type. Configure all the other options, for example, Cylinder, Heads, Sectors/Track, or other properties of the hard disk drive.
	[Auto]	The parameters which you can select in this dialog are usually saved to the respective IDE drive. The "Auto" setting in the "Type" field means that these values are automatically read from the drive and written to memory. If Type is selected for a drive that does not exist, a timeout is triggered within approximately 1 minute and the entries remain unchanged. It makes sense only to set "Auto" for interfaces to which a drive is connected.
	[CD/DVD-ROM]	CD/DVD-ROM is connected
	[ATAPI Removable]	A removable data volume is connected
	[None]	Select "None" if you have not connected a disk drive. This setting reduces system waiting time.
Multi-Sector Transfer	The number of blocks (sectors) transferred per interrupt are defined at the "Multi-Sector Transfer" option. The value depends on the drive and should only be set by way of "Auto" setting at the "Type" field.	
	Disabled	2, 4, 8, 16 sectors
LBA Mode Control	The "Enabled" setting at the "LBA Mode Control" (enabled, disabled) option means that hard disk capacities greater than 528 MB are supported. The value depends on the drive and should only be set by way of "Auto" setting at the "Type" field.	
32-bit I/O	The type of access to the drive is determined in the 32-bit I/O field	
	Disabled	16-bit access (default)
	Enabled	32-bit access
Transfer Mode or Ultra DMA Mode	Define the data transmission rate of the interface in these fields. The value depends on the drive and should only be set by way of "Auto" setting at the "Type" field. Exit the submenu by pressing ESC.	

"Memory Cache" field

The following shortcut menu appears when you select the option "Memory cache" in the main menu:

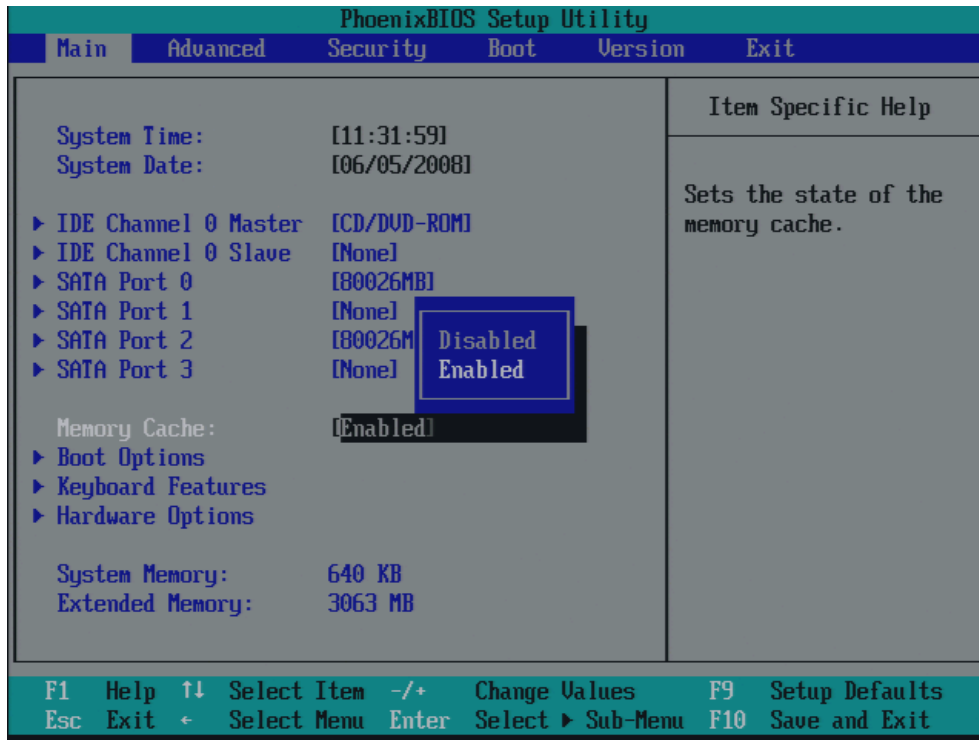

Figure 17-9 "Memory Cache" field

The cache is a high-speed memory buffer between the CPU and memory (DRAM). Repeated memory access operations are executed in the faster cache, and not in the main memory, provided the feature is enabled. In some cases it may be necessary to disable the cache for certain types of hardware and software because intentional program runtimes or delay times may be prevented by the fast cache.

[Disabled]	Cache is disabled
[Enabled]	Cache is enabled

"Boot Options" field

The following shortcut menu appears when you select the option "Boot Options" in the main menu:

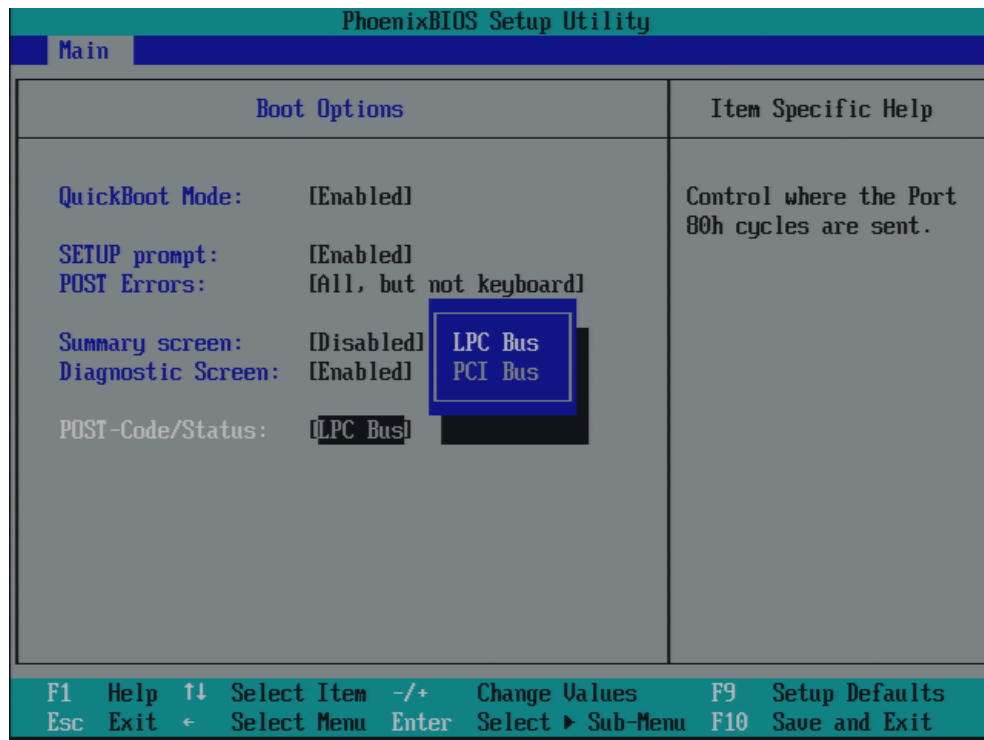

Figure 17-10 "Boot Options" field

Quick Boot Mode	Some hardware tests are skipped to speed up the boot sequence.	
SETUP prompt	During the system load phase, the message "Press <F2> to enter Setup or <Esc> to show boot menu" is output on the bottom of the screen.	
POST errors	If the boot sequence is interrupted due to an error detected within the system startup phase, press <F1> to acknowledge this error.	
	[Disabled]	Error acknowledgment is not required, for example, if a keyboard is not found.
	[All, but not keyboard]	Show all errors except for keyboard errors.
Summary screen	The most important system parameters are displayed when the system run-up phase completes.	
Diagnostic screen	Shows the diagnostics messages on the monitor during booting.	
Port 80h Cycles	Specifies where the POST codes are output.	
	LPC Bus	Output of the status display for the device
	PCI bus	Output to PCI bus

'Enabled' means that the feature is active. 'Disabled' means that the feature is inactive.

Example of a summary screen:

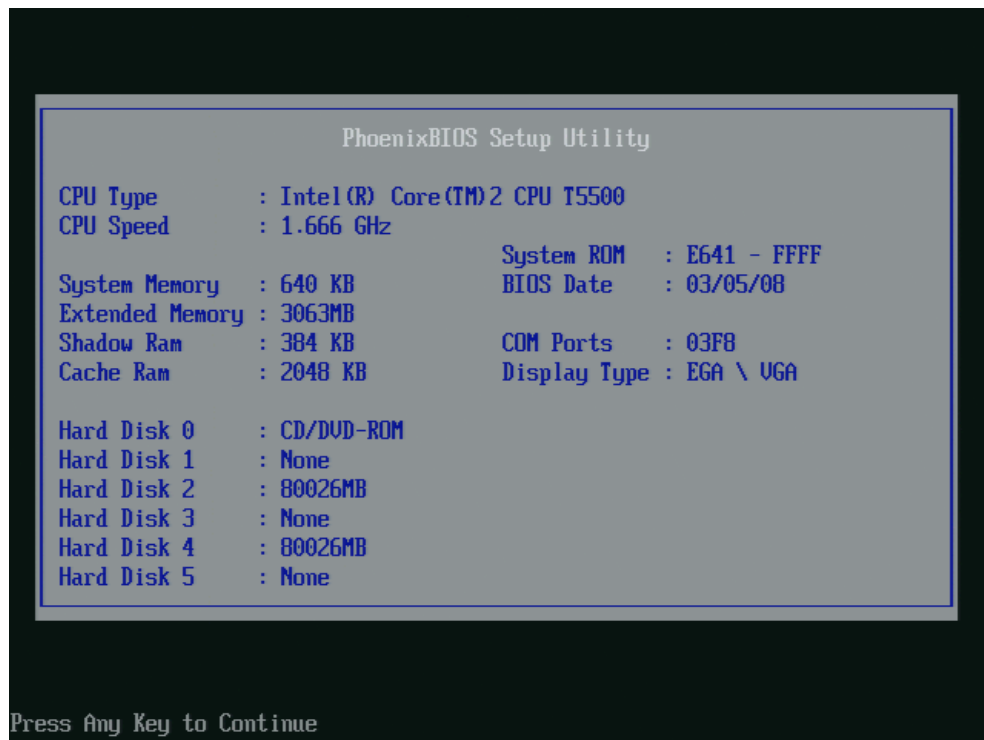

Figure 17-11 Summary screen (example)

The Summary screen appears when the system run-up phase completes.

"Keyboard Features" field

The following shortcut menu appears when you select the option "Keyboard Features" in the main menu:

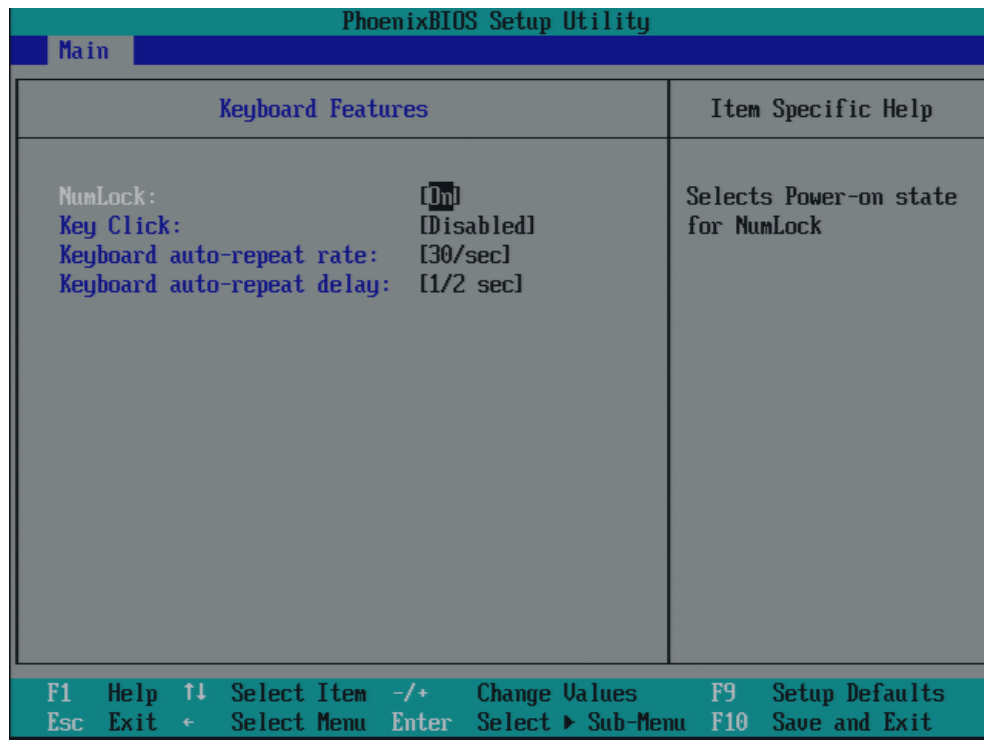

Figure 17-12 "Keyboard Features" field

Numlock	Switches Numlock on or off following power on. This status is saved to non-volatile memory if "Auto" is set.
Key Click	The program outputs an audible "CLICK" for keystrokes.
Keyboard auto-repeat rate	Increase in automatic key repeat rate
Keyboard auto-repeat delay	On-delay of automatic keyboard repeat

"Hardware Options" field

The following shortcut menu appears when you select the option "Hardware Options" in the main menu:

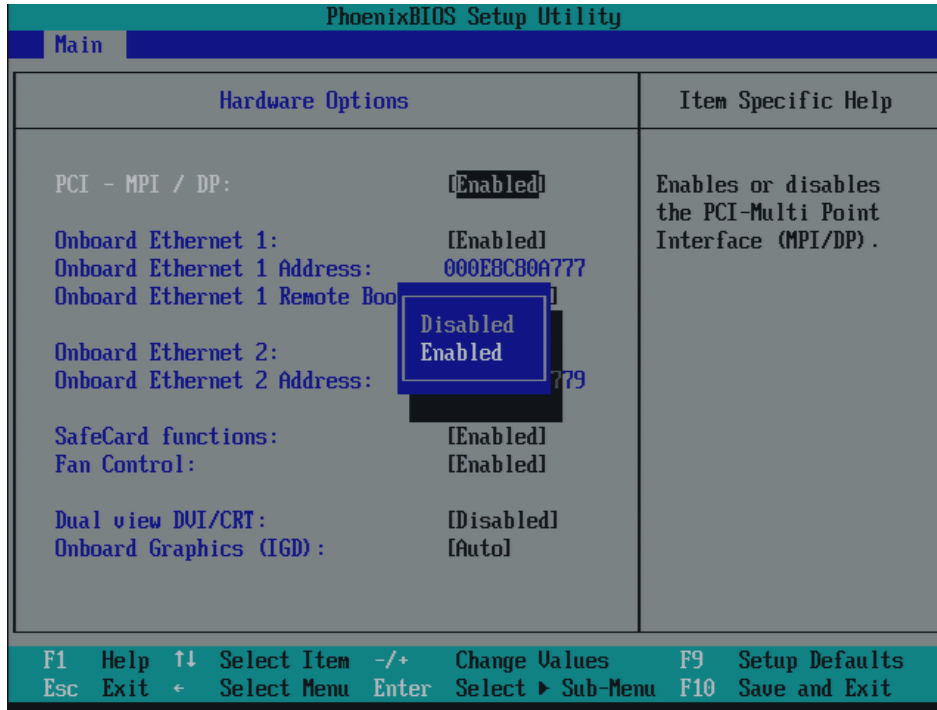

Figure 17-13 "Hardware Options" field

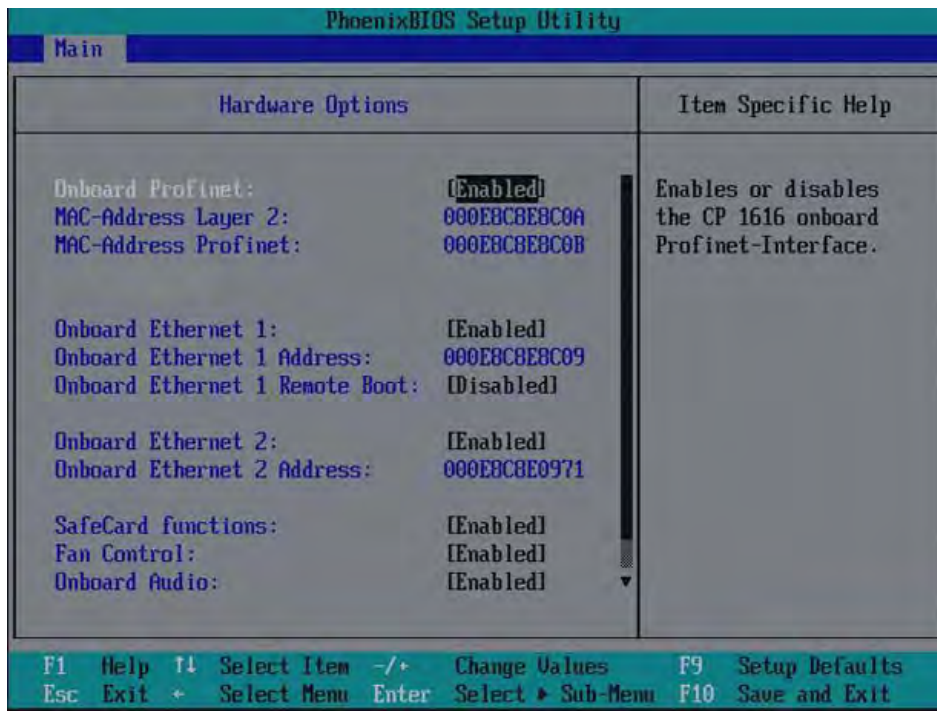

Figure 17-14 "Hardware Options" field for PROFINET

The parameters of the interfaces present on the motherboard are set here.

Entry	Meaning	
PCI - MPI / DP	[Enabled]	Enables the CP5611-compatible MPI/DP interface. The resources are managed by the BIOS PCI Plug and Play mechanism.
	[Disabled]	The CP5611 compatible MPI/DP interface is disabled.
Onboard Profinet	[Enabled]	CP 1616 onboard is enabled
	[Disabled]	CP 1616 onboard is disabled
MAC Address Layer 2	This address is for NDIS applications. Example: 000E8C8E8C0A	
MAC Address Profinet	This is the main address for PROFINET applications Example: 000E8C8E8C0B. The MAC addresses of the individual ports are derived from the "MAC Address Profinet". They are not shown in the BIOS setup. Example: P1=000E8C8E8C0B+1, P2=000E8C8E8C0B+2, P3=000E8C8E8C0B+3	
On-board Ethernet	[Enabled]	The Ethernet interface on the motherboard is enabled.
	[Disabled]	The Ethernet interface on the motherboard is disabled.
On-board Ethernet Address	Shows the individual Ethernet address.	
On-board Ethernet Remote Boot	[Enabled]	Booting via a connected LAN is possible. The respective boot source is displayed as Intel® Boot-Agent in the boot sequence menu.
	[Disabled]	Booting via LAN is not possible.
SafeCard functions	[Enabled]	On-board monitoring functions are enabled.
	[Disabled]	No monitoring functions.
	The relevant driver and the application must be started for operation of the monitoring functions.	
Fan Control	[Enabled]	The fan speed is controlled based on the temperature.
	[Disabled]	The fan always runs at full speed.
Dual view DVI/CRT	[Disabled]	Only one CRT or DVI monitor is driven.
	[Enabled]	When a CRT and a DVI monitor are connected, both are activated.
Onboard Graphics (IGD)	Auto	BIOS detects whether another graphics module is inserted and switches over depending on the "Default Primary Video Adapter" setting.
	Disabled	The graphic integrated in the chipset is disabled. This setting should only be selected if another graphics card is installed.

Note

The second Ethernet interface support is OS dependent. For DOS based applications (e.g. Image Creator) please use the first Ethernet interface.

Note

For or operation without a monitor (= headless operation), Dual view DVI/CRT should be set to "Disabled".

17.4.5 Advanced menu

Menu layout

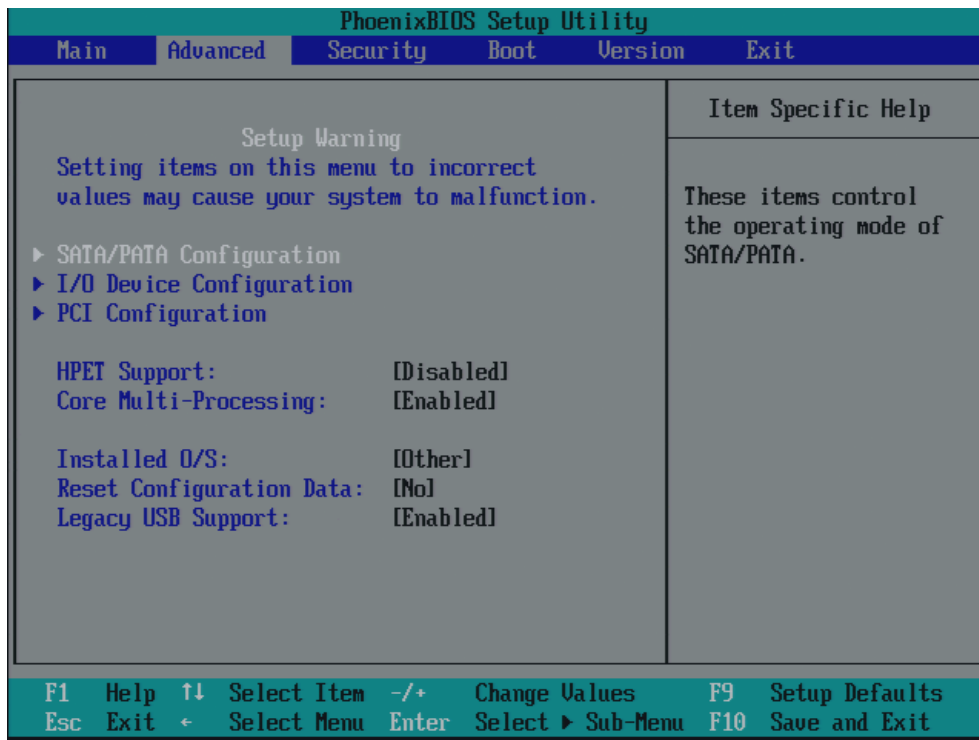

Figure 17-15 "Advanced" menu (example)

Settings in the Advanced Menu

HPET Support	[Disabled]	High-resolution timer for multimedia disabled
	[Enabled]	High-resolution timer for multimedia enabled
Core Multi-Processing ¹⁾	[Disabled]	Core Multi-Processor is disabled Default setting for operating systems that do not support Core Multi-Processing (for example: Windows 2000)
	[Enabled]	Core Multi-Processor enabled

VT Feature *	[Enabled]	VT support of the CPU can be used
	[Disabled]	VT support of the CPU is disabled

Installed O/S	Plug&Play means that all modules are automatically detected and installed, providing they support the Plug&Play functionality.	
	[Other]	BIOS handles the entire Plug&Play capability, default setting.
	[WinXP/2000]	The operating system handles the Plug&Play functions.

Reset Configuration Data	[Yes]	All installations under Plug&Play are deleted and the configuration is retrigged the next time the system boots. The entry is then reset to [No]. System components that do not support Plug&Play have to be entered manually.
	[No]	The Plug&Play system components are initialized after the next system start.
Legacy USB support	[Disabled]	Disables Legacy Universal Serial Bus support
	[Enabled]	Enables Legacy Universal Serial Bus support The USB Boot function must be enabled to allow booting from a USB device, or if the system is to be operated without USB support with a USB keyboard or mouse.
USB controller restart	[Enabled]	The USB controller restart function has to be activated before you can install an operating system or if you experience problems with a user interface (Human Interface Device).

¹⁾ Optional product feature

"SATA/PATA Configuration" submenu

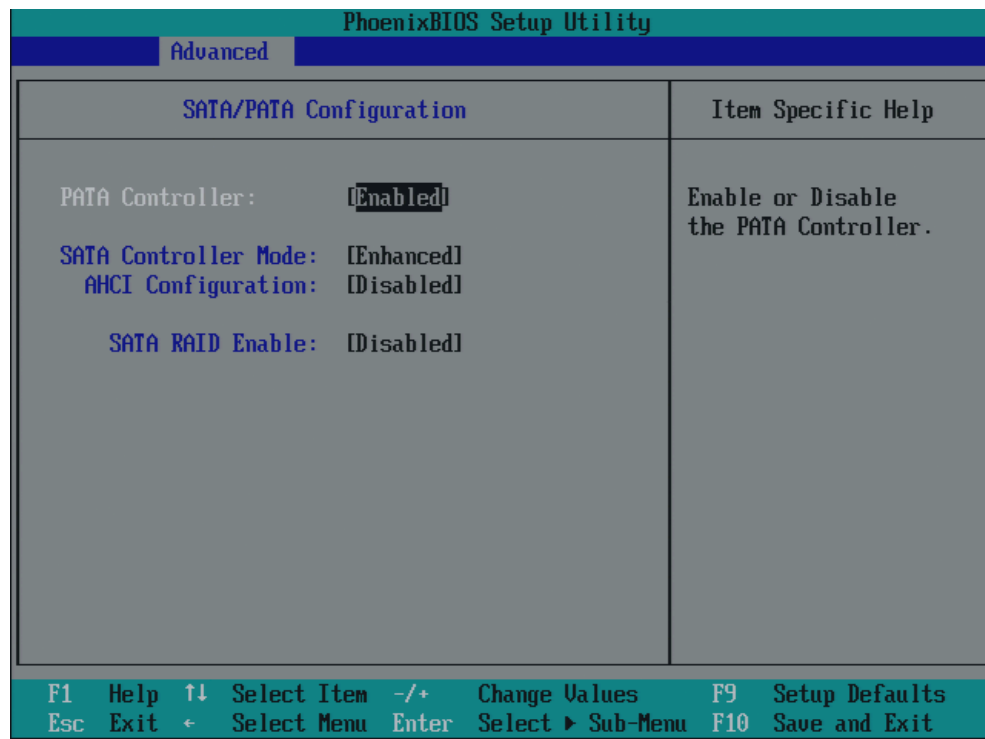

Figure 17-16 "SATA/PATA Configuration" submenu

PATA Controller:	[Enabled] [Disabled]	Disables or enables the PATA controller
SATA Controller mode	[Enhanced]	SATA drive = Primary on the SATA controller in native mode. PATA drive = Primary on the PATA controller in legacy mode.
	[Compatible]	SATA drive = Primary on the SATA controller, in legacy mode PATA drive = drive on the SATA controller in legacy mode
AHCI Configuration	[Disabled] [Enabled]	Disables or enables AHCI support (must be enabled for RAID systems).
SATA RAID Enable	[Disabled] [Enabled]	Disables or enables RAID support

"I/O Device Configuration" submenu

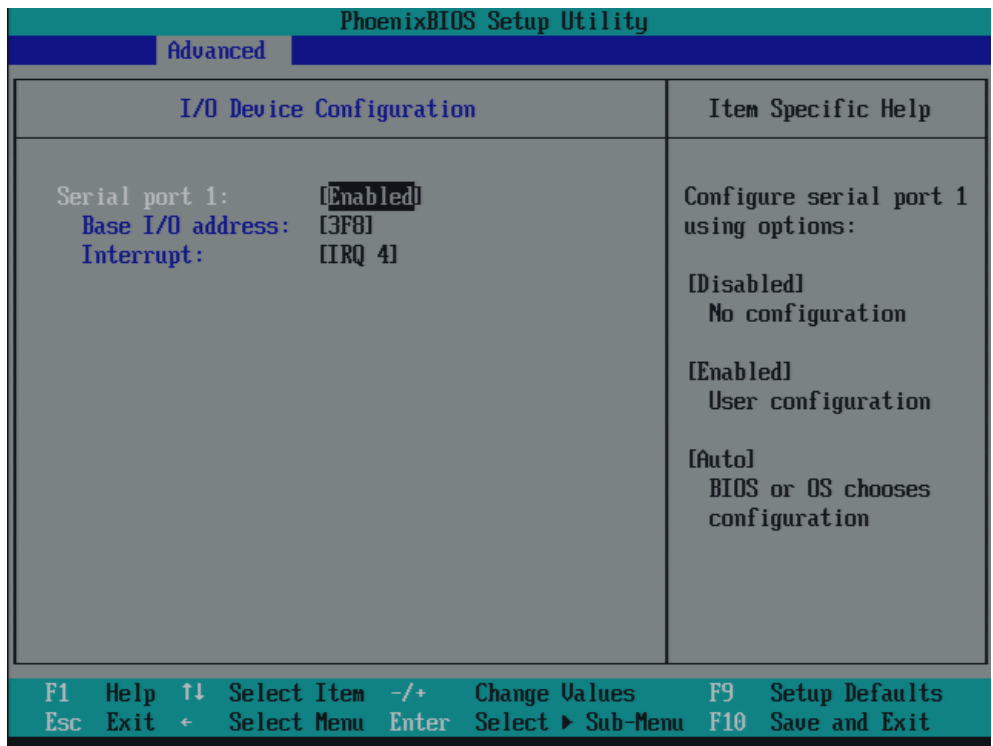

Figure 17-17 "I/O Device Configuration" submenu

The resources used by an interface are released when you disable the interface in question. The I/O addresses and interrupts are pre-assigned; it is advisable not to change these default assignments.

"PCI Configuration" submenu

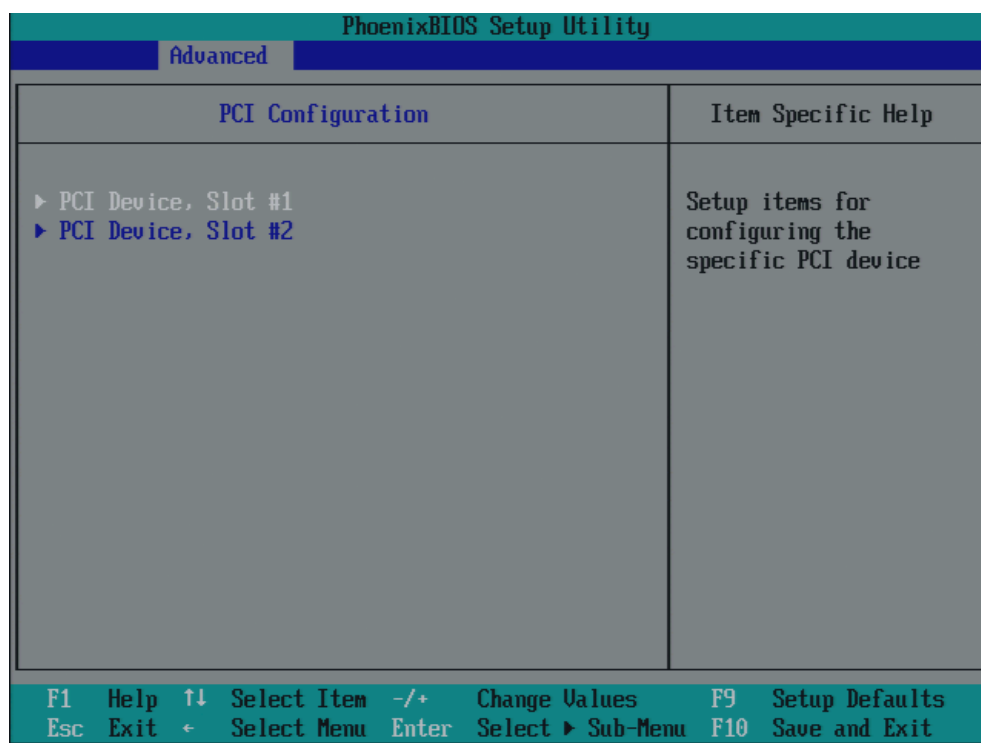

Figure 17-18 "PCI Configuration" submenu (Example)

Note

The submenu for slot 2 is not displayed for the "1 PCI Slot and 1 PCI Express Slot" product models.

"PCI Devices" field

If the PCI devices field is selected, the following submenu appears:

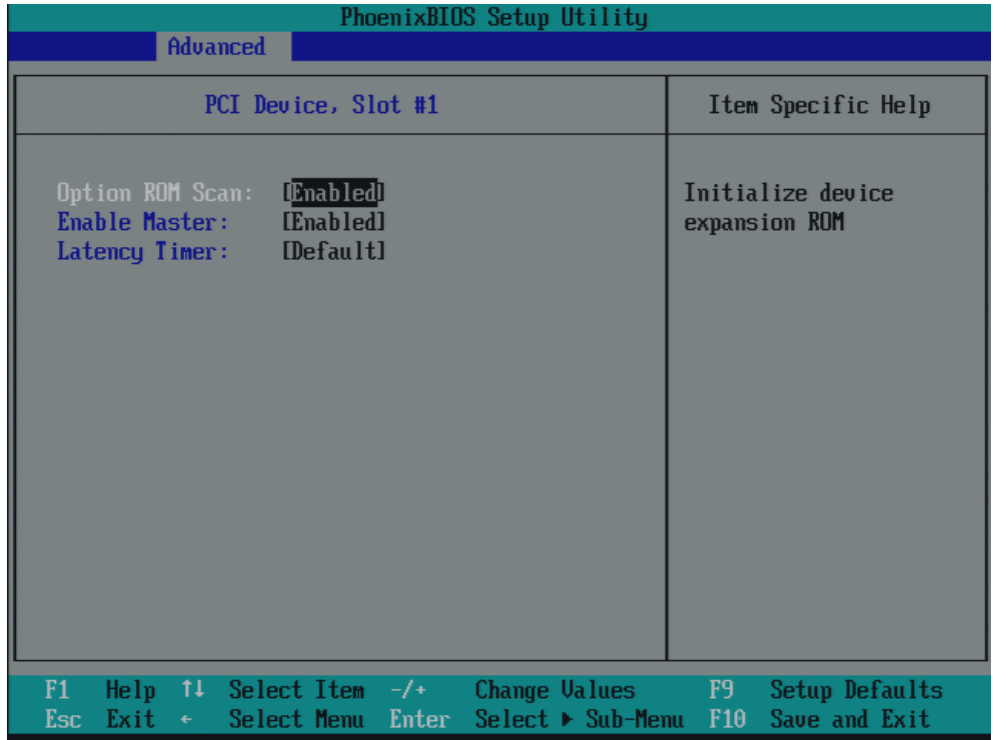

Figure 17-19 "PCI Devices, slot #1" submenu (example)

ROM scan option:	[Enabled]	The ROM option of the PCI module (if present) is enabled
	[Disabled]	The ROM option of a PCI module is disabled.
Enable Master	[Enabled]	This slot can be assigned PCI master functions
	[Disabled]	This slot can only operate as a PCI slave.
Latency Timer	[Default]	The number of active PCI clock cycles of the master modules is determined by this module
	[0020H to 00E0H]	These settings define the maximum number of active PCI clock cycles according to the set value.
	You should only use a value different from the default if the module or its application requires it.	

17.4.6 Security menu

You can only edit the fields enclosed in square brackets. Two passwords can be assigned to protect your PC from unauthorized use. The Supervisor password can be used to restrict access to the hard disks.

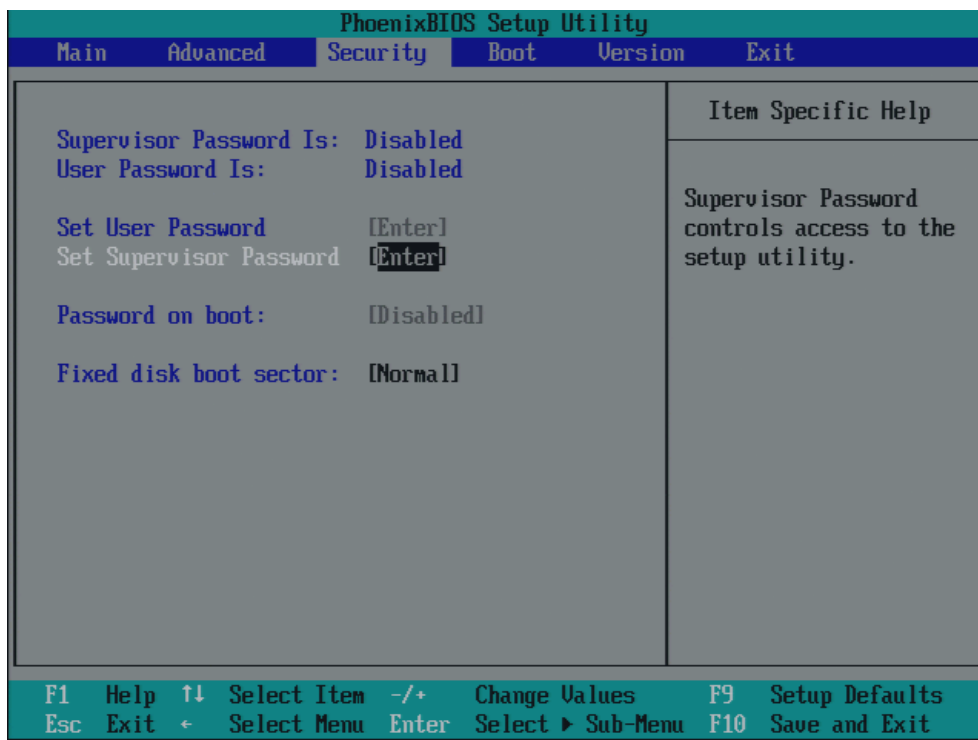

Figure 17-20 Security menu

User password is	Disabled	The password is disabled.
	Enabled	Certain Setup fields are configurable by the user, including the user password.
	The field resets automatically from [Disabled] to [Enabled] when the password is entered.	
Set User Password	This field opens the password input dialog. Logged on users can change the password, or clear and deactivate it by pressing "Return."	
Set Supervisor Password	This field opens the password input dialog. Authorized logged on users can change the supervisor password, or delete and deactivate it by pressing "Return."	
Password on boot	[Disabled]	No password prompt for booting.
	[Enabled]	Supervisor or user password must be entered for system boot.
Fixed disk boot sector	[Normal]	All types of hard-disk access are permitted.
	[Write protect]	the user cannot install an operating system. This is a way of protecting against boot viruses.

Diskette access	This mode of protection is not enabled unless "Password on boot " is [enabled].	
	[Supervisor]	Diskette access is not possible unless the supervisor password was entered during booting.
	[User]	Diskette access is not possible unless the user password was entered during booting. Notice! This function cannot be used under Windows NT/2000 Professional/XP Professional, since these operating systems do not access the diskette via BIOS routines. Use the system programs in Windows 2000/XP Professional system programs to set up this function.

17.4.7 Boot Menu

This menu allows you to assign a priority for the boot devices.

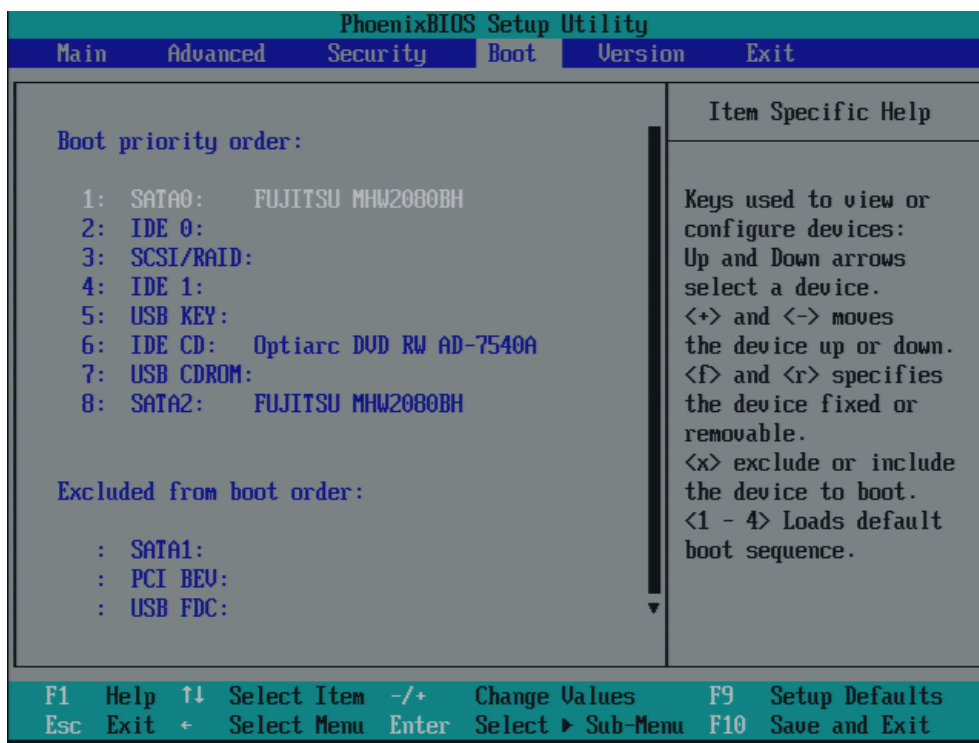

Figure 17-21 Boot Menu

This screen shows all possible boot devices. The boot source with the highest boot priority is at the top. To change the sequence:

Select the boot source with the ↑↓ keys, move to the desired position with + or -.

Note

During startup the boot drive can be selected using the ESC key.

If a boot device is not available, the next device in the sequence is automatically checked to ascertain whether or not it is bootable.

17.4.8 Version Menu

This menu contains system information which should be made available to Technical Support.

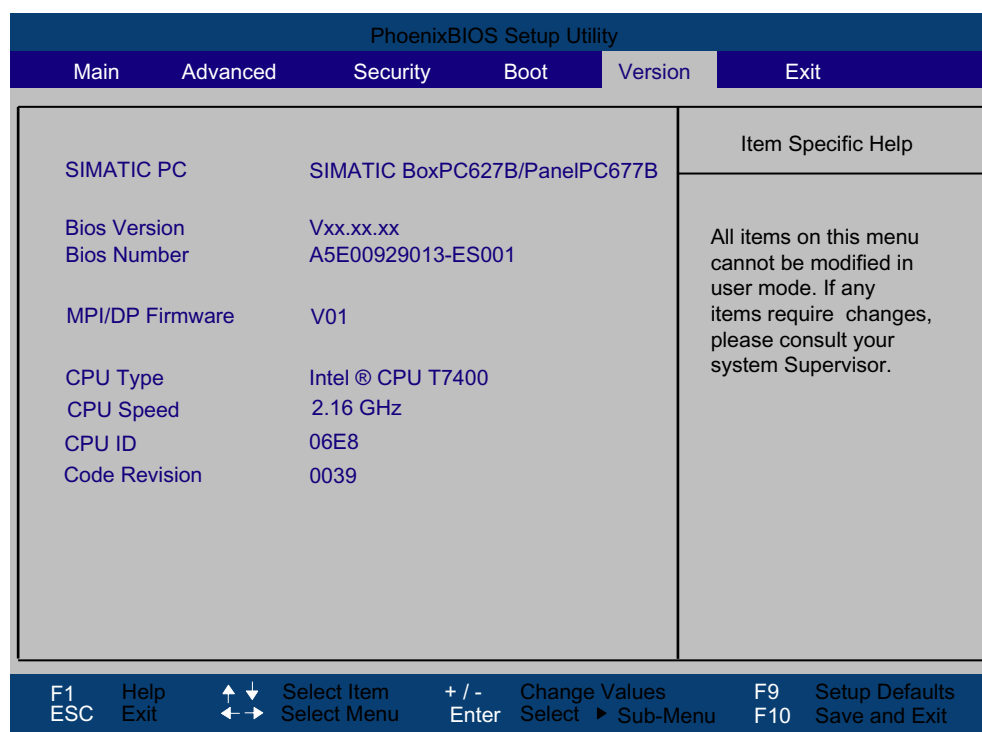

Figure 17-22 Version menu (example)

17.4.9 Exit menu

You always exit BIOS Setup in this menu.

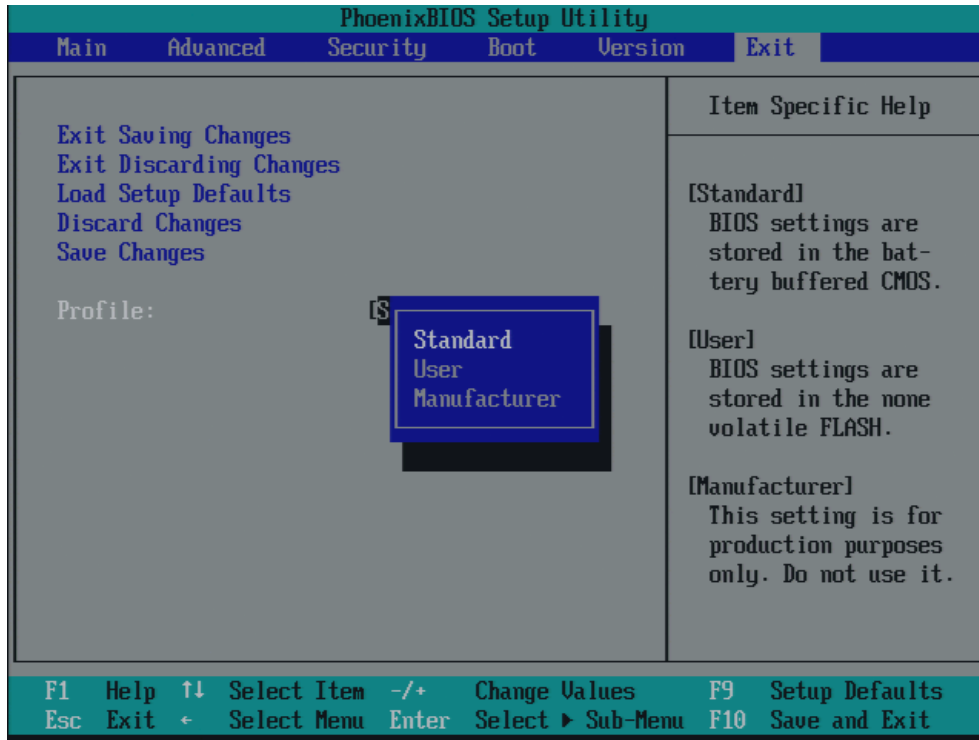

Figure 17-23 The "Exit" menu (example)

Save Changes & Exit	All changes are saved and the system is restarted with the new parameters.	
Exit Without Saving Changes	All changes are discarded and the system is restarted with the old parameters.	
Get Default Values	All parameters are set to safe values.	
Load Previous Values	The last saved values are reloaded.	
Save Changes	Save all Setup settings.	
Profiles	Standard	The BIOS settings are backed up to buffered CMOS
	User	The BIOS settings are saved in the non-volatile Flash memory.
	Manufacturer	This setting is only used for production purposes. Do not use.

17.4.10 BIOS Setup default settings

Documenting your device configuration

If you have changed any default settings in Setup, you can enter them in the following table. You can then refer to these entries for any future hardware modifications.

Note

Print out the table below and keep the pages in a safe place once you made your entries.

Note

The default setup settings vary depending on the ordered device configuration.

BIOS Setup default settings

System parameters	Defaults	Custom entries
Main		
System Time	hh:mm:ss	
System Date	MM/DD/YYYY	
IDE Channel 0 Master	None *	
IDE Channel 0 Slave	None	
SATA Port 0	120GB SATA1 *	
SATA Port 1	None *	
SATA Port 2	None	
SATA Port 3	None	
Memory Cache	Write Back	

Boot options		
Quick Boot Mode	Enabled	
SETUP prompt	Enabled	
POST errors	All, but not keyboard	
Summary screen	Enabled	
Diagnostic screen	Enabled	
Post Code/Status	LPC Bus	

Keyboard Features		
Numlock	On	
Key Click	Disabled	
Keyboard auto-repeat rate	30/sec	
Keyboard auto-repeat delay	½ sec	

Hardware Options		
PCI - MPI / DP ¹⁾	Enabled	
PROFINET ¹⁾	Enabled	
MAC Address Layer 1	000E8C80A63E (example)	
MAC Address Profinet	000E8C80A63F (example)	
On-board Ethernet 1	Enabled	
On-board Ethernet 1 Address	08000624xxxx	
On-board Ethernet 1 Remote Boot	Disabled	
On-board Ethernet 2	Enabled	
On-board Ethernet 2 Address	08000624xxxx	
On-board Ethernet 2 Remote Boot	Disabled	
SafeCard functions	Enabled	
Fan Control	Enabled	
Dual view DVI/CRT	Disabled	
Onboard Graphics (IGD)	Auto	

Advanced		
HPET Support	Disabled	
Core Multi-Processing	Enabled (for WinXP, Win Vista)	
	Disabled (for Win2000 and other operating systems)	
VT	Disabled	
Installed O/S	Other	
Reset Configuration Data	No	
Legacy USB support	Enabled	

I/O Device Configuration		
Internal COM 1	Enabled	
Base I/O address	3F8	
Interrupt	IRQ 4	

PCI Configuration		
PCI Device Slot 1		
ROM scan option:	Enabled	
Enable Master	Enabled	
Latency timer	Default	
PCI Device Slot 2		
ROM scan option:	Enabled	
Enable Master	Enabled	
Latency timer	Default	

SATA/PATA Configuration		
PATA Controller:	Enabled	
SATA Controller mode	Enhanced ¹⁾	
AHCI Configuration	Disabled ¹⁾	
RAID support	Disabled ¹⁾	

Security		
Supervisor password is	Disabled	
User password is	Disabled	
Set User Password	Enter	
Set Supervisor Password	Enter	
Password on boot	Disabled	
Fixed disk boot sector	Standard	

Boot		
Boot priority order:		
Excluded from boot order:		

Version		
SIMATIC PC	SIMATIC BoxPC627B/ PanelPC677B	
BIOS Version	V05.01.XX	
BIOS Number	A5E00378214-ES008	
MPI/DP Firmware	V01	
CPU Type	Intel® Core 2 Duo 2.16 GHz	
CPU ID	06D6	
Code Revision	0017	

¹⁾ Depends on the ordered device configuration

17.5 CP 1616 onboard communications processor

17.5.1 Introduction

The CP 1616 onboard allows the connection of industrial PCs to Industrial Ethernet.

The basic characteristics of the PCS 1616 onboard are:

- Optimized for PROFINET IO
- With Ethernet realtime ASIC ERTEC 400
- Three RJ45 sockets for connecting terminal devices or addition network components
- Integrated 3-port real-time switch
- Automatic hardware detection

17.5.1.1 Network connections

Ethernet

The CP 1616 is designed for operation in Ethernet networks. Additional features are:

- The connectors are designed for 10BaseT and 100BaseTX.
- Data transfer rates of 10 and 100 Mbps in full/half duplex mode are supported.
- The handshake is performed automatically (auto negotiation).
- A 3-port realtime switch is located in the module.
- Autocrossing

Three RJ45 connectors

The CP 1616 is connected to the LAN (Local Area Network) via one of the three RJ45 sockets of the PC.

These three sockets lead to the integrated realtime switch.

17.5.1.2 Typical Communication Partners

CP 1616 onboard as an IO controller

The following diagram shows a typical application: CP 1616 onboard as PROFINET IO controller on the IO controller layer.

The IO base controller user program runs on the PC. This program accesses the functions of the IO base user program interface.

Data traffic is routed via the communication processor to several SIMATIC S7 PROFINET IO devices, ET 200S over Industrial Ethernet.

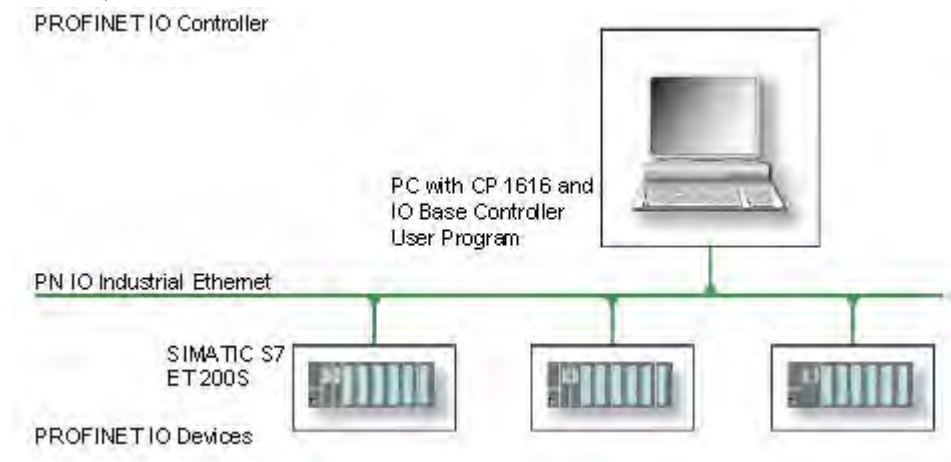

CP 1616 onboard as IO device

The following diagram shows a typical application: Two PCs each with a CP as a PROFINET IO device on the IO device layer.

A PC with a CP as PROFINET IO controller, a SIMATIC S7-400 with a CP 443-1 as PROFINET IO controller and two SIMATIC S7 ET 200S PROFINET IO devices are also connected in the network.

The IO base device user program runs on the IO device PC. This program accesses the functions of the IO base user program interface. Data traffic is routed via the CP 1616 onboard communication processor to a PC as PROFINET IO controller or an S7-400 automation system with CP 443-1 over Industrial Ethernet.

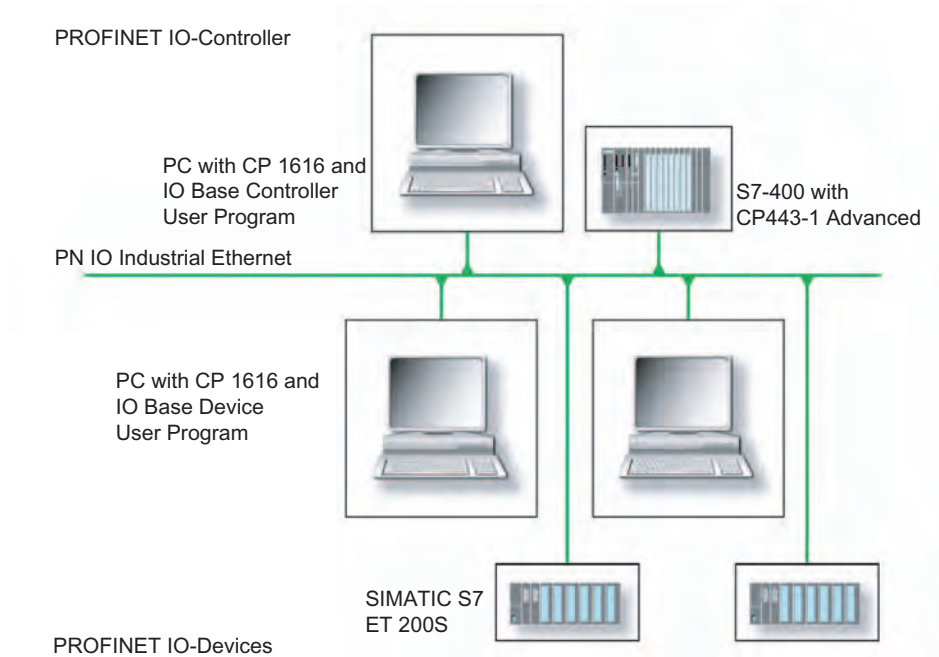

17.5.2 Firmware loader

Scenario for using the firmware loader

The CP 1616 onboard is supplied with the latest version of the firmware. If new functions become available due to product development, you can make them available by performing a firmware download.

Description

This section will familiarize you with the application area and use of the firmware loader. You can find additional, detailed information about the individual loader variants in the integrated help of the program.

Firmware

This refers to the system program in the SIMATIC NET modules.

Application area for the firmware loader

The firmware loader enables you to reload new firmware releases to SIMATIC NET modules. It is used for:

- PROFIBUS modules
- Industrial Ethernet modules
- Modules for gateways, for example IE/PB link

Installation

The firmware loader is available on your PG/PC under Windows following the installation of STEP 7/NCM PC.

Loader files

The firmware loader supports the following file types:

- <File>.FWL
A file format that contains information in addition to the LAD file format, which is displayed by the firmware loader. The firmware loader can use this information to check if the firmware is compatible to the device.
- <File>.LAD
A file format that only contains the system program to be loaded into the module.

Read the information provided along with the loader file, for example, in the readme file. This information is also displayed in the firmware loader when the FWL file is loaded.

17.5.2.1 Loading firmware

Start downloading procedure

1. In the Windows Start menu, select the menu command SIMATIC > STEP 7 > NCM S7 > Firmware Loader.

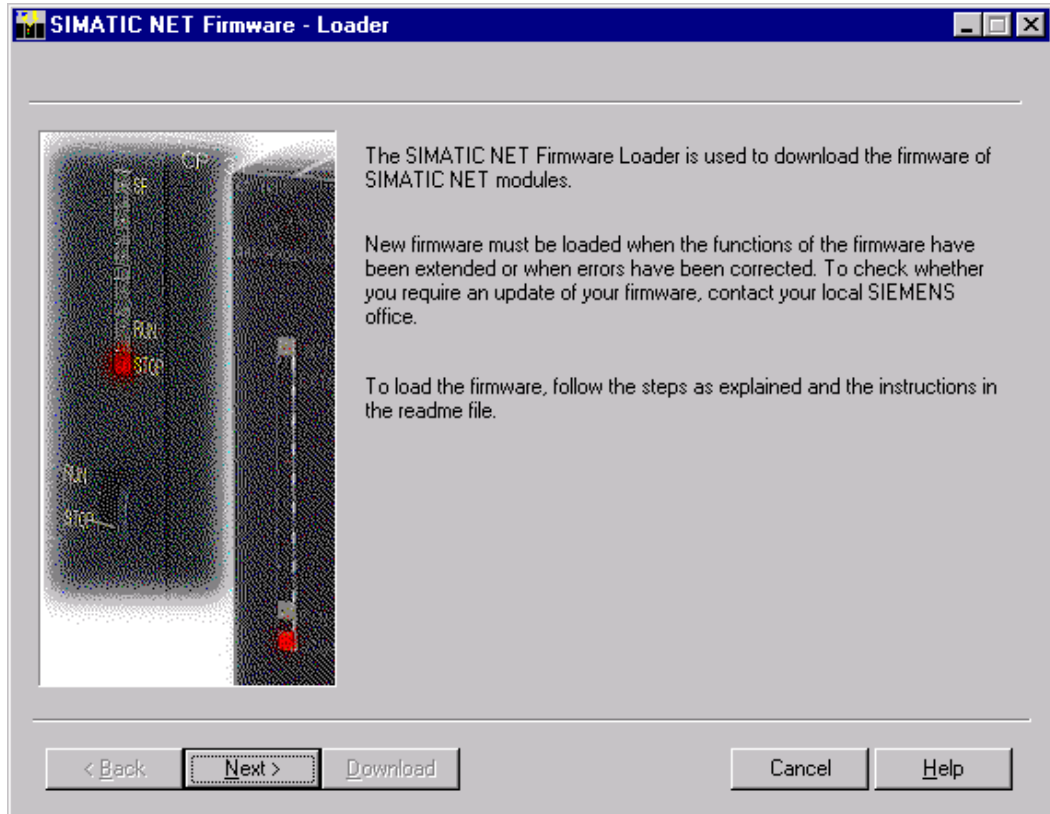

2. Click "Next" and follow the instructions in the dialog fields that follow. A help function is integrated in the software as support.

CAUTION

Ensure that the loader file you are using for the update is suitable for the version of firmware on your module. If you have any doubts, contact your local Siemens consultant.

CAUTION

Be aware that aborting the loading process may result in an inconsistent state in your module.

You can find additional, detailed information about the individual loader variants in the integrated help.

NOTICE

When loading the firmware or commissioning the module, be aware that the CP 1616 onboard takes five MAC addresses (always in direct sequence). The first two are shown in the BIOS.

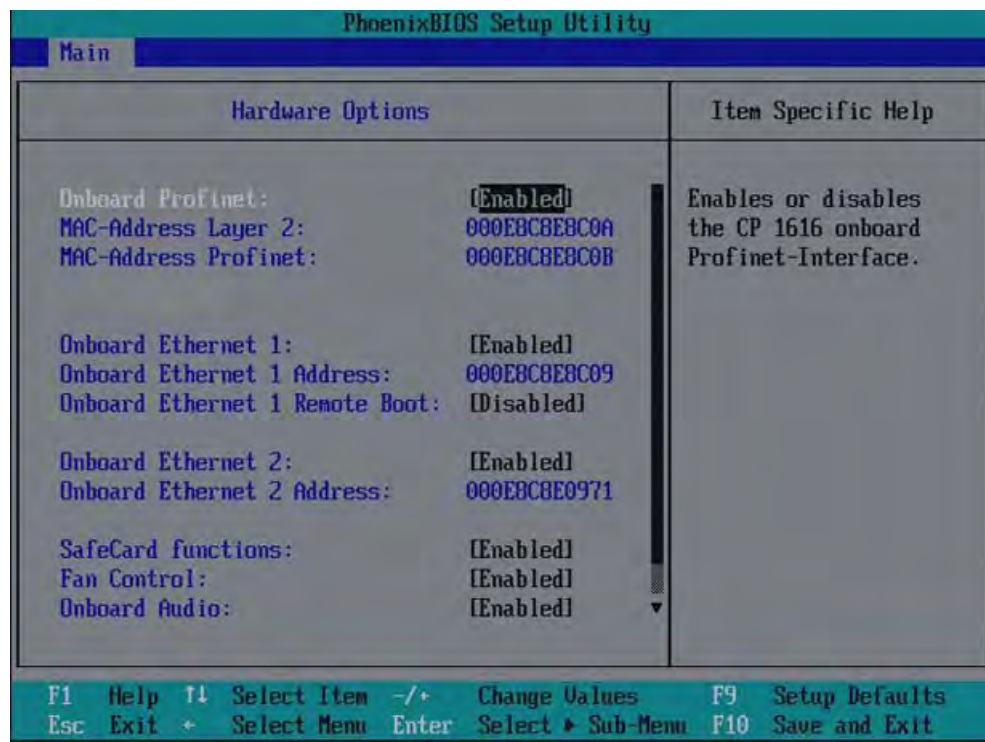
**Example**

The lowest address is for the layer 2 communication. The second is for Ethernet/PROFINET communication.

17.5.3 Further actions in STEP 7/NCM PC**Configuring**

Your PC is now ready, although you still have to configure the SIMATIC NET communication software. The rest of the procedure is described in the "Commissioning PC Stations" manual (on the Windows PC that also contains STEP 7/NCM PC: Start > Simatic > Documentation > English > Commissioning PC Stations).

Appendix

A.1 Certificates and guidelines

A.1.1 Guidelines and declarations

Notes on the CE marking

 The following applies to the SIMATIC product described in this documentation:

EMC directive

AC voltage supply

The devices with AC voltage supply fulfill the requirements of the EC directive "89/336/EEC Electromagnetic Compatibility" and are intended for the following fields of application in accordance with the CE marking:

Application range	Requirement for	
	Noise emission	Immunity to interference
Industry	EN 61000-6-4: 2001	EN 61000-6-2: 2001

The device is also compliant with EN 61000-3-2:2000, harmonic currents and EN 61000-3-3:1995, voltage fluctuations and flicker.

DC voltage supply

These devices with DC voltage supply fulfill the requirements of the EC directive "89/336/EEC Electromagnetic Compatibility" and are intended for the following fields of application in accordance with the CE marking:

Application range	Requirement for	
	Noise emission	Immunity to interference
Industry	EN 61000-6-4: 2001	EN 61000-6-2: 2001

The device is also compliant with EN 61000-3-2:2000, harmonic currents and EN 61000-3-3:1995, voltage fluctuations and flicker.

CAUTION

This is a system of Class A. The equipment may cause RF interference in residential areas. In this case, the operating company may be held liable for taking appropriate measures.
--

Low-voltage directive

The device with AC power pack complies with the requirements of EC directive 73/23/EEC (Low-Voltage Guidelines). Compliance has been verified by a test in accordance with the EN 60950-1 standard. The device with DC power pack also complies with this standard but does not fall within the area of validity of the EU low-voltage directive.

Declaration of conformity

The EC declaration of conformity and the corresponding documentation are made available to authorities in accordance with the EC directives stated above. The declaration of conformity can be downloaded at <http://www.siemens.com/asis> under "Support".

Click on "Software Tools & Downloads" on "Overview Panel PCs" You can find the declaration under Approvals / Certificates.

Design guidelines

Adhere to the installation guidelines and safety instructions given in this documentation during commissioning and operation.

Connecting peripherals

The requirements regarding noise immunity to EN 61000-6-2:2001 are met when you connect a peripheral suitable for an industrial environment. Always use shielded cables to connect peripherals.

A.1.2 Certificates and approvals

DIN ISO 9001 certificate

The quality assurance system for the entire product process (development, production, and marketing) at Siemens fulfills the requirements of ISO 9001 (corresponds to EN 29001: 1987).

This has been certified by DQS (the German society for the certification of quality management systems).



EQ-Net certificate no.: 1323-01

Software License Agreement

The device can be supplied with or without preinstalled software. For devices with preinstalled software, please note the relevant license agreements.

Certification for the United States and Canada

Safety

One of the following markings on a device is indicative of the corresponding approval:	
	UL-listed, approval from Underwriters Laboratories (UL) for United States and Canada: with abbreviation 'I.T.E.' in accordance with binational standard UL 60950-1 / CAN/CSA-22.2 No. 60950-1, with abbreviation 'IND.CONT-EQ' in accordance with standards UL 508 and CSA C22.2. No. 14-5
	UL recognition mark: Components that cannot be operated autonomously, approved by UL

EMC

USA	
Federal Communications Commission Radio Frequency Interference Statement	This equipment has been tested and found to comply with the limits for a Class A digital device, pursuant to Part 15 of the FCC Rules. These limits are designed to provide reasonable protection against harmful interference when the equipment is operated in a commercial environment. This equipment generates, uses, and can radiate radio frequency energy and, if not installed and used in accordance with the instruction manual, may cause harmful interference to radio communications. Operation of this equipment in a residential area is likely to cause harmful interference in which case the user will be required to correct the interference at his own expense.
Shielded cables	Shielded cables must be used with this equipment to maintain compliance with FCC regulations.
Modifications	Changes or modifications not expressly approved by the manufacturer could void the user's authority to operate the equipment.
Conditions of operations	This device complies with Part 15 of the FCC Rules. Operation is subject to the following two conditions: (1) this device may not cause harmful interference, and (2) this device must accept any interference received, including interference that may cause undesired operation.

CANADA	
Canadian Notice	This Class A digital apparatus complies with Canadian ICES-003.
Avis Canadian	Cet appareil numérique de la classe A est conforme à la norme NMB-003 du Canada.

A.1.3 Service and support

Local information

If you have questions about the products described in this document, you can find help at:
<http://www.siemens.com/automation/partner>

Technical documentation for SIMATIC products

Further documentation for SIMATIC products and systems can be found at:
<http://www.siemens.com/simatic-tech-doku-portal>

Easy Shopping at the Mall

Catalog & online ordering system <http://www.siemens.com/automation/mall>

Training

All the training options are listed at: <http://www.siemens.com/sitrain>
Find a contact at: Phone: +49(911) 895-3200

Technical support

Tel +49 180 5050 222
Fax +49 180 5050 223
<http://www.siemens.com/automation/csi/service>

A Web form for Support Request can be found at:

<http://www.siemens.com/automation/support-request>

When you contact the customer support, please have the following information for the technician on hand:

- BIOS version
- Order No. (MLFB) of the device
- Installed additional software
- Installed additional hardware

Online support

Information about the product, Support and Service, right through to the Technical Forum, can be found at: <http://www.siemens.com/automation/service&support>

After-sales information system for SIMATIC PC / PG

Information about contacts, drivers, and BIOS updates, FAQs and Customer Support can be found at: <http://www.siemens.com/asis>

List of Abbreviations/Acronyms

B.1 Abbreviations

Abbreviation	Term	Meaning
AC	Alternating current	Alternating current
ACPI	Advanced Configuration and Power Interface	
PLC	Programmable controller	
APIC	Advanced Programmable Interrupt Controller	Extended programmable interrupt controller
APM	Advanced Power Management	Tool for monitoring and reducing power consumption of the PC
AS	Automation system	
AT	Advanced Technology	
ATA	Advanced Technology Attachment	
AWG	American Wire Gauge	US standard for the cable diameter
BIOS	Basic Input Output System	Basic Input Output System
CAN	Controller Area Network	
CE	Communauté Européenne (CE symbol)	The product is in conformance with all applicable EC directives
CF	Compact Flash	
CLK	Clock pulse	Clock signal for controllers
CMOS	Complementary Metal Oxide Semiconductors	Complementary metal oxide semiconductors
COA	Certificate of authentication	Microsoft Windows Product Key
CoL	Certificate of License	License authorization
COM	Communications Port	Term for the serial interface
CP	Communication Processor	Communication computer
CPU	Central Processing Unit	CPU
CSA	Canadian Standards Association	Canadian organization for tests and certifications according to own or binational standards (with UL / USA) standards
CTS	Clear To Send	Clear to send
DRAM	Dynamic Random Access Memory	
DC	Direct Current	DC current
DCD	Data Carrier Detect	Data carrier signal detection
DMA	Direct Memory Access	Direct memory access

List of Abbreviations/Acronyms

B.1 Abbreviations

Abbreviation	Term	Meaning
DP	Distributed I/O	
DQS	Deutsche Gesellschaft zur Zertifizierung von Qualitätsmanagement mBH	
DDRAM	Double Data Random Access Memory	Memory chip with high-speed interface
DSR	Data Set Ready	Ready for operation
DTR	Data Terminal Ready	Data terminal is ready
DVD	Digital Versatile Disc	Digital versatile disk
DVI	Digital Visual Interface	Digital display interface
ECC	Error Correction Code	Error correction code
ESD	Components sensitive to electrostatic charge	
EIDE	Enhanced Integrated Drive Electronics	An enhancement of the IDE standard
EMM	Expanded Memory Manager	Manages memory expansions
EN	European standard	
EPROM / EEPROM	Erasable Programmable Read-Only Memory / Electrically Erasable Programmable Read-Only Memory	Plug-in submodules with EPROM/EEPROM chips
ESC	Escape character	Control character
EFW	Enhanced Write Filter	
FAT 32	File Allocation Table 32-bit	32-bit file allocation table
FSB	Front Side Bus	
GND	Ground	Chassis ground
HD	Hard disk	Hard disk
HU	Height unit	
HMI	Human Machine Interface	User interface
HTTP	Hypertext Transfer Protocol	Protocol for data transfer on the Internet
Hardware	Hardware	
I/O	Input/Output	Data input/output on computers
IDE	Integrated Device Electronics	
IEC	International Electrotechnical Commission	
IP	Ingress Protection	Degree of protection
IRQ	Interrupt Request	Interrupt request
IT	Information Technology	Information technology
LAN	Local Area Network	Computer network that is limited to a local area.
LCD	Liquid Crystal Display	Liquid crystal display
LVDS	Low Voltage Differential Signaling	
LW	Disk drive	
MLFB	Machine-readable product designation	
MPI	Multipoint-capable interface for programming devices	
MTBF	Mean Time Between Failures	
MUI	Multilanguage User Interface	Language localization in Windows
NA	Not Applicable	

Abbreviation	Term	Meaning
NAMUR	Normenarbeitsgemeinschaft für Mess- und Regelungstechnik in der chemischen Industrie (standardization body for instrumentation and control technology in the chemicals industry)	
NC	Not Connected	Not connected
NCQ	Native Command Queuing	Automatic re-sorting of the file and disk access, for increased performance
NEMA	National Electrical Manufacturers Association	Syndicate of manufacturers of electrical components in the USA
NTFS	New Techniques File System	Secure file system for Windows versions (2000, XP, Vista)
OPC	OLE for Process Control	Standardized interface for industrial processes
PATA	Parallel ATA	
PCI	Peripheral Component Interconnect	High-speed expansion bus
PI	Protective Earth	Protective conductor
PG	Programming device	
PIC	Programmable Interrupt Controller	Programmable interrupt controller
POST	Power On Self Test	
PXE	Preboot Execution Environment	Software for running new PCs without hard disk data via the network
RAID	Redundant Array of Independent Disks	Redundant hard disk array
RAM	Random Access Memory	
ROM	Read-Only Memory	
RS 485	Reconciliation Sublayer 485	Bi-directional bus system designed for up to 32 nodes
RTC	Real Time Clock	Real-time clock
RTS	Reliable Transfer Service	Request to send
RxD	Receive Data	Data transfer signal
SATA	Serial ATA	
SDRAM	Synchronous DRAM	
SELV	Safety Extra Low Voltage	Safety extra low voltage
SMART	Self Monitoring Analysis and Reporting Technology	Hard disk error diagnostics program
SNMP	Simple Network Management Protocol	Network protocol
SO-DIMM	Small Outline Dual Inline Memory Module	
SOM	SafeCard on Motherboard (SOM)	
SVGA	Super Video Graphics Array	Enhanced VGA standard with at least 256 colors
SVP	Serial number of the device	
TFT	Thin-Film-Transistor	Type of LCD flat-screen
TxD	Transmit Data	Data transfer signal
TWD	Watchdog Time	Watchdog monitoring time
UL	Underwriters Laboratories Inc.	US organization for tests and certifications according to own or binational standards (with CSA / Canada) standards

List of Abbreviations/Acronyms

B.1 Abbreviations

Abbreviation	Term	Meaning
UMA	Unified Memory Architecture	
URL	Uniform Resource Locator	Designation of the full address of an Internet page
USB	Universal Serial Bus	
UXGA	Ultra Extended Graphics Array	Graphic standard, maximum resolution 1.600 x 1.200 pixels
V.24		ITU-T standardized recommendation for data transfer via serial ports
VGA	Video Graphics Array	Video adapter which meets industrial standard
VRM	Voltage Regulator Module	
WD	Watchdog	Program monitoring with error detection and alarming.
XGA	Extended Graphics Array	Graphic standard, maximum resolution 1.024 x 768 pixels

Glossary

Automation system (AS)

The programmable logical controllers (PLC) of the SIMATIC S7 system consist of a central controller, one or more CPUs, and various I/O modules.

Backup

Duplicate of a program, data carrier or database, used either for archiving purposes or for the protection of vital and non-replaceable data against loss when the working copy is corrupted. Some applications automatically generate backup copies of data files, and manage both the current and the previous versions on the hard disk.

BEEP code

If the BIOS detects a boot error, it outputs an audible warning based on the current test result

Booting

Start or restart of the computer. During booting the operating system is transferred from the system data carrier to the work memory.

Cache

High-speed access buffer for interim storage (buffering) of requested data.

CE marking

Communauté Européene The CE marking confirms compliance of the product with corresponding EC Directives, for example, with the EMC Directive.

Chipset

Located on the motherboard, connects the processor with the RAM, the graphic controller, the PCI bus, and the external interfaces.

Cold start

A start sequence, starting when the computer is switched on. The system usually performs some basic hardware checks within the cold start sequence, and then loads the operating system from the hard disk to work memory -> boot

COM interface

The COM interface is a serial V.24 interface. The interface is suitable for asynchronous data transfer.

Configuration files

These are files containing data which define the configuration after restart. Examples of such files are CONFIG.SYS, AUTOEXEC.BAT and the registry files .

Configuration software

The configuration software updates the device configuration when new modules are installed . This is done either by copying the configuration files supplied with the module or by manual configuration using the configuration utility.

Controller

Integrated hardware and software controllers that control the functions of certain internal or peripheral devices (for example, the keyboard controller).

Device configuration

The configuration of a PC or programming device contains information on hardware and device options, such as memory configuration, drive types, monitor, network address, etc. The data are stored in a configuration file and enable the operating system to load the correct device drivers and configure the correct device parameters. . If changes are made to the hardware configuration, the user can change entries in the configuration file using the SETUP program. .

Drivers

Program parts of the operating system. They adapt user program data to the specific formats required by I/O devices such as hard disk, printers, and monitors.

EMC directive

Directive concerning **Electromagnetic Compatibility**. Compliance is confirmed by the CE marking and the EC certificate of conformity.

Energy management

The energy management functions of a modern PC allow individual control over the current consumption of vital computer components (e.g. of the monitor, hard disk and CPU), by restricting their activity based on the current system or component load. Energy management is of particular importance for mobile PCs.

Energy options

The energy options can be used to reduce energy consumption of the computer, while keeping it ready for immediate use. This can be configured in Windows by selecting Settings > Control Panel > Energy options.

ESD guidelines

Directive for using electrostatic sensitive components.

Ethernet

Local network (bus structure) for text and data communication with a transfer rate of 10/100 Mbps.

Formatting

Basic partitioning of memory space on a magnetic data carrier into tracks and segments. Formatting deletes all data on a data carrier. All data carriers must be formatted prior to their first use.

Hard disks

Hard disks represent a form of magnetic disk storage medium (Winchester drives, hard disks) with integrated magnetic disks.

Hub

A term in network technology. In a network, a device joining communication lines at a central location, providing a common connection to all devices on the network.

Image

This refers to the image, for example, of hard disk partitions saved to a file in order to restore them when necessary.

Interface

see Interface

LAN

Local Area Network: LAN is a local network that consists of a group of computers and other devices that are distributed across a relatively restricted range and are linked with communication cables. The devices connected to a LAN are called nodes. The purpose of networks is the mutual use of files, printers or other resources.

Legacy USB support

Support of USB devices (e.g. mouse, keyboard) on the USB ports without driver.

License key

The license key represents the electronic license stamp of a license. Siemens provides the license keys for protected software.

License key diskette

The license key diskette contains the authorizations or license keys required to enable protected SIMATIC software.

Low-voltage directive

EC directive for product safety of products operated with low voltage (50 VAC to 1000 VAC, 70V to 1500 VDC) that are not governed by other directives. Compliance is confirmed by the CE marking and the EC certificate of conformity.

Module

Modules are plug-in units for PLCs, programming devices or PCs. They are available as central modules, interfaces, expansion modules or mass storage (mass storage modules), for example.

Module bracket

The module bracket is used to fasten modules and ensure safe contact and transport. Shocks and vibrations especially affect large, heavy modules. It is therefore recommended to use the module bracket for this type of module. There are also short, compact and light modules on the market. The module bracket was not designed for these modules because the standard fastening is sufficient for them.

Motherboard

The motherboard is the core of the computer. Here, data are processed and stored, and interfaces and device I/Os are controlled and managed.

PATA

An interface for hard disk drives and optical drives with parallel data transfer of up to 100 Mbps.

Plug&Play

Generally, a reference to the ability of a computer to automatically configure the system for communication with peripheral devices (for example monitors, modems or printers). The user can plug in a peripheral and "play" it at once without manually configuring the system. A Plug&Play PC requires both a BIOS that supports Plug&Play and a Plug&Play expansion card.

POST

Self-test performed by the BIOS after the computer is switched on. Performs a RAM test and a graphic controller test, for example. The system outputs audible signals (beep codes) if the BIOS detects any errors; the relevant message indicating cause of error is output on the screen.

PROFIBUS/MPI

Process Field Bus (standard bus system for process applications)

PROFINET

PROFINET is the name of the standard for Industrial Ethernet developed and maintained by the PROFIBUS user organization. PROFINET unites protocols and specifications with which Industrial Ethernet meets the requirements of industrial automation technology.

Programmable controller (PLC)

The programmable logical controllers (PLC) of the SIMATIC S5 system consist of a central controller, one or more CPUs, and various other modules (e.g. I/O modules).

PXE server

A **Preboot Execution Environment** server is part of a network environment and can provide software to connected computers even before they boot. This can involve operating system installations or servicing tools, for example.

RAID

Redundant Array of Independent Disks: Data storage system which is used to store data along with the error correction codes (e.g. parity bits) on at least two hard disks, in order to increase system reliability and performance. The hard disk array is controlled by management programs and a hard disk controller for error correction. The RAID system is usually implemented in network servers.

Recovery DVD

Contains the tools for setting up the hard disks and the Windows operating system.

Reset

Hardware reset: Reset/restart of the PC using a button/switch.

Restart

Warm start of a computer in operating state without switching off the power supply (Ctrl + Alt + Del)

Restore DVD

The Restore DVD is used to restore the system partition or the entire hard disk to factory state if the system has crashed. The bootable DVD contains all the necessary image files. You can also create a boot disk allowing restoration via the network.

SETUP (BIOS Setup)

A program in which information about the device configuration (that is, the configuration of the hardware on the PC/PG) is defined. The device configuration of the PC/PG is preset with defaults. Changes must therefore be entered in the SETUP if a memory extension, new modules or a new drive are added to the hardware configuration.

Troubleshooting

Error cause, cause analysis, remedy

V.24 interface

The V.24 interface is a standardized interface for data transmission. Printers, modems, and other hardware modules can be connected to a V.24 interface

Warm restart

The restart of a computer after a program was aborted. The operating system is loaded and restarted again. The hot key CTRL+ ALT+ DEL can be used to perform a warm start.

Index

A

- AC voltage supply, 253
- Accessories, 22
- Alarms, 78, 79
- Allocation of resources, 122
- Antivirus software, 58
- Approval, 9
- Assignment
 - Memory addresses, 220
- Automatic updates, 78

B

- Backlighting, 20
- Backup battery, 208
- Battery replacement, 133
- Beep codes, 163
- BIOS, 70, 194
 - BIOS settings, 70
- BIOS Setup, 220
 - Defaults, 243
 - Menu layout, 222
 - Menus, 222
 - Starting, 221
- BIOS Setup menus
 - Advanced, 234
 - Boot, 240
 - Main, 224
 - Security, 239
 - Version, 241
- Boot options, 229
- Boot sequence
 - Error messages, 161
- Booting
 - Error messages, 161
- Bus board
 - Removing, 137

C

- Care, 106
- CE marking, 9, 254

- Characteristics, 21
- Check list, 57
- CheckLanguageID, 83
- Clamping frame
 - Seal, 40
- Cleaning, 107
 - Front membrane, 107
 - Stainless steel front, 107
- Cleaning agents, 105
- Cleaning guidelines, 107, 109
- COA label, 27
- Commissioning, 13, 57
 - Device, 57
- Compact Flash card, 127
 - Mounting, 129
 - Partitions, 157
 - Removing, 130
- Computer unit
 - Separating from the control unit, 111
- Condensation, 13, 57
- Connecting, 11, 73, 254
 - AC power supply, 45
 - DC power supply, 48
 - Device, 52
 - Electrical connection, 11
 - Peripherals, 73, 254
 - S7 automation system, 52
- Connector pin assignment
 - PCI Express slot, 213
- Control elements, 99
- Control unit, 20
 - Separating from the computer unit, 111
- couple, 53
 - Device, 53
- Couple
 - Couple device via MPI/PROFIBUS, 52
 - Device, 52
- Coupling with SIMATIC S7, 51
- CPU, 194

D

- Data backup, 160
- Data exchange, 51
- DC power supply

- Connecting, 48
- DC voltage supply, 253
- Defaults
 - BIOS Setup, 243
- Degree of protection, 31
 - IP65 degree of protection, 31
- Design
 - Motherboard, 193
- Design guidelines, 254
- Device, 53, 57, 73
 - Commissioning, 57
 - Connecting, 52
 - Connecting an S7 automation system, 52
 - couple, 53
 - Couple, 52
 - Couple via MPI/PROFIBUS, 52
 - Open, 116
 - Separating, 112
 - Switching on, 73
- Device configuration, 243
- Device driver CP16xx.sys, 51
- Device fan, 140, 141
- Device fan supply, 208
- Device with stainless steel front
 - Installation, 40
- DiagMonitor
 - Expansion, 22
- Diagnostics, 169
 - DiagMonitor, 101
- Dimension drawing, 190
- Dimensions, 190
 - Panel PC 677B, 190
- Direct control key module, 23
- Display, 15, 20
 - Ports, 203
 - TFT-LC display, 15
- Distributed, 51
- Download, 14
- Drive bay module, 122
 - Removing, 124
- Driver installation, 158
- Drivers
 - Installation, 60
- DVD burner, 85, 194
- DVD burner drive
 - Removing, 125

E

- Electrical potential difference, 49
- Electromagnetic compatibility, 36
- Electrostatic charge, 16

- Precautions, 16
- EMC, 36
- EMC directive, 36, 253, 256
 - AC voltage supply, 253
 - DC voltage supply, 253
- Equipotential bonding, 49
- Equipotential Bonding, 49
- Error, 169
- Error messages
 - Booting, 161
- ESD, 16, 17
 - Directive, 16
 - Handling, 17
 - Measuring, 17
 - modify., 17
 - Shipping, 17
- Ethernet, 51
- Expansion, 22
 - Memory, 117
- Expansion modules
 - Mounting, 120
- Expansion slots, 21

F

- Factory state, 149
- Fan
 - Removing, 140, 142
- FAQs, 169
- Fault diagnostics, 163
- Field devices, 51
- Field of application, 25
- Firewall, 58
- Firewall, 78
- First commissioning, 59
- Front membrane, 107, 108
 - Cleaning, 107
- Front ports, 205
- Function key, 97
 - labeling, 97

H

- Hard disk
 - Removing, 126
- Hard disk drives, 21
- Hard disks
 - Partitioning, 151
- Hardware Options, 232
- Hotfix, 14

I

I/O front ports, 205
 IDE channel, 225
 Identification data, 27
 Image
 creating, 160
 Immunity to interference, 36
 Installation
 Drivers, 60
 Memory modules, 119
 Installation information, 28
 Stainless steel front, 29
 Integration
 Ethernet, 51
 PROFIBUS, 51
 PROFINET, 51
 Interface, 52
 MPI/DP interface, 52
 USB, 71
 Interfaces
 Ethernet, 194
 PROFIBUS/MPI, 21, 194
 PROFINET, 21, 194, 233
 RJ45 Ethernet, 233
 USB, 21, 194
 VGA, 21
 Interfaces assignment on the motherboard
 COM2 (X31), 202
 Internal interfaces, 206
 Interrupt reaction time, 219
 IT communication, 51

K

Key code, 181
 Key panel, 19, 91
 Keyboard
 Features, 231
 Keyboard table, 181

L

labeling, 97
 Function key, 97
 Softkey, 97
 Labeling, 98
 Labeling strips, 20, 97, 98
 Handwritten strips, 98
 Language selection
 Windows 2000, 150
 Windows Vista, 156

Windows XP, 84, 153
 Language selection for Windows 2000 Professional, 84
 Laser printer, 97
 LED, 20, 87
 Operating status, 20
 POWER, 87
 TEMP, 87
 License key, 147, 149
 Lithium battery, 133
 Localized information, 46
 Low-voltage directive, 254
 LVDS
 Ports, 203

M

Maintaining, 106
 Maintenance, 105
 Measuring, 17
 ESD, 17
 Membrane keyboard, 20
 Memory, 194
 Memory addresses
 Assignment, 220
 Memory Cache, 228
 Memory configuration, 118
 Memory expansion, 117
 memory modules
 Removing, 118
 Memory modules
 Installation, 119
 modify., 17
 ESD, 17
 Monitoring
 DiagMonitor, 101
 Safecard On Motherboard, 101
 Watchdog, 103
 Motherboard
 Design, 193
 Internal interfaces, 206
 Location of the interfaces, 195
 Removal, 138
 Mounting
 Modules, 120
 Mounting clamps, 41
 Mouse, 20, 99
 MPI network, 52
 MS Windows, 62
 Multilanguage User Interface, 150

N

- Note, 11, 13, 28
 - General information, 13
 - Installation guidelines, 28
 - Safety information, 11
- Numeric keys, 93

O

- On / Off switch, 89
- Open
 - Device, 116
- Operating, 100
 - Touch panel, 100
- Operating status, 20, 87
- Operating system
 - Updates, 159
 - Windows 2000, 152
 - Windows Vista, 154
 - Windows XP, 152
 - Windows XP Embedded, 157
 - Windows XP Professional, 150
- Operating systems, 22
- Output voltage, 179, 180

P

- Package contents, 26
 - Checking, 26
- Packaging, 26
 - Checking, 26
 - Removing, 26
- Panel Wizard
 - Start screen, 60
 - starting, 59
- Partitioning
 - Hard disks, 151
 - Windows XP Embedded, 157
 - Windows XP Professional, 157
- PCI configuration, 237
- PCI Devices, 238
- PCI Express
 - Connector pin assignment, 213
- PCI hardware interrupt, 219
- Peripheral, 71
- Peripherals, 73, 254
 - Connecting, 73, 254
- Pixel, 15
 - Defective pixel, 15
- Port pin assignments
 - CF card, 201

- COM1, 202
- DVI, 200
- Ethernet, 199
- PROFIBUS/MPI, 197
- USB, 196
- Ports, 195
 - Display, 203
 - Ethernet, 198
 - LVDS, 203
- Power Good Signal, 179, 180
- Power requirements, 178
- Power supply, 21, 45
 - AC supply voltage, 179
 - DC supply voltage, 180
 - WinAC module, 212
- Power supply unit
 - Removing, 135
- Processor, 21
 - Latch, 144
 - Replacement, 143
- PROFIBUS, 51
 - Integration, 51
- PROFIBUS/MPI interface, 21
- PROFIBUS-DP network, 52
- PROFINET, 51
- PROFINET interface, 21
- PROFINET IO application, 52
- Protective foil, 23

R

- Radiation, 12
 - High frequency radiation, 12
- RAID Level 1, 65
- RAID system
 - Creation, 69
 - Management functions, 65
- RAM, 21
- Rating plate, 27
- Recovery
 - Windows Vista, 154
- Recovery DVD, 151, 152
- Recovery functions, 152
- Removing
 - Bus board, 137
 - Drive bay module, 124
 - DVD burner drive, 125
 - Fan, 140, 142
 - Hard disk, 126
 - memory modules, 118
 - Motherboard, 138
 - Power supply, 135

- Processor, 144
- Repairs, 12
 - Tools, 114
- Replacing
 - Battery, 133
- Resistance, 109
- Resistance to chemicals, 108
- Restore DVD, 147, 149
- Restoring factory state, 148
- RJ45 Ethernet, 198, 199

S

- Safecard On Motherboard
 - Temperature monitoring, 101
- Safety information, 11
- SATA Port, 226
- SATA/PATA Configuration, 235
- Scope, 9
- Scope of maintenance, 106
- Screen size, 61, 63
- Seal, 40
- Self-test, 58, 74
- Separating
 - Device, 112
- Shipping, 17
 - ESD, 17
- SIMATIC NET, 52
- SIMATIC S7, 51, 52
 - Integration, 51
- Slide-in labels, 23
- Softkey, 97
 - labeling, 97
- Softkey row, 97
- Software, 14
- SOM, 87, 101
- Spare parts, 110
- Special codes, 165
- Stainless steel front, 107
 - Cleaning, 107
 - Degree of protection, 31
 - Installation information, 29
 - Type of fixation, 31
- Stainless steel surface, 109
- Standard, 9
- Start screen
 - Panel Wizard, 60
- Status display, 87, 88
- Summary Screen, 230
- Supply voltage, 46, 171
- Switching on, 73
 - Device, 73

- System parameters, 243
- System partition, 147, 149
- System resources, 214

T

- Temperature error, 169
- Temperature monitoring, 103
- Temperature threshold, 87
- TFT technology, 20
- Tools
 - Repairs, 114
- Touch controller, 61
- Touch panel, 19, 100
 - Operating, 100
- Trademark, 10
- Transport, 13
- Troubleshooting, 169
- Type of fixation, 30

U

- Update, 14
- Updates
 - Operating system, 159
 - User programs and drives, 160
- USB, 71
- USB interface, 20, 21, 99
- USB mouse, 99
- USB peripheral, 71

V

- VGA interface, 21
- Virus protection, 78

W

- Warranty, 12
- Watchdog
 - Monitoring function, 103
 - Monitoring times, 104
- WinAC module
 - Power supply connection, 212
- Windows 2000
 - Partitioning the hard disk, 152
- Windows Security Center, 58
- Windows Vista
 - Recovery, 154
- Windows XP
 - Language selection, 84, 153

Partitioning the hard disk, 152
Windows XP Embedded
 Partitioning the hard disk, 157
 Reinstalling the Operating System, 147
Windows XP Professional

Partitioning the hard disk, 157
Reinstalling the operating system, 148