

**SIEMENS**

# **SINUMERIK System 8**

**Freely programmable cycles  
Programming instructions**

## SINUMERIK R - Documentation

## KEY TO EDITIONS

Up to the present edition, the editions below have been issued

In the column "Alterations," the chapters are listed which have been altered with respect to the preceeding edition.

<u>Edition</u>	<u>Order number</u>	<u>Alterations</u>
A.02.81	E321/1780	
A.11.81	E321/1887-101	Revised edition
A.10.82	E321/1887-101	P.0-4, 3-33, 3-34, 3-35, 4-1, 4-2, 5-2, chapt. 6
A.04.83	E321/2022-101	Revised edition
A.12.83	E80210-T73-X-A5-7600	P.0-2, 0-5, 2-2, 2-3, 2-9, 2-10, 3-27, 3-28, 3-34, 6-77

<u>Contents</u>		Page
0.0	Overview of "@" and "&" functions	0 - 4
0.1	Introduction	0 - 5
1.1	Unconditional jump @ 00	1 - 1
1.2	Conditional jumps @ 01, @ 02, @ 03	1 - 3
1.2.1	Summary example of conditional and unconditional jumps	1 - 5
2.1	Square root @ 10	2 - 1
2.2	Sine @ 15	2 - 2
2.3	Arcustangens 18	2 - 3
2.3.1	Summary example covering chapters 1.1 and 1.2	2 - 4
3.1	Load address parameters @ 20	3 - 1
3.1.1	Application example 1	3 - 3
3.1.2	Application example 2	3 - 4
3.2	Reference preparation @ 21	3 - 5
3.3	Intersection point calculation	3 - 10
3.3.1	Summary example covering chapters 3.2 and 3.3 for Stock Removal Cycle L 95	3 - 13
3.3.2	Stock Removal cycle program	3 - 18
3.4	Tool change @ 23	3 - 23
3.4.1	L 91 Tool change cycle example	3 - 24
3.4.2	Tool change cycle program	3 - 26
3.5	Load position value @ 24	3 - 28
3.5.1	Load position example - Determining tool lengths	3 - 30
3.6	Start conditions for cycles @ 25	3 - 32
3.7	Load/Read system stores @ 29	3 - 33
4.1	Clear buffer @ 31	4 - 1
4.2	Reference to machine actual value system @ 30	4 - 3
5.1	Address, parameters @ 90 - @ 99	5 - 1
5.2	Operator's Aids &	5 - 2

6.0	Appendix	6 - 1
6.1	Cycles 8T/Sprint 8T	6 - 1
6.2	Drilling cycles 8M/8MC/Sprint 8M	6 - 16
6.3	Drilling and milling patterns Sprint 8M	6 - 37
6.4	Drilling and milling patterns 8M/8MC	6 - 53
6.5	Address codes for the address parameters	6 - 69
6.6	Figure for stock removal cycle on page 3.3.1	6 - 70
6.7	Figure for stock removal cycle on page 3.3.2	6 - 71
6.8	Defined R parameters	6 - 72
6.9	Overview of store access (Values)	6 - 73
6.9.1	SINUMERIK 8T/Sprint 8T	6 - 73
6.9.2	SINUMERIK Sprint 8M	6 - 74
6.9.3	SINUMERIK 8M/8MC	6 - 75
6.9.4	SINUMERIK 8N	6 - 76

The controls are capable of their respective functions as described.

This does not imply that the functions were fitted at delivery or if they are available for service use.

We reserve the right to amend or change this publication.

0.0 Overview of "@" and "&" functions

Function	BT	Sprint BT	BM	Sprint BM	BMC	BN	Chapter
@ 00 Unconditional jump	(X)	X	(X)	X	X	X	1.1
@ 01 Conditional jump - equals	(X)	X	(X)	X	X	X	1.2
@ 02 Conditional jump - larger	(X)	X	(X)	X	X	X	1.2
@ 03 Conditional jump - larger/equal	(X)	X	(X)	X	X	X	1.2
@ 10 Square root	(X)	X	(X)	X	X	X	2.1
@ 15 Sine	(X)	X	(X)	X	X	X	2.2
@ 18 Arcustangens *							2.3
@ 20 Load address parameter	(X)	X	(X)	X	X	X	3.1
@ 21 Reference preparation	(X)	X	-	-	-	-	3.2
@ 22 Cutter point calculation	(X)	X	-	-	-	-	3.2
@ 23 Tool change	(X)	X	-	-	-	-	3.4
@ 24 Load actual value	(X)	X	(X)	X	X	X	3.5
@ 25 Start conditions for cycles	(X)	X	(X)	X	X	X	3.6
@ 29 Read/Load System stores	(X)	X	(X)	X	X	X	3.7
@ 30 Reference to machine actual value	(X)	X	(X)	X	X	X	4.2
@ 31 Clear buffer	(X)	X	(X)	X	X	-	4.1
@ 90 Address parameter	(X)	X	(X)	X	X	X	5.1
@ 91 Address parameter	(X)	X	(X)	X	X	X	5.1
@ 92 Address parameter	(X)	X	(X)	X	X	X	5.1
@ 93 Address parameter	(X)	X	(X)	X	X	X	5.1
@ 94 Address parameter	(X)	X	(X)	X	X	X	5.1
@ 95 Address parameter	(X)	X	(X)	X	X	X	5.1
@ 96 Address parameter	(X)	X	(X)	X	X	X	5.1
@ 97 Address parameter	(X)	X	(X)	X	X	X	5.1
@ 98 Address parameter	(X)	X	(X)	X	X	X	5.1
@ 99 Address parameter	(X)	X	(X)	X	X	X	5.1
& Operator Aids	(X)	(X)	(X)	(X)	(X)	(X)	5.2

X Available

(X) Available, but cannot be entered from the operator's panel

\* From Software 02 onwards

## 0.1 Introduction

This description covers all System 8 controls. The System 8 cycles are not part of the hardware but stored in the control's program memory. In order to realise the powerful System 8 cycles, it was necessary to develop a number of functions which were developed on from System 7. These functions are called up with the @ address. The purpose of this description is to describe and clarify the functions with examples, thus enabling the customer to program machine and technologically orientated cycles.

In order to understand this description a study of the programming manual 8T/Sprint 8T or 8M/Sprint 8M/8MC or 8N is a pre-requisite.

### Parameter Chaining

Calculation Type	Programmed Calculation	Argument	Result found in
Addition	R01 R02	R01+R02	R01
Subtraction	R01-R02	R01-R02	R01
Multiplication	R01.R02	R01.R02	R01
Division	R01/R02	R01:R02	R01
Definition + Addition	R01 10 R02	R01 +10	R01
Definition - Subtraction	R01-10-R02	R01-10	R01
		R01-R02	R01

**Note:**

Each chain operation must be programmed as a separate block.

General

Programmed parameter chaining and programmed @ functions initiate calculation times which can be up to 10 ms per link. It is therefore necessary to ensure that the calculations be programmed approximately 10 blocks before required. If e.g. a move is executed at a suitable speed, the control can be allowed sufficient time to complete the next 10 calculations. The signal "cycles lock" also enables faster calculations (see chapter 2.2.1 section g).

In conjunction with an @ program definition, it is often necessary to transfer a parameter via the interface. See 3.5.1 (Loading the position value).

R parameter range:

a) Programmable and displayable range

Largest value:  $\pm 99999999.$

Smallest value:  $\pm .00000001$

1.1 @ 00 "Unconditional jump"

Application: With a conditional (absolute) jump, it is possible to jump over parts of a program. The jumped blocks are not executed.

Example: See 1.2.1; 2.2.1

Programming: @ 00

±

1234

Command: Unconditional jump

The jump target precedes (-) or follows (+) the jump command. The control searches for the jump target in the defined direction.

Block number of the jump target max. 4 decades

For a special case, an R parameter and its sign can be added in order to generate different jump targets. This special case is shown on the right hand side of the following figures.



The jump target precedes the jump command (-)

Normal case

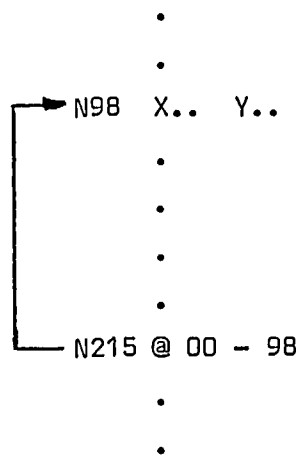

Special case

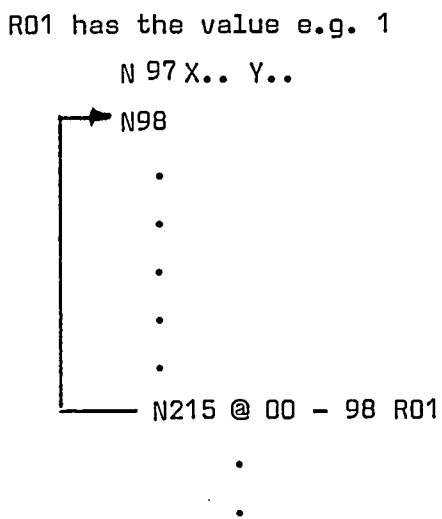

The jump target follows the jump command (+)

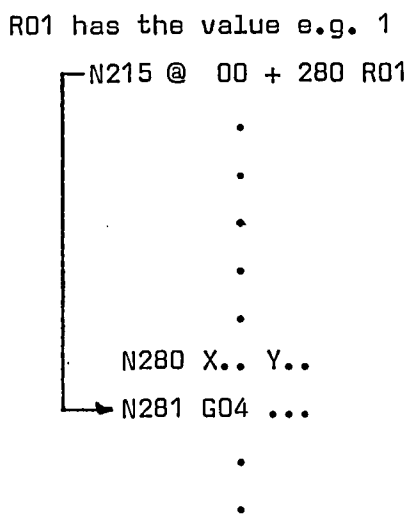
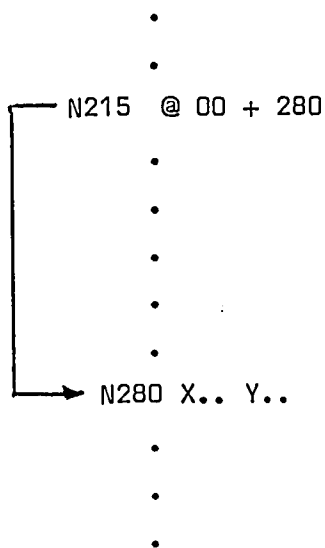

Note: Jump targets must always be blocks with block numbers. This also applies when the jump target is changed by an R parameter.

A jump requires time (max 10 msec per jumped block)

1.2 @ 01, @ 02, @ 03 "Conditional jump"

Application: The conditional jumps permit program branching dependent upon the condition:

- equal to @ 01
- larger than @ 02
- larger than or equal to @ 03

Example: See 1.2.1; 2.2.1

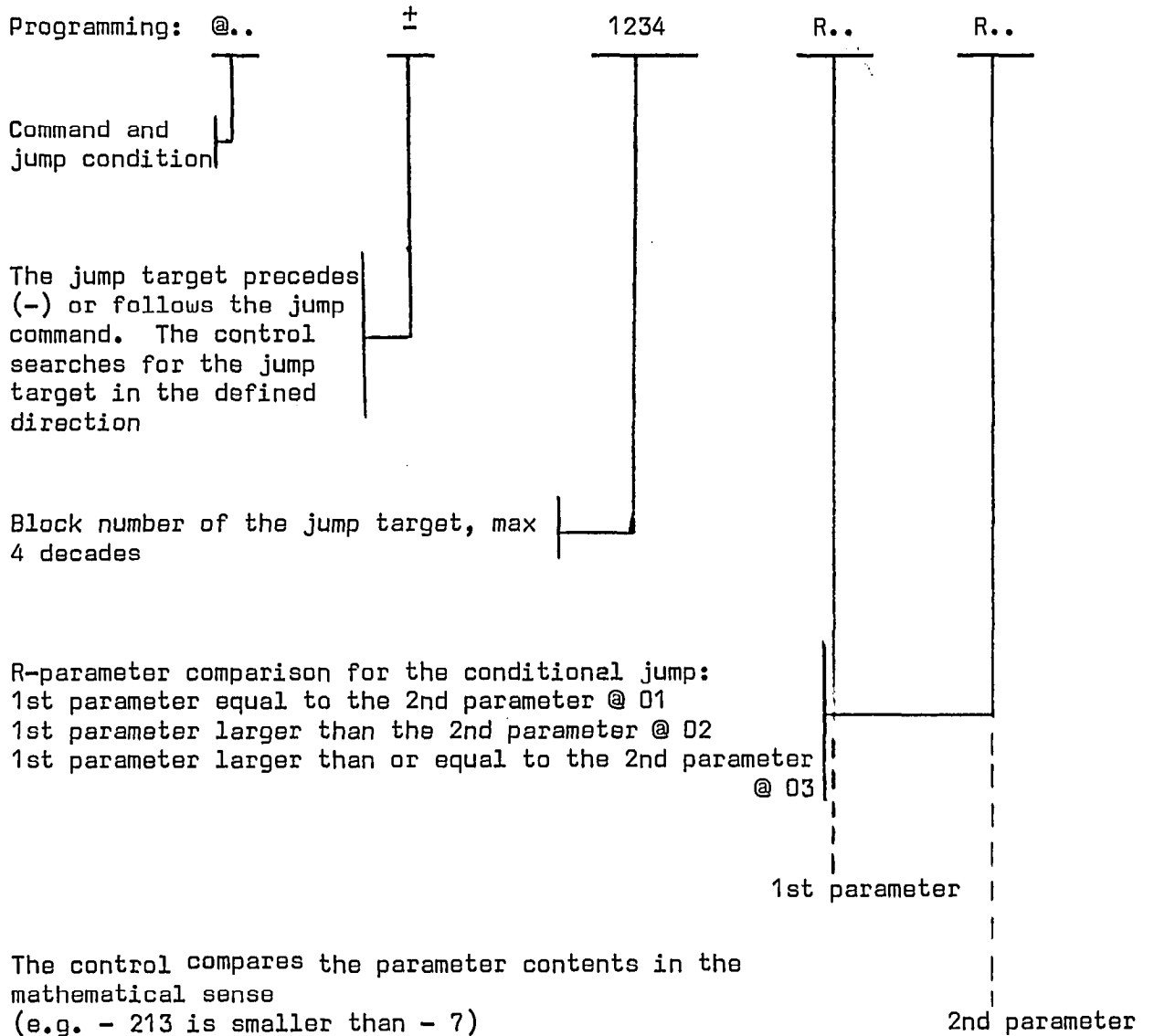



Note: Jump targets must always be blocks with a block number. This also applies when the jump target is changed by an R parameter.

A jump requires time. (max 10 msec per jumped block)

### 1.2.1 Summary example of conditional and unconditional jumps

Task definition: Within a program there must be a branch to another program

Flow chart:

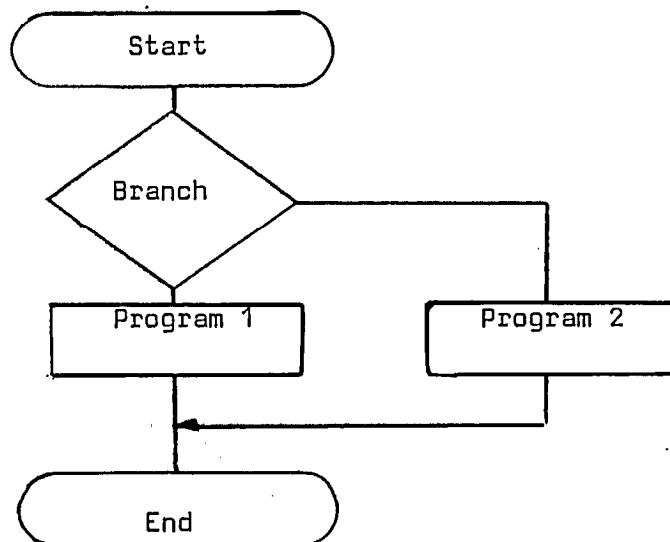

Programming

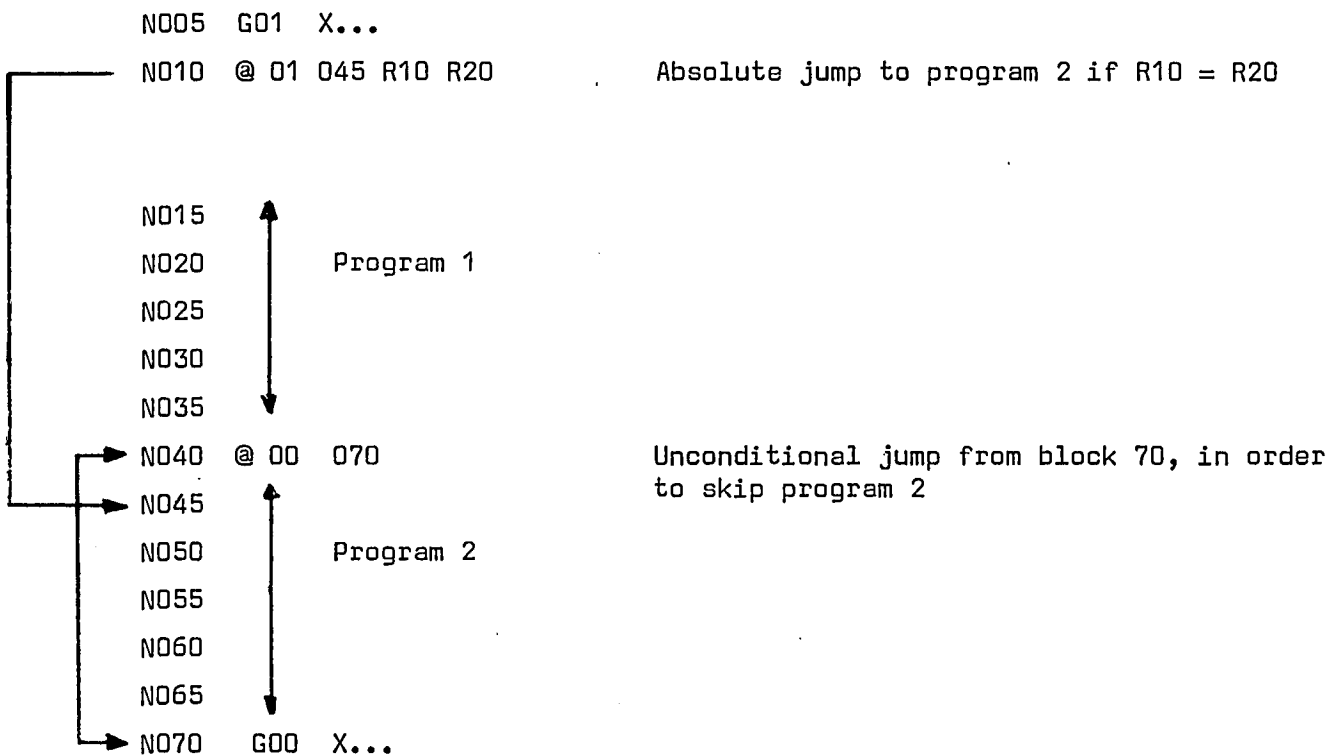

2.1 @ 10 "Square root"

Application: Square root extraction

Example: See programming

Programming

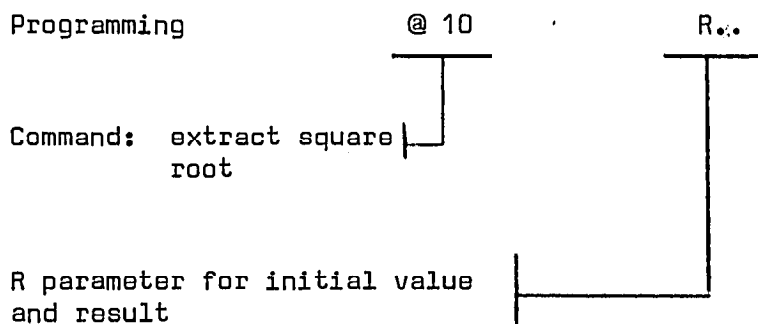

Example:

N10 R10 25

.  
.  
.

N75 @ 10 R10 Extract the root from the value in R10

N80 . From the next program block (as shown N80) the R10  
 contents are 50  
 .

Note:

- Only define positive values
- The largest value is 99999999.
- The smallest value is .00000001

2.2 @ 15 "Sine"

Application: Calculating the sine of an angle

Example: see 2.2.1

Programming

@ 15

R..

Command: calculate Sine

R parameter for initial value and result

Example:

```

N10  R17  45           R17 loaded with 45
      .
      .
      .
N75  @ 15 R17         Calculate the sine of the value in R17
N80  .               From the next program block (as shown N80), the R17
                        contents are .7071067
      .
      .

```

Note:

- Positive and negative values are allowed
- The largest value is +359.99999
- The smallest value is -359.99999

2.3 @18 Arcustangens (available from Software 02 onwards)

Application: Calculation of angle with the help of an arcustangens function

Programming: @18 R ...

Command: Arcustangens

First R-parameter for defined value b and result

Following R-parameter for defined value a

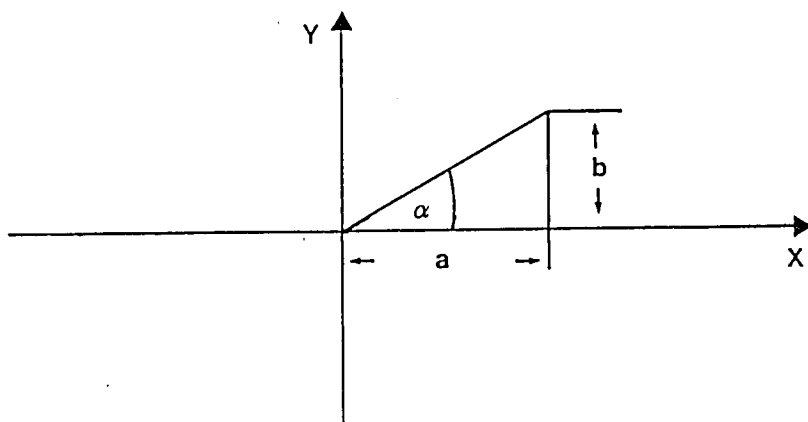
**Example:**

```

N10 R10 20      R10 loaded with 20 (b)
N15 R11 30      R11 loaded with 30 (a)
N20 18 R10      Calculation of arcustangens
R10 = + 33,69007°   $\frac{R10}{R11} \rightarrow R10$ 

```

Result found in R10

**Note:**

Parameter R99 is not allowed



### 2.3.1 Summary example for Chapters 1.1 - Chapter 2.2

In conjunction with the drilling pattern figure below, the approach of defining a cycle is outlined below

a) Task definition:

Around a programmed middle point and radius value, holes should not be symmetrically drilled. The number of holes required must also be defined.

b) Establishing the necessary parameters (Programming)

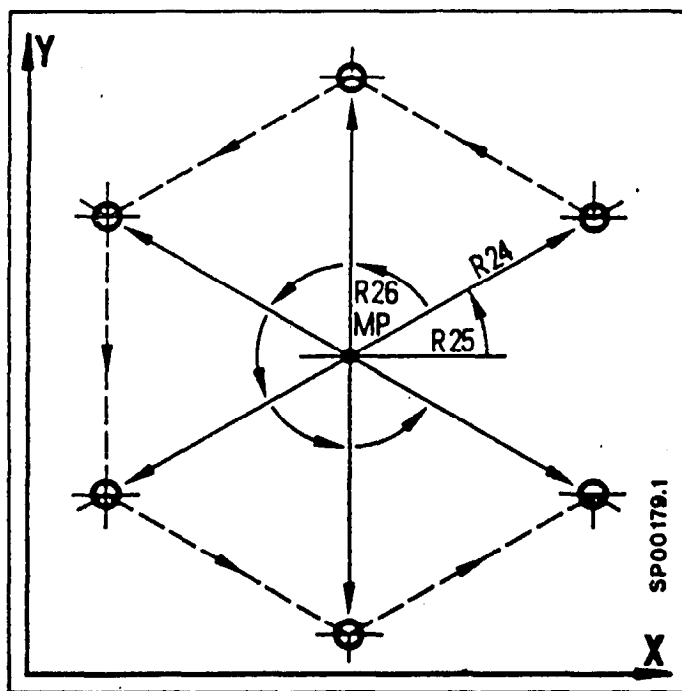

R22, R23	MP, middle point of the drilling pattern
R24	Radius
R25	Starting angle (when changed this causes the hole pattern to rotate)
R26	Pitch angle. If the pitch angle is defined as 0, the number of holes dictate the pitch angle
R27	Number of holes
R28	Drilling cycle number ( <u>G81</u> - <u>G89</u> )

c) Which functions are necessary ?

Pitch angle = 0 → calculate the  
Pitch angle

- Calculated X co-ordinate .

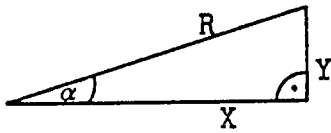

$$X = \cos \text{Alpha} \cdot R$$

$$\cos \text{Alpha} = \text{sine} (\text{Alpha} + 90^\circ)$$

- Calculate Y co-ordinate .

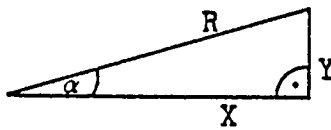

$$Y = \text{sine} \text{Alpha} \cdot R$$

- Logical decisions .

- Counter and reference to the absolute system .

A listing of these functions shows that the middle point task can be omitted.

Function .
Division
Sine Multiplication
Sine Multiplication
Conditional Jumps
Addition

d) Define a flow chart

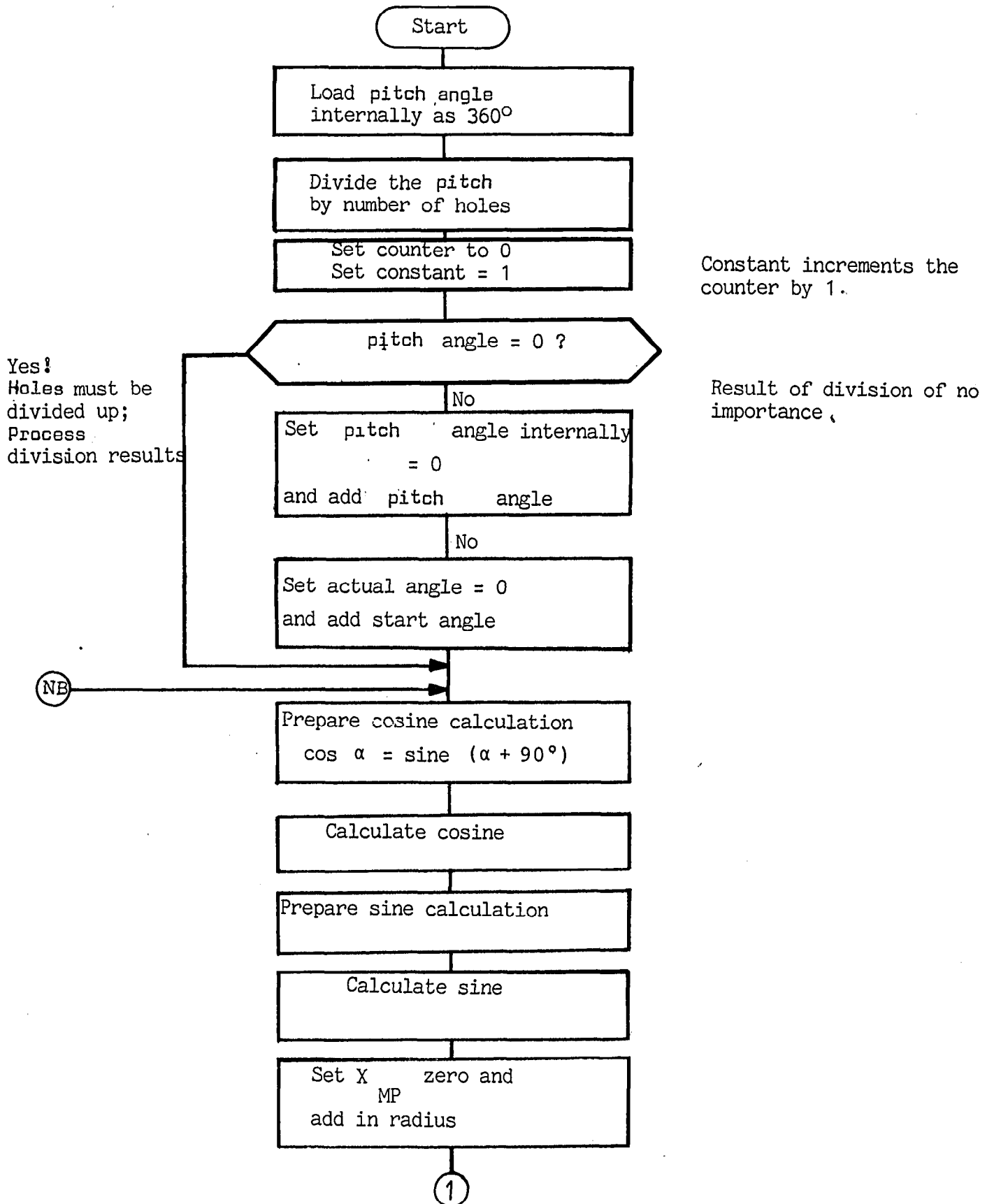

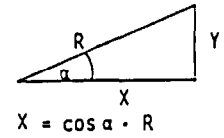
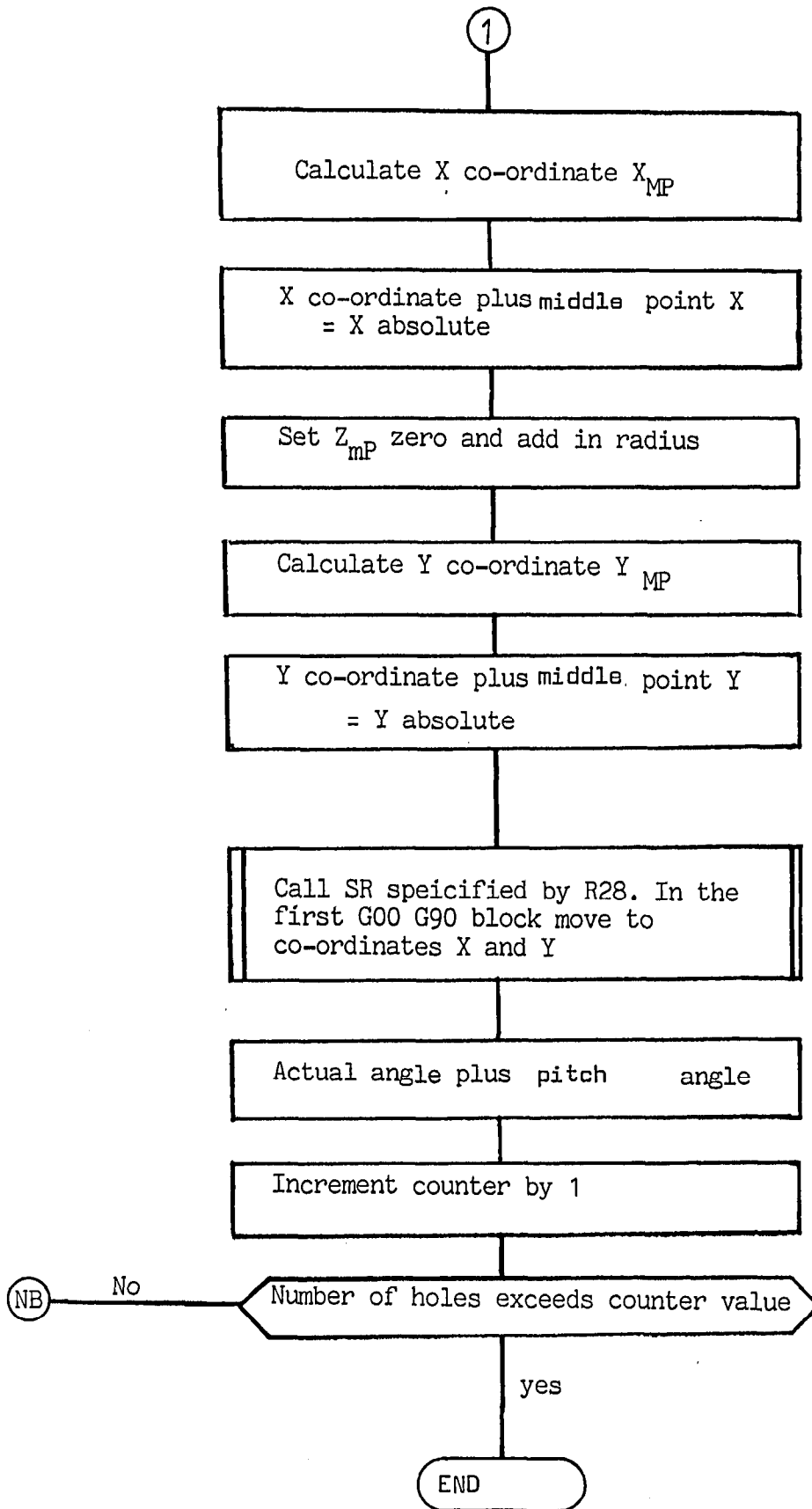

$Y = \sin \cdot R$

## e) Defining internal parameters

The parameters R50 - R99 are employed because they can be disabled to the NC display by the signal "Cycles disable" to the interface. (See Chapter 2.2.1 section g.)

Internal parameters are sometimes necessary for intermediate calculations. The fixed program parameters should not be changed during a cycle because the values are often repetitively transferred to internal parameters.

For the drilling pattern example, the internal parameters are used as follows:

R50	Internal pitch angle
R51	Actual angle
R52	Counter
R53	= 1.
R54	$\cos (R51)$ .
R55	$\sin (R51)$ .
R56	$X_{MP}$ (absolute) middle point
R57	$Y_{MP}$ (absolute) middle point

## f) Programming

L...	-	SR number for cycle call
N1 R50 360	-	Internal pitch angle definition = $360^\circ$
N2 R50/R27	-	Internal pitch angle divided by the number of holes
N3 R52 0 R53 1	-	Counter set 0 : Load constant 1
N4 @ 01 6 R26 R52	-	Jump to N6 if pitch = 0
N5 R50 0 + R26	-	Load pitch angle into R50
N6 R51 0 + R25	-	Load start angle into R51 ( $\alpha$ )
N7 R54 90 + R51	-	Start angle + $90^\circ = \alpha^1$
N8 @ 15 R54	-	Find sine of $\alpha^1$
N9 R55 0 + R51	-	Load start angle $\alpha$
N10 @ 15 R55	-	Find sine $\alpha$
N11 R56 0 + R24	-	Load radius into R56
N12 R56 . R54	-	$X^1 = \cos \alpha .R$
N13 R56 + R22	-	$X^1 + Xmp = X$
N14 R57 0 + R24	-	Load radius into R57
N15 R57 . R55	-	$Y^1 = \text{Sine } \alpha .R$
N16 R57 + R23	-	$Y^1 + Ymp = Y$
N17 LR28	-	Call SR defined by R28
N18 R51 + R50		
N19 R52 + R53	-	Increment counter + 1
N20 @ 02-7 R27 R52	-	Is counter value smaller than the number of holes? jump to N7
N21 M17	-	End of cycle

This cycle is also shown on page 6 - 60 using polar co-ordinate programming.

## g) Test

Before issuing a sub-routine, e.g. as above, the programmer must test it. For this purpose it is advisable to remove the "Disable cycles" signal (0 signal) from the interface, thus permitting single block operation. The results of the R parameter calculation can be checked on the NC display.

When the cycle functions correctly, the "Disable Cycle" signal can be re-applied (1-signal). This signal also stops the cycles (i.e. the SR's) numbered L80 - L99 and L900 - L999 being changed, punched out or displayed. Further, the three types of operation shown below will be executed much faster by:

- 1) Changing, chaining or defining parameters with an R number  $\geq 50$
- 2) Programming no additional functions in the same program block
- 3) Making the interface signal "Disable cycles" active (1 signal)

The variable values of the R parameters R50 - R99 are not displayed in the "Automatic" mode

In the preceding example blocks N1, N2, N3, N5 to N16, N18 and N19 are executed much faster.

### 3.1 @ 20 "Load address parameters"

Application: Many applications require not only variable count values but also variable addressing. An example is that of a boring cycle which is normally completed with the Z axis as the boring axis. Variable addressing permits execution of the boring cycle with another axis.

As it may be necessary to switch other axes in a similar fashion, in addition to the values (R00 - R99) the address parameters @ 90 - @ 99 are available. @ 20 instructs the control to load an address parameter.

Example: see 3.1.1; 3.1.2.



Programming:

- a) Address parameters @ 90 - @ 99 load directly the address code of an axis (Machine parameter)

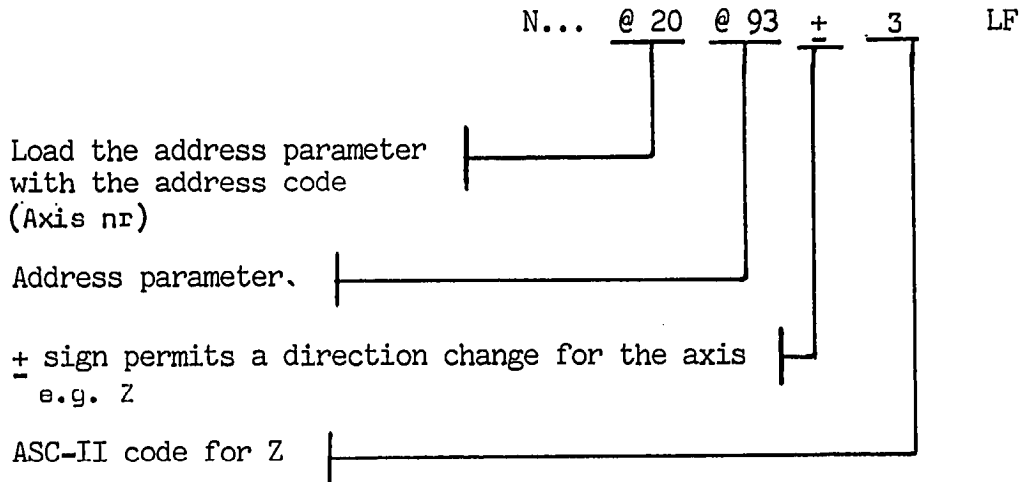

- b) Address parameters @ 90 - @ 99 loaded indirectly to an address as an R parameter

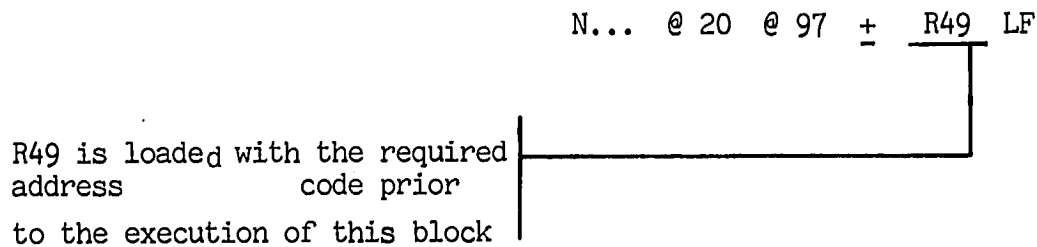

The address parameters ( @ 90 - @ 99) are related to an axis which is detailed in the machine parameter/address/ and address code listings in the appendix. The axis sign can be changed as necessary (multiplicative working).

### 3.1.1 Application example 1

The normal L81 cycles should as required, be applied to any boring cycle

Sub-routine L81 (Drilling, Centering)

Define the following parameters:

R02 Reference plane, return plane

R03 Drill depth

Respective sub-routine

(R81 cycle) with Z axis  
as the boring axis

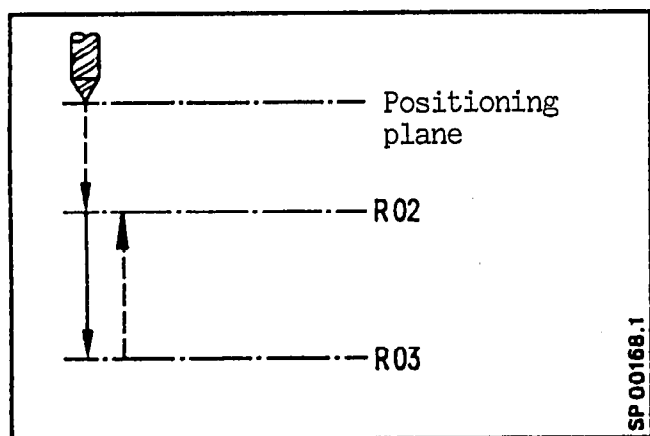

L8100

N1 G00 G60 G90 Z R02

N2 G01 Z R03

N3 G00 Z R02

M17

R11 is defined for the definition of the boring axis. The R11 input as an address code defines the required axis (see appendix).

R 11 3  $\Delta$  Z axis

R 11 2  $\Delta$  Y axis

R 11 1  $\Delta$  X axis

The changed L81 sub-routine cycle is as follows:

L8100

N1 @20 @ 99 R11

N2 G00 G60 G90 @ 99 R02

N3 G01 @ 99 R03

N4 G00 @ 99 R02

M17

Defined addressing via R11

Address parameter @ 99 instead of Z axis

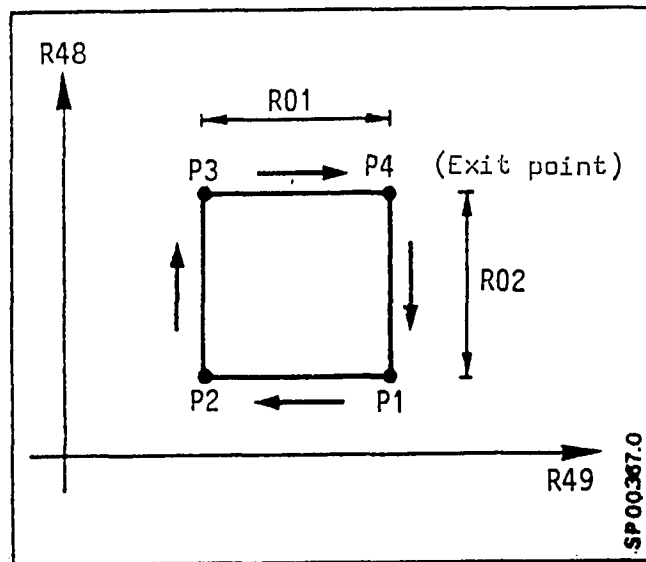
3.1.2 Application example 2

The outlined program should apply in all planes. The side lengths should be entered into parameters R01 and R02 and the axes defined under parameters R48, R49. The start point for the subsequent program is point P4.

L557

SR number

N0 @ 20 @ 90 R48

Defined address R48/@ 90

N5 @ 20 @ 91 R49

Defined address R49/@ 91

N10 G91 @ 90-R02

P1

N15 @ 91-R01

P2

N20 @ 91 R02

P3

N25 @ 91 R01

P4

N30 M17

### 3.2 @ 21 "Reference preparation"

**Application:** Reference preparation is a special function to enable stock removal cycles (Sprint 8T). For stock removal cycles, the contour is defined in a sub-routine. This allows the contour to be programmed with all the control options (brief description of the contour, radius programming).

As the stock removal cycle is programmed as a "normal sub-routine", all block information is required in R parameter form. The reference preparation divides up the programmed contour blocks. This data is then defined in R parameters.

**Example:** See 3.3.1

Programming: N... @ 21 --(in a block on its own)

Command: Prepare reference

@ 21 is always programmed when a new intersection value must be calculated in conjunction with @ 22. This case applies whenever a new contour element is encountered in the order of execution.

### Example

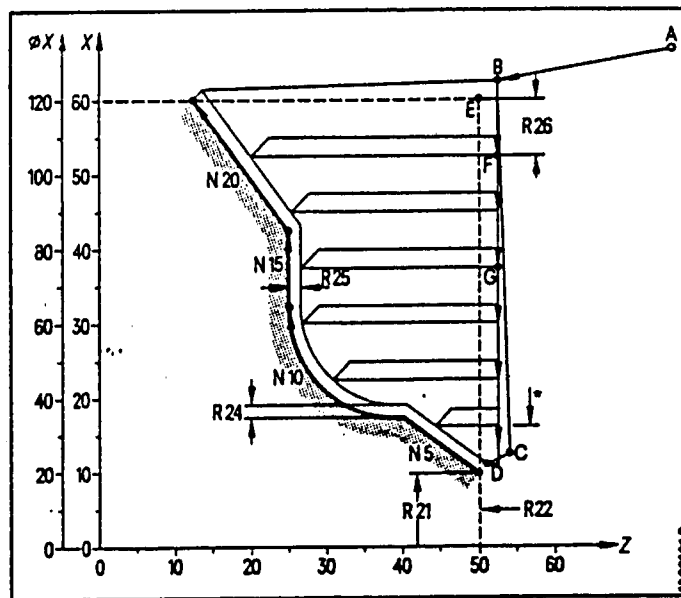

The contour is programmed in L50, as follows:

```
L5000
N5 G90 G01 X35 Z40
N10 G02 X65 Z25 I15 K0
N15 G01 X85
N20 X120 Z15 M17
```

A call of the stock removal cycle (L95) informs the control that

R20 50	is the number of the SR.
R21 20	is the X start point
R22 50	is the Z start point



The table shows how the @21 function parameters the L50 sub-routine blocks. The intersection point calculation @ 22 checks whether an intersect point has been reached. When this is not so, the next block is re-defined. In the example, on the 4th iteration, an intersect is found. This point ① (possibly compensated) is approached, then backed off, at  $45^\circ$ , by 1 mm for safety, followed finally by a rapid traverse move to position ③. Following a move to the roughing depth R26, plus the back off allowance ⑤, (1 mm) the intersection point function @22 is recalled.

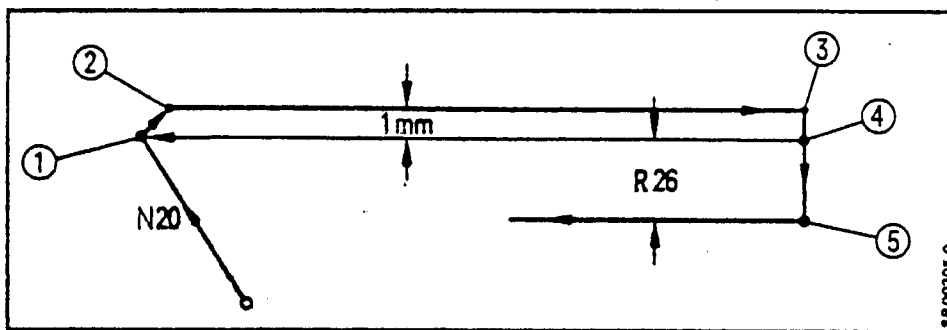

R26 Roughing Depth advance

This sequence is repeated until the roughing cut advance depth cannot be found in block N20. @ 21 now divides up the next block; this is M17. The control parameter R88 is set to 1. It is checked logically to see if the stock removal cycle has finished. This is not the case. Once again the first sub-routine block is divided up by @ 21. Again a check for an intersection point is made. This is not the case in block N5. The control parameter R88 is set to 0. At block N15 the first new intersection point is found etc.

Please note: Before calling @ 21, the control parameter R88 must be set 1. This ensures that the first sub-routine block is parametered.

Other input parameters are:

R20 Sub-routine number .  
R21 Contour start point (X absolute value)  
R22 Contour start point (Y absolute value)

These parameters are set automatically when @ 21 is used in the stock removal cycle. R 20 and R 22 are not to be changed during the cycle.



### 3.3 @ 22 "Intersection Point Calculation"

**Application:** The intersection point calculation is a special function to enable stock removal cycles (Sprint 8T). @ 22, intersection point calculation, works in conjunction with @ 21, reference preparation. Chapter 3.2 shows how the preparation block is parametered (R81 - R87). The intersection point calculation now calculates the intersection point between a reference block (defined in R81 - R87) and the block following the programmed @22. The results are defined in the R parameters (R91, R92).

**Example:** See chapter 3.3.1

Programming:	N..	<u>@ 22</u>	G..	<u>X..</u>	<u>Z...</u>	<u>(I... K...)</u>
Command: Intersection point calculation.						
G function (00, 01, 02, 03),						
Axis command.						
Interpolation parameter.						

Program sequence (see also the reference calculation programming (@ 21):

The reference calculation @ 21 parameters block N15.

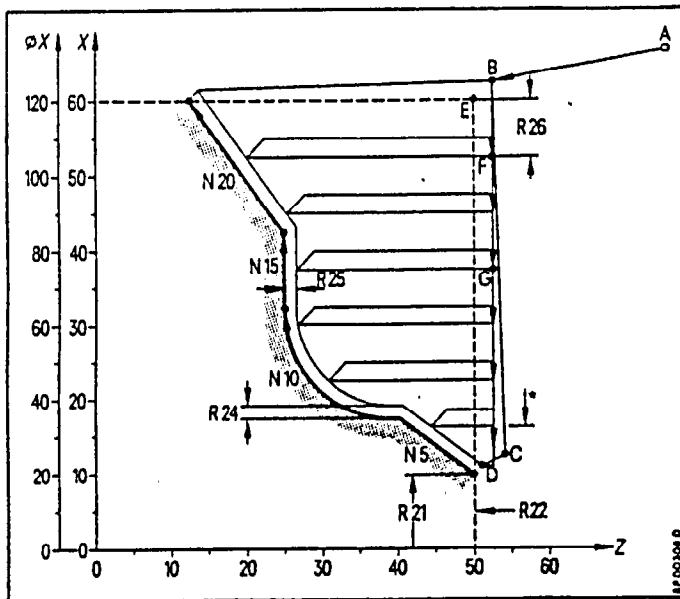

R81 65 (X axis block start point)  
 R82 25 (Z axis block start point)  
 R83 85 (X end point)  
 R84 25 (Z end point)  
 R85 - (Interpolation parameters I)  
 R86 - (Interpolation parameters K)  
 R87 1 (G function)

The calculated values are corrected in X and Z to allow for the final pass.

The intersection point calculation is called from the program.

@ 22 G01 G90 Z-99999      The tool tip intersection point is now point G in this example.

The intersection point is defined in:

R90 1      -      1 means the intersection point is found (0-not found)  
 R91 75      -      X intersection point  
 R92 26      -      Z intersection point

This point can only be approached in a G01 block.

Please note:

A straight line is defined by two points. In an @ 22 call, only one point is programmed. The second point is automatically given as the end point of the last positioning move. In this example, therefore, by the advance path of the roughing cut, R26 and the 1 mm back off distance.

### 3.3.1 Stock Removal Example covering points 3.2 and 3.3

#### "Stock Removal cycle L95"

The stock removal cycle is written as a sub-routine in NC language. DIN 66025 specifies parameter chaining commands and special commands. The special functions are used, the reference preparation function @ 21 and intersection point calculation function @ 22.

Below, the example clarifies a stock removal cycle "Outside contour turning" with one parallel contour finish pass. In order to ease the understanding, all non-pertinent program parts concerning this stock removal cycle are ignored.

Parameter definition - "Technology"

R20	50	Sub-routine L50 defines the finish contour.
R21	20	X contour start point (absolute)
R22	50	Z contour start point (absolute)
R24	1	X finishing depth of cut (1 mm)
R25	1	Z finishing depth of cut (1 mm)
R26	15	X roughing depth of cut (15 mm)
R27	40	Cancels C.R.C. (40 $\hat{=}$ no C.R.C.)
R29	31	Form determination for roughing and finishing (Outside contour roughing, turning with one parallel finish pass)

Warning: See pull-out drawing chapter 6.6!

Contour sub-routine -"Geometry"

L5000

N5 G90 G01 X35 Z40

N10 G02 X65 Z25 I15 K0

N15 G01 X85

N20 X120 Z15 M17

Description of the necessary calculations:

There follows a description of all the necessary calculations.  
Chapter 3.3.2 shows and clarifies the program. The program  
jumps for this example are indicated by broken lines.

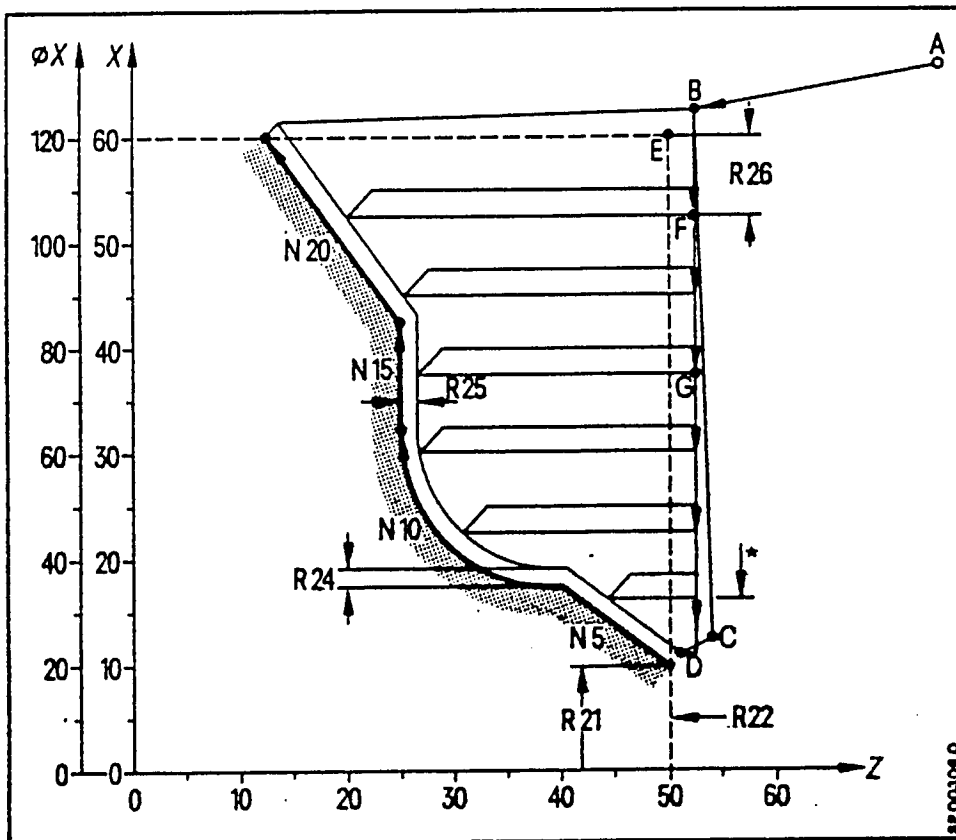

- Considerations for diameter programming

At commissioning the control is set up for diameter programming in the X axis. As all axis moves within the stock removal cycle are programmed as absolute dimensions, it is necessary to calculate some data. For this purpose @ 25 Start preparation for cycles (see chapter 3.6) is called up. Parameter R79 is set to 2. (for diameter programming).

The following parameters must be calculated:

- R24            X axis finishing depth of cut
- R26            X axis roughing depth of cut

R78 is another parameter into which a counter value is loaded, relating to the selected input format of the 1 mm back off distance. This value must always be taken into consideration.

- Calculating point B

In order to calculate point B in our example, the start point for the advance of the roughing cut, the Z start point (R22) and the X contour end point are necessary. The X contour end point is obtained from the reference preparation function @ 21. This is called up in a program loop, until the Control parameter is 1. In this case R83 contains the end point of the last block (See also @25 reference preparation). This results in the axis contour start point and the X axis contour end point being incremented by the back off distance with sign. On the drawing, the back off distance has been increased from 1 mm to 5 mm for clarity. A rapid traverse move is made to the calculated absolute position.

- Calculation for the material to be removed

The calculation for the material to be removed is the X axis start point,  
minus the X axis contour end point,  
plus the finishing allowance  
times (-1)

The calculated value is corrected following every roughing cut advance. Before a new roughing advance, half of the calculated value is compared to the roughing advance depth. If the value is smaller than the roughing advance depth, the last advance results with this calculated value. This case is indicated by an asterisk.

- Calculating the roughing advance

The advance depth is added to an aid parameter (R61) after every advance. This incremented distance is added to the X contour end point such that this becomes the new absolute advance distance. The last advance is half the roughing depth (see Calculating the material to be removed).

- Calculating the contour intersection points

The intersection points are found by the @ 22 function (intersection point calculation). In doing so, the reference calculation @ 21 defines a block. This block corrects the X and Z start and end points by the allowance. The second straight which follows the programmed @ 22 intersection point calculation is parallel to Z axis with a maximum Z axis travel distance. (The path length is = R64 = 99999.) The X value represents the last roughing advance. If an intersection point is found (R90 = 1), a move results in G01. Next, X and Z retract by the back off distance (45<sup>0</sup>). A parallel rapid traverse Z axis move ends the cycle. The next roughing advance can now be executed.

If no contour intersection point is found, the reference calculation is recalled until an intersection point is found.

- Calculating point E

Following roughing, point E is approached.

This is calculated from the co-ordinates of point B (R56, R57) less the back off distance.

- Calculating point C

For the roughing part of the clearance cycle point C is approached at rapid traverse. This is calculated from the X and Z contour start points plus the finishing allowance and back off distance.



L9500 Stock removal cycle

N1 @ 25 Result R78 Count value = 1 mm  
R79 2 = Diameter

R73 40 Load constant 40 into R73

@ 03 36 R73 R27 40 larger/equal R27(41,42)

R73 0 R27 R73 contains e.g. 41, 42, 46

N36 R50 0 R21 Load X contour start point into R50

R51 0 R22 Load Z contour start point into R51

R60 0 R26 Load Roughing depth into R60

R64 1 R88 1 Load constant 1 into R64 and R88

R60 . R79 Multiply Roughing depth by 2 = rough X

R74 0 R26 Load Roughing depth into R74

R74 . R79 Multiply Roughing depth by 2 = rough X

N2 @ 21 Reference calculation is repeated

@ 02-2 R64 R88 until M17 and R88 = 1

} Roughing  
Calculation  
Reference calculation,  
Calculating point B

R64 10 Load constant 10 into R64

R65 R29 Load cycle type (R29) into R65

N3 R65-R64 With R29 31 result equals 21

@ 02-3 R65 R64 Is R65 larger than R64 (1 larger than 10)?

R64 2 Load constant 2 into R64

@ 02 6 R65 R64 Is R65 larger than R64 (1 larger than 2)?

R62-1 Load constant -1 into R62

@ 02 7 R50 R83 Is X contour start point larger than X contour end point?

N4 R52 0 R83 Load X contour end point into R52

R53 0 R51 Load Z contour start point into R53

R68 0 R50 Load X contour start point into R68

R69 0 R84 Load Z contour end point into R69

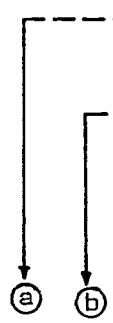

Results in different cycle call.

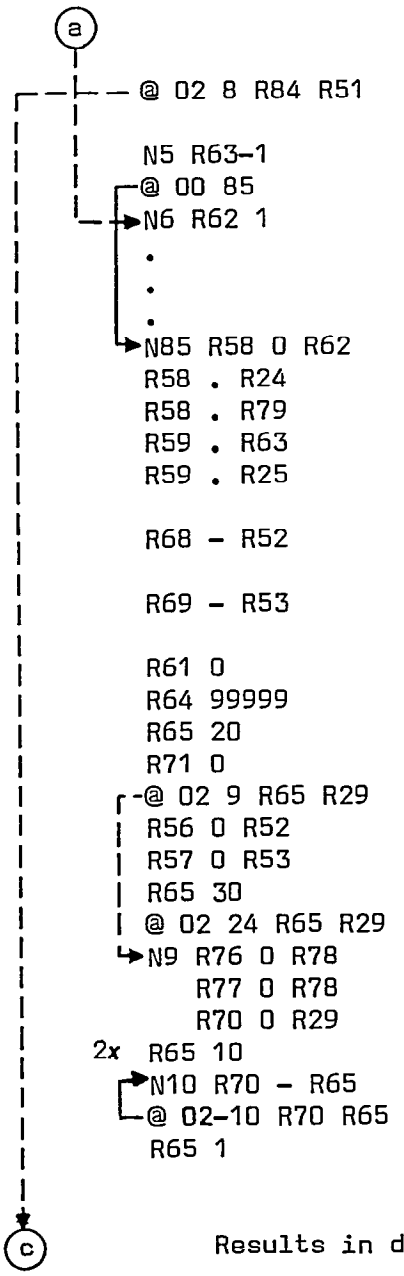

Is Z contour end point larger than  
Z contour start point?  
Load constant -1 into R63  
Jump to N85 (absolute)

Load constant -1 into R58 with R62  
Roughing depth X. (-1)  
(-Roughing depth X) .2  
Load constant -1 into R59 with R62  
Roughing depth Z . (-1)  
= (- Roughing depth Z)  
X contour start point minus  
X contour end point  
Z contour end point minus  
Z contour start point  
Load constant 0 into R61  
Load constant 99999 into R64  
Constant 20 into R65  
Constant 0 into R71  
Is R65 larger than R29 (20 larger than 31)?  
Load X contour end point into R56  
Load Z contour start point into R53  
Load constant 30 into R65  
Is R65 larger than R29 (30 larger than 31)?  
Load back off idstance (1 mm) into R76  
Load back off distance (1 mm) into R77  
Load cycle type (29) into R70  
Load constant 10 into R65  
Cycle type -10 (31-10 = 21)  
Is R70 larger than R65 (31 larger than 10)?  
Load constant 1 into R65

}  
Roughing depth  
calculation  
}  
Calculating the  
material to be cut

Results in different cycle call.

@ 01 11 R70 R65  
:  
:  
:  
N11 @ 20 @ 90 90  
@ 20 @ 91 88  
R76 . R63  
  
R77 . R62  
  
R77 . R79  
R67 O R62  
R56 O R53  
R57 O R52  
N12 R56 - R76  
  
R60 . R67  
R62 . R78  
  
R62 . R79  
R63 . R78  
  
R68 - R58  
R52 - R62  
  
R53 - R63  
  
G00 G90 XR52 ZR53  
  
R53 R63

R70 = R65 (1 = 1)

Load address parameter @ 90 with Z  
Load address parameter @ 91 with X  
Back off distance . R63  
= (-back off distance)  
Back off distance . R62  
= (-back off distance)  
(-Back off distance) .2 (X axis)  
Load R62 into R67 (-1)  
Load Z contour start point into R56  
Load X contour end point into R57  
Z contour start point - (-back off distance)  
Roughing depth (X) . (-1)  
R62 . (Back off distance)  
= (-back off distance)  
(-back off distance) . 2 (X axis)  
R63 . (Back off distance)  
= (- back off distance)  
Delta X - Finishing allowance X  
X axis contour end point  
- (-back off distance X)  
Z contour start point  
- (-back off distance Z)  
Move to start point A on the X contour end point  
+ (-back off distance in X)  
Z contour start point  
+ (-back off distance Z)

Axis definitions  
  
Back off calculation  
  
Calculation for material to be removed  
  
Back off calculation  
  
Calculation for Point B  
  
Move to point B  
  
Return calculation point E

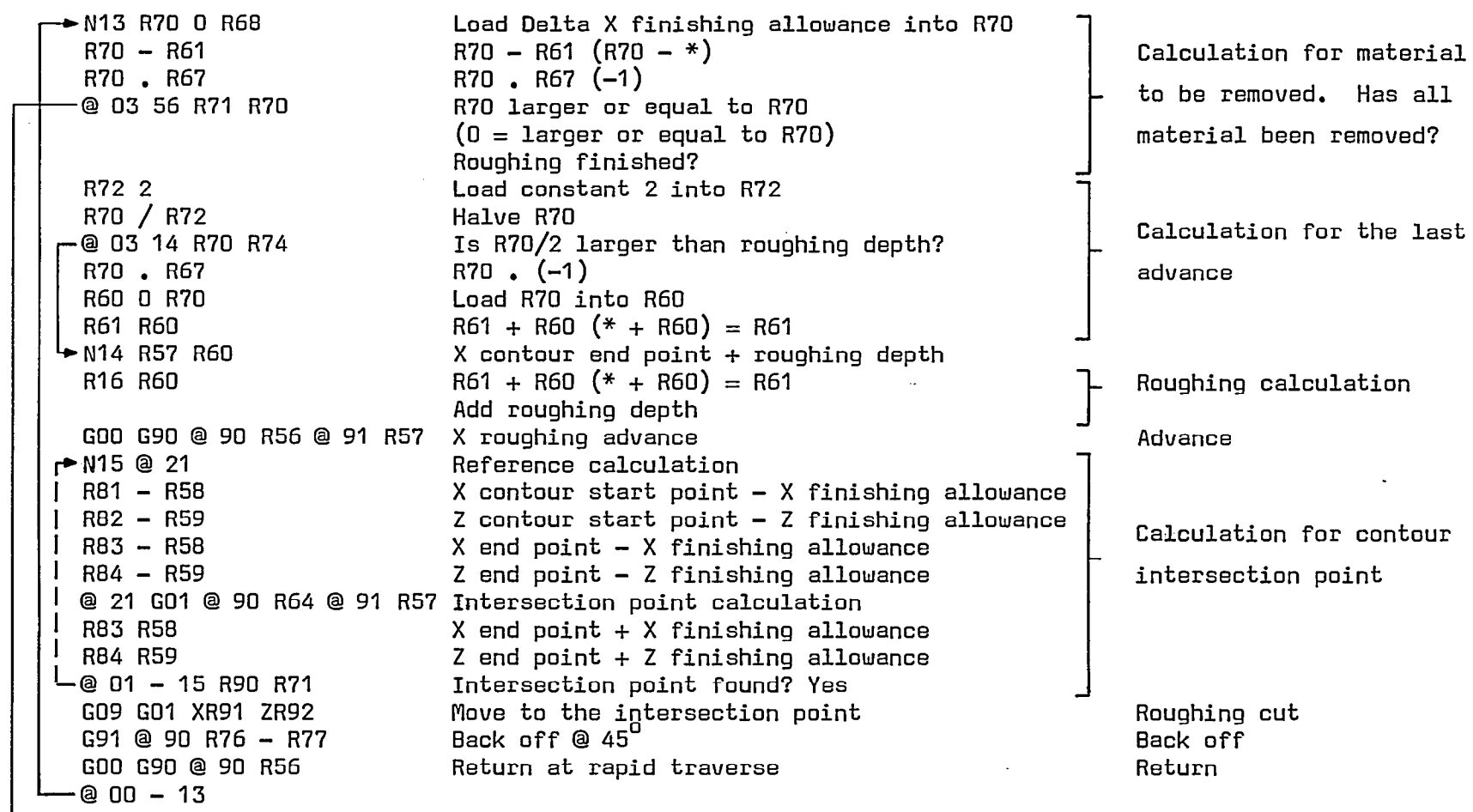

\* R61 = Sum of Roughing advances

1st pass R61 = 0

a

<p>(d)</p> <p>→ N56 R56 O R52</p> <p>R56 - R62</p> <p>R57 - R63</p> <p>G00 G90 XR56 ZR57 G40</p> <p>R65 20</p> <p>R70 1</p> <p>--- @ 02 31 R65 R29</p> <p>R50 - R58</p> <p>R51 - R59</p> <p>R50 - R62</p> <p>R51 - R63</p> <p>G00 G90 XR56 ZR57 G40</p> <p>G01 G91 XR62 ZR63</p> <p>R88 1</p> <p>→ N17 @ 21</p> <p>R83 - R58</p> <p>R84 - R59</p> <p>┌ @ 02 18 R87 R70</p> <p>  G9 G R87 G90 XR83 ZR83</p> <p>  ZR84 G R73</p> <p>  A00 19</p> <p>└ N18 G9 G R87 G90 XR83</p> <p>  ZR84/R85 KR86 G R73</p> <p>  N19 R83 R58</p> <p>  R84 R59</p> <p>--- @ 02 - 17 R70 R88</p> <p>G00 G90 XR56 ZR57 G40</p> <p>R65 40</p> <p>--- @ 02 31 R65 R29</p> <p>  :</p> <p>→ N31 G00 G90 XR56 ZR57 G40</p> <p>M17</p>	<p>Load X contour end point +(- Back off distance X) into R56</p> <p>Load Z contour start point +(- Back off distance Z) into R57</p> <p>R57 -(- Back off distance Z)</p> <p>Move in rapid traverse to the Z start and X end positions</p> <p>Load constant 20 into R65</p> <p>Load constant 1 into R70</p> <p>Is R65 larger than R29 (20 &gt; 31)?</p> <p>X contour start point -(- X finishing allowance)</p> <p>Z contour start point -(- Z finishing allowance)</p> <p>R50 -(- Back off distance X)</p> <p>R51 -(- Back off distance Z)</p> <p>Move in rapid traverse to point C</p> <p>Move to point C in G01 mode</p> <p>Set control parameter to 1</p> <p>Reference point calculation</p> <p>X end point - (- X finishing allowance)</p> <p>Z end point - (- Z finishing allowance)</p> <p>For arcs jump to N18</p> <p>Move in a straight line</p> <p>Move in an arc</p> <p>X End point +(- X finishing allowance)</p> <p>Z end point +(- Z finishing allowance)</p> <p>Is contour finished?</p> <p>Move at rapid travers to point E</p> <p>Load R65 with constant 40</p> <p>Is R65 larger than R29 (40 &gt; 31)?</p> <p>Move at rapid traverse to point E (If point E has been reached, no move results)</p>	<p>calculate Point E</p> <p>move to Point E</p> <p>calculate Point C</p> <p>move to Point C</p> <p>move to point O</p> <p>1st block must be called from SR</p> <p>Divide up the block</p> <p>Include finishing allowance</p> <p>clean up contour</p> <p>clean up arc</p> <p>remove finishing allowance</p> <p>All block completed!</p> <p>Yes, go to point E</p>
--	--	--

3.4 @ 23 "Tool Change"

**Application:** The tool change function is a special function to enable the tool change cycles (Sprint 8T). The tool change cycles ensure collision free tool changes. Data are necessary to define the tool change cycle.

**Example:** See 3.4.1

**Programming:** N... @ 23 LF - (In a block on its own)

**Command:** Tool change

@ 23 is programmed at the start of the L91 or L92 tool change cycle.

The following are defined in parameters:

R91	Actual X axis zero offset
R92	Actual Z axis zero offset
R94	Current tool number (T with compensation number)
R95	X axis absolute tool change point (TE date N383 S)
R96	Z axis absolute tool change point (TE date N384 S)
R97	Largest X tool length
R98	Largest Z tool length
R99	Largest vectoral length

**Warning:** Prior to programming @ 23, @ 31 must be programmed (see chapter 4.1).

### 3.4.1 Example for the tool change cycle L91

There are two variants of the L91 cycle:

- a) A protected zone programmed with X (R18) and Z (R19)

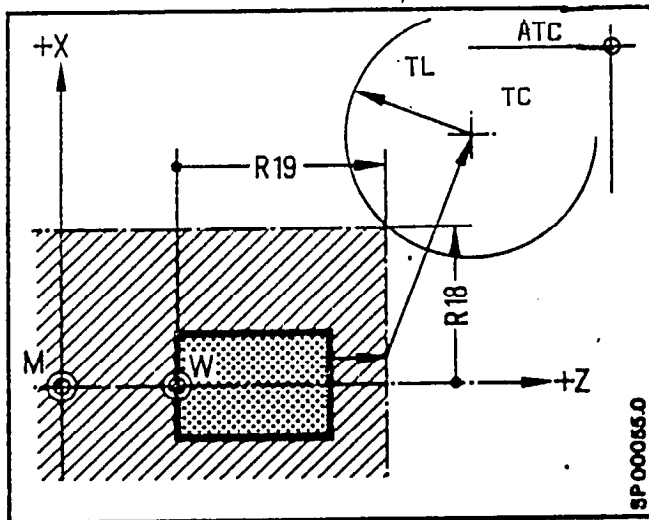

- b) A protected zone programmed with Z only (R19)

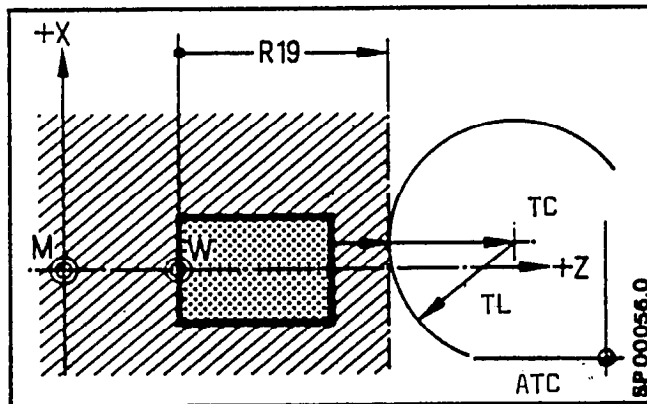

#### Operation notes

If the calculated retract position "TC" exceeds the co-ordinates of the absolute tool change point "ATC", the retract is only to the "ATC" point or to the respective co-ordinate (if a parameter has been programmed as 0). If L 91 or L 92 are called up before tool lengths have been programmed, the retract is always made to the absolute tool change point.





```

L9100
N1 @ 23
@ 25

R78 O R18
R78 . R79
G40 G90 R90 O
R92 O R19
GO ZR19

```

```

Tool change cycle
Tool change
Initiate start condition for the
cycle
Load X protected area into R78
Double for diameter programming
Cancel CRC, G90, Load R90 with O
Load R19 contents into R92
Move into R19 distance at rapid
traverse
R90 = R99 vectoral length = O
R90 = R18 X protection zone = O
Add the largest Z length to Z
protection zone
Load R78 contents into R91 (X
protection zone)
Is R90 larger than R91 (O larger
than X protection zone?)
Add the largest X length to X
protection zone
Jump to N4
(-X protection zone) - largest X
length
Jump to N4
Add the largest vectoral length to
Z protection zone
Load X position into R93
Load R93 into R91
If R92 is larger than R96 the Z move
distance exceeds the Z absolute tool
change point
Is R90 larger than R91? O equals
larger X move
Is R91 larger than R95? X move
exceeds the X tool change point

```

```

Defines the largest tool
Inclusion for
diameter programming

Move to the Z protection zone

Jump if no tool lengths are defined

Calculate ZTC . case A

Jump when X zone negative

Calculate XTC . case A

Calculate - XTC . case A

Calculate ZTC . case B

Jump when ATC coordinates are exceeded
in Z axis

Jump if X move is negative

Jump if ATC coordinates are exceeded
in X axis

```

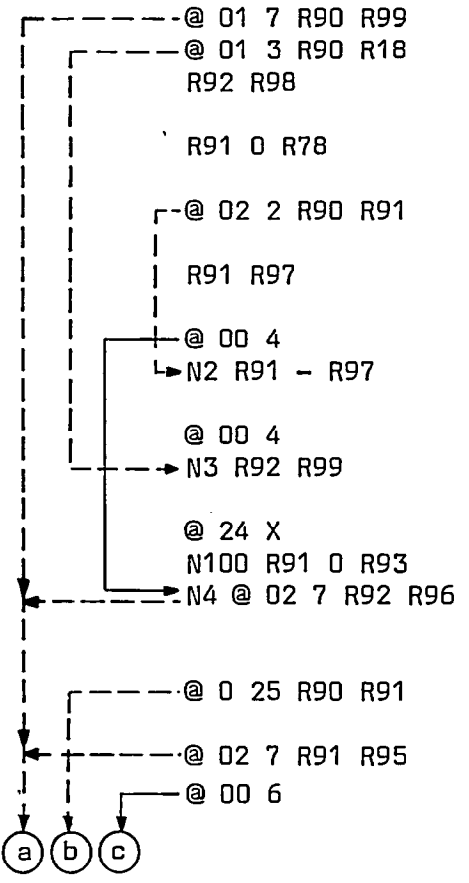

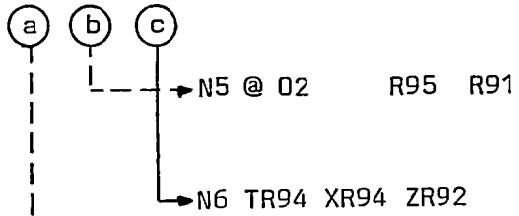

@ 00 8

N8 M17

If R95 is larger than R91, the absolute X tool change point is larger than the X move, move X and Z to TC: cancel the tool offset

Jump to N8

Move X & Z to ATC; Cancel the tool offset

Jump if the ATC co-ordinates are exceeded; X axis move to TC - cancel the tool offset.

Move to ATC - cancel the tool offset

Revised cycle see page 6-1

3.5 @ 24 "Load Position Value"

Application: The function enables an axis position or the angular position of the spindle to be determined. The function realises in turn the following functions:

- Tool lengths determination
- Work piece measuring
- Start point determination

Example: See 3.5.1

Programming: N ... @ 24 Z LF (In a block on its own)

Command: Load position

Load the position of the axis as addressed. If the angular position of the spindle is to be loaded, program the S address.

Indirect address input: N... @ 24 @ 90 LF (In a block on its own)

The address into which the position should be loaded, is indicated by an address parameter (as shown @ 90)

The position value referred to the tool reference point is determined from machine zero. The position value in turn is deposited into a fixed R parameter, R 93.

The spindle angular position obtained and stored in R 93, on programming @ 24 S, is the angular spindle position in the M03 direction from the marker. An accurate transfer of the position value is only possible when axis positioning or spindle positioning has finished. The @ 24 command to load the position value is only executed when axes movements have finished as a result of control supervision.

Please note:           The position value derived from machine zero is only set after reference point approach and cannot be altered manually or by the program. Loaded is the distance between the saddle reference point and the machine zero point of the programmed axis.

### 3.5.1 Example: Load Position - Establishing tool lengths

**Task:** Tool lengths are to be measured using the machine.

**Machine requisites:** The machine must be fitted with an optical measuring system. The geometric cross wire data is referenced to machine zero and defined in protected parameters e.g. R64, R65.

**Sequence:** The operator moves the tool coincident with the optical system cross wires. The "Measure Tool" push button calls the PC sub-routine (L 850). In conjunction with the "Operator Aids" function (see chapter 5.2), the operator then inputs the respective tool offset number. After pressing "Cycle Start" the sub-routine is executed. This cycle calculates the cross-wire position with respect to the machine zeroes and the actual position values. The result are the tool offsets, which are stored in the operator's defined tool offset store.

**WARNING:** The "Measure Tool" push button pre-supposes a PC program.

## Sub-routine:

L 850

N005 R64 100 R65 15	X and Z cross wires position
N010 @ 24 X	Load X axis position into R93
N015 R60 0 R93	Transfer X axis position into R60
N020 @ 24 Z	Load Z axis position into R93
N025 R61 0 R93	Transfer Z axis position into R61
N030 R64 - R60	Calculate $\Delta X$
N035 R65 - R61	Calculate $\Delta Z$
G92 T R66 X R64 Z R65	Store $\Delta X$ and $\Delta Z$ in the tool store
M17	

& L650 (Measure Tool)	] Key with clear text and input format (see chapter 5.2, Operator Aids).
R66 2.0 (TO number)	

### 3.6 @ 25 "Start conditions for cycles"

**Application:**

The start condition function for cycles is defined in two parameters:

R79 1  $\overset{\wedge}{=}$  X axis radius programming.

R79 2  $\overset{\wedge}{=}$  X axis diameter programming.

R78 is loaded with a count value in the correct format, representing the 1 mm distance.

e.g. 1 in metric with the decimal point

e.g. 1000 in metric without the decimal point

R77 is loaded and is used as an internal control marker. This value has no meaning for the end-user.

**Example:**

see 3.3.1; 3.4.1

**Programming:**

N... @ 25 LF (In a block on its own)

**Command:** Start conditions  
for cycles



### 3.7 @ 29 "Load/Read system stores"

**Application:**

This function gives access to the NC control system memories for user programs. It permits read-out from memories and the loading of some system memories (write).

The following system memories are accessed:

- Tool geometry
- Tool wear
- Settable zero offset
- Additive offset
- Resolver shift
- G92 zero offset
- Preset Value
- Actual offset
- R parameter
- Machine parameters
- Programmable additive zero offsets



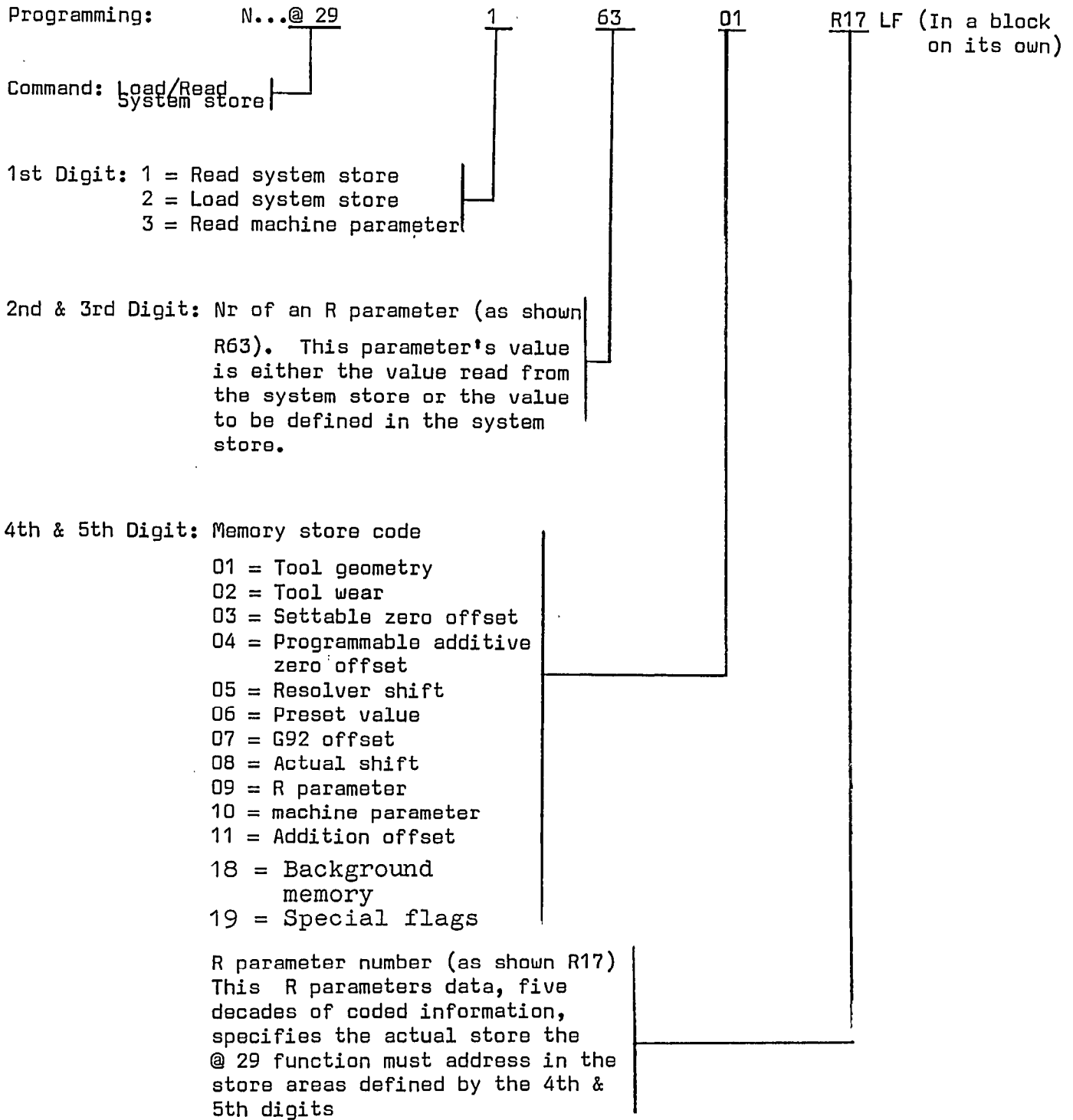

1st & 2nd Digits: e.g. Axis number (For further information, see overview Chapter 6.9)

3rd & 4th & 5th Digits: Ident. number, e.g. the number of the settable zero offset (For further information, see Chapter 6.9)

As a result of this store access, the load actual value command @ 24, for example, can read out the current position with respect to the machine zero and be used to define some other co-ordinate system .

1st Example:

Task: The position of a workpiece face with respect to the workpiece reference must be determined in the X axis with a position sensor.

M = Machine zero

M' = Resolver shift

C = G92 or preset

XMW = Zero offset

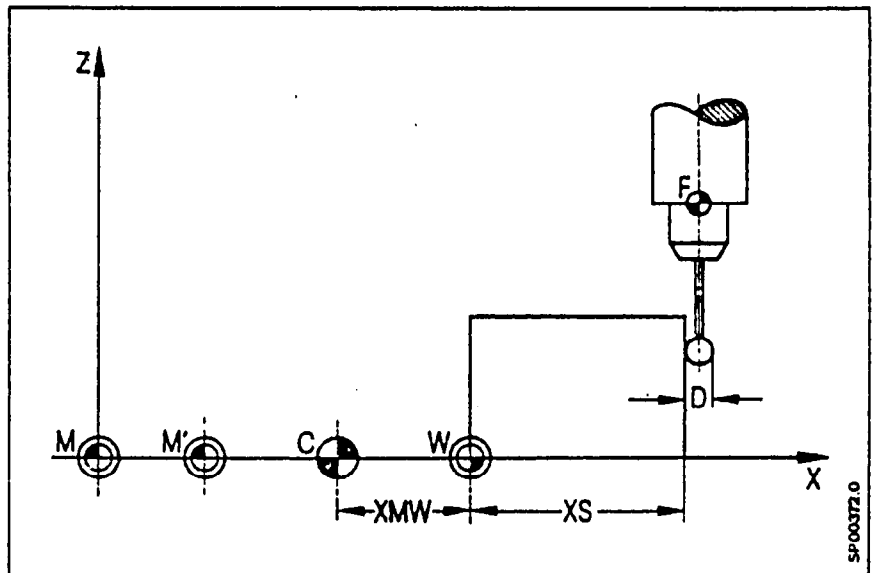

After loading the X axis position, with respect to the zero point by utilising the @ 24 function, the value deposited into R93 is used to calculate the displacement value of the new workpiece reference point.

$$\begin{aligned} \text{Displacement:} & \quad [\text{Absolute position}] - [\text{Actual shift}] \\ & \quad - [\text{Resolver shift}] - [\text{Preset value}] \\ & \quad - [\text{G92 offset}]. \end{aligned}$$

$$\begin{aligned} \text{Actual shift:} & \quad \text{sum of tool offsets (evt. mirrored)} \\ & \quad + \text{sum of all zero offsets} \end{aligned}$$

## Programming:

.  
.  
.

N235 R20 01 001	Call the 1st Axis (X axis) and the group
N240@ 29 1 60 05 R20	Load X axis resolver shift into R60
N245@ 29 1 61 06 R20	Load X axis Preset value into R61
N250@ 29 1 62 07 R20	Load X axis G92 offset into R62
N255@ 29 1 63 08 R20	Load X axis actual shift into R63
N260 R93 - R60	Absolute position - Resolver shift
N265 R93 - R61	Absolute position - Preset value
N270 R93 - R62	Absolute position - G92 offset
N275 R93 - R63	Absolute position - Actual shift
N280 R70 0 R93	Load displacement into R70

2nd Example:

Task: A measuring cycle is to load parameters R01 and R03 with the X Y and Z axis zero offset values.

The measured values are then to be loaded into the 3rd zero offset group of the SINUMERIK Sprint 8M.

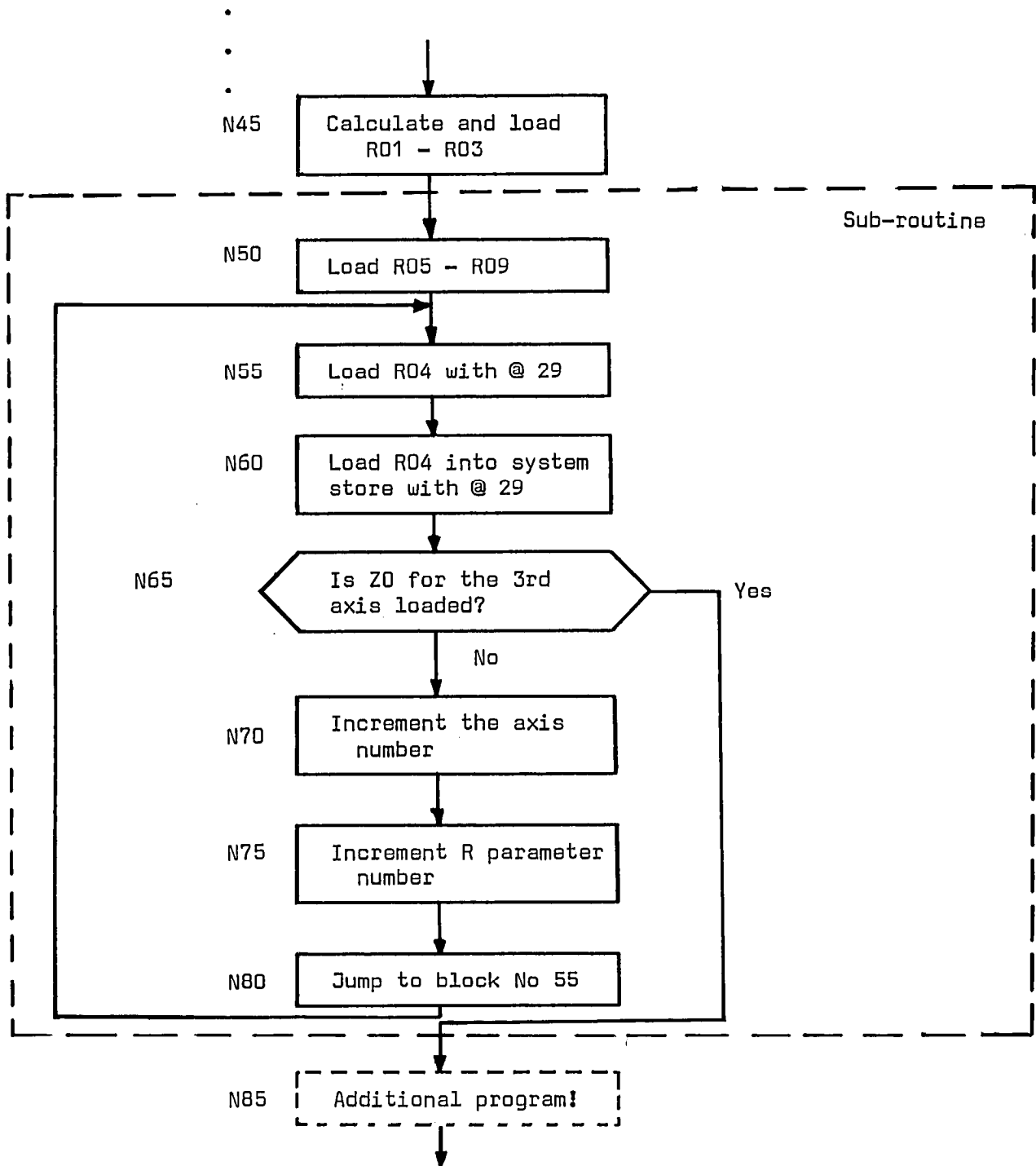
Flow Chart:

## Programming:

```

.
.
.
N50 R05 1003 R06 1000 R07 1 R08 1 R09 3003
N55 @ 29 10409 R07
N60 @ 29 20403 R05
N65 @ 01 + 85 R05 R09
N70 R05 R06
N75 R07 R08
N80 @ 00 - 55
N85
.
.
.
.

```

## Parameter clarification:

R01	165.015	New X axis Z0 value
R02	1003.598	New Y axis Z0 value
R03	29.712	New Z axis Z0 value
R04		Contains the value for transfer (X, Y, Z)
R05	1003	@ 29 coding (1st axis 3rd Z0 group)
R06	1000	Value for axis number increment (Y, Z)
R07	1	@ 29 coding (R parameter number) (leading zeros may be omitted)
R08	1	Value for R parameter incrementing (R02, R03)
R09	3003	Comparison code (3rd axis)

4.1 @ 31 "Clear buffer"

## Application:

Many control signals at the interface (parallel or PC) are not given directly to the NC working memory but routed indirectly via the buffer memory. Some of these signals are listed below and can, for example, be called with M functions:

- |                                   |                                |
|-----------------------------------|--------------------------------|
| - mirror image                    | - External additive zero shift |
| - zero point shift group (8M/8MC) | - external zero shift          |
| - R parameter input               | - synchronous moves (8MC)      |
|                                   | - external tool corrections    |

If these signals are addressed within a working program and active in the following block, the buffer must be cleared. Otherwise, the selected control signal will be active some blocks later.

The buffer can be cleared with the @ 31 function. In the program block containing @ 31 the interface is told that one of the above datum should be transferred to the NC. e.g. with an M function. On recognising the function, the interface disables the interface signal "Read in Enable" until the transfer of data to the NC has finished.

Example: N... M.. The interface disables "Read in Enable" and transfers data to the NC. After data transfer, the disable is removed.

Programming N... @ 31 (In a block on its own)

Command: Buffer clear



L 999 is provided as this function is suitable for both normal programs and sub-routines (see programming manual). The L 999 program is as follows:

L 99900

@ 31

M17 LF

Example: Select the external tool compensation  
e.g. following tool measurement

N15 M.. Select and transfer external tool compensation value. Disable "Read in Enable"

N20 L999 Buffer clear

N25... New tool compensation is calculated and is effective in block N25. In block N20, instead of L999, @ 31 could also be directly programmed.

4.2 @ 30 "Reference to machine actual value system"

Application: It is often required to approach a fixed point of the machine, e.g. the fixed tool change point. By programming @ 30 , it is possible to suppress

- all zero shifts
- the preset shift
- the G92 shift
- the DRV shift (handwheel shift)

Programming: N... @ 30 X ... Z ... LF

Command: Reference to  
machine actual  
value system

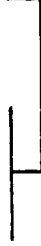

Attention: The command @ 30 is effective in one block, i.e. it must be repeated in subsequent blocks.

Please note also: By setting machine data TE N424, BIT 2 "G53 as @ 30", programming G53 has the same effect as programming @ 30.



5.1 @ 90 to @ 99 "Address parameters"

Application: This enables variable address  
parametering in addition to variable  
count parametering

See 3.1, 3.1.1, 3.1.2, 3.3.1. for further application use  
and programming information.

5.2 & "Operating Aids" (In preparation)

**Application:** Aiding the Operator when manually entering sub-routines or cycles. The name, number and use of the parameters is displayed in clear text by the NC, automatically, following input of the required sub-routine number. The respective text, limited to 14 characters and the format of the R parameters can be defined by the programmer.

**Example:**

**Stock removal cycle:**

L09500		
N1 @ 25		"Stock removal cycle" closed with an M17
:		
:		
N31 G00 G90 XR56 ZR57 G40		
M17		
& L095	(Stock removal)	
R20 3.0	(SR contour type)	
R21 -5.3	(X contour start point)	
R22 -5.3	(Z contour start point)	
R24 1.3	(X finish allowance)	Clear text key and format requirements
R25 1.3	(Z finish allowance)	
R26 2.3	(roughing)	
R27 2.0	(CRC direction)	
R29 2.0	(stock removal cycle type)	
M17		

The Operator Aids clear text key is appended to the sub-routine and closed with M17. The key is normally written without block numbers and starts with "&" followed by the sub-routine number (3 decades) and the name of the sub-routine in clear text.

Example:           & L095 (Stock Removal)

In the subsequent program lines, the sub-routine R parameters are defined. A line starts with the R parameter number, followed by the parameter input format and ends with the clear text which clarifies the input value. Any number of program texts can be written.

Example:           R21 - 5.3 (Start Cont. X)

The format entry consists of a number before and after the decimal point. These numbers indicate the maximum number of digits permitted before and after the decimal point. The "-" sign indicates whether the decimal value can be positive or negative. A format without sign indicates that only a positive value is permitted. An input by the operator is checked for format. When the format is disallowed, the value is not transferred to the control, only underlined. This error can be rectified by pressing the "Clear" push button and re-entry of correct data. The length of clear text on one program line is 14 characters. The mandatory brackets around the clear text are considered to be part of the text. If more than 14 characters are defined, the control defines the 14th character as a close bracket automatically. The remaining text is not displayed.

The key is closed with an M17 in a block on its own.



6.0 Appendix6.1 Cycles 8T/Sprint 8T

```

% SP
L9100<21.06.02 [051] G G40 G90 @25
@31
@23
R82 0 R92 R86 0 R96 R90 0
R95 - R91
R96 - R92 R78 0 R18
R78 . R79 R91 0 R78 R92 0 R19
@02 12 R92 R96
@04 8 R90 R99
@04 6 R90 R18
@02 2 R90 R18
R91 R97
@00 3
N2 R91 - R97
N3 @02 4 R90 R91
@02 8 R91 R95
@00 5
N4 @02 8 R95 R91
N5 R92 R98
@00 7
N6 R92 R99
N7 @02 8 R92 R96
N9 @01 12 R90 R19
ZR19
@01 10 R90 R18
TR94 XR91 ZR92
@00 11
N10 @02 14 R92 R86
TR94 ZR92
@00 11
N14 @01 15 R90 R18
@00 12
N15 R98 R19
R98 R82
@03 12 R98 R86
TR94 ZR96
@00 11
N8 ZR19
@01 -15 R90 R18
N12 TR94 ZR96
XR95
N11 M17

```

L9200 G G40 G90 @25  
@31  
@23  
R81 @ R91 R85 @ R95 R90 @  
R95 - R91  
R96 - R92 R78 @ R18  
R78 . R79 R91 @ R78 R92 @ R19  
@02 12 R91 R95  
@01 8 R90 R99  
@01 6 R90 R19  
@02 2 R90 R18  
R91 R97  
@00 3  
N2 R91 - R97  
N3 @02 4 R90 R91  
@02 8 R91 R95  
@00 5  
N4 @02 8 R95 R91  
N5 R92 R98  
@00 7  
N6 R91 R89  
N7 @02 8 R92 R96  
N9 @01 12 R90 R18  
XR78  
@01 10 R90 R19  
TR94 XR91 ZR92  
@00 11  
N10 @02 14 R91 R85  
TR94 XR91  
@00 11  
N14 @01 15 R90 R19  
@00 12  
N15 R97 R78  
R97 R81  
@03 12 R97 R85  
TR94 XR95  
@00 11  
N8 XR78  
@01 -15 R90 R19  
N12 TR94 XR95  
ZR96  
N11 M17

L9500 G40 G90 R77 0  
 @25 R64 1 R73 40 R88 1  
 @00 R77  
 N0 R50 88 R51 90  
 @00 2  
 N1 R50 1 R51 2  
 N2 @03 3 R73 R27  
 R73 0 R27  
 N3 R60 0 R26 R74 0 R26  
 N4 @21  
 @07 -4 R64 R88  
 R65 0 R29 R64 10  
 N5 R65 - R64  
 @02 -5 R65 R64  
 R64 2  
 @02 9 R65 R64  
 R62 -1  
 @02 9 R21 R83  
 N6 R52 0 R83 R53 0 R22 R68 0 R21 R69 0 R64  
 @02 10 R84 R22  
 N7 R63 -1  
 @00 11  
 N8 R62 1  
 @02 -6 R21 R83  
 N9 R52 0 R21 R53 0 R84 R68 0 R63 R69 0 R22  
 @02 -7 R84 R22  
 N10 R63 1  
 N11 R58 0 R62  
 R58 . R24  
 R58 R79 R59 0 R63  
 R59 R25  
 R68 - R52  
 R69 - R53  
 R52 - R58 R61 0 R71 0  
 R57 - R59 R64 9999  
 R64 . R78  
 R62 R79 R76 0 R78  
 @00 11 R65  
 N12  
 N14 R60 R79 R78 0 R50 R50 0 R51  
 R74 . R79 R51 0 R70  
 R76 . R63 R67 0 R62  
 R67 / R79 R56 0 R53 R67 0 R52  
 @00 16  
 N13  
 N15 R76 . R62 R67 0 R62 R70 0 R68 R68 0 R69 R69 0 R70  
 R56 0 R52 R57 0 R53

N16 @20 @90 R50  
@20 @91 R51  
R56 - R76  
R60 . R67  
R62 . R78  
R63 . R78  
R52 - R62  
R53 - R63 R50 @ R21  
R50 - R62 R51 @ R22  
R51 - R63  
R62 / R79  
R77 @ R29 R78 @  
R77 - R65  
@01 21 R70 R77  
G XR52 ZR53  
R65 20 R72 2 R77 @  
N17 R70 @ R68  
R70 - R61  
R70 . R67  
@03 23 R71 R70  
R70 / R72  
@02 19 R70 R74  
R70 . R67  
@02 18 R77 R71  
R60 @ R70 R77 1  
N18 @02 19 R65 R29  
R61 R60  
N19 R57 R60  
R61 R60  
@90 R56 @91 R57  
N20 @21  
R91 - R58  
R92 - R59  
R93 - R58  
R94 - R59  
@22 G1 @90 R64 @91 R57  
R83 R58  
R84 R59  
@01 -20 R90 R71  
G1 XR91 ZR92  
G91 X- R62 Z- R63  
G G90 @90 R56  
@00 -17  
N21 @01 22 R71 R24  
@00 23  
N22 @01 28 R71 R25



N23 @21  
@01 -23 R88 R71  
R65 20 R70 1  
G XR52 ZR53  
@02 29 R65 R29  
R50 - R58  
R51 - R59  
G XR50 ZR51  
G1 G91 XR62 ZR63 GR73 R88 1  
N24 @21  
@02 27 R88 R70  
R83 - R58  
R84 - R59  
@02 25 R87 R70  
G1 G90 XR83 R58 ZR84 R59  
@00 26  
N25 GR87 G90 XR83 R58 ZR84 R59 IR85 KR86  
N26 @02 -24 R70 R88  
N27 R65 40  
@02 29 R65 R29  
N28 R70 100 R71 1  
R70 . R20  
R70 R71  
G G40 XR52 ZR53  
XR50 ZR51  
G1 XR21 ZR22 GR73 LR70  
N29 G G40 G90 XR52 ZR53 M17

L9700 R77 0 R75 1  
 @25  
 @00 R77  
 N0 R60 00 R61 90  
 @00 2  
 N1 R60 1 R61 2  
 N2 R72 0 R25 R56 0 R24 R62 -1 R64 0 R65 -1  
 @03 3 R24 R64  
 R62 1  
 N3 R50 1 R51 1 R52 -1 R53 -1  
 R78 . R62 R58 0 R31  
 R58 - R21  
 R58 / R79 R59 0 R32  
 R59 - R22  
 @03 4 R58 R64  
 R58 . R65 R50 -1 R52 1  
 N4 @03 5 R59 R64  
 R59 . R65 R51 -1 R53 1  
 N5 @03 6 R59 R58  
 R76 0 R60 R60 0 R61 R61 0 R76  
 R76 0 R50 R50 0 R51 R51 0 R76 R76 0 R58 R58 0 R59 R59 0 R76 R65 1  
 N6 @20 @98 R60  
 @20 @99 R61  
 R54 0 R58 R76 0 -R51  
 R54 / R59 R60 0 R26  
 R60 . R54 R61 0 R27  
 R61 . R54  
 R58 R60  
 R58 R61  
 R59 R26  
 R59 R27  
 R50 . R56  
 R51 . R59  
 @03 7 R65 R64  
 R60 . R79  
 R52 . R60  
 R78 . R79  
 R52 R78  
 R78 / R79  
 R53 . R26  
 @00 8  
 N7 R52 . R26  
 R52 . R79  
 R53 . R60  
 R53 R78

N8 R52 R21 R70 0 R71 0  
R53 R22 R65 90 R29 R66 0 R29  
@15 R66  
@15 R65  
R66 / R65 R68 0 R25  
R68 . R62 R65 1 R61 -1  
R56 R68 R57 0 R28 R68 0 R28  
@10 R57  
R56 / R57  
G G90 XR52 ZR53  
@02 9 R64 R24  
R75 -1  
N9 @03 10 R28 R64  
R68 . R61 R57 1 R79 2  
R57 / R79  
@00 13  
N10 R64 R65  
@02 12 R68 R64  
@02 11 R72 R71  
R70 R65 R57 0 R24  
@00 14  
N11 R72 0  
N12 R57 0 R64  
@10 R57  
N13 R57 . R56  
N14 R67 0 R24  
R67 - R57  
R67 . R76  
R67 . R66  
R67 . R76 R54 0 R51  
R54 R67  
R57 - R78  
G91 @99 - R67  
@98 R57  
G73 @98 R50 @99 R54 IR20 KR20  
G @98 - R57  
G90 XR52 ZR53  
@07 -10 R23 R70  
M17

L9800 @25 R63 0 R22 R64 0 R25 R65 0 R67 2  
R63 - R26  
R67 . R24  
G G64 G90 ZR22  
N3 R63 - R64 R62 0 R26  
@03 4 R65 R63  
R62 R63  
G1 ZR62  
G4 FR28  
G ZR22  
G4 FR27  
R62 R78  
ZR62 - R78  
@03 4 R24 R63  
R64 - R24  
@02 -3 R64 R24  
R64 0 R24  
@03 -3 R63 R67  
R64 0 R63 R62 2  
R64 / R62  
@00 -3  
N4 G1 ZR26  
G4 FR28  
G ZR22 M17

German text cycles 8T/Sprint 8T

& LD91(WKZWECHSEL Z)  
R18 -5.3(SCHUTZZONE X)  
R19 -5.3(SCHUTZZONE Z)  
M17

& LD92(WKZWECHSEL X)  
R18 -5.3(SCHUTZZONE X)  
R19 -5.3(SCHUTZZONE Z)  
M17

& LD95(ABSPANEN)  
R20 3.0(UP-NR KONTUR)  
R21 -5.3(START KONT.X)  
R22 -5.3(START KONT.Z)  
R24 1.3(SCHLI.MASS X)  
R25 1.3(SCHLI.MASS Z)  
R26 2.3(SCHRUPPSPAN)  
R27 2.0(SRK RICHTUNG)  
R29 2.0(ART ABSPANEN)  
M17

& LD97(GEWINDE)  
R20 4.3(STEIGUNG)  
R21 -5.3(START GEW. X)  
R22 -5.3(START GEW. Z)  
R23 1.0(LEERSCHNITTE)  
R24 -2.3(GEWINDETIEFE)  
R25 1.3(SCHLICHTAUFM)  
R26 2.3(EINLAUFWEG)  
R27 2.3(AUSLAUFWEG)  
R28 -3.0(SCHRUPPSCHN.)  
R29 3.3(ZUSTELLWINK)  
R31 -5.3(ENDE GEW. X)  
R32 -5.3(ENDE GEW. Z)  
M17

& LD98(TIEFBOHREN)  
R22 -5.3(START Z)  
R24 2.3(DEGRESSION)  
R25 3.3(1. BOHRTIEFE)  
R26 -5.3(ENDBOHRRTIEFE)  
R27 2.3(ENTSPANZEIT)  
R28 2.3(SPANBRECHEN)  
M17  
M02

English text cycles 8T/Sprint 8T

& LD91(TOOL CHAN. Z)  
R18 -5.3(PROTECTED X)  
R19 -5.3(PROTECTED Z)  
M17  
& LD92(TOOL CHAN. X)  
R18 -5.3(PROTECTED X)  
R19 -5.3(PROTECTED Z)  
M17  
& LD95(MACHINING)  
R20 3.0(SR-NO CONT.)  
R21 -5.3(START CONT.X)  
R22 -5.3(START CONT.Z)  
R24 1.3(FIN.MARGIN X)  
R25 1.3(FIN.MARGIN Z)  
R26 2.3(ROUGH CUT)  
R27 2.0(CRC DIRECT.)  
R29 2.0(TYPE MACH.)  
M17  
& LD97(THREAD)  
R20 4.3(PITCH)  
R21 -5.3(ST.THREAD X)  
R22 -5.3(ST.THREAD Z)  
R23 1.0(NON-METAL P.)  
R24 -2.3(THREAD DEPTH)  
R25 1.3(FINISH MARG.)  
R26 2.3(ACC.DISTANCE)  
R27 2.3(RETRACT DIST)  
R28 -3.0(NO.ROUGH CUT)  
R29 3.3(ANG.OF ADV.)  
R31 -5.3(END THREAD X)  
R32 -5.3(END THREAD Z)  
M17  
& LD98(DEEP DRILL)  
R22 -5.3(START Z)  
R24 2.3(DEGRESSION)  
R25 3.3(1.DRILLDEPTH)  
R26 -5.3(END DEPTH)  
R27 2.3(CHIP REM.T.)  
R28 2.3(CHIP BREAK.T)  
M17  
M02

French text cycles 8T/Sprint 8T

& L091(CHG.UTIL Z)  
R18 -5.3(ZONE PROTG.X)  
R19 -5.3(ZONE PROTG.Z)  
M17  
& L092(CHG.UTIL X)  
R18 -5.3(ZONE PROTG.X)  
R19 -5.3(ZONE PROTG.Z)  
M17  
& L095(DEGROSSIR)  
R20 3.0(NR-SP.CNTOUR)  
R21 -5.3(DEB.CNTOUR X)  
R22 -5.3(DEB.CNTOUR Z)  
R24 1.3(COTE FINIS.X)  
R25 1.3(COTE FINIS.Z)  
R26 2.3(COPEAU EBAU.)  
R27 2.0(DIR.COR.OUT.)  
R29 2.0(TYPE EBAUCHE)  
M17  
& L097(FILETAGE)  
R20 4.3(PAS DE FILET)  
R21 -5.3(DEB.FILET X)  
R22 -5.3(DEB.FILET Z)  
R23 1.0(COUPES VIDE)  
R24 -2.3(PROF.FILET)  
R25 1.3(SURCOTE FIN)  
R26 2.3(CHEMIN ENTR.)  
R27 2.3(CHEMIN SORT.)  
R28 -3.0(COUCPE EBAU.)  
R29 3.3(ANGLE AVANCE)  
R31 -5.3(FIN FILET X)  
R32 -5.3(FIN FILET Z)  
M17  
& L098(PERCAGE PROF)  
R22 -5.3(DEBUT Z)  
R24 2.3(DEGRESSION)  
R25 3.3(1.PROF.PERC.)  
R26 -5.3(PROF.FINALE)  
R27 2.3(TEMPS DECOP.)  
R28 2.3(BRISAGE COP.)  
M17  
M02

Italian text cycles 8T/Sprint 8T

& LD91(CAMBIO UT.Z)  
R18 -5.3(ZONA PROT.X)  
R19 -5.3(ZONA PROT.Z)  
M17  
& LD92(CAMBIO UT.X)  
R18 -5.3(ZONA PROT.X)  
R19 -5.3(ZONA PROT.Z)  
M17  
& LD95(SGROSSATURA)  
R20 3.0(NR.SP CONTOR)  
R21 -5.3(START CONT.X)  
R22 -5.3(START CONT.Z)  
R24 1.3(QUOTA FIN.X)  
R25 1.3(QUOTA FIN.Z)  
R26 2.3(PROF.PASSATA)  
R27 2.0(DIREZ.CRU)  
R29 2.0(ASPORT.TIPO)  
M17  
& LD97(FILETTATURA)  
R20 4.3(PASSO FILET)  
R21 -5.3(START FIL.X)  
R22 -5.3(START FIL.Z)  
R23 1.0(PASS.A VUOTO)  
R24 -2.3(PROF.FILETTO)  
R25 1.3(QUOTA FINIT.)  
R26 2.3(PERC.ENTRATA)  
R27 2.3(PERC.USCITA)  
R28-3.0(PASS.DI SGR.)  
R29 3.3(ANGOLO PENET)  
R31 -5.3(FINE FILET.X)  
R32 -5.3(FINE FILET.Z)  
M17  
& LD98(FOR.PROFONDA)  
R22 -5.3(START Z)  
R24 2.3(DEGRESSIONE)  
R25 3.3(1.PROFONDITA)  
R26 -5.3(PROF.FINALE)  
R27 2.3(SCARICO TRUC)  
R28 2.3(ROTTURA TRUC)  
M17  
MD2



Stock removal cycle L950 8T/Sprint 8T

% SP

L95000(29.09.82[051]) R65 20

@02 1 R29 R65

@00 70

N1 R65 30

@02 70 R29 R65

@25

R73 40 R75 1 R88 1

@03 36 R73 R27

R73 0 R27

N36 R50 0 R21

R51 0 R22

R60 0 R26

R60 . R79

N2 @21

@02 -2 R75 R88

R64 10

R65 0 R29

N3 R65 - R64

@02 -3 R65 R64

R64 2

@02 6 R65 R64

R62 -1

@02 7 R50 R83

N4 R56 0 R83

R57 0 R51

R68 0 R50

R69 0 R84

@02 8 R84 R51

N5 R63 -1

@00 85

N6 R62 1

@02 -4 R50 R83

N7 R56 0 R50

R57 0 R84

R68 0 R83

R69 0 R51

@02 -5 R84 R51

N8 R63 1

N85 R58 0 R62

R58 . R24

R58 . R79

R59 0 R63

R59 . R25

R68 - R56

R69 - R57

R56 - R58

R57 - R59

R61 0 R71 0

N24 R65 -20  
R65 R29  
R70 1  
@01 20 R65 R70  
R70 3  
@01 20 R65 R70  
R76 @ R26  
R61 @  
R64 @ R68  
R64 / R79  
R70 -1  
R60 . R62  
R76 . R63  
R64 / R69  
@02 25 R64 R61  
R64 . R70  
N25 R70 1  
@02 26 R64 R70  
R60 . R64  
@00 38  
N26 R76 . R64  
N38 R74 -1  
R66 @ R60  
R67 @ R76  
@03 55 R66 R71  
R66 . R74  
N55 @03 57 R67 R71  
R67 . R74  
N57 R72 2  
@02 27 R50 R83  
R50 @  
@00 28  
N27 R50 1  
N28 @02 62 R50 R62 R71  
@00 63- R50  
N62 @20 @90 2  
@20 @91 1  
N70 R53 @ R57  
R75 @ R56  
N60 R59 @ R69  
R72 @ R62  
R58 @ R67  
R60 @ R76  
R50 60  
@00 40  
N63 @20 @90 1  
@20 @91 2  
N71 R53 @ R56  
R75 @ R57  
N61 R59 @ R68  
R58 @ R66  
R50 61

N40 R74 -1  
R70 0 R59  
R70 - R61  
001 16 R71 R70  
R70 / R72  
003 52 R70 R71  
R70 . R74  
000 54  
N52 R74 1  
N54 002 42 R70 R58  
R70 . R74  
R60 0 R70  
R61 R60  
R70 0 R61  
R61 0 R59  
R53 R60  
000 44  
N42 R53 R60  
R61 R60  
R70 0 R61  
N44 R70 / R59  
000 50  
N16 001 35 R71 R24  
000 56  
N35 001 20 R71 R25  
N56 R70 1  
R53 R60  
N50 G0 G90 090 R53 091 R75  
N32 021  
002 33 R88 R65  
R54 0 R83  
R54 - R81  
R54 / R79  
R55 0 R84  
R55 - R82  
R54 . R70  
R55 . R70  
R85 . R70  
R86 . R70  
R65 1  
002 29 R87 R65  
G01 G91 XR54 ZR55  
000 30  
N29 GR87 G91 XR54 ZR55 IR65 KR66  
N30 002 -32 R65 R88  
N33 G0 G90 091 R75  
001 31 R70 R65  
000 - R50  
N20 R50 - R62  
R51 - R63  
R70 100 R71 1  
R70 . R20  
R70 R71  
G0 G90 XR50 ZR51  
G1 XR21 ZR22 GR73 LR70  
N31 G00 G90 XR56 ZR57 G40  
N70 M17  
M02

6.2 Drilling cycles 8M/8MC/Sprint 8MDrilling cycles 8M/8MC/Sprint 8M drilling axis: Z

```

% SP
L8100(22.04.82[Z])
G G60 G90 ZR02 ;rapid traverse to reference plane
G1 ZR03 ;drilling to depth
G ZR02 M17 ;rapid traverse back
L8200 G G60 G90 ZR02 ;rapid traverse to reference plane
G1 ZR03 ;drilling to depth
G4 FR04 ;dwell at depth
G ZR02 M17 ;rapid traverse back
L8300 @25 R63 @ R02 R64 @ R01 R65 @ R67 2
R63 - R03 ;start conditions
R67 . R05 ;R67 = 2* degression
G G60 G90 ZR02 ;movement to reference plane
N3 R63 - R64 R62 @ R03 ;R63 = difference to drilling depth
@03 4 R65 R63 ;end crit. R63 <=0
R62 R63 ;R62 = absolute drilling depth
G1 ZR62
G4 FR04
G ZR02
G4 FR00
R62 R78
ZR62 - R78 ;movement to safety distance
@03 4 R05 R63 ;R63 <=degress. => end
R64 - R05
@02 -3 R64 R05 ;calculation next delivery
R64 @ R05
@03 -3 R63 R67 ;half delivery necessary?
R64 @ R63 R62 2
R64 / R62 ;half delivery
@00 -3
N4 G1 ZR03 ;movement to drilling depth
G4 FR04 ;dwell
G ZR02 M17 ;reference plane and basic position
L8400 G G60 G90 ZR02 ;rapid traverse to reference plane
G1 G63 ZR03 ;thread drilling to depth G63
MR06 ;spindle reversal
ZR02 ;back by G63
G G60 MR07 M17 ;basic position
L8500 G G60 G90 ZR02 ;rapid traverse to reference plane
G1 ZR03 ;drilling to depth
G ZR10 M17 ;rapid traverse back to retract. R10
L8600 MR07 ;spindle direction R07
G G60 G90 ZR02 ;rapid traverse to reference plane
G1 ZR03 ;drilling to depth
M5 ;spindle stop
G ZR10 M17 ;rapid traverse back to retract. R10

```

```
L8700 MR07 ;spindle direction R07
G G60 G90 ZR02 ;rapid traverse to reference plane
G1 ZR03 ;drilling to depth
M M5 ;spindle stop and program stop M00
G ZR02 M17 ;rapid traverse back to refer. plane
L8800 MR07 ;spindle direction R07
G G60 G90 ZR02 ;rapid traverse to reference plane
G1 ZR03 ;drilling to depth
G4 FR04 ;dwell before spindle stop
M M5 ;spindle stop and program stop
G ZR02 M17 ;rapid traverse back to refer. plane
L8900 G G60 G90 ZR02 ;rapid traverse to refer. plane
G1 ZR03 ;drilling to depth
G4 FR04 ;dwell
ZR02 ;back by advance feed
G M17
L9000 G G60 G90 ZR02 ;rapid traverse to reference plane
G33 ZR03 KR09 ;thread drilling to depth G33
ZR02 KR09 MR06 ;spindle reversal, back by G33
G MR07 M17 ;basic position
L99900
@31 M17 ;empty intermediate store
M02
```

German text drilling cycles 8M/8MC/Sprint 8M drilling axis: Z

& L081(BOHR ZENTR.)  
R02 -5.3(REFERENZEB.)  
R03 -5.3(BOHRTIEFE)  
M17  
& L082(BOHR PLSENK.)  
R02 -5.3(REFERENZEB.)  
R03 -5.3(BOHRTIEFE)  
R04 2.3(SPANBRECHEN)  
M17  
& L083(TIEFBOHREN)  
R00 2.3(ENTSPANZEIT)  
R01 3.3(1.BOHRTIEFE)  
R02 -5.3(REFERENZEB.)  
R03 -5.3(ENDBOHRTIEFE)  
R04 3.3(SPANBRECHEN)  
R05 3.3(DEGRESSION)  
M17  
& L084(GEWINDE G63)  
R02 -5.3(REFERENZEB.)  
R03 -5.3(BOHRTIEFE)  
R06 2.0(SPINDELMK.)  
R07 2.0(ALTE SPINRI.)  
M17  
& L085(AUSBOHREN 1)  
R02 -5.3(REFERENZEB.)  
R03 -5.3(BOHRTIEFE)  
R10 -5.3(RUECKZUGER.)  
M17  
& L086(AUSBOHREN 2)  
R02 -5.3(REFERENZEB.)  
R03 -5.3(BOHRTIEFE)  
R10 -5.3(RUECKZUGER.)  
M17  
& L087(AUSBOHREN 3)  
R02 -5.3(REFERENZEB.)  
R03 -5.3(BOHRTIEFE)  
R07 2.0(SPINDEL FIN)  
M17

& L088(AUSBOHREN 4)  
R02 -5.3(REFERENZEB.)  
R03 -5.3(BOHRTIEFE)  
R04 2.3(VERWEILZEIT)  
R07 2.0(SPINDEL EIN)  
M17

& L089(AUSBOHREN 5)  
R02 -5.3(REFERENZEB.)  
R03 -5.3(BOHRTIEFE)  
R04 2.3(SPANBRECHEN)  
M17

& L090(GEWINDE G33)  
R02 -5.3(REFERENZEB.)  
R03 -5.3(BOHRTIEFE)  
R06 2.0(SPINDELUMK.)  
R07 2.0(ALTE SPINRI.)  
R09 4.3(STEIGUNG)  
M17  
M02

English text drilling cycles 8M/8MC/Sprint 8M drilling axis: Z

```
& LO81(DRILL.CENTR.)
RO2 -5.3(EXIT PLANE)
RO3*-5.3(DEPTH)
M17
& LO82(DRILL.SINK)
RO2 -5.3(EXIT PLANE)
RO3 -5.3(DEPTH)
RO4 2.3(BREAK CHIPS)
M17
& LO83(DEEP HOLE DR)
RO0 2.3(DWELL)
RO1 3.3(1. DEPTH)
RO2 -5.3(EXIT PLANE)
RO3 -5.3(FINAL DEPTH)
RO4 3.3(BREAK CHIPS)
RO5 3.3(DEGRESSION)
M17
& LO84(THREAD G63)
RO2 -5.3(EXIT PLANE)
RO3 -5.3(DEPTH)
RO6 2.0(REV.SPIN.DIR)
RO7 2.0(ORG.SPIN.DIR)
M17
& LO85(DRILLING 1)
RO2 -5.3(EXIT PLANE)
RO3 -5.3(DEPTH)
R10 -5.3(RETRACT PL.)
M17
& LO86(DRILLING 2)
RO2 -5.3(EXIT PLANE)
RO3 -5.3(DEPTH)
R10 -5.3(RETRACT PLANE)
M17
& LO87(DRILLING 3)
RO2 -5.3(EXIT PLANE)
RO3 -5.3(DEPTH)
RO7 2.0(SPINDLE ON)
M17
```



& LO88(DRILLING 4)  
R02 -5.3(EXIT PLANE)  
R03 -5.3(DEPTH)  
R04 2.3(DWELL)  
R07 2.0(SPINDLE ON)  
M17

& LO89(DRILLING 5)  
R02 -5.3(EXIT PLANE)  
R03 -5.3(DEPTH)  
R04 2.3(BREAK CHIPS)  
M17

& LO90(THREAD G33)  
R02 -5.3(EXIT PLANE)  
R03 -5.3(DEPTH)  
R06 2.0(REV.SPIN.DIR)  
R07 2.0(ORG.SPIN.DIR)  
R09 4.3(PITCH)  
M17  
M02

French text drilling cycles 8M/8MC/Sprint 8M drilling axis: Z

& L081(PERC.CENTRA.)  
RD2 -5.3(PLAN DE REF.)  
RD3 -5.3(PROF.PERC.)  
M17

& L082(PERC.LAMAGE)  
RD2 -5.3(PLAN DE REF.)  
RD3 -5.3(PROF.PERC.)  
RD4 2.3(BRISAGE COP.)  
M17

& L083(PERCAGE PROF)  
RD0 2.3(TEMPS DECOP.)  
RD1 3.3(1.PROF.PERC.)  
RD2 -5.3(PLAN DE REF.)  
RD3 -5.3(PROF.FINALE)  
RD4 3.3(BISAGE COP.)  
RD5 3.3(DEGRESSION)  
M17

& L084(FILETAGE G63)  
RD2 -5.3(PLAN DE REF.)  
RD3 -5.3(PROF.PERC.)  
RD6 2.0(INV.DIR.BRO.)  
RD7 2.0(ANC.DIR.BRO.)  
M17

& L085(ALESAGE 1)  
RD2 -5.3(PLAN DE REF.)  
RD3 -5.3(PROF.PERC.)  
R10 -5.3(PLAN RETRAIT)  
M17

& L086(ALESAGE 2)  
RD2 -5.3(PLAN DE REF.)  
RD3 -5.3(PROF.PERC.)  
R10 -5.3(PLAN RETRAIT)  
M17

& L087(ALESAGE 3)  
RD2 -5.3(PLAN DE REF.)  
RD3 -5.3(PROF.PERC.)  
RD7 2.0(MARCHE BRO.)  
M17

& L088(ALESAGE 4)  
R02 -5.3(PLAN DE REF.)  
R03 -5.3(PROF.PERC.)  
R04 2.3(TPS.ATTENTE)  
R07 2.0(MARCHE BRO.)  
M17

& L089(ALESAGE 5)  
R02 -5.3(PLAN DE REF.)  
R03 -5.3(PROF.PERC.)  
R04 2.3(BRISAGE COP.)  
M17

& L090(FILETAGE G33)  
R02 -5.3(PLAN DE REF.)  
R03 -5.3(PROF.PERC.)  
R06 2.0(INV.DIR.BRO.)  
R07 2.0(ANC.DIR.BRO.)  
R09 4.3(PAS DE FILET)  
M17  
M02

Italian text drilling cycles 8M/8MC/Sprint 8M drilling axis: Z

Under preparation!



Drilling cycles 8M/8MC/Sprint 8M drilling axis: variable

```

% SP
L8100(15. 04. 82[VAR. ]R77 0 R59 0
@25
@00 R77
N0 R59 87
N1 R59 R11 ;address parameter depending on
@20 @92 R59 ;software edition
G G60 G90 @92 R02 ;rapid traverse to reference plane
G1 @92 R03 ;drilling to depth
G @92 R02 M17 ;rapid traverse retraction
L8200 R77 0 R59 0
@25
@00 R77
N0 R59 87
N1 R59 R11
@20 @92 R59
G G60 G90 @92 R02 ;rapid traverse to reference plane
G1 @92 R03 ;drilling to depth
G4 FR04 ;dwell in depth
G @92 R02 M17 ;rapid traverse retraction
L8300 R59 0 R77 0 R65 0 R67 2 ;start preparations
@25 R64 0 R01 R63 0 R02 R66 1
@00 R77
N0 R59 87
N1 R59 R11
@20 @92 R59
R67 . R05 ;R67 = 2* degression
R63 - R03
@03 2 R63 R65 ;drilling direction check
R66 -1 ;R66 = sign
N2 R63 . R66
R78 . R66
G G60 G90 @92 R02 ;move to reference plane
N3 R63 - R64
@03 4 R65 R63 ;end crit. R63 = 0
R63 . R66 R62 0 R03
R62 R63 ;R62 = absolute drilling depth
G1 @92 R62
G4 FR04
G @92 R02
G4 FR00
R62 R78 ;move to safety
@92 R62 - R78 ;for next drilling
R63 . R66
@03 4 R05 R63 ;R63 = degress. end
R64 - R05
@02 -3 R64 R05 ;calculate next delivery
R64 0 R05
@03 -3 R63 R67 ;half delivery required?
R64 0 R63 R62 2
R64 / R62 ;half delivery
@00 -3
N4 G1 @92 R03 ;last delivery drilling
G4 FR04
G @92 R02 M17 ;end

```

L8400 R77 0 R59 0  
@25

@00 R77

N0 R59 87

N1 R59 R11

@20 @92 R59

G G60 G90 @92 R02

G1 G63 @92 R03

MR06

@92 R02

G G60 MR07 M17

L8500 R77 0 R59 0  
@25

@00 R77

N0 R59 87

N1 R59 R11

@20 @92 R59

G G60 G90 @92 R02

G1 @92 R03

G @92 R10 M17

L8600 R77 0 R59 0  
@25

@00 R77

N0 R59 87

N1 R59 R11

@20 @92 R59

MR07

G G60 G90 @92 R02

G1 @92 R03

M5

G @92 R10 M17

L8700 R77 0 R59 0  
@25

@00 R77

N0 R59 87

N1 R59 R11

@20 @92 R59

MR07

G G60 G90 @92 R02

G1 @92 R03

M M5

G @92 R02 M17

;rapid traverse to reference plane

;thread drilling to depth G63

;spindle reversal

;back by G63

;basic position

;rapid traverse to reference plane

;drilling to depth

;rapid traverse back to retraction R10

;spindle direction R07

;rapid traverse to reference plane

;drilling to depth

;spindle stop

;rapid traverse back to retraction R10

;spindle direction R07

;rapid traverse to reference plane

;drilling to depth

;spindle stop and program stop M00

;rapid traverse back to reference plane

L8800 R77 0 R59 0  
@25

@00 R77

N0 R59 87

N1 R59 R11

@20 @92 R59

MR07

G G60 G90 @92 R02

G1 @92 R03

G4 FR04

M M5

G @92 R02 M17

L8900 R77 0 R59 0

@25

@00 R77

N0 R59 87

N1 R59 R11

@20 @92 R59

G G60 G90 @92 R02

G1 @92 R03

G4 FR04

@92 R02

G M17

L9000 R77 0 R59 0

@25

@00 R77

N0 R59 87

N1 R59 R11 R77 3

@20 @92 R59

G G60 G90 @92 R02

@02 3 R11 R77

@00 R11

N1 G33 @92 R03 IR09

@92 R02 IR09 MR06

@00 5

N2 G33 @92 R03 JR09

@92 R02 JR09 MR06

@00 5

N3 G33 @92 R03 KR09

@92 R02 KR09 MR06

N5 G MR07 M17

L99900

@31 M17

M02

;spindle direction R07

;rapid traverse to reference plane

;drilling to depth

;dwell before spindle stop

;spindle stop and program stop

;rapid traverse back to ref. plane

;rapid traverse ref. plane

;drilling to depth

;dwell

;advance feed back

;basic position

;rapid traverse to ref. plane

;thread drilling to depth G33

;spindle reversal, back by G33

;basic position

;empty intermediate store



German text drilling cycles 8M/8MC/Sprint 8M drilling axis: variable

& L081(BOHR ZENTR.)  
R02 -5.3(REFERENZEB.)  
R03 -5.3(BOHRTIEFE)  
R11 2.0(ACHSNUMMER)  
M17  
& L082(BOHR PLSENK.)  
R02 -5.3(REFERENZEB.)  
R03 -5.3(BOHRTIEFE)  
R04 2.3(SPANBRECHEN)  
R11 2.0(ACHSNUMMER)  
M17  
& L083(TIEFBOHREN)  
R00 2.3(ENTSPANZEIT)  
R01 3.3(1.BOHRTIEFE)  
R02 -5.3(REFERENZEB.)  
R03 -5.3(ENDBOHRTIEFE)  
R04 3.3(SPANBRECHEN)  
R05 3.3(DEGRESSION)  
R11 2.0(ACHSNUMMER)  
M17  
& L084(GEWINDE G63)  
R02 -5.3(REFERENZEB.)  
R03 -5.3(BOHRTIEFE)  
R06 2.0(SPINDELUMK.)  
R07 2.0(ALTE SPINRI.)  
R11 2.0(ACHSNUMMER)  
M17  
& L085(AUSBOHREN 1)  
R02 -5.3(REFERENZEB.)  
R03 -5.3(BOHRTIEFE)  
R10 -5.3(RUECKZUGEB.)  
R11 2.0(ACHSNUMMER)  
M17  
& L086(AUSBOHREN 2)  
R02 -5.3(REFERENZEB.)  
R03 -5.3(BOHRTIEFE)  
R10 -5.3(RUECKZUGEB.)  
R11 2.0(ACHSNUMMER)  
M17  
& L087(AUSBOHREN 3)  
R02 -5.3(REFERENZEB.)  
R03 -5.3(BOHRTIEFE)  
R07 2.0(SPINDEL EIN)  
R11 2.0(ACHSNUMMER)  
M17

& L088 (AUSBOHREN 4)  
R02 -5.3 (REFERENZEB.)  
R03 -5.3 (BOHRTIEFE)  
R04 2.3 (VERWEILZEIT)  
R07 2.0 (SPINDEL EIN)  
R11\* 2.0 (ACHSNUMMER)  
M17

& L089 (AUSBOHREN 5)  
R02 -5.3 (REFERENZEB.)  
R03 -5.3 (BOHRTIEFE)  
R04 2.3 (SPANBRECHEN)  
R11 2.0 (ACHSNUMMER)  
M17

& L090 (GEWINDE G33)  
R02 -5.3 (REFERENZEB.)  
R03 -5.3 (BOHRTIEFE)  
R06 2.0 (SPINDELUMK.)  
R07 2.0 (ALTE SPINRI.)  
R09 4.3 (STEIGUNG)  
R11 2.0 (ACHSNUMMER)  
M17  
M02

English text drilling cycles 8M/8MC/Sprint 8M drilling axis: variable

& LOB1(DRILL.CENTR.)  
RO2 -5.3(EXIT PLANE)  
RO3 -5.3(DEPTH)  
R11 2.0(AXIS NO.)  
M17

& LOB2(DRILL.SINK)  
RO2 -5.3(EXIT PLANE)  
RO3 -5.3(DEPTH)  
RO4 2.3(BREAK CHIPS)  
R11 2.0(AXIS NO.)  
M17

& LOB3(DEEP HOLE DR)  
RO0 2.3(DWELL)  
RO1 3.3(1. DEPTH)  
RO2 -5.3(EXIT PLANE)  
RO3 -5.3(FINAL DEPTH)  
RO4 3.3(BREAK CHIPS)  
RO5 3.3(DEGRESSION)  
R11 2.0(AXIS NO.)  
M17

& LOB4(THREAD G63)  
RO2 -5.3(EXIT PLANE)  
RO3 -5.3(DEPTH)  
RO6 2.0(REV.SPIN.DIR)  
RO7 2.0(ORG.SPIN.DIR)  
R11 2.0(AXIS NO.)  
M17

& LOB5(DRILLING 1)  
RO2 -5.3(EXIT PLANE)  
RO3 -5.3(DEPTH)  
R10 -5.3(RETRACT PL.)  
R11 2.0(AXIS NO.)  
M17

& LOB6(DRILLING 2)  
RO2 -5.3(EXIT PLANE)  
RO3 -5.3(DEPTH)  
R10 -5.3(RETRACT PLANE)  
R11 2.0(AXIS NO.)  
M17

& LOB7(DRILLING 3)  
RO2 -5.3(EXIT PLANE)  
RO3 -5.3(DEPTH)  
RO7 2.0(SPINDLE ON)  
R11 2.0(AXIS NO.)  
M17

& L088(DRILLING 4)  
R02 -5.3(EXIT PLANE)  
R03 -5.3(DEPTH)  
R04 2.3(DWELL)  
R07 2.0(SPINDLE ON)  
R11 2.0(AXIS NO.)  
M17  
& L089(DRILLING 5)  
R02 -5.3(EXIT PLANE)  
R03 -5.3(DEPTH)  
R04 2.3(BREAK CHIPS)  
R11 2.0(AXIS NO.)  
M17  
& L090(THREAD G33)  
R02 -5.3(EXIT PLANE)  
R03 -5.3(DEPTH)  
R06 2.0(REV.SPIN.DIR)  
R07 2.0(ORG.SPIN.DIR)  
R09 4.3(PITCH)  
R11 2.0(AXIS NO.)  
M17  
M02

French text drilling cycles 8M/8MC/Sprint 8M drilling axis: variable

& L081(PERC.CENTRA.)  
R02 -5.3(PLAN DE REF.)  
R03 -5.3(PROF.PERC.)  
R11 2.0(NUMERO AXE)  
M17

& L082(PERC.LAMAGE)  
R02 -5.3(PLAN DE REF.)  
R03 -5.3(PROF.PERC.)  
R04 2.3(BRISAGE COP.)  
R11 2.0(NUMERO AXE)  
M17

& L083(PERCAGE PROF)  
R00 2.3(TEMPS DEGOP.)  
R01 3.3(1.PROF.PERC.)  
R02 -5.3(PLAN DE REF.)  
R03 -5.3(PROF.FINALE)  
R04 3.3(BISAGE COP.)  
R05 3.3(DEGRESSION)  
R11 2.0(NUMERO AXE)  
M17

& L084(FILETAGE G63)  
R02 -5.3(PLAN DE REF.)  
R03 -5.3(PROF.PERC.)  
R06 2.0(INV.DIR.BRO.)  
R07 2.0(ANC.DIR.BRO.)  
R11 2.0(NUMERO AXE)  
M17

& L085(ALESAGE 1)  
R02 -5.3(PLAN DE REF.)  
R03 -5.3(PROF.PERC.)  
R10 -5.3(PLAN RETRAIT)  
R11 2.0(NUMERO AXE)  
M17

& L086(ALESAGE 2)  
R02 -5.3(PLAN DE REF.)  
R03 -5.3(PROF.PERC.)  
R10 -5.3(PLAN RETRAIT)  
R11 2.0(NUMERO AXE)  
M17

& L087(ALESAGE 3)  
R02 -5.3(PLAN DE REF.)  
R03 -5.3(PROF.PERC.)  
R07 2.0(MARCHE BRO.)  
R11 2.0(NUMERO AXE)  
M17

& LD88(ALESAGE 4)  
RD2 -5.3(PLAN DE REF.)  
RD3 -5.3(PROF.PERC.)  
RD4 2.3(TPS.ATTENTE)  
RD7 2.0(MARCHE BRO.)  
R11 2.0(NUMERO AXE)

M17

& LD89(ALESAGE 5)  
RD2 -5.3(PLAN DE REF.)  
RD3 -5.3(PROF.PERC.)  
RD4 2.3(BRISAGE COP.)  
R11 2.0(NUMERO AXE)

M17

& LD90(FILETAGE G33)  
RD2 -5.3(PLAN DE REF.)  
RD3 -5.3(PROF.PERC.)  
RD6 2.0(INV.DIR.BRO.)  
RD7 2.0(ANC.DIR.BRO.)  
RD9 4.3(PAS DE FILET)  
R11 2.0(NUMERO AXE)

M17

MD2

Italian text drilling cycles 8M/8MC/Sprint 8M drilling axis: variable

Under preparation!





6.3 Drilling and milling patterns Sprint 8M

```

% SP
L90000(20.04.82 [03] SP 8M) ; start conditions
R62 0 R02 R50 360 R52 0 R53 1 025
R62 - R03 R85 0 R78 ;and load of aux. parameters
002 0 R62 R52 ;drilling direction evaluation
R85 0 -R78
N0 003 5 R53 R78 ;check with/without DP
R50 360000000 ;load without DP R50=360 degrees
N5 R50 / R27 ;angular step = 0? N6
001 6 R26 R52 ;start angle at R51
R50 0 R26 ;R11 =drilling axis
N6 R51 0 R25 ;address parameter loading
000 R11 ;depending on drilling axis
N1 020 090 2
020 091 3
000 7
N2 020 090 3
020 091 1
000 7
N4
N3 020 090 1
020 091 2
N7 020 092 R11
N8 G10 G90 090 R22 091 R23 FR24 AR51 GR28
;approach drill pos., drill by GR28
G80 G91 092 R85 ;back to safety distance
R51 R50 ;actual angle + angular step
R52 R53 ;increment counter for drilling
002 -8 R27 R52 ;compare counter drilling number
G90 M17 ;end

```

```

L90100 R50 360 R52 0 R53 1 R85 1 @25
;start conditions
;check with/without DP

@03 5 R53 R78
R85 100000
R50 R85
;load without DP. R50=360 degrees
;360 degrees : number of drillings
N5 R50 / R27
;angular step = 0? N6
@01 6 R26 R52
R50 0 R26
;angular step in R50
N6 R51 0 R25
;start angle at R51
N8 R51 / R85
;change R51 in degrees
R71 90 R51 R72 0 R51 R54 360
;aux. param. for SIN, COS
R51 R85
;change back R51
N9 @03 10 R54 R72
;if angle for SIN >=360,
R72 - R54
;then R72 - 360
N10 @03 11 R54 R71
;COS
R71 - R54
@00 -9
;repeat
N11 @15 R71
;R71 = COS R51
@15 R72
;R72 = SIN R51
R60 0 R02
;R60 drilling depth
R60 - R03 R66 0 R12 R70 2
;R66 0.5*groove width
R66 / R70 R56 0 R24
;R56 radius + 0.5 groove width
R56 R66 R67 0 R66
;R67 0.5 groove width *SIN R51
R67 R72 R68 0 R66
;R68 0.5 groove width *COS R51
R68 R71 R62 0 R67
;R62 = R67 - R68
R62 - R68 R63 0 R67
;R63 = R67 +R68
R63 R68 R64 2
;R64 = 2*R68
R64 R68 R65 2
;R65 = 2*R67
R65 R67 R76 0 R13
;R76 groove length - groove width
R76 - R12 R75 0 R76
;R75 = R76 *COS R51
R75 R71
;R76 = R76 *SIN R51
R76 R72 R81 9 R84 10
;R81,R82,R83 = 0.9 *R62,R63,R66
R81 / R84 R82 0 R81 R83 0 R81
R81 R62
R82 R63
R83 R66
G10 G17 G60 G90 XR22 YR23 AR51 PR56
;start pos. groove

R02 R78
G ZR02 - R78
;reference plane + safety
N12 R69 0 R03 R70 0
;N12,N13,N14 depending on
@03 14 R01 R60
;depth delivery crit.
R60 - R01 R70 2
;calculate milling depth
@03 13 R60 R01
R60 R01
R60 / R70
N13 R69 R60

```

```
N14 G1 ZR69 ;move to milling depth
G41 G91 XR68 YR67 ;CRC selection
G3 G64 X R62 Y- R63 P-R66 ;groove milling in cont. path oper.
G1 XR75 YR76
G3 X- R65 YR64 PR66
G1 X- R75 Y- R76
G3 G60 XR81 Y- R82 PR83 ;tangential departure
G11 G40 G90 AR51 PR56 ;cancel CRC
@03 -12 R70 R53 ;groove end?
R02 R78
G ZR02 -R78 ;reference plane + safety
R51 R50 ;next angle
R52 R53 ;increment counter
@02 -8 R27 R52 ;all grooves milled?
.M17 ;end
```

```

L90200 R60 0 R02 R50 360 R52 0 R53 1
R60 - R03 R85 1 R86 1 @25 ;start conditions
@02 0 R60 R52 ;and load aux. param.
R86 -1 ;calculation of milling direction
N0 @03 5 R53 R78 ;check with/without DP.
R85 100000
R50 . R85 ;load without DP.R50=360 degrees
N5 R50 / R27 ;360 degrees ; number of drillings
@01 6 R26 R52 ;angular step = 0? N6
R50 0 R26 ;angular step at R50
N6 R51 0 R25 ;allocate address par. to
@00 R11 ;axes
N1 @20 @90 2
@20 @91 3
G19
@00 7
N2 @20 @90 3
@20 @91 1
G18
@00 7
N4
N3 @20 @90 1
@20 @91 2
G17
N7 @20 @92 R11
R78 R86 ;safety sign
N8 R51 / R85 ;change R51 in degrees
R71 90 R51 R72 0 R51 R54 360 ;aux. par. for SIN , COS
R51 R85 ;change back R51
N9 @03 10 R54 R72 ;if angle for SIN >=360,
R72 - R54 ;then R72 - 360
N10 @03 11 R54 R71 ;COS
R71 - R54
@00 -9 ;repeat

```

```

N11 @15 R71 ;R71 = C05 R51
@15 R72 ;R72 = SIN R51
R60 @ R02
R60 - R03 R66 @ R12 R70 2 ;R60 drilling depth
R66 / R70 R56 @ R24 ;R66 0.5*
R56 R66 R67 @ R66 ;R56 radius + 0.5 groove width
R67 . R72 R68 @ R66 ;R67 0.5 groove width *SIN R51
R68 . R71 R62 @ R67 ;R68 0.5 groove width *COS R51
R62 - R68 R63 @ R67 ;R62 = R67 - R68
R63 R69 R64 2 ;R63 = R67 + R68
R64 . R68 R65 2 ;R64 = 2*R68
R65 . R67 R76 @ R13 ;R65 = 2*R67
R76 - R12 R75 @ R76 ;R76 groove length - groove width
R75 . R71 ;R75 = R76 *COS R51
R76 . R72 R81 9 R84 10 ;R76 = R76 *SIN R51
R81 / R84 R82 @ R81 R83 @ R81
R81 . R62 ;R81, R82, R83 = 0.9 *R62, R63, R66
R82 . R63
R83 . R66
G10 G60 G90 @90 R22 @91 R23 AR51 PR56
;start pos. groove
R02 R78
G @92 R02 - R78 ;reference plane + safety
N12 R60 . R86 R69 @ R03 R70 @ ;N12, N13, N14 depending on
@03 14 R01 R60 ;depth delivery crit.
R60 - R01 R70 2 ;calculate milling depth
@03 13 R60 R01
R60 R01
R60 / R70
N13 R60 . R86
R69 R60
N14 G1 @92 R69 ;move to milling depth
G41 G91 @90 R68 @91 R67 ;selection CRC
G3 G64 @90 R62 @91 - R63 P-R66 ;groove milling in cont. path oper.
G1 @90 R75 @91 R76
G3 @90 - R65 @91 R64 PR66
G1 @90 - R75 @91 - R76
G3 G60 @90 R81 @91 - R82 PR83 ;tangential departure
G11 G40 G90 AR51 PR56 ;cancel CRC
@03 -12 R70 R53 ;end of a groove?
R02 R78
G @92 R02 -R78 ;reference plane + safety
R51 R50 ;next angle
R52 R53 ;increment counter
@02 -8 R27 R52 ;all grooves milled?
M17 ;end

```

```

L90300 R50 360 R52 0 R53 1 @25 . ;start conditions
@03 5 R53 R78 ;check with/without DP
R50 36000000 ;load without DP.R50=360 degrees
N5 R50 / R27 ;360 degrees: number of drillings
@01 6 R26 R52 ;angular step = 0? N6
R50 0 R26 ;angular step at R50
N6 R51 0 R25 ;start angle at R51
R56 0 R12 R70 2 ;R56 0.5*tool diameter + radius
R56 / R70 R57 0 -R56
R56 R24 ;R57 radius tool radius + hole length
R57 R24
R57 R13
N8 R60 0 R02 R55 -1 ;load aux. parameters
R60 - R03 ;Incr. R60 milling depth
G10 G60 G90 XR22 YR23 AR51 PR56 ;move to milling position
R02 R78
G ZR02 - R78 ;reference plane + safety
N9 R69 0 R03 R70 -2 ;N9, N10
@03 11 R01 R60 ;calculate milling depth
R60 - R01 R70 2
@03 10 R60 R01
R60 R01
R60 /R70
N10 R69 R60
N11 G1 ZR69 ;move to milling depth
@00 14 R53 ;jump to N13 or N15
N13 G11 AR51 PR56 ;inner side oblong hole
@00 16
N15 G11 AR51 PR57 ;outer side oblong hole
N16 R53 . R55 ;R53 = R53 *(-1)
@03 -9 R70 R53 ;end crit. of oblong hole
R02 R78
G ZR02 - R78 ;reference plane + safety
R51 R50 R53 1 ;next angle
R52 R53 ;increment counter
@02 -8 R27 R52 ;all oblong holes finished?
M17 ;end

```

```

L90400 R60 0 R02 R50 360 R52 0 R53 1
;start conditions
R60 - R03 R86 1 @25 ;and load aux. parameters
@02 0 R60 R52 ;calculation milling direction
R86 -1
N0 @03 5 R53 R78 ;check with/without DP
R50 36000000 ;load without DP.R50=360 degrees
N5 R50 / R27 ;360 degrees : number of drillings
@01 6 R26 R52 ;angular step = 0? N6
R50 0 R26 ;angular step at R50
N6 R51 0 R25 ;start angle at R51
@00 R11 ;R11 is drilling axis
N1 @20 @90 2 ;load address parameter
@20 @91 3 ;depending on drilling axis
@00 7
N2 @20 @90 3
@20 @91 1
@00 7
N4
N3 @20 @90 1
@20 @91 2
N7 @20 @92 R11
R78 . R86 R56 0 R12 R70 2
R56 / R70 R57 0 -R56 ;R56 0.5*tool diameter + radius
R56 R24
R57 R24 ;R57 radius tool radius + hole length
R57 R13
N8 R60 0 R02 R55 -1 ;load aux. parameters
R60 - R03 ;incr. R60 milling depth
G10 G60 G90 @90 R22 @91 R23 AR51PR56 ;move to milling position
R02 R78
G @92 R02 - R78 ;reference plane + safety
N9 R60 . R86 R69 0 R03 R70 -2 ;N9, N10
@03 11 R01 R60 ;calculate milling depth
R60 - R01 R70 2
@03 10 R60 R01
R60 R01
R60 / R70
N10 R60 . R86
R69 R60
N11 G1 @92 R69 ;move to milling depth
@00 14 R53 ;jump to N12 or N15
N13 G11 AR51 PR56 ;inner side oblong hole
@00 16
N15 G11 AR51 PR57 ;outer side oblong hole
N16 R53 R55 ;R53 = R53 *(-1)
@03 -9 R70 R53 ;end crit. of oblong hole
R02 R78
G @92 R02 - R78 ;reference plane + safety
R51 R50 R53 1 ;next angle
R52 R53 ;increment counter
@02 -8 R27 R52 ;all oblong holes finished?
M17 ;end

```

```
L90500 R50 360 R52 0 R53 1 @25 ;start conditions
@03 5 R53 R78 ;check with/without DP
R50 36000000 ;load without DP R50=360 degrees
N5 R50 / R27 ;360 degrees : number of drillings
@01 6 R26 R52 ;angular step = 0? N6
R50 0 R26 ;angular step at R50
N6 R51 0 R25 ;start angle at R51
N8 G10 G90 XR22 YR23 PR24 AR51 GR28 ;move to drilling pos., drill. by GR28
G80 G91 ZR78 ;back to safety distance
R51 R50 ;act. angle + angular step
R52 R53 ;increment counter for drilling
@02 -8 R27 R52 ;compare counter
G90 M17 ;end
M02
```



German text drilling and milling patterns Sprint 8M

## &amp; L900(BOHRBILD)

R1 2.0(ACHSNUMMER)  
R22 -5.3(MP ACHSE 1)  
R23 -5.3(MP ACHSE 2)  
R24 4.3(RADIUS)  
R25 3.5(STARTWINKEL)  
R26 3.5(TEILWINKEL)  
R27 3.0(BOHRANZAHL)  
R28 3.0(NR.BOHRZYK.)  
M17

## &amp; L901(FRAESBLD NUT)

R01 -2.3(ZUSTELLTIEFE)  
R02 -5.3(REFERENZEB.)  
R03 -5.3(NUTTIEFE)  
R22 -5.3(MP ACHSE 1)  
R23 -5.3(MP ACHSE 2)  
R24 4.3(RADIUS)  
R25 3.5(STARTWINKEL)  
R26 3.5(TEILWINKEL)  
R27 3.0(NUT ANZAHL)  
R12 4.3(NUTBREITE)  
R13 4.3(NUTLAENGE)  
M17

## &amp; L902(FRAESBLD NUT)

R01 -2.3(ZUSTELLTIEFE)  
R02 -5.3(REFERENZEB.)  
R03 -5.3(NUTTIEFE)  
R11 2.0(ACHSNUMMER)  
R22 -5.3(MP ACHSE 1)  
R23 -5.3(MP ACHSE 2)  
R24 4.3(RADIUS)  
R25 3.5(STARTWINKEL)  
R26 3.5(TEILWINKEL)  
R27 3.0(NUT ANZAHL)  
R12 4.3(NUTBREITE)  
R13 4.3(NUTLAENGE)  
M17

## &amp; L903(LANGLOCH)

R01 -2.3(ZUSTELLTIEFE)  
R02 -5.3(REFERENZEB.)  
R03 -5.3(NUTTIEFE)  
R22 -5.3(MP ACHSE 1)  
R23 -5.3(MP ACHSE 2)  
R24 4.3(RADIUS)  
R25 3.5(STARTWINKEL)  
R26 3.5(TEILWINKEL)  
R27 3.0(LOCHANZAHL)  
R12 4.3(FRAESERDURCH)  
R13 4.3(LANGL.LAENGE)  
M17

& L904 (LANGLOCH)  
R01 -2.3 (ZUSTELLTIEFE)  
R02 -5.3 (REFERENZER.)  
R03 -5.3 (NUTTIEFE)  
R11 2.0 (ACHSNUMMER)  
R22 -5.3 (MP ACHSE 1)  
R23 -5.3 (MP ACHSE 2)  
R24 4.3 (RADIUS)  
R25 3.5 (STARTWINKEL)  
R26 3.5 (TEILWINKEL)  
R27 3.0 (LOCHANZAHL)  
R12 4.3 (FRAESERDURCH)  
R13 4.3 (LANGL.LAENGE)  
M17

& L905 (BOHRBILD)  
R22 -5.3 (MP ACHSE 1)  
R23 -5.3 (MP ACHSE 2)  
R24 4.3 (RADIUS)  
R25 3.5 (STARTWINKEL)  
R26 3.5 (TEILWINKEL)  
R27 3.0 (BOHRANZAHL)  
R28 3.0 (NR. BOHRZYK.)  
M17  
M02

English text drilling and milling patterns Sprint 6M

& L900(DRILL.PATERN)  
R11 2.0(Axis No.)  
R22 -5.3(CNTR.PT.1.AX)  
R23 -5.3(CNTR.PT.2.AX)  
R24 4.3(RADIUS)  
R25 3.5(START ANGLE)  
R26 3.5(PROGR. ANGLE)  
R27 3.0(NO. OF HOLES)  
R28 3.0(CYCLE NO.)  
M17  
& L901(MILL.GROOVE)  
R01 -2.3(DEPTH)  
R02 -5.3(EXIT PLANE)  
R03 -5.3(GROOVE DEPTH)  
R22 -5.3(CNTR.PT.1.AX)  
R23 -5.3(CNTR.PT.2.AX)  
R24 4.3(RADIUS)  
R25 3.5(START ANGLE)  
R26 3.5(PROGR. ANGLE)  
R27 3.0(NO. OF HOLES)  
R12 4.3(GROOVE WIDTH)  
R13 4.3(GROOVE LENG.)  
M17  
& L902(MILL.GROOVE)  
R01 -2.3(DEPTH)  
R02 -5.3(EXIT PLANE)  
R03 -5.3(GROOVE DEPTH)  
R11 2.0(Axis No.)  
R22 -5.3(CNTR.PT.1.AX)  
R23 -5.3(CNTR.PT.2.AX)  
R24 4.3(RADIUS)  
R25 3.5(START ANGLE)  
R26 3.5(PROGR. ANGLE)  
R27 3.0(NO. OF GROOVE)  
R12 4.3(GROOVE WIDTH)  
R13 4.3(GROOVE LENG.)  
M17  
& L903(SLOT)  
R01 -2.3(DEPTH)  
R02 -5.3(EXIT PLANE)  
R03 -5.3(GROOVE DEPTH)  
R22 -5.3(CNTR.PT.1.AX)  
R23 -5.3(CNTR.PT.2.AX)  
R24 4.3(RADIUS)  
R25 3.5(START ANGLE)  
R26 3.5(PROGR. ANGLE)  
R27 3.0(NO. OF HOLES)  
R12 4.3(GROOVE WIDTH)  
R13 4.3(GROOVE LENG.)  
M17

& L904(SLOT)  
R01 -2.3(DEPTH)  
R02 -5.3(EXIT PLANE)  
R03 -5.3(GROOVE DEPTH)  
R11 2.0(AXIS NO.)  
R22 -5.3(CNTR.PT.1.AX)  
R23 -5.3(CNTR.PT.2.AX)  
R24 4.3(RADIUS)  
R25 3.5(START ANGLE)  
R26 3.5(PROGR. ANGLE)  
R27 3.0(NO. OF HOLES)  
R12 4.3(CUTTER DIA.)  
R13 4.3(SLOT LENGTH)  
M17  
& L905(DRILL.PATTERN)  
R22 -5.3(CNTR.PT.1.AX)  
R23 -5.3(CNTR.PT.2.AX)  
R24 4.3(RADIUS)  
R25 3.5(START ANGLE)  
R26 3.5(PROGR. ANGLE)  
R27 3.0(NO. OF HOLES)  
R28 3.0(CYCLE NO.)  
M17  
M02

French text drilling and milling patterns Sprint 8M

& L900(TROU.REPARTI)

R14 2.0(NUMERO AXE)  
R22 -5.3(CENTRE AXE 1)  
R23 -5.3(CENTRE AXE 2)  
R24 4.3(RAYON)  
R25 3.5(ANGL.INITIAL)  
R26 3.5(ANGL.PARTIEL)  
R27 3.0(NBRE.PERC.)  
R28 3.0(NUMERO CYCLE)  
M17

& L901(RAIN.REPARTI)

RD1 -2.3(PROF.AVANCE)  
RD2 -5.3(PLAN DE REF.)  
RD3 -5.3(PROF.RAINURE)  
R22 -5.3(CENTRE AXE 1)  
R23 -5.3(CENTRE AXE 2)  
R24 4.3(RAYON)  
R25 3.5(ANGL.INITIAL)  
R26 3.5(ANGL.PARTIEL)  
R27 3.0(NBRE.RAINURE)  
R12 4.3(LARG.RAINURE)  
R13 4.3(LONG.RAINURE)  
M17

& L902(RAIN.REPARTI)

RD1 -2.3(PROF.AVANCE)  
RD2 -5.3(PLAN DE REF.)  
RD3 -5.3(PROF.RAINURE)  
R11 2.0(NUMERO AXE)  
R22 -5.3(CENTRE AXE 1)  
R23 -5.3(CENTRE AXE 2)  
R24 4.3(RAYON)  
R25 3.5(ANGL.INITIAL)  
R26 3.5(ANGL.PARTIEL)  
R27 3.0(NBRE.RAINURE)  
R12 4.3(LARG.RAINURE)  
R13 4.3(LONG.RAINURE)  
M17

& L903(MORTAISE)

RD1 -2.3(PROF.AVANCE)  
RD2 -5.3(PLAN DE REF.)  
RD3 -5.3(PROF.RAINURE)  
R22 -5.3(CENTRE AXE 1)  
R23 -5.3(CENTRE AXE 2)  
R24 4.3(RAYON)  
R25 3.5(ANGL.INITIAL)  
R26 3.5(ANGL.PARTIEL)  
R27 3.0(NBRE.TROUS)  
R12 4.3(DIAM.FRAISE)  
R13 4.3(LONG.MORTAI.)  
M17

## &amp; L904(MORTAISE)

R01 -2.3(PROF.AVANCE)  
R02 -5.3(PLAN DE REF.)  
R03 -5.3(PROF.RAINURE)  
R11 2.0(NUMERO AXE)  
R22 -5.3(CENTRE AXE 1)  
R23 -5.3(CENTRE AXE 2)  
R24 4.3(RAYON)  
R25 3.5(ANGL.INITIAL)  
R26 3.5(ANGL.PARTIEL)  
R27 3.0(NBRE.TROUS)  
R12 4.3(DIAM.FRAISE)  
R13 4.3(LONG.MORTAI)  
M17

## &amp; L905(TROU.REPARTI)

R22 -5.3(CENTRE AXE 1)  
R23 -5.3(CENTRE AXE 2)  
R24 4.3(RAYON)  
R25 3.5(ANGL.INITIAL)  
R26 3.5(ANGL.PARTIEL)  
R27 3.0(NBRE.PERC.)  
R28 3.0(NUMERO CYCLE)  
M17  
M02

Italian text drilling and milling patterns Sprint 8M

Under preparation!





6.4 Drilling and milling patterns 8M/8MC

```

% SP
L90000(20. 04. 82 [03] 8M,MC) ;start conditions
R62 0 R02 R50 360 R52 0 R53 1 @25 ;and load aux. parameters

R62 - R03 R85 0 R78
@02 0 R62 R52 ;drilling direction calculation
R85 0 -R78
N0 @03 5 R53 R78 ;check with/without DP
R50 36000000 ;load without DP R50=360 degrees
N5 R50 / R27 ;360 degrees: number of holes
@01 6 R26 R52 ;angular step = 0? N6
R50 0 R26 ;start angle at R51
N6 R51 0 R25 ;R11 = drilling axis
@00 R11 ;address parameters loading
N1 @20 @90 2 ;depending on drilling axis
@20 @91 3
@00 7
N2 @20 @90 3
@20 @91 1
@00 7
N4
N3 @20 @90 1
@20 @91 2
N7 @20 @92 R11
N8 G10 G90 @90 R22 @91 R23 PR24 AR51 GR28 ;move to drilling pos., drill. by GR28
G80 G91 @92 R85 ;back to safety distance
R51 R50 ;act. angle + angular step
R52 R53 ;increment counter for drilling
@02 -8 R27 R52 ;compare counter no. of holes
G90 M17 ;end

```

```

L90100 R50 360 R52 0 R53 1 R85 1 @25
;start conditions
;check with/without DP.
@03 5 R53 R78
R85 100000
R50 . R85 ;load without DP. R50=360 degrees
N5 R50 / R27 ;360 degrees : number of holes
@01 6 R26 R52 ;angular step = 0? N6
R50 0 R26 ;angular step at R50
N6 R51 0 R25 ;start angle at R51
N8 R51 / R85 ;change R51 into degrees
R71 90 R51 R72 0 R51 R54 360 ;aux. par. for SIN, COS
R51 . R85 ;change back R51
N9 @03 10 R54 R72 ;if angle for SIN >=360,
R72 - R54 ;then R72 - 360
N10 @03 11 R54 R71 ;COS
R71 - R54
@00 -9 ;repeat
N11 @15 R71 ;R71 = COS R51
@15 R72 ;R72 = SIN R51
R60 0 R02 ;R60 drilling depth
R60 - R03 R66 0 R12 R70 2 ;R66 0.5*groove width
R66 / R70 R56 0 R24 ;R56 radius + 0.5 groove width
R56 R66 R67 0 R66 ;R67 0.5 groove width *SIN R51
R67 . R72 R68 0 R66 ;R68 0.5 groove width *COS R51
R68 . R71 R62 0 R67 ;R62 = R67 - R68
R62 - R68 R63 0 R67 ;R63 = R67 + R68
R63 R68 R64 2 ;R64 = 2*R68
R64 . R68 R65 2 ;R65 = 2*R67
R65 . R67 R76 0 R13 ;R76 groove length - groove width
R76 - R12 R75 0 R76 ;R75 = R76 *COS R51
R75 . R71 ;R76 = R76 *SIN R51
R76 . R72 R81 9 R84 10
R81 / R84 R82 0 R81 R83 0 R81 ;R81,R82,R83 = 0.9 *R62,R63,R66
R81 . R62
R82 . R63
R83 . R66
G10 G60 G90 XR22 YR23 AR51 PR56 ;start pos. groove
R02 R78
G ZR02 - R78 ;reference plane + safety
N12 R69 0 R03 R70 0 ;N12, N13, N14 depending on
@03 14 R01 R60 ;depth delivery crit.
R60 - R01 R70 2 ;calculate milling depth
@03 13 R60 R01
R60 R01
R60 / R70
N13 R69 R60

```

```
M14 G1 ZR69 ;move to milling depth
G41 DR14 G91 XR68 YR67 ;selection CRC
G3 G64 X R62 Y- R63 P-R66 ;mill groove in cont.path operation
G1 XR75 YR76
G3 X- R65 YR64 PR66
G1 X- R75 Y- R76
G3 G60 XR81 Y- R82 PR83 ;tangential departure
G11 G41 D G90 AR51 PR56 ;cancel CRC
@03 -12 R70 R53 ;end of groove?
R02 R78
G ZR02 -R78 ;reference plane + safety
R51 R50 ;next angle
R52 R53 ;increment counter
@02 -8 R27 R52 ;all grooves finished?
M17 ;end
```

```

L90200 R60 0 R02 R50 360 R52 0 R53 1
;start conditions
R60 - R03 R85 1 R86 1 @25 ;and load aux. parameters
@02 0 R60 R52 ;milling direction calculation
R86 -1
N0 @03 5 R53 R78 ;check with/without DP
R85 100000
R50 . R85 ;load without DP R50=360 degrees
N5 R50 / R27 ;360 degrees : number of holes
@01 6 R26 R52 ;angular step = 0? N6
R50 0 R26 ;angular step at R50
N6 R51 0 R25 ;start angle at R51
@00 R11 ;allocate address parameters
N1 @20 @90 2 ;to axes
@20 @91 3
@00 7
N2 @20 @90 3
@20 @91 1
@00 7
N4
N3 @20 @90 1
@20 @91 2
N7 @20 @92 R11
R78 . R86 ;safety sign
N8 R51 / R85 ;change R51 into degrees
R71 90 R51 R72 0 R51 R54 360 ;aux. parameters for SIN, COS
R51 . R85 ;change back R51
N9 @03 10 R54 R72 ;if angle for SIN >=360,
R72 - R54 ;then R72 - 360
N10 @03 11 R54 R71 ;COS
R71 - R54
@00 -9 ;repeat

```

```

N11 ,@15 R71 ;R71 = COS R51
@15 R72 ;R72 = SIN R51
R60 @ R02
R60 - R03 R66 @ R12 R70 2 ;R60 drilling depth
R66 / R70 R56 @ R24 ;R66 0.5*groove width
R56 R66 R67 @ R66 ;R56 radius + 0.5 groove width
R67 . R72 R68 @ R66 ;R67 0.5 groove width *SIN R51
R68 . R71 R62 @ R67 ;R68 0.5 groove width *COSR51
R62 - R68 R63 @ R67 ;R62 = R67 - R68
R63 R68 R64 2 ;R63 = R67 + R68
R64 . R68 R65 2 ;R64 = 2*R68
R65 . R67 R76 @ R13 ;R65 = 2*R67
R76 - R12 R75 @ R76 ;R76 groove length - groove width
R75 . R71 ;R75 = R76 * COS R51
R76 . R72 R81 9 R84 10 ;R76 = R76 * SIN R51
R81 / R84 R82 @ R81 R83 @ R81 ;R81,R82,R83 = 0.9 *R62,R63,R66
R81 . R62
R82 . R63
R83 . R66
G10 G60 G90 @90 R22 @91 R23 AR51 PR56 ;start position groove

R02 R78
G @92 R02 - R78 ;reference plane + safety
N12 R60 . R86 R69 @ R03 R70 @ ;N12,N13,N14 depending on
@03 14 R01 R60 ;depth delivery crit.
R60 - R01 R70 2 ;milling depth calculation
@03 13 R60 R01
R60 R01
R60 / R70
N13 R60 . R86
R69 R60
N14 G1 @92 R69
G41 DR14 G91 @90 R68 @91 R67 ;move to milling depth
G3 G64 @90 R62 @91 - R63 F-R66 ;selection CRC
G1 @90 R75 @91 R76 ;mill groove in cont.path operation
G3 @90 - R65 @91 R64 PR66
G1 @90 - R75 @91 - R76
G3 G60 @90 R81 @91 - R82 PR83 ;tangential departure
G11 G41 D G90 AR51 PR56 ;cancel CRC
@03 -12 R70 R53 ;end of groove?
R02 R78
G @92 R02 -R78 ;reference plane + safety
R51 R50 ;next angle
R52 R53 ;increment counter
@02 -8 R27 R52 ;all grooves finished?
M17 ;end

```

```

L90300 R50 360 R52 0 R53 1 @25 ;start conditions
@03 5 R53 R78 ;check with/without DP
R50 36000000 ;load without DP R50=360 degrees
N5 R50 / R27 ;360 degrees: number of holes
@01 6 R26 R52 ;angular step = 0? N6
R50 0 R26 ;angular step at R50
N6 R51 0 R25 ;start angle at R51
R56 0 R12 R70 2 ;R56 0.5*tool diameter + radius
R56 / R70 R57 0 -R56
R56 R24 ;R57 radius - tool radius + hole length
R57 R24
R57 R13
N8 R60 0 R02 R55 -1 ;load aux. parameters
R60 - R03 ;increment R60 milling depth
G10 G60 G90 XR22 YR23 AR51 PR56;move to milling position
R02 R78
G ZR02 - R78 ;reference plane + safety
N9 R69 0 R03 R70 -2 ;N9,N10
@03 11 R01 R60 ;calculate milling depth
R60 - R01 R70 2
@03 10 R60 R01
R60 R01
R60 /R70
N10 R69 R60
N11 G1 ZR69 ;move to milling depth
@00 14 R53 ;jump to N13 or N15
N13 G11 AR51 PR56 ;inner side oblong hole
@00 16
N15 G11 AR51 PR57 ;outer side oblong hole
N16 R53 . R55 ;R53 = R53 *(-1)
@03 -9 R70 R53 ;end crit. of oblong hole
R02 R78
G ZR02 - R78 ;reference plane + safety
R51 R50 R53 1 ;next angle
R52 R53 ;increment counter
@02 -8 R27 R52 ;all oblong holes finished?
M17 ;end

```

L90400 R60 0 R02 R50 360 R52 0 R53 1

```

R60 - R03 R86 1 @25 ;start conditions
@02 0 R60 R52 ;and load auxiliary parameters
R86 -1 ;calculation milling direction
N0 @03 5 R53 R78
R50 36000000 ;check with/without DP
N5 R50 / R27 ;load without DP R50=360 degrees
@01 6 R26 R52 ;360 degrees: number of holes
R50 0 R26 ;angular step = 0? N6
N6 R51 0 R25 ;angular step at R50
@00 R11 ;start angle at R51
N1 @20 @90 2 ;R11 is drilling axis
@20 @91 3 ;load address parameters
@00 7 ;depending on drilling axis
N2 @20 @90 3
@20 @91 1
@00 7
N4
N3 @20 @90 1
@20 @91 2
N7 @20 @92 R11
R78 . R86 R56 0 R12 R70 2
R56 / R70 R57 0 -R56 ;R56 0.5 * tool diameter + radius
R56 R24 ;R57 radius - tool rad.#hole length
R57 R24
R57 R13
N8 R60 0 R02 R55 -1 ;load aux. parameters
R60 - R03 ;increment R60 milling depth
G10 G60 G90 @90 R22 @91 R23 AR51 PR56 ;move to milling position
R02 R78
G @92 R02 - R78 ;reference plane + safety
N9 R60 . R86 R69 0 R03 R70 -2 ;N9,N10
@03 11 R01 R60 ;calculate milling depth
R60 - R01 R70 2
@03 10 R60 R01
R60 R01
R60 / R70
N10 R60 . R86
R69 R60
N11 G1 @92 R69 ;move to milling depth
@00 14 R53 ;jump to N13 or N15
N13 G11 AR51 PR56 ;inner side oblong hole
@00 16
N15 G11 AR51 PR57 ;outer side oblong hole
N16 R53 R55 ;R53 = R53 * (-1)
@03 -9 R70 R53 ;end crit. of oblong hole
R02 R78
G @92 R02 - R78 ;reference plane + safety
R51 R50 R53 1 ;next angle
R52 R53 ;increment counter
@02 -8 R27 R52 ;all oblog holes finished?
M17 ;end

```

```
L90500 R50 360 R52 0 R53 1 @25 ;start conditions
@03 5 R53 R78 ;check with/without DP
R50 36000000 ;load without DP R50=360 degrees
N5 R50 / R27 ;360 degrees: number of holes
@01 6 R26 R52 ;angular step = 0? N6
R50 0 R26 ;angular step at R50
N6 R51 0 R25 ;start angle at R51
N8 G10 G90 XR22 YR23 PR24 AR51 GR28
;move to drilling pos., drilling by GR28
G80 G91 ZR78 ;back to safety distance
R51 R50 ;actual angle + angular step
R52 R53 ;increment counter for drilling
@02 -8 R27 R52 ;compare counter
G90 M17 ;end
M02
```



German text drilling and milling patterns 8M/8MC

& L900(BOHRBILD)

R11 2.0(ACHSNUMMER)  
R22 -5.3(MP ACHSE 1)  
R23 -5.3(MP ACHSE 2)  
R24 4.3(RADIUS)  
R25 3.5(STARTWINKEL)  
R26 3.5(TEILWINKEL)  
R27 3.0(BOHRANZAHL)  
R28 3.0(NR. BOHRZYK.)  
M17

& L901(FRAESBLD NUT)

RO1 -2.3(ZUSTELLTIEFE)  
RO2 -5.3(REFERENZER.)  
RO3 -5.3(NUTTIEFE)  
R14 3.0(FRK D-NR.)  
R22 -5.3(MP ACHSE 1)  
R23 -5.3(MP ACHSE 2)  
R24 4.3(RADIUS)  
R25 3.5(STARTWINKEL)  
R26 3.5(TEILWINKEL)  
R27 3.0(NUT ANZAHL)  
R12 4.3(NUTBREITE)  
R13 4.3(NUTLAENGE)  
M17

& L902(FRAESBLD NUT)

RO1 -2.3(ZUSTELLTIEFE)  
RO2 -5.3(REFERENZER.)  
RO3 -5.3(NUTTIEFE)  
R11 2.0(ACHSNUMMER)  
R14 3.0(FRK D-NR)  
R22 -5.3(MP ACHSE 1)  
R23 -5.3(MP ACHSE 2)  
R24 4.3(RADIUS)  
R25 3.5(STARTWINKEL)  
R26 3.5(TEILWINKEL)  
R27 3.0(NUT ANZAHL)  
R12 4.3(NUTBREITE)  
R13 4.3(NUTLAENGE)  
M17

& L903(LANGLOCH)  
R01 -2.3(ZUSTELLTIEFE)  
R02 -5.3(REFERENZER.)  
R03 -5.3(NUTTIEFE)  
R22 -5.3(MP ACHSE 1)  
R23 -5.3(MP ACHSE 2)  
R24 4.3(RADIUS)  
R25 3.5(STARTWINKEL)  
R26 3.5(TEILWINKEL)  
R27 3.0(LOCHANZAHL)  
R12 4.3(FRAESERDURCH)  
R13 4.3(LANGL.LAENGE)  
M17

& L904(LANGLOCH)  
R01 -2.3(ZUSTELLTIEFE)  
R02 -5.3(REFERENZER.)  
R03 -5.3(NUTTIEFE)  
R11 2.0(ACHSNUMMER)  
R22 -5.3(MP ACHSE 1)  
R23 -5.3(MP ACHSE 2)  
R24 4.3(RADIUS)  
R25 3.5(STARTWINKEL)  
R26 3.5(TEILWINKEL)  
R27 3.0(LOCHANZAHL)  
R12 4.3(FRAESERDURCH)  
R13 4.3(LANGL.LAENGE)  
M17

& L905(BOHRBILD)  
R22 -5.3(MP ACHSE 1)  
R23 -5.3(MP ACHSE 2)  
R24 4.3(RADIUS)  
R25 3.5(STARTWINKEL)  
R26 3.5(TEILWINKEL)  
R27 3.0(BOHRANZAHL)  
R28 3.0(NR. BOHRZYK.)  
M17  
M02

English text drilling and milling patterns 8M/8MC

& L900(DRILL.PATERN)  
R11 2.0(AXIS NO.)  
R22 -5.3(CNTR.PT.1.AX)  
R23 -5.3(CNTR.PT.2.AX)  
R24 4.3(RADIUS)  
R25 3.5(START ANGLE)  
R26 3.5(PROGR. ANGLE)  
R27 3.0(NO. OF HOLES)  
R28 3.0(CYCLE NO.)  
M17  
& L901(MILL.GROOVE)  
R01 -2.3(DEPTH)  
R02 -5.3(EXIT PLANE)  
R03 -5.3(GROOVE DEPTH)  
R14 3.0(CRC D-NO.)  
R22 -5.3(CNTR.PT.1.AX)  
R23 -5.3(CNTR.PT.2.AX)  
R24 4.3(RADIUS)  
R25 3.5(START ANGLE)  
R26 3.5(PROGR. ANGLE)  
R27 3.0(NO. OF HOLES)  
R12 4.3(GROOVE WIDTH)  
R13 4.3(GROOVE LENG.)  
M17  
& L902(MILL.GROOVE)  
R01 -2.3(DEPTH)  
R02 -5.3(EXIT PLANE)  
R03 -5.3(GROOVE DEPTH)  
R11 2.0(AXIS NO.)  
R14 3.0(CRC D-NO.)  
R22 -5.3(CNTR.PT.1.AX)  
R23 -5.3(CNTR.PT.2.AX)  
R24 4.3(RADIUS)  
R25 3.5(START ANGLE)  
R26 3.5(PROGR. ANGLE)  
R27 3.0(NO. OF GROOVE)  
R12 4.3(GROOVE WIDTH)  
R13 4.3(GROOVE LENG.)  
M17

## &amp; L903(SLOT)

R01 -2.3(DEPTH)  
R02 -5.3(EXIT PLANE)  
R03 -5.3(GROOVE DEPTH)  
R22 -5.3(CNTR.PT.1.AX)  
R23 -5.3(CNTR.PT.2.AX)  
R24 4.3(RADIUS)  
R25 3.5(START ANGLE)  
R26 3.5(PROGR. ANGLE)  
R27 3.0(NO. OF HOLES)  
R12 4.3(GROOVE WIDTH)  
R13 4.3(GROOVE LENG.)  
M17

## &amp; L904(SLOT)

R01 -2.3(DEPTH)  
R02 -5.3(EXIT PLANE)  
R03 -5.3(GROOVE DEPTH)  
R11 2.0(AXIS NO.)  
R22 -5.3(CNTR.PT.1.AX)  
R23 -5.3(CNTR.PT.2.AX)  
R24 4.3(RADIUS)  
R25 3.5(START ANGLE)  
R26 3.5(PROGR. ANGLE)  
R27 3.0(NO. OF HOLES)  
R12 4.3(CUTTER DIA.)  
R13 4.3(SLOT LENGTH)  
M17

## &amp; L905(DRILL.PATERN)

R22 -5.3(CNTR.PT.1.AX)  
R23 -5.3(CNTR.PT.2.AX)  
R24 4.3(RADIUS)  
R25 3.5(START ANGLE)  
R26 3.5(PROGR. ANGLE)  
R27 3.0(NO. OF HOLES)  
R28 3.0(CYCLE NO.)  
M17  
M02

French text drilling and milling patterns 8M/8MC

& L900(TROU.REPARTI)  
R11 2.0(NUMERO AXE)  
R22 -5.3(CENTRE AXE 1)  
R23 -5.3(CENTRE AXE 2)  
R24 4.3(RAYON)  
R25 3.5(ANGL.INITIAL)  
R26 3.5(ANGL.PARTIEL)  
R27 3.0(NBRE.PERC.)  
R28 3.0(NUMERO CYCLE)  
M17  
& L901(RAIN.REPARTI)  
RD1 -2.3(PROF.AVANCE)  
RD2 -5.3(PLAN DE REF.)  
RD3 -5.3(PROF.RAINURE)  
R14 3.0(COR.OUT.NR-D)  
R22 -5.3(CENTRE AXE 1)  
R23 -5.3(CENTRE AXE 2)  
R24 4.3(RAYON)  
R25 3.5(ANGL.INITIAL)  
R26 3.5(ANGL.PARTIEL)  
R27 3.0(NBRE.RAINURE)  
R12 4.3(LARG.RAINURE)  
R13 4.3(LONG.RAINURE)  
M17  
& L902(RAIN.RAPARTI)  
RD1 -2.3(PROF.AVANCE)  
RD2 -5.3(PLAN DE REF.)  
RD3 -5.3(PROF.RAINURE)  
R11 2.0(NUMERO AXE)  
R14 3.0(COR.OUT.NR-D)  
R22 -5.3(CENTRE AXE 1)  
R23 -5.3(CENTRE AXE 2)  
R24 4.3(RAYON)  
R25 3.5(ANGL.INITIAL)  
R26 3.5(ANGL.PARTIEL)  
R27 3.0(NBRE.RAINURE)  
R12 4.3(LARG.RAINURE)  
R13 4.3(LONG.RAINURE)  
M17

## &amp; L903(MORTAISE)

R01 -2.3(PROF.AVANCE)  
R02 -5.3(PLAN DE REF.)  
R03 -5.3(PROF.RAINURE)  
R22 -5.3(CENTRE AXE 1)  
R23 -5.3(CENTRE AXE 2)  
R24 4.3(RAYON)  
R25 3.5(ANGL.INITIAL)  
R26 3.5(ANGL.PARTIEL)  
R27 3.0(NBRE.TROUS)  
R12 4.3(DIAM.FRAISE)  
R13 4.3(LONG.MORTAI)  
M17

## &amp; L904(MORTAISE)

R01 -2.3(PROF.AVANCE)  
R02 -5.3(PLAN DE REF.)  
R03 -5.3(PROF.RAINURE)  
R11 2.0(NUMERO AXE)  
R22 -5.3(CENTRE AXE 1)  
R23 -5.3(CENTRE AXE 2)  
R24 4.3(RAYON)  
R25 3.5(ANGL.INITIAL)  
R26 3.5(ANGL.PARTIEL)  
R27 3.0(NBRE.TROUS)  
R12 4.3(DIAM.FRAISE)  
R13 4.3(LONG.MORTAI.)  
M17

## &amp; L905(TROU.REPARTI)

R22 -5.3(CENTRE AXE 1)  
R23 -5.3(CENTRE AXE 2)  
R24 4.3(RAYON)  
R25 3.5(ANGL.INITIAL)  
R26 3.5(ANGL.PARTIEL)  
R27 3.0(NBRE.PERC.)  
R28 3.0(NUMERO CYCLE)  
M17  
M02

Italian text drilling and milling patterns 8M/8MC

Under preparation!





6.5 Address codes for the address parameter

Machine axes	Possible axes addresses*	Address code (Axis no. from machine parameter)
1	X	1
2	Y	2
3	Z	3
4	A	4
5	B	5
6	C	6
7	U	7
8	V	8
9	W	9
10	E	10

\* For the machine axes 4-10, in addition to the above A - E addresses, the address H, P and Q can be selected.

6.6 Figure for stock removal cycle 3.3.1

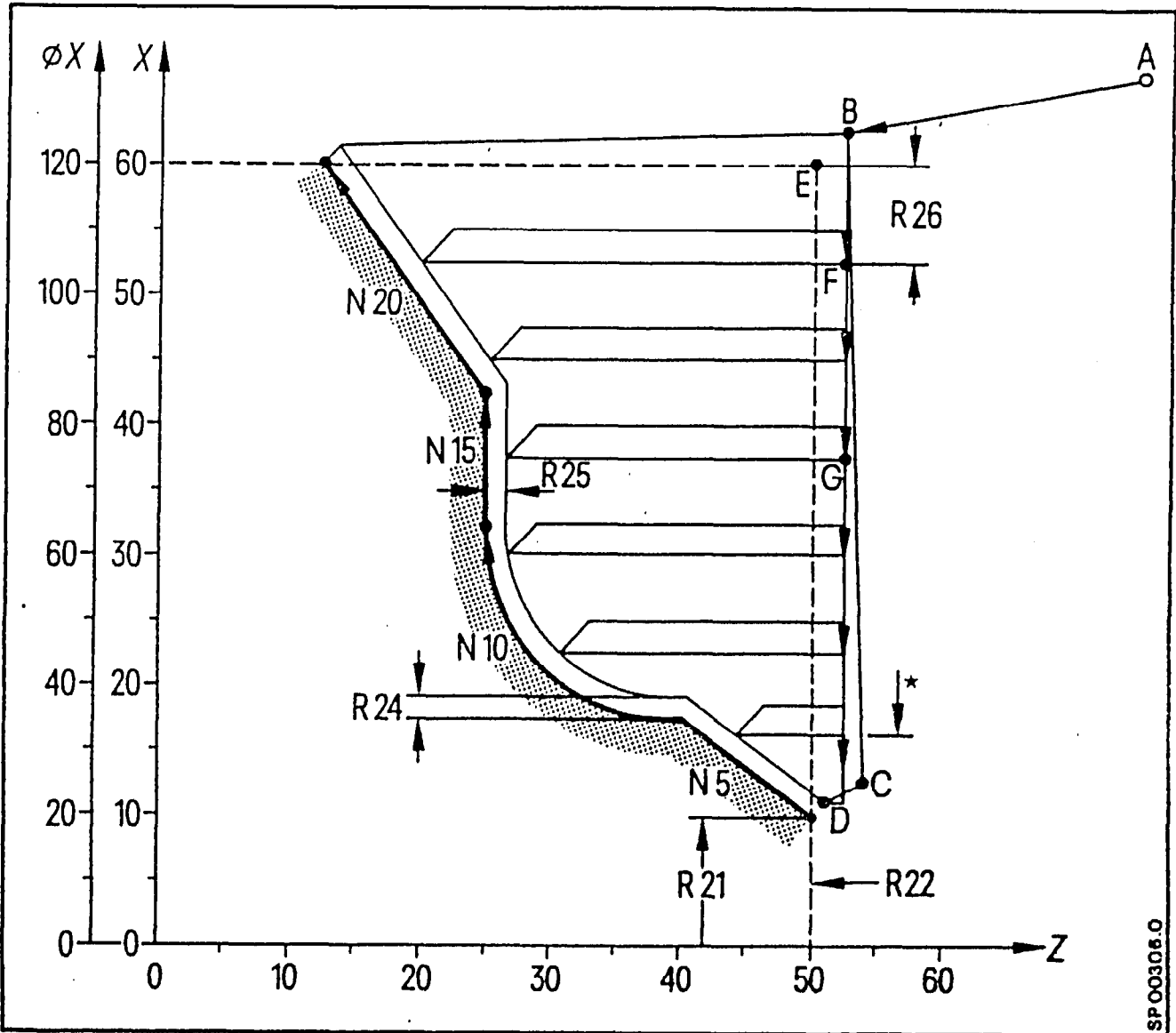

6.7 Figure for stock removal cycle 3.3.2

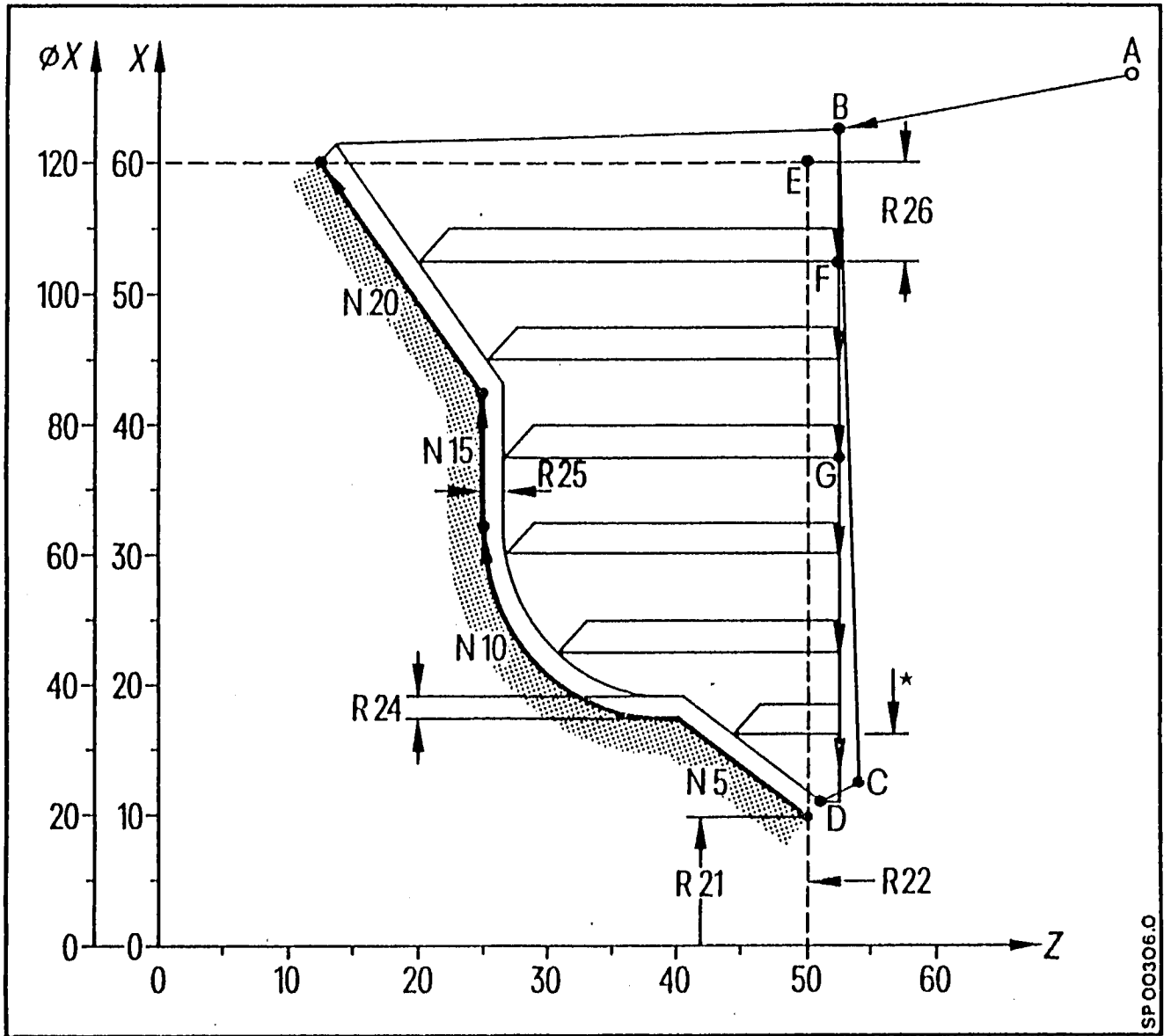

5.8 Defined P - Parameters

Parameter	BT/Sprint BT	BM/BMC/Sprint BM	BM
R00 - R11	-	Drilling cycles L81 - L89 or G81 - G89	-
R18 - R19	Tool change cycles L91/L92	-	-
R20	L95 - L98	-	-
R21	L95 - L98	-	-
R22	L95 - L98	L900 and L901	-
R23	L95 - L98	L900 and L901	-
R24	L95 - L98	L900 and L901	-
R25	L95 - L98	L900 and L901	-
R25	L95 - L98	L900 and L901	-
R27	L95 - L98	L900 and L901	-
R28	L95 - L98	L900 and L901	-
R29	L95 - L98	-	-
R30	L95 - L98	-	-
R31	L95 - L98	-	-
R50 - R99*	All cycles	All cycles	-
R77	@ 25	@ 25	@ 25
R78	@ 25	@ 25	@ 25
R79	@ 25	@ 25	@ 25
R 80	Load parameter from PC	Load parameter from PC	Load parameter from PC
R81 - R88	@ 21	-	-
R90 - R92	@ 22	-	-
R93	@ 24	@ 24	@ 24

\* Parameters R50 - R99 are used internally for cycles and are not displayed. (See chapter 2.2.1, section 9)

6.9 Overview of store access (max values)6.9.1 SIMULTEK 8T/Sprint 8T

e.g. N100 RAB 1 2 3 4 5 LF

N110 @ 29 1 2 3 4 5 RAB LF

@ 29					RAB				
Digit 1	Meaning	Digit 2 & 3	Meaning	Digit 4 & 5	Meaning System store for:	Digit 1 & 2	Meaning	Digit 3,4 & 5	Meaning
1 or 2	Read store Load store	00 to 99	100 possible R parameters	01	Tool geometry	01 02 03 04	1st axis 2nd axis radius tip	001 to 032	32 possible groups
1 2	Read Load	00 to 99	100 possible R parameters	01	Programmable additional length offset	01 02	1st axis 2nd axis	033	1 group
1 2	Read Load	00 to 99	100 possible R parameters	02	Tool wear	01 02	1st axis 2nd axis	001 to 032	32 possible groups
1 2	Read Load	00 to 99	100 possible R parameters	03	Settable zero offset	01 02	1st axis 2nd axis	001 to 002	2 groups
1 2	Read Load	00 to 99	100 possible R parameters	04	Programmable additive zero offset	01 02	1st axis 2nd axis	001	1 group
1	Read	00 to 99	100 possible R parameters	05	Resolver shift	01 02	1st axis 2nd axis	001	1 group
1	Read	00 to 99	100 possible R parameters	06	PRESET	01 02	1st axis 2nd axis	001	1 group
1	Read	00 to 99	100 possible R parameters	07	G92 offset	01 02	1st axis 2nd axis	001	1 group
1	Read	00 to 99	100 possible R parameters	08	Actual shift? [ Z TO (possibly mirrored) + 20!e ]	01 02	1st axis 2nd axis	001	1 group
1 2	Read Load	00 to 99	100 possible R parameters	09	R parameter	00	not specified	000 to 099	100 numbers
1	Read	00 to 99	100 possible R parameters	10	machine parameters	00	not specified	100 to 471	371 numbers
3	Read bit	00 to 99	100 possible R parameters	10	machine parameter bit	00 to 07	Bit Nr	400 to 471	71 numbers
1 2	Read Load	00 to 99	100 possible R parameters	11	Additional compensation	01 02	1st axis 2nd axis	001	1 group

6.9.2 SINUMERIK Sprint 8M

e.g. N100 RAD 1 2 3 4 5 LF  
N110 @ 29 1 2 3 4 5 RAD LF

@ 29					RAD				
Digit 1	Meaning	Digit 2 & 3	Meaning	Digit 4 & 5	Meaning System store for:	Digit 1 & 2	Meaning	Digit 3,4 & 5	Meaning
1 or 2	Read store Load store	00 to 99	100 possible R parameters	01	Tool geometry	01 02	Length or Radius	001 to 099	99 possible groups
1 2	Read Load	00 to 99	100 possible R parameters	02	Tool wear	01 02	Length or Radius	001 to 099	99 possible groups
1 2	Read Load	00 to 99	100 possible R parameters	03	Settable zero offset	01 to 04	1st axis to 4th axis	001 to 004	4 groups
1 2	Read Load	00 to 99	100 possible R parameters	04	Programmable additive zero offset	01 to 04	1st axis to 4th axis	001	1 group
1	Read	00 to 99	100 possible R parameters	05	Resolver shift	01 to 04	1st axis to 4th axis	001	1 group
1	Read	00 to 99	100 possible R parameters	06	PRESET	01 to 04	1st axis to 4th axis	001	1 group
1	Read	00 to 99	100 possible R parameters	07	G92 offset	01 to 04	1st axis to 4th axis	001	1 group
1	Read	00 to 99	100 possible R parameters	08	Actual shift? [ $\Sigma$ T0 (possibly mirrored) + Z0's ]	01 to 04	1st axis to 4th axis	001	1 group
1 2	Read Load	00 to 99	100 possible R parameters	09	R parameter	00	not specified	000 to 099	100 numbers
1	Read	00 to 99	100 possible R parameters	10	machine parameters	00	not specified	100 to 471	371 numbers
3	Read bit	00 to 99	100 possible R parameters	10	machine parameter bit	00 to 07	Bit Nr	400 to 471	71 numbers
1 2	Read Load	00 to 99	100 possible R parameters	11	Additional compensation	01 to 04	1st axis 4th axis	001	1 group

6.9.3 SIEMERIK BR/BMC

e.g. N100 RAD 1 2 3 4 5, LF

N110 @ 29 1 2 3 4 5 RAD LF

@ 29					RAD				
Digit 1	Meaning	Digit 2 & 3	Meaning	Digit 4 & 5	Meaning System store for:	Digit 1 & 2	Meaning	Digit 3,4 & 5	Meaning
1 or 2	Read store Load store	00 to 99	100 possible R parameters	01	Tool geometry	01	Length or Radius	001 to 199	199 possible groups
1 2	Read Load	00 to 99	100 possible R parameters	02	Tool wear	01	Length or Radius	001 to 199	199 possible groups
1 2	Read Load	00 to 99	100 possible R parameters	03	Settable zero offset	01 to 10	1st axis to 10th axis	001 to 012	12 groups
1 2	Read Load	00 to 99	100 possible R parameters	04	Programmable additive zero offset	01 to 10	1st axis to 10th axis	001	1 group
1	Read	00 to 99	100 possible R parameters	05	Resolver shift	01 to 10	1st axis to 10th axis	001	1 group
1	Read	00 to 99	100 possible R parameters	06	PRESET	01 to 10	1st axis to 10th axis	001	1 group
1	Read	00 to 99	100 possible R parameters	07	G92 offset	01 to 10	1st axis to 10th axis	001	1 group
1	Read	00 to 99	100 possible R parameters	08	Actual shift? [ $\Sigma$ T0 (possibly mirrored) + Z0's ]	01 to 10	1st axis to 10th axis	001	1 group
1 2	Read Load	00 to 99	100 possible R parameters	09	R parameter	00	not specified	000 to 099	100 numbers
1	Read	00 to 99	100 possible R parameters	10	machine parameters	00	not specified	100 to 471	371 numbers
3	Read bit	00 to 99	100 possible R parameters	10	machine parameter bit	00 to 07	Bit Nr	400 to 471	71 numbers
1 2	Read Load	00 to 99	100 possible R parameters	11	Additional compensation	01 to 10	1st axis to 10th axis	001	1 group

6.9.4 SINUMERIK 8N

e.g. N100 RAB 1 2 3 4 5 LF

N110 @ 29 1 2 3 4 5 RAB LF

@ 29				RAB					
Digit 1	Meaning	Digit 2 & 3	Meaning	Digit 4 & 5	Meaning System store for:	Digit 1 & 2	Meaning	Digit 3,4 & 5	Meaning
1 or 2	Read store Load store	00 to 99	100 possible R parameters	01	Tool geometry	01	Radius or tool middle to edge	001 to 099	99 possible groups
1 2	Read Load	00 to 99	100 possible R parameters	02	Tool wear	01	Radius or tool middle to edge	001 to 099	99 possible groups
1 2	Read Load	00 to 99	100 possible R parameters	03	Settable Zero Offset	01 to 04	1st axis to 4th axis	001 to 004	4 groups
1 2	Read Load	00 to 99	100 possible R parameters	04	Programmable additive Zero Offset	01 to 04	1st axis to 4th axis	001	1 group
1	Read	00 to 99	100 possible R parameters	05	DRF- Offset	01 to 04	1st axis to 4th axis	001	1 group
1	Read	00 to 99	100 possible R parameters	06	PRESET	01 to 04	1st axis to 4th axis	001	1 group
1	Read	00 to 99	100 possible R parameters	07	G92 offset	01 to 04	1st axis to 4th axis	001	1 group
1 2	Read Load	00 to 99	100 possible R parameters	08	Actual shift? [ $\sum$ TO (possibly mirrored) + Z0's ]	01 to 04	1st axis to 4th axis	001	1 group
1	Read	00 to 99	100 possible R parameters	09	R parameter	00	not specified	000 to 099	100 numbers
1	Read	00 to 99	100 possible R parameters	10	machine parameters	00	not specified	100 to 471	371 numbers
3	Read bit	00 to 99	100 possible R parameters	10	machine parameter bit	00 to 07	Bit Nr	400 to 471	71 numbers
1 2	Read Load	00 to 99	100 possible R parameters	11	Additional compensation	01 to 04	1st axis to 4th axis	001	1 group



6.9.4 SINUMERIK 8M/BMC/8N/8T/SP8T/SP8M

Extended memory access by read- and store function from software 02 onwards

z.B.: N100 RAB 1 2 3 4 5 LF  
N110 29 1 2 3 4 5 RAB LF

29					RAB				
Digit 1	Meaning	Digit 2 & 3	Meaning	Digit 4 & 5	Meaning System store for:	Digit 1 & 2	Meaning	Digit 3,4 & 5	Meaning
1	Read	00 to 99	100 possible R-parameters	10	Machine data	00	not specified	100 to 478	379 groups
3	Flag Read	00 to 99	100 possible R-parameters	10	Machine data flag	00	Flag-no.	400 to 478	60 nos.
1 2	Read Load	00 to 99	100 possible R-parameters	18	1)background memory for 100 par.values	00	not specified	000 to 099	100 nos.
3	Flag	00 to	100 possible R-parameters	19	1)special flags	00 to	Flag no.	001	1 no.

1) Background memories are active after cancel 3.

2) Special flags:

The following flags can be read:

Bit 0 = 1 block search active  
0 block search not active

Bit 1 = 1 dry run active  
0 dry run not active

Bit 2 = 1 measuring probe contact closed  
0 measuring probe contact open

