

SIEMENS

SIMATIC

Industrial PC SIMATIC IPC277D

Operating Instructions



Preface

Overview	1
Safety instructions	2
Installing and connecting the device	3
Commissioning the device	4
Advanced device functions	5
Operating the device	6
Device expansion and parameter assignment	7
Device maintenance and repairs	8
Technical specifications	9
Technical Support	A
List of abbreviations	B

Legal information

Warning notice system

This manual contains notices you have to observe in order to ensure your personal safety, as well as to prevent damage to property. The notices referring to your personal safety are highlighted in the manual by a safety alert symbol, notices referring only to property damage have no safety alert symbol. These notices shown below are graded according to the degree of danger.

 DANGER
indicates that death or severe personal injury will result if proper precautions are not taken.
 WARNING
indicates that death or severe personal injury may result if proper precautions are not taken.
 CAUTION
indicates that minor personal injury can result if proper precautions are not taken.
NOTICE
indicates that property damage can result if proper precautions are not taken.

If more than one degree of danger is present, the warning notice representing the highest degree of danger will be used. A notice warning of injury to persons with a safety alert symbol may also include a warning relating to property damage.

Qualified Personnel

The product/system described in this documentation may be operated only by **personnel qualified** for the specific task in accordance with the relevant documentation, in particular its warning notices and safety instructions. Qualified personnel are those who, based on their training and experience, are capable of identifying risks and avoiding potential hazards when working with these products/systems.

Proper use of Siemens products

Note the following:

 WARNING
Siemens products may only be used for the applications described in the catalog and in the relevant technical documentation. If products and components from other manufacturers are used, these must be recommended or approved by Siemens. Proper transport, storage, installation, assembly, commissioning, operation and maintenance are required to ensure that the products operate safely and without any problems. The permissible ambient conditions must be complied with. The information in the relevant documentation must be observed.

Trademarks

All names identified by ® are registered trademarks of Siemens AG. The remaining trademarks in this publication may be trademarks whose use by third parties for their own purposes could violate the rights of the owner.

Disclaimer of Liability

We have reviewed the contents of this publication to ensure consistency with the hardware and software described. Since variance cannot be precluded entirely, we cannot guarantee full consistency. However, the information in this publication is reviewed regularly and any necessary corrections are included in subsequent editions.

Preface

These operating instructions contain all the information you need for commissioning and operation of the SIMATIC IPC277D.

It is intended both for programming and testing personnel who commission the device and connect it with other units (automation systems, programming devices), as well as for service and maintenance personnel who install add-ons or carry out fault/error analyses.

Basic knowledge required

A solid background in personal computers and Microsoft operating systems is required to understand this manual. General knowledge in the field automation control engineering is recommended.

Scope of validity of this documentation

These operating instructions are valid for all versions of the SIMATIC IPC277D.

Scope of this documentation

The documentation for the SIMATIC IPC277D consists of:

- Product information, e.g. "Important notes on your device"
- Quick Install Guide SIMATIC IPC277D
- SIMATIC IPC277D operating instructions in English and German

The PDF version of the documentation is supplied with the device on the "Documentation and Drivers" CD/DVD.

Conventions

The terms "PC" or "device" are used in place of the product name SIMATIC IPC277D in these operating instructions.

In these operating instructions, the terms "Windows Embedded Standard 2009" and "Windows Embedded Standard 7" are also abbreviated with the term "Windows Embedded Standard". "Windows 7" is used as an abbreviation for "Windows 7 Ultimate".

History

The following earlier release versions of these operating instructions have been published:

Edition	Comment
07/2011	First edition, valid for the first delivery stage
11/2011	Second edition, valid for all delivery stages
02/2012	Third edition with corrections
06/2013	Fourth edition with corrections

Guideline to the operating instructions

Content structure	Contents
Preface	Purpose, layout and description of the important topics
Table of contents	Detailed organization of the documentation, including the index of pages and chapters
Overview	<ul style="list-style-type: none"> • Description of the product: Characteristics and field of application • Product package • Structure of the product/system: Operator control and connection elements • Accessories
Safety instructions	<p>All generally valid safety aspects:</p> <ul style="list-style-type: none"> • Legal requirements • Product/system view during installation • General information on commissioning • Notes on operation
Installing and connecting the device	<ul style="list-style-type: none"> • Application planning: Aspects of storage, transport, environmental and EMC conditions to be considered in the preparatory stage. • Installation: Product installation options and installation instructions • Connection: Options of connecting the product and wiring instructions • Integration: Options of integrating the product into existing or planned automation systems and networks.
Commissioning the device	Commissioning the product/system
Extended device functions	Monitoring and display functions
Expanding and assigning parameters to the device	Procedure for installing device expansions (modules, drives)
Device maintenance and repair	<ul style="list-style-type: none"> • Replacing hardware components • Restoring and setting up the operating system and BIOS (Recovery) • Installing drivers and software • Service and spare parts • Recycling and disposal
Technical specifications	<ul style="list-style-type: none"> • General specifications in compliance with relevant standards and current/voltage values • Guidelines and certifications, ESD guidelines, notes on retrofitting • Dimension drawings: Dimensions of the device and of modules • Detailed descriptions of boards and system resources
Technical support	<ul style="list-style-type: none"> • Service and support • Troubleshooting: Problems, causes, remedy • BIOS Setup
Abbreviations	Abbreviations of the technical terms used

Table of contents

	Preface	3
1	Overview.....	9
1.1	Product description	9
1.2	Configuration of the devices	10
1.2.1	SIMATIC IPC277D 7".....	10
1.2.2	SIMATIC IPC277D 9".....	12
1.2.3	SIMATIC IPC277D 12", 15" and 19".....	13
1.2.4	IPC277D 7" and 9" – interfaces and operator controls	16
1.2.5	IPC277D 12", 15" and 19" – interfaces and operator controls.....	16
1.3	Accessories.....	17
2	Safety instructions	19
2.1	Security information	21
2.2	Notes on usage	21
3	Installing and connecting the device	25
3.1	Preparing for installation	25
3.1.1	Checking the delivery package.....	25
3.1.2	Identification data of the device	26
3.1.3	Permitted mounting positions.....	28
3.1.4	Preparing the mounting cutout.....	29
3.2	Installing the device	30
3.2.1	Installation guidelines.....	30
3.2.2	Securing with clamps	32
3.2.3	Securing with clamps (can be ordered as options).....	34
3.3	Connecting the device	35
3.3.1	Notes on connecting	35
3.3.2	Connecting the protective earth.....	36
3.3.3	Connecting the power supply to the 7" and 9" devices.....	37
3.3.4	Connecting the power supply to the 12", 15 and 19" devices	38
3.3.5	Connect device to networks.....	39
3.3.6	Mounting the Ethernet connector strain relief.....	40
3.3.7	Securing the cables	41
4	Commissioning the device.....	43
4.1	General information on commissioning	43
4.2	Initial commissioning.....	44
4.3	Windows Security Center.....	45

5	Advanced device functions	47
5.1	Monitoring functions	47
5.1.1	Overview of the monitoring functions	47
5.1.2	Temperature monitoring/display	48
5.1.3	Watchdog (WD).....	48
5.1.4	Battery monitoring	49
5.2	Enhanced Write Filter.....	49
5.3	File-Based Write Filter.....	51
5.4	Buffer memory MRAM (option)	53
6	Operating the device.....	55
6.1	Overview	55
6.2	Operating the touch screen.....	55
6.3	Configuring the touch screen	56
6.3.1	Standard calibration	57
6.3.2	Extended calibration.....	58
6.3.3	Extended Touch touch functionality	59
6.4	Using the on-screen keyboard	59
6.5	Setting the display brightness	60
6.6	Command line call.....	61
6.7	Setting the screen saver	62
6.8	WinMove	64
7	Device expansion and parameter assignment	65
7.1	Open the device.	65
7.2	Inserting and removing CompactFlash cards	66
8	Device maintenance and repairs	69
8.1	Cleaning the Device Front.....	69
8.2	Installing and removing hardware	70
8.2.1	Repair information.....	70
8.2.2	Maintenance.....	71
8.2.3	Replacing the backup battery	72
8.2.4	Replacing drives of IPC277D 7" and 9"	74
8.2.5	Replacing the drive of an IPC277D 12", 15" and 19".....	76
8.3	Installing the software	77
8.3.1	Reinstalling the operating system	77
8.3.1.1	General installation procedure	77
8.3.1.2	Restoring the factory state	78
8.3.1.3	Installing Windows XP.....	79
8.3.1.4	Installation of Windows 7	81
8.3.1.5	Setting up the language selection by means of the Multilanguage User Interface (MUI).....	85

8.3.2	Partitioning data media	86
8.3.2.1	Partitions in Windows Embedded Standard 2009 and Windows Embedded Standard 7	86
8.3.2.2	Partitions under Windows 7 Ultimate and Windows XP Professional	87
8.3.2.3	Adapting partitions in Windows 7 Ultimate and Windows Embedded Standard 7	87
8.3.2.4	Adapting partitions in Windows XP and Windows Embedded Standard 2009	88
8.3.3	Drivers and software	88
8.3.3.1	Driver installation for Windows Embedded Standard 7 and 2009	88
8.3.3.2	Installing drivers and software	89
8.3.4	Installing updates	89
8.3.4.1	Updating the operating system	89
8.3.4.2	Installing or updating application programs and drivers	90
9	Technical specifications	91
9.1	Certificates and approvals	91
9.2	Directives and declarations	93
9.2.1	Electromagnetic compatibility for industrial environments	93
9.2.2	ESD guideline	93
9.3	Dimension drawings	96
9.3.1	Dimensional drawing IPC277D, 7" display	96
9.3.2	Dimensional drawing IPC277D, 9" display	97
9.3.3	Dimensional drawing IPC277D, 12" display	98
9.3.4	Dimensional drawing IPC277D, 15" display	99
9.3.5	Dimensional drawing IPC277D, 19" display	100
9.4	Technical specifications	101
9.4.1	General technical specifications	101
9.4.2	Environmental conditions	104
9.4.3	Shipbuilding	105
9.4.4	Power supply IPC277D, 7" and 9" displays	105
9.4.4.1	Power requirements of additional components	105
9.4.4.2	Power consumption	106
9.4.4.3	DC power supply	106
9.4.5	Power supply IPC277D, 12", 15" and 19" display	107
9.4.5.1	Power requirements of additional components	107
9.4.5.2	Power consumption	107
9.4.5.3	DC power supply	107
9.5	Hardware description	108
9.5.1	Technical features of the motherboard	108
9.5.2	External interfaces	108
9.5.2.1	Overview of interfaces	108
9.5.2.2	Extended COM ports	109
9.5.2.3	Ethernet port	109
9.5.2.4	USB 2.0 port	110
9.5.3	System resources	110
9.5.3.1	Currently allocated system resources	110
9.5.3.2	System resources used by the BIOS/DOS	110
9.5.4	Input/output address areas	112
9.5.4.1	Overview of the internal module registers	112
9.5.4.2	Battery status register (read-only)	112
9.5.4.3	MRAM address register	112

9.6	BIOS description	113
9.6.1	Overview	113
9.6.2	Starting BIOS Setup	113
9.6.3	BIOS Setup menus	113
9.6.3.1	BIOS Setup overview	113
9.6.3.2	Main menu	115
9.6.3.3	Advanced menu	116
9.6.3.4	Security menu	120
9.6.3.5	Power menu	121
9.6.3.6	Boot menu	122
9.6.3.7	Version menu	127
9.6.3.8	Exit menu	127
9.6.4	BIOS Setup default settings	128
9.6.5	Alarm, error and system messages	131
9.7	Functional scope in Windows	131
9.7.1	Windows Embedded Standard 2009	131
9.7.2	Windows Embedded Standard 7	133
A	Technical Support.....	135
A.1	Service and support	135
A.2	Problem solving.....	136
B	List of abbreviations.....	137
	Glossary	141
	Index.....	149

Overview

1.1 Product description

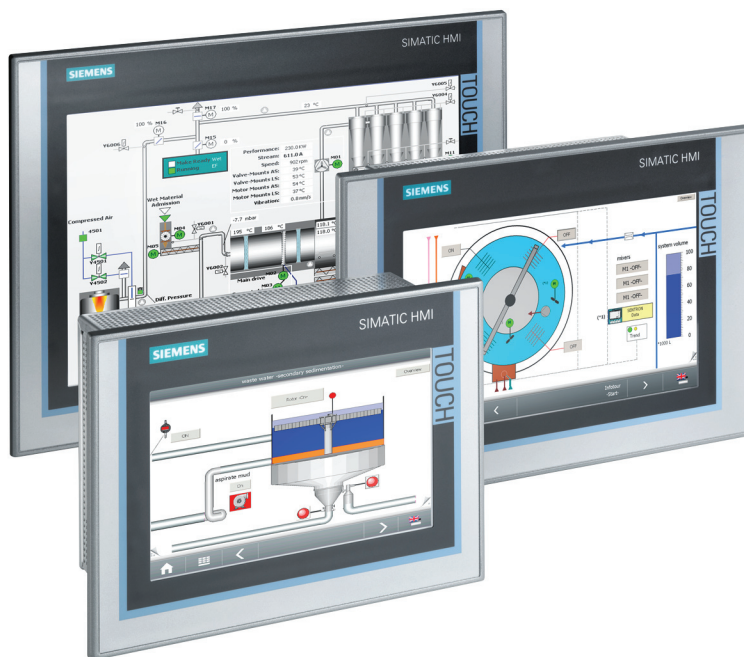

The SIMATIC IPC277D provides high-level industrial performance.

- Compact design
- Rugged
- Maintenance-free operation possible

SIMATIC IPC277D is available with various control units that differ with regard to the display size. This display is a color display with a backlit "wide-screen" format TFT color display.

Displays are available in the following sizes for the SIMATIC IPC277D:

- 7" touch
- 9" touch
- 12" touch
- 15" touch
- 19" touch

Basic data

Power supply	24V DC (19.2 to 28.8 V), max. 1.8 A
Conditions of use	Operation without fan

Monitoring and safety functions

Watchdog	<ul style="list-style-type: none">• Monitoring function for program execution• Restart can be parameterized in the event of a fault
Voltage drop	Up to 15 ms buffer time at full load
Buffer memory	512 KB MRAM

1.2 Configuration of the devices

1.2.1 SIMATIC IPC277D 7"

Front and side view

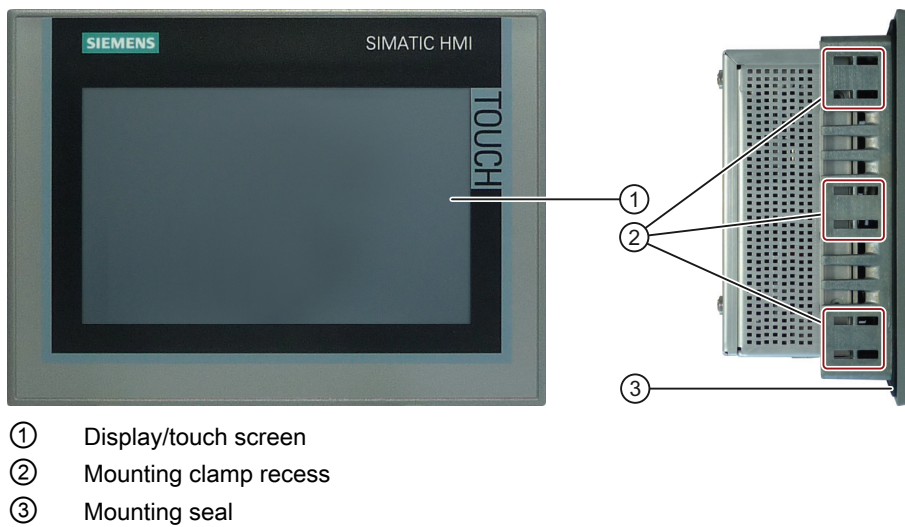

Rear view



- ① Rating plate
- ② Interface designation

Bottom view

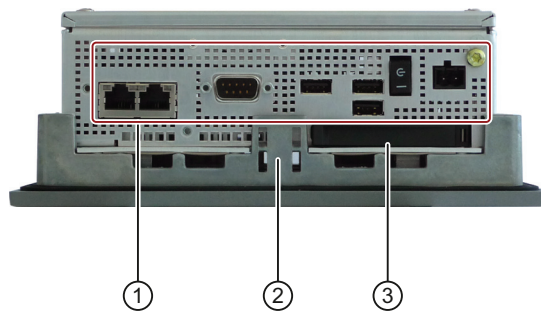

- ① Interfaces and operating elements
- ② Mounting clamp recess
- ③ Flap for memory card slot

1.2.2 SIMATIC IPC277D 9"

Front and side view

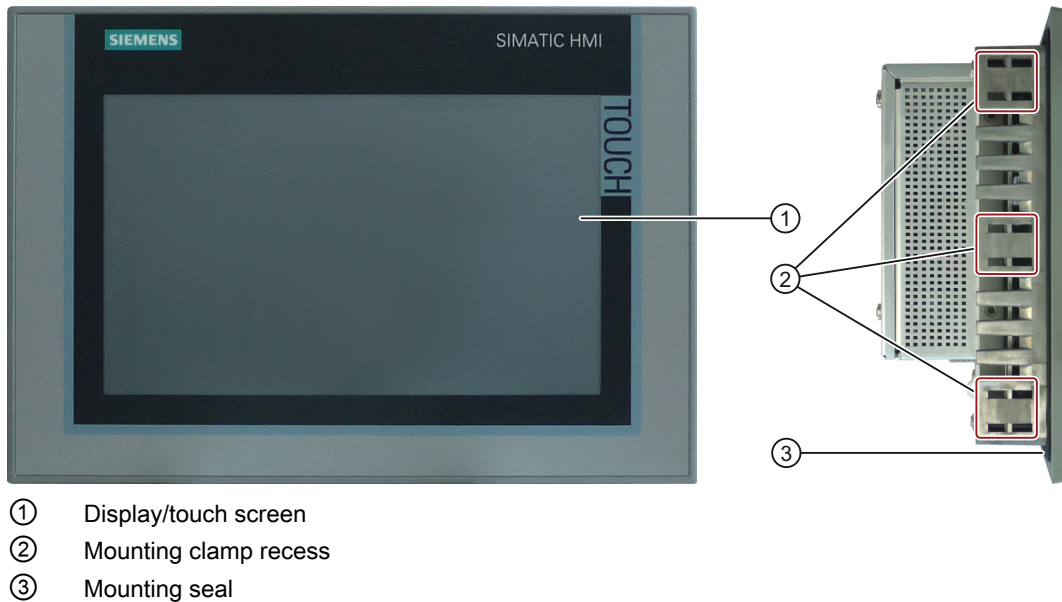

Rear view



Bottom view

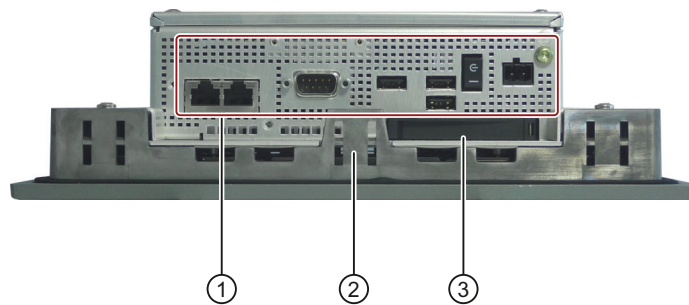

- ① Interfaces and operating elements
- ② Mounting clamp recess
- ③ Flap for memory card slot

1.2.3 SIMATIC IPC277D 12", 15" and 19"

This section describes the 12", 15" and 19" devices using the example of the SIMATIC IPC277D 12". The 15" and 19" devices have an additional USB port at the front.

Front and side view, 12"



- ① Display/touch screen
- ② Mounting clamp recess
- ③ Mounting seal

Front view, 15"

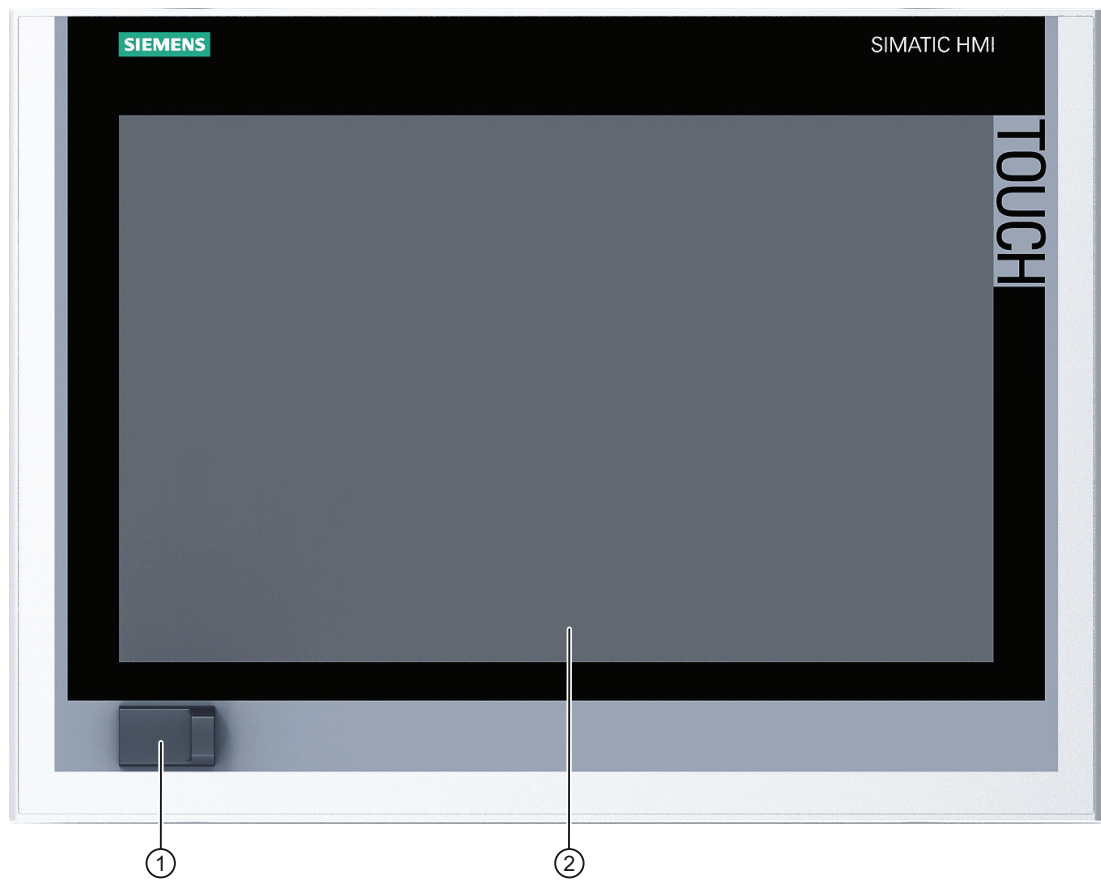

- ① Front USB port
- ② Display/touch screen

The front view of the 19" device is similar.

Rear view

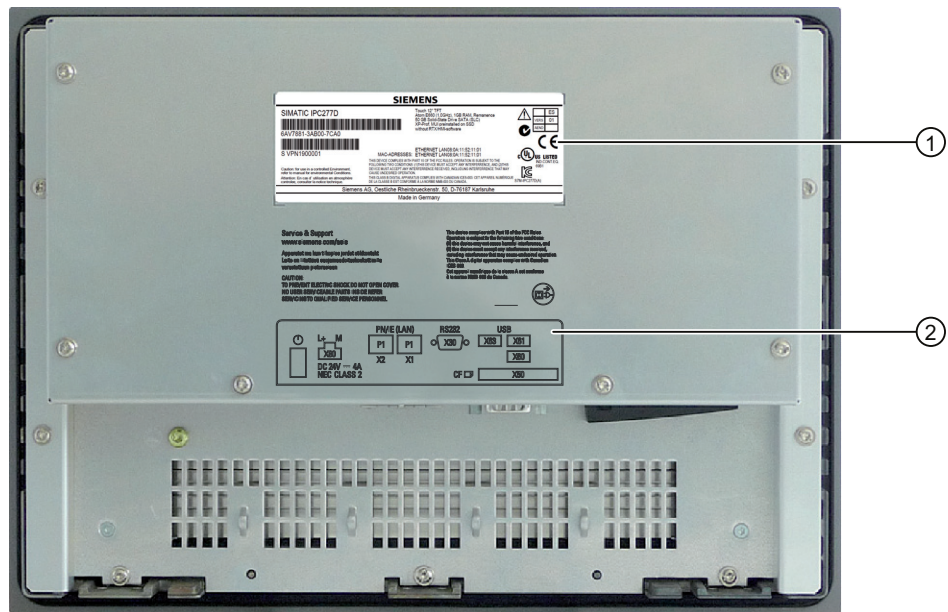

- ① Rating plate
- ② Interface designation

Bottom view

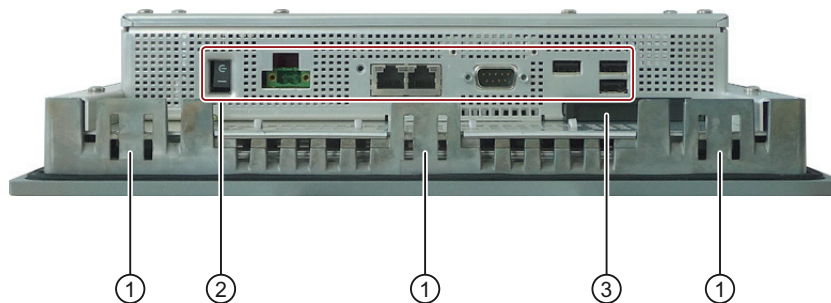

- ① Mounting clamp recess
- ② Interfaces and operating elements
- ③ Flap for memory card slot

1.2.4 IPC277D 7" and 9" – interfaces and operator controls

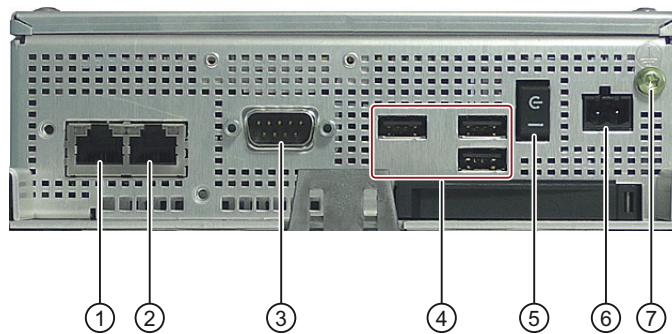

- ① RJ45 Ethernet connection LAN2 for 10/100/1000 Mbps
- ② RJ45 Ethernet connection LAN1 for 10/100/1000 Mbps
- ③ RS-232 interface, D-sub connector, 9-pin
- ④ USB 2.0 connection, high speed
Only two USB interfaces may be operated simultaneously in high-current mode.
- ⑤ On/off switch. OFF position, when the symbol "C-" is pressed in.
- ⑥ Connection for a 24 VDC power supply
- ⑦ Protective conductor connection

Observe the printing on the rear of the device.

1.2.5 IPC277D 12", 15" and 19" – interfaces and operator controls

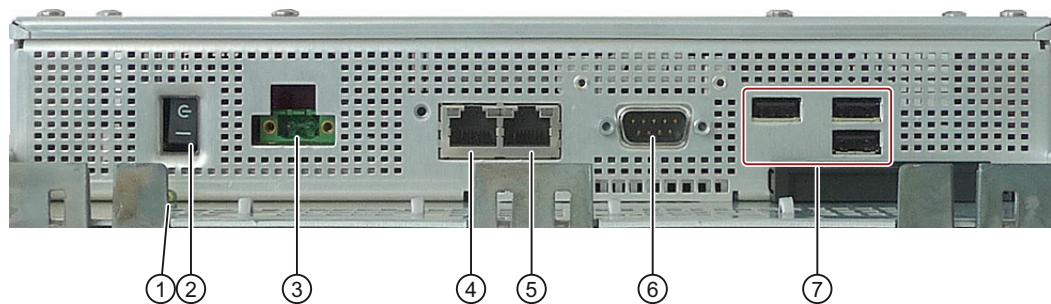

- ① Protective conductor connection
- ② On/off switch: OFF position, when the symbol "C-" is pressed in.
- ③ Connection for a 24 VDC power supply
- ④ RJ45 Ethernet connection LAN2 for 10/100/1000 Mbps
- ⑤ RJ45 Ethernet connection LAN1 for 10/100/1000 Mbps
- ⑥ RS-232 interface, D-sub connector, 9-pin
- ⑦ USB 2.0 connection, high speed
Only two USB interfaces may be operated simultaneously in high-current mode.

Observe the printing on the rear of the device.

1.3 Accessories

This section contains the scope of accessories valid at the time these operating instructions were written. Additional accessories can be found on the Internet at:

- Expansion components and accessories (http://www.automation.siemens.com/mcms/pc-based-automation/en/industrial-pc/expansion_components_accessories)
- Industry Mall (<http://mall.automation.siemens.com>)

CompactFlash cards

Note

Replace CompactFlash cards only with replacement cards of the same product versions

You may only operate this device with SIMATIC PC CompactFlash cards of product version 03 (ES03 or higher).

The following CompactFlash cards can be ordered:

- CompactFlash card, 2 GB
- CompactFlash card, 4 GB
- CompactFlash card, 8 GB
- CompactFlash card, 16 GB

Touch pen

The SIMATIC IPC touch pen is used for convenient operation of devices with touch screen.

 WARNING
Life-threatening voltages are present with an open control cabinet
When you install the device in a control cabinet, some areas or components in the open control cabinet may be carrying life-threatening voltages.
If you touch these areas or components, you may be killed by electric shock.
Switch off the power supply to the cabinet before opening it.

System expansions

NOTICE
Damage through system expansions
Device and system expansions may be faulty and can affect the entire machine or plant.
The installation of expansions can damage the device, machine or plant. Device and system expansions may violate safety rules and regulations regarding radio interference suppression. If you install or exchange system expansions and damage your device, the warranty becomes void.
Note the following for system expansions:
<ul style="list-style-type: none">• Only install system expansion devices designed for this device. Contact your technical support team or where you purchased your PC to find out which system expansion devices may safely be installed.• Observe the information on electromagnetic compatibility (Page 93).

 WARNING
Risk of fire
The device is classified as "Open Type" for use in the area of industrial control equipment in accordance with UL508. Burning substances may escape and cause fire in the event of overheating.
Please therefore note the following:
<ul style="list-style-type: none">• The installation of the device in an enclosure conforming to UL508 is a mandatory requirement for approval and operation in accordance with UL508.• Install the device in an enclosure that meets the requirements of paragraphs 4.6 and 4.7.3 of the standards EN 60950-1:2006 and IEC/UL/EN/DIN-EN 60950-1.

Battery and rechargeable battery

 **WARNING**

Risk of explosion and release of harmful substances

Improper handling of lithium batteries can result in an explosion of the batteries.

Explosion of the batteries and the released pollutants can cause severe physical injury.

Worn batteries jeopardize the function of the device.

Note the following when handling lithium batteries:

- Replace used batteries in good time; see the section "Replacing the backup battery" in the operating instructions.
- Replace the lithium battery only with an identical battery or types recommended by the manufacturer (order no.: A5E30314053).
- Do not throw lithium batteries into fire, do not solder on the cell body, do not recharge, do not open, do not short-circuit, do not reverse polarity, do not heat above 100°C, and protect from direct sunlight, moisture and condensation.

High frequency radiation

NOTICE

Unintentional operating situations

High frequency radiation, e.g. from a cellular phone, interferes with device functions and can result in malfunctioning of the device.

Persons are injured and the plant is damaged.

Avoid high-frequency radiation:

- Remove radiation sources from the environment of the device.
- Switch off radiating devices.
- Reduce the radio output of radiating devices.
- Observe the information on electromagnetic compatibility (Page 93).

ESD Guideline

Electrostatic sensitive devices can be labeled with an appropriate symbol.



NOTICE

Electrostatic sensitive devices (ESD)

When you touch electrostatic sensitive components, you can destroy them through voltages that are far below the human perception threshold.

If you work with components that can be destroyed by electrostatic discharge, observe the ESD Guideline (Page 93).

2.1 Security information

Siemens offers IT security mechanisms for its portfolio of automation and drive products in order to support safe operation of the plant/machine. We recommend that you stay informed about the IT security developments for your products. For information on this topic, refer to: Industry Online Support (http://www.siemens.de/automation/csi_en_WW): You can register for a product-specific newsletter here.

For the safe operation of a plant/machine, however, it is also necessary to integrate the automation components into an overall IT security concept for the entire plant/machine, which corresponds to the state-of-the-art IT technology. You can find information on this under: Industrial Security (<http://www.siemens.com/industrialsecurity>).

Products used from other manufacturers should also be taken into account here.

2.2 Notes on usage

 WARNING
Risks associated with the unprotected machine or plant
According to the results of a risk analysis, certain hazard potentials associated with the unprotected machine exist. These hazards could lead to personal injury.
Avoid such hazards by taking the following precautions in accordance with the risk analysis:
<ul style="list-style-type: none">• Installation of additional safety equipment on the machine or plant. In particular, the programming, parameter assignment and wiring of the inserted I/O modules must be executed in accordance with the safety performance identified by the necessary risk analysis (SIL, PL or Cat.).• Use as intended must be validated for the device by means of a function test on the plant. These tests help you to identify programming, parameter assignment and wiring errors.• Documentation of the test results that you can enter in the relevant safety verification documents, if necessary.

Environment

NOTICE
Ambient conditions and chemical resistance
Unsuitable environmental conditions have a negative impact on device operation. Chemical substances such as cleaners or fuels may alter the color, shape and structure of the device surface, for example, the front panel.
The device may be damaged, possibly resulting in malfunctions.
For this reason, please observe the following precautions:
<ul style="list-style-type: none">• Always operate the device in closed rooms. All warranties shall be void in the case of noncompliance.• Operate the device only in accordance with the ambient conditions specified in the technical specifications.• Protect the device against dust, moisture and heat.• Do not expose the device to direct sunlight or to other strong sources of light.• Without additional safety measures, such as a supply of clean air, the device may not be used in locations with harsh operating conditions caused by acidic vapors or gases.• Always use suitable cleaning agents. Read the information on the Internet concerning chemical resistance, see the "After Sales Information System for SIMATIC PC/PG" link in the section "Auto-Hotspot".

Note

Use in an industrial environment without additional protective measures

The device has been designed for use in a normal industrial environment in accordance with IEC 60721-3-3 (pollutant class 3C2 for chemical influences, 3S2 for sand and dust).

TFT displays

NOTICE

Burn-in effect and backlighting

A permanent picture with bright screen objects leads to a burn-in effect. The longer the same screen contents are displayed, the longer it will take for the burn-in effect to disappear. Screensavers (for example, "starfield simulation") for the backlit active black mode reduce the burn-in effect. The brightness of the backlighting deteriorates over the course of the screen's life cycle.

The service life of the screen and backlighting is extended by the following measures:

- Switch on the screensaver. The backlight brightness is reduced while the screensaver is active.
- You should also reduce the backlighting.
- Observe the backlighting operating time.

Defective pixels in the display

At present, the manufacturing process of modern displays does not guarantee that all pixels of the display will be perfect. A small number of defective pixels in the display is therefore unavoidable. This does not present a functional problem as long as the defective pixels are not bunched in one location.

Additional information is available in the section "Auto-Hotspot".

See also

General technical specifications (Page 101)

SIMATIC IPC after-sales information system (<http://www.siemens.com/asis>)

Installing and connecting the device

3.1 Preparing for installation

3.1.1 Checking the delivery package

Procedure

1. When accepting a delivery, please check the packaging for visible transport damage.
2. If any transport damage is present at the time of delivery, lodge a complaint at the shipping company in charge. Have the shipper confirm the transport damage immediately.
3. Unpack the device at its installation location.
4. Keep the original packaging in case you have to transport the unit again.

Note

Damage to the device during transport and storage

If a device is transported or stored without packaging, shocks, vibrations, pressure and moisture may impact the unprotected unit. A damaged packaging indicates that ambient conditions have already had a massive impact on the device.

The device may be damaged.

Do not dispose of the original packaging. Pack the device during transportation and storage.

5. Check the contents of the packaging and any accessories you may have ordered for completeness and damage.
6. If the contents of the packaging are incomplete, damaged or do not match your order, inform the responsible delivery service immediately. Fax the enclosed form "SIMATIC IPC/PG Quality Control Report".

3.1 Preparing for installation

 WARNING
Electric shock and fire hazard due to damaged device A damaged device can be under hazardous voltage and trigger a fire in the machine or plant. A damaged device has unpredictable properties and states. Death or serious injury could occur. Make sure that the damaged device is not inadvertently installed and put into operation. Label the damaged device and keep it locked away. Send off the device for immediate repair.

NOTICE
Damage from condensation If the device is subjected to low temperatures or extreme fluctuations in temperature during transportation, for example in cold weather, moisture could build up on or inside the HMI device. Moisture can result in short-circuits in electrical circuits and damage the device. In order to prevent damage to the device, proceed as follows: <ul style="list-style-type: none">• Store the device in a dry place.• Bring the device to room temperature before starting it up.• Do not expose the device to direct heat radiation from a heating device.• If condensation develops, wait approximately 12 hours or until the device is completely dry before switching it on.

- 7. Please keep the enclosed documentation in a safe place. It belongs to the device. You need the documentation when you commission the device for the first time.
- 8. Write down the identification data of the device.

3.1.2 Identification data of the device

The device can be clearly identified with the help of this identification data in case of repairs or theft.

Enter the identification data in the following table:

Order number	6AV...
Serial number	S VP
Product version	ES
Windows "Product Key"	
Ethernet address 1 (MAC)	
Ethernet address 2 (MAC)	

You can find this information on the rating plate and COA label. The rating plate is located on the back of the unit. The COA label is only available with pre-installed Windows operating systems and is affixed to the rear of the device.

Procedure

1. Take down the order number, serial number, product version (ES) and Ethernet addresses from the rating plate.

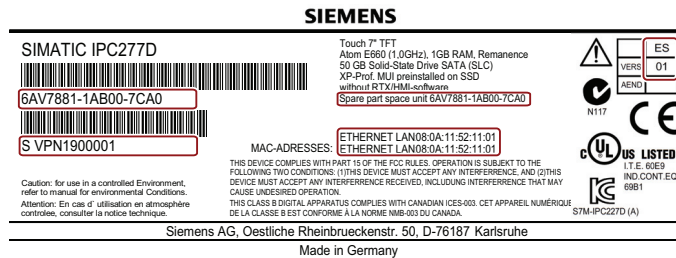

The Ethernet addresses can also be found in the BIOS Setup (F2 key) under "Main > Advanced > Peripheral Configuration".

Replacement device: On the rating plate, the order number of a replacement device which is available from stock at short notice is listed under "Spare Part Space Units". The replacement device is always supplied without storage media.

Note

Replacement device without storage media

When you order a replacement device, remove all the storage media, such as SSD, CompactFlash card, from your device. Insert the storage media in the replacement device.

2. Take down the Windows "Product Key" from the COA label. Example: Windows XP Pro:

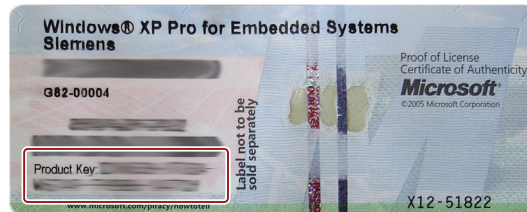

3.1.3 Permitted mounting positions

The device may be mounted in the following positions:

- Standard position: Vertical installation in horizontal format

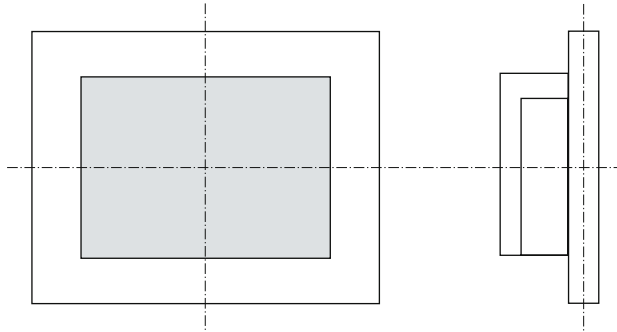

For vertical installation in horizontal format, the following ambient temperatures are permitted:

Maximum ambient temperature at the device			Comment
7", 9" and 12"	15"	19"	
50 °C	50 °C	45 °C	

- Inclined installation in horizontal format with a vertical inclination of maximum $\pm 45^\circ$

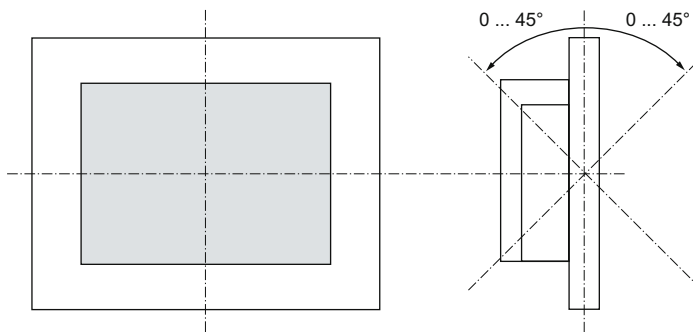

For inclined installation in horizontal format, the following ambient temperatures are permitted:

Maximum ambient temperature at the device			Comment
7", 9" and 12"	15"	19"	
50 °C ¹	45 °C	45 °C	The device housing fulfills the requirement of a fire protection enclosure.

¹ Applicable for SIMATIC IPC277D 9": The device must be installed in a restricted access location (RAL), e.g. a locked switchgear cabinet, if the temperature is $>45^\circ\text{C}$.

- Vertical installation in upright format, display turned through $\pm 90^\circ$ compared with the standard position

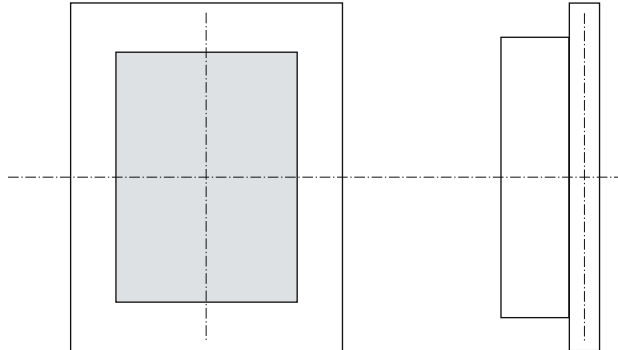

For vertical installation in upright format, the following ambient temperatures are permitted:

Maximum ambient temperature at the device			Comment
7", 9" and 12"	15"	19"	
45 °C	40° C	40° C	The device must be installed in a fire protection enclosure (see "Safety instructions (Page 19)").

3.1.4 Preparing the mounting cutout

Note

Stability of the mounting cutout

The material in the area of the mounting cutout must provide sufficient strength to guarantee the enduring and safe mounting of the HMI device.

The force of the clamps or operation of the device may not lead to deformation of the material in order to achieve the degrees of protection described below.

Degrees of protection

The degrees of protection of the HMI device can only be guaranteed if the following requirements are met:

- Material thickness at the mounting cutout for IP65 degree of protection, or for enclosure type 4X/type 12 (indoor use only): 2 mm to 6 mm
- Permitted deviation from plane at the mounting cutout: ≤ 0.5 mm
This condition must be fulfilled for the mounted HMI device.
- Permissible surface roughness in the area of the mounting seal: $\leq 120 \mu\text{m}$ ($R_z 120$)

Dimensions of the mounting cutout

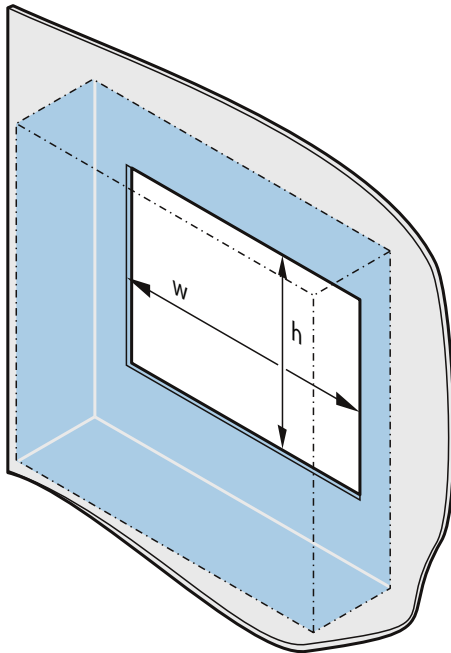

The following table shows the dimensions of the required mounting cutout:

Mounting cutout	Device				
	7 inch	9 inch	12 inch	15-inch	19-inch
Width w *	197 ⁺¹ mm	251 ⁺¹ mm	310 ⁺¹ mm	395 ⁺¹ mm	464 ⁺¹ mm
Height h *	141 ⁺¹ mm	166 ⁺¹ mm	221 ⁺¹ mm	290 ⁺¹ mm	318 ⁺¹ mm

* Width and height should be reversed accordingly when mounting in vertical format.

3.2 Installing the device

3.2.1 Installation guidelines

The installer of the plant is responsible for proper installation of the device.

<p>⚠ WARNING</p> <p>Dangerous voltage in control cabinet</p> <p>A high voltage may be present in the switchgear cabinet and could cause a dangerous electric shock.</p> <p>It may result in death or serious physical injury.</p> <p>Isolate the power supply to the control cabinet before opening it. Ensure that the power to the control cabinet cannot be turned on accidentally.</p>
--

NOTICE**Risk of fire**

If you install the device in an unapproved mounting position or if you do not observe the ambient conditions, the device can overheat.

Overheating can cause a fire. Proper functioning of the device is no longer guaranteed.

Before you install the device, note the following general installation information.

Note

In the standard installation position, the device meets the requirements for fire protection enclosures in accordance with EN 60950-1 and can therefore be installed without an additional fire protection covering.

- Install the device only in one of the permitted mounting positions.
- For installation in control cabinets, note the SIMATIC setup guidelines as well as the relevant DIN/VDE requirements or the country-specific regulations.
- Ensure that the device is classified as "Open Type" when using it in the area of Industrial Control Equipment (UL508). A UL508 conform enclosure is therefore a mandatory requirement for approval or operation according to UL508.
- Provide adequate volume in the control cabinet for air circulation and heat transport. Keep at least 5 cm distance between the device and control cabinet.
- The ventilation slots of the device may not be covered or obstructed.
- The minimum distance between the device and the cabinet is 5 cm at the air output end.
- Ensure there is enough free space in the control cabinet to allow the cover to be removed.
- Equip the control cabinet with struts for stabilizing the mounting cut-out. Install struts where necessary.

IP65 degree of protection **WARNING****Danger of electric shock when degree of protection is not guaranteed**

The specified degree of protection cannot be guaranteed if the device is not correctly installed. Moisture or water could leak in and cause electric shock or destroy the plant.

The degree of protection IP65 is ensured for the front of the device under the following conditions:

- The mounting cutout was prepared based on the correct dimensions; see chapter "Preparing the mounting cutout (Page 29)".
- The device was secured with the supplied mounting clamps or with clamps which can be optionally ordered.
- The mounting seal is undamaged.

See also

Technical specifications (Page 101)

Dimension drawings (Page 96)

3.2.2 Securing with clamps

Position of the mounting clamps

To ensure the necessary degree of protection on the HMI device, you need to use the mounting clamps with the positions listed below.

The positions of the mounting clamps are marked by stamps on the cutouts. Fit mounting clamps in all the stamped cutouts.

The following table shows the type, number and position of mounting clamps needed for the various HMI devices.

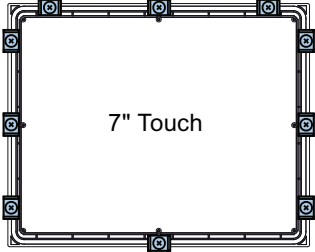
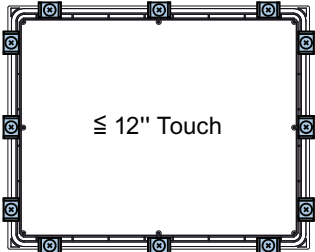
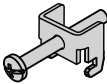
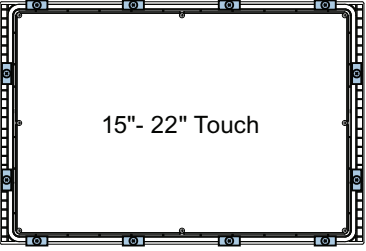
HMI device	Mounting clamps		
	Type	Quantity	Position on the HMI device
IPC277D, 7" display		10	 7" Touch
IPC277D, 9" display IPC277D, 12" display		12	 ≤ 12" Touch
IPC277D, 15" display IPC277D, 19" display		12	 15"- 22" Touch

Requirement

- All packaging components and protective foils should be removed from the HMI device.
- To install the HMI device, you need the mounting clamps from the accessory kit.

Procedure

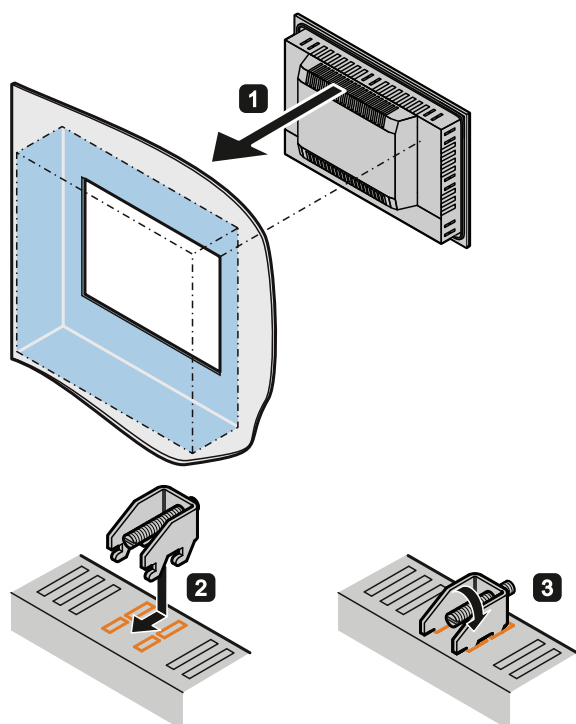

- 1** Insert the HMI device into the mounting cutout from the front.
- 2** Insert a mounting clamp into the cutout provided on the HMI device.
- 3** Tighten the mounting clamp with the threaded pin. The threaded pins of the mounting clamps have a maximum tightening torque of 0.5 Nm on the 7, 9, and 12 inch variants.
- 4** Repeat steps 2 and 3 for all mounting clamps.
- 5** Check the fit of the mounting seal.

Result

The HMI device is mounted and the relevant degree of protection is ensured at the front.

3.2.3 Securing with clamps (can be ordered as options)

Requirement

- 2.5 mm hexagonal spanner
- IPC277D, 15" display: 6 clamps
- IPC277D, 19" display: 8 clamps

Clamps are available as an accessory.



Procedure

1. Disconnect the device from the power supply.
2. Working from the front, insert the device into the mounting cutout.
3. Fasten the control unit from the rear using the clamps.
4. Tighten the setscrews to a torque of 0.4 - 0.5 Nm.

See also

Accessories (Page 17)

3.3 Connecting the device

3.3.1 Notes on connecting

 WARNING
Risk of fire and electric shock The on/off switch does not isolate the device from the power supply. Risk of electric shock if the device is opened incorrectly or defective. There is also a risk of fire if the device or connecting lines are damaged. You should therefore protect the device as follows: <ul style="list-style-type: none">• Always pull out the power plug when you are not using the device or if the device is defective. The power plug must be freely accessible.• Connect the device to a protective conductor as instructed (see "Connecting the protective conductor").• Use a central isolating switch in the case of cabinet installation.

 WARNING
Risk of lightning strikes A lightning flash may enter the mains cables and data transmission cables and jump to a person. Death, serious injury and burns can be caused by lightning. Take the following precautions: <ul style="list-style-type: none">• Disconnect the device from the power supply in good time when a thunderstorm is approaching.• Do not touch mains cables and data transmission cables during a thunderstorm.• Keep a sufficient distance from electric cables, distributors, systems, etc.

NOTICE
Fault caused by I/O devices The connection of I/O devices can cause faults in the device. The result may be personal injury and damage to the machine or plant. Note the following when connecting I/O devices: <ul style="list-style-type: none">• Read the documentation of the I/O devices. Follow all instructions in the documentation.• Only connect I/O devices which are approved for industrial applications in accordance with EN 61000-6-2 and IEC 61000-6-2.• I/O devices that are not hotplug-capable may only be connected after the device has been disconnected from the power supply.

NOTICE

Damage through regenerative feedback

Regenerative feedback of voltage to ground by a connected or installed component can damage the device.

Connected or built-in I/Os, for example, a USB drive, are not permitted to supply any voltage to the device. Regenerative feedback is generally not permitted.

3.3.2 Connecting the protective earth

The protective conductor discharges dangerous currents, triggering a surge protection switch. The protective conductor also discharges any interference transmitted from external power supply cables, signal cables or cables to the I/O devices. The connection for the protective earth is labeled with the following symbol:



Requirement

- T20 screwdriver
- Cable lug for M4
- Protective earth with a minimum cross-section of 2.5 mm²

Procedure

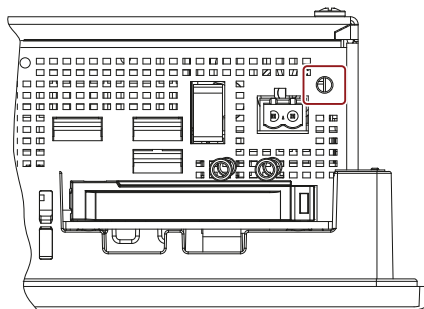

- 1** Clamp the cable lug onto the protective earth.
- 2** Firmly attach the cable lug to the protective conductor connection on the device using the M4 thread (see part labeled).
- 3** Connect the protective conductor to the protective conductor connection of the cabinet or the plant in which the device is installed.

3.3.3 Connecting the power supply to the 7" and 9" devices

Please note the following:

Note

The device should only be connected to a 24 VDC power supply which meets the requirements of safe extra low voltage (SELV) according to IEC/EN/DIN EN/UL 60950-1.

The power supply must meet the requirement NEC Class 2 or LPS according to the IEC/EN/DIN EN/UL 60950-1.

Note

The 24 V DC power supply must be adapted to the input data of the device (see technical specifications).

Requirement

- The protective conductor is connected.
- You are using the connection terminal supplied.
- A two-core cable with a cable cross-section of 0.75 mm² to 2.5 mm² for the 24 VDC connection.
- A slotted screwdriver with approx. 3 mm blade.

Procedure

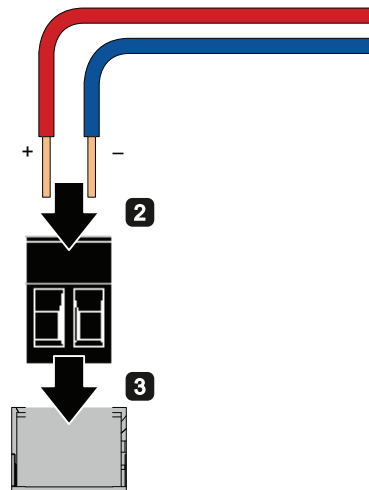

- 1 Switch off the 24 VDC power supply.
- 2 Connect the wires of the power supply.

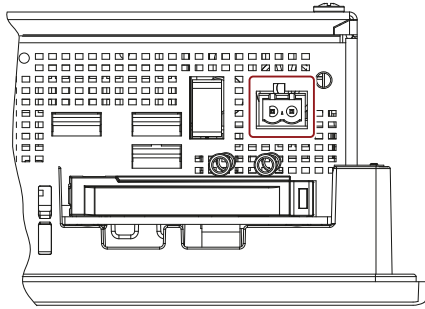

- 3 Connect the connection terminal at the marked position.

See also

Technical specifications (Page 101)

3.3.4 Connecting the power supply to the 12", 15 and 19" devices

Please note the following:

Note

The device should only be connected to a 24 VDC power supply which meets the requirements of safe extra low voltage (SELV) according to IEC/EN/DIN EN/UL 60950-1.

The power supply must meet the requirement NEC Class 2 or LPS according to the IEC/EN/DIN EN/UL 60950-1.

Note

The 24 VDC power supply must be adapted to the input data of the device (see the technical specifications in the operating instructions).

Requirement

- The protective conductor is connected.
- You are using the connection terminal supplied.
- A two-core cable with a cable cross-section of 0.75 mm² to 2.5 mm² for the 24 VDC connection.
- A slotted screwdriver with approx. 3 mm blade.

Procedure

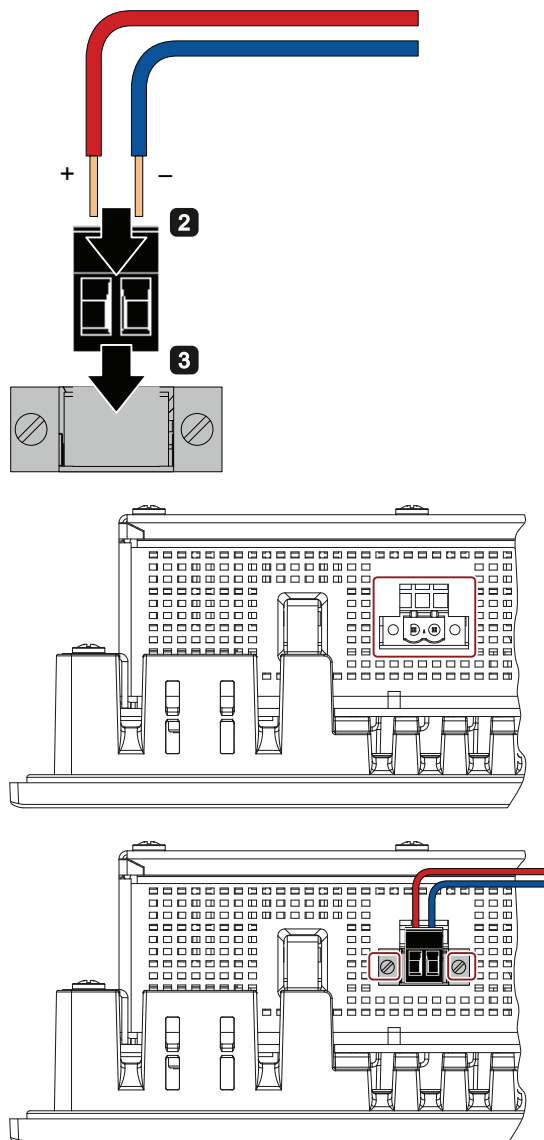

- 1 Switch off the 24 VDC power supply.
- 2 Connect the wires of the power supply.

- 3 Connect the connection terminal at the marked position.

- 4 Secure the connection terminal with the marked screws.

3.3.5 Connect device to networks

The following options are available for integrating the device in existing or planned system environments and networks.

Ethernet

You can use the integrated Ethernet interfaces (10/100/1000 Mbps) for communication and data exchange with automation devices, e.g. SIMATIC S7.

You need a suitable software to use this functionality: STEP 7, WinCC, WinAC, SIMATIC NET.

Industrial Ethernet

You can establish a network between the device and other computers via Industrial Ethernet. The on-board LAN interfaces are twisted-pair TP interfaces that support data transmission rates of 10/100/1000 Mbps.

Note

You need a category 6 Ethernet cable for operation at 1000 Mbps.

PROFINET

PROFINET can be operated via:

- Standard Ethernet interfaces (RT)

SIMATIC NET

Use this software package to create, operate and configure an innovative network for Field & Control level. Information on this can be found on the SIMATIC NET Manual Collection CD. The software package and the documentation are not included in the product package.

Additional information

You can find additional information on the Internet at: Technical Support (http://www.siemens.de/automation/csi_en_WW)

3.3.6 Mounting the Ethernet connector strain relief

The Ethernet connector strain relief safely prevents the unintentional disconnection of the Ethernet connectors from the device. The Ethernet connector strain relief is available as an accessory.

Procedure

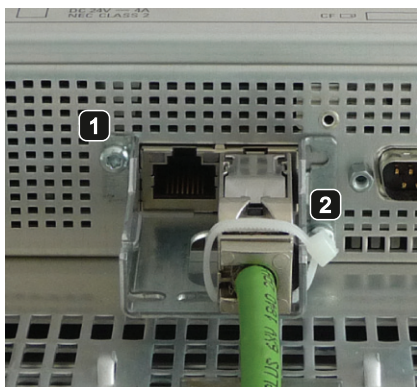

- 1** Screw the Ethernet connector strain relief at the bottom of the housing.
- 2** Secure the Ethernet connectors using cable ties.

3.3.7 Securing the cables

On the rear panel of the 9" and 12" devices, you will find fixing eyelets for cable ties for strain relief of the following connecting cables:

- Power supply cable
- RS232 cable
- USB cables

Procedure

SIMATIC IPC277D 9"

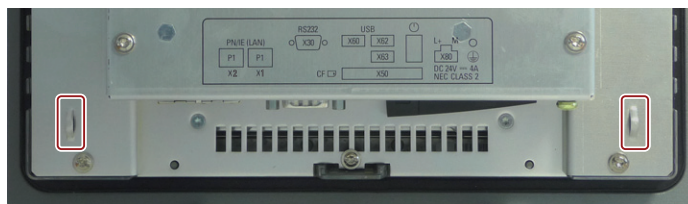

Secure the connecting cables with cable ties at the points marked.

SIMATIC IPC277D 12"

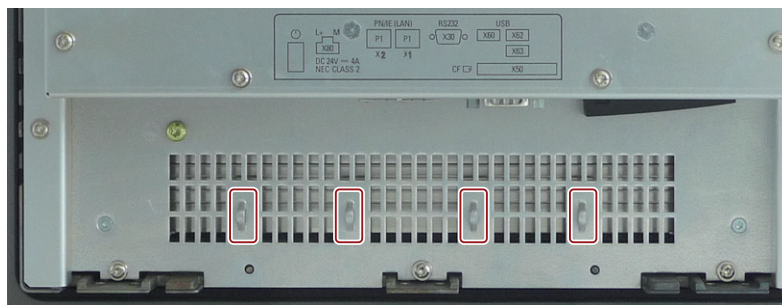

Commissioning the device

4.1 General information on commissioning

 CAUTION
Danger of burns The surface of the device can reach temperatures of over 70 °C. Any unprotected contact may cause burns. Avoid direct contact during operation of the device. Touch the device only with appropriate protective gloves.

Note**Windows Embedded Standard 7**

Read the EWF and FBWF information

Two configurable write filters (Enhanced Write Filter and File Based Write Filter) are provided with Windows Embedded Standard. Read the EWF/FBWF information if you activate and use them, otherwise you may experience data loss.

Note**Configuring memory cards in the device**

Memory cards used in a device need to be configured on that device. Memory cards configured on other devices will not boot as the drive parameters will be different.

Requirement

- The device is connected to the power supply.
- The protective conductor is connected.
- The connection cables are plugged in correctly.
- The following hardware is available for initial commissioning:
 - One USB keyboard
 - One USB mouse
 - A monitor/display

4.2 Initial commissioning

Following the initial switch-on, the operating system pre-installed on the device is set up automatically on the device.

NOTICE

Faulty installation

If you change the default values in the BIOS setup or if you turn off the device during installation, you disrupt the installation and the operating system is not installed correctly. The operating safety of the device and the plant is at risk.

Do not switch off the device during the entire installation process. Do not change the default values in the BIOS setup.

Procedure - Switching on the device

1. Set the on/off switch to position "1".

The module carries out a self-test. During the self-test, the following message appears:

Press <F2> to go to Setup Utility

Press <F12> to go to Boot Manager

2. Wait for the message to disappear.
3. Follow the instructions on the screen.
4. Make the region and language settings.

If you want your system language to be international, select English. Information about changing the region and language settings is available in the chapter "Servicing and maintaining the device", section "Installing software".

Note

Once the operating system has been set up, the device may restart.

5. Type in the product key as required.

The product key is located on the "Certificate of Authentication", in the "Product Key" line.

Result

The interface of the operating system is displayed every time you turn on the device and after the startup routine.

Procedure - Switching off the device

To turn off the device, always select "Start > Shutdown".

If the device is not going to be used for a long period of time after shutdown, set the on/off switch to position "0".

4.3 Windows Security Center

Warning from the Windows Security Center

A warning from the Windows Security Center is displayed the first time you switch on your device. The Security Center checks the status of the device in regard to the three important security aspects listed below. If a problem is detected (an outdated antivirus program, for example), the Security Center issues a warning and makes recommendations on how you can better protect the device.

- **Firewall:** The Windows Firewall adds protection to the device by blocking network or Internet access to the device by unauthorized users. Windows checks if the device is protected by a software firewall.
The firewall is enabled by default in the delivery state.
- **Antivirus software:** Antivirus programs add protection to the device by searching for and eliminating viruses and other security threats. Windows checks if a full-range, up-to-date antivirus program is running on the device.
No antivirus software is installed in the delivery state.
- **Automatic updates:** Using the Automatic Update feature allows Windows to regularly search for the latest critical updates for the device and to install them automatically. This feature is disabled in the delivery state.
- **Real-time protection (Windows 7 only):** Windows Defender displays warnings if spyware or possibly unwanted software is installed or executed on the computer. You will also receive a warning if programs attempt to modify important Windows settings.

Configure the Security Center according to your requirements.

Advanced device functions

5.1 Monitoring functions

5.1.1 Overview of the monitoring functions

The basic version of the device also provides monitoring functions. The following display, monitoring and control functions are available when the appropriate software is used:

- Temperature monitoring (overtemperature, low temperature, or cable break at a temperature sensor)
- Monitoring of drives with S.M.A.R.T. functionality
- Watchdog (hardware or software reset of the computer)
- Operating hours meter (information on total runtime)

SIMATIC IPC DiagBase software

Use the functions of the SIMATIC IPC DiagBase software included in the scope of delivery for local monitoring. Use the "DiagBase Management Explorer" application to obtain a clear overview of the controls. Use the DiagBase Alarm Manager to receive notifications about individual alarms.

Note

For more information on SIMATIC IPC DiagBase software functionality, please refer to the relevant Online Help.

SIMATIC IPC DiagMonitor software

SIMATIC IPC DiagMonitor is available on CD (not included in the scope of delivery). This monitoring software comprises:

- The software for the stations to be monitored.
- A library for creating user-specific applications.

5.1.2 Temperature monitoring/display

Temperature monitoring

Three temperature sensors monitor the temperature of the device at several positions:

- Processor temperature
- Temperature close to the RAM ICs/chips
- Temperature of the basic module

A temperature error is triggered when one of the three temperature values exceeds the set temperature threshold and the following reaction is initiated:

Reaction	Option
The DiagBase or DiagMonitor software is enabled	None

The temperature error is retained in memory until temperatures have fallen below the thresholds and it is reset by one of the following measures:

- Acknowledgment of the error message by the monitoring software
- Restart of the device

5.1.3 Watchdog (WD)

Function

The watchdog is able to monitor program runtime and informs the user about the different reactions that are triggered if the user program does not respond to the watchdog within the specified monitoring time.

The watchdog is in idle state during power on of the device or after a HW-RESET (cold restart). A WD reaction is not triggered while it is in idle state. However, an active watchdog alarm remains after the restart.

Watchdog reactions

The following reactions may be triggered if the watchdog is not retriggered within the set time:

Reaction	Option
Trigger a PC reset	Configurable
Output DiagBase alarm messages	None

Note

Contact Customer Support for a detailed description of the Watchdog functions.

WD monitoring times

Set the monitoring times in SIMATIC Diagnostics Management as integer values in the range from 4 to 255 seconds.

Note

The watchdog will be retriggered if you change the watchdog time after the WD has been activated.

5.1.4 Battery monitoring

The installed backup battery has a limited service life, see section "Replacing the backup battery (Page 72)". A two-tier battery monitoring checks the status of the backup battery. The SIMATIC DiagBase and SIMATIC DiagMonitor diagnostic software determines the status of the backup battery.

When the first warning level is reached, the battery for buffering CMOS data still has a remaining service life of at least one month.

5.2 Enhanced Write Filter

Purpose and function

The EWF (Enhanced Write Filter) is a function that is only available for Windows Embedded operating systems. It provides write protection that can be configured by the user.

The Enhanced Write Filter enables you to boot Windows Embedded Standard from read-only media (e.g. CD-ROM), assign write protection attributes to partitions, and customize file system performance (when using CompactFlash cards, for example).

EWF can be used to minimize write access to CompactFlash cards. This is important because the write cycles on CompactFlash cards are limited due to technical reasons. We therefore recommend using EWF if you work with CompactFlash cards.

NOTICE
Activate only one write filter per partition - otherwise you may incur data loss.
Both EWF and FBWF are preinstalled in the SIMATIC IPC images.
Ensure that only one write filter is enabled on a partition, otherwise you may incur data loss.

Note

In Windows Embedded Standard, the Enhanced Write Filter is disabled by default. After the operating system has been set up, you should back up your data and then enable the EWF.

Set EWF

The following programs can be used to install, enable or disable the EWF:

- EWFMgr.EXE
- SIMATIC IPC EWF Manager

The SIMATIC IPC EWF Manager is preinstalled and included on the supplied "Documentation and Drivers" CD/DVD. The SIMATIC EWF Manager can be started with an icon in the system tray on the task bar.

EWFMgr.EXE is started with the command prompt. The following functions are available:

Function	Command
Write-protect drive C: Switching on	<code>ewfmgr c: -enable</code>
Write-protect drive C: disable (modified files are accepted)	<code>ewfmgr c: -commitanddisable</code>
Modified files on drive C: Accept	<code>ewfmgr c: -commit</code>
Display information about the EWF drive	<code>ewfmgr c:</code>
Display help	<code>ewfmgr c: /h</code>

Note

The EWF commands affecting the write protection do not become active until after the next booting process.

Note

The EWF command `ewfmgr c: -commitanddisable` cannot be used in combination with the `-live` option (invalid entry, for example: `ewfmgr c: -commitanddisable -live`).

Special features for the use of Enhanced Write Filters (EWF)

- In the event of a power failure, if the EWF is enabled changes made after the boot sequence on drive C: are lost.
To prevent data loss in the event of a power failure, the use of a UPS is recommended.
- You can save the files in the EWF RAM overlay to the CompactFlash card or the hard disk before you shut down the device. To do so, enter the following command in the command prompt:

```
ewfmgr c: -commitanddisable
```

Then restart the system.

```
ewfmgr c: -enable
```

Then restart the system.

Note

When the system is set to automatically adjust the clock for daylight saving time adjustment, systems without central time management and with activated EWF set the clock forward or backward by one hour in the daylight saving time or standard time period each time the system boots.

The reason for this behavior is that Windows Embedded Standard 2009 has a registry entry that detects if the clock has been adjusted for daylight saving time. Since this file is also protected against modification by the EWF, the marker is lost during the boot sequence and the adjustment is made again.

We therefore recommend that you deactivate the automatic adjustment and change the clock manually.

Procedure:

1. Switch off the EWF filter (ewfmgr c: -commitanddisable) and reboot the system.
 2. Deactivate automatic adjustment in the Control Panel. In the Time Zone tab opened with the menu command Start > Control Panel > Date and Time, remove the check mark from the "Automatically adjust clock for daylight saving changes" check box.
 3. Enable EWF again (ewfmgr c: -enable) and reboot the system.
-

5.3 File-Based Write Filter

Purpose and function

Microsoft introduced a second write filter with Feature Pack 2007 for Windows XP Embedded, namely the File Based Write Filter (FBWF).

In contrast to EWF, which protects partitions based on sectors, FBWF works on the file level. When FBWF is enabled, all files and folders of a partition are protected unless included in an exception list.

FBWF is disabled by factory default in the operating system image for SIMATIC IPC and must be enabled and configured by the user.

When you enable FBWF, the write access to the C:\FBWF and D:\FBWF folders is enabled by default.

Comparison between EWF and FBWF

- You should preferably use FBWF, as this allows a more flexible configuration and immediate writing without rebooting.
- EWF is indispensable when HORM or compressed NTFS is used.

NOTICE

Activate only one write filter per partition - otherwise you risk data loss!

EWF and FBWF are preinstalled in the SIMATIC IPC images.

Ensure that only one write filter is enabled on a partition, otherwise you risk data loss!

Configuring the FBWF

The FBWF can be configured in the command console using the program FBWFMGR.EXE.

Note

- Observe the following syntax: You must always append a **space** character to the colon following the drive letter.
- You must restart the system to activate the changes for direct write access.
- Only existing files and folders can be included in the exception list.

Function	Command
Display the current FBWF status	fbwfmgr /displayconfig
Enable FBWF after the next startup	fbwfmgr /enable
Write to protected files	fbwfmgr /commit c: \Test.txt
Adding/removing elements in the exception list:	
• Add file	fbwfmgr /addexclusion C: \Test.txt
• Add folder	fbwfmgr /addexclusion C: \Test folder
• Remove file	fbwfmgr /removeexclusion C: \Test.txt
• Remove folder	fbwfmgr /removeexclusion C: \Test folder
Call up the help function	fbwfmgr /?

See also

Instructions on FBWF
[http://msdn.microsoft.com/en-us/library/aa940926\(WinEmbedded.5\).aspx](http://msdn.microsoft.com/en-us/library/aa940926(WinEmbedded.5).aspx)

5.4 Buffer memory MRAM (option)

The motherboard is equipped with MRAM that applications can use to backup data on power failure. Failure of the supply voltage for a duration longer than 5 ms is indicated by the DC FAIL signal.

The function provides at least the time it takes to copy the data to MRAM, which means that 128 KB can be saved with a full configuration.

A memory window with a maximum size of 512 KB can be displayed by means of PCI address register. The base address is initialized by the BIOS.

A corresponding function is implemented in BIOS to enable the use of MRAM in WinAC RTX.

Operating the device

6.1 Overview

The device variants differ with regard to their dimensions and display size.

The example in the following figure shows the front view of the 7" touchscreen variant.

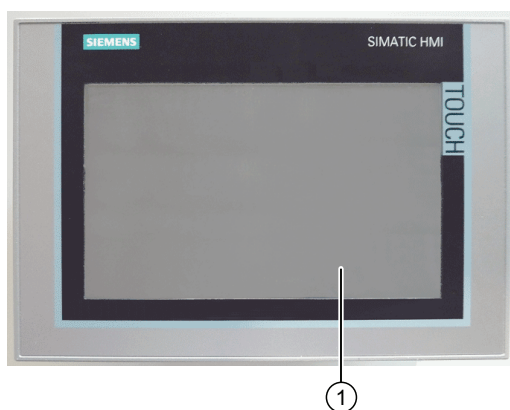

- ① Display with touchscreen

6.2 Operating the touch screen

Application-specific user interface elements, for example buttons, are shown on the display. Tapping a button with your finger activates the function assigned to the button.

WARNING

Incorrect operation of the touch screen

Incorrect operations at the touch screen cannot be excluded. Such actions may lead to personal injury or damage to the machine or plant.

Take the following precautions:

- Never use the touch screen to control safety-related functions.
- Use a suitable touch pen to operate the touch screen.
- Calibrate the touch screen regularly.
- Switch off the device for cleaning and maintenance.

The following types of pressure are permissible:

- Using a plastic pen with a 1 mm radius at the point: 25 g.
- Using a silicone finger with a diameter of 1.6 cm: 50 g.

Note

Only touch one point on the touch screen and not several points at one time, as this may trigger unintended reactions.

Do not touch the screen in the following situations:

- During the boot process
 - When plugging or unplugging USB components
 - While Scandisk is running
 - During active BIOS update
-

6.3 Configuring the touch screen

In its delivery state the touch screen of the device is already pre-calibrated. The following two calibration types are available to recalibrate the touch screen:

- Standard 3-point calibration
- Extended 25-point calibration

6.3.1 Standard calibration

Procedure

1. Select "Start > Programs > UPDD > Settings".

The "UPDD Console" dialog box opens.

Select the touch controller of the device you want to calibrate in the header of the dialog.

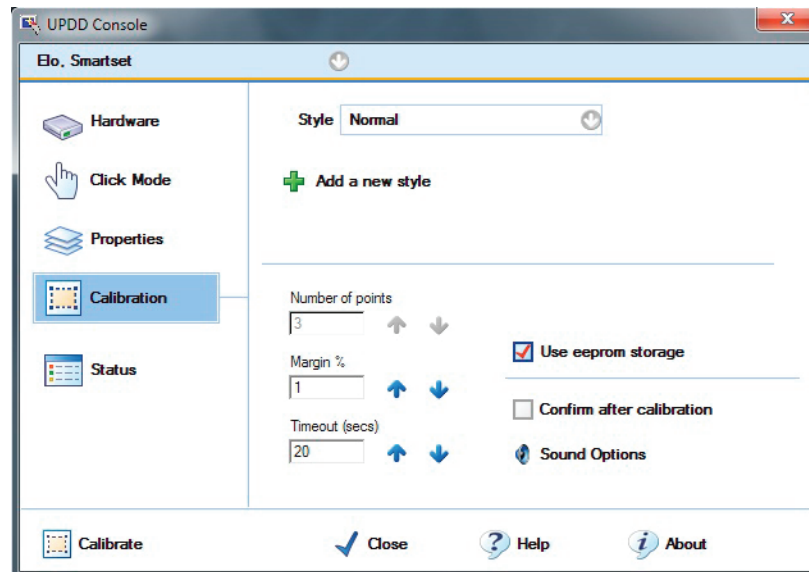

2. Click the "Calibration" tab.
3. Activate the option "Use eeprom storage". For Touch Controllers with EEPROM, the option box is pre-selected.
The option box "Number of points" shows "3-point calibration".
4. Click the button "Calibrate".
The calibration screen is displayed in the selected display.
5. Quickly touch the corresponding selections one after the other.
The entry is confirmed by a check mark, the next selection is displayed.
6. Confirm all input prompts (arrows, or crosses in the center) until the complete screen has been calibrated.

Note

If the screen does not respond to touch as expected, check the controller selected under "1." in "UPDD Console" and repeat the calibration. Only an active touch controller can be calibrated. A removed touch controller is displayed in red.

If the accuracy of this 3-point calibration is not sufficient, you can clear the "Use eeprom storage" option box and use the extended 25-point calibration instead.

6.3.2 Extended calibration

Procedure

1. Select "Start > Programs > UPDD > Settings".

The "UPDD Console" dialog box opens.

Select the touch controller of the device you want to calibrate in the header of the dialog.

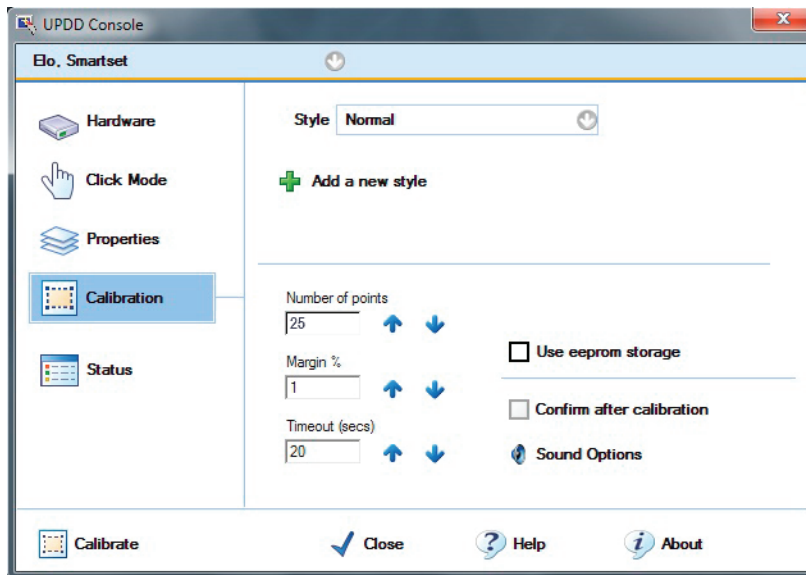

2. Click the "Calibration" tab.
3. Deactivate the option "Use eeprom storage".
4. Enter the value "25" under "Number of points".
5. Click the button "Calibrate".
The calibration screen is displayed in the selected display.
6. Touch the corresponding selections one after the other.
The entry is confirmed by a check mark, the next selection is displayed.
7. Confirm all input prompts (arrows, or crosses in the center) until the complete screen has been calibrated.
8. Finally, confirm the input prompt "Confirm".

6.3.3 Extended Touch touch functionality

Procedure

1. Select "Start > Programs > UPDD > Settings".

The "UPDD Console" dialog box opens.

Select the touch controller of the device you want to activate the extended touch functions for in the header of the dialog.

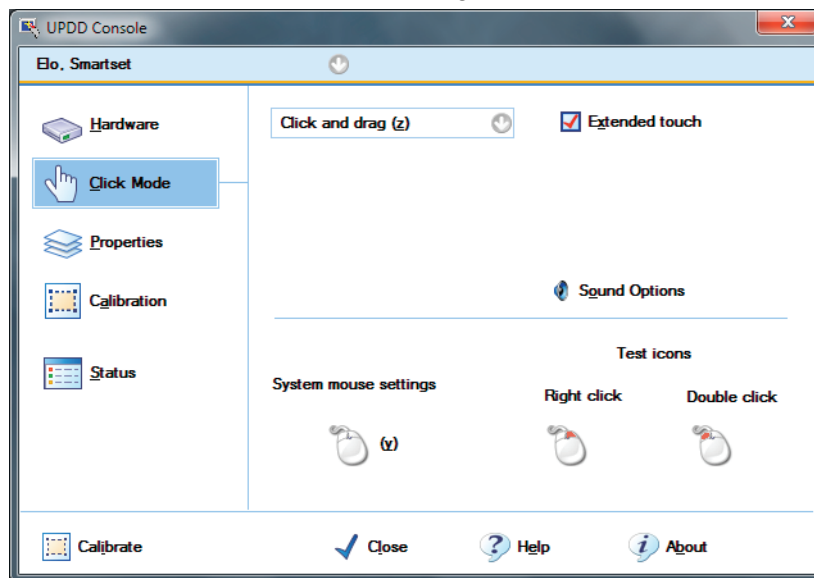

2. Select the "Click Mode" option.
3. Activate the option "Extended Touch".

Note

"Extended touch" is only available for the Windows 7 Ultimate operating system.

If "Extended touch" is activated, the extended touch functions of Windows 7 are also available, such as permanently touching the touch screen, which corresponds to the right mouse button function. In addition, the OSK is opened automatically at Windows logon and at the activation of entry fields.

6.4 Using the on-screen keyboard

You can operate the device by means of a virtual screen keyboard. You can use it to enter the characters directly on the touch screen or with the mouse. The virtual on-screen keyboard "HMITouchInput" is only pre-installed with Windows XP Professional and Windows Embedded Standard 2009. Windows Embedded Standard 7 and Windows 7 include an on-screen keyboard in the operating system.

Procedure



1. Open the screen keyboard via the "TouchInput" symbol on the desktop.



- ① Button for changing the language
2. Place the cursor in any input field in any program.
3. Enter the desired characters via the screen keyboard.

6.5 Setting the display brightness

Procedure



1. Open the dialog box for setting the brightness by clicking the "SetBrightness" icon on the desktop. The following figure shows the dialog box using an example with two devices.

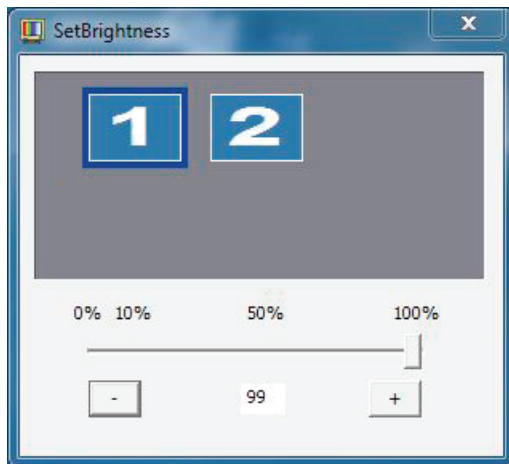

2. Select the device whose display brightness you want to change. In the example, device "1" is selected, all other devices are not selected.
3. Set the desired display brightness. You have the following setting options:
 - Using the slider. The set value is applied when you release the slider.
 - Using keyboard input in the text box
 - Using the "Increase brightness (+)" and "Decrease brightness (-)" buttons.

Note

The minimum value for the brightness setting is 10%. If you select a value of less than 10% using one of the setting options, the brightness value is automatically set to 10%.

6.6 Command line call

Call parameters

The "SetBrightness" program can be called in command line mode. The option "-?" (or incorrect parameters) displays a help text that explains the corresponding call parameters. If the "SetBrightness" program is started with the parameter "-experthelp", an extended help text is displayed. The "SetBrightness" program can be called in the command line with the following options:

SetBrightness.exe -ACTION [VALUE] [-device DEVICENUMBER]

Note

In contrast to the graphical interface, the minimum value is set to 0% in command line mode. In this case, the display is switched off. By pressing an input device, for example touch or keyboard, the display is switched on again and set to the most recent configured brightness level. The first input event, for example a mouse click, is discarded in this case to avoid the triggering an unintended action.

Parameter -ACTION [VALUE]

The "ACTION" parameter must be specified for each command line call of the "SetBrightness" program. The following options are available for selection:

Value	Explanation
-get	Returns the currently set brightness. There must not be any other value specified for VALUE.
-set	The brightness value specified by VALUE (0-100) is applied.
-getdevicecount	Supplies the number of connected displays. There must not be any other value specified for VALUE.

Option [-device DEVICENUMBER]

The "device" option can be specified for the command line call of the "SetBrightness" program. It specifies the number of the display for which the current brightness is to be read out or set. If the option is not used, the Display with the number 1 is always used. The following are examples of this:

SetBrightness -get	Returns the brightness of display "1".
SetBrightness -set 50 -device 2	Sets the brightness of display "2" to 50%.

Advanced options -plugin PLUGINNAME

To increase the execution speed, it can be specified explicitly for the command line call that not all available plugins are loaded, but rather only the plugin indicated by PLUGINNAME. Notice: The respective numbers of the operable displays are shifted accordingly. Example:

SetBrightness.exe -set 75 -device 2 -plugin FPPlugin.dll	Sets the brightness of display "2" to 75%. Only the "FPPlugin.dll" plugin is loaded.
--	--

6.7 Setting the screen saver

Note

If an additional display device connected to the PC during operation, the PC must be rebooted. During the start of Windows, the additional device is recognized by the service of the screensaver and integrated.

Procedure

1. Open the "Screen Saver Settings" dialog with "Start > Settings > Control Panel > Display".

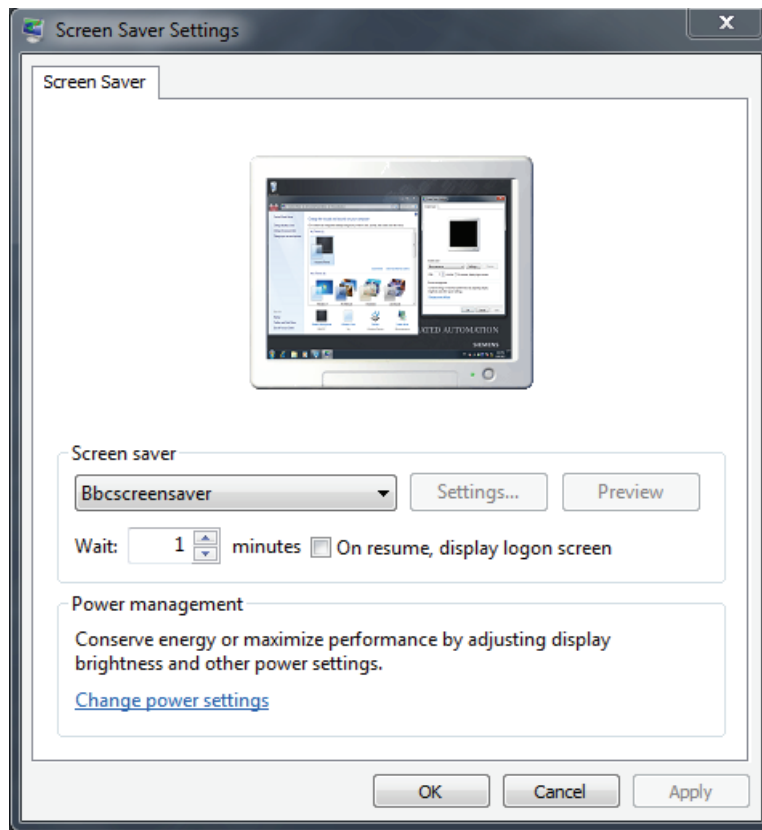

2. Select the "BbcScreenSaver" under "Screen Saver".
3. Click on the "Settings" button. The "BbcScreenSaver" dialog box opens.

The following figure shows the dialog box using an example with two devices. A secondary device is optional and is not supported by all devices.

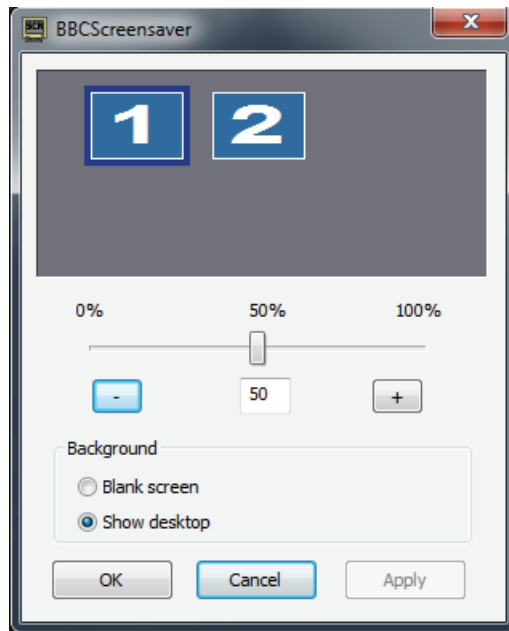

4. Set the desired brightness value for the activated display using the slider or the "-" and "+" buttons.

Note

The set value is retained following a restart and you can only change it in the "BBCScreenSaver" dialog box.

5. Under "Background" select from the following options:
 - "Blank screen": The desktop is shown with a black background.
 - "Show desktop": The desktop will be transparent.
6. Confirm the set values with "OK" or terminate the input with "Cancel" without saving the modified settings.

Note

If you set the value 0, the backlighting of all connected monitors is turned off.

6.8 WinMove

"WinMove" allows you to move program windows vertically in order to display window areas that extend beyond the display area. "WinMove" is available on devices with a vertical resolution of ≤ 600 pixels.

Procedure



1. Open "WinMove" using the corresponding icon on the desktop.

The "WinMove" window with the "Up" and "Down" buttons is displayed.



2. Move the open program window using the "Up" and "Down" buttons.

WinMove parameters

As soon as the "WinMove" window is visible, the "WinMove" icon is displayed in the taskbar:



By right-clicking on the "WinMove" icon, you open the "WinMove" shortcut menu:

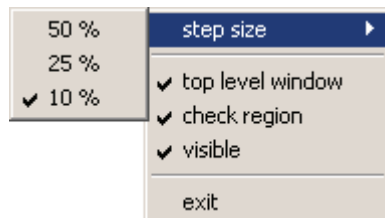

Via the shortcut menu, you can set the following WinMove parameters:

- "Step size": Determines the increment when you press the "Up" and "Down" buttons.
- If "top level window" is activated, only the program window in the foreground is moved. Otherwise, all open program windows are moved.
- If "check region" is activated, it is not possible to move program windows completely out of the desktop area.

Note

If the taskbar parameter "Auto-hide the taskbar" is not activated, windows which are moved downwards can disappear behind the taskbar, even if the "WinMove" parameter "check region" is activated.

- With the "visible" parameter, you display or hide the "WinMove" window.

Use "exit" to end WinMove.

Device expansion and parameter assignment

7.1 Open the device.

Observe the information in section "ESD guideline (Page 93)".

Requirement

- The device is disconnected from the power supply.
- All cables have been disconnected from the device.
- The device has been removed from the control cabinet.
- A T10 screwdriver

Procedure - opening IPC277D 7" and 9"

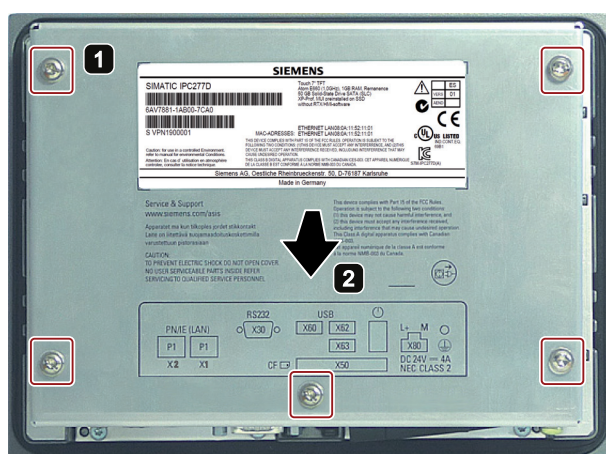

- 1 Remove the marked screws
- 2 Remove the rear panel.

Procedure: opening IPC277D 12", 15" and 19"

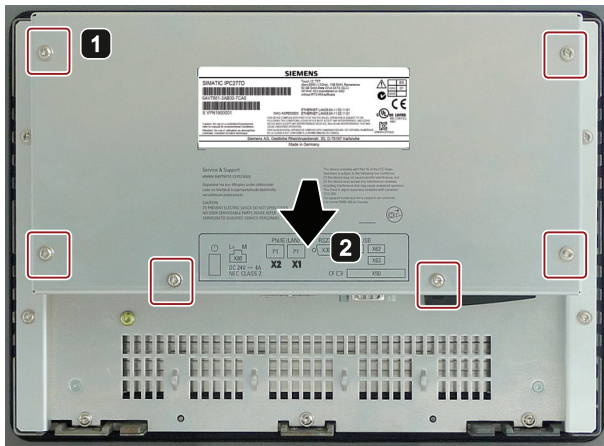

- 1** Remove the marked screws
- 2** Remove the rear panel.

Procedure - closing the device.

Close the device in reverse order.

See also

Replacing drives of IPC277D 7" and 9" (Page 74)

7.2 Inserting and removing CompactFlash cards

The device is equipped with a slot for a CF memory card type I/II.

Requirement - removing the CF memory card

- The device is switched off.

Procedure

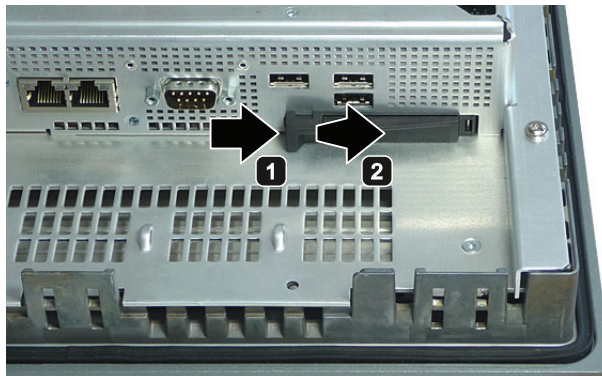

- 1** Release the lock of the cover.
Grip the cover on its rear side in direction of the arrow.
- 2** Open the cover completely.

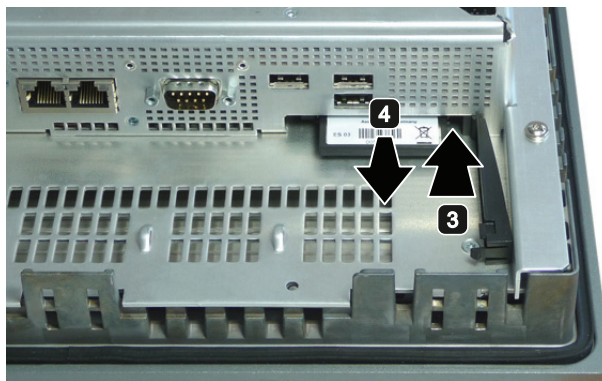

- 3** Press the ejector button.
The memory card is pushed out of the slot.
- 4** Pull the memory card out of the slot.
Grip the memory card on its web on the bottom side when pulling it out.

Requirement - inserting the CF memory card

- A CF memory card that is approved for industrial use.

This device is only approved for operation with CF memory cards as of product version 03.

Note

Always replace the CF memory card with a card of the same product version.

Procedure

Note

Insert the CF card into the slot without applying excess force.

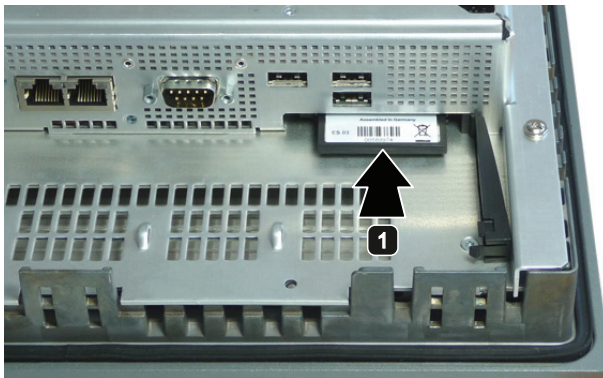

- 1** Insert the memory card into the memory card slot as shown in the figure.

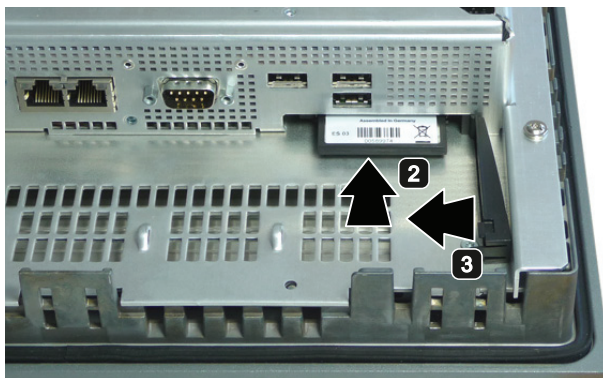

- 2** Push the memory card into the slot.
The memory card is properly inserted if you can close the cover without noticeable resistance.
- 3** Close the cover.

Device maintenance and repairs

8.1 Cleaning the Device Front

The device is designed for low-maintenance operation. You should still clean the device front regularly, however.

CAUTION

Unwanted reactions when cleaning the device

You risk unintentional actuation of control elements if you clean the device while it is switched on.

You may possibly trigger unwanted actions of the device or controller that are liable to cause personal injury or damage to the machinery.

Always switch off the device before you clean it.

Cleaning Agents

NOTICE

Damage to the HMI device caused by impermissible cleaning agents

Impermissible and unsuitable cleaning agents may cause damage to the HMI device.

Use dish soap or foaming screen cleaner only as cleaning agents. Do not use the following cleaning agents:

- Aggressive solvents or scouring powder
- Steam jets
- Compressed air

Cleaning the Device Front

1. Switch off the device.
2. Dampen the cleaning cloth.
3. Spray the cleaning agent on the cloth and not directly on the device.
4. Clean the device with the cleaning cloth.

8.2 Installing and removing hardware

8.2.1 Repair information

Carrying out repairs

Only qualified personnel are permitted to repair the device.

 **WARNING**

Unauthorized opening and improper repairs on the device may result in substantial damage to equipment or endanger the user.

- Always disconnect the power plug before you open the device.
- Only install system expansion devices designed for this device. If you install other expansion devices, you may damage the device or violate the safety requirements and regulations on RF suppression. Contact your technical support team or where you purchased your PC to find out which system expansion devices may safely be installed.

If you install or exchange system expansions and damage your device, the warranty becomes void.

 **CAUTION**

Electrostatic sensitive devices (ESD)

The device contains electronic components which are destroyed by electrostatic charges. This can result in malfunctions and damage to the machine or plant.

Therefore, make sure you take precautionary measures even when you open the device, for example, when opening device doors, device covers or the housing cover. For more information, refer to the section "ESD Guideline (Page 93)"

Limitation of Liability

All technical specifications and approvals of the device only apply if you use expansion components that have a valid CE approval (CE mark). The installation instructions for expansion components in the associated documentation must be observed.

UL approval of the device only applies when the UL-approved components are used according to their "Conditions of Acceptability".

We are not liable for functional limitations caused by the use of third-party devices or components.

Tools

Tools to open the device, see section "Opening the device". You can make repairs on the device with the following tools:

- T20 screwdriver for protective conductor connection
- T10 screwdriver for all of the remaining screws

8.2.2 Maintenance

To maintain high system availability, we recommend the preventative replacement of those PC components that are subject to wear in accordance with the intervals for replacement indicated in the table below.

Component	Replacement interval:
CMOS backup battery	4 years

Product can only be delivered without storage media

Note

If a replacement device is available from stock at short notice, the order number of the replacement is listed on the rating plate. The replacement device is always supplied without mass storage media (CF and/or SSD).

- If you order a replacement device, remove all storage media (SSD, CompactFlash card etc.) from your device and insert them into the new device.
-

8.2.3 Replacing the backup battery

Prior to replacement

 WARNING
Risk of explosion and release of harmful substances Improper handling of lithium batteries can result in an explosion of the batteries. Explosion of the batteries and the released pollutants can cause severe physical injury. Worn batteries jeopardize the function of the device. Note the following when handling lithium batteries: <ul style="list-style-type: none">• Replace the battery every 4 years.• Replace the lithium battery only with an identical battery or types recommended by the manufacturer. The order number is A5E00331143.• Do not throw lithium batteries into fire, do not solder on the cell body, do not recharge, do not open, do not short-circuit, do not reverse polarity, do not heat above 100°C and protect from direct sunlight, moisture and condensation.

NOTICE
Disposal of batteries and rechargeable batteries Do not dispose of used batteries and rechargeables in household waste. Users are obliged by law to return used batteries and rechargeable batteries. Used batteries and rechargeable batteries pollute the environment as hazardous waste. Improper disposal of used batteries and rechargeables renders you liable to prosecution. When disposing of rechargeable batteries, observe the following: <ul style="list-style-type: none">• Dispose of used batteries and rechargeable batteries separately as hazardous waste in accordance with local regulations.• You can return used batteries and rechargeables to public collection points and wherever batteries and rechargeable batteries of the type in question are sold.• Label the battery container with "Used batteries and rechargeable batteries".

Requirement

- The device is disconnected from the power supply.
- The device is opened.

Procedure - removal

NOTICE

Time may be deleted

The time will be deleted if it takes you longer than 30 seconds to replace the battery. The device is no longer synchronous. Time-controlled programs will no longer run or will run at the wrong time. This may damage the plant.

Reset the time for the device.

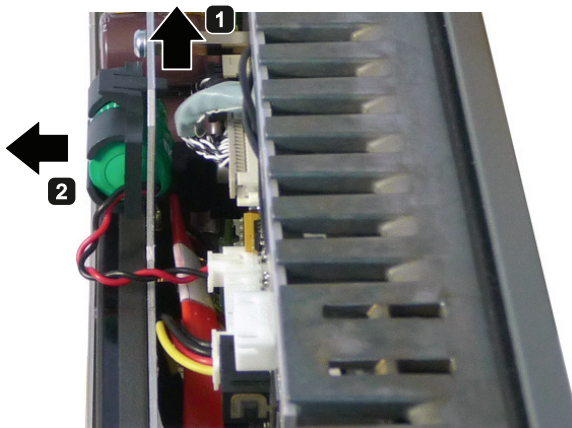

- 1 Pull the hook in direction of the arrow.
- 2 Push the battery holder in the direction of the arrow while keeping the hook pulled.

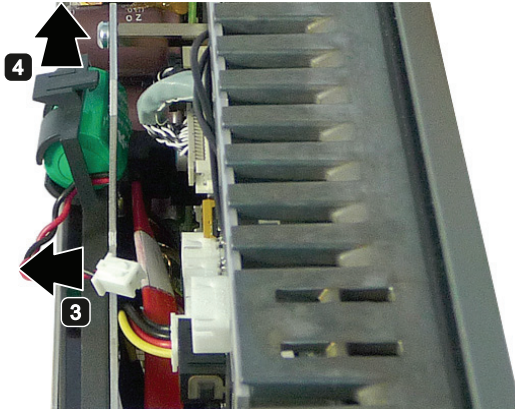

- 3 Disconnect the battery plug
- 4 Remove the battery and battery holder.



- 5 Lift up the battery and pull the connecting cable out of the battery holder.

Procedure - installation

Follow the steps in reverse to install the replacement battery and close the device.
Remember the following:

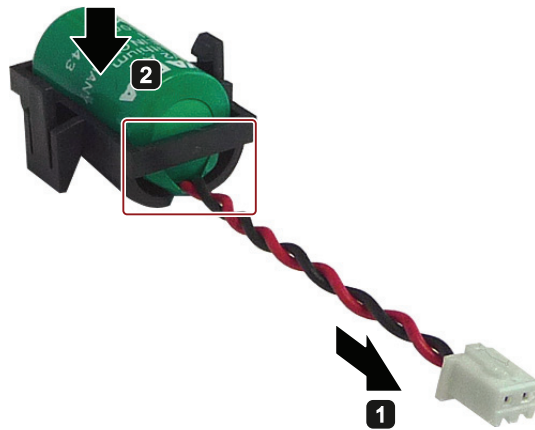

- 1** Pull the connecting cable through the opening underneath the marked web.
- 2** Insert the battery into the battery holder.

See also

Open the device. (Page 65)

8.2.4 Replacing drives of IPC277D 7" and 9"

Carry out the procedure if you want to replace an SSD with an SSD.

Please observe the information in section "Repair information (Page 70)".

Requirement

- The device is opened.
See section "Open the device. (Page 65)".
- An SSD
- A T10 screwdriver

Procedure - removal

For information on the removal of the backup battery and battery holder, refer to section "Replacing the backup battery (Page 72)".

Note

Do not remove the battery connector. If you remove the battery connector, you will have to reinstall the BIOS.

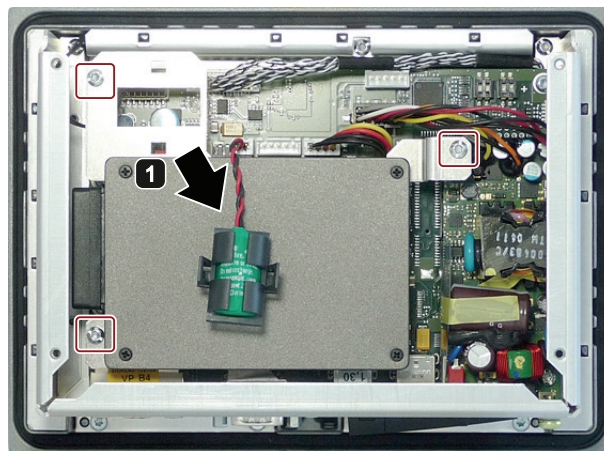

- 1 Remove the battery holder.
- 2 Remove the marked screws.

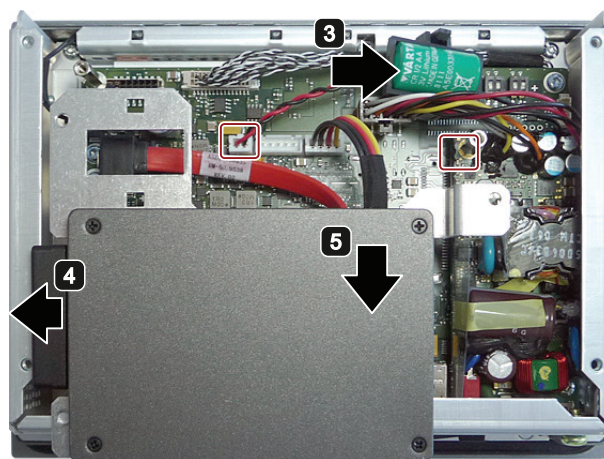

- 3 Put down the backup battery. The marked connector must remain connected.
- 4 Remove the connector from the SDD
- 5 Remove the drive and put it aside.

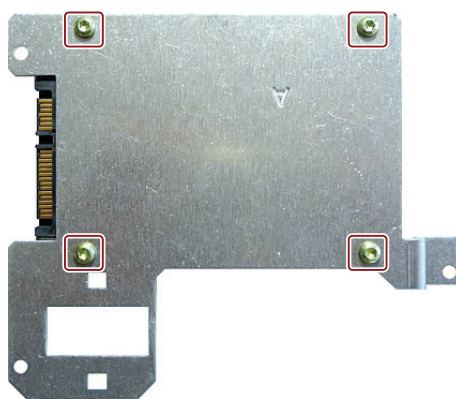

- 6 Remove the marked screws.
- 7 Put down the drive carrier panel and the drive.

Procedure - installation

For installation, follow these steps in reverse and close the device.

8.2.5 Replacing the drive of an IPC277D 12", 15" and 19"

Carry out the procedure if you want to replace the SSD.

Please observe the information in section "Repair information (Page 70)".

Requirement

- The device is opened. See section "Open the device. (Page 65)".
- An SSD
- A T10 screwdriver

Procedure - removal

For information on the removal of the backup battery and battery holder, refer to section "Replacing the backup battery (Page 72)".

Note

Do not remove the battery connector. If you remove the battery connector, you will have to reinstall the BIOS.

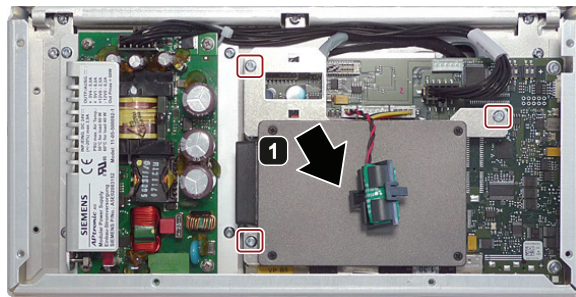

- 1** Remove the battery holder.
- 2** Remove the marked screws.

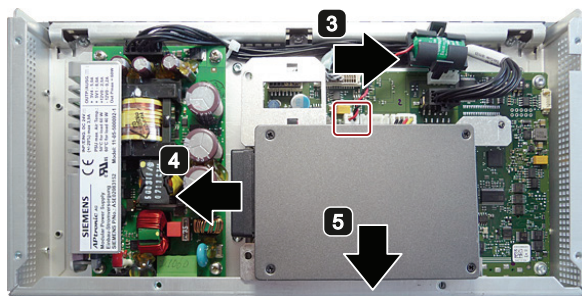

- 3** Put down the backup battery. The marked connector must remain connected
- 4** Pull off the connector.
- 5** Remove the drive and put it aside.

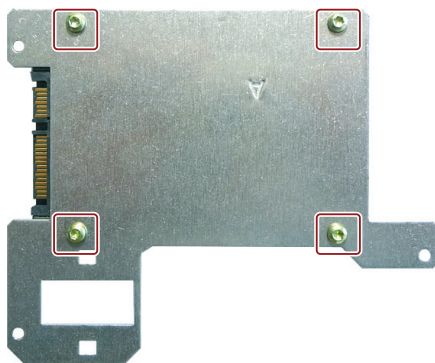

- 6** Remove the marked screws.
- 7** Put down the drive carrier panel and the drive.

Procedure - installation

For installation, follow these steps in reverse and close the device.

8.3 Installing the software

8.3.1 Reinstalling the operating system

8.3.1.1 General installation procedure

If your operating system is no longer functioning correctly, you can reinstall it in one of two ways:

- With the recovery DVD and "Documentation and Drivers" CD/DVD
- With the restore DVD.

Recovery DVD

The recovery DVD contains the installation program with tools for configuring the drives and installing the operating system and the supported languages (MUI package).

The basic language of the installed operating system is English. To add other languages, install these languages from the Recovery DVD at a later time.

"Documentation and Drivers" CD/DVD

The "Documentation and Drivers" CD/DVD contains the documentation and the hardware drivers.

Restore DVD

The Restore DVD is included in the scope of delivery when you have ordered a device with operating system. The DVD contains an image file with the original software package: Operating system with installed hardware drivers and monitoring software, e.g. DiagBase.

8.3.1.2 Restoring the factory state

You can restore the original factory software using the Restore DVD. The DVD contains the necessary images and tools for transferring the factory software to the drive of your device. Restoration of the entire C drives: (system) and D: or only drive C: is possible. This allows you to retain any user data on drive D:.

Retrieving authorization or license

- Check whether you can retrieve your authorization or license key from the disk and perform this procedure if possible.
- If backup is not possible, please contact Customer Support. There you can obtain information necessary for software authorization.

Procedure

NOTICE
Data loss If "Restore system partition only" is set all data on drive C: (system partition) will be deleted. All data, user settings and all authorizations or license keys on drive C: are lost! All data on drive C: will be completely deleted, reformatted and overwritten with the original factory software. The "Restore entire hard disk" option deletes all data, user settings, authorizations and license keys on the entire drive.

1. Enable "USB Boot" in the BIOS setup.
2. Connect a DVD drive to the USB interface.
3. Insert the Restore DVD into the DVD drive.
4. Reboot the device.
5. Press the <F12> key when the following BIOS message appears:

Press <F2> to go to Setup Utility

Press <F12> to go to Boot Manager

After initialization, a boot menu is displayed.

6. Select the optical drive using the cursor keys.

Example:

USB-ODD : Optical Disk Drive

7. Follow the on-screen instructions.

8.3.1.3 Installing Windows XP

Note

Specific information on the use of the Windows XP Professional operating system is available in the following manual (not included in the scope of delivery):

Microsoft Windows XP Professional, Technical Reference (MSPress No. 934)

Requirement

You need the following hardware and software:

- A USB DVD-ROM drive
- A USB disk drive
- A USB hub
- Driver disk for the AHCI controller
You will find information on setting up the driver disk on the "Documentation and Drivers" CD/DVD.
- Recovery DVD for the operating system you want to install, which is included in the scope of delivery.

Procedure

1. Enable "USB Boot" in the BIOS setup.
2. Connect the disk drive to the USB port.
3. Insert the driver disk into the disk drive.
4. Connect the DVD drive to the USB port.
5. Insert the Recovery DVD into the DVD drive.
6. Reboot the device.
7. Press the <F12> key when the following BIOS message appears.

Press F2 to go to Setup Utility

Press F12 to go to Boot Manager

After initialization, a boot menu is displayed.

8. In the boot menu, select the optical drive using the cursor keys.

Example:

USB-ODD : Optical Disk Drive

9. Confirm the selection by pressing ENTER.

8.3 Installing the software

10. **Immediately** press any key when you see the following prompt to install the operating system from the Recovery DVD.

Press any key to boot from CD ..

A blue background followed by the Windows XP installation program appears after a few seconds.

11. Press the <F6> key repeatedly as soon as the blue background appears.

The dialog box for installing data carrier controllers will be displayed in a few seconds.

Select the driver for the AHCI controller on the driver disk.

12. Follow the instructions of the Windows XP installation program.

Windows XP installation program

The language of the installation program and the Windows XP Professional operating system is preset to English. You can change the language of Windows XP Professional once you have installed it. You can find information on this in section: Setting up the language selection by means of the Multilanguage User Interface (MUI) (Page 85).

Partitions in the factory state for Windows XP

The recommended minimum size of the partition on which you want to install Windows XP varies depending on how much work memory and which additional software you want to use. Information on partitioning of the data carrier in the factory state is provided in the following table.

Partition	Name	Size	File system
First	SYSTEM	25 GB	NTFS not compressed
Second	DATA	Remainder	NTFS not compressed

8.3.1.4 Installation of Windows 7

Note

Specific information on using the Windows operating systems is available in the following manual (not included in the scope of delivery): Windows 7 Technical Reference (MS Press No. 5913)

Requirement

- A USB DVD-ROM drive
- Recovery DVD for the operating system you want to install, which is included in the scope of delivery.

Procedure

1. Enable "USB Boot" in the BIOS setup.
2. Connect the DVD drive to the USB port.
3. Insert the recovery DVD into the DVD drive.
4. Reboot the device.
5. Press the <F12> key when the following BIOS message appears.

Press F2 to go to Setup Utility

Press F12 to go to Boot Manager

After initialization, a boot menu is displayed.

6. In the boot menu, select the optical drive using the cursor keys.

Example:

USB-ODD : Optical Disk Drive

7. Confirm the selection by pressing ENTER.
8. **Immediately** press any key when you see the following prompt to install the operating system from the Recovery DVD.

Press any key to boot from CD or DVD ..

After a few seconds, you will see the "Install Windows" installation program.

9. Now follow the instructions in the installation program. You can find additional information on this in the section: "Install Windows" installation program.

"Install Windows" installation program

The language of the installation program and the operating system you want to install has been preset to English. You can change the language of the operating system after the installation. You can find information on this in section: Setting up the language selection by means of the Multilanguage User Interface (MUI) (Page 85).

Setting up partitions and integrating unknown data carrier controllers into the operating system

You can set up partitions during the installation process and integrate data carrier controllers that are unknown to the operating system. To do so, select "Custom (advanced)" when prompted for the installation type in the "Install Windows" installation program.

The following dialog windows are then available (example):

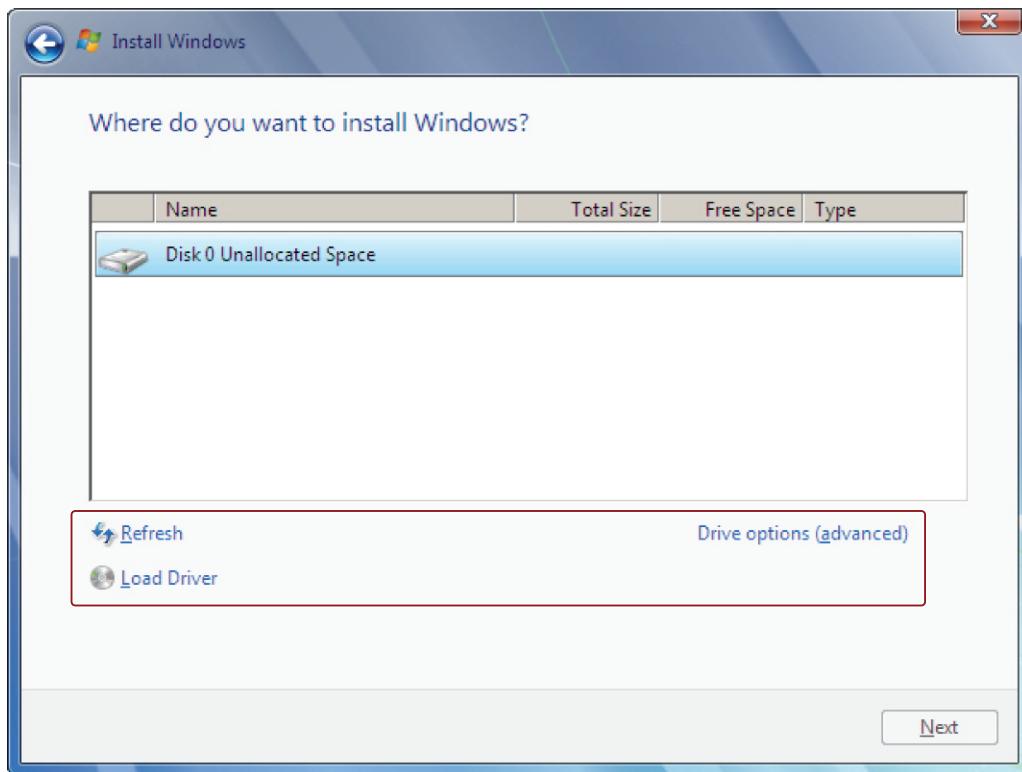

Refresh	Update
Load Driver	Integration of controller drivers unknown to the operating system and required for installation. Note the information in Section "Information for systems with RAID, AHCI, or SAS controllers (optional)".
Drive options (advanced)	For display of additional functions that you can use to set up the data carriers, see figure "Windows installation window "Drive options (advanced)".

Windows installation window "Drive options (advanced)":

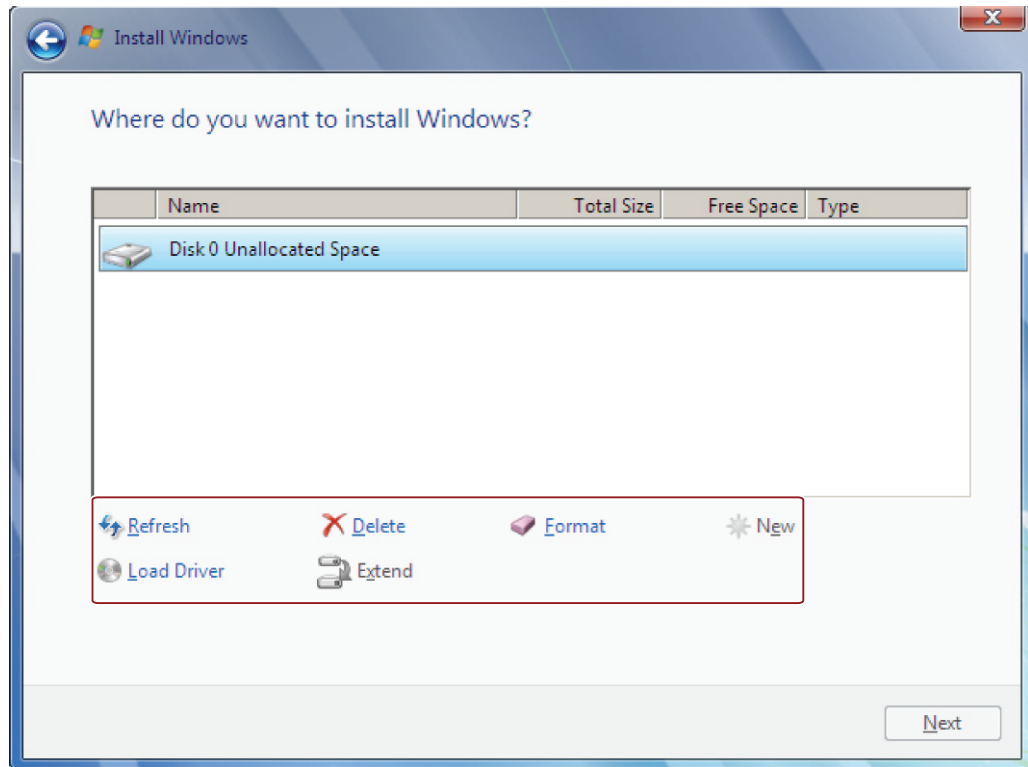

Refresh	Update
Load Driver	Integration of controller drivers unknown to the operating system and required for installation. Note the information in Section "Information for systems with RAID, AHCI, or SAS controllers (optional)".
Delete	Deleting a partition
Extend	Changing the partition size
Format	Formatting a partition
New	Creating new partitions
	Identification for error messages, for example, if the data carrier was not formatted in the required "NTFS" format.

Procedure

Note

If you want to install the operating system on a data carrier connected to a data carrier controller unknown to the operating system, you have to integrate the driver of the data carrier controller. Integrate this driver before starting the partitioning of the data carrier and installing the operating system, see Section "Information for systems with data carrier controller".

1. Make sure that the partition on which you want to install the operating system is large enough and is set up with a NTFS file system.

The recommended minimum size of this partition varies, depending on the operating system, how much RAM you have available and how much additional software you want to use. Information on how the data carrier is partitioned in its factory state is available in the following tables.

2. Select the partition on which you want to install the operating system.
3. Click "Next".

Installation is started.

Examples of partitions in the factory state

Windows 7 32 bit:

Partition	Name	Size	File system
First	SYSTEM	25 GB	NTFS not compressed
Second	DATA	Remainder	NTFS not compressed

Information for systems with data carrier controller

Data carrier controllers unknown to the operating system must be made known to the operating system prior to installation in the "Install Windows" installation program.

Requirement

You have copied the relevant controller driver to a USB stick.

Procedure

1. Connect the USB stick with the controller driver to the device.
2. Start the "Install Windows" installation program as described above.
3. Select "Load Drivers" in the Windows installation window.
4. Select the respective driver on the USB stick.

8.3.1.5 Setting up the language selection by means of the Multilanguage User Interface (MUI)

You can set the display of menus, dialogs or other information, such as date and time, to a different language. For this purpose, you can either select one of the preinstalled languages or install a new language package.

The following command sequences are described in English. Depending on the default setting, they can be displayed in another language.

Setting up the language selection for Windows XP Professional

Note

Specific information on setting up the language selection for Windows XP Professional can be found in Manual "Microsoft Windows XP Professional, Technical Reference (MSPress No. 934)", not included in the scope of delivery.

Changing the settings for language, region and formats of a registered user account

1. Choose:
"Start > Control Panel > Regional and Language"
2. You can make the desired changes in the "Regional Settings", "Languages" and "Advanced" tabs.

Installing new language packages

1. Start the "MUISETUP.EXE" program in the "MUI" folder from the Recovery DVD.
All languages that can be installed are displayed.

Setting up the language selection in Windows 7

Note

Specific information on setting up the language selection for Windows operating systems can be found in Manual "Windows 7, Technical Reference (MSPress No. 5913)", not included in the scope of delivery.

Changing the settings for language, region and formats of a registered user account

1. Choose:
"Start > Control Panel > Clock, Language, and Region > Regional and Language Options"
2. You can make the desired changes in the "Formats" and "Location und Keyboards and Languages" tabs.

8.3 Installing the software

Changing the settings for language, region and formats of the system account and the standard user account

You can change the settings for language, region and formats of the system account (for example, the language in the user login dialog) and the settings of the standard user account (standard setting for new users). The settings of the registered user are copied to the system account and the standard user account for this purpose.

1. Choose:
"Start > Control Panel > Clock, Language, and Region > Regional and Language Options"
2. You can make the required changes in the "Administrative" tab. You copy the settings by clicking the respective button.

Installing new language packages

Some language packages are available on the Recovery DVD in the "Languagepacks" folder.

1. Choose:
"Start > Control Panel > Clock, Language, and Region > Regional and Language Options"
2. Select the "Keyboards and Languages" tab.
3. Click the "Install/uninstall languages" button and make the required changes.

8.3.2 Partitioning data media

8.3.2.1 Partitions in Windows Embedded Standard 2009 and Windows Embedded Standard 7

You need to reset the partitions after installing a new drive if the partitions are corrupt or if you want to change the layout of the partitions.

Partitioning the CompactFlash card

In the factory state, the following partitions are set up on the CompactFlash card:

Partition	Name	Card size				File system
		2 GB	4 GB	8 GB	16 GB	
1. Partition	SYSTEM	1536 MB	2560 MB (WES2009) 3690 MB (WES7)	5120 MB (WES2009) 6150 MB (WES7)	10240 MB	NTFS (compressed)
2. Partition	DATA	Remainder	Remainder	Remainder	Remainder	NTFS (compressed)
3. Partition	WinCCMB	32 MB ¹	32 MB ¹	32 MB ¹	32 MB ¹	NTFS (compressed)

¹ Only for devices with bundle software

Partitioning the SSD

In the factory state, the following partitions are set up on the SSD:

Partition	Name	Size	File system
1. Partition	SYSTEM	25 GB	NTFS (compressed)
2. Partition	DATA	Remainder	NTFS (compressed)
3. Partition	WinCCMB	32 MB ¹⁾	NTFS (compressed)

¹⁾ Only for devices with bundle software

To restore the original partition of the factory state, we recommend you use the software tool "SIMATIC IPC Image & Partition Creator".

8.3.2.2 Partitions under Windows 7 Ultimate and Windows XP Professional

You need to reset the partitions after installing a new drive if the partitions are corrupt or if you want to change the layout of the partitions.

Partitioning the SSD

In the factory state, the following partitions are set up on the SSD:

Partition	Name	Size	File system
1. Partition	SYSTEM	25 GB	NTFS (not compressed)
2. Partition	DATA	Remainder	NTFS (not compressed)

To restore the original partition of the factory state, we recommend you use the software tool "SIMATIC IPC Image & Partition Creator".

8.3.2.3 Adapting partitions in Windows 7 Ultimate and Windows Embedded Standard 7

With the disk management, you can adapt the partitioning of your drives.

You can reduce or delete an available partition to acquire unassigned memory space, which you can use to set up a new partition or to increase an existing partition.

Note

Data lost in the case of deleting a partition!

If you delete a partition, all the data on this partition is lost.

Back up your data before you change partitions.

Requirement

You are logged on as an administrator.

Reduce partition

1. Click with the right mouse button on the partition to be reduced and click on "Reduce size".
2. Follow the instructions.

Increase partition

Note

To increase a partition, this partition must not be formatted with a data system or the partition must be formatted with an "NTFS" data system.

1. Click in the partition manager with the right mouse button on the partition to be increased and click on "Increase size".
2. Follow the instructions on the screen.

Additional information is available in the "Help" menu under "Help topics" and "Search".

8.3.2.4 Adapting partitions in Windows XP and Windows Embedded Standard 2009

In order to adapt partitions, we recommend you use the software tool SIMATIC IPC Image & Partition Creator. Detailed information about using this tool is available in the manufacturer documentation.

8.3.3 Drivers and software

8.3.3.1 Driver installation for Windows Embedded Standard 7 and 2009

The drivers for Windows Embedded Standard are installed as in Windows XP Professional. Pay attention to the installation instructions of the driver manufacturer.

Procedure

If the message "Windows XP installation CD required" appears when you install drivers, proceed as follows:

1. If your device has no CD/DVD drive, connect an external USB CD/DVD drive to a USB port.
2. Insert the recovery CD/DVD.
3. The necessary ".cab" files can be found in the "\Drivers_WES" folder. Unpack the ".cab" files to a folder on the local hard disk.
4. Disable the Enhanced Write Filter before installing drivers and enable it again when you are finished.

8.3.3.2 Installing drivers and software

Introduction

Note

In the case of multilingual operating systems (MUI versions), you have to set the regional settings for menus and dialogs and the default language to English (US) before you install new drivers or operating system updates.

Procedure

1. If your device has no CD/DVD drive, connect an external USB CD/DVD drive to a USB port.
2. Insert the "Documentation and Drivers" CD/DVD provided.
3. Start the "START" program.
4. Select "Drivers" from the index.
5. Select the device and operating system.
6. Select the desired driver
7. Open the folder with the driver data by clicking on the link next to "Driverpath".
8. Start the setup program in this folder.

Note

For a new installation of Windows operating systems, the chipset driver must be installed before all other drivers, if required.

8.3.4 Installing updates

8.3.4.1 Updating the operating system

Windows

The latest updates for the Windows operating system are available on the Internet at Microsoft (<http://www.microsoft.com>).

Note

Before you install new drivers or operating system updates for Windows MUI versions, configure the regional menu and dialog settings and the default English (US) language.

8.3 Installing the software

Other operating systems

Contact the corresponding manufacturer.

8.3.4.2 Installing or updating application programs and drivers

To install software from a CD and/or floppy disk in a Windows operating system, you must connect a suitable external USB drive to the computer.

The drivers for USB floppy drives and USB CD-R drives are included in the operating system and do not have to be installed separately.

For information about installation of SIMATIC software packages, refer to the corresponding manufacturer documentation.

For updates of third-party drivers and application programs, contact the respective manufacturer.

Data backup under Windows Embedded Standard 2009 and Windows Embedded 7 / Windows XP Professional / Windows 7 Ultimate

We recommend you use the **SIMATIC IPC Image & Partition Creator** software tool (V3.2 or higher) for data backups in Windows Embedded Standard / Windows XP Professional / Windows 7 Ultimate. This tool provides comfortable and efficient functions for backup and restoring the full content of CompactFlash cards, hard disks, and of individual partitions (images).

SIMATIC IPC Image & Partition Creator supports the burning of DVD media only. You can order the tool using the Siemens online ordering system (<http://www.siemens.com/automation/mall>). For more information about SIMATIC IPC Image & Partition Creator, refer to its product documentation.

Note

The SIMATIC Image & Partition Creator only supports the LAN 2 interface (Intel® 82574L Gigabit Network Connection).

Technical specifications

9.1 Certificates and approvals

CE marking



The device meets the requirements and safety specifications of the EMC Directive 2004/108/EC "Electromagnetic Compatibility".

EC Declaration of Conformity

The corresponding documentation is available on the Internet at: SIMATIC IPC277D certificates (<http://support.automation.siemens.com/WW/view/en/48958258/134200>).

DIN ISO 9001 certificate

The Siemens quality management system for all production processes (development, production and sales) meets the requirements of DIN ISO 9001:2000.

This has been certified by DQS (the German society for the certification of quality management systems).

Certificate registration no. DE-000656 QM08

Software license agreements

If the device is supplied with preinstalled software, you must observe the corresponding license agreements.

UL approval



Underwriters Laboratories (UL) complying with standard UL 508 and C22.2 No. 142 (IND.CONT.EQ)

FCC and Canada

USA	
Federal Communications Commission Radio Frequency Interference Statement	This equipment has been tested and found to comply with the limits for a Class A digital device, pursuant to Part 15 of the FCC Rules. These limits are designed to provide reasonable protection against harmful interference when the equipment is operated in a commercial environment. This equipment generates, uses, and can radiate radio frequency energy and, if not installed and used in accordance with the instruction manual, may cause harmful interference to radio communications. Operation of this equipment in a residential area is likely to cause harmful interference in which case the user will be required to correct the interference at his own expense.
Shielded Cables	Shielded cables must be used with this equipment to maintain compliance with FCC regulations.
Modifications	Changes or modifications not expressly approved by the manufacturer could void the user's authority to operate the equipment.
Conditions of Operations	This device complies with Part 15 of the FCC Rules. Operation is subject to the following two conditions: (1) this device may not cause harmful interference, and (2) this device must accept any interference received, including interference that may cause undesired operation.
CANADA	
Canadian Notice	This Class A digital apparatus complies with Canadian ICES-003.
Avis Canadien	Cet appareil numérique de la classe A est conforme à la norme NMB-003 du Canada.

AUSTRALIA / NEW ZEALAND



This product meets the requirements of EN 61000-6-4:2007 Generic standards - Emission standard for industrial environments.

This product meets the requirements of the standard EN 61000-6-4:2007 Generic standards – Emission standard for industrial environments.

KOREA



This product meets the requirements of Korean certification.

This product satisfies the requirement of the Korean Certification (KC Mark).

이 기기는 업무용(A급) 전자파 적합기기로서 판매자 또는 사용자는 이 점을 주의하시기 바라며 가정 외의 지역에서 사용하는 것을 목적으로 합니다.

Shipbuilding approvals

The following shipbuilding approvals are provided for the device. After acceptance, the certificates will be made available under the following address on the Internet: SIMATIC IPC277D certificates

(<http://support.automation.siemens.com/WW/view/en/48958258/134200>).

- ABS American Bureau of Shipping (USA)
- BV Bureau Vertias (France)
- DNV Det Norske Veritas (Norway)
- GL Germanische Lloyd
- LR Lloyds Register of Shipping
- Class NK Nippon Kaiji Kyokai (Japan)

9.2 Directives and declarations

9.2.1 Electromagnetic compatibility for industrial environments

This product meets the requirements of EC Directive 2004/108/EC "Electromagnetic Compatibility".

The device is designed for the following areas of application corresponding to the CE marking:

Scope of application	Requirements for	
	Interference emission	Immunity to interference
Industrial area	EN 61000-6-4:2007	EN 61000-6-2:2005

9.2.2 ESD guideline

What does ESD mean?

An electronic module is equipped with highly integrated components. Due to their design, electronic components are highly sensitive to overvoltage and thus to the discharge of static electricity. Such electronic components or modules are labeled as electrostatic sensitive devices.

The following abbreviations are commonly used for electrostatic sensitive devices:

- ESD – Electrostatic sensitive device
- ESD – Electrostatic Sensitive Device as a common international designation

Electrostatic sensitive devices can be labeled with an appropriate symbol.



NOTICE

Damage to ESD from touch

Electrostatic sensitive devices, ESD, can be destroyed by voltages which are far below the human perception limit. If you touch a component or electrical connections of a module without discharging any electrostatic energy, these voltages may arise.

The damage to a module by an overvoltage can often not be immediately detected and only becomes evident after an extended period of operation. The consequences are incalculable and range from unforeseeable malfunctions to a total failure of the machine or system.

Avoid touching components directly. Make sure that persons, the workstation and the packaging are properly grounded.

Charge

Every person without a conductive connection to the electrical potential of his/her surroundings can be electrostatically charged.

The material with which this person comes into contact is of particular significance. The figure shows the maximum electrostatic voltages with which a person is charged, depending on humidity and material. These values conform to the specifications of IEC 61000-4-2.

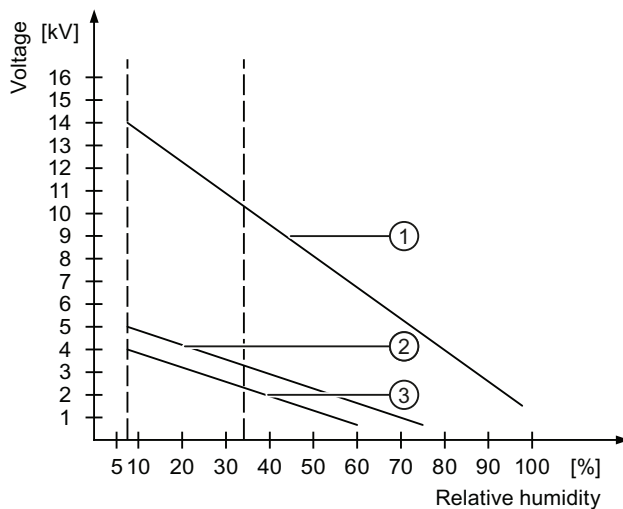

- ① Synthetic materials
- ② Wool
- ③ Antistatic materials such as wood or concrete

NOTICE
Grounding measures There is no equipotential bonding without grounding. An electrostatic charge is not discharged and may damage the ESD. Protect yourself against discharge of static electricity. When working with electrostatic sensitive devices, make sure that the person and the workplace are properly grounded.

Protective measures against discharge of static electricity

- Disconnect the power supply before you install or remove modules which are sensitive to ESD.
- Pay attention to good grounding:
 - When handling electrostatic sensitive devices, make sure that persons, the workstation and devices, tools and packaging used are properly grounded. This way you avoid static discharge.
- Avoid direct contact:
 - As a general rule, do not touch electrostatic sensitive devices, except in the case of unavoidable maintenance work.
 - Hold the modules at their edge so that you do not touch the connector pins or conductor paths. This way, the discharge energy does not reach and damage the sensitive components.
 - Discharge your body electrostatically before you take a measurement at a module. Do so by touching grounded metallic parts. Always use grounded measuring instruments.

9.3 Dimension drawings

9.3.1 Dimensional drawing IPC277D, 7" display

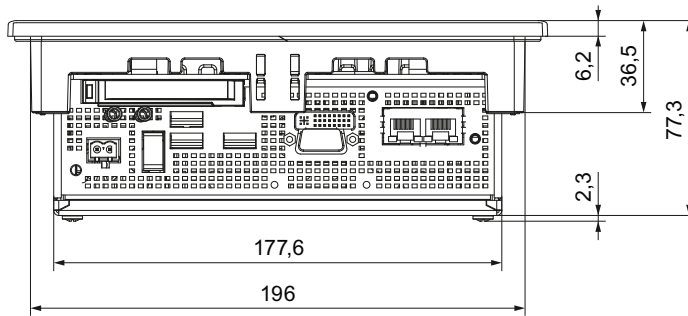

Alle Angaben in mm.

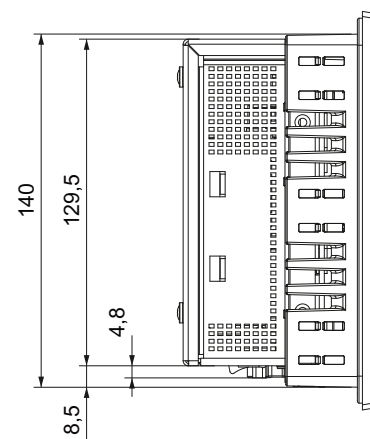
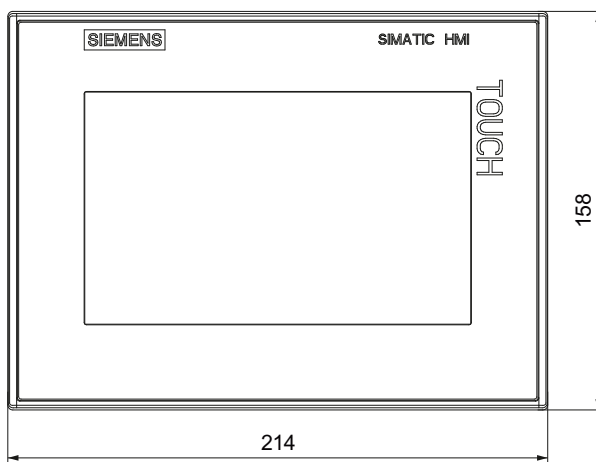

9.3.2 Dimensional drawing IPC277D, 9" display

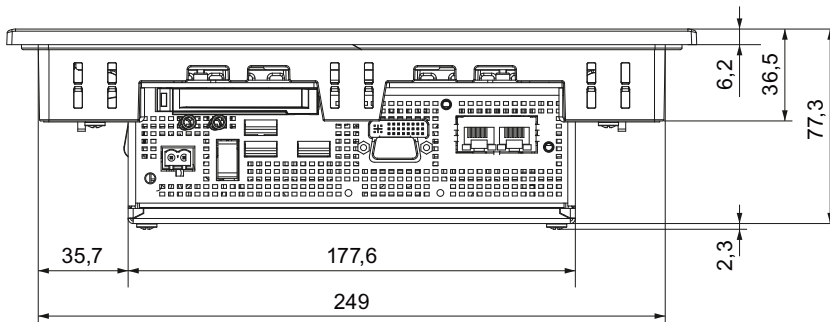

Alle Angaben in mm.

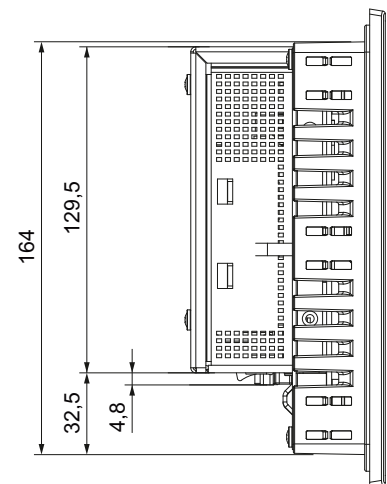
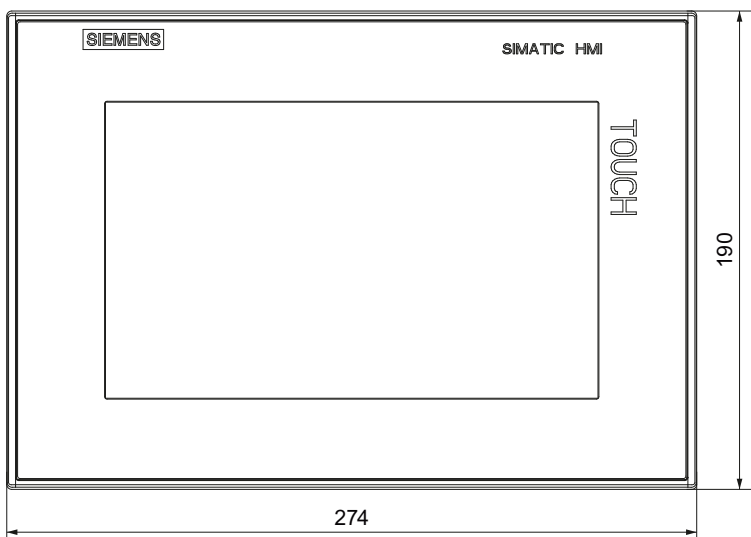

9.3.3 Dimensional drawing IPC277D, 12" display

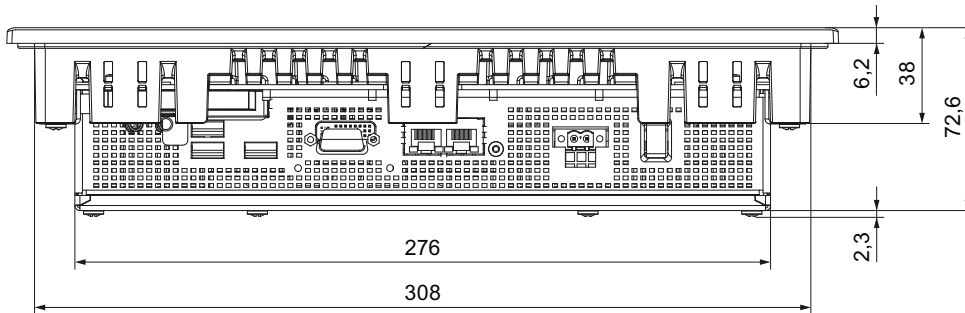

Alle Angaben in mm.

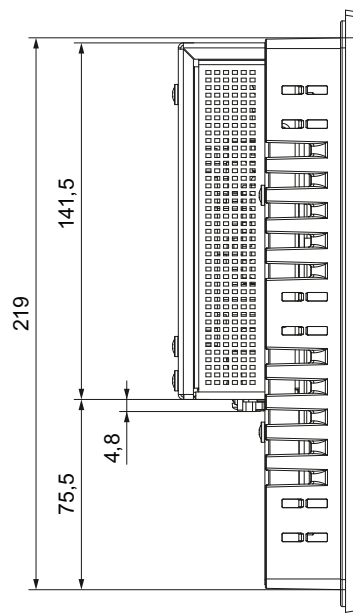
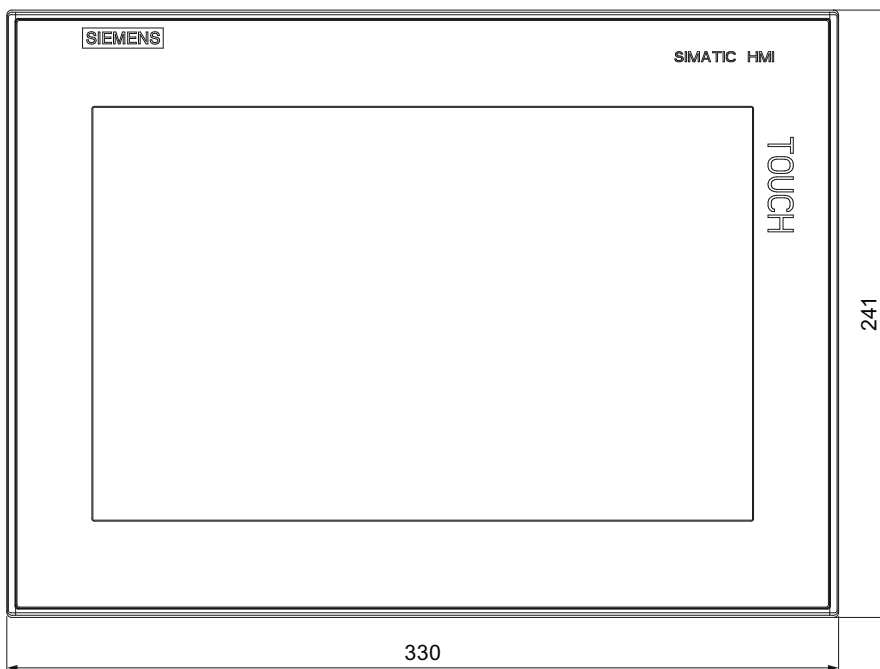

9.3.4 Dimensional drawing IPC277D, 15" display

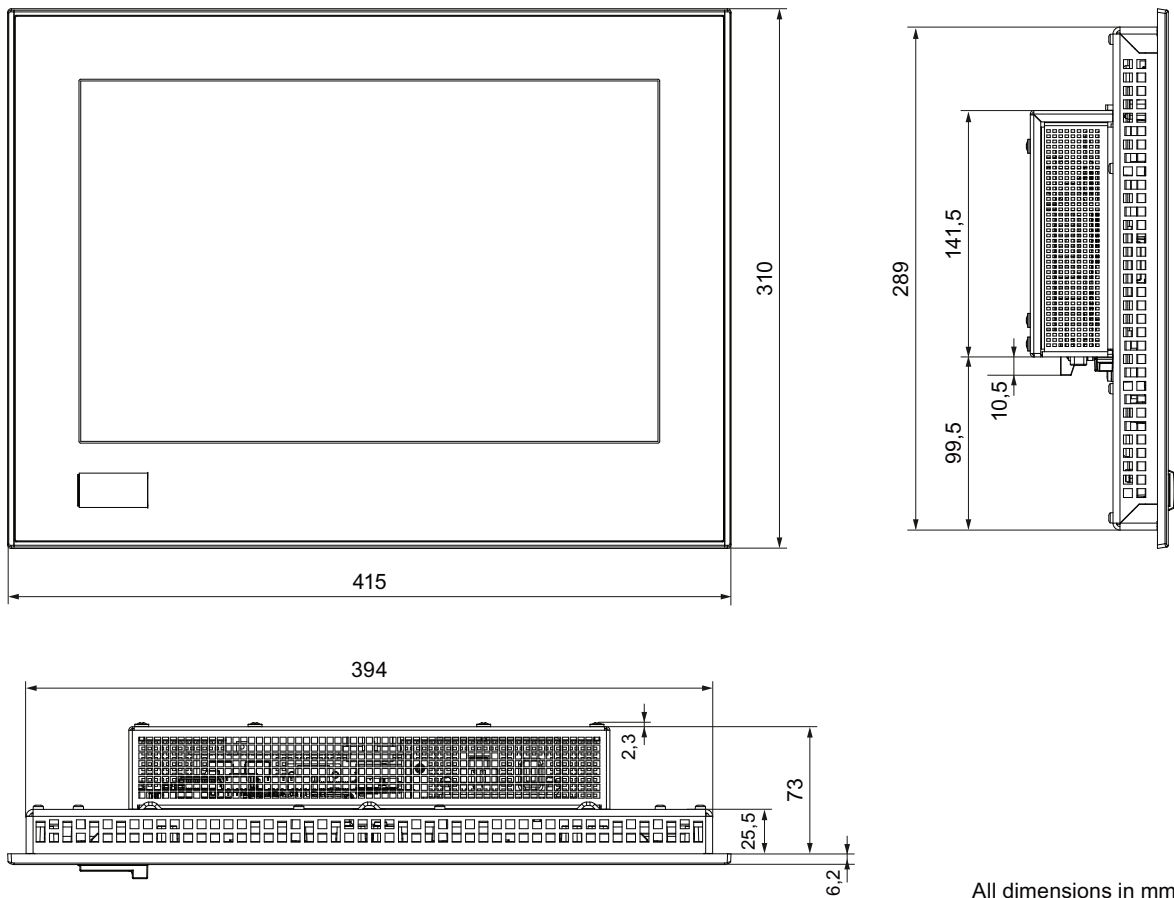

All dimensions in mm.

9.3.5 Dimensional drawing IPC277D, 19" display

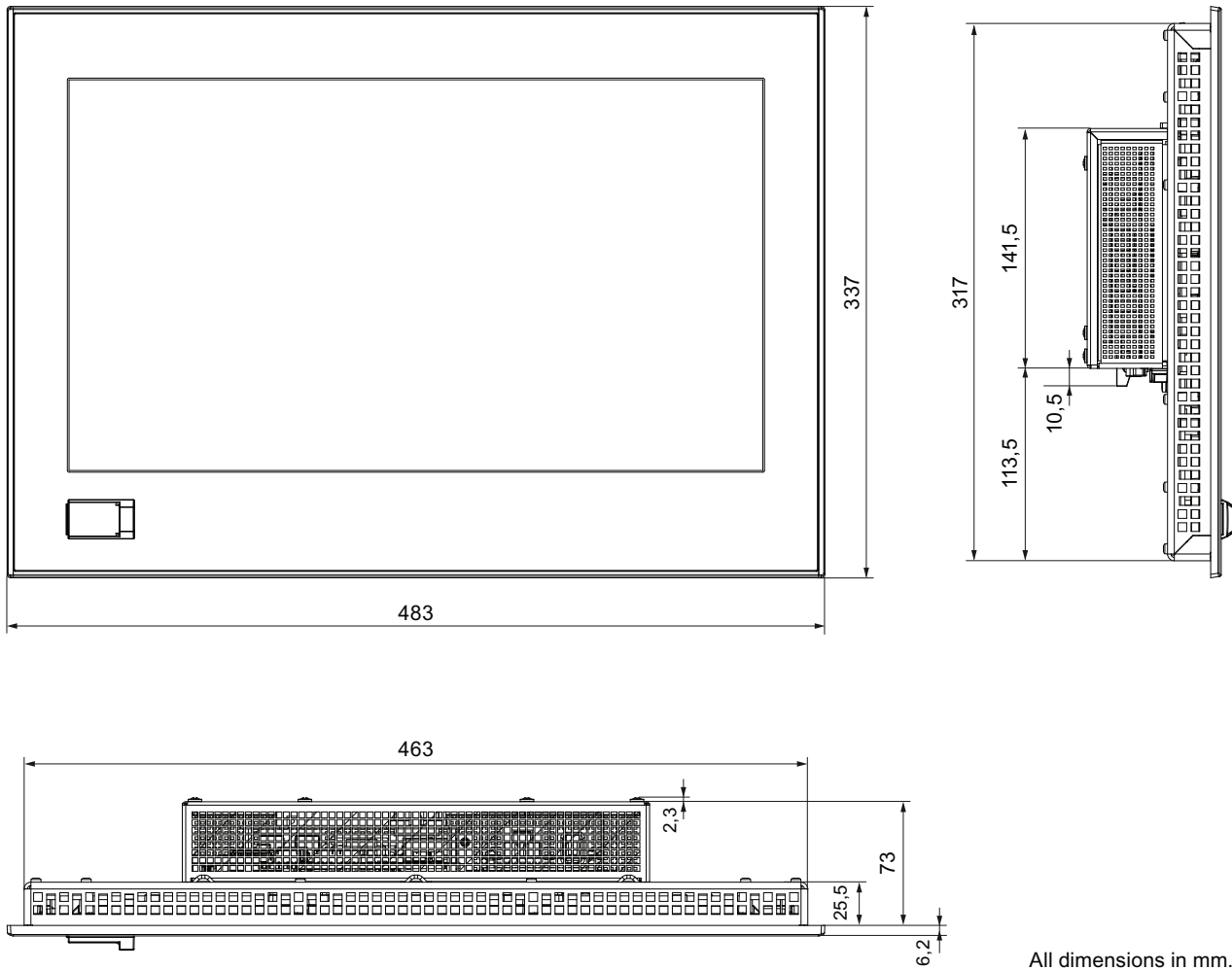

All dimensions in mm.

9.4 Technical specifications

9.4.1 General technical specifications

Order numbers	See order documents
Weight <ul style="list-style-type: none"> • IPC277D, 7" display • IPC277D, 9" display • IPC277D, 12" display • IPC277D, 15" display • IPC277D, 19" display 	<ul style="list-style-type: none"> • 1500 g • 1950 g • 2750 g • 4000 g • 5700 g
Power supply ¹	24V DC (19.2 to 28.8 V)
Brief power failure according to Namur	Min. 15 ms (DC) Max. 10 events per hour; min. 1 s recovery time
Max. power consumption (DC): <ul style="list-style-type: none"> • IPC277D, 7" display • IPC277D, 9" display • IPC277D, 12" display • IPC277D, 15" display • IPC277D, 19" display The current may differ depending on the operating mode and extensions.	Continuous current <ul style="list-style-type: none"> • 24 V, 1.1 A • 24 V, 1.2 A • 24 V, 1.4 A • 24 V, 1.9 A • 24 V, 1.9 A
Degree of protection	IP 20 to IEC 60529
Quality assurance	In accordance with ISO 9001

¹ The generation of the supply voltage with the line-side power supply must be realized as safety extra-low voltage with safe electrical isolation, isolated according to IEC 60364-4-41 or as SELV according to IEC/UL/EN/DIN-EN 60950-1 and LPS/NEC Class 2.

Electromagnetic compatibility

Emission standard	EN 61000-6-4; CISPR 22:2004 Class A; FCC Class A
Immunity with regard to conducted interference on the supply lines	± 2 kV in accordance with IEC 61000-4-4; burst ± 1 kV in accordance with IEC 61000-4-5; symmetrical surge ± 2 kV in accordance with IEC 61000-4-5; asymmetrical surge
Noise immunity on signal lines	± 2 kV in accordance with IEC 61000-4-4; burst; length > 3 m ± 2 kV in accordance with IEC 61000-4-5; symmetrical surge, length > 30 m
Immunity to electrostatic discharge	± 6 kV contact discharge at the front in accordance with IEC 61000-4-2 ± 4 kV housing contact discharge at the back in accordance with IEC 61000-4-2 ± 8 kV air discharge in accordance with IEC 61000-4-2
Immunity to RF interference	10 V/m, 80 to 1000 MHz 80% AM according to IEC 61000-4-3 10 V/m, 1.4 to 2 GHz 1 V/m, 2 to 2.7 GHz 10 V, 9 kHz to 80 MHz according to IEC 61000-4-6
Immunity to magnetic fields	100 A/m, 50/60 Hz according to IEC 61000-4-8

Main circuit board

Processor	Intel Atom 1.0 GHz Intel Atom 1.3 GHz
Main memory	DDR2 1 GB or 2 GB, memory cannot be exchanged. For information on the memory size, refer to the order data.
Backup memory	512 KB MRAM Of this, 128 KB of this can be backed up at full load in the buffer time of the power supply.

Drive, memory medium

Solid-state drive, optional	≥ 50 GB, 2.5" SATA-SSD (SLC) ≥ 80 GB, 2.5" SATA-SSD (MLC)
CompactFlash memory card, optional	<ul style="list-style-type: none"> • 2 GB or • 4 GB or • 8 GB or • 16 GB
Floppy and CD-ROM drive	External, can be connected via USB port ¹
USB stick	External, can be connected via USB port

¹ Only to USB port of the device, not via USB hub

Graphics

Display, resolution	<ul style="list-style-type: none"> • 7" screen diagonal with backlighting, resolution 800 × 480 pixels, WVGA, WGA (Wide VGA) • 9" screen diagonal with backlighting, resolution 800 × 480 pixels, WVGA, WGA (Wide VGA) • 12" screen diagonal with backlighting, resolution 1280 × 800 pixels, WXGA (Wide XGA) • 15" screen diagonal with backlighting, resolution 1280 × 800 pixels, WXGA (Wide XGA) • 19" screen diagonal with backlighting, resolution 1366 × 768 pixels
Touch controller	Resistive Semtech controller ELO CTR-2216SU-AT-CHP-00 Touch screen analog resistive Touch force with test pen; 2 mm diameter: 5 N
Backlighting (MTBF) Half brightness life time, typical	LED min. 50000 h at 50 °C, 50% brightness
Pixel error class in accordance with ISO 9241-307	I

Interfaces

COM 1	RS232, max. 115 kbps, sub-D connector, 9-pin
USB	<ul style="list-style-type: none"> • 3 × USB 2.0, a maximum of 2 can be operated in high-current mode at the same time • IPC277D 15"/19": 1 x front USB 2.0 high current
LAN interface X1 P1, RJ45 ¹	Intel Platform Controller Hub EG20T Gigabit Ethernet 10, 100, 1000 Mbps
LAN interface X2 P1, RJ45 ¹	Intel 82574L Gigabit Ethernet controller 10, 100, 1000 Mbps, teaming is supported ²
Keyboard, mouse	Connection via USB port

¹ For unique labeling, the LAN interfaces are numbered on the enclosure. The numbering by the operating system can differ.

² Teaming can be set and initiated in the configuration interface. In teaming operation, jumbo frames, e.g. for the camera application, are not supported.

9.4.2 Environmental conditions

Climatic ambient conditions

Permitted mounting positions see section "Preparing for installation"

Temperature, tested in accordance with IEC 60068-2-1, IEC 60068-2-2			
Temperature gradient in operation	Max. 10 °C/h, no condensation		
Ambient temperature in operation	7", 9" and 12"	15"	19"
<ul style="list-style-type: none"> When installed vertically in horizontal format When installed inclined, inclination vertical installation, inclination $\leq \pm 45^\circ$ When installed vertically in horizontal format 	0 ... 50 °C	0 ... 50 °C	0 ... 45 °C
	0 ... 50 °C	0 ... 45 °C	0 ... 45 °C
	0 ... 45 °C	0 ... 40 °C	0 ... 40 °C
Temperature during storage/transport	-20 to +60 °C		
Storage/transport, gradient	Max. 20 °C/h, no condensation		
Relative humidity, tested in accordance with IEC 60068-2-78, IEC 60068-2-30			
Operation	5 ... 85 % at 30 °C, no condensation		
Storage/transport	5 ... 95 % at 25 °C, no condensation		
Air pressure, in accordance with IEC 60068-2-13			
Operation	1080 to 795 hPa, corresponds to an elevation of -1000 to 2000 m		
Storage/transport	1080 to 660 hPa, corresponds to an elevation of -1000 to 3500 m		

Mechanical ambient conditions

Vibration, tested according to DIN IEC 60068-2-6	
Operation	10 to 58 Hz: 0.075 mm 58 to 500 Hz: 9.8 m/s ²
Storage/transport	5 to 9 Hz: 3.5 mm 9 to 500 Hz: 9.8 m/s ²
Shock resistance, tested in accordance with IEC 60068-2-27, IEC 60068-2-29	
Operation	50 m/s ² , 30 ms
Storage/transport	250 m/s ² , 6 ms

9.4.3 Shipbuilding

Ambient conditions for use of the devices in shipbuilding

The device is suitable for shipping and offshore applications. The installation and attachment conditions are the same as those for industrial applications.

The following ambient conditions are permitted:

ENV1 and ENV2 in accordance with "Lloyd's Register Type Approval System, Test Specification Number 1-2002".

NOTICE
<p>Filters and snap-on ferrite upstream</p> <p>If the device is used in shipbuilding, a Corcom 6FC10 filter type from the Corcom company must be connected upstream, in the 24 V DC supply line of the device.</p> <p>The power supply cable must be fitted with a snap-on ferrite directly before the device connector (manufacturer: Würth 742 711 32).</p>

9.4.4 Power supply IPC277D, 7" and 9" displays

9.4.4.1 Power requirements of additional components

Maximum permitted current consumption at the USB ports

Auxiliary components		Maximum permitted power consumption	Max. total power
		+5 V	
USB device	High current	500 mA	6 W (for all USB devices)
	Low current	100 mA	

9.4.4.2 Power consumption

Normal power consumption (7" device)

	Power consumption (at 24 V rated voltage)
Basic device ATOM 1.0 GHz, 1 GB RAM with display	18 W
Basic device ATOM 1.3 GHz, 2 GB RAM with display	18 W
SSD	2 W
Expansion USB, max.	6 W

Normal power consumption (9" device)

	Power consumption (at a rated voltage of 24 V)
Basic device ATOM 1.0 GHz, 1 GB RAM with display	21 W
Basic device ATOM 1.3 GHz, 2 GB RAM with display	21 W
SSD	2 W
USB extension, max.	6 W

9.4.4.3 DC power supply

Input voltage	24 VDC (19.2 to 28.8 VDC)
Power consumption ¹	Max. 32 W
Power failure buffering	Hold-up time > 15 ms (DC_FAIL becomes active after > 5 ms)
Maximum continuous output power ¹	25 W

¹ The performance specifications apply to the power supply component, but not to the device.

Note

Inrush current

The inrush current of the device at an input voltage of 24 V amounts to at least 2 A for a period of 25 ms.

The peak value of the inrush current depends on the input voltage and the impedance of the 24 V source; peak currents in excess of 2.0 A are possible. This will not have a negative impact on device functionality.

9.4.5 Power supply IPC277D, 12", 15" and 19" display

9.4.5.1 Power requirements of additional components

Maximum permitted current consumption at the USB ports

Auxiliary components		Maximum permitted power consumption	Max. total power
		+5 V	
USB device	High current	500 mA	6 W
	Low current	100 mA	
USB front ¹⁾		500 mA	2.5 W

¹⁾ For 15" and 19" devices

9.4.5.2 Power consumption

Normal power consumption 12" device

	Power consumption (at a rated voltage of 24 V)		
	12"	15"	19"
Basic device ATOM 1.0 GHz / 1 GB RAM with display	24 W	36 W	36 W
Basic device ATOM 1.3 GHz / 2 GB RAM with display	24 W	36 W	36 W
SSD	2 W	2 W	2 W
Maximum USB extension	Max. 6 W	Max. 6 W	Max. 6 W
USB port, front	-	Max. 2.5 W	Max. 2.5 W

9.4.5.3 DC power supply

Input voltage	24 VDC (19.2 to 28.8 VDC)
Power consumption ¹⁾	Max. 72 W
Power failure buffering	Hold-up time > 15 ms (DC_FAIL becomes active after > 5 ms)
Maximum continuous output power ¹⁾	60 W

¹⁾ The performance specifications apply to the power supply component, but not to the device.

Note

Inrush current

The device needs an inrush current of at least 4.5 A for 25 ms.

The peak value of the inrush current depends on the input voltage and the impedance of the 24 V source; peak currents in excess of 4.5 A are possible. This will not have a negative impact on device functionality.

9.5 Hardware description

9.5.1 Technical features of the motherboard

Component / port	Description	Parameters
Chipset	Intel EG20T	
BIOS	Core, Video, ACPI	
CPU	Intel Atom E6x0	
Memory	DDR 2 onboard	512 MB, 1 GB, and 2 GB
Graphics	Intel Embedded Media Graphic Device (IEMGD)	32 - 256 MB graphics memory taken dynamically from RAM

9.5.2 External interfaces

9.5.2.1 Overview of interfaces

Interface	Position	Description	
COM	external	9-pin sub D: • RS232 (pin)	
CompactFlash	external	CompactFlash card	
USB	external	3 x external USB Only two of these USB ports may be operated simultaneously in high-current mode.	USB 1.1/2.0
	Front ¹⁾	High-current	USB 1.1/2.0
Ethernet	external	2 x RJ45	10/100/1000 Mbps

¹ For 15" and 19" devices

9.5.2.2 Extended COM ports

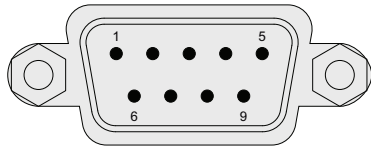

Pin	Short description	3 extended COM ports ¹	Meaning
1	DCD	Not linked	
2	RxD	Rx	Received data (I)
3	TxD	Tx	Transmitted data (O)
4	DTR	Not linked	
5	GND	GND	Ground
6	DSR	Not linked	
7	RTS	Not linked	
8	CTS	Not linked	
9	RI	Not linked	

¹ For device variant COM only

9.5.2.3 Ethernet port

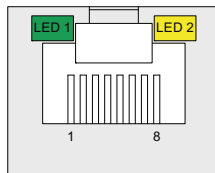

Pin	Short description	Meaning
1	BI_DA+	Bidirectional data A+, input/output
2	BI_DA-	Bidirectional data A-, input/output
3	BI_DB+	Bidirectional data B+, input/output
4	BI_DC+	Bidirectional data C+, input/output
5	BI_DC-	Bidirectional data C-, input/output
6	BI_DB-	Bidirectional data B-, input/output
7	BI_DD+	Bidirectional data D+, input/output
8	BI_DD-	Bidirectional data D-, input/output

LED	Short description	Meaning
1	LED 1	Off: 10 Mbps Lit green: 100 Mbps Lit orange: 1000 Mbps
2	LED 2	Lit orange: Connection established Flashes: Activity

9.5.2.4 USB 2.0 port

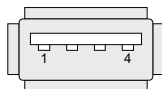

Pin	Short description	Meaning
1	USB_P5V_fused (O)	+5 V, fused
2	USB_D0M (I/O)	Data+
3	USB_D0P (I/O)	Data-
4	USB_GND	GND

9.5.3 System resources

9.5.3.1 Currently allocated system resources

All system resources (hardware addresses, memory utilization, interrupt assignment, DMA channels) are assigned dynamically by the Windows operating system, depending on the hardware equipment, drivers and connected external devices. You can view the current allocation of system resources or possible conflicts in the Control Panel as follows:

Procedure

To view the system resources, proceed as follows:

1. In the Windows Start menu, select "Start -> Run".
2. Enter "msinfo32" in the command prompt and confirm your entry with "OK".

9.5.3.2 System resources used by the BIOS/DOS

The following tables and pictures describe the system resources for the factory state of the device.

Interrupt channels

The interrupts are assigned to devices by BIOS. An exclusive non-shared interrupt for Windows Embedded Standard 7 and Windows 7 is available for the primary Ethernet interface.

This means that applications or real-time operating system extensions can operate these devices exclusively and with high performance, without having to share the interrupt with other devices.

The following table shows the interrupt sharing in APIC mode:

Interrupt		Interrupt type
IRQ0	System Timer / HPET	ISA exclusive
IRQ1	PS/2 keyboard controller emulation	ISA exclusive
IRQ2	Interrupt controller 2	ISA exclusive
IRQ3	Free	
IRQ4	Free	
IRQ5	Free	
IRQ6	Reserved	
IRQ7	Free	
IRQ8	Realtime clock	ISA exclusive
IRQ9	ACPI-SCI (system control interrupt)	
IRQ10		ISA exclusive (CAN)
IRQ11	Free	
IRQ12	PS/2 mouse controller emulation	ISA exclusive
IRQ13	Coprocessor	ISA exclusive
IRQ14		ISA exclusive
IRQ15		ISA exclusive
IRQ16	PCI Express Port 1 General Purpose I/O Controller USB OHCI Controller 1, 2, 3 USB EHCI Controller 1 LAN1	PCI shared ¹⁾
IRQ17	LAN2 Gigabit Network Connection PCI Express Port 2 SATA AHCI Controller	PCI shared ¹⁾
IRQ18	PCI Express Port 3 CAN Controller I2C Controller IEEE 1588 Hardware Assist SDIO Controller Serial Peripheral Interface Bus	PCI shared ¹⁾
IRQ19	PCI Express Port 4 DMA Controller USB Client Controller USB OHCI Controller 4, 5, 6 USB EHCI Controller 2 UART Controller 1 (COM3) UART Controller 2 (COM4) UART Controller 3 (COM5) UART Controller 4 (COM6)	PCI shared ¹⁾
IRQ20	Embedded media and graphics	PCI shared ¹⁾

9.5.4 Input/output address areas

9.5.4.1 Overview of the internal module registers

The following addresses are used for the internal registers:

Register type	Addresses
Watchdog register	See Intel Atom E6xx data sheet (http://www.intel.com/content/www/us/en/intelligent-systems/medical-applications/atom-e6xx-series-datasheet.html)
Battery status register (read-only) (Page 112)	RTC_low: GPIO_BAR(D31:F0 offset 44-47h) + offset 08h bit 1 RTC_fail: GPIO_BAR(D31:F0 offset 44-47h) + offset 08h bit 2

9.5.4.2 Battery status register (read-only)

The status of the CMOS battery is monitored; the status (two-tier) can be read from the battery status register.

9.5.4.3 MRAM address register

MRAM occupies a 512 KB memory address area that can be read via PCI registers.

Meaning of the bits

MRAM address register		
PCI register address: MRAM base address register	PCI register content: MRAM memory address (default)	Length of the memory area
8010 2010h	9040 0000h Address is assigned dynamically (depending on device configuration)	80000 h

9.6 BIOS description

9.6.1 Overview

BIOS Setup program

BIOS Setup program is stored in ROM BIOS. System configuration data are stored in battery-backed RAM of the device.

SETUP can be used to define the hardware configuration (for example, the drive type) and system properties. The BIOS Setup is also used to set the time and date of the realtime clock.

Changing the device configuration

Your device configuration is preset for operating with the included software. You should only change the default values if you have modified the technical configuration your device, or if a fault occurs when the unit is powered up.

9.6.2 Starting BIOS Setup

Starting BIOS Setup

Start the setup program as follows:

1. Reset the device (warm or cold restart).

In the figures shown, the default settings differ based on the device versions. With the default setting of the device, the example display shown below appears following startup:

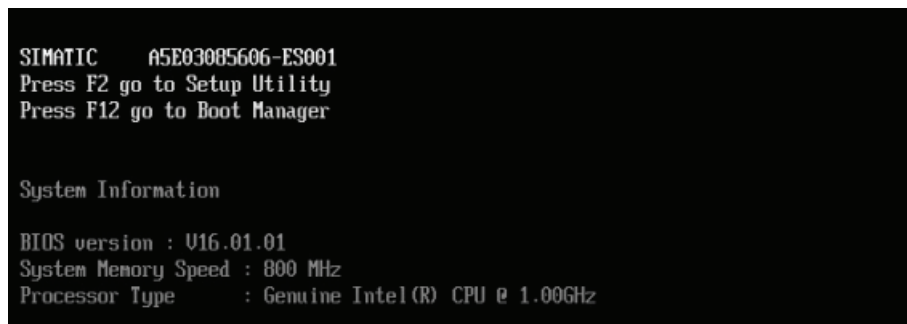

```
SIMATIC A5E03085606-ES001
Press F2 go to Setup Utility
Press F12 go to Boot Manager

System Information

BIOS version : U16.01.01
System Memory Speed : 800 MHz
Processor Type : Genuine Intel(R) CPU @ 1.00GHz
```

On completion of the POST, the BIOS gives you the opportunity of starting the SETUP program. The following message appears:

PRESS F2 go to Setup Utility, Press F12 go to Boot Manager

2. Press the <F2> key as long as the BIOS prompt appears on the screen.

9.6.3 BIOS Setup menus

9.6.3.1 BIOS Setup overview

The various menus and submenus are listed on the next pages. You can obtain information on the selected SETUP item from the "Item-specific help" part of the respective menu.

Example of the BIOS SETUP menu

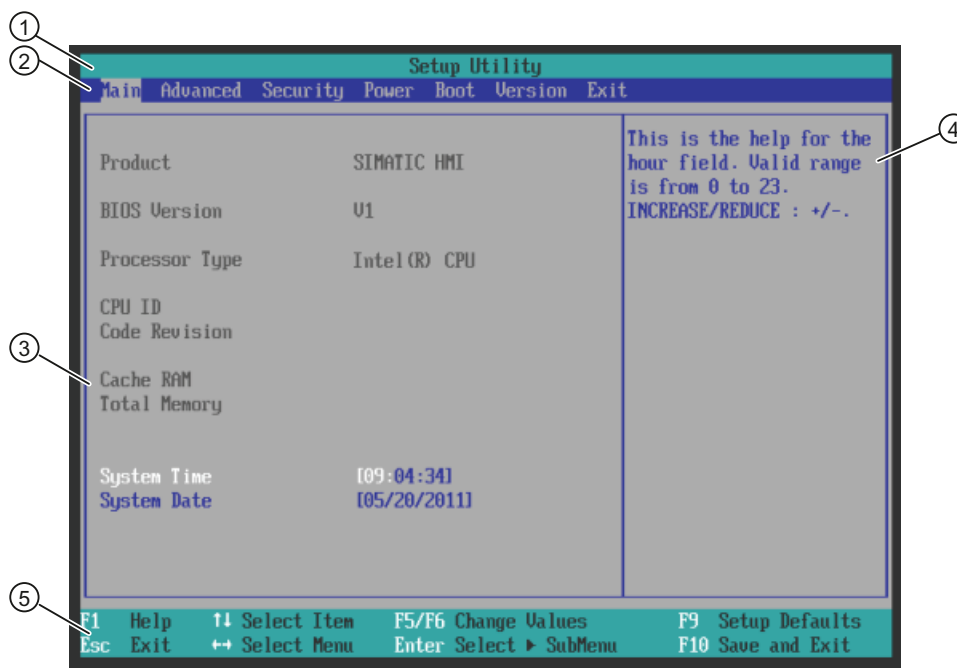

- ① Header
- ② Menu bar
- ③ Selectable submenu
- ④ Help window
- ⑤ Command line

Menu layout

The screen is divided into four sections. In the top section ②, you can select the submenus [Main], [Advanced], [Security], [Power], [Boot], [Version], [Exit]. You can select various settings or submenus in the left middle section ③. Short help texts are displayed on the right ④ for currently selected menu entries; the bottom section contains information for operator input.

The following figures represent examples of specific device configurations. The screen content may deviate slightly depending on the equipment actually supplied.

You can move between the menu forms using the cursor keys [←] left and [→] right.

Menu	Meaning
Main	Setting system functions
Advanced	Advanced system configuration
Security	Security functions, e.g. setting a password
Power	Specify startup characteristics of the device, e.g. in response to specific events, in case of power failure, or in power saving mode.
Boot	Set boot options, e.g. the boot priority.
Version	Device-specific information (e.g. product version)
Exit	Close and save

9.6.3.2 Main menu

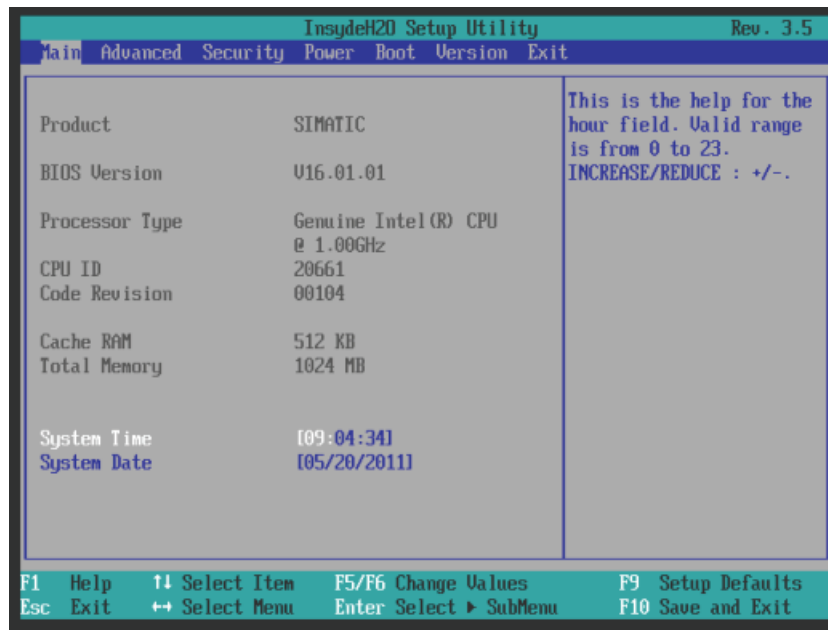

Main menu settings

In the main menu, you can move up and down to select the following system configuration boxes by means of the [↑] up and [↓] down cursor keys:

Field	Meaning
System Time	For viewing and setting the current time
System Date	For viewing and setting the current date

System time and date

System Time and System Date indicate the current values. Once you have selected the appropriate option, you can use the [+] and [-] keys to modify the time setting

Hour: Minute: Second

and for the date

Month/Day/Year

You can navigate through the entries within the date and time fields (for example, from hour to minute) using the Enter key.

9.6.3.3 Advanced menu

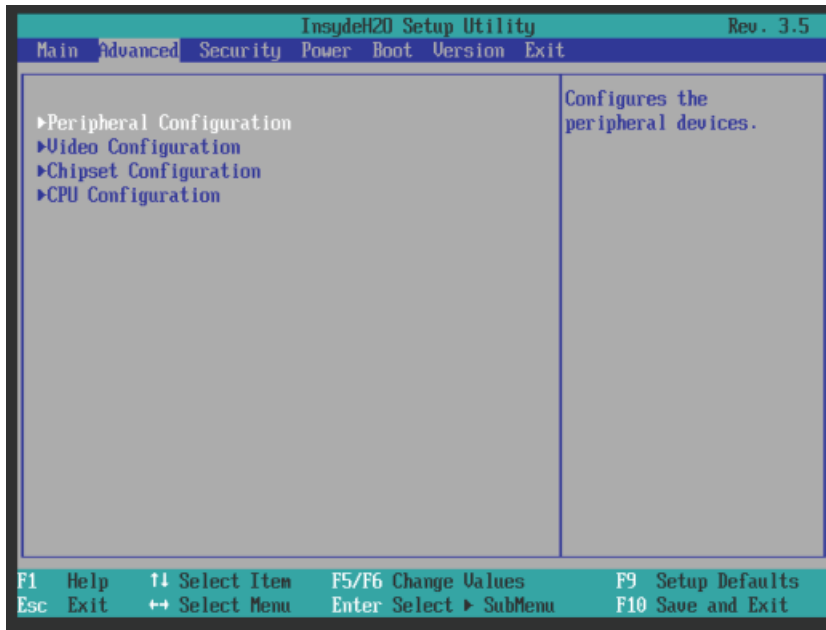

Advanced menu settings

Entry	Meaning
Peripheral Configuration	Configuration of components on the motherboard.
Video Configuration	Configuration of the graphics interface
Chipset Configuration	Extended chipset configuration.
CPU Configuration	Configuration of CPU parameters

Advanced menu > "Peripheral Configuration" submenu

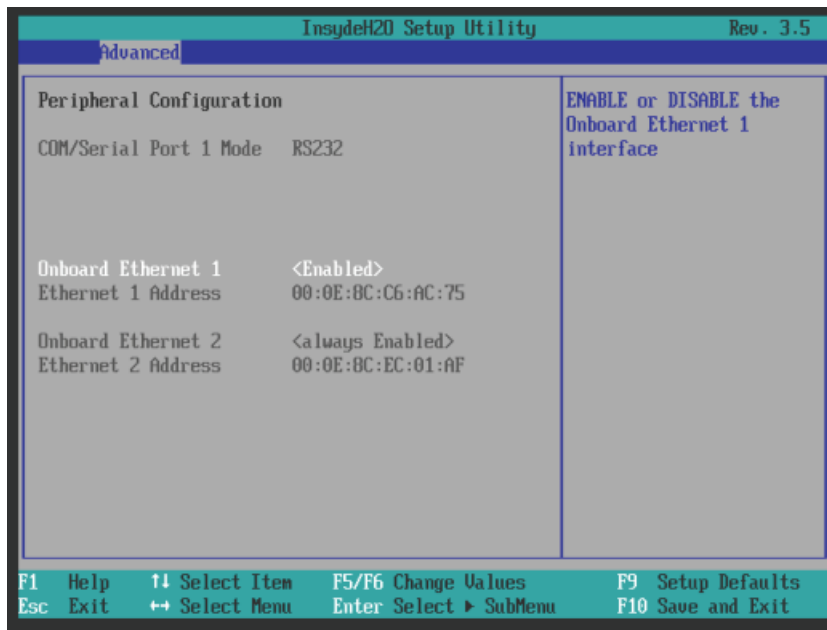

Entry	Meaning
COM/Serial Port 1 Mode	The displayed Port 1 Mode RS232.
Onboard Ethernet 1	Enable (Enabled) the onboard Ethernet 1 interface.
Ethernet 1 address	Display the MAC address of Ethernet 1
Onboard Ethernet 2	Enable (Enabled) the onboard Ethernet 2 interface.
Ethernet 2 address	Display the MAC address of Ethernet 2

Advanced menu > submenu "Video Configuration"

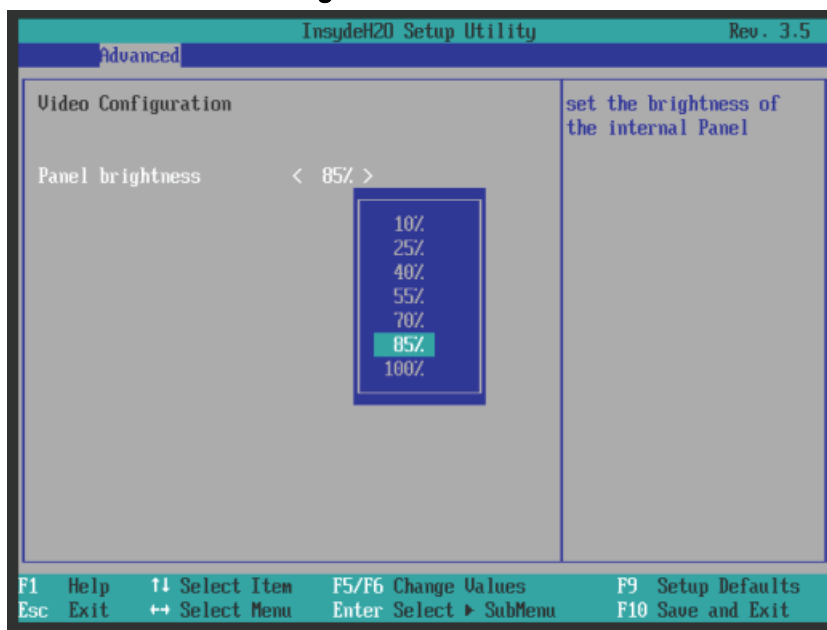

Note

This setting is used when Windows is subsequently booted up. The new value is applied if the brightness is changed with the "Set brightness" tool.

Entry	Meaning
Panel brightness	Sets the screen brightness from 10 to 100 percent in the case of non-Windows operating systems. During the start, screen brightness is automatically set to 50% so that you can set the BIOS Setup.

Advanced menu > "Chipset Configuration" submenu

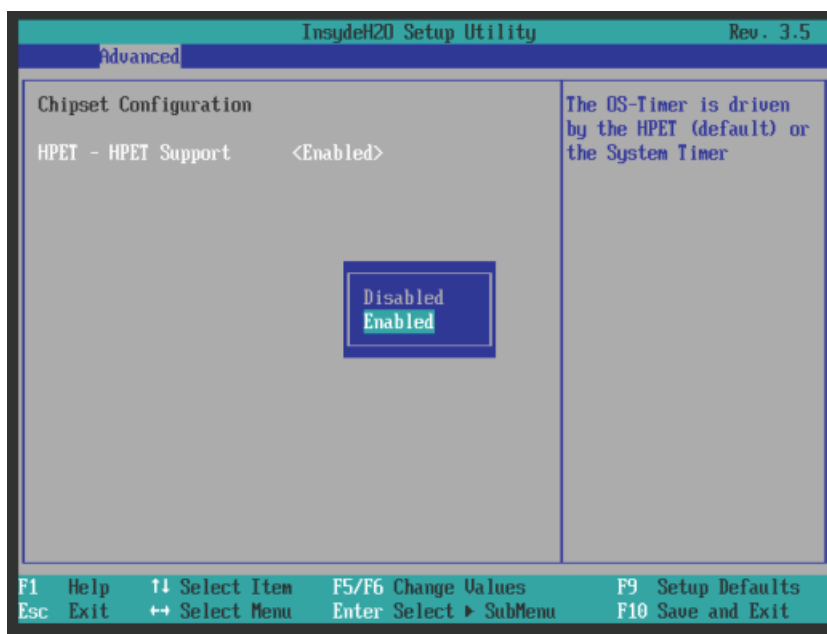

Entry	Meaning
HPET - HPET Support	Enable High Precision Event Timer

Advanced menu > "CPU Configuration" submenu

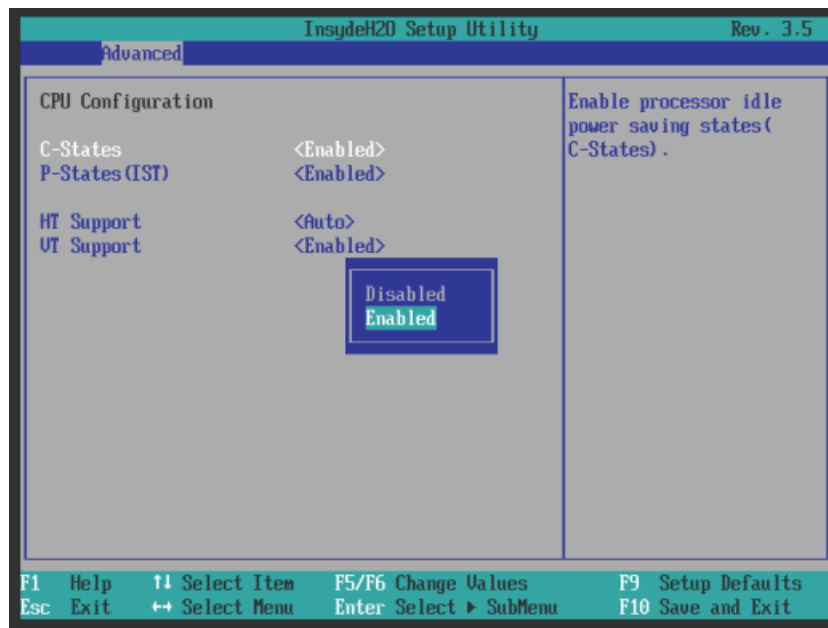

Entry	Meaning
C-States	Enable the power saving modes of the processor.
P-States (IST)	Enable the performance modes of the processor.
HT Support	<ul style="list-style-type: none"> • Auto: Use hyperthreading, if available. • Disabled: Hyperthreading disabled.
VT Support	Enable or disable virtualization functionality "Vanderpool Technology".

9.6.3.4 Security menu

You can only edit the fields enclosed in square brackets. Two passwords can be assigned to protect your PC from unauthorized use. The supervisor password can be used to restrict access to the drives.

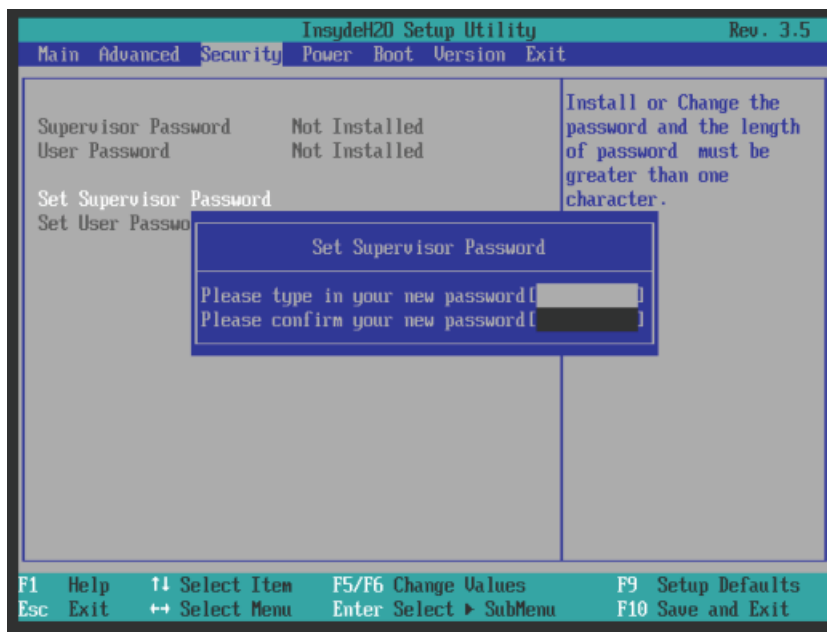

Supervisor Password	Installed	Certain setup fields can be customized, including the supervisor and user passwords.
	Not installed	The password is disabled.
User password	Installed	Certain setup fields can be changed by the user, including the user password.
	Not installed	The password is disabled.
Set Supervisor Password	This field opens the password input dialog. After having entered the supervisor password, you can enter a new password or clear and deactivate it by pressing "Return".	
Set User Password	This field opens the password input dialog. Logged on users can change the password, or clear and deactivate it by pressing "Return".	
Power on password	Disabled	The password is queried during startup.
	Enabled	The password is not queried during startup.
User Access Level	View only	Read access only to all fields of the InsydeH20 Setup.
	Limited	Only certain fields can be edited.
	Full	All fields can be edited, with the exception of the "Supervisor password".
Clear user password		Deletes the user password.

9.6.3.5 Power menu

The reaction of the device to a power failure and after wake events is specified in this menu.

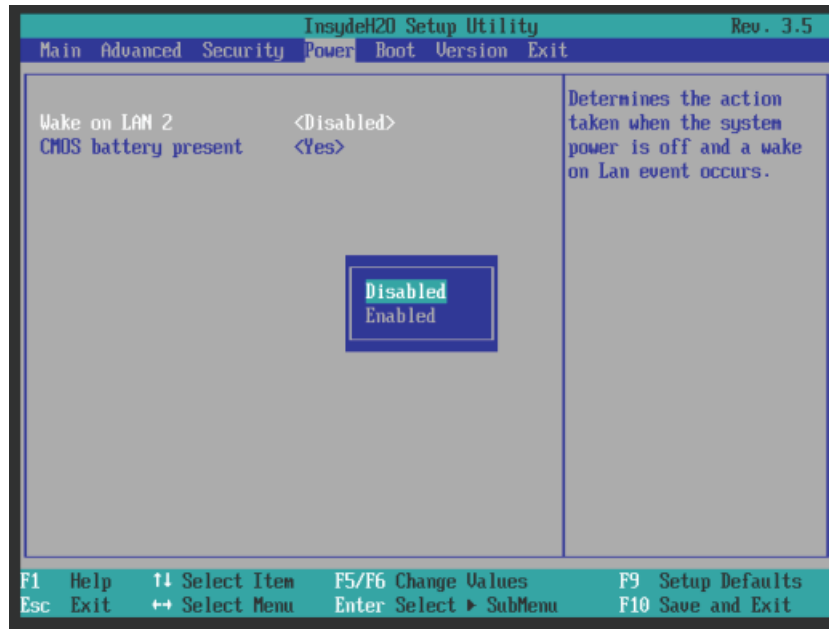

Entry in the Power menu

Entry	Meaning
Wake on LAN 2	If activated <Enabled>, the device powers on when a wake event occurs. Otherwise, the device remains switched off.
CMOS battery present	This function indicates to the system whether a CMOS battery is being used. Enable this function with "Yes" if a CMOS battery has been installed. Disable this function with "No" if no CMOS battery has been installed.

9.6.3.6 Boot menu

In this menu this booting behavior of the device is specified and the boot medium or sequence of the boot media is determined.

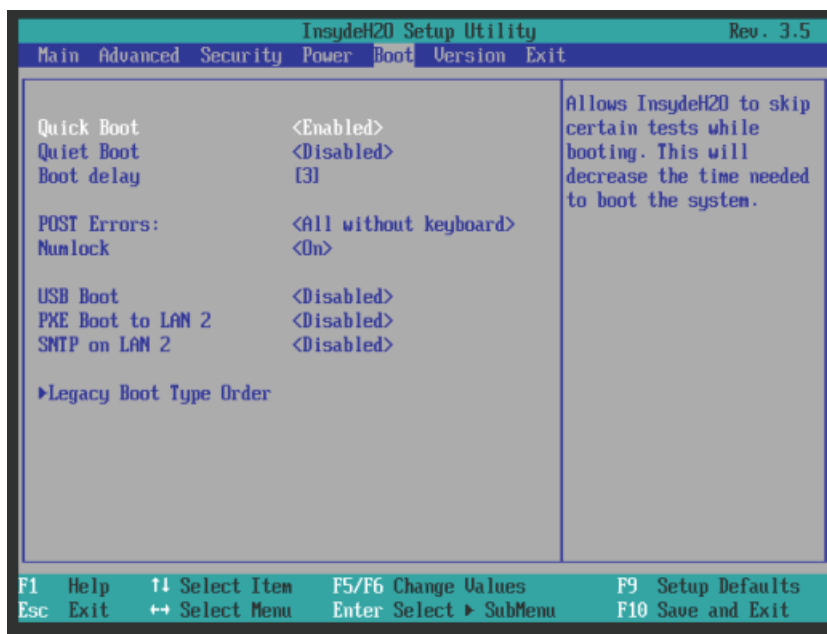

Entries in the boot menu

Entry	Meaning
Quick Boot	Enable or disable If enabled, the device starts faster because various hardware function tests are skipped.
Quiet Boot	If disabled, the device boots in text mode. If enabled, a splash screen with logo is output.
Boot delay	Delays the boot sequence by n seconds.
POST errors	Specification of the boot reaction when faults are detected. <ul style="list-style-type: none"> • Never halt on errors: Continue the booting process when errors occur. • Halt on all errors: Interrupt the booting process when errors occur. • All without keyboard: Interrupt the booting process when errors occur, except for keyboard errors. • All without kb/smart: Interrupt the booting process when errors occur, except for keyboard and S.M.A.R.T errors. (SMART: Self-Monitoring, Analysis and Reporting Technology)
Numlock	On = Enable numeric keypad on right Off = Disable numeric keypad on right (= navigation)
USB Boot	Allow/Do not allow booting of inserted USB devices.
PXE Boot to LAN 2	Enable or disable booting of the LAN2 via PXE.
SNTP on LAN 2	Enable or disable booting of the LAN2 via SNTP.
Legacy Boot Type Order	Set the traditional boot order (Normal, Advanced, Placeholder).

Boot menu > "Legacy Boot Type Order (normal)" submenu

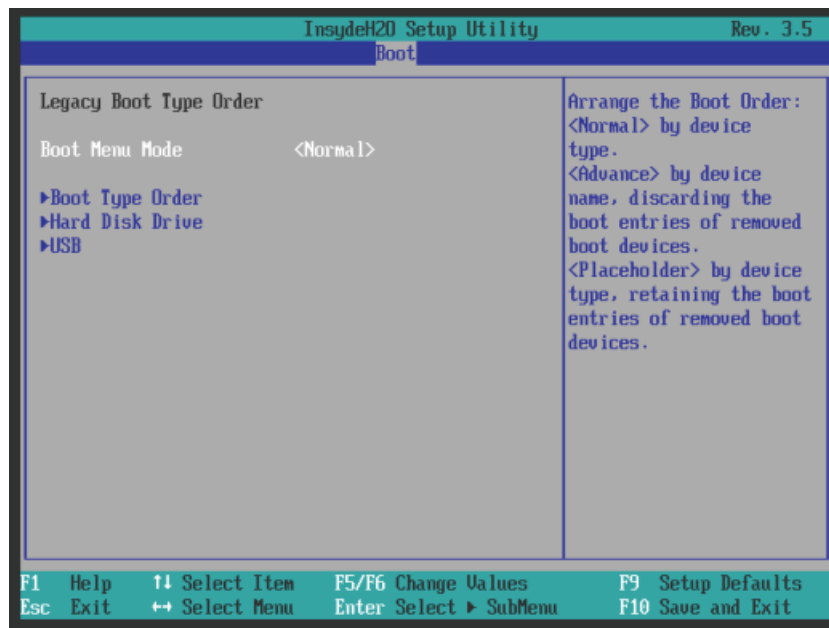

Entry	Meaning
Entry	Meaning
Boot menu mode	<ul style="list-style-type: none"> • Normal = Boot order based on component type • Advance = Customized boot order of all components • Placeholder = individual, fixed boot sequence that is not changed automatically
Boot Type Order (for Boot menu mode "Normal" only)	Submenu for setting the boot order of component groups relative to one another
Hard disk drive (for Boot menu mode "Normal" only)	Submenu for setting the boot order within the group of drives

Boot menu > "Boot Type Order" sub-submenu

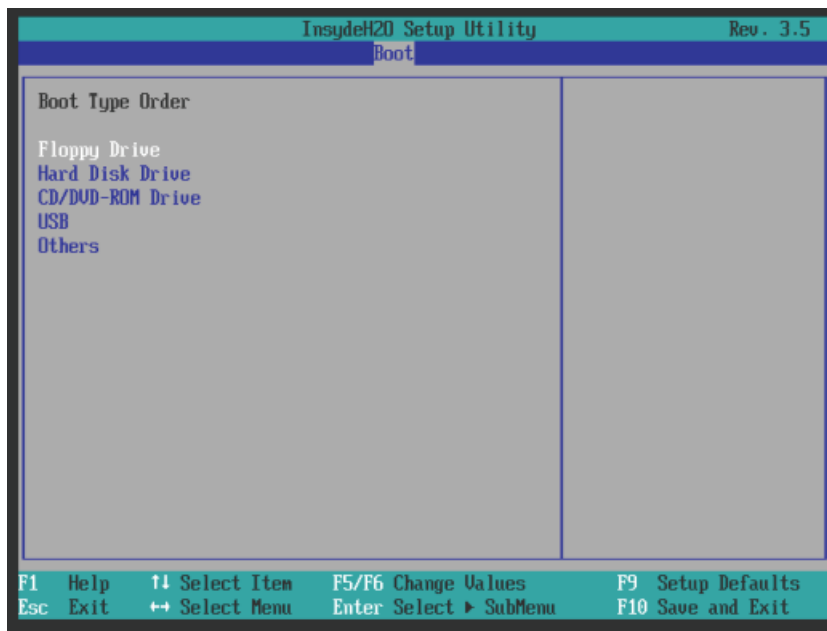

Entry	Meaning
Entry	Meaning
Floppy drive	Setting the boot order within the group of magnetic card drives
Hard disk drive	Setting the boot order within the group of drives
CD/DVD ROM Drive	Setting the boot order within the group of optical drives
USB	Setting the boot order within the group of USB drives
Others	Setting the boot order within the Others group, for example, Remote Boot device

"Hard Disc Drive" sub-submenu

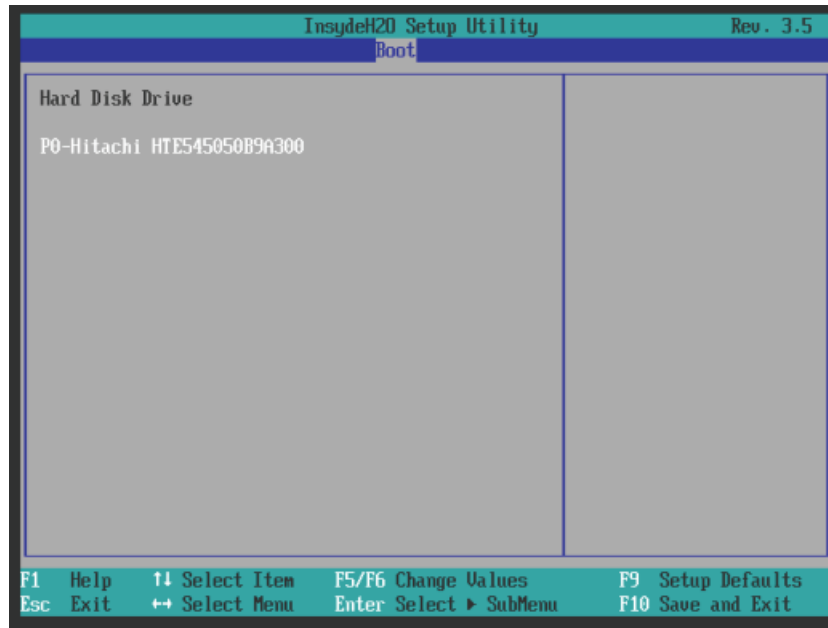

Boot menu > "Legacy Boot Type Order (Advance) and (Placeholder)" submenu

In this menu all the connected bootable components and their booting position are displayed. The booting position of the component can be moved freely.

During booting the component at the first position (highest booting priority) is used. If the component is not available, booting is carried out from the next component in the list.

The boot sequence is changed as follows:

Select the boot component with the ↑ ↓ keys, move to the desired position with + or -.

Note

During the booting process the boot manager can be started by using the F12 key. The boot manager displays all the available boot components and boots the device selected by the user.

"Legacy Boot Type Order (Advance)" submenu

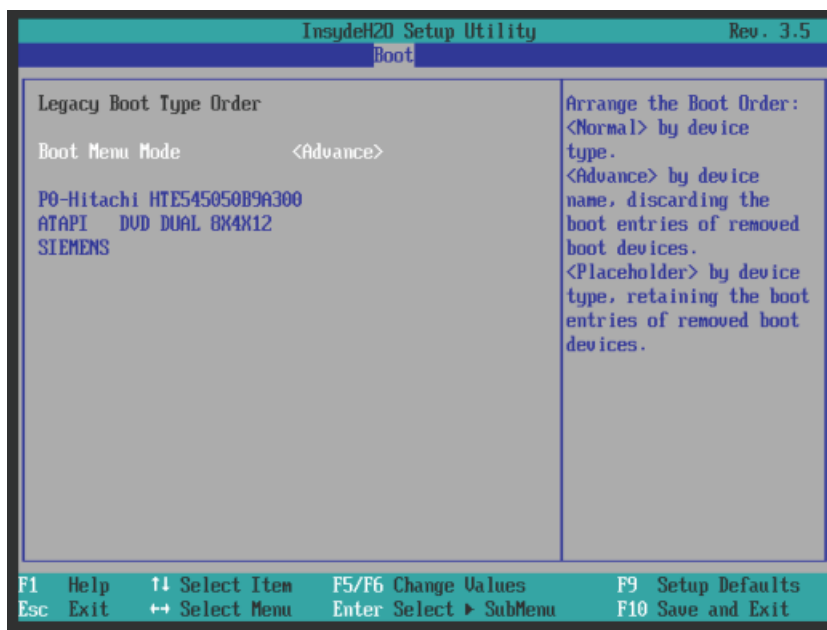

BIOS sets bootable components that are disconnected and reconnected on the PC between the boot processes to the first position in the "Advance" setting.

"Legacy Boot Type Order (Placeholder)" submenu

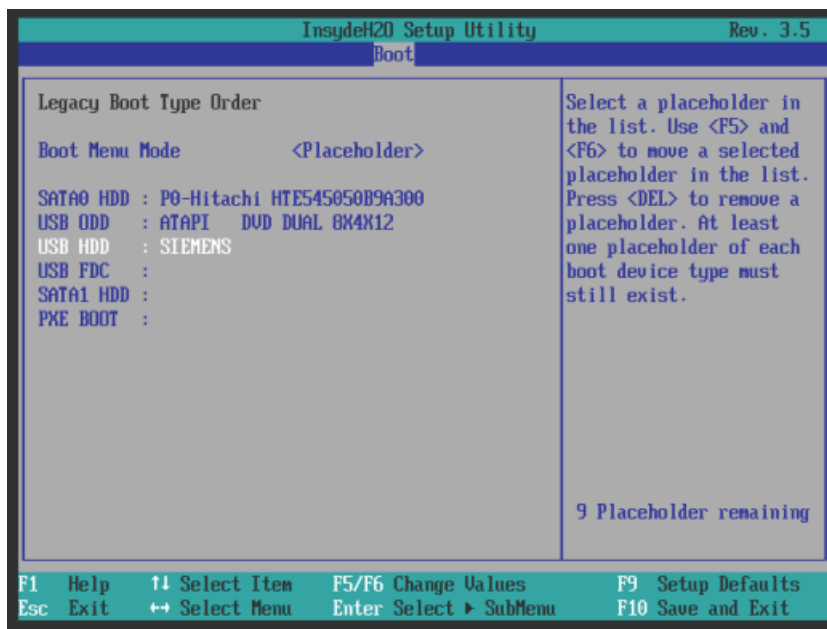

BIOS sets bootable components that are disconnected and reconnected on the PC between the boot processes to their original boot position in the "Placeholder" setting (Placeholder Boot).

9.6.3.7 Version menu

The menu shows the versions of important device-specific functions, for example, Option ROM. Keep this information at hand if customer support has technical questions about your system.

Example

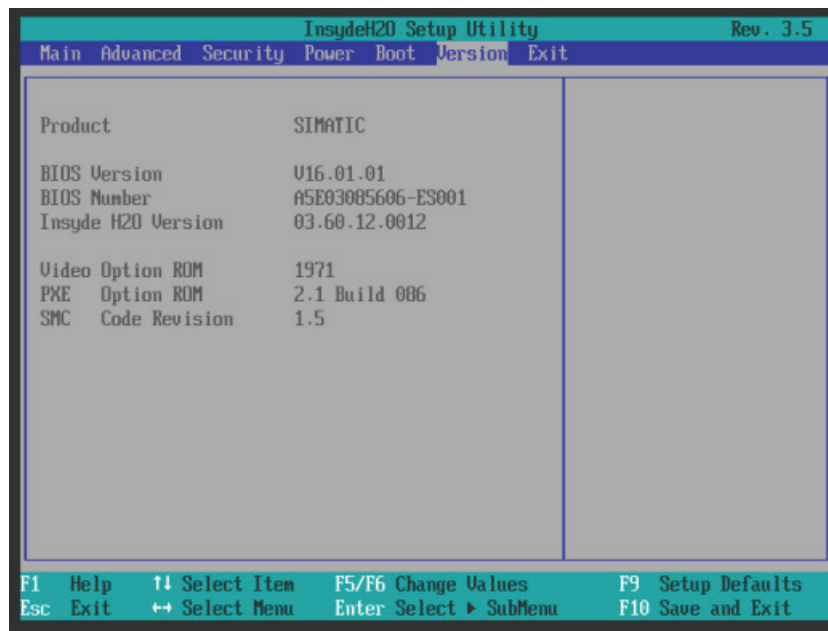

9.6.3.8 Exit menu

You always exit BIOS Setup in this menu.

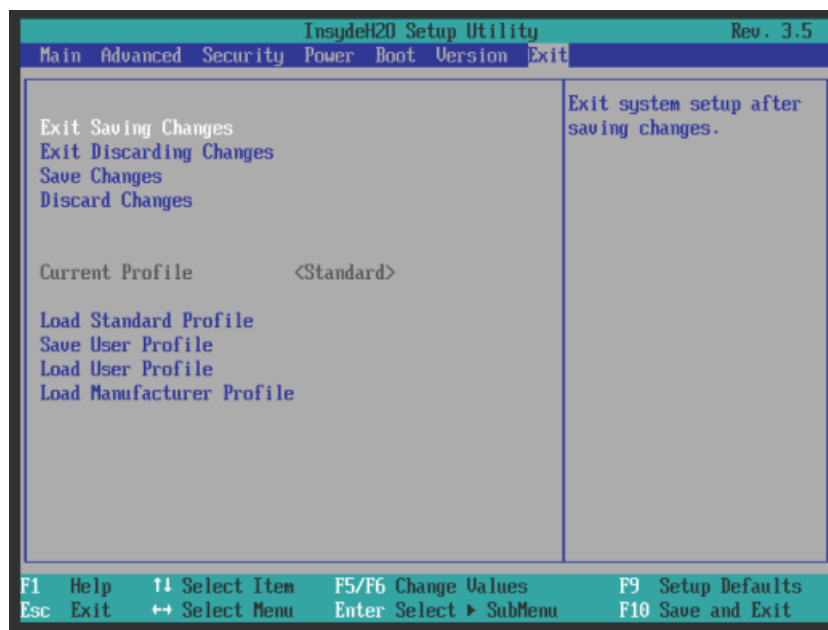

Settings in the Exit menu

Exit Saving Changes	All changes are saved and the system is restarted with the new parameters.	
Exit Discarding Changes	All changes are discarded and the system is restarted with the old parameters.	
Save Changes	All changes are saved.	
Discard Changes	All changes are discarded.	
Current profile	Standard	The BIOS settings are saved in the Flash memory.
	User	The BIOS settings are retained with <F9> "load defaults".
	Manufacturer	This setting is only used for production purposes. Do not use.
Load <Standard User Manufacturer> profile	Loads the values of the respective profile.	
Save user profile	Saves the user profile values.	

9.6.4 BIOS Setup default settings

Documenting your device configuration

If you have changed any default settings in Setup, you can enter them in the following table. You can then refer to these entries for any future hardware modifications.

Note

Print out the table below and keep the pages in a safe place once you made your entries.

Note

The default setup settings vary depending on the ordered device configuration. If you have changed any default settings in Setup, you can enter them in the following table. You can then refer to these entries for any future hardware modifications.

BIOS Setup default settings

System parameters	Default settings	Local settings
Main		
System Time	hh:mm:ss	
System Date	MM/DD/YYYY	

System parameters	Default settings	Local settings
Advanced>Peripheral Configuration		
Onboard Ethernet 2	Enabled	

System parameters	Default settings	Local settings
Advanced>Video Configuration		
Panel brightness	<85%>	

System parameters	Default settings	Local settings
Advanced>Chipset Configuration		
HPET - HPET Support	Enabled	

System parameters	Default settings	Local settings
Advanced>CPU Configuration		
C-States	Disabled	
P-States (IST)	Disabled	
HT Support	Auto	
VT Support	Enabled	

System parameters	Default settings	Local settings
Security		
Supervisor Password	Not installed	
User password	Not installed	
Set Supervisor Password	Inactive (no password assigned)	
Set User Password	Inactive (no password assigned)	

System parameters	Default settings	Local settings
Power		
Wake on LAN 2	Disabled	
CMOS battery present	Yes	

System parameters	Default settings	Local settings
Boot		
Quick Boot	Enabled	
Quiet Boot	Disabled	
Boot delay	3	
POST errors	All without keyboard	
Numlock	On	
USB Boot	Disabled	
PXE Boot to LAN 2	Disabled	

System parameters	Default settings	Local settings
Boot > Legacy Boot Type Order		
Boot Menu Mode	Placeholder	
USB FDC		
USB ODD		
USB HDD		
SATA0 SSD		
PXE Boot		

System parameters	Default settings	Local settings
Exit		
Current profile	Standard	

9.6.5 Alarm, error and system messages

During startup (the boot process), the BIOS first performs a **Power On Self Test (POST)** and checks whether certain functional units of the PC are operating error-free. The boot sequence is immediately interrupted if critical errors occur.

BIOS initializes and tests further functional units if the POST does not return any errors. In this startup phase, the graphics controller is initialized and any error messages are output to the screen.

The error messages output by system BIOS are listed below. For information on error messages output by the operating system or application programs, refer to the corresponding manuals.

On-screen error messages

On-screen error message	Meaning/tip
Operating system not found	Possible causes: <ul style="list-style-type: none"> • No operating system installed • Operating system available, but the partition is not active
Keyboard controller error	Controller error. Contact your technical support team.
SMART error	Hard disk reports pending failure through S.M.A.R.T.
Real-time clock error	Battery is weak
Real-time clock has lost power	Time corrupt due to discharged battery
CMOS battery error	Battery exhausted
CMOS battery failed	Battery empty or not inserted

9.7 Functional scope in Windows

9.7.1 Windows Embedded Standard 2009

The overview below shows the most important device functions in Windows Embedded Standard 2009:

Function	HDD/SDD/CompactFlash card version
Enhanced Write Filter (EWF)	In RAM RAM(REG)
SIMATIC IPC DiagBase	Available
Pagefile	Deactivated in favor of the EWF
System Restore Core	Deactivated in favor of the EWF
File based Writefilter (FBWF)	Available
Registryfilter	Available
Device Update Agent (DUA)	Available
HORM	Available

9.7 Functional scope in Windows

Function	HDD/SDD/CompactFlash card version
Telnet Server	Available
Windows Backup	Available
User Mode Driver Framework (UMDF)	Available
MUI	GER default language: English
Administrator Account	Available
User Account	Available
Explorer Shell	Available
Internet Explorer (IE)	Available, IE7
Internet Information Server (IIS)	Available V5.1
Terminal Services	Available
Bluetooth	Available
Wireless Network Support	Available
Windows Firewall	Available
Windows Security Center	Available
MSN Explorer	Not available
Outlook Express	Available
Administrative Tools	Available
SMS Advanced Client	Not available
Remote Desktop	Available V6.0
Remote Assistance	Available
.NET Framework	Not available
ASP.NET	Not available
Windows .NET Messenger	Available V4.7
Code pages/User Location/Keyboard	Selection available
Disk Management Services	Available
Windows Installer Service	Available V 3.1
Class Installer	Available
CoDevice Installer	Available
Windows Movie Maker	Not available
Media Player	Available, V11.0
Windows Media Player Tour	Not available
DirectX	V9.0c
Accessories	Available
Help files for all components	Not available
Games	Not available
Fonts	118
Windows XP Tour	Not available
Microsoft Silverlight	Available V 1.0
NetMeeting	Available V 3.1

Note

Activation of "HORM" and creation of a "Hibernate File"

Activate "HORM" as follows to use the "Hibernate" function:

EWFMGR C: /activatehorm

"Hibernate" is activated following a restart. The system then always boots from this file.

9.7.2 Windows Embedded Standard 7

The overview shows the most important device functions under Windows Embedded Standard 7:

Function	HDD / SSD version	Memory card version
.Net Framework	Available, V3.5	Available, V3.5
Accessories	Available	Available
Aero background	Available	Available
Backup and Restore	Available	Available
Bluetooth	Available	Available
Dialog box filter	Available	Available
DirectX and Windows Device Experience	Available, V11	Available, V11
Domain services	Available	Available
Driver database	Available	Not available
Driver frameworks	Available	Available
Encrypted File System (EFS)	Available	Available
Enhanced Write Filter	Available	Available
Fax and Scan	Available	Available
File Based Write Filter (FBWF)	Available	Available
Fonts	134	48
Help and Support Engine	Available	Available
Hibernate Once Resume Many (HORM-EEF)	Available	Available
Image Mastering API V2	Available	Available
IME Base Components	Available	Available
Internet Explorer	Available, IE 8	Available, IE 8
Internet Information Server (IIS)	Available, V7.0	Available, V7.0
Language (Standard)	English ¹	English ¹
Mobility Center	Available	Available
Network and Sharing Center	Available	Available
Network Diagnostics	Available	Available
Pagefile	Available	Available
Printing Utilities and Management	Available	Available
Registry Filter	Available	Available

9.7 Functional scope in Windows

Function	HDD / SSD version	Memory card version
Remote Assistance	Available	Available
Remote Client	Available	Available
Remote Desktop	Available	Available
SIMATIC IPC DiagBase	Available, V1.4	Available, V1.4
Speech	Available	Not available
System Management Administrative Tools	Available	Available
Telnet Server	Available	Available
User Account Control	Available	Available
Windows Explorer Shell	Available	Available
Windows Firewall	Available	Available
Windows Installer	Available	Available
Windows Media Player	Available, V12	Available, V12
Windows PowerShell 2.0	Available	Available
Windows Search and Natural Language 6	Available	Available
Windows Security Center	Available	Available
Windows Update	Available	Available
Wireless Networking	Available	Available

¹ Note the licensing agreements for Windows Embedded Standard 7.

Additional information on language selection is available in the section "Setting up the language selection by means of the Multilanguage User Interface (MUI) (Page 85)".

Technical Support

A.1 Service and support

You can find additional information and support for the products described on the Internet at the following addresses:

- Technical support (http://www.siemens.de/automation/csi_en_WW)
- Support request form (<http://www.siemens.com/automation/support-request>)
- After-sales information system for SIMATIC PC / PG (<http://www.siemens.com/asis>)
- SIMATIC Documentation Collection (<http://www.siemens.com/simatic-tech-doku-portal>)
- Your local representative
(<http://www.automation.siemens.com/mcms/aspa-db/en/Pages/default.aspx>)
- Training center (<http://sitrain.automation.siemens.com/sitrainworld/?AppLang=en>)
- Industry Mall (<http://mall.automation.siemens.com>)

When contacting your local representative or Technical Support, please have the following information at hand:

- Order number of the device (MLFB)
- BIOS version (industry PC) or image version (HMI device)
- Installed additional hardware
- Installed additional software

Tools & downloads

Please check regularly if updates and hotfixes are available for download to your device. The downloads are available on the Internet under "After Sales Information System SIMATIC PC/PG" (see above).

A.2 Problem solving

This section provides you with tips on how to locate and/or troubleshoot problems which occur.

Problem	Possible cause	Possible remedy
The device is not operational	No power supply	<ul style="list-style-type: none"> Check the power supply, the power cord and the power plug. Check if the On/Off switch is in the correct position.
	Device is being operated outside the specified ambient conditions	<ul style="list-style-type: none"> Check the ambient conditions. After transport in cold weather, wait approximately 12 hours before switching on the device.
The monitor remains dark	The brightness button has been set to dark	Increase brightness using the brightness button. For detailed information, please refer to the monitor operating instructions.
	Power cord is not connected	<ul style="list-style-type: none"> Check whether the power cord has been properly connected to the monitor and to the system unit or to the grounded shockproof outlet.
		If the monitor screen still remains dark after you have performed these checks and measures, contact your technical support team.
The mouse pointer does not appear on the screen	The mouse driver is not loaded	Check whether the mouse driver is properly installed and available when you start the user program. Detailed information about the mouse driver is available in the corresponding documentation.
	Mouse not connected.	<ul style="list-style-type: none"> Check whether the mouse cord is properly connected to the system unit. If you use an adapter or expansion for the mouse cable, also check these connectors.
		If the mouse pointer still does not appear on the screen after you have performed these checks and actions, contact your technical support team.
Wrong time and/or date on the PC		<ol style="list-style-type: none"> Press <F2> during the booting process to open the BIOS Setup. Set the time and date in the setup menu.
Although the BIOS setting is OK, the time and data are still wrong.	The backup battery is dead.	Replace the backup battery.
USB device not responding.	The USB ports are disabled in BIOS.	Use a different USB port or enable the port.
	The operating system does not support the USB ports.	<ul style="list-style-type: none"> Turn on USB Legacy Support for mouse and keyboard. For other devices, you need the USB device drivers for the required operating system.
"chkdsk" is not functioning	EWF (Enhanced Write Filter) has been activated. The "chkdsk" command is not supported if the EWF has been activated.	Deactivate the EWF or use an alternative method to "chkdsk".

B

List of abbreviations

AC	Alternating current	Alternating current
ACPI	Advanced Configuration and Power Interface	
AHCI	Advanced Host Controller Interface	Standardized controller interface for SATA devices. This is supported in Microsoft Windows XP as of SP1 and IAA driver.
APIC	Advanced Programmable Interrupt Controller	
AT	Advanced Technology	
ATA	Advanced Technology Attachment	
AWG	American Wire Gauge	Unit of measurement for wire diameter. Used in North America and Canada.
BIOS	Basic Input Output System	
CAN	Controller Area Network	
CD-ROM	Compact Disc – Read Only Memory	
CE	Communauté Européenne	
CF	CompactFlash	
CMOS	Complementary Metal Oxide Semiconductors	
COA	Certificate of authentication	
COM	Communications Port	Term for the serial interface
CPU	Central Processing Unit	CPU
CSA	Canadian Standards Association	Canadian organization for tests and certifications according to national or binational standards
CTS	Clear To Send	Clear to send
DC	Direct Current	DC current
DCD	Data Carrier Detect	Data carrier signal detection
DMA	Direct Memory Access	
DOS	Disk Operating System	
DQS	Deutsche Gesellschaft zur Zertifizierung von Qualitätsmanagement mBH	
DSR	Data Set Ready	Ready for operation
DTR	Data Terminal Ready	Data terminal is ready
DVD	Digital Versatile Disk	
ESD	Electrostatic Sensitive Devices	
EN	European standard	

EEPROM	Electrically Erasable Programmable Read-Only Memory	
ESD	Electrostatic Sensitive Device Electrostatic discharge	Electrostatic Sensitive Device Electrostatic discharge
EWf	Enhanced Write Filter	
FBWF	File Based Write Filter	
GND	Ground	Chassis ground
HD	Hard disk	Hard disk
HDD	Hard Disk Drive	HDD
HMI	Human Machine Interface	User interface
HORM	Hibernate Once - Resume Many	
HT	Hyper-Threading	
I/O	Input/Output	Data input/output for computers
IDE	Integrated Device Electronics	
IEC	International Electrotechnical Commission	
IGD	Integrated Graphics Device	
IP	Ingress Protection	Degree of protection
IRQ	Interrupt Request	
ISA	Industry Standard Architecture	Bus for expansion modules
LAN	Local Area Network	Computer network that is limited to a local area.
LEDs	Light Emitting Diode	Light emitting diode
LPS	Limited Power Source	
MAC	Media access control	Media access control
MLFB	Machine-readable product designation	
MS	Microsoft	
MTBF	Mean Time Between Failures	
MUI	Multilanguage User Interface	Language localization in Windows
NTFS	New Techniques File System	
NVRAM	Non Volatile Random Access Memory	Non-volatile data memory. Data memory is retained without external power supply.
ODD	Optical Disk Drive	
PC	Personal computer	
PCI	Peripheral Component Interconnect	High-speed expansion bus
PCIe	Peripheral Component Interconnect express	High-speed serial, differential full-duplex PtP interface with high data rate.
PG	Programming device	
POST	Power On Self Test	
PXE	Preboot Execution Environment	Software for running new PCs without hard disk data via the network

RAID	Redundant Array of Independent Disks	Redundant hard disk array
RAL	Restricted Access Location	
RAM	Random Access Memory	
RI	Ring Input	Incoming call
ROM	Read-Only Memory	
RS 485	Reconciliation Sublayer 485	Bidirectional bus system
RTC	Real Time Clock	Real-time clock
RTS	Reliable Transfer Service	Request to send
RxD	Receive Data	Data transfer signal
SATA	Serial Advanced Technology Attachment	
SELV	Safety Extra Low Voltage	Safety extra low voltage
SMART	Self Monitoring Analysis and Reporting Technology	Hard disk error diagnostics program
SRAM	Static Random Access Memory	Static RAM
SSD	Solid State Drive	
TFT	Thin-Film-Transistor	
TxD	Transmit Data	Data transfer signal
UEFI	Unified Extensible Firmware Interface	
UL	Underwriters Laboratories Inc.	US organization for testing and certification according to national or binational standards.
USB	Universal Serial Bus	
VDE	Verein deutscher Elektrotechniker (Union of German Electrical Engineers)	
VT	Virtualization Technology	Intel technology which makes available a virtual, closed environment.
VT-D	Virtualization Technology for Directed I/O	Enables the direct assignment of a device (e.g. network adapter) to a virtual device.
WD	Watchdog	Program monitoring with error detection and alarming.

Glossary

AHCI mode

AHCI is a standardized method to address the SATA controller. AHCI describes a structure in the RAM, which contains a general area for control and status, as well as a command list.

APIC mode

Advanced peripheral interrupt controller. 24 interrupt lines are available.

Automation system

A programmable controller (PLC) of the SIMATIC S7 system consist of a central controller, one or several CPUs, and various I/O modules.

Backup

Duplicate of a program, data medium or database, used either for archiving purposes or for the protection of vital and non-replaceable data against loss when the working copy is corrupted. Certain applications automatically generate backup copies of data files, and manage both the current and the previous versions on the hard disk.

Baud

Physical unit for the step speed in signal transmission. Defines the number of transferred signal states per second. With only two states, one baud is equivalent to a transmission rate of 1 bps.

Boot disk

A boot disk is a disk with a "Boot" sector. This can be used to load the operating system from the disk.

Cache

High-speed access buffer for interim storage (buffering) of requested data.

CE marking

Communauté Européene The CE mark confirms compliance of the product with corresponding EC Directives, for example, with the EMC Directive.

Chipset

Located on the motherboard, connects the processor with the PCI or PCIe bus and the external interfaces.

Cold restart

A start sequence, starting when the computer is switched on. The system usually performs some basic hardware checks within the cold start sequence, and then loads the operating system from the hard disk to work memory -> boot

COM interface

The COM interface is a serial V.24 interface. The interface is suitable for asynchronous data transfer.

CompactFlash card

CompactFlash is a digital storage medium in card format and without moving parts. The CF card contains the non-volatile memory and the controller. The interface of the CF card corresponds with the IDE interface. CF cards can be operated without additional electronics on PCMCIA or IDE hard disk controllers using a plug and socket adapter. There are two design forms: CF-I (42.6 x 36.4 x 3.3 mm) and CF-II (42.8 x 36.4 x 5 mm).

Configuration files

These are files containing data which define the configuration after restart. Examples of such files are CONFIG.SYS, AUTOEXEC.BAT and the registry files .

Configuration software

The configuration software updates the device configuration when new modules are installed . This is done either by copying the configuration files supplied with the module or by manual configuration using the configuration utility.

Controller

Integrated hardware and software controllers that control the functions of certain internal or peripheral devices (for example, the keyboard controller).

Device configuration

The configuration of a PC or programming device contains information on hardware and device options, such as memory configuration, drive types, monitor, network address, etc. The data are stored in a configuration file and enable the operating system to load the correct device drivers and configure the correct device parameters. . If changes are made to the hardware configuration, the user can change entries in the configuration file using the SETUP program. .

Drivers

Program parts of the operating system. They adapt user program data to the specific formats required by I/O devices such as hard disk, printers, and monitors.

EMC directive

Directive concerning **E**lectromagnetic **C**ompatib**I**lity. Compliance is confirmed by the CE symbol and the EC certificate of conformity.

Energy management

The energy management functions of a modern PC allow individual control over the current consumption of vital computer components (e.g. of the monitor, hard disk and CPU), by restricting their activity based on the current system or component load. Energy management is of particular importance for mobile PCs.

Energy options

The energy options can be used to reduce energy consumption of the computer, while keeping it ready for immediate use. This can be configured in Windows by selecting Settings > Control Panel > Energy options.

Enhanced Write Filter

Configurable write filter that allows you to, for example, boot Windows Embedded Standard from write-protected media (e.g., CD-ROM), set write protection for individual partitions, and adapt the file system performance to user requirements (when using memory cards, for example).

ESD Guideline

Guideline for using electrostatic sensitive components.

Ethernet

Local network (bus structure) for text and data communication with a transfer rate of 10/100/1000 Mbps.

Execute Disable Capability

Hardware implementation that prevents mutual memory accesses by programs and applications. It is only effective when all relevant system components, such as processors, operating systems and applications are supported.

Extensible Firmware Interface

Refers to the central interface between the firmware, the individual components of a computer and the operating system. EFI is located logically beneath the operating system and represents the successor to PC BIOS, focusing on 64-bit systems.

File Based Write Filter

Configurable write filter to protect individual files from write access.

Formatting

Basic partitioning of memory space on a magnetic data medium into tracks and segments. Formatting deletes all data on a data medium. All data media must be formatted prior to their first use.

HORM

Hibernate once, resume many is a method for fast booting from a single Hibernate file that only needs to be created once. HORM ensures restoration of a uniform, saved system state when booting. This minimizes write access, for example to a CompactFlash medium, when you start up and shut down Windows Embedded Standard 7.

Hub

A term in network technology. In a network, a device joining communication lines at a central location, providing a common connection to all devices on the network.

Hyper Threading

HT technology (multi-threading) enables the parallel computing of processes. HT is only effective when all relevant system components, such as processors, operating systems and applications are supported.

IGD

Integrated Graphics Device. Graphics interface integrated in the chipset.

Image

This refers to the image, for example, of hard disk partitions saved to a file in order to restore them when necessary.

Intel Active Management Technology

This technology permits the diagnostics, management and remote control of PCs. It is only effective when all relevant system components, such as processors, operating systems and applications are supported.

Intel VT

The Intel Virtualization Technology (IVT) is the implementation of a secure closed environment for applications. Special (visualization) software on a VT-capable processor is required for its use.

Interface

- Physical interconnection (cable) of hardware elements such as PLCs, PCs, programming devices, printers or monitors.
- Interface for interactive software applications.

LAN

Local Area Network: LAN is a local network that consists of a group of computers and other devices that are distributed across a relatively restricted range and are linked with communication cables. The devices connected to a LAN are called nodes. The purpose of networks is the mutual use of files, printers or other resources.

Legacy Boot Device

Conventional drives can be used as USB devices.

License key

The license key represents the electronic license stamp of a license. Siemens provides the license keys for protected software.

License key disk

The license key disk contains the authorizations or license keys required to enable protected SIMATIC software.

Low-voltage directive

EC Product Safety Directive relating to the safety of products which are operated on low voltage (50 V AC to 1000 V AC, 70 V DC to 1500 V DC) and not specified in other directives. Compliance is confirmed by the CE symbol and the EC certificate of conformity.

Module

Modules are plug-in units for PLCs, programming devices or PCs. They are available as local modules, expansion modules, interfaces or mass storage (Mass storage module).

Motherboard

The motherboard is the core of the computer. Here, data are processed and stored, and interfaces and device I/Os are controlled and managed.

Operating system

Generic term which describes all functions for controlling and monitoring user program execution, distribution of system resources to the user programs and the operating mode in cooperation with the hardware (for example, Windows 7 Ultimate).

Pixel

The pixel represents the smallest element that can be reproduced on-screen or on a printer.

Plug&Play

Generally, a reference to the ability of a computer to automatically configure the system for communication with peripheral devices (for example monitors, modems or printers). The user can plug in a peripheral and "play" it at once without manually configuring the system. A Plug&Play PC requires both a BIOS that supports Plug&Play and a Plug&Play expansion card.

POST

Self-test performed by the BIOS after the computer is switched on. Performs a RAM test and a graphics controller test, for example. The system outputs audible signals (beep codes) if the BIOS detects any errors; the relevant message indicating cause of error is output on the screen.

Programmable controller

The programmable controllers of the SIMATIC S5 system consist of a central controller, one or several CPUs and various other modules (for example, I/O modules).

PXE server

A Preboot Execution Environment server is part of a network environment and can provide software to connected computers even before they boot. This can involve operating system installations or servicing tools, for example.

RAL

Restricted Access Location: Installation of the device in a production facility with restricted access, for example, a locked control cabinet.

Recovery CD

Contains the tools for configuring hard disks and the Windows operating system.

Reset

Hardware reset: Reset/restart of the PC using a button/switch.

Restart

Warm restart of a computer without switching the power off (Ctrl + Alt + Del)

Restore DVD

The Restore DVD is used to restore the system partition or the entire hard disk to factory state if the system has crashed. The bootable DVD contains all the necessary image files. You can also create a boot disk allowing restoration via the network.

ROM

Read-Only Memory ROM is a read-only memory in which every memory location can be addressed individually. The programs or data are permanently stored and are not lost in the event of a power failure.

S.M.A.R.T

The Self-Monitoring, Analysis and Reporting Technology (SMART or S.M.A.R.T.) is an industry standard integrated in storage media. It makes for permanent monitoring of important parameters and early detection of imminent problems.

SATA

Serial ATA Interface for hard disk drives and optical drives with serial data transmission rates of up to 300 Mbps.

SETUP (BIOS Setup)

A program in which information about the device configuration (that is the configuration of the hardware on the PC/PG) is defined. The device configuration of the PC/PG is preset with defaults. Changes must therefore be entered in the SETUP if a memory expansion, new modules or a new drive are added to the hardware configuration.

SSD (Solid State Drive)

A Solid State Drive is a drive that can be installed like any other drive; it does not contain a rotating disk or other moving parts because only semiconductor memory chips of similar capacity will be used. This design makes SSDs more rugged, provides shorter access times, low energy consumption and rapid data transfer.

STEP 7

Programming software for the creation of user programs for SIMATIC S7 controllers.

Troubleshooting

Error cause, cause analysis, remedy

Trusted Execution Technology

Hardware implementation that allows secured execution of programs and applications. It is only effective when all relevant system components, such as processors, operating systems and applications are supported.

Wake on LAN

Wake on Local area network. This function allows the PC to be started via the LAN interface.

Warm restart

The restart of a computer after a program was aborted. The operating system is loaded and restarted again. The CTRL+ ALT+ DEL hotkey can be used to initiate a warm restart.

Index

"

"Chipset Configuration" submenu, 118
"CPU Configuration" submenu, 119
"Peripheral Configuration" submenu, 117
"Video Configuration" submenu, 117

A

Adapting
 Partitioning, 87
AHCI controller
 Making known to the operating system, 82
Antivirus software, 45
Approval
 Shipbuilding, 93
Authorization, 78

B

Backup battery, 49
Battery monitoring, 49
BIOS Setup, 113
 Advanced menu, 116
 Boot menu, 122
 Default settings, 129
 Exit menu, 127
 Main menu, 115
 Menu layout, 114
 Power menu, 121
 Security menu, 120
 Version menu, 127
Boot sequence, 131

C

CE marking, 91
Certificates, 91
 Certifications and approvals, 91
chkdsk, 136
Cleaning Agents, 69
COA label, 27
Components sensitive to electrostatic charge, 93
Condensation, 26

Connecting
 Network, 39
 Peripherals, 35
 Protective earth, 36
Connecting the protective earth, 36
Creating an image, 90

D

Data backup, 90
Data carrier controller
 Making known to the operating system, 82
Data exchange, 39
Date
 BIOS Setup, 115
DC power supply, 107
Degree of protection, 29
Device
 Closing, 66
 Opening, 66
 Switching off, 44
Device configuration, 128
DiagBase software, 47
DiagMonitor
 Temperature monitoring, 48
DiagMonitor software, 47
Diagnostics,
 DiagBase software, 47
 DiagMonitor software, 47
 Error Messages, 131
Directive
 ESD Directive, 93
Display, 23
 Size, 9
Documentation and Drivers CD/DVD, 77
Drive, 102
Driver installation, 88

E

EC Declaration of Conformity, 91
Enhanced Write Filter, 49
ESD, 93
ESD Directive, 93
Ethernet, 108
EWF (Enhanced Write Filter), 49
External interfaces, 108

F

- FBWF (File Based Write Filter), 51
- File-Based Write Filter, 51
- Fire protection covering, 31
- Fire protection enclosure, 31
- Firewall, 45

H

- Hibernate
 - Enable, 133
- HMI device
 - Mounting, 33

I

- Identification data, 26
- Industrial Ethernet, 40
- Initial commissioning, 44
- Installation guidelines, 31
- Installation information, 31
- Installation of operating system
 - Windows 7, 81
 - Windows XP, 79
- Installing language package, 85
- Integration
 - Ethernet, 39
 - Industrial Ethernet, 40
 - PROFINET, 40
- Interface, 103
- IT communication, 39
- IT Security, 21

L

- License key, 78
- Limitation of Liability, 70

M

- Marking
 - EC Declaration of Conformity, 91
- Memory card
 - Inserting, 67
 - Removing, 66
- Memory medium, 102
- Messages
 - On the screen, 131
- Monitoring functions, 47

- Motherboard
 - External interfaces, 108
 - Technical features, 108

- Mounting
 - HMI device, 33
- Mounting clamp
 - Mounting, 32
- Mounting cutout
 - Dimensions, 30
 - Preparing, 30
- Mounting positions, 28
- MRAM, 53
- MUI, 85

N

- Note, 31
 - General Information, 22
 - Installation guidelines, 31

O

- On-screen error messages, 131
- Operating system
 - Initial commissioning, 44
- Operation
 - Touch screen, 55

P

- Package contents, 25
 - Checking, 25
- Packaging, 25
 - Checking, 25
 - Removing, 25
- Partition, 84
 - Windows 7 in factory state, 84
 - Windows XP factory state, 80
- Partitioning
 - Adapting, 87
 - CompactFlash card, 86
 - SSD, 87
 - Windows 7, 87
 - Windows Embedded Standard 2009, 86
 - Windows XP, 87
- Pixel, 23
 - Defective pixel, 23
- Power supply
 - DC power supply, 107
 - Power requirements of additional components, 107
- PROFINET, 40

Protective earth, 36
 Protective measure
 Static electricity, 95

R

Radiation, 20
 High frequency radiation, 20
 Rating plate, 27
 Real-time protection, 45
 Recovery DVD, 77
 Repairs, 71
 Replacement device, 71
 Restore DVD,
 Restoring the factory state, 78

S

Safety
 Certificates, 91
 Standards, 91
 Safety information
 Storage, 26
 Transportation, 26
 Screen keyboard
 calling, 60
 Screen saver, 62
 Security information, 21
 SetBrightness, 60
 Setting up partitions, 82
 Setting up the language selection, 85
 Shipbuilding
 Assembly for shipbuilding, 105
 Shipbuilding approval, 93
 SIMATIC NET, 40
 SIMATIC S7, 39
 Integration, 39
 Software, 78
 SSD
 Partitioning, 87
 Standards, 91
 Startup, 131
 Static electricity
 Protective measures, 95
 System Date, 115
 System partition, 78
 System resources, 110
 Currently allocated system resources, 110
 System Time, 115

T

Teaming, 103
 Temperature monitoring, 48
 Time
 BIOS Setup, 115
 Tools, 71
 Touch input
 Calling the screen keyboard, 60
 Touch screen
 Operation, 55

U

Updates
 Application programs and drives, 90
 USB, 108
 User password, 120

V

Ventilation slits, 31

W

Warranty, 19
 Watchdog, 48
 Monitoring function, 48
 Monitoring times, 49
 Windows 7
 Installation, 81
 Partitioning a drive, 87
 Windows 7 Ultimate
 Data backup, 90
 Windows Embedded Standard
 Data backup, 90
 Driver installation, 88
 Windows Embedded Standard 2009
 Partitioning a drive, 86
 Windows Security Center, 45
 Windows XP
 Installation, 79
 Partitioning a drive, 87
 Windows XP Professional
 Data backup, 90
 WinMove, 64

