

SIMADYN D Digital Control System

User Manual

I/O board EM11

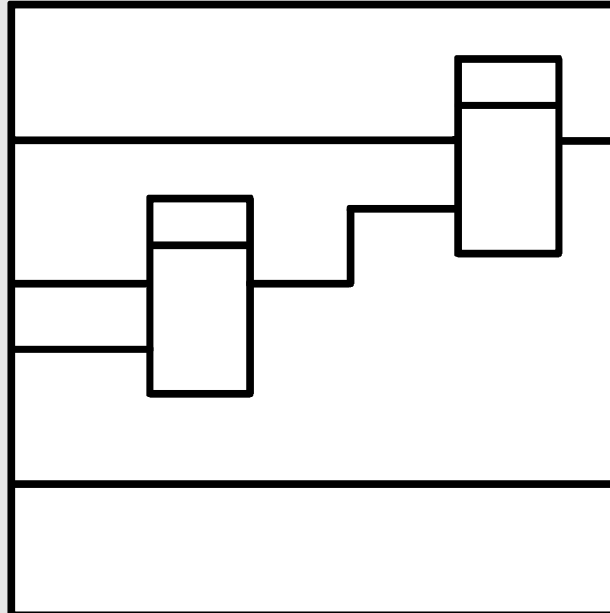

User Manual, I/O board EM11

Edition		Edition status
1	I/O board EM11	03.91
2	I/O board EM11	05.95

Copying of this document and giving it to others and the use or communication of the contents thereof is forbidden without express authority. Offenders are liable to the payment of damages. All rights are reserved in the event of the grant of a patent or the registration of a utility model or design.

We have checked the contents of this Manual to ensure that they coincide with the described hardware and software. However, deviations cannot be completely ruled-out, so we cannot guarantee complete conformance. However, the information in this document is regularly checked and the necessary corrections included in subsequent editions. We are thankful for any recommendations or suggestions.

Contents

Warning information.....	1
1. Description.....	3
1.1. New functions.....	4
1.1.1. RIC: *RDY-INTERNAL-CONTROL.....	4
1.1.2. Speed Value Inputs.....	4
1.1.3. Monitor Input of the Speed Value Connector.....	5
1.1.4. Monitor Register for the Speed Value Input.....	5
1.1.5. Binary outputs.....	6
1.1.6. Analog outputs.....	6
2. Board Design.....	7
3. Application Notes.....	8
4. Technical Specification.....	10
5. Connector Pin Assignments of the EM 11.....	13
5.1. Pin Assignments for Actual Speed Value, Connector X5.....	13
5.2. Pin Assignments of the Analog Inputs and Outputs, Connector X6.....	13
5.3. Pin Assignments for the Binary Inputs/Outputs, Connector X7.....	14
6. STRUC-L menu.....	15
7. Miscellaneous.....	16
7.1. Appendices.....	16
7.1.1. Diagrams.....	16
7.1.2. Drawings.....	18
8. ECB instructions.....	19

NOTE!

The information in this Manual does not purport to cover all details or variations in equipment, nor to provide for every possible contingency to be met in connection with installation, operation or maintenance.

Should further information be desired or should particular problems arise which are not covered sufficiently for the purchaser's purposes, please contact your local Siemens office.

Further, the contents of this Manual shall not become a part of or modify any prior or existing agreement, commitment or relationship. The sales contract contains the entire obligation of Siemens. The warranty contained in the contract between the parties is the sole warranty of Siemens. Any statements contained herein do not create new warranties nor modify the existing warranty.

Warning information

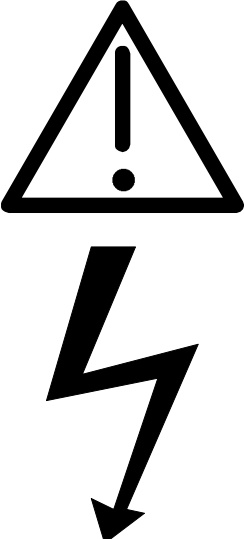
	WARNING!
	<p>Electrical equipment has components which are at dangerous voltage levels.</p> <p>If these instructions are not strictly adhered to, severe bodily injury and material damage can result.</p> <p>Only appropriately qualified personnel may work on this equipment or in its vicinity.</p> <p>This personnel must be completely knowledgeable about all the warnings and service measures according to this User Manual.</p> <p>The successful and safe operation of this equipment is dependent on proper handling, installation, operation and maintenance.</p>

Definitions

* **QUALIFIED PERSONNEL**

For the purpose of this User Manual and product labels, a „Qualified person“ is someone who is familiar with the installation, mounting, start-up and operation of the equipment and the hazards involved. He or she must have the following qualifications:

1. Trained and authorized to energize, de-energize, clear, ground and tag circuits and equipment in accordance with established safety procedures.
2. Trained in the proper care and use of protective equipment in accordance with established safety procedures.
3. Trained in rendering first aid.

* **DANGER**

For the purpose of this User Manual and product labels, „Danger“ indicates death, severe personal injury and/or substantial property damage will result if proper precautions are not taken.

* **WARNING**

For the purpose of this User Manual and product labels, „Warning“ indicates death, severe personal injury or property damage can result if proper precautions are not taken.

* **CAUTION**

For the purpose of this User Manual and product labels, „Caution“ indicates that minor personal injury or material damage can result if proper precautions are not taken.

* **NOTE**

For the purpose of this User Manual, „Note“ indicates information about the product or the respective part of the User Manual which is essential to highlight.

	CAUTION!
	This board contains components which can be destroyed by electrostatic discharge. Prior to touching any electronics board, your body must be electrically discharged. This can be simply done by touching a conductive, grounded object immediately beforehand (e.g. bare metal cabinet components, socket protective conductor contact).

	WARNING!
	Hazardous voltages are present in this electrical equipment during operation. Non-observance of the safety instructions can result in severe personal injury or property damage. It is especially important that the warning information in all of the relevant Operating Instructions are strictly observed.

1. Description

The EM11 I/O board is used for digitizing (analog inputs with A/D or V/F/D converters) and for the output of analog voltage signals, for the input of binary signals (speed), for input/output (binary I/O) and display (LED) of binary information.

The programmable address decoder calculates the board address, related to the board location.

The board features the following:

- a) X6: For digitizing analog voltage signals:
 - * Four channels with A/D conversion,
 - * Four channels with V/F and subsequent F/D conversion (V/F/D conversion)
- b) X6: For the output of analog voltage signals:
 - * Two channels with D/A conversion
- c) X5: For incremental encoding:
 - * One channel for actual speed value and position encoding with inputs for two tracks plus the zero marking pulse;
 - * Subsequent digital filter and quadrupling the track frequency of the incremental shaft angle encoder
 - * One input for function monitoring
- d) X7: For the input and output of binary information:
 - * 16 binary inputs and 8 binary outputs.
 - * 4 binary outputs for signal states of connector X5
- e) H10/H20: For display:
 - * 16 LED's on the front panel, logical order in two bytes:
 - * one byte (H10) with red LED's (H11-H18, H11 is the least sign. bit)
 - * one byte (H20) with yellow LED's (H21-H28, H21 is the least sign. bit)
 - * independent from binary signals in d)

The 40 pin BERG connector X7 at the front panel is arranged in three rows of ten and one row of six pins, whereas

- * 10 pins are designed for 8-bit values, external supply with P 24 external and M 24 external, and
- * 6 pins are assigned to the zero marking pulse, track A signal,

track B signal, monitor signal for connector X5, P 24 external and M 24 external (the other 4 pins are not connected).

The connector is thus sub-divided into the following sections:

- * 2 sections (bytes) for input,
- * 1 section (byte) for output and
- * 4 single bit output (1 bit information, wired and not configurable) for the zero marking pulse, track A, track B and X5 monitor signal.

1.1. New functions

The board offers some additional features starting from version 3.0. It is compatible with former versions, as long as the following is adhered to:

- The nominal levels of the speed value input (connector X5) are 15 V.
- The 5 V (supply for a shaft angle encoder) are no longer available at pins 9 and 10 of the connector X5.

1.1.1. RIC: *RDY-INTERNAL-CONTROL

The new connector RIC in the board screen is designed to suppress the board reset signal *BGRES when the *RDYIN signal occurs. An active signal *RDYIN usually generates a board reset *BGRES, which causes the outputs (analog and binary: output of zero volts) to be disabled. The board requires a renewed initialization. The RIC enables the board to continue running without *BGRES when a processor fails in the sub-rack (*RDYIN active).

Filtering out this signal is only effective until the next *RESAD (reset signal from the power supply, always generates a *BGRES).

If the *RDYIN is to be ineffective on the board, then a "Y" must be configured at the RIC connector (i.e. the outputs remain active). The board does then not run a reset and the outputs remain enabled. The default value of "N" in the STRUC-L screen corresponds to the functionality of the previous board version.

1.1.2. Speed Value Inputs

The three tracks A, B and zero are detected via differential inputs with a rated voltage level of 15V. The threshold lies by approximately half the rated level with a hysteresis of 5 to 15% of the rated level (see technical specifications). The corresponding minus terminal of each track may be grounded (ground supply terminal of the digital encoder from X5:M').

1.1.3. Monitor Input of the Speed Value Connector

The supply of the speed plug connector with P5 is dispensed with because of the definition of the speed signal level (5V - level deleted). The pins 9 and 10 have therefore become available for a monitoring signal with a level of 15V. The threshold lies by approximately half the rated level with a hysteresis of 5 to 15% of the rated level (see technical specifications).

The corresponding minus terminal of each track may be grounded (ground supply terminal of the digital encoder from X5:M').

The speed input can be monitored with this monitoring input. Connection of a monitoring signal from the digital speed encoder or checking whether the encoders plug is connected by jumpering P15' with the positive input pin 9 and jumpering M' (ground) with the negative input pin 10.

1.1.4. Monitor Register for the Speed Value Input

The EM11 board has an additional monitor register starting from version3.0, which is accessed via the ZPC connector.

Currently only bit 7 (X5_OK, status of monitoring input of X5) is utilized.

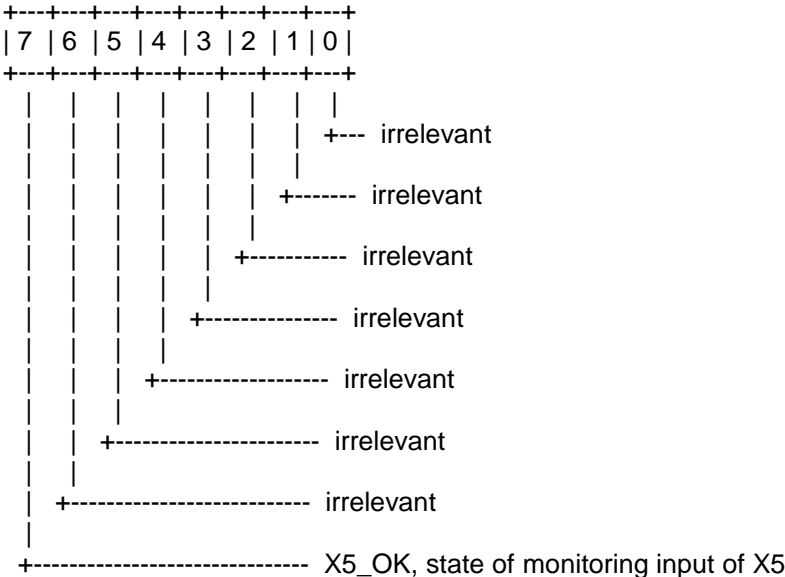

This bit has the state HIGH, if the switching threshold of the monitor input on speed value connector X5 is exceeded (see technical specification). Otherwise it is LOW.

1.1.5. Binary outputs

Three new binary outputs have been installed on previously unconnected pins of the sub-connector X7B (pins 12, 13, 14, see also connector allocation).

These outputs permanently take the state of internal 5V signals. These are set via output drivers to a 24V level (usual binary output SIMADYN D, no reaction on the original signal). The signals are the following:

- X7, pin 11: zero marking pulse (as previous versions)
- X7, pin 12: track A
- X7, pin 13: track B
- X7, pin 14: X5 monitor signal

1.1.6. Analog outputs

The two analog outputs of the board generate 0 V when disabled (in previous versions: -10V).

2. Board Design

- * One slot (1 1/3 SPS)
- * SIMADYN D local bus interface
- * Programmable address decoder with board identification
- * Three system timing controllers AM 9513
- * One analog/digital converter AD 574, 12 bits
- * One digital/analog converter AD 7549, 12 bits
- * Four analog input channels with multiplexer and A/D converter
- * Four analog input channels with V/F/D conversion
- * Two analog output channels with D/A converters.
- * One channel for the incremental shaft angle encoder consisting of the following:
 - * Three pulse inputs (2 tracks, 1 zero marking pulse), one monitor input (differential amplifier inputs, non-floating)
 - * 16 binary inputs (non-floating)
 - * 8 binary outputs (non-floating, 30 V/ 50 mA max.)
 - * 1 binary output for zero marking pulse (non-floating, 30 V/ 50 mA max.),
 - * 1 binary output for track A (non-floating, 30 V/ 50 mA max.),
 - * 1 binary output for track B (non-floating, 30 V/ 50 mA max.),
 - * 1 binary output for X5 monitor signal (non-floating, 30 V/ 50 mA max.),
- * 16 LED's on the front panel.

3. Application Notes

The EM 11 board can be used in all SIMADYN D sub-racks connected to the local bus. It requires one slot in the sub-rack.

The board must be fixed to the sub-rack with screws (even during commissioning) to ensure perfect operation.

If the board is plugged onto an adapter, the front panel (or better still one of the two metallized front panel handles) must be electrically connected to chassis via a short lead.

The pulse inputs at connector X5 are linked with the incremental shaft angle encoder of the drive via a multi-core screened cable.

The appropriate block diagram is shown in the appendix, diagram 1.

Supplementary Components at the Speed Input:

Component set

* SM1.1 6 DD 1680 - 0AB1
15 pin male connector, with casing

The analog input and output signal lines are connected via the SE7.1 interface module, which snaps onto the mounting rail. The 20 pin ribbon cable SC12 is used to inter-connect boards from connector X6 to the interface module connector X1. The cable type SC12 (twisted pair) guarantees higher transmission security.

The SE7.1 interface module provides one screw-type terminal each for signal inputs \pm , signal outputs/ground and screen for each channel.

The SE40 interface modules enable additional boards to be connected (1-to-1 connection between faston connectors and screw-type terminals).

The configuration for analog signals is shown in the appendix in diagram 2.

Supplementary components used for analog signals:

Ribbon cable

* 20 pole, twisted pair, 1.5 m SC12 6 DD 1684 - 0BC0,

* 20 pole 2.0 m SC11 6 DD 1684 - 0BB0.

Interface modules

* SE7.1 6 DD 1681 - 0AH1
I/O block, analog, 8/10 channels

* SE40 6 DD 1681 - 0EA0
terminal block, 20 pole, one to one

The binary signal lines are connected as follows:

Ribbon cables are used to link connector X7 of the EM11 board with the interface modules (both ends are provided with ribbon cable socket connectors).

The corresponding block diagram is located in the appendix, as diagram 3.

The binary outputs are supplied with power (24V) via the interface modules.
The M24 ground is simultaneously reference potential for the binary inputs and is connected to the SIMADYN D ground on the board.

Comments to diagram 3:

- to a) The 16 binary inputs and outputs at connector X7 of the EM11 are connected to the SE3.1 or SE23 interface module via a 40 pin ribbon cable. The interface modules incorporate the external connections for the plant (screw-type terminals).
- to b) The binary inputs and outputs of the connector are split up and allocated to four different SE4.1 interface modules. The 40 pin connector is divided up into four separate cables by splitting up the attached ribbon cable (4 x 10 pin, with sub-connector identification, see diagram 3) at the ends and connecting the four cable sections to the individual interface modules.
Thus it is possible e.g. to connect input or output signal lines with or without galvanic isolation.

Supplementary binary input and output components

Ribbon cable

* 40 pin	2.0 m	SC18	6DD 1684-0BJ0
* 40 pin --> 4+10 pin	2.0 m	SC13	6DD 1684-0BD0

Interface modules

- * SE3.1 6DD 1681-0AD0
16 binary inputs and 16 binary outputs, non-floating
- * SE4.1 6DD 1681-0AE1
8 binary inputs or outputs, non-floating
- * SE5.3 6DD 1681-0AF3
8 binary inputs, 220 V, floating
- * SE6.1 6DD 1681-0AG1
8 binary outputs, 220 V max., floating
- * SE8 6DD 1681-0AJ0
8 binary inputs or outputs
(10 pin, one-to-one connection)
- * SE23 6DD 1681-0CD0
16 binary inputs and 16 binary outputs
(40 pin, one-to-one connection)
- * SE37 6DD 1681-0DH0
8 binary outputs, 24 V, floating
- * SE41.1 6DD 1681-0EB1
8 binary inputs, 48 V, floating
- * SE41.2 6DD 1681-0EB2
8 binary inputs, 24 V, floating

4. Technical Specification

GENERAL

INSULATION COORDINATION	acc. to VDE 0110/1.89;contamination grade 2
AMBIENT TEMPERATURE	0 to 55 deg. C, with unforced ventilation
STORAGE TEMPERATURE	-40 to +70 deg. C
PROTECTION TYPE	IP00 acc. to DIN 40050
HUMIDITY CLASS	F to DIN 40040
ALTITUDE RATING	S to DIN 40040
MECHANICAL STRESS	Installation in stationary, equipment, sensitive to vibrations
PACKAGING SYSTEM	ES 902 C
DIMENSIONS	233.4 x 220 mm
BOARD WIDTH	1 1/3 SPS = 1 slot = 20.14 mm
WEIGHT	0.6 kg
CURRENT CONSUMPTION	P5 1.20 A P15 0.10 A + Consumption connector X5, P15' N15 0.15 A + Consumption connector X5, N15' P24 0.10 A + Consumption connector X7A, X7B

BINARY INPUTS

NUMBER	16, no galvanic isolation
INPUT VOLTAGE	+24 V rated value
FOR 0 SIGNAL	-1V to +6V; or binary inputs open
FOR 1 SIGNAL	+13 V to +33 V
INPUT CURRENT	

- AT 1 SIGNAL DELAY	5 mA (typical) 200 us
BINARY OUTPUTS	
NUMBER	12, no galvanic isolation
SUPPLY VOLTAGE	24 V - rated value
- RIPPLE	3.6 V DC
- PERM. RANGE	+20 to +30 V, including ripple
- TEMPORARY	+35 V, t < 0,5 sec.
OUTPUT CURRENT AT 1 SIGNAL	50 mA rated value
- PERM. RANGE	0.2 mA to 60 mA
SHORT-CIRCUIT PROTECTION TO GROUND	Electronic, unlimited duration
DELAY	15 us at full load 4 us at no load (measurement instrument)
INDUCTIVE CIRCUIT INTERRUPT.	Limited to -1V
TOTAL LOAD	80 % at 55 deg. C all outputs 50 mA
RESIDUAL CURRENT	20 uA at 0 signal
SIGNAL LEVEL	24 VDC rated
- AT 0 SIGNAL	3 V max.
- AT 1 SIGNAL	-2.5 V min. supply voltage

ANALOG OUTPUTS D/A CONVERSION

NUMBER	2
OUTPUT VOLTAGE (MIN.)	- 10 V
OUTPUT VOLTAGE (MAX.)	+ 10 V
OUTPUT CURRENT (MAX.)	10 mA
RESOLUTION	11 bits + sign (corresponding to 5 mV)
ACCURACY (ABSOLUTE / TYPICAL)	± 0.25 % (= ± 25 mV)
SHORT-CIRCUIT PROTECTION TO GROUND	Ohmic resistance 56 Ohm
SHORT-CIRCUIT DURATION (MAX.)	120 sec
TOTAL LOAD	All outputs simultaneously at 10 mA each

MEASURING SYSTEMS

ANALOG INPUTS WITH A/D CONVERSION

NUMBER	4
RATED INPUT VOLTAGE (MIN.)	- 10V
RATED INPUT VOLTAGE (MAX.)	+ 10V
OVERLOAD INPUT VOLTAGE (MIN.)	- 14 V (absolute value)
OVERLOAD INPUT VOLTAGE (MAX.)	+ 14 V (absolute value)
INPUT RESISTANCE	20 kohms (differential amplifier input)
RESOLUTION	11 bits + sign (corresponding to 5 mV)
ACCURACY (ABSOLUTE / TYPICAL)	± 0.25 % (= ± 25 mV)

ANALOG WITH V/F/D CONVERSION

NUMBER	4
RATED INPUT VOLTAGE (MIN.)	- 10V
RATED INPUT VOLTAGE (MAX.)	+ 10V
OVERLOAD INPUT VOLTAGE (MIN.)	- 14 V (absolute value)
OVERLOAD INPUT VOLTAGE (MAX.)	+ 14 V (absolute value)
INPUT RESISTANCE	20 kohms (differential amplifier input)
RESOLUTION	14 bits + sign (corresponding to 0.6 mV)
ACCURACY (ABSOLUTE / TYPICAL)	± 0.25 % (= ± 25 mV)

ACTUAL SPEED VALUE ACQUISITION

PULSE INPUTS TRACKS ZERO, A, B, AND MONITOR INPUT	15 V, 1 mA rated value
PULSE AMPLITUDE	8-30 V, I maximum = 3 mA
PULSE FREQUENCY (MAX.)	100 KHz sin or squarewave sampling 1:1
SIGNAL LEVEL	7,5 V rated value for threshold
1-SIGNAL	> 8 V
0-SIGNAL	< 5 V, minimum: -30V
SWITCHING HYSTERESIS	> 1 V
SMOOTHING TRACKS ZERO, A, B	1 usec
SMOOTHING MONITOR INPUT	200 usec
POWER SUPPLY	P15', M', N15', each via resistance
P15'	+15 V ± 10%, I _{max} = 250mA, R _i = 3,6Ohm
M'	0 V ± 0,2V, I _{max} = 250mA, R _i = 0,9Ohm
N15'	-15 V ± 10%, I _{max} = 250mA, R _i = 3,6Ohm
SHORT CIRCUIT PROTECTION (GRD)	Resistance (R _i)
SHORT CIRCUIT DURATION (MAX.)	1 sec., longer: R _i becomes infinite

NOTE : SPECIAL ATTENTION MUST BE PAID TO THE TOTAL LOADING OF THE SUB-RACK POWER SUPPLY WHEN THE SUPPLY OUTPUTS AT PLUG CONNECTOR X5 IS LOADED (CONCERNS P15', N15'). THIS IS ESPECIALLY IMPORTANT WHEN SEVERAL EM11 BOARDS ARE SUPPLIED FROM ONE SUB-RACK POWER SUPPLY. THE SIMADYN-D POWER SUPPLY CUTS OUT WHEN OVERLOADS OCCUR (I.E. ALSO FOR SHORT CIRCUITS).

The practical resolution of the measuring systems depends on the function blocks used.

Measuring system	Function block
A/D conversion	ADC001 : analog input
V/F/D conversion	AFC001 : analog frequency/digital conversion
D/A conversion	DAM : analog output EM 11
Actual speed value acquisition	NAV : digital actual speed value acquisition

5. Connector Pin Assignments of the EM 11

5.1. Pin Assignments for Actual Speed Value, Connector X5

Socket no.	Designation	Connector	Function
1	Screen		
2	Digital ground		Voltage reference for P15' or P5'
3	NC		Not connected
4	Zero marking pulse Z+	X5A, B	Connection for zero marking pulse
5	Track A+	X5A, B	Connection for track A
6	Track A-	X5A, B	Inverse signal or zero voltage reference for track A
7	P15'		Supply voltage for encoder +15 V
8	Digital ground		Zero voltage reference for P15' or P5'
9	Monitor +		Monitor signal
10	Monitor -		Monitor signal, reference
11	Zero marking pulse Z-	X5A,B	Inverse signal or zero voltage reference point for zero marking pulse
12	Track B+	X5A,B	Connection for track B
13	Track B-	X5A,B	Inverse signal or zero voltage reference point for track B
14	N15'		Supply voltage for encoder -15V
15	Screen		

5.2. Pin Assignments of the Analog Inputs and Outputs, Connector X6

Pin no.	Designation	Connector	Function
1	Analog input 1+	X6A	4 analog inputs with differential amplifiers and one A/D converter (multiplexed)
2	Analog input 1-		
3	Analog input 2+	X6B	
4	Analog input 2-		
5	Analog input 3+	X6C	
6	Analog input 3-		
7	Analog input 4+	X6D	
8	Analog input 4-		
9	Input (V/F) 1+	X6E	4 analog inputs with differential amplifiers V/F converters and F/D conversion
10	Input (V/F) 1-		
11	Input (V/F) 2+	X6F	
12	Input (V/F) 2-		
13	Input (V/F) 3+	X6G	
14	Input (V/F) 3-		
15	Input (V/F) 4+	X6H	
16	Input (V/F) 4-		
17	Analog output 1	X6J	D/A conv., analog signal
18	Analog ground		reference for output 1
19	Analog output 2	X6K	D/A conv., analog signal
20	Analog ground		reference for output 2

The two analog outputs can only be addressed via function block DAM.

5.3. Pin Assignments for the Binary Inputs/Outputs, Connector X7

(40 pin faston connector)

Pin no.	Designation	Connector	Function	
1	Output 1	X7 A	Binary outputs	
2	Output 2	X7 A		
3	Output 3	X7 A		
4	Output 4	X7 A		
5	Output 5	X7 A		
6	Output 6	X7 A		
7	Output 7	X7 A		
8	Output 8	X7 A		
9	P external	X7 B	External power supply for binary inputs and outputs	
10	M external		Output for zero marking pulse	
11	Output 9		Not connected	
12	Output 10			
13	Output 11			
14	Output 12			
15	N.C.		External power supply for binary inputs and outputs	
16	N.C.			
17	N.C.			
18	N.C.			
19	P external		X7 C	Binary inputs
20	M external			
21	Input 1			
22	Input 2			
23	Input 3			
24	Input 4			
25	Input 5			
26	Input 6			
27	Input 7	X7 D	External power supply for binary inputs and outputs	
28	Input 8		Binary inputs	
29	P external			
30	M external			
31	Input 9			
32	Input 10			
33	Input 11			
34	Input 12			
35	Input 13	External power supply for binary inputs and outputs		
36	Input 14			
37	Input 15			
38	Input 16			
39	P external	X7 D	External power supply for binary inputs and outputs	
40	M external			

6. STRUC-L menu

: EM11 "I/O board mixed, L-bus"
ISE 1C = N "Ignore failed message (RDYINT) (Y/N) ?"
ZPC 8K < "Zero impulse monitor register"
X5A 4K < "actual position"
X5B 4K < "digital speed"
X6A 1K < "A/D converter 1"
X6B 1K < "A/D converter 2"
X6C 1K < "A/D converter 3"
X6D 1K < "A/D converter 4"
X6E 1K < "V/F/D converter 1"
X6F 1K < "V/F/D converter 2"
X6G 1K < "V/F/D converter 3"
X6H 1K < "V/F/D converter 4"
X7C 8K < "binary inputs 1"
X7D 8K < "binary inputs 2"
X6J 1K > "D/A converter 1"
X6K 1K > "D/A converter 2"
X7A 8K > "binary outputs 1"
H10 8K > "LED block 1: H11-H18"
H20 8K > "LED block 2: H21-H28"

7. Miscellaneous

7.1. Appendices

7.1.1. Diagrams

a)

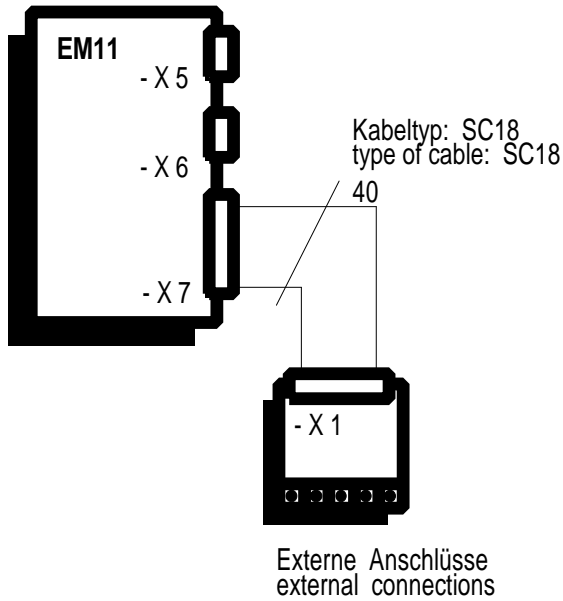

b)

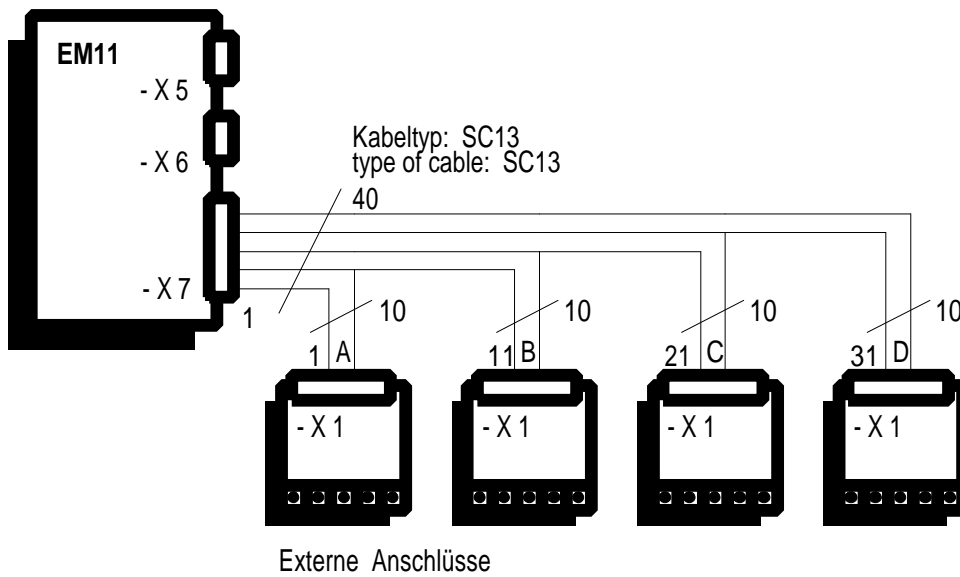

Diagram 1

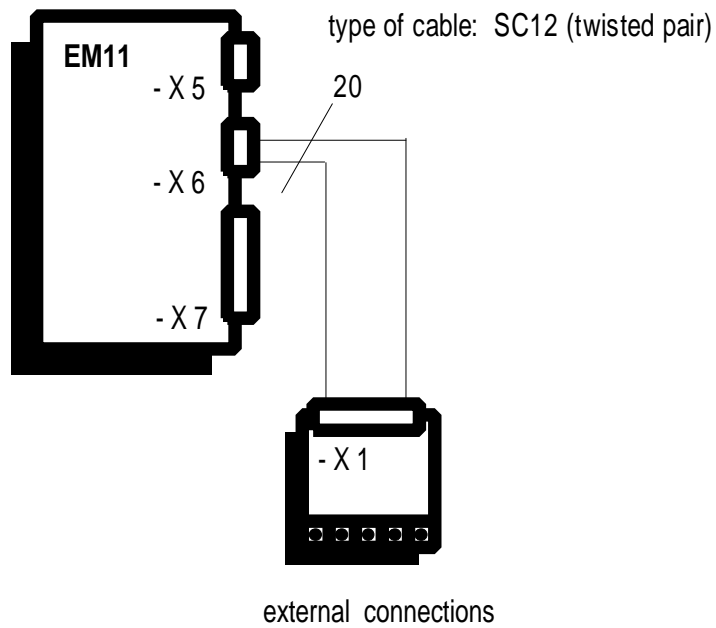

Diagram 2

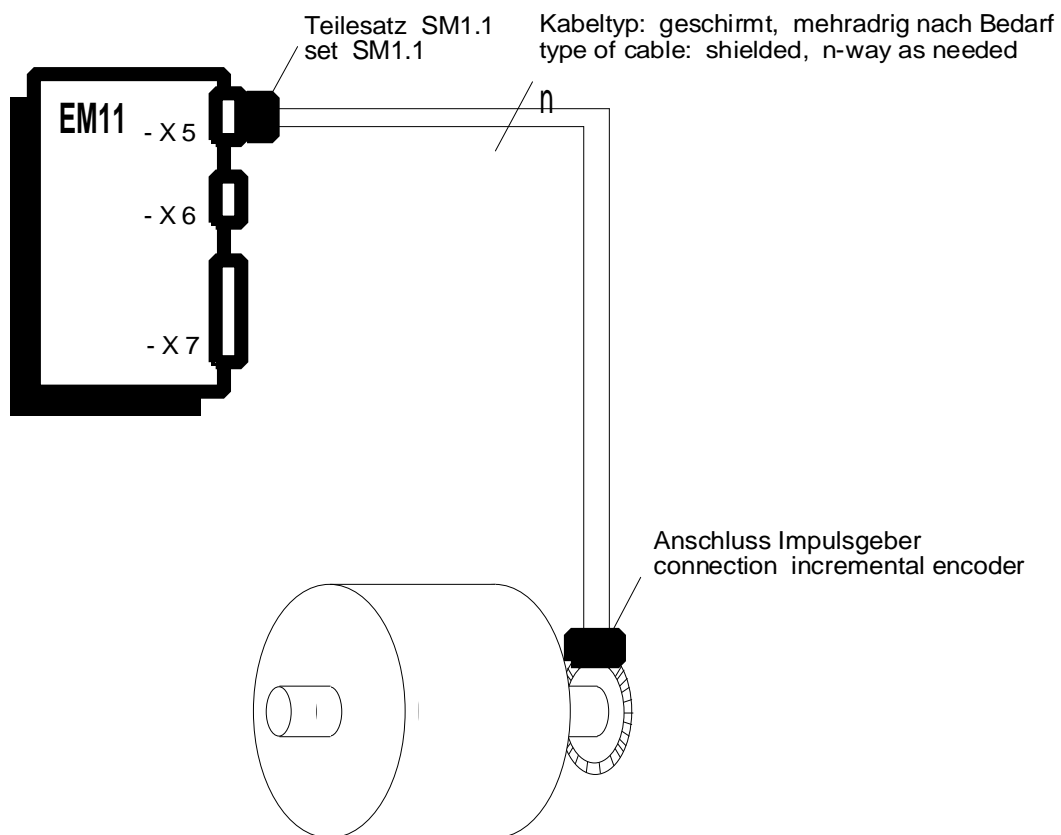

Diagram 3

7.1.2. Drawings

Block diagram

Block diagram
page 1 and 2 3GE.465.640.9002.01 SU

Dimension drawing and table of connectors

Dimension drawing showing front panel and table
of connectors used: 3GE.465.640.9002.01 MB

Location diagram

Location diagram 3GE.465.640.9002.01 AO

8. ECB instructions

Components which can be destroyed by electrostatic discharge (ECB)

Generally, electronic boards should only be touched when absolutely necessary.

The human body must be electrically discharged before touching an electronic board. This can be simply done by touching a conductive, grounded object directly beforehand (e.g. bare metal cubicle components, socket outlet protective conductor contact).

Boards must not come into contact with highly-insulating materials - e.g. plastic foils, insulated desktops, articles of clothing manufactured from man-made fibers.

Boards must only be placed on conductive surfaces.

When soldering, the soldering iron tip must be grounded.

Boards and components should only be stored and transported in conductive packaging (e.g. metalized plastic boxes, metal containers).

If the packing material is not conductive, the boards must be wrapped with a conductive packing material, e.g. conductive foam rubber or household aluminum foil.

The necessary ECB protective measures are clearly shown in the following diagram.

a = Conductive floor surface
b = ECB table
c = ECB shoes

d = ECB overall
e = ECB chain
f = Cubicle ground connection

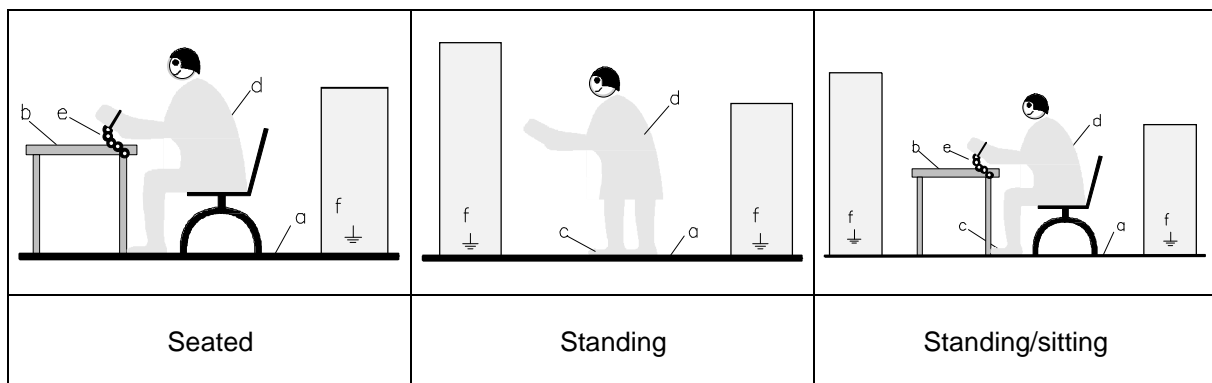

Drives and Standard Products
Motors and Drives Systems Group
Postfach 3269, D-91050 Erlangen

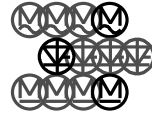

System-Based
Technology