

**SYSMAC  
CPM2A**

**Programmable Controllers**

**OPERATION MANUAL**

**OMRON**

# **CPM2A Programmable Controllers**

## **Operation Manual**

*Revised December 1999*

## Notice:

OMRON products are manufactured for use according to proper procedures by a qualified operator and only for the purposes described in this manual.

The following conventions are used to indicate and classify precautions in this manual. Always heed the information provided with them. Failure to heed precautions can result in injury to people or damage to property.

 **DANGER** Indicates an imminently hazardous situation which, if not avoided, will result in death or serious injury.

 **WARNING** Indicates a potentially hazardous situation which, if not avoided, could result in death or serious injury.

 **Caution** Indicates a potentially hazardous situation which, if not avoided, may result in minor or moderate injury, or property damage.

## OMRON Product References

All OMRON products are capitalized in this manual. The word “Unit” is also capitalized when it refers to an OMRON product, regardless of whether or not it appears in the proper name of the product.

The abbreviation “Ch,” which appears in some displays and on some OMRON products, often means “word” and is abbreviated “Wd” in documentation in this sense.

The abbreviation “PC” means Programmable Controller and is not used as an abbreviation for anything else.

## Visual Aids

The following headings appear in the left column of the manual to help you locate different types of information.

**Note** Indicates information of particular interest for efficient and convenient operation of the product.

**1, 2, 3...** 1. Indicates lists of one sort or another, such as procedures, checklists, etc.

## © OMRON, 1999

All rights reserved. No part of this publication may be reproduced, stored in a retrieval system, or transmitted, in any form, or by any means, mechanical, electronic, photocopying, recording, or otherwise, without the prior written permission of OMRON.

No patent liability is assumed with respect to the use of the information contained herein. Moreover, because OMRON is constantly striving to improve its high-quality products, the information contained in this manual is subject to change without notice. Every precaution has been taken in the preparation of this manual. Nevertheless, OMRON assumes no responsibility for errors or omissions. Neither is any liability assumed for damages resulting from the use of the information contained in this publication.

# TABLE OF CONTENTS

<b>PRECAUTIONS</b> .....	<b>xi</b>
1 Intended Audience .....	xii
2 General Precautions .....	xii
3 Safety Precautions .....	xii
4 Operating Environment Precautions .....	xiii
5 Application Precautions .....	xiii
6 EC Directives .....	xv
<b>SECTION 1</b>	
<b>Introduction</b> .....	<b>1</b>
1-1 CPM2A Features and Functions .....	2
1-2 Basic System Configurations .....	8
1-3 Structure and Operation .....	10
1-4 Functions Listed by Usage .....	16
1-5 Comparison with the CPM1A .....	18
1-6 Preparation for Operation .....	24
<b>SECTION 2</b>	
<b>Unit Specifications and Components</b> .....	<b>27</b>
2-1 Specifications .....	28
2-2 Unit Components .....	35
<b>SECTION 3</b>	
<b>Installation and Wiring</b> .....	<b>43</b>
3-1 Design Precautions .....	44
3-2 Selecting an Installation Site .....	44
3-3 Installing the CPM2A .....	46
3-4 Wiring and Connections .....	49
<b>SECTION 4</b>	
<b>Using Programming Devices</b> .....	<b>83</b>
4-1 SYSMAC-CPT Support Software .....	84
4-2 SYSMAC Support Software (SSS) .....	92
4-3 Using a Programming Console .....	95
4-4 Programming Console Operations .....	101
4-5 Programming Example .....	124
<b>SECTION 5</b>	
<b>Test Runs and Error Processing</b> .....	<b>131</b>
5-1 Initial System Checks and Test Run Procedure .....	132
5-2 Self-diagnostic Functions .....	133
5-3 Programming Console Operation Errors .....	136
5-4 Programming Errors .....	136
5-5 Troubleshooting Flowcharts .....	137
5-6 Maintenance Inspections .....	145
5-7 Battery Replacement .....	146
<b>SECTION 6</b>	
<b>Expansion Memory Unit</b> .....	<b>149</b>
6-1 Overview .....	150
6-2 Specifications and Nomenclature .....	151
6-3 Handling .....	152

# TABLE OF CONTENTS

## Appendices

A Standard Models .....	159
B Dimensions .....	163

<b>Index .....</b>	<b>171</b>
--------------------	------------

<b>Revision History .....</b>	<b>175</b>
-------------------------------	------------

## About this Manual:

The CPM2A is a compact, high-speed Programmable Controller (PC) designed for control operations in systems requiring from 10 to 120 I/O points per PC. There are two manuals describing the setup and operation of the CPM2A: The *CPM2A Operation Manual* (this manual) and the *CPM1/CPM1A/CPM2A/CPM2C/SRM1(-V2) Programming Manual* (W353). (The *CPM1/CPM1A/CPM2A/CPM2C/SRM1(-V2) Programming Manual* is referred to as simply the *Programming Manual* in this manual.)

This manual describes the system configuration and installation of the CPM2A and provides a basic explanation of operating procedures for the Programming Consoles. It also introduces the capabilities of the SYSMAC Support Software (SSS) and SYSMAC-CPT Support Software. Read this manual first to acquaint yourself with the CPM2A.

The *Programming Manual* (W353) provides detailed descriptions of the CPM2A's programming functions. The *SYSMAC Support Software Operation Manuals: Basics and C-series PCs* (W247 and W248) provide descriptions of SSS operations for the CPM2A and other SYSMAC C-series PCs. The *SYSMAC-CPT Support Software Quick Start Guide* (W332) and *User Manual* (W333) provide descriptions of ladder diagram operations in the Windows environment. The *WS02-CXPC1-E CX-Programmer User Manual* (W361) and the *CX-Server User Manual* (W362) provide details of operations for the WS02-CXPC1-E CX-Programmer.

Please read this manual carefully and be sure you understand the information provided before attempting to install and operate the CPM2A.

**Section 1** gives a brief overview of the steps involved in developing of a CPM2A System, describes the possible system configurations, and describes the CPM2A's special features and functions.

**Section 2** provides the technical specifications of the Units that go together to create a CPM2A PC and describes the main components of the Units.

**Section 3** describes how to install and wire a CPM2A PC.

**Section 4** describes SYSMAC and SYSMAC-CPT Support Software capabilities, how to connect the Programming Console, and how to perform the various programming operations.

**Section 5** describes how to perform a test run and how to diagnose and correct the hardware and software errors that can occur during PC operation.

**Section 6** describes how to use the CPM1-EMU01-V1 Expansion Memory Unit. Follow the handling precautions and procedures to properly use the Unit.

**Appendix A** provides tables of CPM2A Units and related products.

**Appendix B** provides the dimensions of CPM2A Units.



**WARNING** Failure to read and understand the information provided in this manual may result in personal injury or death, damage to the product, or product failure. Please read each section in its entirety and be sure you understand the information provided in the section and related sections before attempting any of the procedures or operations given.

# PRECAUTIONS

This section provides general precautions for using the Programmable Controller (PC) and related devices.

**The information contained in this section is important for the safe and reliable application of the Programmable Controller. You must read this section and understand the information contained before attempting to set up or operate a PC system.**

1 Intended Audience .....	xii
2 General Precautions .....	xii
3 Safety Precautions .....	xii
4 Operating Environment Precautions .....	xiii
5 Application Precautions .....	xiii
6 EC Directives .....	xv

## 1 Intended Audience

This manual is intended for the following personnel, who must also have knowledge of electrical systems (an electrical engineer or the equivalent).

- Personnel in charge of installing FA systems.
- Personnel in charge of designing FA systems.
- Personnel in charge of managing FA systems and facilities.

## 2 General Precautions

The user must operate the product according to the performance specifications described in the operation manuals.

Before using the product under conditions which are not described in the manual or applying the product to nuclear control systems, railroad systems, aviation systems, vehicles, combustion systems, medical equipment, amusement machines, safety equipment, and other systems, machines, and equipment that may have a serious influence on lives and property if used improperly, consult your OMRON representative.

Make sure that the ratings and performance characteristics of the product are sufficient for the systems, machines, and equipment, and be sure to provide the systems, machines, and equipment with double safety mechanisms.

This manual provides information for programming and operating the Unit. Be sure to read this manual before attempting to use the Unit and keep this manual close at hand for reference during operation.

 **WARNING** It is extremely important that a PC and all PC Units be used for the specified purpose and under the specified conditions, especially in applications that can directly or indirectly affect human life. You must consult with your OMRON representative before applying a PC System to the above-mentioned applications.

## 3 Safety Precautions

 **WARNING** Do not attempt to take any Unit apart while the power is being supplied. Doing so may result in electric shock.

 **WARNING** Do not touch any of the terminals or terminal blocks while the power is being supplied. Doing so may result in electric shock.

 **WARNING** Do not attempt to disassemble, repair, or modify any Units. Any attempt to do so may result in malfunction, fire, or electric shock.

 **WARNING** Provide safety measures in external circuits (i.e., not in the Programmable Controller), including the following items, in order to ensure safety in the system if an abnormality occurs due to malfunction of the PC or another external factor affecting the PC operation. Not doing so may result in serious accidents.

- Emergency stop circuits, interlock circuits, limit circuits, and similar safety measures must be provided in external control circuits.
- The PC will turn OFF all outputs when its self-diagnosis function detects any error or when a severe failure alarm (FALS) instruction is executed. As a countermeasure for such errors, external safety measures must be provided to ensure safety in the system.



- The PC outputs may remain ON or OFF due to deposition or burning of the output relays or destruction of the output transistors. As a countermeasure for such problems, external safety measures must be provided to ensure safety in the system.
- When the 24-VDC output (service power supply to the PC) is overloaded or short-circuited, the voltage may drop and result in the outputs being turned OFF. As a countermeasure for such problems, external safety measures must be provided to ensure safety in the system.

 **WARNING** When transferring programs to other nodes, or when making changes to I/O memory, confirm the safety of the destination node before transfer. Not doing so may result in injury.

 **Caution** Execute online edit only after confirming that no adverse effects will be caused by extending the cycle time. Otherwise, the input signals may not be readable.

 **Caution** Tighten the screws on the terminal block of the AC Power Supply Unit to the torque specified in the operation manual. The loose screws may result in burning or malfunction.

## 4 Operating Environment Precautions

 **Caution** Do not operate the control system in the following places:

- Locations subject to direct sunlight.
- Locations subject to temperatures or humidity outside the range specified in the specifications.
- Locations subject to condensation as the result of severe changes in temperature.
- Locations subject to corrosive or flammable gases.
- Locations subject to dust (especially iron dust) or salts.
- Locations subject to exposure to water, oil, or chemicals.
- Locations subject to shock or vibration.

 **Caution** Take appropriate and sufficient countermeasures when installing systems in the following locations:

- Locations subject to static electricity or other forms of noise.
- Locations subject to strong electromagnetic fields.
- Locations subject to possible exposure to radioactivity.
- Locations close to power supplies.

 **Caution** The operating environment of the PC System can have a large effect on the longevity and reliability of the system. Improper operating environments can lead to malfunction, failure, and other unforeseeable problems with the PC System. Be sure that the operating environment is within the specified conditions at installation and remains within the specified conditions during the life of the system.

## 5 Application Precautions

Observe the following precautions when using the PC System.

 **WARNING** Always heed these precautions. Failure to abide by the following precautions could lead to serious or possibly fatal injury.

- Always connect to a ground such that the grounding resistance does not exceed 100  $\Omega$  when installing the Units. Not connecting to the correct ground may result in electric shock.

- Always turn OFF the power supply to the PC before attempting any of the following. Not turning OFF the power supply may result in malfunction or electric shock.
  - Mounting or dismounting I/O Units, CPU Units, Memory Cassettes, or any other Units.
  - Assembling the Units.
  - Setting DIP switches or rotary switches.
  - Connecting or wiring the cables.
  - Connecting or disconnecting the connectors.

**Caution**

Failure to abide by the following precautions could lead to faulty operation of the PC or the system, or could damage the PC or PC Units. Always heed these precautions.

- Fail-safe measures must be taken by the customer to ensure safety in the event of incorrect, missing, or abnormal signals caused by broken signal lines, momentary power interruptions, or other causes.
- Construct a control circuit so that power supply for the I/O circuits does not come ON before power supply for the Unit. If power supply for the I/O circuits comes ON before power supply for the Unit, normal operation may be temporarily interrupted.
- If the operating mode is changed from RUN or MONITOR mode to PROGRAM mode, with the IOM Hold Bit ON, the output will hold the most recent status. In such a case, ensure that the external load does not exceed specifications. (If operation is stopped because of an operation error (including FALS instructions), the values in the internal memory of the CPU Unit will be saved, but the outputs will all turn OFF.)
- Always use the power supply voltage specified in the operation manuals. An incorrect voltage may result in malfunction or burning.
- Take appropriate measures to ensure that the specified power with the rated voltage and frequency is supplied. Be particularly careful in places where the power supply is unstable. An incorrect power supply may result in malfunction.
- Install external breakers and take other safety measures against short-circuiting in external wiring. Insufficient safety measures against short-circuiting may result in burning.
- Do not apply voltages to the input terminals in excess of the rated input voltage. Excess voltages may result in burning.
- Do not apply voltages or connect loads to the output terminals in excess of the maximum switching capacity. Excess voltage or loads may result in burning.
- Disconnect the functional ground terminal when performing withstand voltage tests. Not disconnecting the functional ground terminal may result in burning.
- Install the Unit properly as specified in the operation manual. Improper installation of the Unit may result in malfunction.
- Be sure that all the mounting screws, terminal screws, and cable connector screws are tightened to the torque specified in the relevant manuals. Incorrect tightening torque may result in malfunction.
- Be sure to leave the labels attached at the time of shipment on the CPM1 or CPM2A when wiring in order to prevent wiring cuttings from entering the Unit.
- Remove the label after the completion of wiring to ensure proper heat dissipation. Leaving the label attached may result in malfunction.
- Be sure to perform wiring in accordance with the relevant operation manual. Incorrect wiring may result in burning.
- Use crimp terminals for wiring. Do not connect bare stranded wires directly to terminals. Connection of bare stranded wires may result in burning.

- Double-check all the wiring before turning ON the power supply. Incorrect wiring may result in burning.
- Be sure that the terminal blocks, Memory Units, expansion cables, and other items with locking devices are properly locked into place. Improper locking may result in malfunction.
- Be sure that terminal blocks and connectors are connected in the specified direction with the correct polarity. Not doing so may result in malfunction.
- Check the user program for proper execution before actually running it on the Unit. Not checking the program may result in an unexpected operation.
- Confirm that no adverse effect will occur in the system before attempting any of the following. Not doing so may result in an unexpected operation.
  - Changing the operating mode of the PC.
  - Force-setting/force-resetting any bit in memory.
  - Changing the present value of any word or any set value in memory.
- Resume operation only after transferring to the new CPU Unit the contents of the DM and HR Areas required for resuming operation. Not doing so may result in an unexpected operation.
- Do not pull on the cables or bend the cables beyond their natural limit. Doing either of these may break the cables.
- Do not place objects on top of the cables. Doing so may break the cables.
- Under no circumstances should batteries be short-circuited between positive (+) and negative (–) terminals, charged, disassembled, heated, or thrown into fire.
- When replacing parts, be sure to confirm that the rating of a new part is correct. Not doing so may result in malfunction or burning.
- Before touching the Unit, be sure to first touch a grounded metallic object in order to discharge any static build-up. Not doing so may result in malfunction or damage.
- Do not touch the expansion I/O connecting cable while the power is being supplied in order to prevent any malfunction due to static electricity.
- When using a thermocouple-input type Temperature Sensor Unit, observe the following precautions:
  - Do not remove the cold junction compensator attached at the time of delivery. If the cold junction compensator is removed the Unit will not be able to measure temperatures correctly.
  - Each of the input circuits is calibrated with the cold junction compensator attached to the Unit. If the Unit is used with the cold junction compensator from other Units, the Unit will not be able to measure temperatures correctly.
  - Do not touch the cold junction compensator. Doing so may result in incorrect temperature measurement.

## 6 EC Directives

### 6-1 Applicable Directives

- EMC Directives
- Low Voltage Directive

### 6-2 Concepts

#### EMC Directives

OMRON devices that comply with EC Directives also conform to the related

EMC standards so that they can be more easily built into other devices or the overall machine. The actual products have been checked for conformity to EMC standards (see the following note). Whether the products conform to the standards in the system used by the customer, however, must be checked by the customer.

EMC-related performance of the OMRON devices that comply with EC Directives will vary depending on the configuration, wiring, and other conditions of the equipment or control panel on which the OMRON devices are installed. The customer must, therefore, perform the final check to confirm that devices and the overall machine conform to EMC standards.

**Note** Applicable EMC (Electromagnetic Compatibility) standards are as follows:

EMS (Electromagnetic Susceptibility): EN61131-2  
EMI (Electromagnetic Interference): EN50081-2  
(Radiated emission: 10-m regulations)

#### **Low Voltage Directive**

Always ensure that devices operating at voltages of 50 to 1,000 VAC and 75 to 1,500 VDC meet the required safety standards for the PC (EN61131-2).

### **6-3 Conformance to EC Directives**

The CPM2A PCs comply with EC Directives. To ensure that the machine or device in which the CPM2A PC is used complies with EC directives, the PC must be installed as follows:

- 1, 2, 3...** 1. The CPM2A PC must be installed within a control panel.
2. Reinforced insulation or double insulation must be used for the DC power supplies used for the communications and I/O power supplies.
3. CPM2A PCs complying with EC Directives also conform to the Common Emission Standard (EN50081-2). Radiated emission characteristics (10-m regulations) may vary depending on the configuration of the control panel used, other devices connected to the control panel, wiring, and other conditions. You must therefore confirm that the overall machine or equipment complies with EC Directives.

### **6-4 Relay Output Noise Reduction Methods**

The CPM2A PCs conform to the Common Emission Standards (EN50081-2) of the EMC Directives. However, the noise generated when the PC is switched ON or OFF using the relay output may not satisfy these standards. In such a case, a noise filter must be connected to the load side or other appropriate countermeasures must be provided external to the PC.

Countermeasures taken to satisfy the standards vary depending on the devices on the load side, wiring, configuration of machines, etc. Following are examples of countermeasures for reducing the generated noise.

#### **Countermeasures**

(Refer to EN50081-2 for more details.)

Countermeasures are not required if the frequency of load switching for the whole system with the PC included is less than 5 times per minute.

Countermeasures are required if the frequency of load switching for the whole system with the PC included is 5 times or more per minute.

**Countermeasure Examples**

When switching an inductive load, connect a surge protector, diodes, etc., in parallel with the load or contact as shown below.

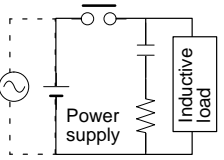
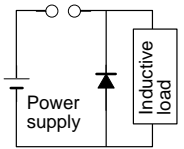
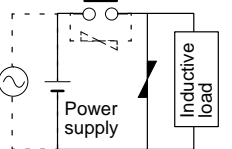
Circuit	Current		Characteristic	Required element
	AC	DC		
<p>CR method</p> 	Yes	Yes	<p>If the load is a relay or solenoid, there is a time lag between the moment the circuit is opened and the moment the load is reset.</p> <p>If the supply voltage is 24 to 48 V, insert the surge protector in parallel with the load. If the supply voltage is 100 to 200 V, insert the surge protector between the contacts.</p>	<p>The capacitance of the capacitor must be 1 to 0.5 <math>\mu\text{F}</math> per contact current of 1 A and resistance of the resistor must be 0.5 to 1 <math>\Omega</math> per contact voltage of 1 V. These values, however, vary with the load and the characteristics of the relay. Decide these values from experiments, and take into consideration that the capacitance suppresses spark discharge when the contacts are separated and the resistance limits the current that flows into the load when the circuit is closed again.</p> <p>The dielectric strength of the capacitor must be 200 to 300 V. If the circuit is an AC circuit, use a capacitor with no polarity.</p>
<p>Diode method</p> 	No	Yes	<p>The diode connected in parallel with the load changes energy accumulated by the coil into a current, which then flows into the coil so that the current will be converted into Joule heat by the resistance of the inductive load.</p> <p>This time lag, between the moment the circuit is opened and the moment the load is reset, caused by this method is longer than that caused by the CR method.</p>	<p>The reversed dielectric strength value of the diode must be at least 10 times as large as the circuit voltage value. The forward current of the diode must be the same as or larger than the load current.</p> <p>The reversed dielectric strength value of the diode may be two to three times larger than the supply voltage if the surge protector is applied to electronic circuits with low circuit voltages.</p>
<p>Varistor method</p> 	Yes	Yes	<p>The varistor method prevents the imposition of high voltage between the contacts by using the constant voltage characteristic of the varistor. There is time lag between the moment the circuit is opened and the moment the load is reset.</p> <p>If the supply voltage is 24 to 48 V, insert the varistor in parallel with the load. If the supply voltage is 100 to 200 V, insert the varistor between the contacts.</p>	---

## 6-5 CPM1A-MAD01 Conformance to EMC Directives

Immunity testing conditions when using the current I/O of the CPM1A-MAD01 are as follows.

- Total accuracy: +10%/-1%
- Insert the following core in each line as shown below.

Recommended core: 2643-002402

Manufacturer: Fair Rite Products Corp.

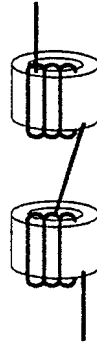

# SECTION 1

## Introduction

This section describes the CPM2A's special features and functions, shows the possible system configurations, and outlines the steps required before operation. Read this section first when using the CPM2A for the first time.

Refer to the *CPM1/CPM1A/CPM2A/CPM2C/SRM1(-V2) Programming Manual (W353)* for details on programming operation.

1-1	CPM2A Features and Functions .....	2
1-1-1	CPM2A Features .....	2
1-1-2	Overview of CPM2A Functions .....	7
1-2	Basic System Configurations .....	8
1-2-1	Stand-alone CPU Unit .....	8
1-2-2	CPU Unit, Expansion Units, and Expansion I/O Units .....	8
1-3	Structure and Operation .....	10
1-3-1	CPU Unit Structure .....	10
1-3-2	Operating Modes .....	11
1-3-3	Operating Mode at Startup .....	11
1-3-4	PC Operation at Startup .....	12
1-3-5	Cyclic Operation and Interrupts .....	13
1-4	Functions Listed by Usage .....	16
1-5	Comparison with the CPM1A .....	18
1-6	Preparation for Operation .....	24

# 1-1 CPM2A Features and Functions

## 1-1-1 CPM2A Features

The CPM2A PCs incorporate a variety of features in a compact Unit, including synchronized pulse control, interrupt inputs, pulse outputs, analog settings, and a clock function. Also, the CPM2A CPU Unit is a stand-alone Unit that can handle a broad range of machine control applications, so it is ideal for use as a built-in control unit in equipment.

The full complement of communications functions provide communications with personal computers, other OMRON PCs, and OMRON Programmable Terminals. These communications capabilities allow the user to design a low-cost distributed production system.

The CPU Unit contains 20, 30, 40, or 60 I/O points and Expansion I/O Units can be added to provide a total I/O capacity of up to 120 I/O points. Analog I/O Units, Temperature Sensor Units, and CompoBus/S I/O Link Units can also be connected.

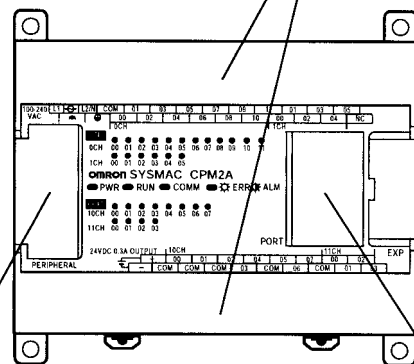

**Peripheral Port**  
Programming Devices are compatible with other models of OMRON PCs. This port can also be used for Host Link or no-protocol communications.

**RS-232C Port**  
This port can be used for a Host Link, no-protocol, 1:1 PC Link, or 1:1 NT Link communications.

### Basic Functions

#### CPU Unit Variations

The CPM2A PCs are one-piece PCs with 20, 30, 40, or 60 built-in I/O terminals. There are 3 types of outputs available (relay outputs, sinking transistor outputs, and sourcing transistor outputs) and 2 types of power supplies available (100/240 VAC or 24 VDC).

#### Expansion I/O Units

Up to 3 Expansion I/O Units can be connected to the CPU Unit to increase the PC's I/O capacity to a maximum of 120 I/O points. There are 3 types of Expansion I/O Units available: a 20-point I/O Unit, an 8-point Input Unit, and an 8-point Output Unit. The maximum I/O capacity of 120 I/O points is achieved by connecting three 20-point I/O Units to a CPU Unit with 60 built-in I/O terminals.

#### Analog I/O Units

Up to 3 Analog I/O Units can be connected to provide analog inputs and outputs. Each Unit provides 2 analog inputs and 1 analog output, so a maximum of 6 analog inputs and 3 analog outputs can be achieved by connecting 3 Analog I/O Units. (Time-proportional control can be performed by combining the analog I/O points with the PID(—) and PWM(—) instructions.)

- The analog input range can be set to 0 to 10 VDC, 1 to 5 VDC, or 4 to 20 mA with a resolution of 1/256. (The open-circuit detection function can be used with the 1 to 5 VDC and 4 to 20 mA settings.)
- The analog output range can be set to 0 to 10 VDC, -10 to 10 VDC, or 4 to 20 mA with a resolution of 1/256.

#### Temperature Sensor Units

A Temperature Sensor Unit can be connected to provide up to 6 inputs for temperature input from sensors, such as thermocouples or platinum resistance



**CompoBus/S I/O Link Units**

thermometers. The PID(—) instruction can be used with a Temperature Sensor Unit for easy temperature monitoring.

CompoBus/S I/O Link Units can be connected to make the CPM2A a Slave Device in a CompoBus/S Network. The I/O Link Unit has 8 input bits (internal) and 8 output bits (internal).

The CompoBus/S Network provides distributed CPU control based on a “PC + compact PC” configuration, which is an improvement on the earlier distributed I/O control based on a “PC + remote I/O” configuration. The distributed CPU control makes equipment modular, so designs can be standardized, special needs can be addressed, and modules can be replaced easily in the event of a breakdown.

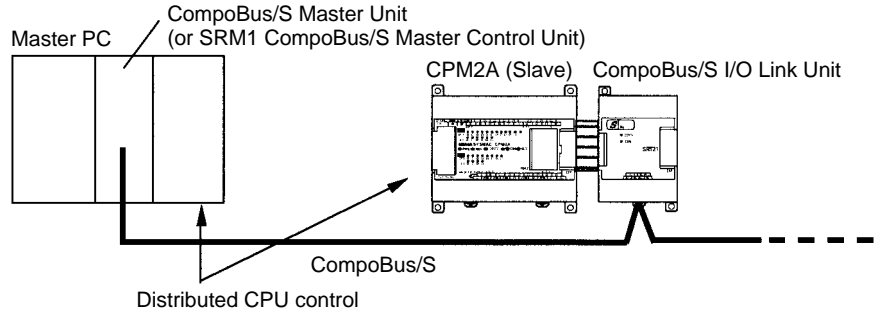

**Share Programming Devices**

The same Programming Devices, such as Programming Consoles and Support Software, can be used for the C200H, C200HS, C200HX/HG/HE, CQM1, CPM1, CPM1A, CPM2C, and SRM1 (-V2) PCs, so existing ladder program resources can be used effectively.

**Built-in Motor Control Capability**

**Synchronized Pulse Control (Transistor Outputs Only)**

Synchronized pulse control provides an easy way to synchronize the operation of a peripheral piece of equipment with the main equipment. The output pulse frequency can be controlled as some multiple of the input pulse frequency, allowing the speed of a peripheral piece of equipment (such as a supply conveyor) to be synchronized with the speed of the main piece of equipment.

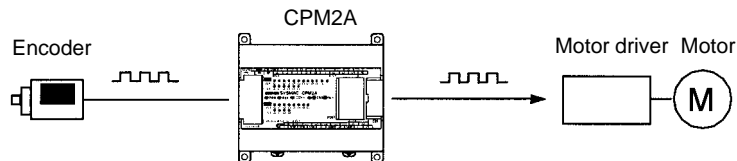

Pulses are output as a fixed multiple of the input frequency.

**High-speed Counters and Interrupts**

The CPM2A has a total of five high-speed counter inputs. The one high-speed counter input has a response frequency of 20 kHz/5 kHz and the four interrupt inputs (in counter mode) have a response frequency of 2 kHz.

The high-speed counter can be used in any one of the four input modes: differential phase mode (5 kHz), pulse plus direction input mode (20 kHz), up/down pulse mode (20 kHz), or increment mode (20 kHz). Interrupts can be triggered when the count matches a set value or falls within a specified range.

The interrupt inputs (counter mode) can be used for incrementing counters or decrementing counters (2 kHz) and trigger an interrupt (executing the interrupt program) when the count matches the target value.

**Easy Position Control with Pulse Outputs (Transistor Outputs Only)**

CPM2A PCs with transistor outputs have two outputs that can produce 10 Hz to 10 kHz pulses (single-phase outputs).

When used as single-phase pulse outputs, there can be two outputs with a frequency range of 10 Hz to 10 kHz with a fixed duty ratio or 0.1 to 999.9 Hz with a variable duty ratio (0 to 100% duty ratio).

When used as pulse plus direction or up/down pulse outputs, there can be just one output with a frequency range of 10 Hz to 10 kHz.

### **High-speed Input Capabilities for Machine Control**

<b>High-speed Interrupt Input Function</b>	There are four inputs used for interrupt inputs (shared with quick-response inputs and interrupt inputs in counter mode) with a minimum input signal width of 50 $\mu$ s and response time of 0.3 ms. When an interrupt input goes ON, the main program is stopped and the interrupt program is executed.
<b>Quick-response Input Function</b>	There are four inputs used for quick-response inputs (shared with interrupt inputs and interrupt inputs in counter mode) that can reliably read input signals with a signal width as short as 50 $\mu$ s.
<b>Stabilizing Input Filter Function</b>	The input time constant for all inputs can be set to 1 ms, 2 ms, 3 ms, 5 ms, 10 ms, 20 ms, 40 ms, or 80 ms. The effects of chattering and external noise can be reduced by increasing the input time constant.

### **Other Functions**

<b>Interval Timer Interrupts</b>	The interval timer can be set between 0.5 and 319,968 ms and can be set to generate just one interrupt (one-shot mode) or periodic interrupts (scheduled interrupt mode).
<b>Analog Settings</b>	There are two controls on the CPU Unit that can be turned to change the analog settings (0 to 200 BCD) in IR 250 and IR 251. These controls can be used to easily change or fine-tune machine settings such as a conveyor belt's pause time or feed rate.
<b>Calendar/Clock</b>	The built-in clock (accuracy within 1 minute/month) can be read from the program to show the current year, month, day, day of the week, and time. The clock can be set from a Programming Device (such as a Programming Console) or the time can be adjusted by rounding up or down to the nearest minute.
<b>Long-term Timer</b>	TIML(—) is a long-term timer that accommodates set values up to 99,990 seconds (27 hours, 46 minutes, 30 seconds). When combined with the SECONDS TO HOURS conversion instruction (HMS(—)), the long-term timer provides an easy way to control equipment scheduling.
<b>Analog PID Control</b>	The PID(—) instruction can be used with an Analog I/O Unit to control analog I/O.

### **Complete Communications Capabilities**

<b>Host Link</b>	A Host Link connection can be made through the PC's RS-232C port or Peripheral port. A personal computer or Programmable Terminal connected in Host
------------------	---

Link mode can be used for operations such as reading/writing data in the PC's I/O memory or reading/changing the PC's operating mode.

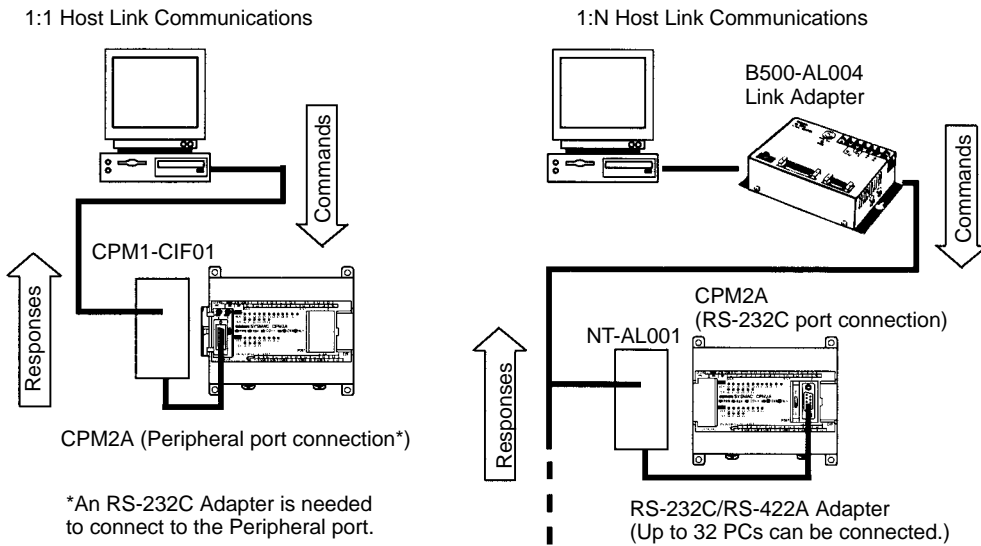

**No-protocol Communications**

The TXD(48) and RXD(47) instructions can be used in no-protocol mode to exchange data with standard serial devices. For example, data can be received from a bar code reader or transmitted to a serial printer. The serial devices can be connected to the RS-232C port or Peripheral port.

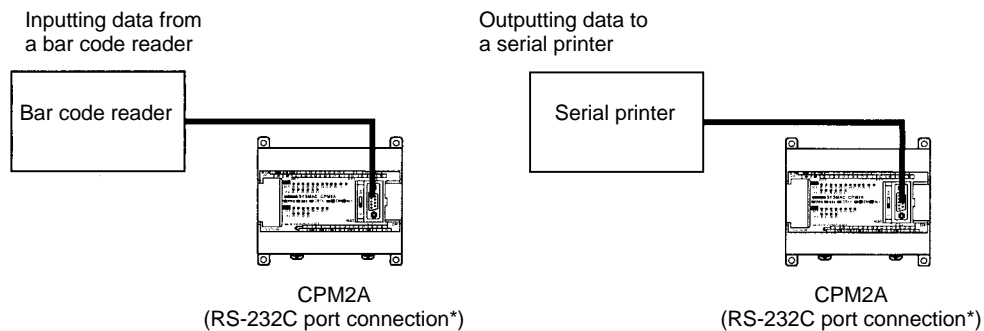

\*An RS-232C Adapter is needed to connect to the Peripheral port.

**High-speed 1:1 NT Link Communications**

In a 1:1 NT Link, an OMRON Programmable Terminal (PT) can be connected directly to the CPM2A. The PT must be connected to the RS-232C port; it cannot be connected to the Peripheral port.

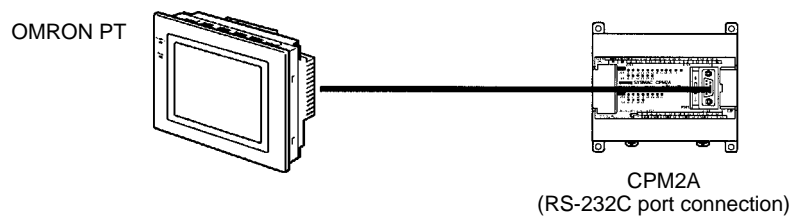

**One-to-one PC Link**

A CPM2A can be linked directly to another CPM2A, CQM1, CPM1, CPM1A, CPM2C, SRM1(-V2), or a C200HS or C200HX/HG/HE PC. The 1:1 PC Link al-

allows automatic data link connections. The PC must be connected through the RS-232C port; it cannot be connected through the Peripheral port.

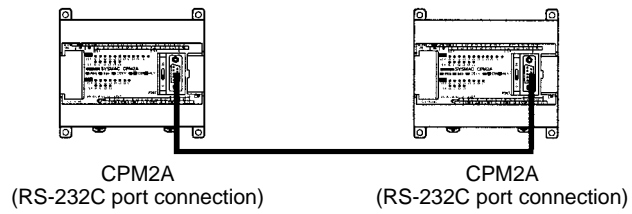

**Expansion Memory Unit**

The CPM1-EMU01-V1 Expansion Memory Unit is a program loader for small-size or micro PLCs. Using the CPM1-EMU01-V1, simple on-site transfer of user programs and data memory is possible with PLCs.

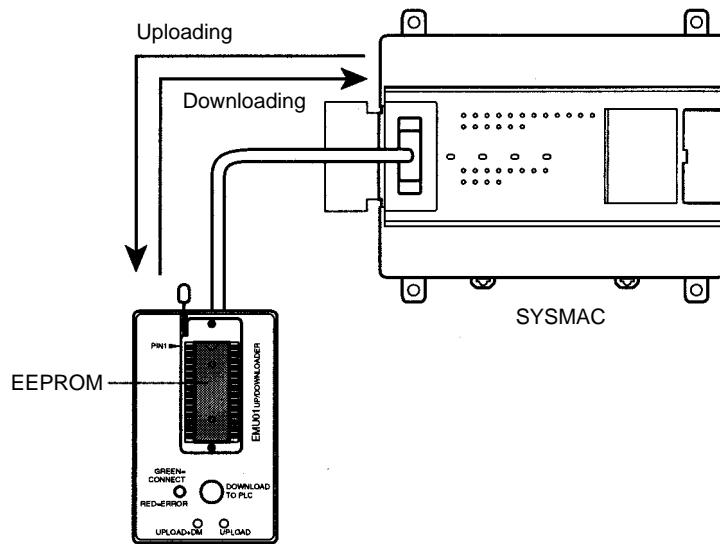

## 1-1-2 Overview of CPM2A Functions

Main function	Variations/Details	
Interrupts	Interrupt inputs 4 inputs, see note 1. Response time: 0.3 ms	
	Interval timer interrupts 1 input Set value: 0.5 to 319,968 ms Precision: 0.1 ms	Scheduled interrupts
		One-shot interrupt
High-speed counters	High-speed counter 1 input, see note 2. Differential phase mode (5 kHz) Pulse plus direction input mode (20 kHz) Up/down input mode (20 kHz) Increment mode (20 kHz)	
		No interrupt
		Count-check interrupt (An interrupt can be generated when the count equals the set value or the count lies within a preset range.)
	Interrupt inputs (counter mode) 4 inputs, see note 1. Incrementing counter (2 kHz) Decrementing counter (2 kHz)	No interrupt
	Count-up interrupt	
Pulse outputs	2 outputs: Single-phase pulse output without acceleration/deceleration (See note 3.) 10 Hz to 10 kHz 2 outputs: Variable duty ratio pulse output (See note 3.) 0.1 to 999.9 Hz, duty ratio 0 to 100% 1 output: Pulse output with trapezoidal acceleration/deceleration (See note 3.) Pulse plus direction output, up/down pulse output, 10 Hz to 10 kHz	
Synchronized pulse control	1 point, see notes 2 and 3. Input frequency range: 10 to 500 Hz, 20 Hz to 1 kHz, or 300 Hz to 20 kHz Output frequency range: 10 Hz to 10 kHz	
Quick-response input	4 inputs, see note 1. Minimum input signal width: 50 $\mu$ s	
Analog settings	2 controls (setting ranges: 0 to 200 BCD)	
Input time constant	Determines the input time constant for all inputs. (Settings: 1, 2, 3, 5, 10, 20, 40, or 80 ms)	
Calendar/Clock	Shows the current year, month, day of the week, day of the month, hour, minute, and second.	
Expansion Unit functions	Analog I/O Unit functions (CPM1A-MAD01) Two analog inputs: input range 0 to 10 V, 1 to 5 V, or 4 to 20 mA One analog output: output range 0 to 10 V, -10 to 10 V, or 4 to 20 mA	
	Temperature Sensor Unit functions Thermocouple input (CPM1A-TS001/002; 2/4 input points): K: -200° to 1,300°C (-300° to 2,300°F) 0.0° to 500.0°C (0.0° to 900.0°F) J: -100° to 850°C (-100° to 1,500°F) 0.0° to 400.0°C (0.0° to 750.0°F) Platinum resistance thermometer input (CPM1A-TS101/102; 2/4 input points): Pt100: -200.0° to 650.0°C (-300.0° to 1,200.0°F) JPt100: -200.0° to 650.0°C (-300.0° to 1,200.0°F)	
	CompoBus/S Slave functions (CPM1A-SRT21)	
	Exchanges 8 input bits and 8 output bits of data with the Master Unit.	

**Note** 1. These four inputs are shared by interrupt inputs, interrupt inputs in counter mode, and quick-response inputs, but each input can be used for only one purpose.

2. This input is shared by the high-speed counter and synchronized pulse control functions.
3. This output is shared by the pulse output and synchronized pulse control functions. These functions can be used with transistor outputs only.

## 1-2 Basic System Configurations

### 1-2-1 Stand-alone CPU Unit

CPU Unit with 20/30 I/O Points

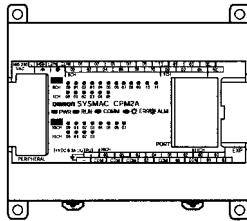

CPU Unit with 40 I/O Points

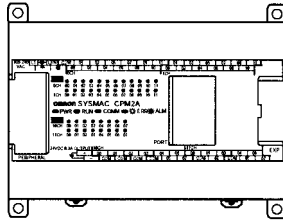

CPU Unit with 60 I/O Points

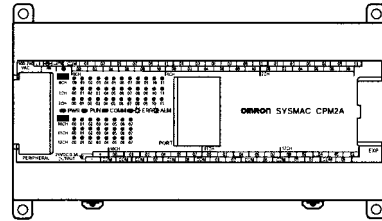

Number of I/O points	Power supply	Inputs	Outputs	Model
20 I/O points (12 inputs and 8 outputs)	100 to 240 VAC	24 VDC	Relay	CPM2A-20CDR-A
	24 VDC	24 VDC	Relay	CPM2A-20CDR-D
		24 VDC	Sinking Transistor	CPM2A-20CDT-D
		24 VDC	Sourcing Transistor	CPM2A-20CDT1-D
30 I/O points (18 inputs and 12 outputs)	100 to 240 VAC	24 VDC	Relay	CPM2A-30CDR-A
	24 VDC	24 VDC	Relay	CPM2A-30CDR-D
		24 VDC	Sinking Transistor	CPM2A-30CDT-D
		24 VDC	Sourcing Transistor	CPM2A-30CDT1-D
40 I/O points (24 inputs and 16 outputs)	100 to 240 VAC	24 VDC	Relay	CPM2A-40CDR-A
	24 VDC	24 VDC	Relay	CPM2A-40CDR-D
		24 VDC	Sinking Transistor	CPM2A-40CDT-D
		24 VDC	Sourcing Transistor	CPM2A-40CDT1-D
60 I/O points (36 inputs and 24 outputs)	100 to 240 VAC	24 VDC	Relay	CPM2A-60CDR-A
	24 VDC	24 VDC	Relay	CPM2A-60CDR-D
		24 VDC	Sinking Transistor	CPM2A-60CDT-D
		24 VDC	Sourcing Transistor	CPM2A-60CDT1-D

### 1-2-2 CPU Unit, Expansion Units, and Expansion I/O Units

Up to 3 Expansion Units or Expansion I/O Units can be connected to the expansion connector with expansion I/O connecting cables. (Only one Expansion Unit or Expansion I/O Unit can be connected if an NT-AL001 Adapter is connected to the RS-232C port because the CPU Unit's 5-VDC power supply is limited.)

There are four types of Units available: Expansion I/O Units, an Analog I/O Unit, Temperature Sensor Units, and a CompoBus/S I/O Link Unit.

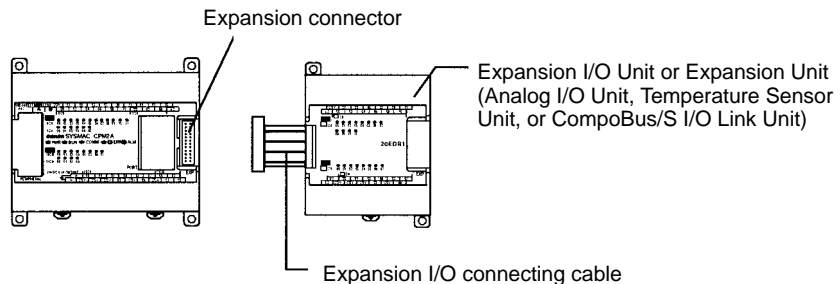

A PC with 120 I/O points (the maximum) can be assembled by connecting three Expansion I/O Units to a CPU Unit with 60 I/O points.

$$\text{CPM2A-60CDR-A (36 inputs, 24 outputs)} \times 1 \text{ Unit} + \text{CPM1A-20EDR1 (12 inputs, 8 outputs)} \times 3 \text{ Units} = 72 \text{ inputs, 48 outputs}$$

A PC with 6 analog inputs and 3 analog outputs (the maximum) can be assembled by connecting three Analog I/O Units. (Only one Analog I/O Unit can be connected if an NT-AL001 Adapter is connected to the CPU Unit's RS-232C port.)

A PC with up to 6 temperature inputs for input from thermocouples or platinum resistance thermometers can be assembled by connecting Temperature Sensor Units.

CompoBus/S I/O Link Units (Slave Units) can be connected to a CPU Unit. I/O data (8 inputs and 8 outputs) is transferred between the CPU Unit and the area allocated to the CompoBus/S Slave. (The I/O data exchanged with the Slave is internal data; there are no external input or output terminals.)

- Note**
1. Different types of Expansion I/O Units or Expansion Units can be connected at the same time. For example, an Expansion I/O Unit, an Analog I/O Unit, and a CompoBus/S I/O Link Unit can be connected to the CPU Unit.
  2. When an NT-AL001 Adapter is connected to the RS-232C port, only one Expansion Unit or Expansion I/O Unit can be connected to the CPU Unit because of power supply limitations.

**Expansion I/O Units**

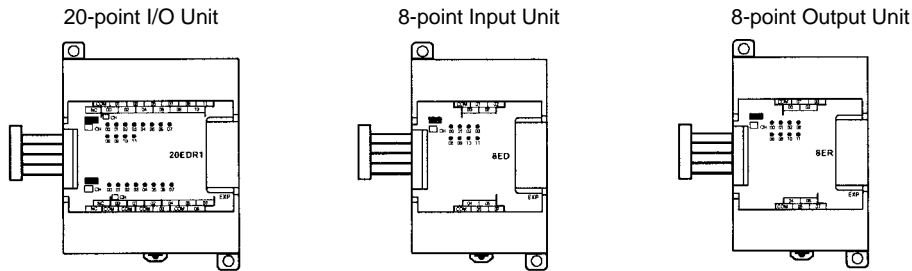

Unit		Max. number of Units	Inputs	Outputs	Model
Expansion I/O Units	20 I/O points 12 inputs 8 outputs	3 Units max. (See note.)	24 VDC	Relays	CPM1A-20EDR1
			24 VDC	Sinking transistors	CPM1A-20EDT
	24 VDC		Sourcing transistors	CPM1A-20EDT1	
	8 inputs		24 VDC	---	CPM1A-8ED
	8 outputs		---	Relays	CPM1A-8ER
			---	Sinking Transistors	CPM1A-8ET
			---	Sourcing Transistors	CPM1A-8ET1

**Note** Only one Expansion I/O Unit can be connected if an NT-AL001 Adapter is connected to the CPU Unit's RS-232C port.

**Expansion Units**

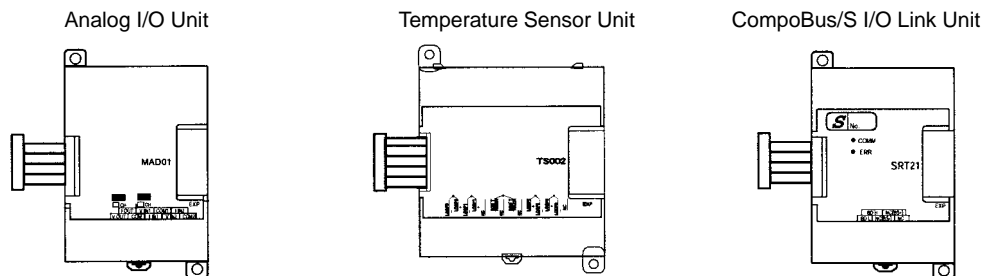

Unit		Max. number of Units	Inputs	Outputs	Model
Analog I/O Unit 2 analog inputs (2 words) 1 analog output (1 word)		3 Units max. (See note.)	2 analog inputs	1 analog output	CPM1A-MAD01
Temperature Sensor Unit	Thermocouple inputs	3 Units max. (See note.)	2 inputs (K, J)	---	CPM1A-TS001
		1 Unit max. (See note.)	4 inputs (K, J)		CPM1A-TS002
	Platinum resistance thermometer inputs	3 Units max. (See note.)	2 inputs (Pt100, JPt100)		CPM1A-TS101
		1 Unit max. (See note.)	4 inputs (Pt100, JPt100)		CPM1A-TS102
CompoBus/S I/O Link Unit 8 inputs and 8 outputs		3 Units max. (See note.)	8 bits (Inputs from the Master.)	8 bits (Outputs to the Master.)	CPM1A-SRT21

**Note** Only one Expansion Unit can be connected if an NT-AL001 Adapter is connected to the CPU Unit's RS-232C port.

## 1-3 Structure and Operation

### 1-3-1 CPU Unit Structure

The following diagram shows the internal structure of the CPU Unit.

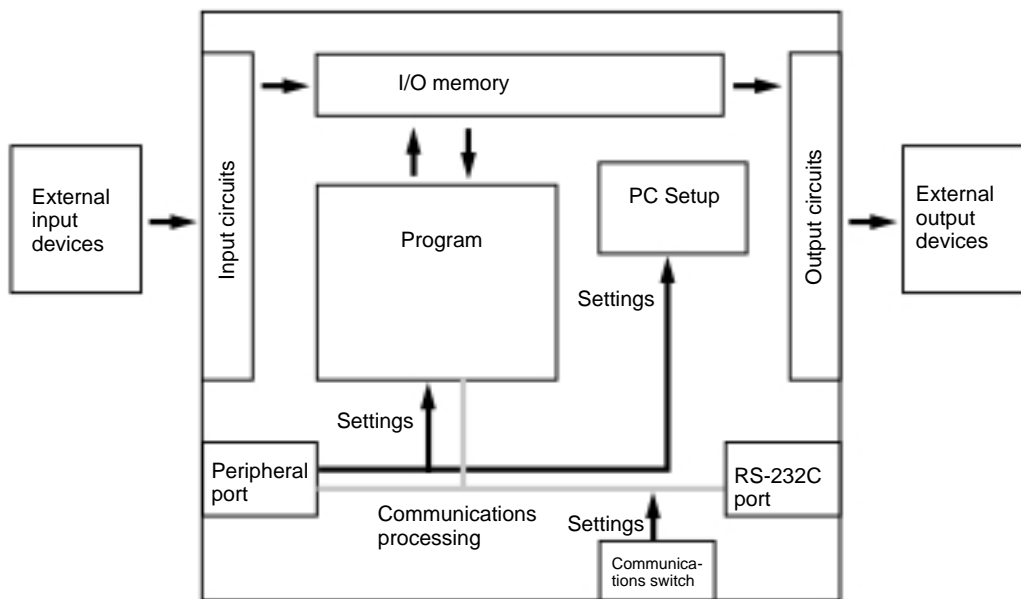

#### I/O Memory

The program reads and writes data in this memory area during execution. Part of the I/O memory contains the bits that reflect the status of the PC's inputs and outputs. Parts of the I/O memory are cleared when the power is turned ON and other parts are retained.

**Note** Refer to *Section 3 Memory Areas* in the *Programming Manual (W353)* for more details on I/O memory.

#### Program

This is the program written by the user. The CPM2A executes the program cyclically. (Refer to *1-3-5 Cyclic Operation* and *Interrupts* for details.)

The program can be divided broadly into two parts: the "main program" that is executed cyclically and the "interrupt programs" that are executed only when the corresponding interrupt is generated.



**PC Setup**

The PC Setup contains various startup and operating parameters. The PC Setup parameters can be changed from a Programming Device only; they cannot be changed from the program.

Some parameters are accessed only when PC's power supply is turned on and others are accessed regularly while the power is on. It will be necessary to turn the power off and then on again to enable a new setting if the parameter is accessed only when the power is turned on.

**Note** Refer to *Section 1 PC Setup* in the *Programming Manual (W353)* for more details.

**Communications Switch**

The Communications Switch determines whether the peripheral port and RS-232C port operate with the standard communications settings or the communications settings in the PC Setup.

### 1-3-2 Operating Modes

CPM2A CPU Units have 3 operating modes: PROGRAM, MONITOR, and RUN.

**PROGRAM Mode**

The program cannot be executed in PROGRAM mode. This mode is used to perform the following operations in preparation for program execution

- Changing initial/operating parameters such as those in the PC Setup
- Writing, transferring, or checking the program
- Checking wiring by force-setting and force-resetting I/O bits

**MONITOR Mode**

The program is executed in MONITOR mode and the following operations can be performed from a Programming Device. In general, MONITOR mode is used to debug the program, test operation, and make adjustments.

- Online editing
- Monitoring I/O memory during operation
- Force-setting/force-resetting I/O bits, changing set values, and changing present values during operation

**RUN Mode**

The program is executed at normal speed in RUN mode. Operations such as online editing, force-setting/force-resetting I/O bits, and changing set values/present values cannot be performed in RUN mode, but the status of I/O bits can be monitored.

### 1-3-3 Operating Mode at Startup

The operating mode of the CPM2A when the power is turned on depends upon the PC Setup settings and the Programming Console's mode switch setting if a Programming Console is connected.

PC Setup setting			Programming Console connected	Programming Console not connected
Word	Bits	Setting		
DM6600	08 to 15	00	Startup mode determined by the mode switch setting.	Startup mode is RUN mode. (See note.)
		01	Startup mode is the same as the operating mode before power was interrupted.	
		02	Startup mode is determined by bits 00 to 07.	
	00 to 07	00	PROGRAM mode	
		01	MONITOR mode	
		02	RUN mode	

**Note** The default setting is 00. With this default setting, the startup operating mode is determined by the Programming Console's mode switch setting if a Programming Console is connected to the Peripheral port. If a Programming Console is not connected, the PC will automatically enter RUN mode.

### 1-3-4 PC Operation at Startup

#### Time Required for Initialization

The time required for startup initialization depends on several factors, such as the operating conditions (including power supply voltage, system configuration, and ambient temperature) and the program contents.

#### Power OFF Operation

##### Minimum Power Supply Voltage

The PC will stop and all outputs will be turned OFF if the power supply voltage falls below 85% of the rated value.

##### Momentary Power Interruption

A power interruption will not be detected and CPU Unit operation will continue if the power interruption lasts less than 10 ms for an AC power supply or 2 ms for a DC power supply.

A power interruption may or may not be detected for power interruptions somewhat longer than 10 ms for an AC power supply or 2 ms for a DC power supply.

When a power interruption is detected, the CPU Unit will stop operating and all outputs will be turned OFF.

##### Automatic Reset

Operation will restart automatically when the power supply voltage is restored to more than 85% of the rated voltage.

##### Timing Chart of Power OFF Operation

The power interruption detection time is the time required for a power interruption to be detected after the power supply voltage drops below 85% of the rated value.

- 1, 2, 3...
1. Minimum power interruption detection time  
Power interruptions that are shorter than 10 ms (AC power supply) or 2 ms (DC power supply) will not be detected.
  2. Undetermined additional time  
Power interruptions only slightly longer than the minimum power interruption time may not be detected.

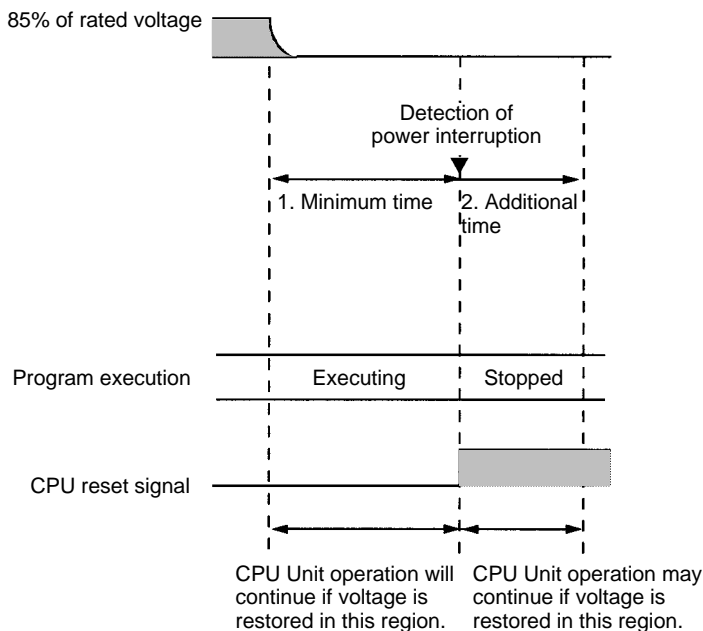

**Note** If the power supply voltage fluctuates around 85% of the PC's rated voltage, PC operation may stop and restart repeatedly. When repeated stopping and starting will cause problems with the controlled system, set up a protective circuit such as a circuit that shuts off the power supply to sensitive equipment until the power supply voltage returns to the rated value.

### 1-3-5 Cyclic Operation and Interrupts

#### Basic CPU Operation

Initialization processing is performed when the power is turned on. If there are no initialization errors, the overseeing processes, program execution, I/O refreshing, and communications port servicing are performed repeatedly (cyclically).

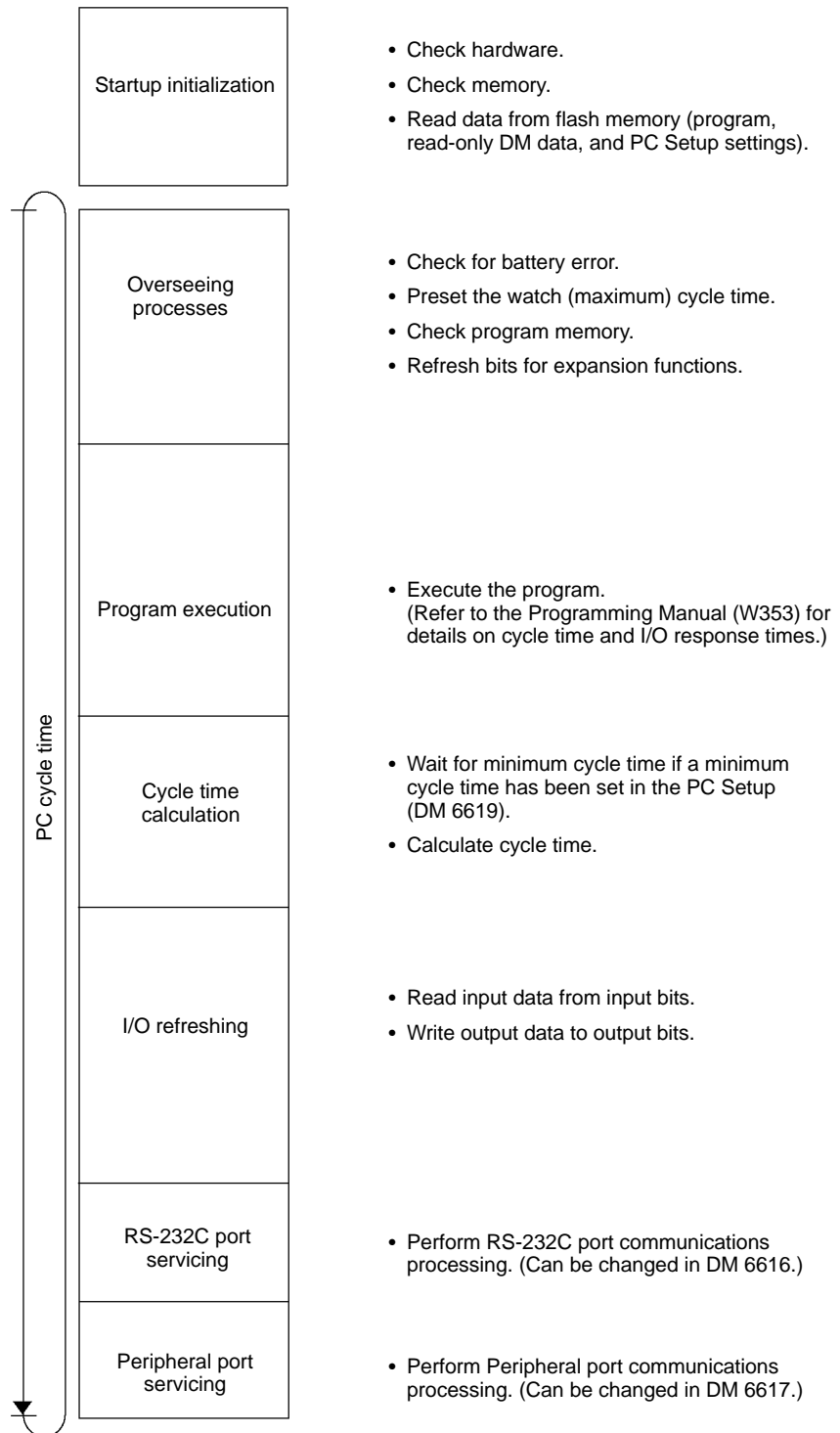

The cycle time can be read from a Programming Device.

AR 14 contains the maximum cycle time and AR 15 contains the present cycle time in multiples of 0.1 ms.

**Program Execution in Cyclic Operation**

The cycle time will vary slightly depending on the processing being performed in each cycle, so the calculated cycle time will not always match the actual cycle time.

The following diagram shows the cyclic operation of the CPM2A when the program is being executed normally.

Normally, the results of program execution are transferred to I/O memory just after program execution (during I/O refreshing), but IORF(97) can be used to refresh a specified range of I/O words during program execution. The specified range of I/O words will be refreshed when IORF(97) is executed.

The cycle time is the sum of the time required for program execution, I/O refreshing, and communications port servicing.

A minimum cycle time (1 to 9,999 ms) can be set in the PC Setup (DM 6619). When a minimum cycle time has been set, CPU operation is paused after program execution until the minimum cycle time is reached. CPU operation will not be paused if the actual cycle time is longer than the minimum cycle time set in DM 6619.

**Note** A fatal error will occur and PC operation will stop if a maximum cycle time has been set in the PC Setup (DM 6618) and the actual cycle time exceeds that setting.

The default settings for RS-232C port servicing and Peripheral port servicing are 5% of the cycle time, but these settings can be changed (between 1% and 99%) in the PC Setup. The RS-232C port's setting is in DM 6616 and the Peripheral port's setting is in DM 6617.

Refer to *Section 7 PC Operations and Processing Time* in the *Programming Manual (W353)* for more details and precautions on the cycle time.

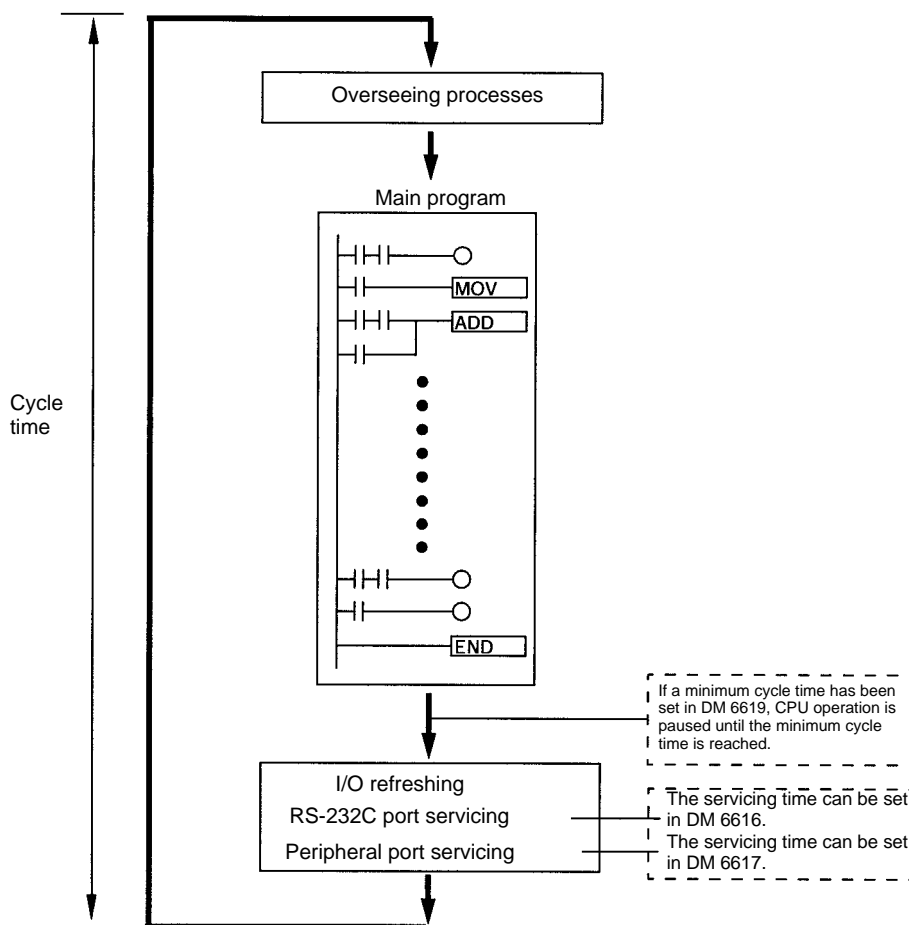

**Interrupt Program Execution**

When an interrupt is generated during execution of the main program, main program execution is interrupted immediately and the interrupt program is executed. The following diagram shows the cyclic operation of the CPM2A when an interrupt program is executed.

Normally, the results of interrupt program execution are transferred to I/O memory just after program execution (during I/O refreshing), but IORF(97) can be used to refresh a specified range of I/O words during execution of the interrupt program. The specified range of I/O words will be refreshed when IORF(97) is executed.

The normal cycle time is extended by the time required for execution of the interrupt program.

Refer to *Section 7 PC Operations and Processing Time* in the *Programming Manual (W353)* for more details and precautions on the cycle time.

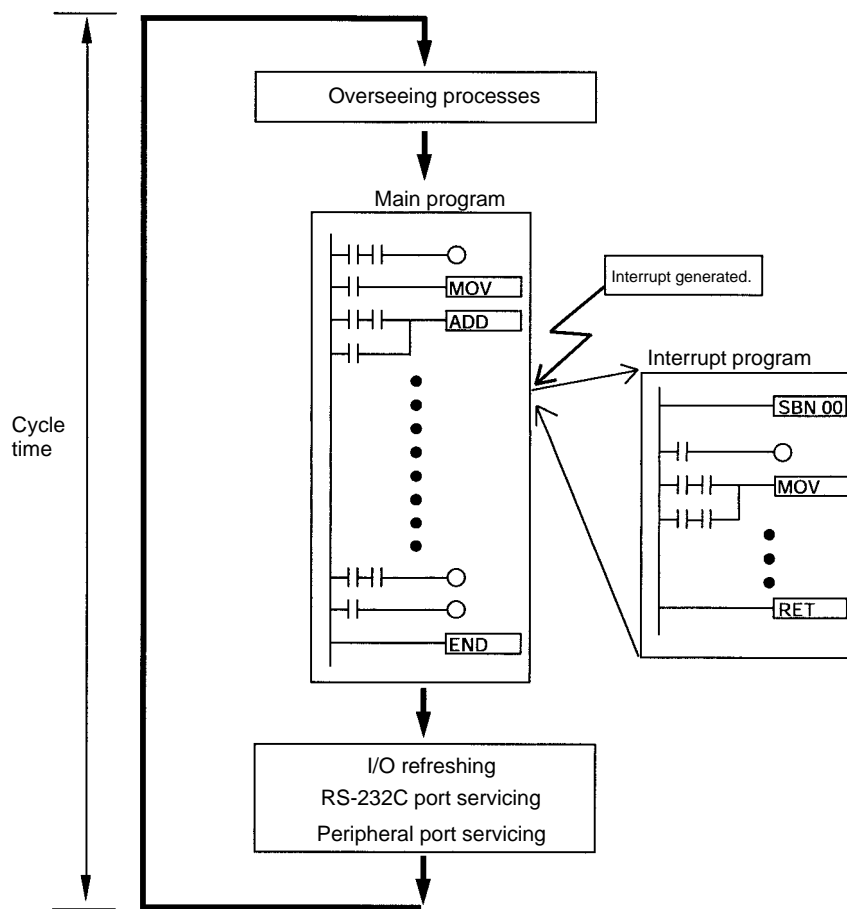

**Caution**

Although IORF(97) can be used in interrupt subroutines, you must be careful of the interval between IORF(97) executions. If IORF(97) is executed too frequently, a fatal system error may occur (FALS 9F), stopping operation. The interval between executions of IORF(97) should be at least 1.3 ms + total execution time of the interrupt subroutine.

**Immediate Refreshing**

IORF(97) can be executed in the program to refresh a specified range of I/O words. The specified I/O words will be refreshed when IORF(97) is executed. IORF(97) can be used to refresh I/O from the main program or the interrupt program.

When IORF(97) is used, the cycle time is extended by the time required to refresh the specified I/O words.

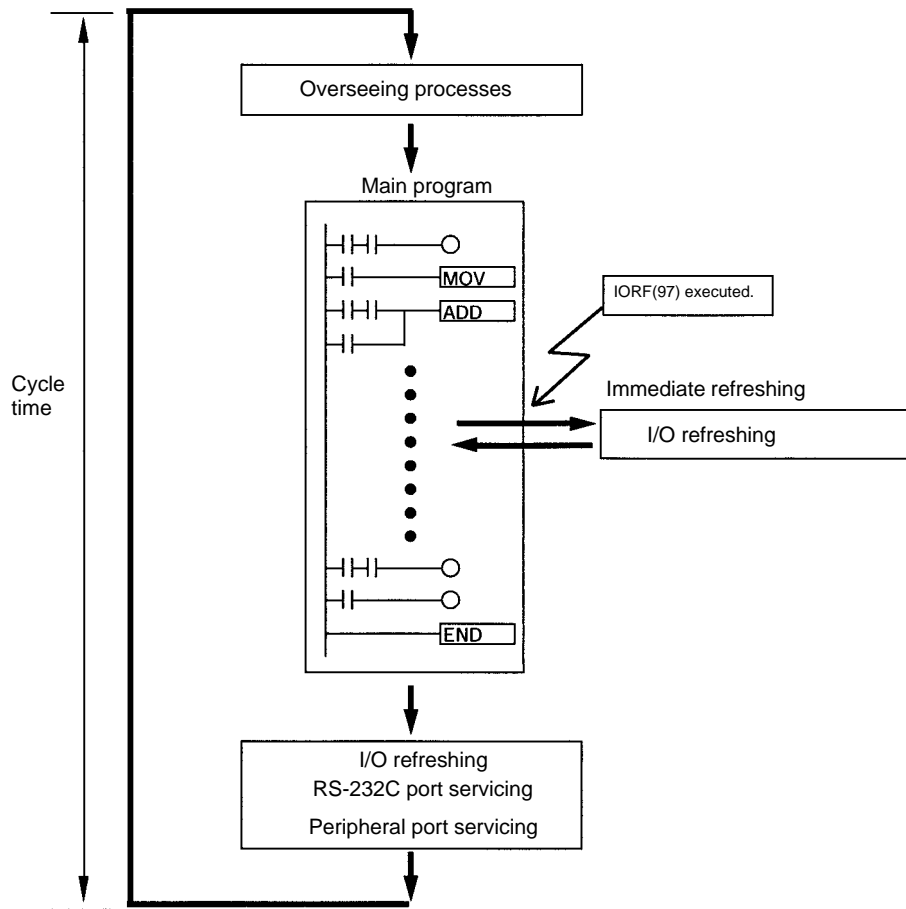

## 1-4 Functions Listed by Usage

### Machine Control Functions

Usage		Function	Refer to
Receive high-speed count inputs (For example, calculating length or position with an encoder).	Max. count frequency of 2 kHz (single-phase)	Use interrupt input (counter mode) to read the present value without interrupts.	W353
	Max. count frequency of 5 kHz (differential phase) or 20 kHz (single-phase)	Use high-speed counter to read the present value without interrupts.	
Generate a pulse output based on a multiple of an input pulse to synchronize control of a peripheral process with the main process.  The multiple for the peripheral process (such as tool feed rate) can be changed during operation by calculating the multiple from another input value (such as an encoder) in the peripheral process.  This method can be used to change the process for different products or models without stopping the equipment.		Pulse synchronization	

Usage		Function	Refer to
<p>Multiply the input pulse frequency from a high-speed counter by a fixed multiple, convert that value to an analog value, and output as an analog output. (For example, synchronizing the speed of a supply conveyor with the rotational position of the main piece of equipment (such as a label inserter) measured by an analog input.)</p>		Pulse synchronization and analog output function	W353
<p>Reliably receive input pulses with an ON-time shorter than the cycle time (such as inputs from a photomicrosensor).</p>		Quick-response input function	
Interrupt functions	<p>Execute a special process very quickly when an input goes ON. (For example, operating a cutter when an interrupt input is received from a Proximity Switch or Photoelectric Switch.)</p>	Interrupt input (interrupt input mode)	
	<p>Count input ON pulses and execute a special process very quickly when the count reaches the preset value. (For example, stopping the supply feed when a preset number of workpieces have passed through the system.)</p>	Interrupt input (counter mode)	
	<p>Execute a special process at a preset count value. (For example, cutting material very precisely at a given length.)</p>	High-speed counter interrupt generated when the count matches the set value.	
	<p>Execute a special process when the count is within a preset range. (For example, sorting material very quickly when it is within a given length range.)</p>	High-speed counter interrupt generated when the count is within the set range.	
	<p>Execute a special process when a timer times out. (For example, stopping a conveyor at very precise time (independent of the cycle time) after the workpiece is detected.)</p>	Interval timer interrupt (One-shot mode)	
	<p>Repeat a special process at regular intervals. (For example, the speed of a sheet feeder can be monitored by measuring the input signal from an encoder at regular intervals and calculating the speed.)</p>	Interval timer interrupt (Scheduled interrupt mode)	
<p>Perform simple positioning by outputting pulses to a motor driver that accepts pulse-train inputs.</p>		Pulse output function	
<p>Use a variable duty-ratio output to perform time-allocated temperature control.</p>		Analog input + Variable duty-ratio output pulse function (PWM(—))	
<p>Easily set and fine-tune settings such as the low-speed feed rate when a conveyor is temporarily stopped.</p>		Analog controls	
<p>Receive an analog input and output an analog output.</p>		Analog I/O Unit (Connect the Analog I/O Unit to the CPU Unit.)	
<p>Receive temperature sensor input directly at the PC.</p>		Temperature Sensor Unit (Connect the Temperature Sensor Unit to the CPU Unit.)	
<p>Reduce required wiring, space, and PC load by controlling equipment with a few low-capacity PCs dispersed near the equipment rather than a single, large, centralized PC. (Create a remote I/O link with a CompoBus/S Master and CompoBus/S Slaves.)</p>		CompoBus/S I/O Link Unit (Connect the CompoBus/S I/O Link Unit to the CPU Unit.)	

**Basic Functions**

Usage	Function	Refer to
Set the cycle time to a fixed interval.	Set a minimum (fixed) cycle time in the PC Setup.	W353
Stop PC operation when the cycle time exceeds a maximum setting.	Set a maximum (watch) cycle time in the PC Setup.	
Keep all outputs ON when PC operation stops.	Turn ON the IOM Hold Bit (SR 25212).	
Retain the contents of I/O memory when starting operation.	Turn ON the IOM Hold Bit (SR 25212).	
Retain the contents of I/O memory when the PC is turned on.	Turn ON the IOM Hold Bit (SR 25212) and set the PC Setup (DM 6601) so that the status of the IOM Hold Bit is maintained at startup.	
Eliminate effects from chattering and external noise.	Set a longer input time constant in the PC Setup.	

**Maintenance Functions**

Usage	Function	Refer to
Record data with time-stamp.	Clock/calendar function	W353
Establish user-defined errors for desired input conditions. (Fatal and non-fatal errors can be defined.)	FAL(06) defines non-fatal errors. (PC operation continues.) FALS(07) defines fatal errors. (PC operation stops.)	
Read the number of power interruptions.	The number of power interruptions is stored in AR 23.	
Set the startup operating mode.	Set the startup operating mode in the PC Setup (DM 6600).	

**Communications Functions**

Usage	Function	Refer to
Read/write I/O memory data and change the operating mode from a host computer.	Host Link communications (Set the communications mode to Host Link in the PC Setup.)	W353
Connect to a serial device such as a bar code reader or serial printer.	No-protocol communications (Set the communications mode to no-protocol in the PC Setup.)	
Make a high-speed connection with an OMRON Programmable Terminal.	1:1 NT Link (Set the communications mode to 1:1 NT Link in the PC Setup.)	
Make a PC-PC data link connection with another CPM2A, or a CPM1, CPM1A, CPM2C, SRM1, CQM1, C200HS, or C200HX/HG/HE PC.	1:1 PC Link (Set the communications mode to 1:1 PC Link in the PC Setup.)	
Connect a Programming Console.	Connect the Programming Console to the Peripheral port. (The CPU Unit's Communications Switch setting has no effect on this connection.)	Page 98
Connect a personal computer running SYSMAC Support Software (SSS) or SYSMAC-CPT Support Software.	The computer can be connected to the Peripheral port or RS-232C port. (The Host Link settings in the PC Setup are used when the switch is OFF; the standard Host Link communications settings are used when the CPU Unit's Communications Switch is ON.)	Page 89
Monitor equipment with a Programmable Terminal and program the PC with a Programming Device.	The RS-232C port and Peripheral port can be used simultaneously.	W353 Page 98

**1-5 Comparison with the CPM1A**

Item		CPM2A	CPM1A
Instruction set	Basic instructions	14	Same as CPM2A.
	Special instructions	105 instructions, 185 variations	79 instructions, 139 variations
Instruction execution times	Basic instructions	LD: 0.64 $\mu$ s	LD: 1.72 $\mu$ s
	Special instructions	MOV(21): 7.8 $\mu$ s	MOV(21): 16.3 $\mu$ s
Program capacity		4,096 words	2,048 words



Item		CPM2A	CPM1A
Maximum number of I/O points	Stand-alone CPU Unit	30, 40, or 60 points	10, 20, 30, or 40 points
	CPU Unit with Expansion I/O Units	90, 100, or 120 points max.	90 or 100 points max.
Expansion Units and Expansion I/O Units	Maximum number of Units	A maximum of 3 Units can be connected to any of the CPU Units. (If the CPM1A-TS002/102 is connected, the maximum is 2.)	A maximum of 3 Units can be connected to the 30-point and 40-point CPU Units.
	Available models	Expansion I/O Units, Analog I/O Unit, Temperature Sensor Units, and CompoBus/S I/O Link Unit	Same as CPM2A.
I/O memory	Input bits	IR 00000 to IR 00915	Same as CPM2A.
	Output bits	IR 01000 to IR 01915	Same as CPM2A.
	Work bits	928 bits: IR 02000 to IR 04915, IR 20000 to IR 22715	512 bits: IR 20000 to IR 23115
	SR (Special Relay) area	448 bits: SR 22800 to SR 25515	384 bits: SR 23200 to SR 25515
	TR (Temporary Relay) area	8 bits: TR0 to TR7	Same as CPM2A.
	HR (Holding Relay) area	320 bits: HR 0000 to HR 1915	Same as CPM2A.
	AR (Auxiliary Relay) area	384 bits: AR 0000 to AR 2315	256 bits: AR 0000 to AR 1515
	LR (Link Relay) area	256 bits: LR 0000 to LR 1515	Same as CPM2A.
	Timer/Counter area	256 bits: TIM/CNT 0 to TIM/CNT 256	128 bits: TIM/CNT 0 to TIM/CNT 127
	DM (Data Memory) area	Read/write area	2,048 words (DM 0000 to DM 2047)
Read-only area		456 words (DM 6144 to DM 6599)	Same as CPM2A.
PC Setup		56 words (DM 6600 to DM 6655)	Same as CPM2A.
Memory backup	Program area, read-only DM area (including PC Setup)	Flash memory backup	Same as CPM2A.
	Read/write DM area, HR area, AR area, and counters	Internal battery backup (5-year lifetime, replaceable)	Capacitor backup (20-day backup at 25°C)
Interrupt inputs (interrupt input mode)		4	Same as CPM2A.
Interrupt inputs (counter mode)	Counter mode	Incrementing counter Decrementing counter	Decrementing counter
	Counter upper limit	2 kHz	1 kHz
	SR 244 to SR 247	Contains counter PV.	Contains counter PV-1.
	Method(s) to read counter PV	Read SR 244 to SR 247. Execute PRV(62). (Counter PV)	Read SR 244 to SR 247. (Counter PV - 1)
Method to change counter PV		Execute INI(61).	Not supported.
Interval timer	One-shot mode	Yes	Yes
	Scheduled interrupt mode	Yes	Yes
Quick-response inputs	Setting the quick-response function	PC Setup	PC Setup and INT(89) (Unmask interrupt input.)
	INT(89) (Mask)	Not supported (ignored)	Supported.
	INT(89) (Read mask)	Reads mask status.	Reads result of mask setting.
	INT(89) (Clear)	Not supported (ignored)	Supported.
	Minimum pulse width	50 $\mu$ s min.	200 $\mu$ s min.

Item		CPM2A	CPM1A
High-speed counter	Count mode	Differential-phase (up/down) mode Pulse plus direction mode Up/down pulse mode Increment mode	Differential-phase (up/down) mode Increment mode
	Max. counter frequency	5 kHz in differential-phase (up/down) mode 20 kHz in pulse plus direction mode, up/down pulse mode, and increment mode	2.5 kHz in differential-phase (up/down) mode, 5 kHz in increment mode
	Counter PV range	−8,388,608 to 8,388,607 in differential-phase (up/down) mode, pulse plus direction mode, and up/down pulse mode 0 to 16,777,215 in increment mode	−32,768 to 32,767 in differential-phase (up/down) mode 0 to 65,535 in increment mode
	Check when registering target value match table	Same direction, same SV not possible	Same direction, same SV possible
	Method used to reference the target value match interrupt table	Comparison of all values in the table, regardless of order of appearance in table	Comparison in order of appearance in table
	Reading range-comparison results	Check AR 1100 to AR 1107 or execute PRV(62).	Check AR 1100 to AR 1107.
	Reading status	Check AR 1108 (comparison in progress), check AR 1109 (high-speed counter PV overflow/underflow), or execute PRV(62).	---
	Pulse synchronization		Supported.
Pulse output control	Trapezoidal acceleration/deceleration	Supported with ACC(—). The initial frequency can be set.	Not supported.
	PWM(—) output	Supported.	Not supported.
	Number of simultaneous pulse outputs	2 max.	1 max.
	Maximum frequency	10 kHz max.	2 kHz max.
	Minimum frequency	10 Hz	20 Hz
	Pulse output quantity	−16,777,215 to 16,777,215	0 to 16,777,215
	Direction control	Supported.	Not supported.
	Positioning to absolute positions	Supported.	Not supported.
	Bit status while pulses are being output	No effect	Turned ON/OFF by pulse output
	Reading PV	Read SR 228 through SR 231 or execute PRV(62).	Not supported.
	Resetting PV	Supported.	Not supported.
	Status outputs	Accelerating/decelerating PV overflow/underflow Pulse quantity set Pulse output completed Pulse output status	Pulse output status
Analog controls		2	2
Clock function		Internal	None
	Words containing time info.	AR 17 to AR 21	---
Analog I/O		Analog I/O Units can be connected.	Same as CPM2A.

Item		CPM2A	CPM1A
Temperature monitoring		The CPU Unit can receive temperature sensor input from either thermocouples or platinum resistance thermometers.	Same as CPM2A.
CompoBus/S communications		A CompoBus/S I/O Link Unit can be connected to provide CompoBus/S Slave functions.	Same as CPM2A.
Communications switch		This switch determines whether communications are governed by the standard settings or PC Setup settings.	None
Battery	Battery	Lithium	None (capacitor backup only)
	Battery replacement	Possible	---
	Life expectancy/backup time	5-year lifetime at 25°C	20-day backup at 25°C
	Battery error detection	Supported.	---
Communications (in CPU Unit)	Peripheral port	Programming Console (auto-detect) Peripheral bus (auto-detect) Host Link (with Slave-initiated communications) No-protocol	Programming Console (auto-detect) Peripheral bus (auto-detect) Host Link 1:1 PC Link 1:1 NT Link
	RS-232C port	Host Link No-protocol 1:1 PC Link 1:1 NT Link	None
Input time constant		Can be set to 1, 2, 3, 5, 10, 20, 40, or 80 ms. (Default: 10 ms)	Can be set to 1, 2, 4, 8, 16, 32, 64, or 128 ms. (Default: 8 ms)

**Differences in Instruction Sets****Instructions added to the CPM2A**

<b>Mnemonic</b>	<b>Name</b>
TXD(48)	TRANSMIT
RXD(47)	RECEIVE
SCL(66)	SCALING
SCL2(—)	SIGNED BINARY TO BCD SCALING
SCL3(—)	BCD TO SIGNED BINARY SCALING
SRCH(—)	DATA SEARCH
MAX(—)	FIND MAXIMUM
MIN(—)	FIND MINIMUM
SUM(—)	SUM CALCULATION
FCS(—)	FCS CALCULATE
HEX(—)	ASCII-TO-HEXADECIMAL
AVG(—)	AVERAGE VALUE
PWM(—)	PULSE WITH VARIABLE DUTY RATIO
PID(—)	PID CONTROL
ZCP(—)	AREA RANGE COMPARE
ZCPL(—)	DOUBLE AREA RANGE COMPARE
NEG(—)	2'S COMPLEMENT
ACC(—)	ACCELERATION CONTROL
STUP(—)	CHANGE RS-232C SETUP
SYNC(—)	SYNCHRONIZED PULSE CONTROL
BINL(58)	DOUBLE BCD TO DOUBLE BINARY
BCDL(59)	DOUBLE BINARY TO DOUBLE BCD
TMHH(—)	VERY HIGH-SPEED TIMER
TIML(—)	LONG TIMER
SEC(—)	HOURS-TO-SECONDS
HMS(—)	SECONDS-TO-HOURS

**Instructions with Changed Specifications**

<b>Mnemonic</b>	<b>Name</b>	<b>CPM2A</b>	<b>CPM1A</b>
INI(61)	MODE CONTROL	Supports the interrupt input (counter mode) PV change operation. Supports the pulse output PV change operation. Supports the pulse synchronization control stop operation.	Does not support these operations.
PRV(62)	HIGH-SPEED COUNTER PV READ	Supports the interrupt input (counter mode) PV read operation. Supports the pulse output PV read operation.	Does not support these operations.
CTBL(63)	COMPARISON TABLE LOAD	The count is compared with all of the target values in the target value comparison table.	The count is compared with each target value in the order that they appear in the target value comparison table.
PULS(65)	SET PULSES	Supports absolute pulse specification, but the coordinate system must be set to absolute coordinates.	Does not support absolute pulse specification.
INT(89)	INTERRUPT CONTROL	Supports a count-up interrupt for incrementing counters.	Does not support this interrupt function.

**Caution** Before using a CPM1A program containing one or more of the instructions in the table above, check the program to be sure that it will operate properly and edit the program if necessary. The CPM2A may not operate properly if a CPM1A program with these instructions is transferred and executed unchanged.

**Added Function Code Allocations**

The following three instructions are allocated function codes that were not used in the CPM1A.

Instruction	CPM2A	CPM1A
RXD(47)	RECEIVE	Not allocated. (NOP(00))
TXD(48)	TRANSMIT	
SCL(66)	SCALING	

**Differences in I/O Memory**

**SR Area Differences**

The following table shows differences in the SR area. (PV is the abbreviation for present value.)

Function	CPM2A	CPM1A
Pulse output 0 PV	SR 228 to SR 229	Not supported.
Pulse output 1 PV	SR 230 to SR 231	
Pulse output 0 PV Reset Bit	SR 25204	
Pulse output 1 PV Reset Bit	SR 25205	
RS-232C Port Reset Bit	SR 25209	
Battery Error Flag	SR 25308	
Changing RS-232C Port Setup Flag	SR 25312	

**AR Area Differences**

The following table shows differences in the AR area.

Function	CPM2A	CPM1A	
Clock/calendar data	AR 17 to AR 21	Not supported.	
RS-232C Communications Error Code	AR 0800 to AR 0803		
RS-232C Error Flag	AR 0804		
RS-232C Transmission Enabled Flag	AR 0805		
RS-232C Reception Completed Flag	AR 0806		
RS-232C Reception Overflow Flag	AR 0807		
Peripheral Port Reception Completed Flag	AR 0814		
Peripheral Port Reception Overflow Flag	AR 0815		
RS-232C Reception Counter	AR 09		
High-speed Counter Comparison Flag	AR 1108		
High-speed Counter Overflow/Underflow Flag	AR 1109		
Pulse Output 0 Condition	AR 1111		
Pulse Output 0 PV Overflow/Underflow Flag	AR 1112		
Pulse Output 0 Pulse Quantity Set Flag	AR 1113		
Pulse Output 0 Output Completed Flag	AR 1114		
Pulse Output 1 PV Overflow/Underflow Flag	AR 1212		
Pulse Output 1 Pulse Quantity Set Flag	AR 1213		
Pulse Output 1 Output Completed Flag	AR 1214		
Pulse Output 1 Output Status	AR 1215		
Power OFF Counter	AR 23 (See note.)		AR 10

**Note** CPM1A programs that use AR 10 (the Power OFF Counter) cannot be used in the CPM2A without editing the program. In the CPM2A, the Power OFF Counter is in AR 23.

**DM Area Differences**

The following table shows differences in the DM area other than the PC Setup.

Function	CPM2A	CPM1A
Error Log Area	DM 2000 to DM 2021	DM 1000 to DM 1021

**Note** CPM1A programs that use the Error Log Area cannot be used in the CPM2A without editing the program to change the location of the Error Log Area.

The following table shows differences in the PC Setup.

Function	CPM2A	CPM1A
RS-232C Port Servicing Time Setting	DM 6616 bits 00 to 07	Not supported
RS-232C Port Servicing Time Enable	DM 6616 bits 08 to 15	
Pulse Output 0 Coordinate System	DM 6629 bits 00 to 03	
Pulse Output 1 Coordinate System	DM 6629 bits 04 to 07	
RS-232C Communications Settings Selector	DM 6645 bits 00 to 03	
RS-232C Port CTS Control Settings	DM 6645 bits 04 to 07	
RS-232C Port Link Words for 1:1 PC Link	DM 6645 bits 08 to 11	
RS-232C Port Communications Mode	DM 6645 bits 12 to 15	
RS-232C Port Baud Rate	DM 6646 bits 00 to 07	
RS-232C Port Frame Format	DM 6646 bits 08 to 15	
RS-232C Port Transmission Delay	DM 6647	
RS-232C Port Host Link Node Number	DM 6648 bits 00 to 07	
RS-232C Port No-protocol Start Code Enable	DM 6648 bits 08 to 11	
RS-232C Port No-protocol End Code Enable	DM 6648 bits 12 to 15	
RS-232C Port No-protocol Start Code Setting	DM 6649 bits 00 to 07	
RS-232C Port No-protocol End Code Setting or Number of Bytes Received	DM 6649 bits 08 to 15	
Peripheral Port No-protocol Start Code Enable	DM 6653 bits 08 to 11	
Peripheral Port No-protocol End Code Enable	DM 6653 bits 12 to 15	
Peripheral Port No-protocol Start Code Setting	DM 6654 bits 00 to 07	
Peripheral Port No-protocol End Code Setting or Number of Bytes Received	DM 6654 bits 08 to 15	
Battery Error Detect Setting	DM 6655 bits 12 to 15	

## 1-6 Preparation for Operation

Follow the steps listed below when setting up a CPM2A system.

- 1, 2, 3...**
1. System Design
    - Select a CPM2A CPU Unit, Expansion Units and Expansion I/O Units with the specifications required in the controlled system.
    - Design external fail-safe circuits such as interlock circuits and limit circuits. Refer to *2-1 Specifications* and *3-1 Design Precautions* for details.
  2. Installation
    - Install the CPU Unit. (Surface-mount or DIN-track installation)
    - Install the Expansion Unit(s) and Expansion I/O Unit(s).
 Refer to *3-3 Installing the CPM2A* and *3-4 Wiring and Connections* for details.
  3. Wiring
    - Wire the power supply and I/O devices.
    - Connect communications devices if necessary.
    - Connect the Programming Console.
 Refer to *3-4 Wiring and Connections* for details.
  4. Initial Settings
    - Turn OFF the CPU Unit's Communications Switch, if necessary. (When this switch is OFF, communications with devices other than the Programming Console are governed by the settings in the PC Setup.)

- Connect the Programming Console, set the mode switch to PROGRAM mode, and turn ON the PC.
- Check the CPU Unit's LED indicators and the Programming Console's display.
- Clear the PC's memory. (All Clear)
- Make PC Setup settings.

Refer to *3-3 Installing the CPM2A* for details.

5. Create Ladder Program

- Create a ladder program to control the system.

Refer to the *Programming Manual* for details.

6. Write Ladder Program in PC

- Write the ladder program in the PC with the Programming Console or transfer the program to the PC from the Support Software.

Refer to *Section 4 Using Programming Devices*, to the *SYSMAC Support Software Operation Manuals* and to the *CPT User Manual* for details.

7. Test Run

- Check I/O wiring in PROGRAM mode.
- Check and debug program execution in MONITOR mode.

Refer to *Section 5 Test Runs and Error Processing* for details.

# SECTION 2

## Unit Specifications and Components

This section provides the technical specifications of the Units that go together to create a CPM2A PC and describes the main components of the Units.

2-1	Specifications .....	28
2-1-1	General Specifications of CPU Units .....	28
2-1-2	Characteristics .....	29
2-1-3	I/O Specifications .....	31
2-2	Unit Components .....	35
2-2-1	CPU Unit Components .....	35
2-2-2	Expansion I/O Unit Components .....	38
2-2-3	Analog I/O Unit Components .....	39
2-2-4	Temperature Sensor Unit Components .....	39
2-2-5	CompoBus/S I/O Link Unit Components .....	41



## 2-1 Specifications

### 2-1-1 General Specifications of CPU Units

Item		CPU Units with 20 I/O points	CPU Units with 30 I/O points	CPU Units with 40 I/O points	CPU Units with 60 I/O points
Supply voltage	AC power	100 to 240 VAC, 50/60 Hz			
	DC power	24 VDC			
Operating voltage range	AC power	85 to 264 VAC			
	DC power	20.4 to 26.4 VDC			
Power consumption	AC power	60 VA max.			
	DC power	20 W max.			
Inrush current	AC power	60 A max.			
	DC power	20 A max.			
External power supply (AC power supplies only)	Supply voltage	24 VDC			
	Output capacity	300 mA: Use for input devices only. Cannot be used to drive outputs. (When the external power supply provides an overcurrent or is short circuited, the external power supply voltage will drop and PC operation will stop.)			
Insulation resistance		20 MΩ min. (at 500 VDC) between the external AC terminals and protective earth terminals			
Dielectric strength		2,300 VAC 50/60 Hz for 1 min between the external AC and protective earth terminals, leakage current: 10 mA max.			
Noise immunity		Conforms to IEC6100-4-4; 2 kV (power lines)			
Vibration resistance		10 to 57 Hz, 0.075-mm amplitude, 57 to 150 Hz, acceleration: 9.8 m/s <sup>2</sup> in X, Y, and Z directions for 80 minutes each (Time coefficient; 8 minutes × coefficient factor 10 = total time 80 minutes)			
Shock resistance		147 m/s <sup>2</sup> three times each in X, Y, and Z directions			
Ambient temperature		Operating: 0° to 55°C Storage: -20° to 75°C			
Humidity		10% to 90% (with no condensation)			
Atmosphere		Must be free from corrosive gas			
Terminal screw size		M3			
Power interrupt time		AC power supply: 10 ms min. DC power supply: 2 ms min. (A power interruption occurs if power falls below 85% of the rated voltage for longer than the power interrupt time.)			
CPU Unit weight	AC power	650 g max.	700 g max.	800 g max.	1,000 g max.
	DC power	550 g max.	600 g max.	700 g max.	900 g max.
Expansion I/O Unit weight		Units with 20 I/O points: 300 g max. Units with 8 output points: 250 g max. Units with 8 input points: 200 g max.			
Expansion Unit weight		Analog I/O Units: 150 g max. Temperature Sensor Units: 250 g max. CompoBus/S I/O Link Units: 200 g max.			

## 2-1-2 Characteristics

Item		Specification			
Control method		Stored program method			
I/O control method		Cyclic scan with direct output (Immediate refreshing can be performed with IORF(97).)			
Programming language		Ladder diagram			
Instruction length		1 step per instruction, 1 to 5 words per instruction			
Instructions		Basic instructions: 14 Special instructions: 105 instructions, 185 variations			
Execution time		Basic instructions: 0.64 $\mu$ s (LD instruction) Special instructions: 7.8 $\mu$ s (MOV instruction)			
Program capacity		4,096 words			
Max. I/O capacity	CPU Unit only	20 points	30 points	40 points	60 points
	With Expansion I/O Units	80 points max.	90 points max.	100 points max.	120 points max.
Input bits		IR 00000 to IR 00915 (Words not used for input bits can be used for work bits.)			
Output bits		IR 01000 to IR 01915 (Words not used for output bits can be used for work bits.)			
Work bits		928 bits: IR 02000 to IR 04915 and IR 20000 to IR 22715			
Special bits (SR area)		448 bits: SR 22800 to SR 25515			
Temporary bits (TR area)		8 bits (TR0 to TR7)			
Holding bits (HR area)		320 bits: HR 0000 to HR 1915 (Words HR 00 to HR 19)			
Auxiliary bits (AR area)		384 bits: AR 0000 to AR 2315 (Words AR 00 to AR 23)			
Link bits (LR area)		256 bits: LR 0000 to LR 1515 (Words LR 00 to LR 15)			
Timers/Counters		256 timers/counters (TIM/CNT 000 to TIM/CNT 255)  1-ms timers: TMHH(—) 10-ms timers: TIMH(15) 100-ms timers: TIM 1-s/10-s timers: TIML(—) Decrementing counters: CNT Reversible counters: CNTR(12)			
Data memory		Read/Write: 2,048 words (DM 0000 to DM 2047)* Read-only: 456 words (DM 6144 to DM 6599) PC Setup: 56 words (DM 6600 to DM 6655)  *The Error Log is contained in DM 2000 to DM 2021.			
Interrupt processing		External interrupts: 4 (Shared by the external interrupt inputs (counter mode) and the quick-response inputs.)			
Interval timer interrupts		1 (Scheduled Interrupt Mode or Single Interrupt Mode)			
High-speed counter		One high-speed counter: 20 kHz single-phase or 5 kHz two-phase (linear count method) Counter interrupt: 1 (set value comparison or set-value range comparison)			
Interrupt Inputs (Counter mode)		Four inputs (Shared by the external interrupt inputs (counter mode) and the quick-response inputs.) Counter interrupts: 4 (Shared by the external interrupt inputs and quick-response inputs.)			
Pulse output		Two points with no acceleration/deceleration, 10 Hz to 10 kHz each, and no direction control. One point with trapezoid acceleration/deceleration, 10 Hz to 10 kHz, and direction control. Two points with variable duty-ratio outputs.  (Pulse outputs can be used with transistor outputs only, they cannot be used with relay outputs.)			
Synchronized pulse control		One point: A pulse output can be created by combining the high-speed counter with pulse outputs and multiplying the frequency of the input pulses from the high-speed counter by a fixed factor.  (This output is possible with transistor outputs only, it cannot be used with relay outputs.)			
Quick-response inputs		Four points (Min. input pulse width: 50 $\mu$ s max.)			
Analog controls		2 controls, setting range: 0 to 200			

Item	Specification
Input time constant (ON response time = OFF response time)	Can be set for all input points. (1 ms, 2 ms, 3 ms, 5 ms, 10 ms, 20 ms, 40 ms, or 80 ms)
Clock function	Shows the year, month, day of the week, day, hour, minute, and second. (Backed up by the battery.)
Communications functions	Built-in peripheral port: Supports Host Link, peripheral bus, no-protocol, or Programming Console connections.  Built-in RS-232C port: Supports Host Link, no-protocol, 1:1 Slave Unit Link, 1:1 Master Unit Link, or 1:1 NT Link connections.
Functions provided by Expansion Units	Analog I/O Unit: Provides 2 analog inputs and 1 analog output.  Temperature Sensor Unit: Provides up to 6 thermocouple or platinum resistance thermometer inputs.  CompoBus/S I/O Link Unit: Provides 8 inputs and 8 outputs as a CompoBus/S Slave.
Memory protection (See notes 1 and 2.)	HR area, AR area, program contents, read/write DM area contents, and counter values maintained during power interruptions.
Memory backup (See notes 1 and 2.)	Flash memory: Program, read-only DM area, and PC Setup  Battery backup: The read/write DM area, HR area, AR area, and counter values are backed up by a battery. (Battery life is approximately 5 years at 25°C.)
Self-diagnostic functions	CPU Unit failure (watchdog timer), I/O bus error, battery error, and memory failure
Program checks	No END instruction, programming errors (checked when operation is started)

- Note**
1. The DM area, HR area, AR area, and counter values are backed up by the CPU Unit's built-in battery. If the battery is discharged, the contents of these areas will be lost and the data values will revert to the defaults.
  2. The contents of the program area, read-only DM area (DM 6144 to DM 6599), and PC Setup (DM 6600 to DM 6655) are stored in flash memory. The contents of these areas will be read from flash memory the next time the power is turned ON, even if the backup battery is discharged. When data has been changed in any of these areas, write the new values to flash memory by switching the CPM2A to MONITOR or RUN mode, or by turning the power OFF and then ON again.

### 2-1-3 I/O Specifications

#### CPU Unit Input Specifications

Item	Inputs	Specification
Input voltage	All	24 VDC +10%/−15%
Input impedance	IN00000 to IN00001	2.7 kΩ
	IN00002 to IN00006	3.9 kΩ
	IN00007 and up	4.7 kΩ
Input current	IN00000 to IN00001	8 mA typical
	IN00002 to IN00006	6 mA typical
	IN00007 and up	5 mA typical
ON voltage/current	IN00000 to IN00001	17 VDC min., 5 mA
	IN00002 and up	14.4 VDC min., 3 mA
OFF voltage/current	All	5.0 VDC max., 1 mA
ON delay	All	1 to 80 ms max. Default: 10 ms (See note.)
OFF delay	All	1 to 80 ms max. Default: 10 ms (See note.)
Circuit configuration	IN00000 to IN00001	
	IN00002 to IN00006	
	IN00007 and up	

**Note** The input time constant can be set to 1, 2, 3, 5, 10, 20, 40, or 80 ms in the PC Setup.

#### High-speed Counter Inputs

Inputs IN00000 through IN00002 can be used as high-speed counter inputs, as shown in the following table. The maximum count frequency is 5 kHz in differential phase mode and 20 kHz in the other modes.

Input	Function			
	Differential phase mode	Pulse plus direction input mode	Up/down input mode	Increment mode
IN00000	A-phase pulse input	Pulse input	Increment pulse input	Increment pulse input
IN00001	B-phase pulse input	Direction input	Decrement pulse input	Normal input
IN00002	Z-phase pulse input or hardware reset input (IN00002 can be used as a normal input when it is not used as a high-speed counter input.)			

The minimum pulse widths for inputs IN00000 (A-phase input) and IN00001 (B-phase input) are as follows:

Pulse plus direction input mode, Up/down input mode, Increment mode

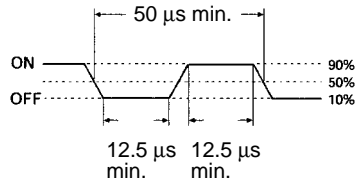

Differential phase mode

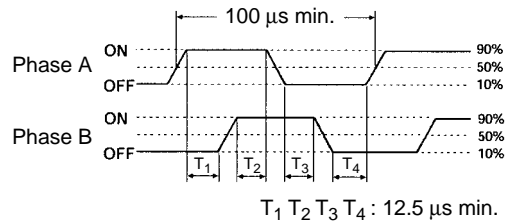

The minimum pulse width for input IN00002 (Z-phase input) is as follows:

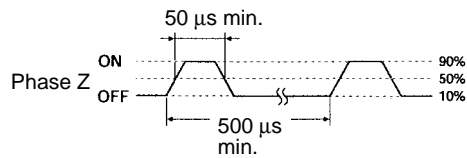

**Interrupt Inputs**

Inputs IN00003 through IN00006 can be used as interrupt inputs (interrupt input mode or counter mode) and quick-response inputs. The minimum pulse width for these inputs is 50 μs.

**Expansion I/O Unit Input Specifications**

Item	Specification
Input voltage	24 VDC $+10\%/_{-15\%}$
Input impedance	4.7 kΩ
Input current	5 mA typical
ON voltage	14.4 VDC min.
OFF voltage	5.0 VDC max.
ON delay	1 to 80 ms max. Default: 10 ms (See note.)
OFF delay	1 to 80 ms max. Default: 10 ms (See note.)
Circuit configuration	

**Note** The input time constant can be set to 1, 2, 3, 5, 10, 20, 40, or 80 ms in the PC Setup.

**Caution** Do not apply voltage in excess of the rated voltage to the input terminal. It may result in damage to the product or fire.

### CPU Unit and Expansion I/O Unit Output Specifications

#### Relay Outputs

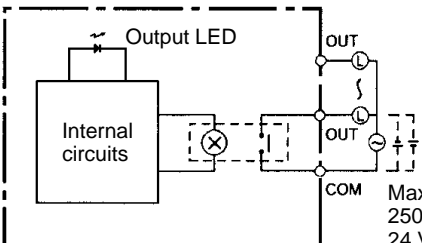
Item	Specification					
	20CDR-□	30CDR-□	40CDR-□	60CDR-□	8ER	20EDR1
Max. switching capacity	2 A, 250 VAC ( $\cos\phi = 1$ ) 2 A, 24 VDC (4 A/common)					
Min. switching capacity	10 mA, 5 VDC					
Service life of relay (See note.)	Electrical: 150,000 operations (24-VDC resistive load) 100,000 operations (240-VAC inductive load, $\cos\phi = 4$ ) Mechanical: 20,000,000 operations					
ON delay	15 ms max.					
OFF delay	15 ms max.					
Circuit configuration						

**Note** The service life of relay output contacts shown in the table assumes the worst conditions. The following graph shows the results of OMRON's service life tests at a switching rate of 1,800 times/hour.

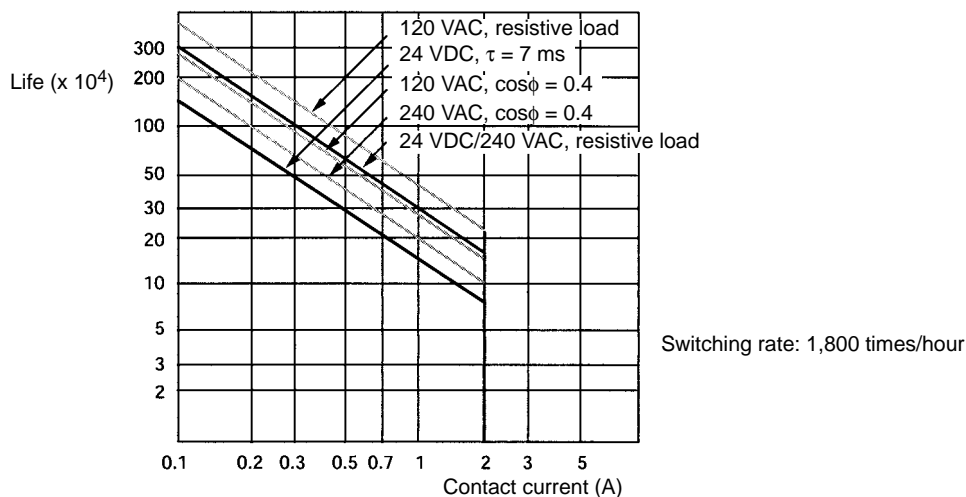

Transistor Outputs (Sinking or Sourcing)

Item	Specification					
	20CDT-D 20CDT1-D	30CDT-D 30CDT1-D	40CDT-D 40CDT1-D	60CDT-D 60CDT1-D	8ET 8ET1	20EDT 20EDT1
Max. switching capacity	OUT01000 and OUT01001: 4.5 to 30 VDC, 0.2 A/output (See note 1.)					24 VDC $+10\%/-5\%$ , 0.3 A/output
	OUT01002 and up: 4.5 to 30 VDC, 0.3 A/output					
	0.8 A/common 1.6 A/Unit (See note 2.)	0.8 A/common 2.4 A/Unit (See note 2.)	0.8 A/common 3.2 A/Unit (See note 2.)	0.8 A/common 4.8 A/Unit (See note 2.)	0.9 A/common 1.8 A/Unit (See note 2.)	0.9 A/common 1.8 A/Unit
Leakage current	0.1 mA max.					
Residual voltage	1.5 V max.					
ON delay	OUT01000 and OUT01001: 20 $\mu$ s max. OUT01002 and up: 0.1 ms max.					0.1 ms max.
OFF delay	OUT01000 and OUT01001: 40 $\mu$ s max. for 4.5 to 26.4 V, 10 to 100 mA 0.1 ms max. for 4.5 to 30 V, 10 to 200 mA OUT01002 and up: 1 ms max.					1 ms max. (24 VDC $+10\%/-5\%$ , 5 to 300 mA)
Fuse	1 fuse/output (cannot be replaced by user)					1 fuse/common (cannot be replaced by user)
Circuit configuration	<p><b>Sinking Outputs</b></p>			<p><b>Sourcing Outputs</b></p>		

- Note**
1. When using OUT01000 or OUT01001 as a pulse output, connect a dummy resistor as required to bring the load current between 0.01 and 0.1 A. If the load current is below 0.1 A, the ON-to-OFF response time will be shorter and high-speed pulses (source-type transistor outputs) will not be output. If the load current is above 0.1 A, the transistor will generate more heat and components may be damaged.
  2. The total for OUT01000 to OUT 01003 must be 0.8 A maximum. If the ambient temperature is maintained below 50 °C, however, up to 0.9 A/common can be used.

 **Caution** Do not apply voltage in excess of the maximum switching capacity to an output terminal. It may result in damage to the product or fire.

## 2-2 Unit Components

### 2-2-1 CPU Unit Components

#### CPU Units with 20 or 30 I/O Terminals

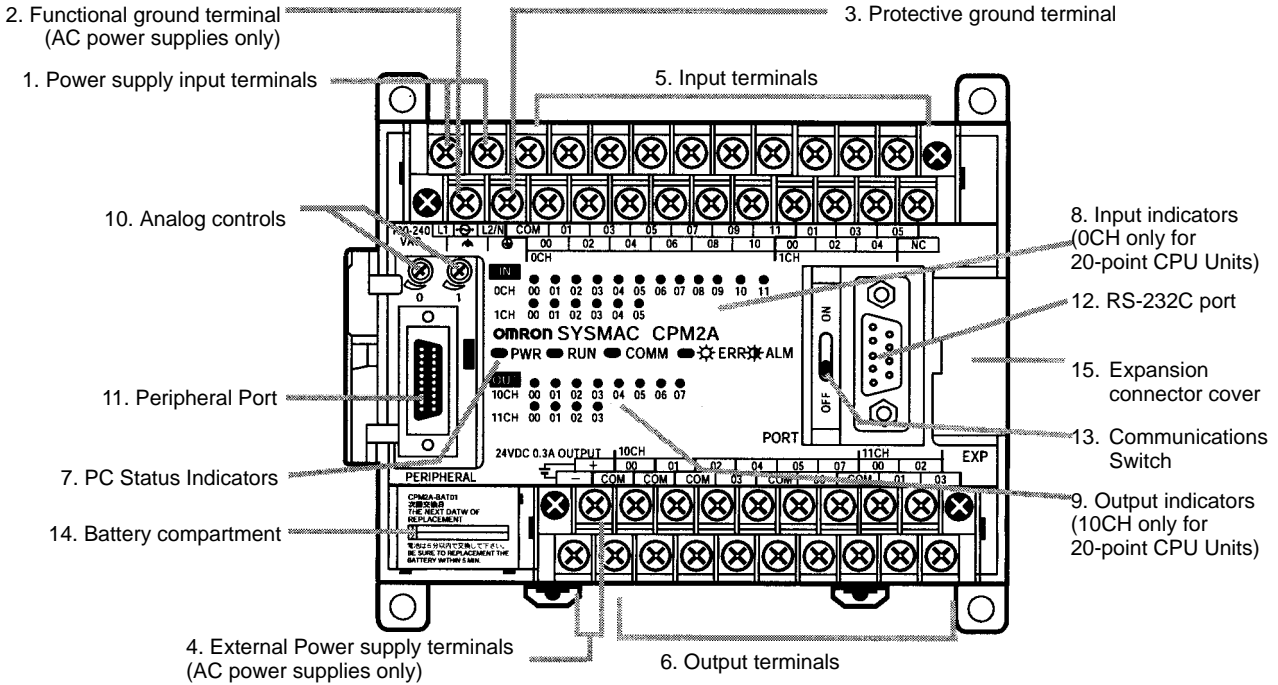

#### CPU Units with 40 I/O Terminals

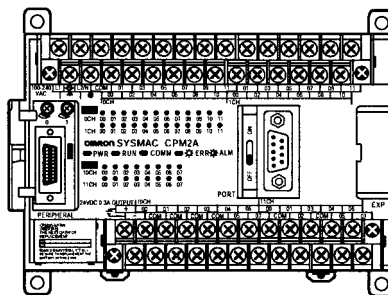

#### CPU Units with 60 I/O Terminals

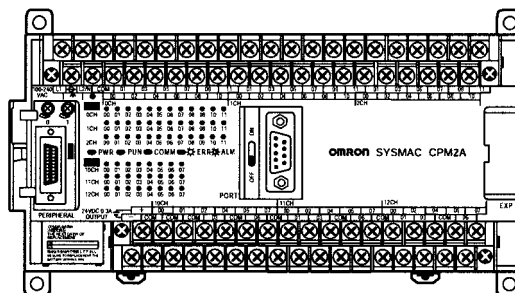



**CPU Unit Component Descriptions**

- 1, 2, 3... 1. Power Supply Input Terminals  
Connect the power supply (100 to 240 VAC or 24 VDC) to these terminals.
2. Functional Ground Terminal (⏏)  
Be sure to ground this terminal (AC-type PCs only) to enhance immunity to noise and reduce the risk of electric shock.
3. Protective Ground Terminal (⏏)  
Be sure to ground this terminal to reduce the risk of electric shock.
4. External Power Supply Terminals  
CPM2A PCs are equipped with these 24-VDC power output terminals to supply power to input devices. (AC-type PCs only.)
5. Input Terminals  
Connects the CPU Unit to external input devices.
6. Output Terminals  
Connects the CPU Unit to external output devices.
7. PC Status Indicators  
These indicators show the operating status of the PC, as shown in the following table.

Indicator	Status	Meaning
PWR (green)	ON	Power is being supplied to the PC.
	OFF	Power isn't being supplied to the PC.
RUN (green)	ON	The PC is operating in RUN or MONITOR mode.
	OFF	The PC is in PROGRAM mode or a fatal error has occurred.
COMM (yellow)	Flashing	Data is being transferred via the Peripheral port or RS-232C port.
	OFF	Data isn't being transferred via the Peripheral port or RS-232C port.
ERR/ALARM (red)	ON	A fatal error has occurred. (PC operation stops.)
	Flashing	A non-fatal error has occurred. (PC operation continues.)
	OFF	Indicates normal operation.

8. Input Indicators  
The input indicators are lit when the corresponding input terminal is ON. The indicators are lit during I/O refreshing.

When a fatal error occurs, the input indicators change as follows:

Fatal error	Input indicators
CPU Unit error, I/O bus error, or too many I/O Units	Turn OFF.
Memory error or FALS (fatal system) error	The indicators will change with the status of the input signal, but input status will not be updated in memory.

- Note** a) When interrupt inputs are used in interrupt input mode, the indicator may not light even when the interrupt condition is met if the input is not ON long enough.
- b) When high-speed counters are used, the input indicator may not light if the input pulse is too fast.

9. Output Indicators  
The output indicators are lit when the corresponding output terminal is ON. The indicators are lit during I/O refreshing. When pulse outputs are being used, the indicator will remain lit continuously while the pulses are being output.

10. Analog Controls

Turn these controls to change the analog settings (0 to 200) in IR 250 and IR 251.

11. Peripheral Port

Connects the PC to a Programming Device (including Programming Consoles), host computer, or standard external device.

12. RS-232C Port

Connects the PC to a Programming Device (excluding Programming Consoles), host computer, Programmable Terminal, or standard external device.

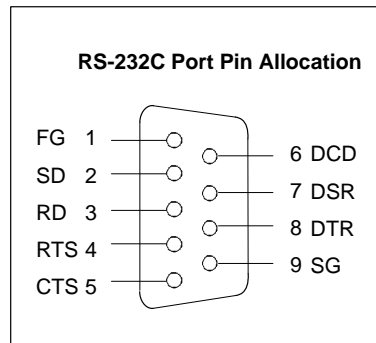

13. Communications Switch

This switch selects whether the Peripheral port and RS-232C port will use the communications settings in the PC Setup or the standard settings.



OFF	The Peripheral port and RS-232C port operate according to the communications settings in the PC Setup, except for a Programming Console connected to the Peripheral port.
ON	The Peripheral port and RS-232C port operate according to the standard communications settings, except for Programming Consoles connected to the Peripheral port.

**Note** This switch's setting has no effect on communications with a Programming Console connected to the Peripheral port. It affects the RS-232C port.

14. Battery

This battery backs up memory in the CPU Unit and is connected when the Unit is shipped.

15. Expansion Connector

Connects the PC's CPU Unit to an Expansion I/O Unit or Expansion Unit (Analog I/O Unit, Temperature Sensor Unit, or CompoBus/S I/O Link Unit). Up to 3 Expansion Units or Expansion I/O Units can be connected to a CPU Unit.

**Note** If an NT-AL001 is connected to the CPM2A's RS-232C port, only one Expansion Unit or Expansion I/O Unit can be connected to the CPU Unit because the NT-AL001 draws its 5-VDC power from the CPU Unit.

## 2-2-2 Expansion I/O Unit Components

Expansion I/O Unit with 20 I/O Terminals

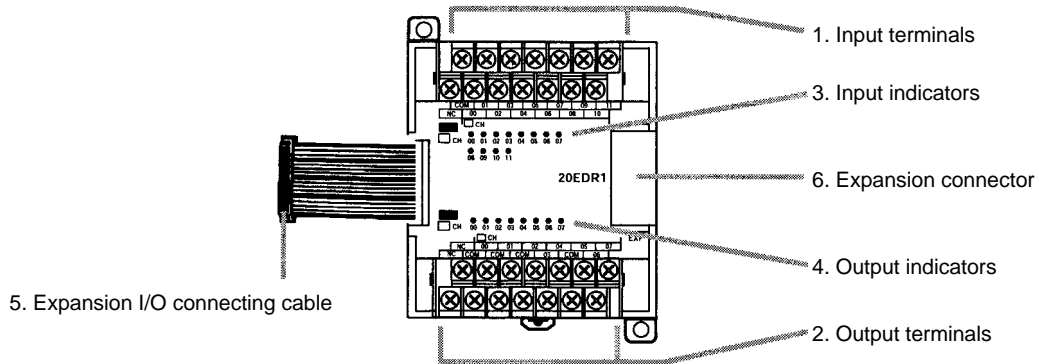

Expansion I/O Unit with 8 Input Terminals

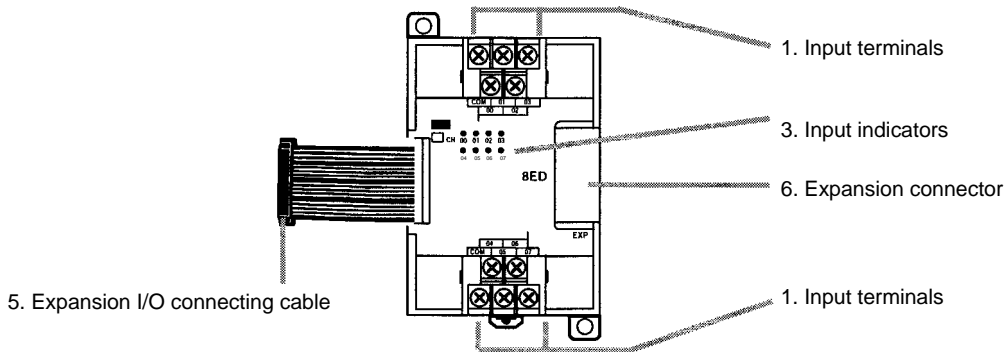

Expansion I/O Unit with 8 Output Terminals

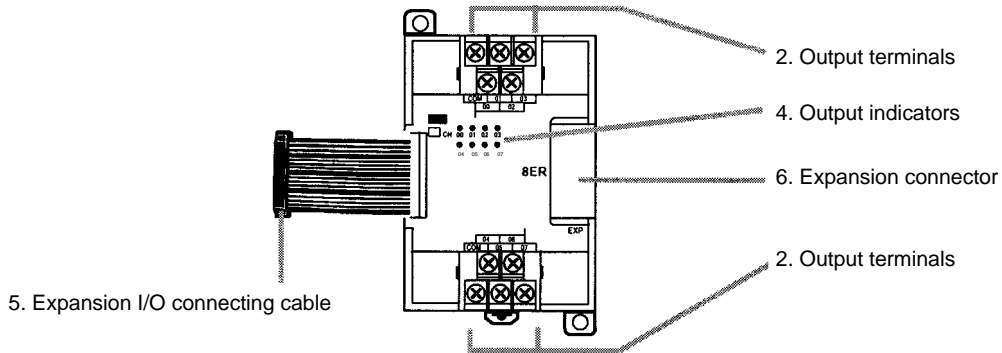

- 1, 2, 3...**
1. Input Terminals  
Connects the CPU Unit to external input devices.
  2. Output Terminals  
Connects the CPU Unit to external output devices.
  3. Input Indicators  
The input indicators are lit when the corresponding input terminal is ON.
  4. Output Indicators  
The output indicators are lit when the corresponding output terminal is ON.
  5. Expansion I/O Connecting Cable  
Connects the Expansion I/O Unit to the expansion connector on the PC's CPU Unit, an Expansion Unit, or another Expansion I/O Unit.

**Caution** Do not touch the expansion I/O connecting cable while the power is being supplied in order to prevent any malfunction due to static electricity.

6. Expansion Connector

Connects to another Expansion I/O Unit or an Expansion Unit (Analog I/O Unit, Temperature Sensor Unit, or CompoBus/S I/O Link Unit). Up to 3 Expansion Units or Expansion I/O Units can be connected to a CPU Unit.

### 2-2-3 Analog I/O Unit Components

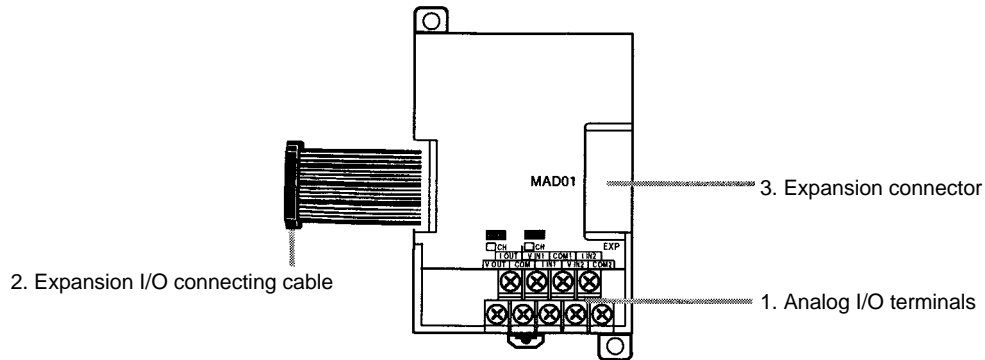

**1, 2, 3...** 1. Analog I/O Terminals  
Connects the Unit to analog input devices and analog output devices.

2. Expansion I/O Connecting Cable  
Connects the Analog I/O Unit to the expansion connector on the PC's CPU Unit, an Expansion I/O Unit, or another Expansion Unit. The cable is connected to the Analog I/O Unit and cannot be removed.

**Caution** Do not touch the expansion I/O connecting cable while the power is being supplied in order to prevent any malfunction due to static electricity.

3. Expansion Connector

Connects to an Expansion I/O Unit or another Expansion Unit (Analog I/O Unit, Temperature Sensor Unit, or CompoBus/S I/O Link Unit). Up to 3 Expansion Units or Expansion I/O Units can be connected to a CPU Unit.

### 2-2-4 Temperature Sensor Unit Components

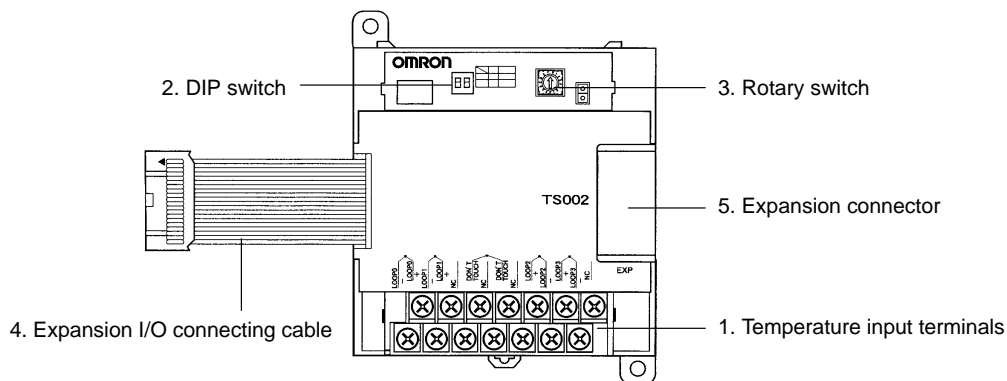

**1, 2, 3...** 1. Temperature Input Terminals  
Connect to a thermocouple or a platinum resistance thermometer.

2. DIP Switch

Sets the temperature unit (°C or °F), and the number of decimal places used.

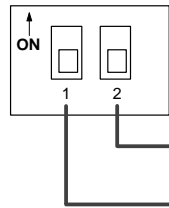

Number of decimal places used  
 OFF: Normal (0 or 1); ON: 2  
 Temperature unit  
 OFF: °C; ON: °F

3. Rotary Switch

Sets the temperature range. Set the range in accordance with the specifications of the temperature sensor used.

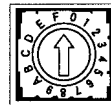

CPM1A-TS001/002

Set value	Thermocouple	Range (°C)	Range (°F)
0	K	-200 to 1,300	-300 to 2,300
1		0.0 to 500.0	0.0 to 900.0
2	J	-100 to 850	-100 to 1,500
3		0.0 to 400.0	0.0 to 750.0
4 to F	---	Setting not possible	

CPM1A-TS101/102

Set value	Platinum resistance thermometer	Range (°C)	Range (°F)
0	Pt100	-200.0 to 650.0	-300.0 to 1,200.0
1	JPt100	-200.0 to 650.0	-300.0 to 1,200.0
2 to F	---	Setting not possible	

4. Expansion I/O Connecting Cable

Connects the Temperature Sensor Unit to the expansion connector on the PC's CPU Unit, an Expansion I/O Unit, or another Expansion Unit. The cable is connected to the Temperature Sensor Unit and cannot be removed.



**Caution** Do not touch the expansion I/O connecting cable while the power is being supplied in order to prevent any malfunction due to static electricity.

5. Expansion Connector

Connects to an additional Expansion I/O Unit or another Expansion Unit.

### 2-2-5 CompoBus/S I/O Link Unit Components

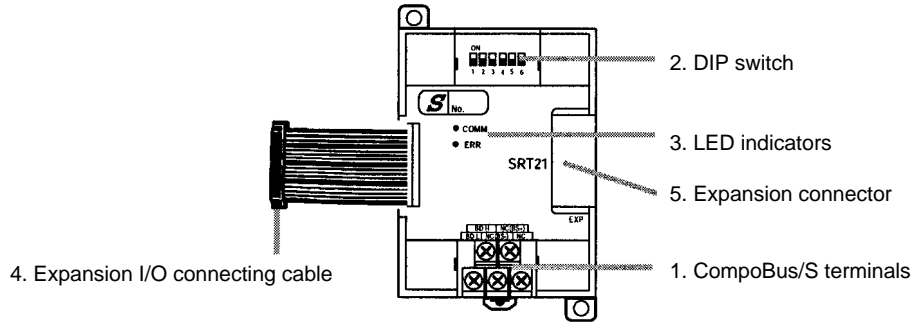

**1, 2, 3...** 1. CompoBus/S Terminals

Include the CompoBus/S communications data high/low terminal, communications power supply +/- terminals, and NC terminals. Power is supplied to the Unit internally, so the power supply terminals can be used as relay terminals.

2. DIP Switch

The DIP switch sets the Unit's node address, sets the communications mode, and determines whether or not the outputs will be cleared in the event of a communications error.

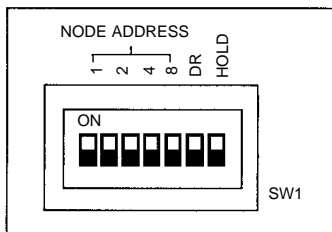

Pin(s)	Function
1 to 4 (labeled 1, 2, 4, and 8)	These pins set the Unit's node address using the DIP switch pins as binary digits. (1 = ON)
	0: 0000      1: 0001      2: 0010      3: 0011 4: 0100      5: 0101      6: 0110      7: 0111 8: 1000      9: 1001      10: 1010      11: 1011 12: 1100      13: 1101      14: 1110      15: 1111
DR	ON: Long-distance Communications Mode OFF: High-speed Communications Mode (See note.)
HOLD	ON: Retain outputs when a communications error occurs. OFF: Clear outputs when a communications error occurs.

**Note** The Long-distance Communications Mode can be used only when connected to one of the following Master Units: C200HW-SRM21-V1, CQM1-SRM21-V1, or SRM1-C0□-V2.

3. LED Indicators

These indicators show the status of CompoBus/S communications.

Indicator	Status	Meaning
COMM (yellow)	ON	Communications in progress.
	OFF	Communications error or stopped.
ERR (red)	ON	A communications error has occurred.
	OFF	Indicates normal or no communications.

4. Expansion I/O Connecting Cable

Connects the CompoBus/S I/O Link Unit to the expansion connector on the PC's CPU Unit, an Expansion I/O Unit, or another Expansion Unit.



**Caution** Do not touch the expansion I/O connecting cable while the power is being supplied in order to prevent any malfunction due to static electricity.

5. Expansion Connector

Connects to an Expansion I/O Unit or another Expansion Unit (Analog I/O Unit, Temperature Sensor Unit, or CompoBus/S I/O Link Unit). Up to 3 Expansion Units or Expansion I/O Units can be connected to a CPU Unit.

# SECTION 3

## Installation and Wiring

This section provides information on installing and wiring a CPM2A PC. Be sure to follow the directions and precautions in this section when installing the CPM2A in a panel or cabinet, wiring the power supply, or wiring I/O.

3-1	Design Precautions . . . . .	44
3-1-1	Power Supply Wiring . . . . .	44
3-1-2	Power Supply Voltage . . . . .	44
3-1-3	Interlock and Limit Circuits . . . . .	44
3-2	Selecting an Installation Site . . . . .	44
3-2-1	Installation Site Conditions . . . . .	45
3-2-2	Panel/Cabinet Installation . . . . .	45
3-3	Installing the CPM2A . . . . .	46
3-3-1	CPM2A Orientation . . . . .	46
3-3-2	CPM2A Installation . . . . .	46
3-3-3	Connecting an Expansion Unit or Expansion I/O Unit . . . . .	48
3-4	Wiring and Connections . . . . .	49
3-4-1	General Precautions for Wiring . . . . .	49
3-4-2	Removing the Terminal Block . . . . .	50
3-4-3	Ground Wiring . . . . .	51
3-4-4	Power Supply Wiring . . . . .	52
3-4-5	Input Wiring . . . . .	54
3-4-6	Output Wiring . . . . .	62
3-4-7	Programming Device Connections . . . . .	76
3-4-8	Host Link Connections . . . . .	77
3-4-9	No-Protocol Communications . . . . .	80
3-4-10	OMRON PT Connections . . . . .	80
3-4-11	One-to-one PC Link Connections . . . . .	81
3-4-12	CompoBus/S I/O Link Connections . . . . .	81

### 3-1 Design Precautions

Observe the following precautions when designing a system incorporating a CPM2A PC.

#### 3-1-1 Power Supply Wiring

Separate the power supply wiring from the control system, CPM2A system, and DC I/O system wiring. Separate the control circuits that supply power to the main Unit from the main circuits using dedicated circuit protectors and fuses.

#### 3-1-2 Power Supply Voltage

**Caution** Use the power supply voltages indicated in *Section 2 Unit Specifications and Components*. Failure to adhere to the specifications may result in fire. If the power supply voltage falls below 85% of the rated voltage, the CPM2A will stop and all outputs will be turned OFF. If low voltage affects the equipment, etc., provide a protection circuit which shuts off the output until the supply voltage returns to the rated value. In places where power supply conditions are poor, take steps to ensure that power is supplied at the rated voltage. Be sure to adhere to safety precautions, such as providing breakers to prevent short circuits in external wiring. When conducting any of the following operations, turn OFF the power to the PC. Electrocutation, product damage and malfunction may result.

- Connecting or disconnecting Expansion Units, Expansion I/O Units, and CPU Units.
- Assembling Units
- Connecting cables and wiring.

#### 3-1-3 Interlock and Limit Circuits

**WARNING** Emergency stop circuits, interlock circuits, limit circuits, and similar safety measures must be provided in external control circuits (i.e., not in the Programmable Controller) to ensure safety in the system if an abnormality occurs due to malfunction of the PC or another external factor affecting the PC operation. Not providing proper safety measures may result in serious accidents.

The following diagram shows an example of an interlock circuit.

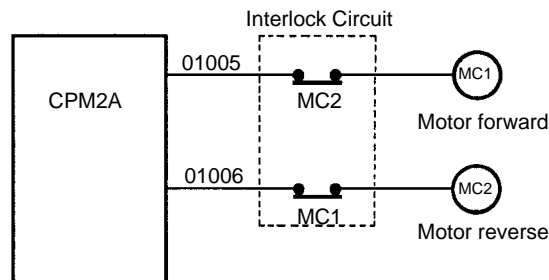

In the interlock circuit above, MC1 and MC2 can't be ON at the same time even if CPM2A outputs 01005 and 01006 are both ON (an incorrect PC operation).

### 3-2 Selecting an Installation Site

The CPM2A is resistant to harsh conditions and highly reliable, but installing the PC in a favorable site will maximize its reliability and operating lifetime.



**Caution** Be sure to install the CPM2A correctly, as outlined in this manual. Failure to do so may result in Unit malfunction.

### 3-2-1 Installation Site Conditions

**Note** Do not install the CPM2A under any of the following conditions.

- Locations subject to direct sunlight.
- Locations subject to a temperature below 0°C or over 55°C.
- Locations subject to a humidity below 10% or over 90%.
- Locations subject to condensation as the result of severe changes in temperature.
- Locations subject to corrosive or flammable gases.
- Locations subject to dust (especially iron dust) or salts.
- Locations subject to shock or vibration.
- Locations subject to exposure to water, oil, or chemicals.

Be sure that the conditions at the installation site conform to the CPM2A's general specifications. Refer to 2-1-1 *General Specifications* for details.

**Note** Provide proper shielding when installing in the following locations:

- Locations subject to static electricity or other sources of noise.
- Locations subject to strong electromagnetic fields.
- Locations subject to possible exposure to radiation.
- Locations near to power supply lines.

### 3-2-2 Panel/Cabinet Installation

Consider PC operation, maintenance, and surrounding conditions when installing the CPM2A in a panel or cabinet.

#### Overheating

The operating temperature range for the CPM2A is 0°C to 55°C. Be sure that there is adequate ventilation for cooling.

- Allow enough space for air circulation.
- Do not install the CPM2A above equipment that generates a large amount of heat, such as heaters, transformers, or large resistors.
- Install a cooling fan or system when the ambient temperature exceeds 55°C.

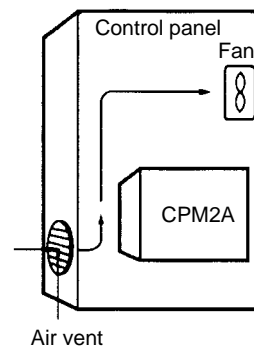

#### Electrical Noise

Power lines and high-voltage equipment can cause electrical noise in the PC.

- Do not install the CPM2A in a panel or cabinet with high-voltage equipment.
- Allow at least 200 mm between the CPM2A and nearby power lines.

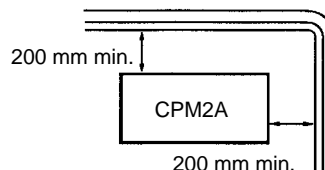

**Accessibility**

- Ensure that the CPM2A can be accessed for normal operation and maintenance.
- Provide a clear path to the CPM2A for operation and maintenance. High-voltage equipment or power lines could be dangerous if they are in the way during routine operations.
  - The PC will be easiest to access if the panel or cabinet is installed about 3 to 5 feet above the floor.

### 3-3 Installing the CPM2A

This section describes how to install the CPM2A and connect Expansion Units and Expansion I/O Units. Refer to *Appendix B* for diagrams showing the dimensions of the Units.

#### 3-3-1 CPM2A Orientation

The CPM2A must be installed in the position shown below to ensure adequate cooling.

**Correct**

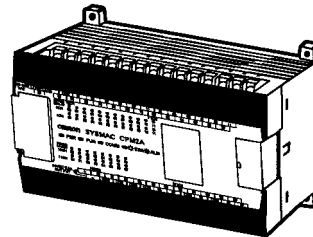

Do not install the CPM2A in either of the following positions.

**Incorrect**

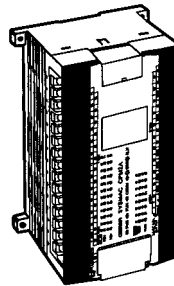

**Incorrect**

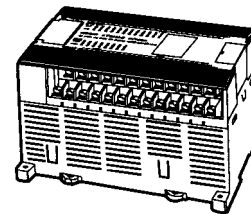

#### 3-3-2 CPM2A Installation

The CPM2A can be installed on a horizontal surface or on a DIN track.

**Surface Installation**

Use the following pattern when installing a CPM2A CPU Unit, Expansion Unit, or Expansion I/O Unit on a vertical surface. (Use M4 dia. x 15 screws.)

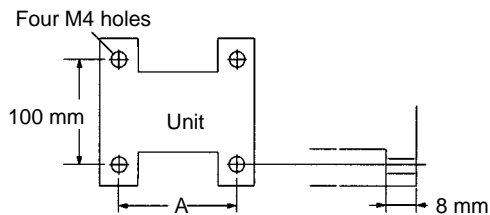

The width (A) between the mounting holes depends on the Unit.

Unit	Width (A) (tolerance: ±0.2 mm)
CPU Unit with 20/30 I/O terminals	120 mm
CPU Unit with 40 I/O terminals	140 mm

Unit	Width (A) (tolerance: ±0.2 mm)
CPU Unit with 60 I/O terminals	185 mm
Expansion I/O Unit with 20 I/O terminals	76 mm
Expansion I/O Unit with 8 input terminals	56 mm
Expansion I/O Unit with 8 output terminals	56 mm
Analog I/O Unit	56 mm
CompoBus/S I/O Link Unit	56 mm
RS-232C Adapter	21 mm
RS-422 Adapter	21 mm
Temperature Sensor Unit	76 mm

Allow 10 to 15 mm between the Units when installing an Expansion Unit, Expansion I/O Unit, or Communications Adapter next to the CPU Unit.

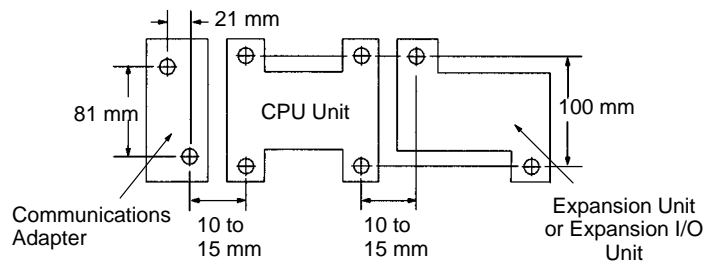

**DIN Track Installation**

The CPM2A can be installed on a 35-mm DIN Track.

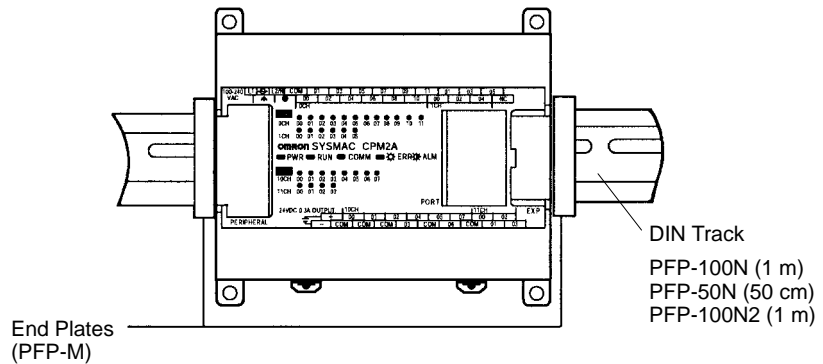

**Installation**

Lower the CPM2A so that the notch on the back of the PC catches the top of the DIN Track. Push the PC forward until the lock snaps into place.

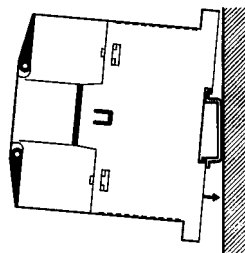

**Removal**

Pry the lock down with a flat-blade screwdriver and pivot the PC upward to remove it.

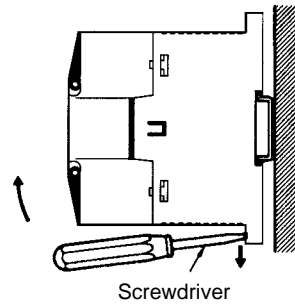

**3-3-3 Connecting an Expansion Unit or Expansion I/O Unit**

Up to 3 Expansion Units or Expansion I/O Units can be connected to a CPM2A CPU Unit. Use the following procedure when connecting an Expansion Unit or Expansion I/O Unit.

- 1, 2, 3... 1. Remove the cover from the CPU Unit's or the Expansion I/O Unit's expansion connector. Use a flat-blade screwdriver to remove the cover from the Expansion I/O Connector.

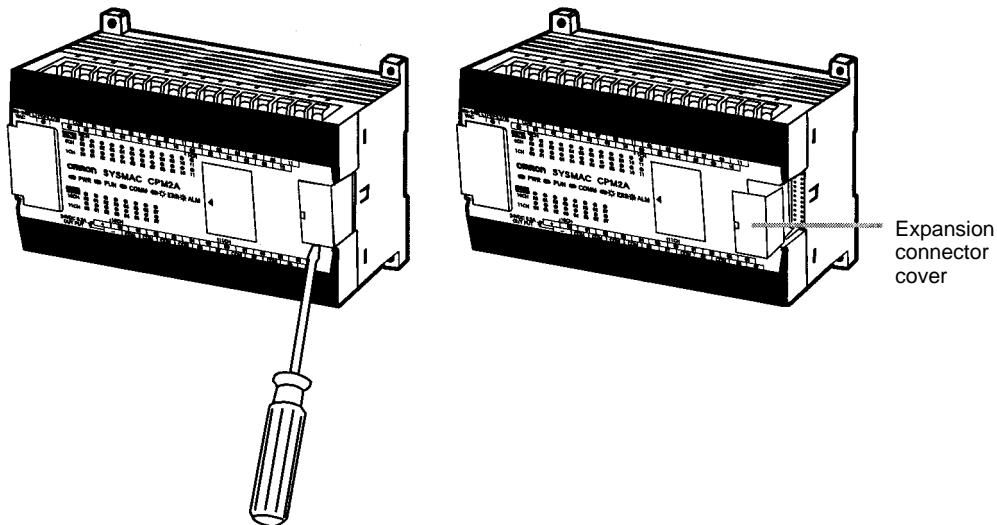

2. Insert the Expansion I/O Unit's connecting cable into the CPU Unit's or the Expansion I/O Unit's expansion connector.

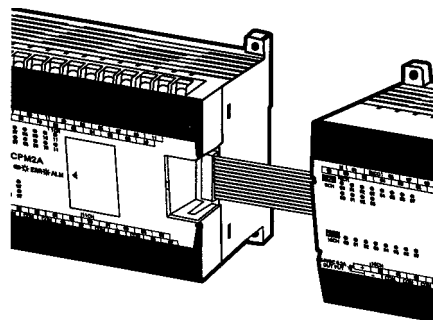

3. Replace the cover on the CPU Unit's or the Expansion I/O Unit's expansion connector.

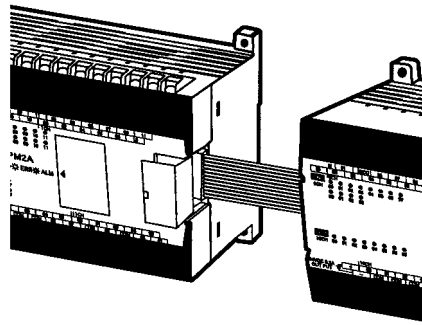

### 3-4 Wiring and Connections

This section provides basic information on wiring the Power Supply Unit, Expansion Units, and Expansion I/O Units, and on connecting Programming Devices.

#### 3-4-1 General Precautions for Wiring

- Caution** Leave the protective label in place while wiring. The Unit may malfunction if strands of wire get inside the Unit. After completing wiring be sure to remove the label to avoid overheating.

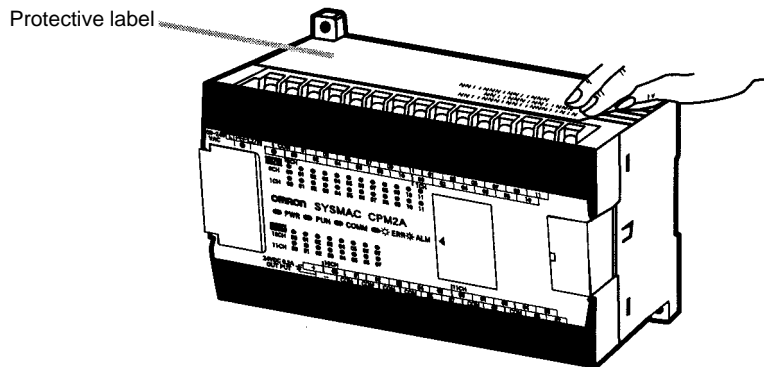

#### I/O Line Noise

Do not run CPM2A I/O lines in the same duct or conduit as power lines.

#### Hanging Ducts

Leave at least 300 mm between the power cables and the I/O or control wiring, as shown in the following diagram.

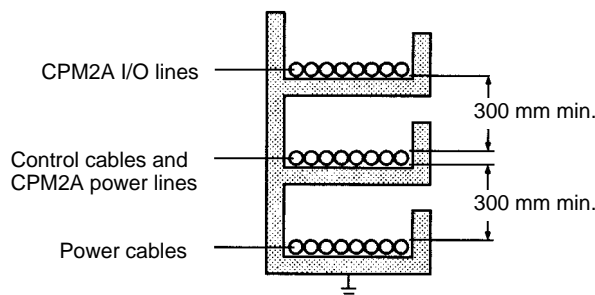

**Floor Ducts**

Leave at least 200 mm between the wiring and the top of the duct, as shown in the following diagram.

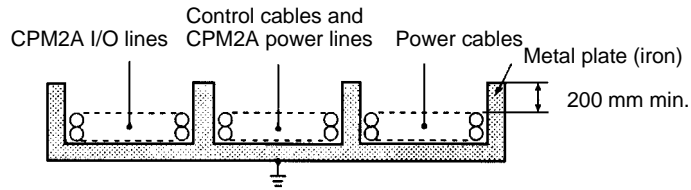

**Conduits**

Separate the CPM2A I/O lines, power and control lines, and power cables, as shown in the following diagram.

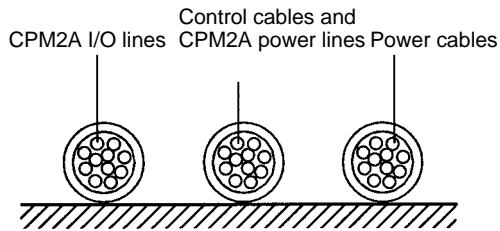

**3-4-2 Removing the Terminal Block**

The terminal block on the CPM2A CPU Unit can be removed. Use the following procedure.

The terminal blocks on the Expansion Units and Expansion I/O Units cannot be removed.

- 1, 2, 3... 1. Loosen the black screws at the ends of the terminal block as shown in the following diagram.

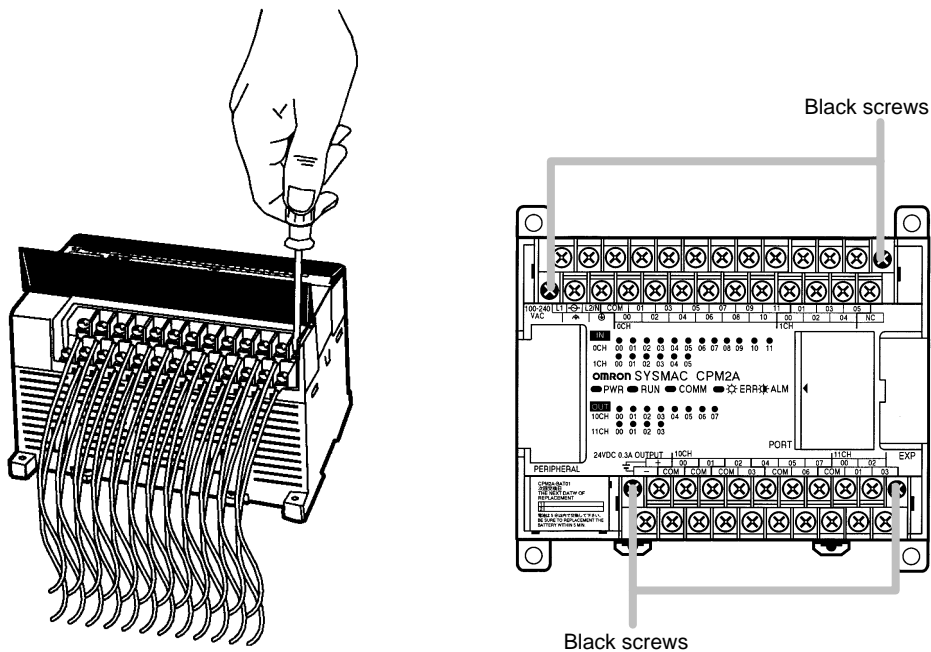

2. Lift the terminal block off the CPU Unit.

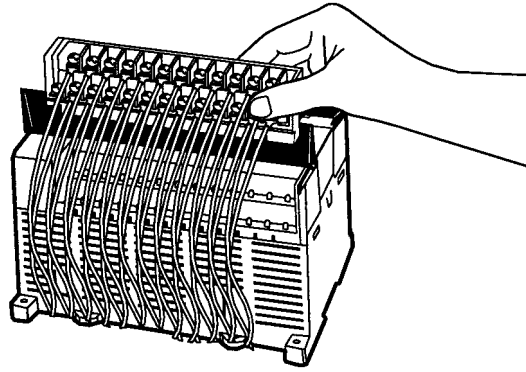

### 3-4-3 Ground Wiring

#### Grounding

Be sure to ground the earth terminal to less than 100 Ω in order to protect against electric shock and incorrect operation from electrical noise. Be sure to use a wire of at least 1.25 mm<sup>2</sup> for grounding.

**! WARNING** During installation, be sure to ground to 100 Ω max.

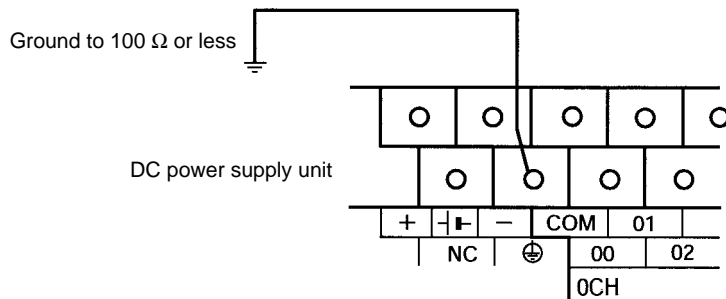
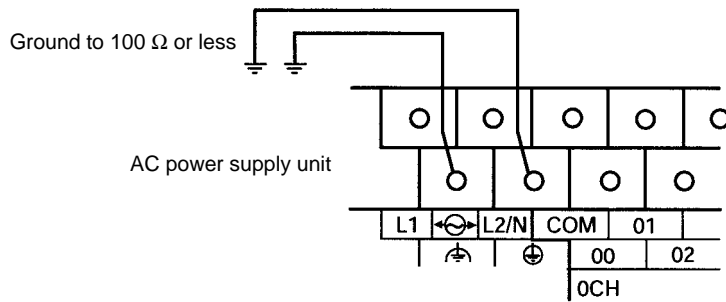

**Note** Always disconnect the functional earth terminal before conducting a withstand voltage test.

#### Crimp Terminals

**! Caution** Always use crimp terminals for the CPM2A's ground lines or use solid wire (instead of a stranded wire). Do not connect bare stranded wires directly to terminals. Stray wire strands can short-circuit and cause a fire.

Use M3 crimp terminals and tighten the terminal screws to a torque of 0.5 N • m.

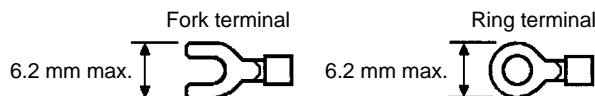

The recommended wire size for solid wires is 0.4 to 1.2 mm (AWG26 to AWG18).

### 3-4-4 Power Supply Wiring

#### 100- to 240-VAC Power Supply

Wire a separate circuit for the CPM2A's power supply circuit so that there isn't a voltage drop from the inrush current that flows when other equipment is turned on.

When several CPM2A PCs are being used, it is recommended to wire the PCs on separate circuits to prevent a voltage drop from the inrush current or incorrect operation of the circuit breaker.

Use twisted power supply wires to prevent noise from the power supply lines. Adding a 1:1 isolating transformer reduces electrical noise even further.

Considering the possibility of voltage drops and the allowable current, be sure to use thick power lines.

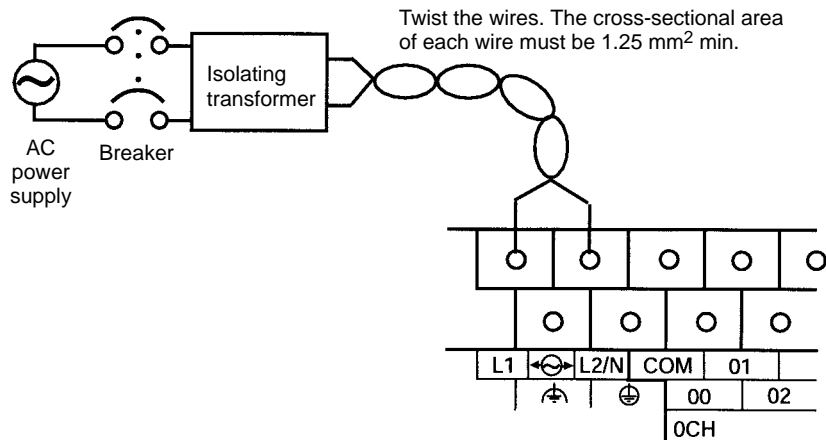

- Note**
1. Before connecting the power supply, make sure that the CPU Unit requires an AC power supply and not a DC power supply. The CPU Unit's internal circuitry will be damaged if AC power is mistakenly supplied to a CPU Unit that requires a DC power supply.
  2. The power supply input terminals are at the top of the CPU Unit; the terminals at the bottom of the CPU Unit output 24-VDC power for external devices. The CPU Unit's internal circuitry will be damaged if AC power is mistakenly supplied to a CPU Unit's power supply output terminals.

**Caution** Tighten the terminal block screws of the AC Power Supply to the torque of 0.5 N • m. Loose screws may result in fire or malfunction.

#### Crimp Terminals

**Caution** Always use crimp terminals for the CPM2A's power lines. Do not connect bare stranded wires directly to terminals. Stray wire strands can short-circuit and cause a fire.

Use M3 crimp terminals and tighten the terminal screws to a torque of 0.5 N • m. Connect a ring terminal to each terminal screw.

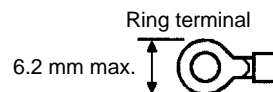



**24-VDC Power Supply**

Use a DC power supply with sufficient capacity and low ripple.

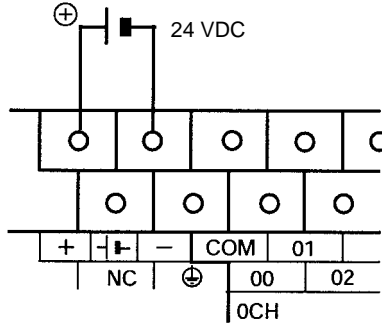

- Note**
1. Do not perform a dielectric test on the DC power supply terminals on the CPU Unit. The test might damage the PC's internal components.
  2. When equipment must conform to the EC Directives (Low-voltage Directives), use a power supply with double insulation or reinforced insulation.

**Crimp Terminals**

 **Caution** Always use crimp terminals for the CPM2A's power lines or use solid wire (instead of a stranded wire). Do not connect bare stranded wires directly to terminals. Stray wire strands can short-circuit and cause a fire.

Use M3 crimp terminals and tighten the terminal screws to a torque of 0.5 N • m.

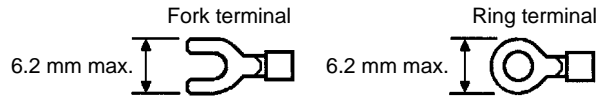

The recommended wire size for solid wires is 0.4 to 1.2 mm (AWG26 to AWG18).

### 3-4-5 Input Wiring

Wire the inputs to the CPM2A's CPU Unit and Expansion I/O Units as shown in the following diagrams. Use crimp terminals or solid wires (not stranded wire) to connect to the PC. The power supply output terminals can be used with CPU Units with AC power supplies.

**Note** When equipment must conform to the EC Directives (Low-voltage Directives), use a power supply with double insulation or reinforced insulation.

#### Input Configuration

The following diagrams show the input configurations.

**Note** Refer to *Section 3 Memory Areas* in the *Programming Manual (W353)* for details on the allocation of input bits in CPM2A PCs.

#### CPM2A-20CDR-□, CPM2A-20CDT-D, and CPM2A-20CDT1-D

Terminals 00 through 11 of "0CH" correspond to bits IR 00000 through IR 00011.

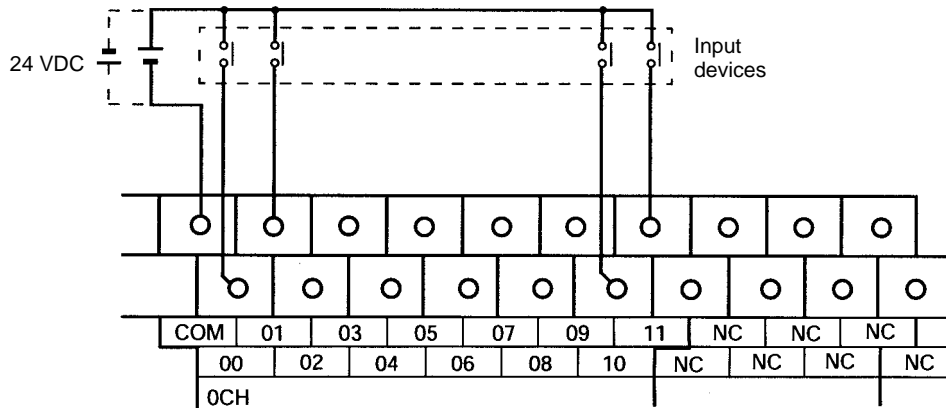

#### CPM2A-30CDR-□, CPM2A-30CDT-D, and CPM2A-30CDT1-D

Terminals 00 through 11 of "0CH" correspond to bits IR 00000 through IR 00011, terminals 00 through 05 of "1CH" correspond to bits IR 00100 through IR 00105.

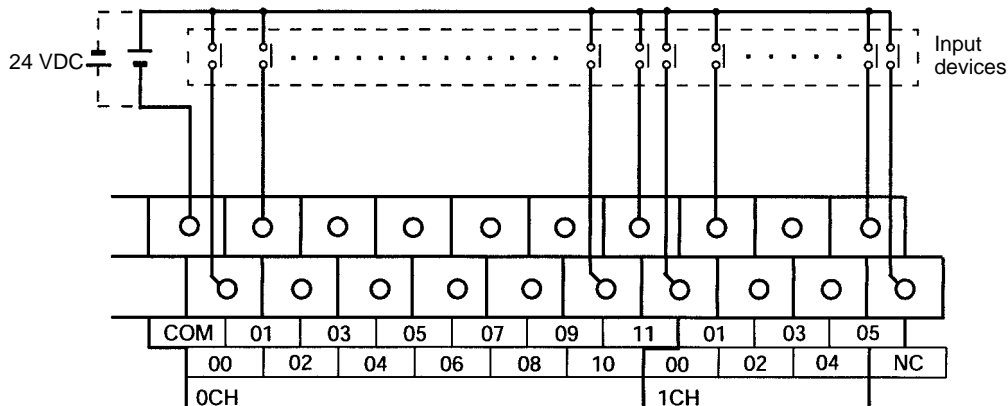

**CPM2A-40CDR-□, CPM2A-40CDT-D, and CPM2A-40CDT1-D**

Terminals 00 through 11 of "0CH" correspond to bits IR 00000 through IR 00011, terminals 00 through 11 of "1CH" correspond to bits IR 00100 through IR 00111.

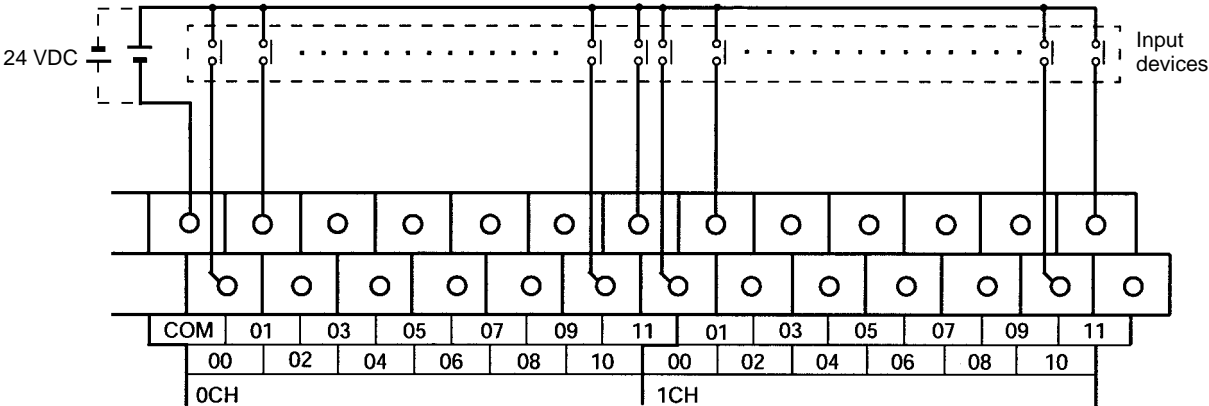

**CPM2A-60CDR-□, CPM2A-60CDT-D, and CPM2A-60CDT1-D**

Terminals 00 through 11 of "0CH" correspond to bits IR 00000 through IR 00011, terminals 00 through 11 of "1CH" correspond to bits IR 00100 through IR 00111, terminals 00 through 11 of "2CH" correspond to bits IR 00200 through IR 00211.

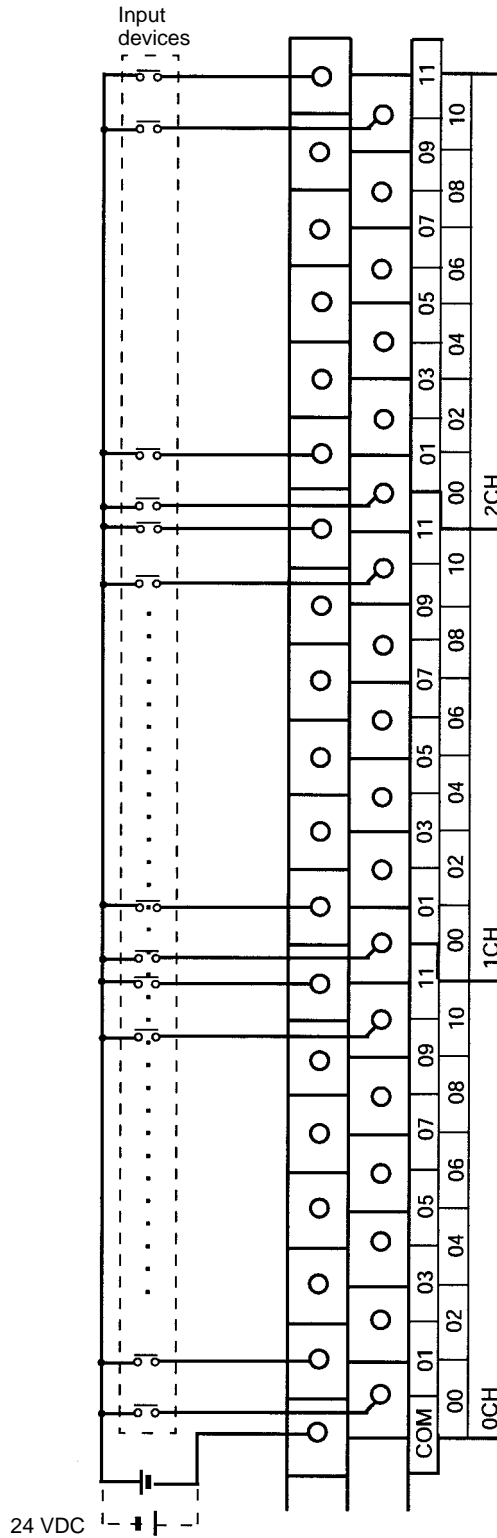

**CPM1A-20EDR1, CPM1A-20EDT, and CPM1A-20EDT1**

Terminals 00 through 11 of "mCH" correspond to bits 00 through 11 of word IR m.

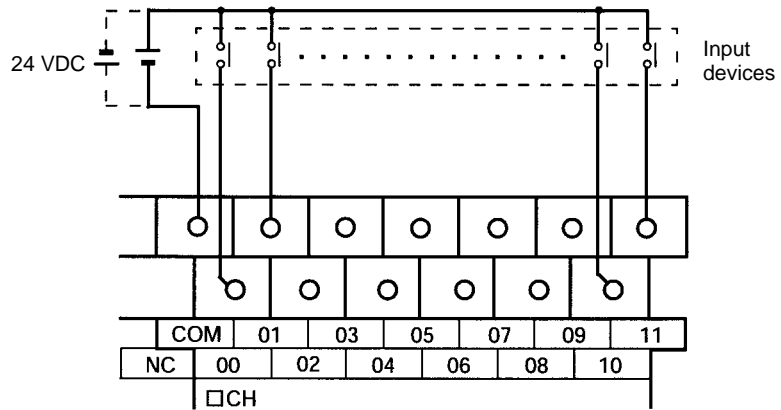

**CPM1A-8ED**

Terminals 00 through 07 of "mCH" correspond to bits 00 through 07 of word IR m.

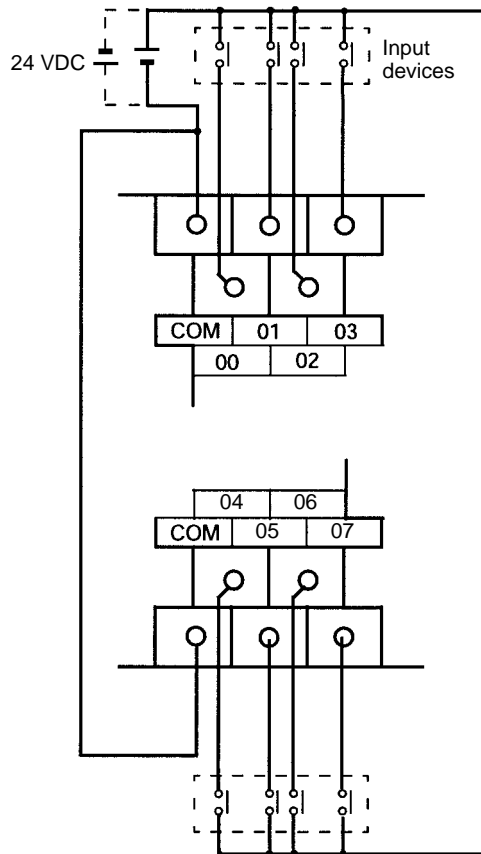

**Note** Although the commons are connected internally, they must all be wired.

**Input Wiring Example**

A CPU Unit with an AC power supply is shown. CPU Units with DC power supplies don't have power supply outputs.

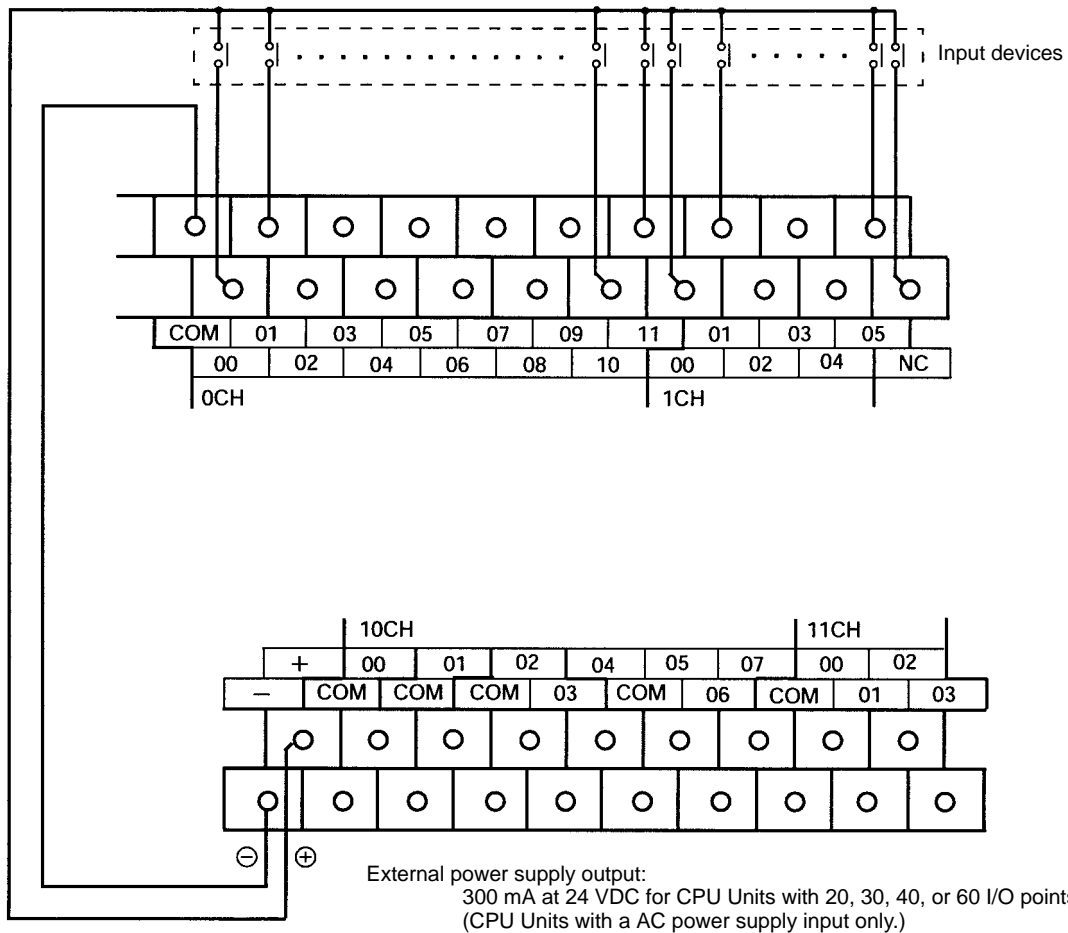

**⚠ WARNING** When the 24-VDC output (service power supply to the PC) is overloaded or short-circuited, the voltage may drop and result in the outputs being turned OFF. External safety measures must be provided to ensure safety in the system. Not providing proper safety measures may result in serious accidents.

Input Devices

The following table shows how to connect various input devices.

Device	Circuit diagram
Relay output	
NPN open collector	
NPN current output	
PNP current output	
Voltage output	

**Note** Do not use the following wiring with voltage-output devices:

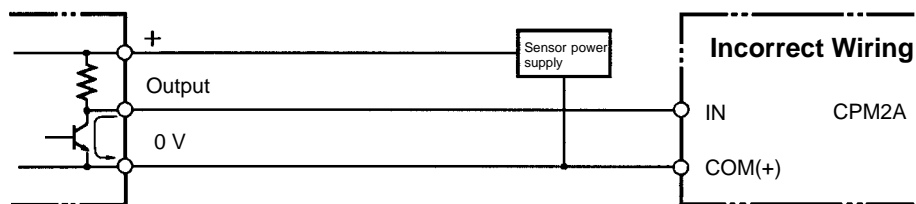

High-speed Counter Inputs

Using IR 0000 to IR 0002 as High-speed Counter Inputs

In these examples, Encoders with an external 24-VDC open-collector output are connected.

Differential Phase Mode  
(Count frequency: 5 kHz)

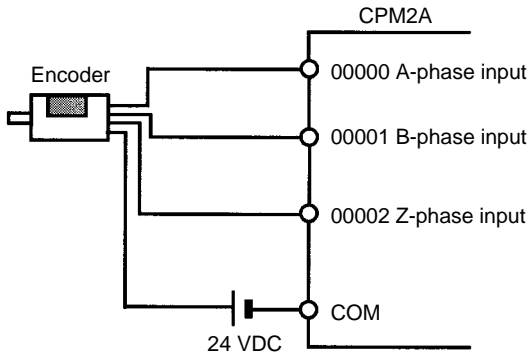

Pulse Plus Direction Input Mode  
(Count frequency: 20 kHz)

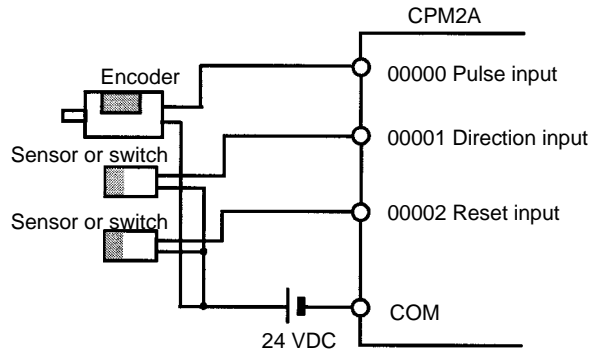

Up/Down Mode  
(Count frequency: 20 kHz)

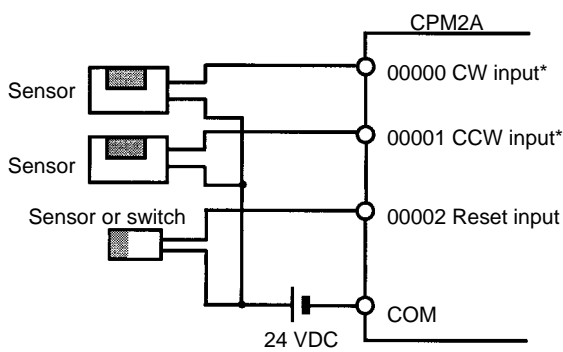

Increment Mode  
(Count frequency: 20 kHz)

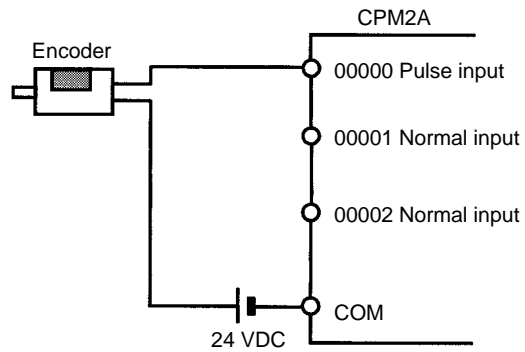

**Note** \*CW is clockwise and CCW is counter-clockwise.

Using IR 00003 to IR 00006 as Interrupt Inputs (Counter Mode)

In these examples, an Encoder with an external 24-VDC open-collector output is connected.

Increment or decrement  
(Count frequency: 2 kHz)

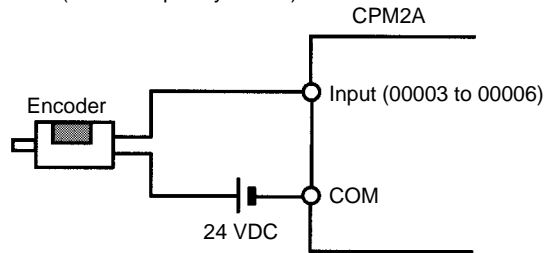

PC Setup Settings

The input bits shown in the following tables can operate as normal inputs or they can be assigned special functions in the PC Setup.

Special functions for input bits IR 00000 through IR 00002 are set in DM 6642:

Bit address	PC Setup setting (DM 6642 bits 08 to15)		
	00	01	02, 03, or 04
IR 00000	Used as normal inputs.	Used as high-speed counter inputs.	Used as inputs for synchronized pulse control.
IR 00001			
IR 00002			Used as a normal input.



Special functions for input bits IR 00003 through IR 00006 are set in DM 6628:

Bit address	Bits in DM 6628	PC Setup setting (in DM 6628)		
		0	1	2
IR 00003	00 to 03	Used as normal inputs.	Used as interrupt inputs (including counter mode).	Used as quick-response inputs.
IR 00004	04 to 07			
IR 00005	08 to 11			
IR 00006	12 to 15			

**High-speed Counter Input Connection Examples**

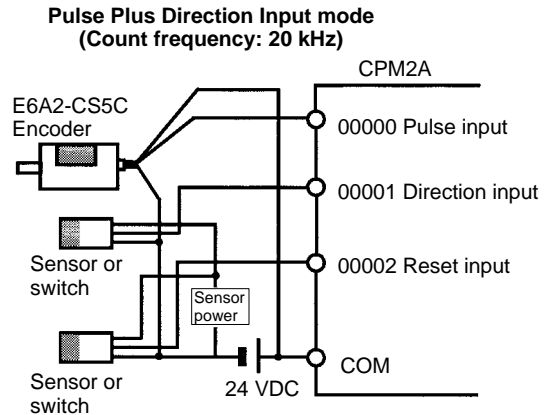
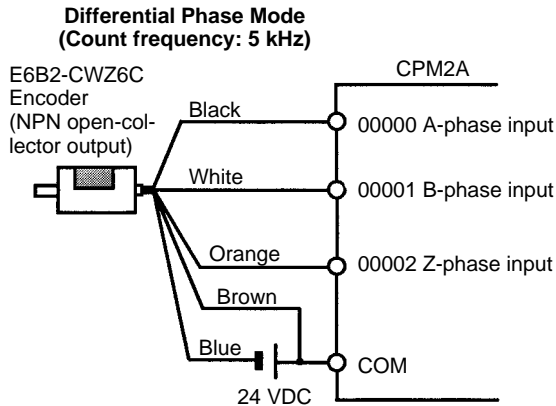

**Leakage Current**

A leakage current can cause false inputs when using 2-wire sensors (proximity switches or photoelectric switches) or limit switches with LEDs. False inputs won't occur if the leakage current is less than 1.0 mA (2.5 mA for IN00000 to IN00002). If the leakage current exceeds these values, insert a bleeder resistor in the circuit to reduce the input impedance, as shown in the following diagram.

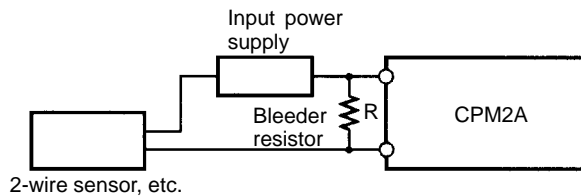

- I: Device's leakage current (mA)
- R: Bleeder resistance (kΩ)
- W: Bleeder resistor's power rating (W)
- L<sub>C</sub>: CPM2A's input impedance (kΩ)
- I<sub>C</sub>: CPM2A's input current (mA)
- E<sub>C</sub>: CPM2A's OFF voltage (V) = 5.0 V

$$R = \frac{L_C \times 5.0}{I \times L_C - 5.0} \text{ k}\Omega \text{ max.} \quad W = \frac{2.3}{R} \text{ W min.}$$

The equations above were derived from the following equations:

$$I \times \frac{R \times \frac{\text{Input voltage (24)}}{\text{Input Current (I}_C)}}{R + \frac{\text{Input voltage (24)}}{\text{Input Current (I}_C)}} \leq \text{OFF voltage (E}_C : 5.0)$$

$$W \leq \frac{\text{Input voltage (24)}}{R} \times \text{Input voltage (24)} \times \text{tolerance (4)}$$

Refer to 2-1-3 I/O Specifications for details on the values L<sub>C</sub>, I<sub>C</sub>, and E<sub>C</sub>. The input impedance, input current, and OFF voltage may vary depending on the input being used. (IN00000 through IN00002 have different values.)

**Inductive Loads**

When connecting an inductive load to an input, connect a diode in parallel with the load. The diode should satisfy the following requirements:

- 1, 2, 3... 1. Peak reverse-breakdown voltage must be at least 3 times the load voltage.

2. Average rectified current must be 1 A.

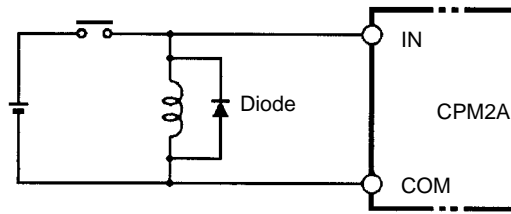

**Crimp Terminals**

**Caution** Always use crimp terminals for the CPM2A's I/O lines or use solid wire (instead of a stranded wire). Do not connect bare stranded wires directly to terminals. Stray wire strands can short-circuit and cause a fire.

Use M3 crimp terminals and tighten the terminal screws to a torque of 0.5 N • m.

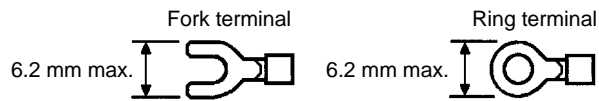

The recommended wire size for solid wires is 0.4 to 1.2 mm (AWG26 to AWG18).

**3-4-6 Output Wiring**

**Relay Output Wiring**

Wire the outputs to the CPM2A's CPU Unit and Expansion I/O Units as shown in the following diagrams. Use crimp terminals or solid wires (not stranded wire) to connect to the PC. The power supply output terminals can be used with a CPU Unit with an AC power supply.

- Always use single wire or attach crimp terminals if a stranded wire is used.
- Don't exceed the output capacity or the maximum common current. Refer to 2-1-3 I/O Specifications for details.

Item	Relay outputs	Transistor outputs, sinking or sourcing
Output capacity	2 A (250 VAC or 24 VDC)	01000 and 01001: 200 mA (30 VDC) 01002 and higher: 300 mA (30 VDC)
Max. common capacity	4 A/common	0.8 A/common

**Note** Refer to Section 3 Memory Areas in the Programming Manual (W353) for details on the allocation of output bits in CPM2A PCs.

**WARNING** The PC outputs may remain ON or OFF due to deposition or burning of the output relays or destruction of the output transistors. External safety measures must be provided to ensure safety in the system. Not providing proper safety measures may result in serious accidents.

Output Configurations

**CPM2A-20CDR-□**

Terminals 00 through 07 of "10CH" correspond to IR 01000 through IR 01007.

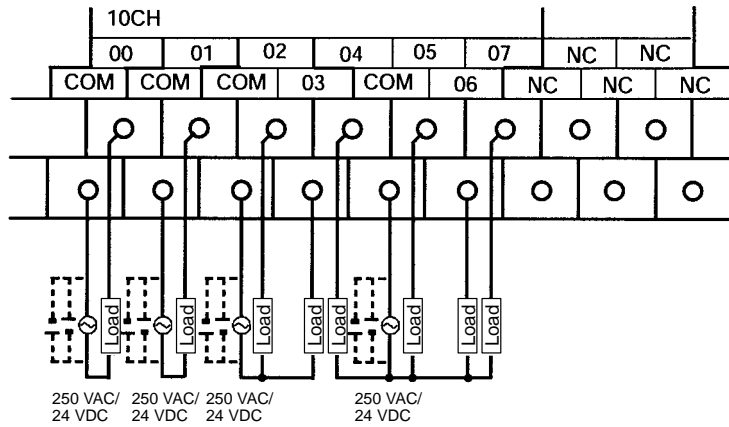

**CPM2A-30CDR-□**

Terminals 00 through 07 of "10CH" correspond to IR 01000 through IR 01007.

Terminals 00 through 03 of "11CH" correspond to IR 01100 through IR 01103.

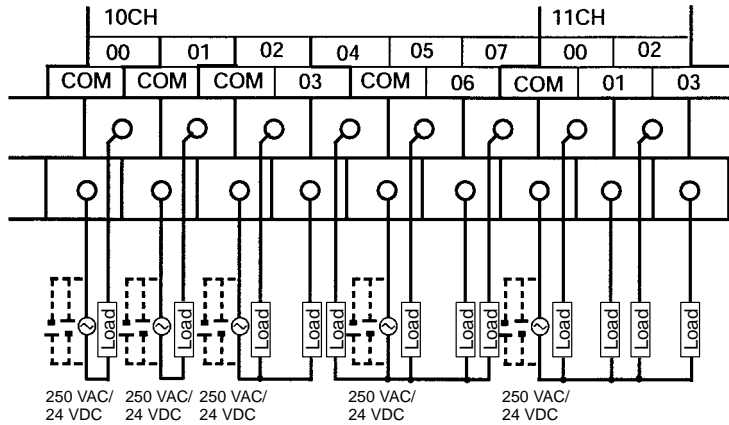

**CPM2A-40CDR-□**

Terminals 00 through 07 of "10CH" correspond to IR 01000 through IR 01007.

Terminals 00 through 07 of "11CH" correspond to IR 01100 through IR 01107.

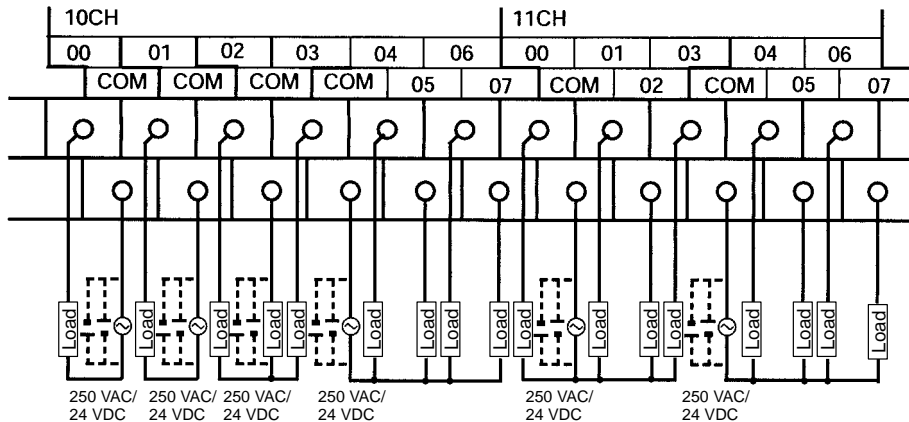

CPM2A-60CDR-□

Terminals 00 through 07 of "10CH" correspond to IR 01000 through IR 01007.

Terminals 00 through 07 of "11CH" correspond to IR 01100 through IR 01107.

Terminals 00 through 07 of "12CH" correspond to IR 01200 through IR 01207.

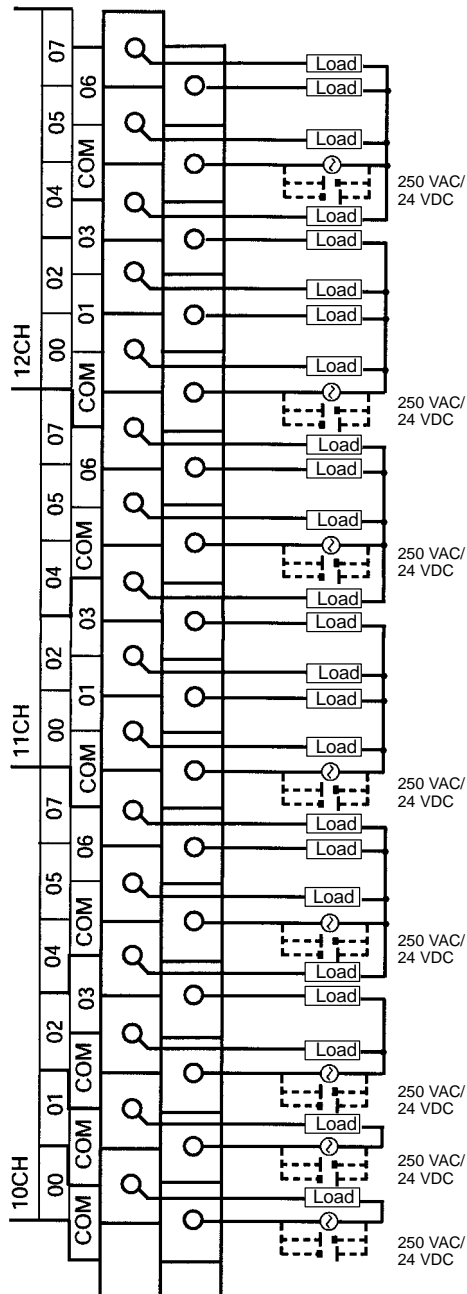

**CPM1A-20EDR1**

Terminals 00 through 07 of "1nCH" correspond to bits 00 through 07 of word IR 1n.

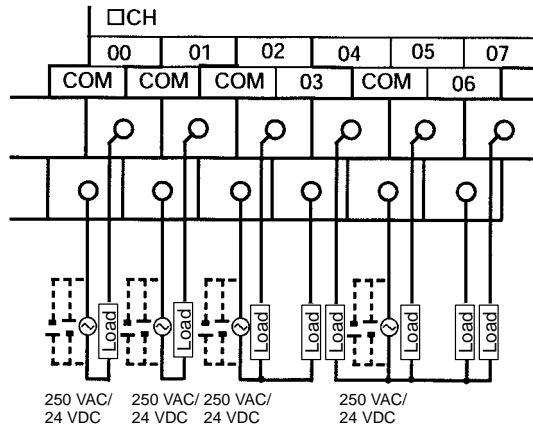

**CPM1A-8ER**

Terminals 00 through 07 of "1nCH" correspond to bits 00 through 07 of word IR 1n.

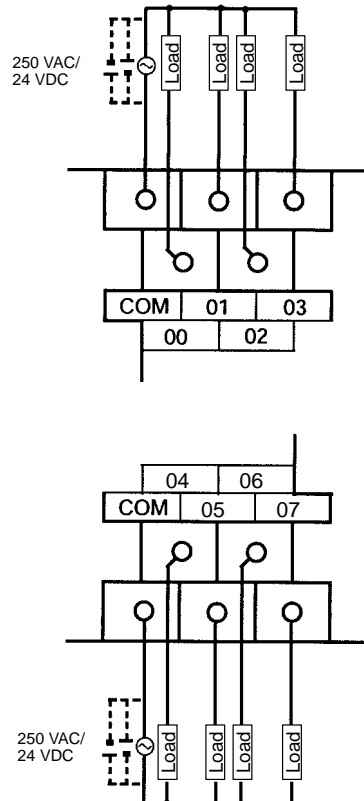

**Transistor Output Wiring (Sinking)**

Wire the outputs to the CPM2A's CPU Unit and Expansion I/O Units as shown in the following diagrams.

- Always use single wire or attach crimp terminals if a stranded wire is used.
- Don't exceed the output capacity or the maximum common current. Refer to 2-1-3 I/O Specifications for details.

Item	Specification
Output capacity	OUT01000 and OUT01001: 200 mA (30 VDC) OUT01002 and up: 300 mA (30 VDC)
Max. common capacity	0.8 A/common

**Note** Refer to Section 3 Memory Areas in the Programming Manual (W353) for details on the allocation of output bits in CPM2A PCs.

**Caution** Double-check the polarity of the power supply for the load before turning it ON. If the polarity is reversed, the load may malfunction or internal components may be damaged.

**Output Configurations**

**CPM2A-20CDT-D**

Terminals 00 through 07 of "10CH" correspond to IR 01000 through IR 01007.

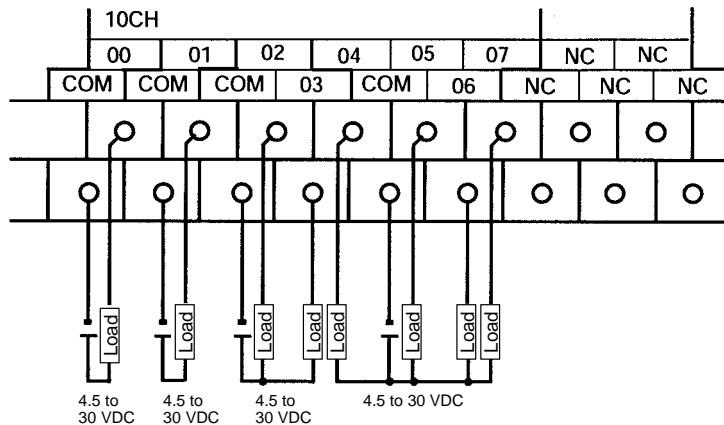

**CPM2A-30CDT-D**

Terminals 00 through 07 of "10CH" correspond to IR 01000 through IR 01007. Terminals 00 through 03 of "11CH" correspond to IR 01100 through IR 01103.

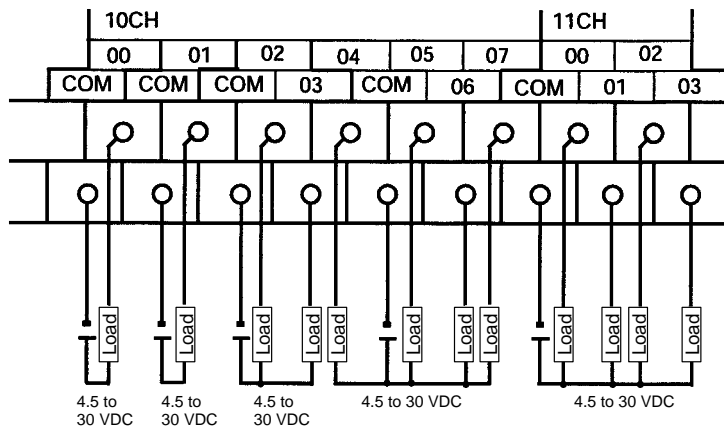

**CPM2A-40CDT-D**

Terminals 00 through 07 of "10CH" correspond to IR 01000 through IR 01007.  
Terminals 00 through 07 of "11CH" correspond to IR 01100 through IR 01107.

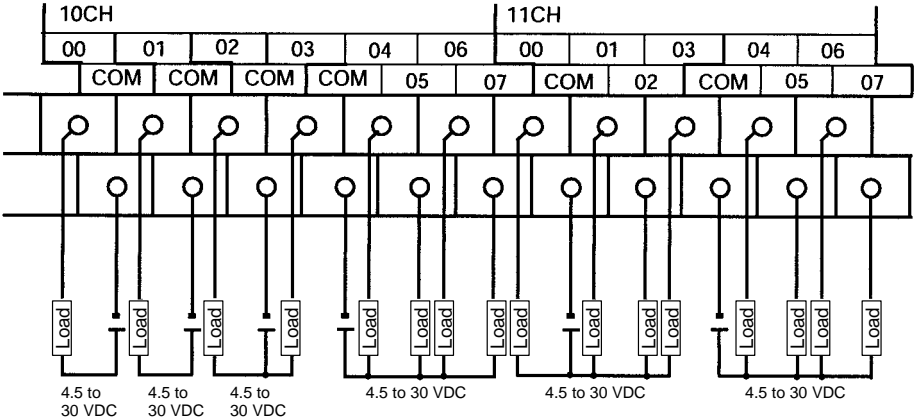

**CPM2A-60CDT-D**

Terminals 00 through 07 of "10CH" correspond to IR 01000 through IR 01007.  
 Terminals 00 through 07 of "11CH" correspond to IR 01100 through IR 01107.  
 Terminals 00 through 07 of "12CH" correspond to IR 01200 through IR 01207.

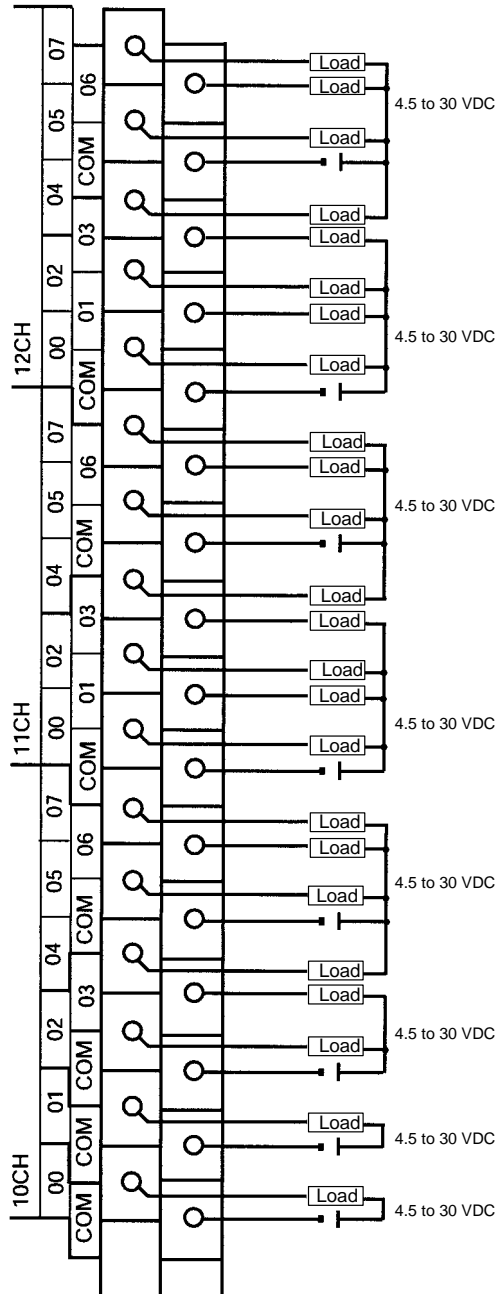



**CPM1A-20EDT**

Terminals 00 through 07 of "1nCH" correspond to bits 00 through 07 of word IR 1n.

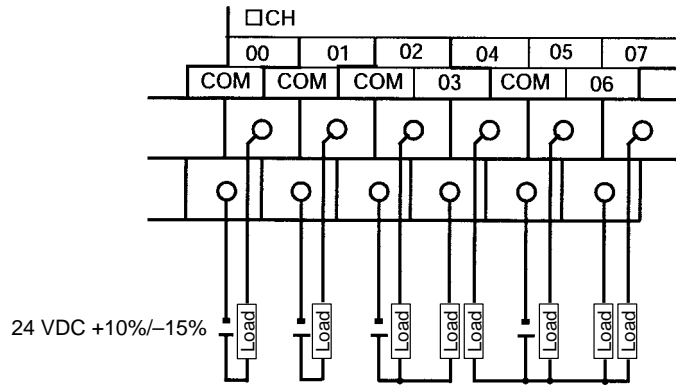

**CPM1A-8ET**

Terminals 00 through 07 of "1nCH" correspond to bits 00 through 07 of word IR 1n.

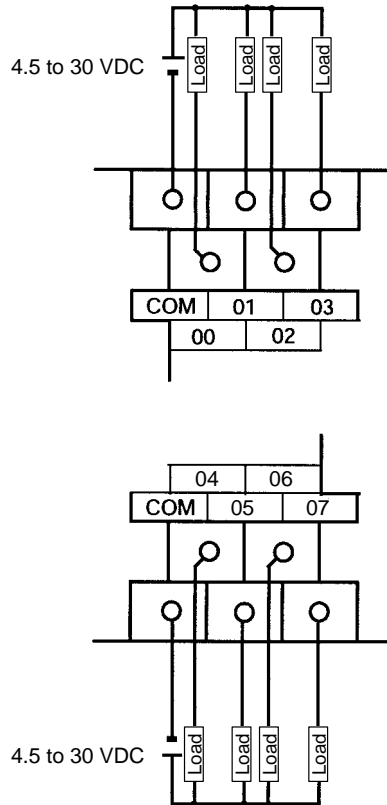

**Transistor Output Wiring (Sourcing)**

Wire the outputs to the CPM2A's CPU Unit and Expansion I/O Units as shown in the following diagrams.

- Always use single wire or attach crimp terminals if a stranded wire is used.
- Don't exceed the output capacity or the maximum common current. Refer to 2-1-3 I/O Specifications for details.

Item	Specification
Output capacity	OUT01000 and OUT01001: 200 mA (30 VDC) OUT01002 and up: 300 mA (30 VDC)
Max. common capacity	0.8 A/common

**Note** Refer to Section 3 Memory Areas in the Programming Manual (W353) for details on the allocation of output bits in CPM2A PCs.

**Caution** Double-check the polarity of the power supply for the load before turning it ON. If the polarity is reversed, the load may malfunction or internal components may be damaged.

**Output Configurations**

**CPM2A-20CDT1-D**

Terminals 00 through 07 of "10CH" correspond to IR 01000 through IR 01007.

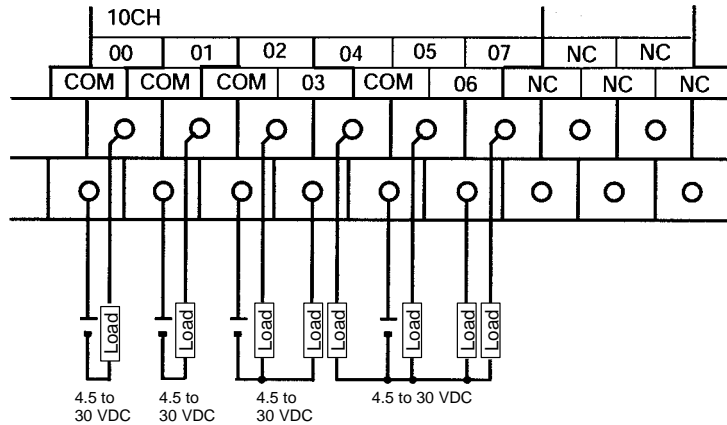

**CPM2A-30CDT1-D**

Terminals 00 through 07 of "10CH" correspond to IR 01000 through IR 01007. Terminals 00 through 03 of "11CH" correspond to IR 01100 through IR 01103.

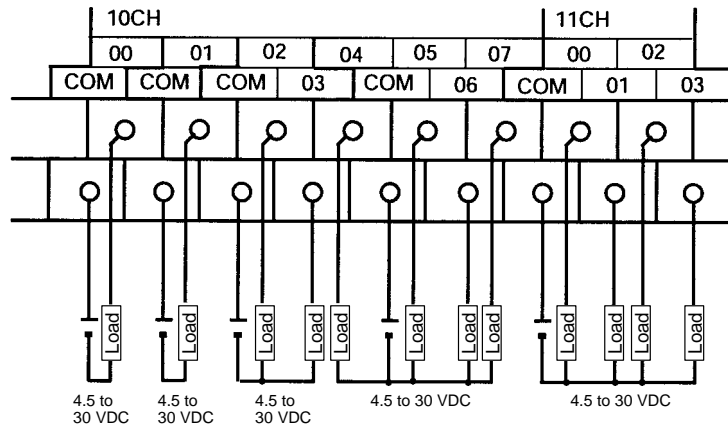

**CPM2A-40CDT1-D**

Terminals 00 through 07 of "10CH" correspond to IR 01000 through IR 01007.  
Terminals 00 through 07 of "11CH" correspond to IR 01100 through IR 01107.

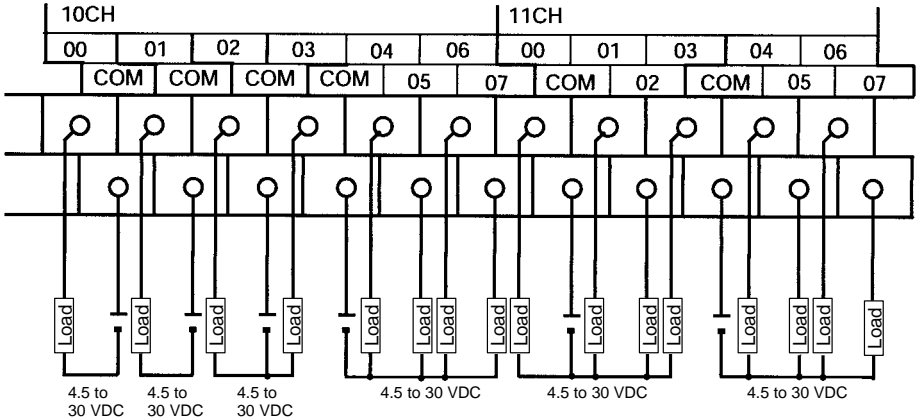

CPM2A-60CDT1-D

Terminals 00 through 07 of "10CH" correspond to IR 01000 through IR 01007.

Terminals 00 through 07 of "11CH" correspond to IR 01100 through IR 01107.

Terminals 00 through 07 of "12CH" correspond to IR 01200 through IR 01207.

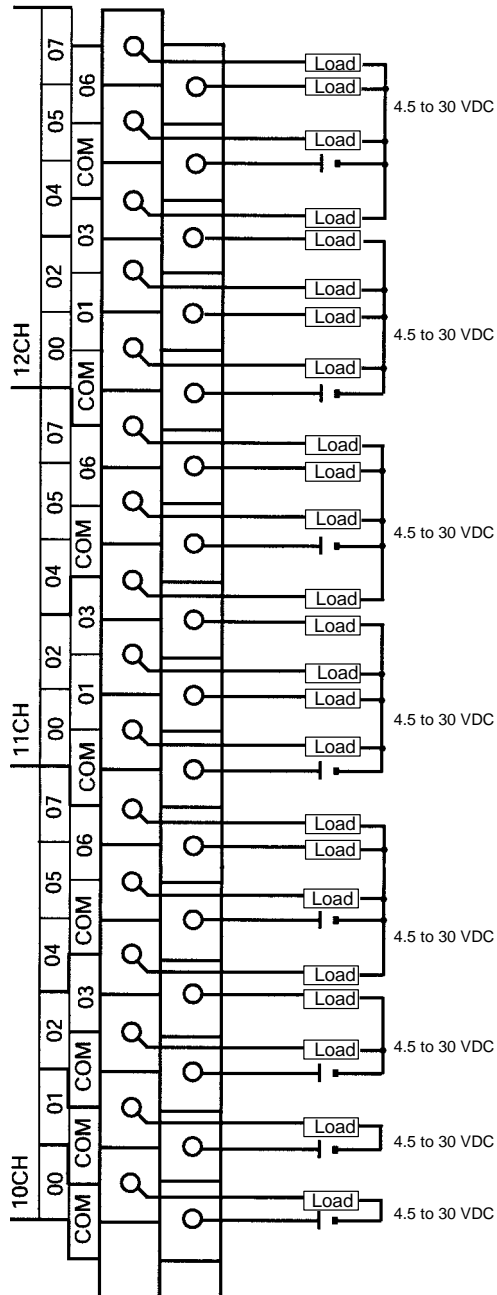

**CPM1A-20EDT1**

Terminals 00 through 07 of "1nCH" correspond to bits 00 through 07 of word IR 1n.

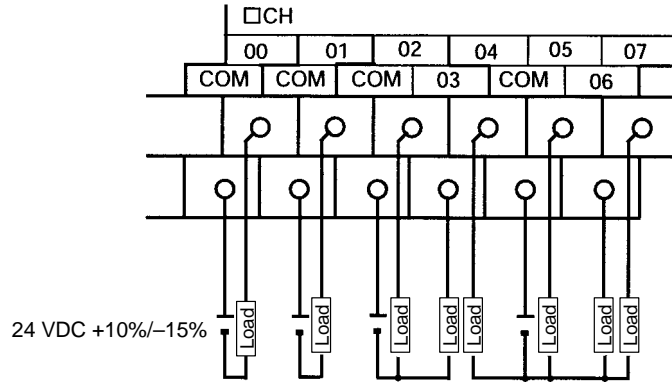

**CPM1A-8ET1**

Terminals 00 through 07 of "1nCH" correspond to bits 00 through 07 of word IR 1n.

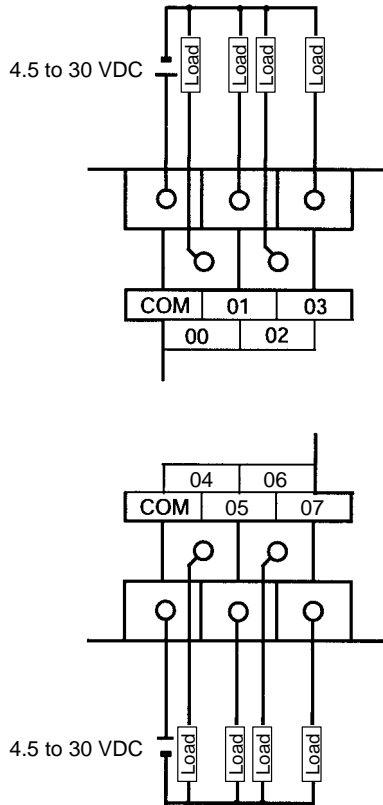

**Using Pulse Outputs**

The following diagrams show example applications of sink-type transistor outputs using output bits IR 01000 and IR 01001. Use the PULS(65), SPED(—), ACC(—), PWM(—), and SYNC(—) instructions to produce pulse outputs (rather than normal outputs) from output bits IR 01000 and IR 01001.

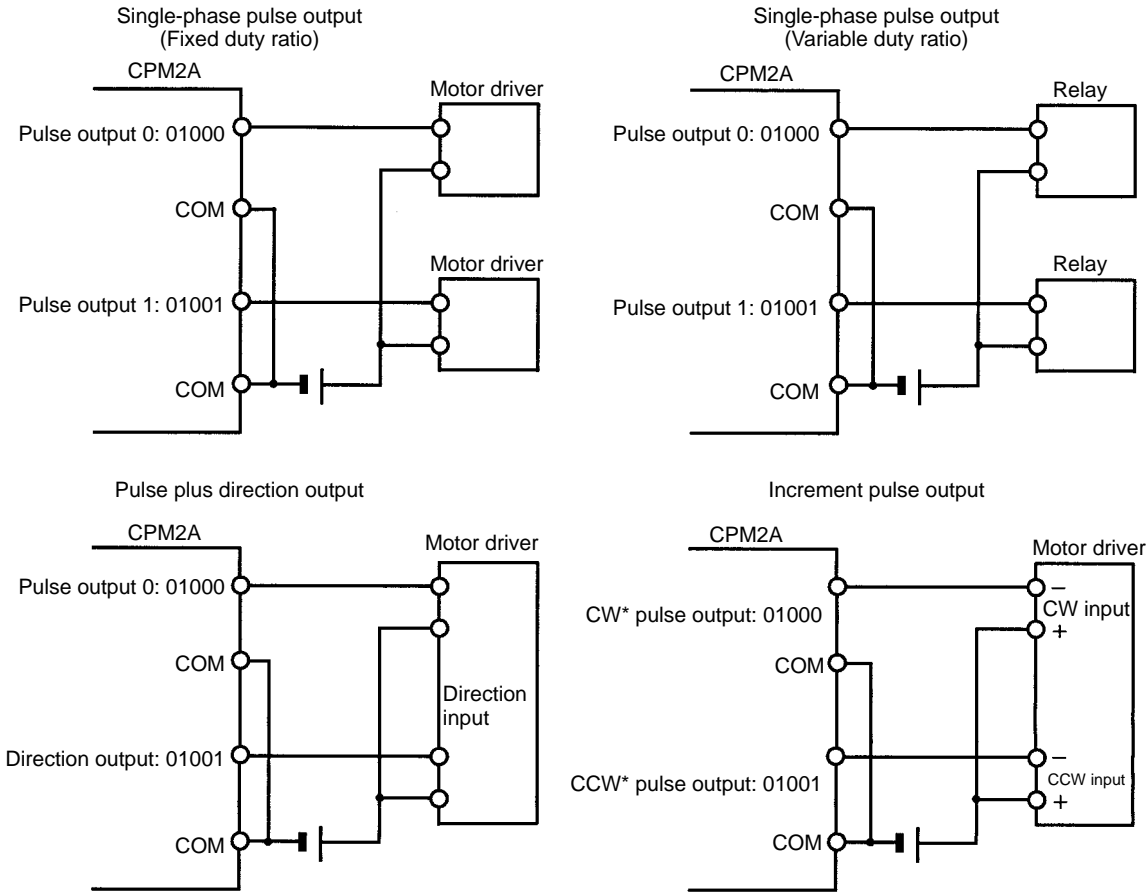

**Note** \*CW is clockwise and CCW is counter-clockwise.

**Output Wiring Precautions**

Observe the following precautions to protect the PC's internal components.

**Output Short Protection**

The output or internal circuitry might be damaged when the load connected to an output is short-circuited, so it is recommended to install a protective fuse in each output circuit.

**Inductive Loads**

When connecting an inductive load to an input, connect a surge protector or diode in parallel with the load.

The surge protector's components should have the following ratings:

**Relay Output**

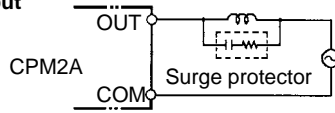

**Relay Output Transistor Output (Sinking)**

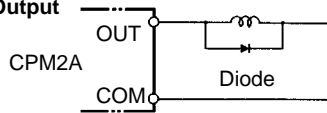

**Relay Output Transistor Output (Sourcing)**

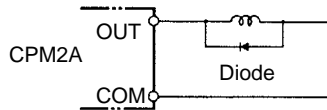

The diode should satisfy the following requirements:

- Peak reverse-breakdown voltage must be at least 3 times the load voltage.
- Average rectified current must be 1 A.

**Inrush Current Considerations**

When switching a load with a high inrush current in the CPM2A relay output or transistor output model, such as an incandescent lamp, suppress the inrush current as shown below.

**Countermeasure 1**

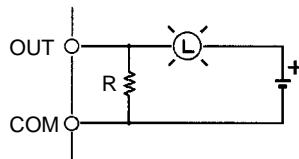

Providing a dark current of approx. one-third of the rated value through an incandescent lamp

**Countermeasure 2**

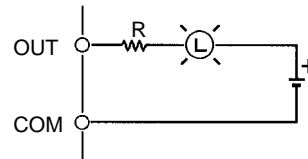

Providing a limiting resistor

**Fuse Insertion**

The CPM2A with transistor output may burn if the load is short-circuited, therefore, insert a protective fuse in series to the load.

**Crimp Terminals**



**Caution**

Always use crimp terminals for the CPM2A's I/O lines or use solid wire (instead of a stranded wire). Do not connect bare stranded wires directly to terminals. Stray wire strands can short-circuit and cause a fire.

Use M3 crimp terminals and tighten the terminal screws to a torque of 0.5 N • m.

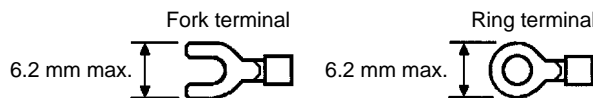

The recommended wire size for solid wires is 0.4 to 1.2 mm (AWG26 to AWG18).

### 3-4-7 Programming Device Connections

The CPM2A CPU Unit can be connected to a Programming Console or a host computer running SYSMAC Support Software (SSS) or SYSMAC-CPT Support Software.

#### Programming Console

The CPM2A CPU Unit can be connected to a C200H-PRO27-E Programming Console with a standard C200H-CN222 (2 m) or C200H-CN422 (4 m) Connecting Cable. The CPM2A CPU Unit can be also connected to a CQM1-PRO01-E. A 2-m Connecting Cable is attached to the CQM1-PRO01-E.

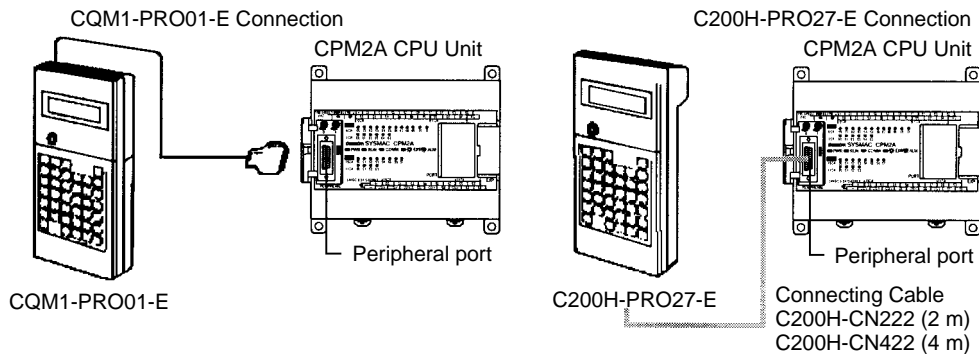

Connect the Programming Console to the CPU Unit's Peripheral port; a Programming Console cannot be connected to the RS-232C port. The PC will automatically communicate with the Programming Console in Programming Console mode, regardless of the communications method selected on the CPU Unit's Communications Switch.

#### Support Software

An IBM-compatible personal computer running the SSS or SYSMAC-CPT Support Software can be connected to the CPU Unit's Peripheral port or RS-232C port. The Peripheral port can operate in Peripheral bus mode or Host Link mode. The RS-232C port operates in Host Link mode only.

The setting on the CPU Unit's Communications Switch determines whether the RS-232C port will operate with the communications settings in the PC Setup or the standard settings, as shown in the following table.

Switch setting	Communications settings	
	Peripheral port	RS-232C port
ON	Standard settings (The standard settings and PC Setup default settings are Host Link communications at 9,600 bps with 1 start bit, 7-bit data, 2 stop bits, and even parity.)	
OFF	PC Setup settings in DM 6650 and DM 6651	PC Setup settings in DM 6645 and DM 6646

Connect to the Peripheral port when connecting to the PC's Peripheral bus. The communications mode will be Host Link communications, but the CPM2A will automatically switch to Peripheral bus communications if Peripheral bus has been selected in the Support Software.



**Peripheral Port Connection**

A personal computer can be connected to the CPU Unit's Peripheral port with a CQM1-CIF01 or CPM1-CIF01 RS-232C Adapter.

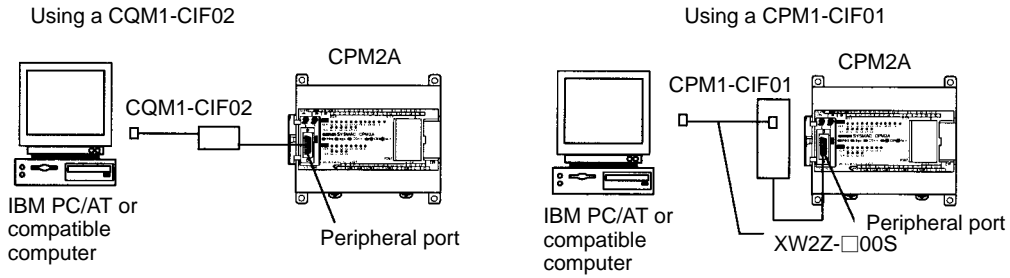

**RS-232C Port Connection**

A personal computer can be connected to the CPU Unit's RS-232C port with an XW2Z-□00S or XW2Z-□00S-V Connecting Cable.

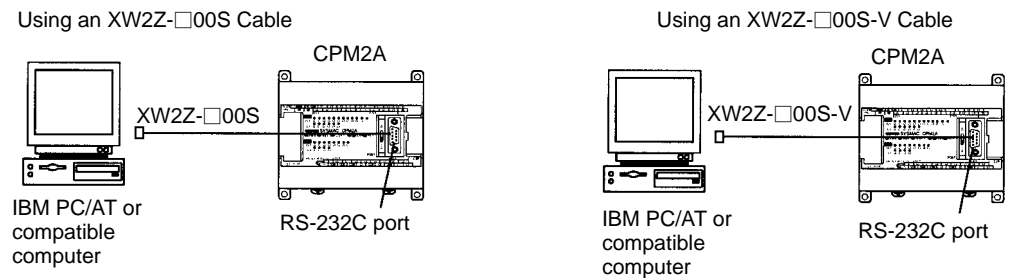

**Note** The XW2Z-□00S cables have a D-Sub 25-pin connector and the XW2Z-□00S-V cables have a D-Sub 9-pin connector.

**Support Software**

Name	Model number	Comments
SYSMAC Support Software	C500-ZL3AT1-E	For IBM PC/AT or compatible computers (1.44 MB 3.5-inch floppy disks)
SYSMAC-CPT Support Software	WS01-CPTB1-E	For IBM PC/AT or compatible computers (1.44 MB 3.5-inch floppy disks or CD-ROM)

**Cables and Adapters**

CPM2A port	Cable length	Model number	Comments
Peripheral	3.3 m	CQM1-CIF01	For a 25-pin computer serial port
	3.3 m + 0.15 m	CPM1-CIF01 + XW2Z-S001	
RS-232C	2 m	XW2Z-200S	For a 25-pin computer serial port
	5 m	XW2Z-500S	
	2 m	XW2Z-200S-V	For a 9-pin computer serial port
	5 m	XW2Z-500S-V	

**3-4-8 Host Link Connections**

Host Link is a command/response communications system in which commands are transmitted from the host computer and corresponding responses are returned from the destination PCs. Host Link commands can be used to read/write data in PC data areas and read/write PC settings.

**One-to-one Host Link Connection**

The CPM2A CPU Unit can be connected to an IBM PC/AT or compatible computer or a Programmable Terminal through the CPU Unit's Peripheral port or RS-232C port, as shown in the following diagrams.

**Peripheral Port Connection**

Connect to the CPU Unit's Peripheral port with a CQM1-CIF01 or CPM1-CIF01 RS-232C Adapter.

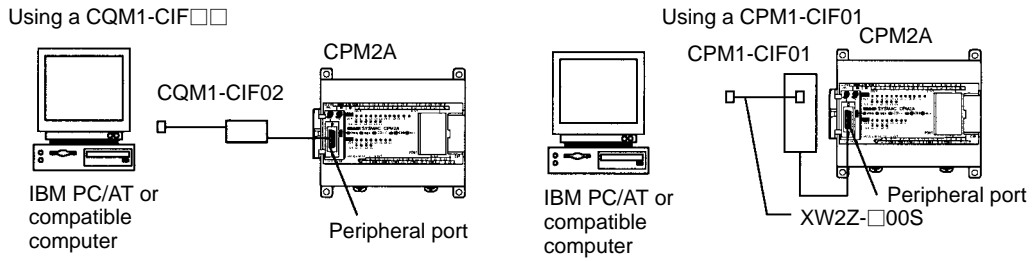

**RS-232C Port Connection**

Connect to the CPU Unit's RS-232C port with an XW2Z-□00S or XW2Z-□00S-V Connecting Cable.

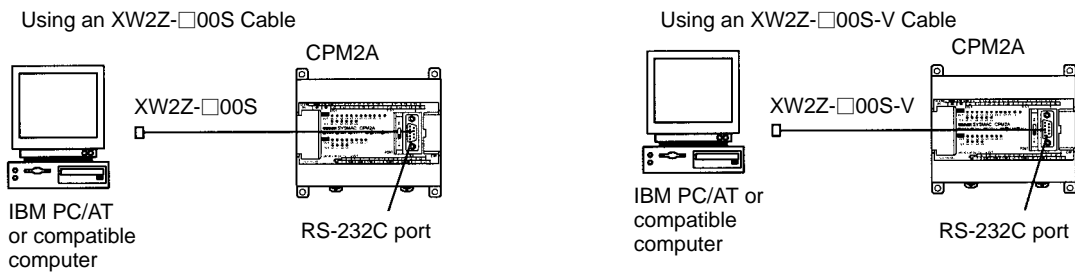

**Note** The XW2Z-□00S cables have a D-Sub 25-pin connector and the XW2Z-□00S-V cables have a D-Sub 9-pin connector.

**Cables and Adapters**

CPM2A port	Cable length	Model number	Comments
Peripheral	3.3 m	CQM1-CIF02	For a 25-pin computer serial port
	3.3 m + 0.15 m	CPM1-CIF01 + XW2Z-S001	
RS-232C	2 m	XW2Z-200S	For a 25-pin computer serial port
	5 m	XW2Z-500S	
	2 m	XW2Z-200S-V	For a 9-pin computer serial port
	5 m	XW2Z-500S-V	

**Communications Settings**

Set the CPU Unit's Communications Switch to ON when using the standard communications settings<sup>1</sup>. Set the switch to OFF to use the settings in the PC Setup.

**Note** The standard settings are: Host Link, 9,600 bps, 7-bit data, 1 start bit, 2 stop bits, and even parity. Refer to *Section 1 PC Setup* in the *Programming Manual* (W353) for details on settings.

**One-to-N Host Link Connection**

Up to 32 OMRON PCs, including CPM2A PCs, can be controlled from a host computer. The following diagrams show separate RS-232C port and Peripheral port configurations, but both ports can be used simultaneously.

**RS-232C Port Connection**

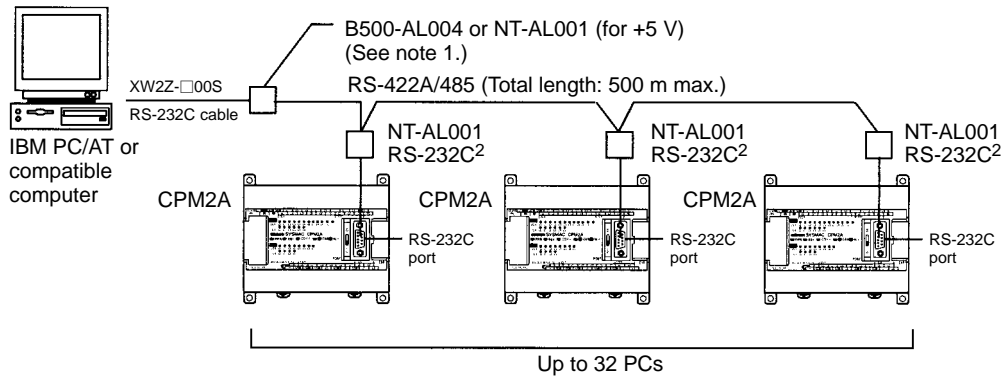

**Peripheral Port Connection**

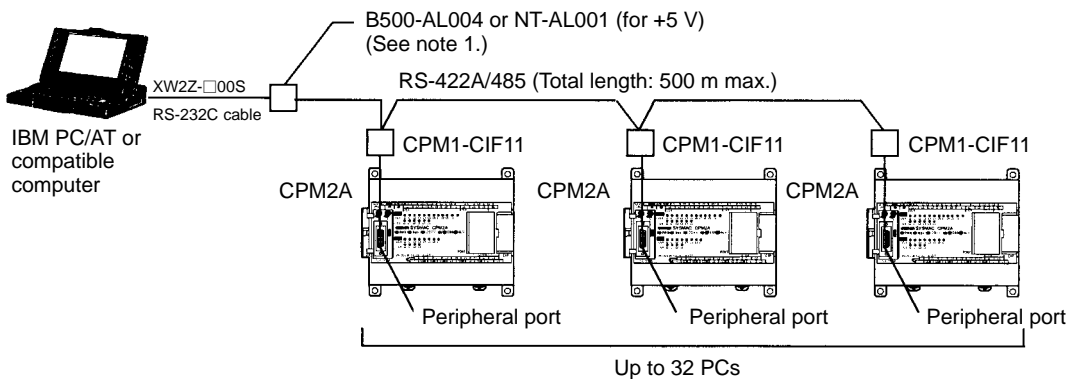

- Note**
1. The NT-AL001 must be supplied externally with 5 VDC.  
 When an NT-AL001 is connected to a CPM2A PC, pin 6 of the CPM2A's RS-232C port supplies +5 VDC and an external power supply is not necessary. When the NT-AL001 is connected to a host computer, it is necessary to supply 5 VDC from an external power supply.  
 If an NT-AL001 is connected to the CPM2A's RS-232C port, only one Expansion Unit or Expansion I/O Unit can be connected to the CPU Unit because the NT-AL001 draws its 5-VDC power from the CPU Unit.
  2. Use an XW2Z-070T-1 (0.7 m) or XW2Z-200T-1 (2 m) cable to connect the NT-AL001 to the CPM2A's RS-232C port.

**Cables and Adapters**

Name	Function		Model number
Link Adapter	RS-232C/RS-422 conversion	For host computer connection (Can be connected to the CPM2A.)	B500-AL004
RS-422 Adapter		For CPM2A connection (Can be connected to a host computer, but requires an external 5-VDC power supply.)	NT-AL001

### 3-4-9 No-Protocol Communications

The TXD(48) and RXD(47) instructions can be used in no-protocol mode to exchange data with standard serial devices. For example, data can be received from a bar code reader or transmitted to a serial printer. The serial devices can be connected to the RS-232C port or Peripheral port, as shown in the following diagrams.

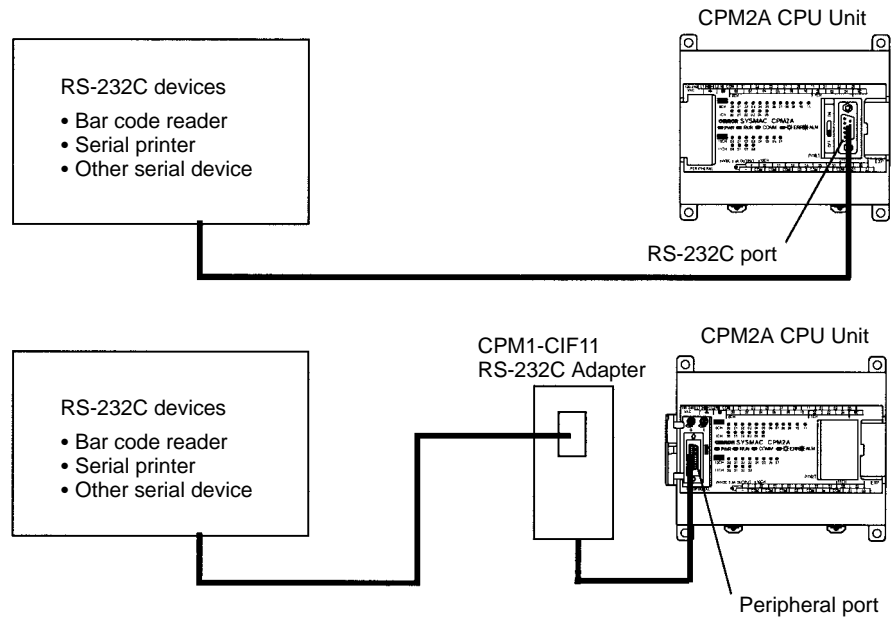

**Note** Set the CPU Unit's Communications Switch to OFF to use the settings in the PC Setup and set the communications mode to no-protocol mode for the port being used. Refer to *Section 1 PC Setup* in the *Programming Manual (W353)* for details on settings.

### 3-4-10 OMRON PT Connections

In a 1:1 NT Link, a CPM2A can be connected directly to a Programmable Terminal. The Programmable Terminal must be connected to the RS-232C port; it cannot be connected to the Peripheral port.

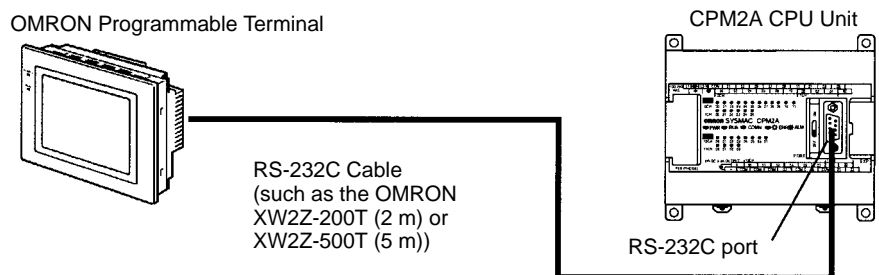

**Note** Set the CPU Unit's Communications Switch to OFF to use the settings in the PC Setup and set the communications mode to a 1:1 NT Link for the RS-232C port. Refer to *Section 1 PC Setup* in the *Programming Manual (W353)* for details on settings.

### 3-4-11 One-to-one PC Link Connections

A CPM2A can be linked to another CPM2A, a CQM1, CPM1, CPM1A, CPM2C, SRM1 or a C200HS or C200HX/HE/HG PC. The PC must be connected through the RS-232C port; it cannot be connected through the Peripheral port.

In a 1:1 PC connection, one PC is specified as the Master in its PC Setup and the other as the Slave in its PC Setup.

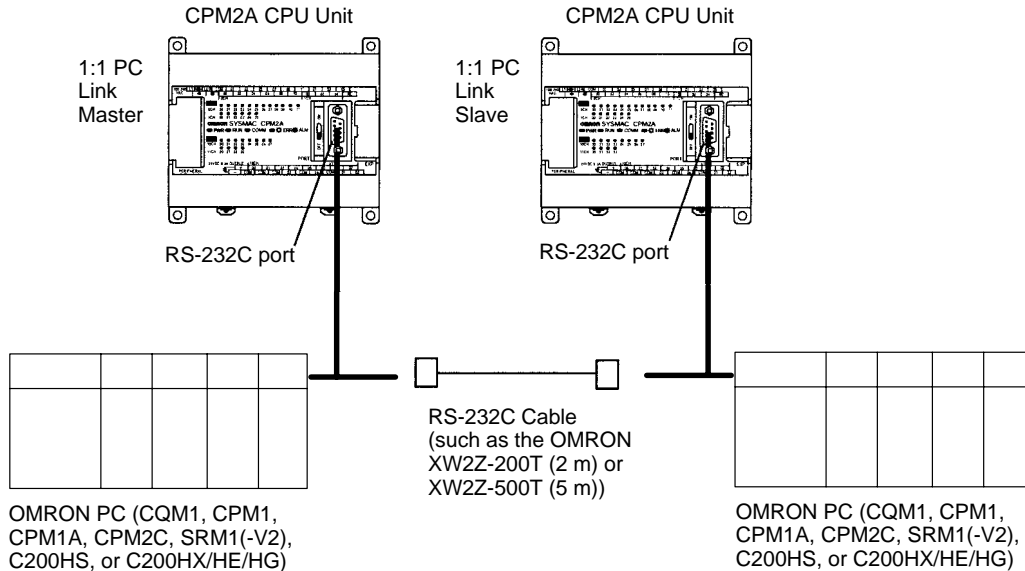

**Note** Set the CPU Unit's Communications Switch to OFF to use the settings in the PC Setup and set the RS-232C port communications mode to 1:1 PC Link Master in one PC and 1:1 PC Link Slave in the other PC. Refer to *Section 1 PC Setup* in the *Programming Manual (W353)* for details on settings.

### 3-4-12 CompoBus/S I/O Link Connections

A CompoBus/S I/O Link can be used to create an I/O link (remote I/O) of 8 input points and 8 output points with a CompoBus/S Master Unit or SRM1 PC. The connection is made through a CompoBus/S I/O Link Unit.

From the standpoint of the CPM2A CPU Unit, the area allocated to the CompoBus/S I/O Link Unit can be treated just like the area allocated to an Expansion I/O Unit. The difference is that the bits are not actual I/O points, but I/O bits in the Master Unit.

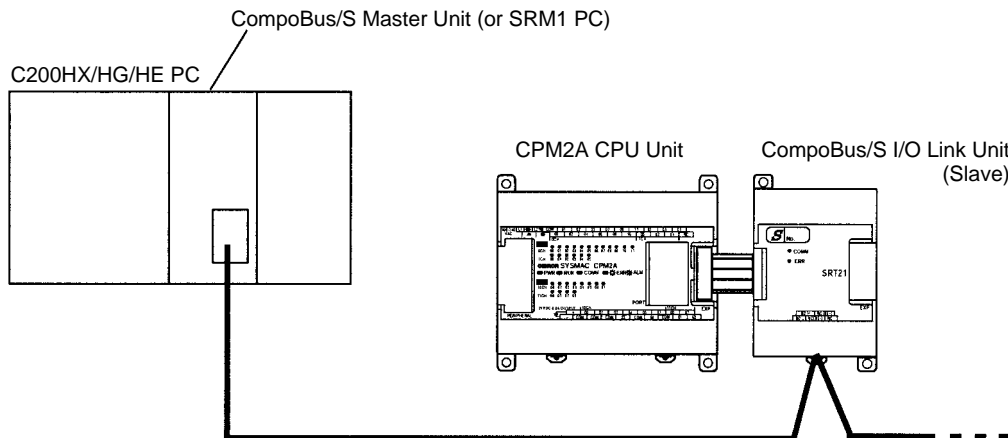

**Cables**

Use special flat cable or VCTF cable to connect the nodes in the CompoBus/S

I/O Link. (Special flat cables and VCTF cables cannot be combined in the same system.)

<b>Name</b>	<b>Specifications</b>
Flat cable	4-core flat cable, 0.75 mm <sup>2</sup>
VCTF cable	2-core x 0.75 mm <sup>2</sup>

# SECTION 4

## Using Programming Devices

This section outlines the operations possible with the SYSMAC-CPT, SYSMAC Support Software (SSS) and the Programming Consoles. Actual SYSMAC-CPT operating procedures are provided in the *SYSMAC-CPT User Manual*. Actual SSS operating procedures are provided in the *SSS Operation Manuals: Basics and C-series PCs*. Operations for the WS02-CXPC1-E CX-Programmer are provided in the *WS02-CXPC1-E CX-Programmer User Manual (W361)* and the *CX-Server User Manual (W362)*.

Refer to 3-4-7 *Programming Device Connections* and 4-3-3 *Connecting the Programming Console* for details on connecting a Programming Console or personal computer to the CPM2A.

4-1	SYSMAC-CPT Support Software .....	84
4-1-1	Introduction .....	84
4-1-2	Limitations and Precautions .....	84
4-1-3	Using the SYSMAC-CPT Support Software .....	86
4-2	SYSMAC Support Software (SSS) .....	92
4-2-1	Introduction .....	92
4-2-2	Limitations and Precautions .....	92
4-3	Using a Programming Console .....	95
4-3-1	Compatible Programming Consoles .....	95
4-3-2	Changing the CPM2A's Mode with the Mode Switch .....	97
4-3-3	Connecting the Programming Console .....	98
4-3-4	Preparation for Operation .....	99
4-3-5	Entering the Password .....	99
4-4	Programming Console Operations .....	101
4-4-1	Overview .....	101
4-4-2	Clearing Memory .....	102
4-4-3	Reading/Clearing Error Messages .....	103
4-4-4	Buzzer Operation .....	103
4-4-5	Assigning Expansion Instruction Function Codes .....	104
4-4-6	Setting and Reading a Program Memory Address and Monitoring I/O Bit Status .....	105
4-4-7	Entering or Editing Programs .....	105
4-4-8	Instruction Search .....	108
4-4-9	Bit Operand Search .....	109
4-4-10	Inserting and Deleting Instructions .....	110
4-4-11	Checking the Program .....	111
4-4-12	Bit, Digit, Word Monitor .....	111
4-4-13	Differentiation Monitor .....	113
4-4-14	Binary Monitor .....	114
4-4-15	Three-Word Monitor .....	115
4-4-16	Signed Decimal Monitor .....	115
4-4-17	Unsigned Decimal Monitor .....	116
4-4-18	Three-Word Data Modification .....	116
4-4-19	Changing Timer, Counter SV .....	117
4-4-20	Hexadecimal, BCD Data Modification .....	118
4-4-21	Binary Data Modification .....	119
4-4-22	Signed Decimal Data Modification .....	119
4-4-23	Unsigned Decimal Data Modification .....	120
4-4-24	Force Set, Reset .....	121
4-4-25	Clear Force Set/Reset .....	122
4-4-26	Hex-ASCII Display Change .....	122
4-4-27	Displaying the Cycle Time .....	123
4-4-28	Reading and Setting the Clock .....	123
4-5	Programming Example .....	124
4-5-1	Preparatory Operations .....	124
4-5-2	Example Program .....	125
4-5-3	Programming Procedures .....	126
4-5-4	Checking the Program .....	129
4-5-5	Test Run in MONITOR Mode .....	129

## 4-1 SYSMAC-CPT Support Software

### 4-1-1 Introduction

The SYSMAC-CPT Support Software is a complete programming and control package. It provides not only programming capabilities, but also advanced debugging, monitoring, and program/data management. The software is compatible with Windows 3.1, Windows 95, Windows 98, and Windows NT 3.5/4.0. Any version of the SYSMAC-CPT Support Software can be used to program CPM2A PCs with the limitations described later in this section. For further information and actual operating procedures, please refer to the *SYSMAC-CPT Support Software Quick Start Guide (W332)* and *User Manual (W333)*.

Refer to *3-4-7 Programming Device Connections* for details on connecting a personal computer to the CPM2A.

### 4-1-2 Limitations and Precautions

When programming a CPM2A PC with the SYSMAC-CPT Support Software, set the PC model to "CQM1" and the CPU model to "CPU43." There are some software limitations because of differences between the CPM2A and CQM1-CPU43 CPUs.

#### Program Input and Program Check

CQM1 data areas are larger than the corresponding CPM2A data areas, so the data area addresses that don't actually exist in the CPM2A or instructions not supported by the CPM2A can be input and won't be detected in the program check. Be sure that the word and bit addresses are within the specified ranges and that all instructions are supported.

If a program contains a data area address that exceeds the range of a CPM2A data area, a memory error will be generated when the program is executed and the Memory Area Specification Error Flag (AR 1308) will be turned ON.

Data area		CQM1 range	CPM2A range
Input words		IR 000 to IR 011	IR 000 to IR 009
Output words		IR 100 to IR 111	IR 010 to IR 019
Work words and dedicated words		IR 012 to IR 099	IR 020 to IR 049/IR 200 to IR 227 (IR 050 to IR 199 cannot be used.)
SR area		SR 244 to SR 255	SR 228 to SR 255
HR area		HR 00 to HR 99	HR 00 to HR 19 (HR 20 to HR 99 cannot be used.)
AR area		AR 00 to AR 27	AR 00 to AR 23 (AR 24 to AR 27 cannot be used.)
LR area		LR 00 to LR 63	LR 00 to LR 15 (LR 16 to LR 63 cannot be used.)
Timer/Counter area		TIM/CNT 000 to 511	TIM/CNT 000 to 255 (TIM/CNT 256 to 511 cannot be used.)
DM area	Read/write	DM 0000 to DM 6143	DM 0000 to DM 1999, DM 2022 to DM 2047 (DM 2048 to DM 6143 cannot be used.)
	Read-only	DM 6144 to DM 6568	DM 6144 to DM 6599
	Error Log	DM 6569 to DM 6599	DM 2000 to DM 2021
	PC Setup	DM 6600 to DM 6655	DM 6600 to DM 6655

#### Monitoring, Online Editing, and Set Values

An error message will be displayed and the values will not be accepted if a data area address that exceeds the range of a CPM2A data area is entered for monitoring, an instruction operand, or a timer/counter SV.

#### Available Program Memory

The program capacity of the CQM1 (7,200 words) is greater than that of the CPM2A (4,096 words), and so the display will show more free space than is actually available. Be sure to keep the actual program capacity in mind while programming.



**Program Transfer**

When the program is transferred from the PC to the CPT with the default function code assignments, FUN18, FUN19, FUN87, and FUN88 will be displayed as TKY, MCMP, DSW, and 7SEG. The instructions, however, will be transferred correctly.

An error will occur if any instructions not supported by the CPT are transferred from the CPM2A.

When the program is transferred from the CPT to the PC, TKY, MCMP, DSW, and 7SEG will be displayed on the CPT, but will not be executed in the CPU Unit. They will be treated as NOP.

If expansion instructions are transferred to the PC with DM 6602 is set to the “default settings” or if instructions not supported by the CPM2A are transferred to the PC, a message saying that expansion instructions cannot be written because DIP switch pin 4 is OFF will be displayed. Change the setting of DM 6602 to enable user settings to use expansion instructions.

**Expansion Instructions**

It will not be possible to transfer the program if the function codes assigned to expansion instructions (18 instructions) have been changed from their default settings. A message to turn ON the DIP switch of the PC and execute again will be displayed. Change the function code assignments to the CQM1 defaults shown in the following table before programming.

Function code	Default CPM2A Assignments	Default CQM1 Assignments
17	ASFT	ASFT
18	---	TKY
19	---	MCMP
47	RXD	RXD
48	TXD	TXD
60	CMPL	CMPL
61	INI	INI
62	PRV	PRV
63	CTBL	CTBL
64	SPED	SPED
65	PULS	PULS
66	SCL	SCL
67	BCNT	BCNT
68	BCMP	BCMP
69	STIM	STIM
87	---	DSW
88	---	7SEG
89	INT	INT

There are four CPM2A instructions (STUP(—), SYNC(—), TIML(—), and TMHH(—)) that are not supported by the CQM1 and cannot be used. If one of these instructions is used in the program, an error will occur when the program is transferred from the PC to the computer.

The input word for the frequency for PWM must be between IR 000 and IR 049, or between IR 200 and IR 252.

If a CQM1 instruction that is not supported by the CPM2A is used in the program, an error will occur when the program is transferred from the computer to the PC.

**Error Log**

The error log cannot be displayed. If data has been written to DM 6569 to DM 6599, however, this data will be incorrectly displayed as the error log. Do not use the information that is displayed.

**PC Setup**

Some of the CPM2A's PC Setup settings are different from those in the CQM1, so not all settings can be made from the menus. These settings have to be made by writing data directly to the word containing the setting.

### 4-1-3 Using the SYSMAC-CPT Support Software

This section shows how to perform basic SYSMAC-CPT Support Software operations with the CPM2A PC. (The software is operating in a Windows 95 environment in these examples.)

#### Starting the Software

The SYSMAC-CPT Support Software is a Windows 3.1/Windows 95 application. Refer to the *SYSMAC-CPT Support Software User Manual (W333)* for details on computer requirements and the software installation procedure.

- 1, 2, 3...** 1. Select "Programs (P)" from the Start Menu, "SYSMAC-CPT," and then "SYSMAC-CPT" to start the software.



2. Read the notes provided in the startup messages and click "OK."



3. The SYSMAC-CPT Support Software will start.



**Note** To exit from the SYSMAC-CPT Support Software, select "File (F)" from the menu bar and "Exit (X)" from the File menu.

**Creating a New Project**

Follow this procedure when using SYSMAC-CPT Support Software for the first time or creating a new project. Specify the PC model and CPU version of the PC being used.

- 1, 2, 3... 1. Select "File (E)" from the menu bar and "New (N)" from the File menu.



2. Input the name of the new project, set the PC model to "CQM1," set the CPU version to "CPU43," and click "OK."

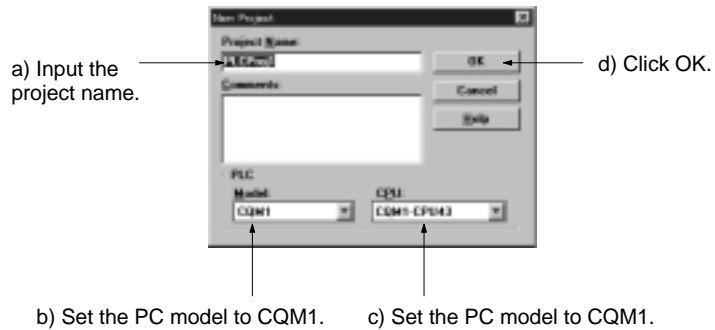

3. The new project's ladder diagram will be displayed.

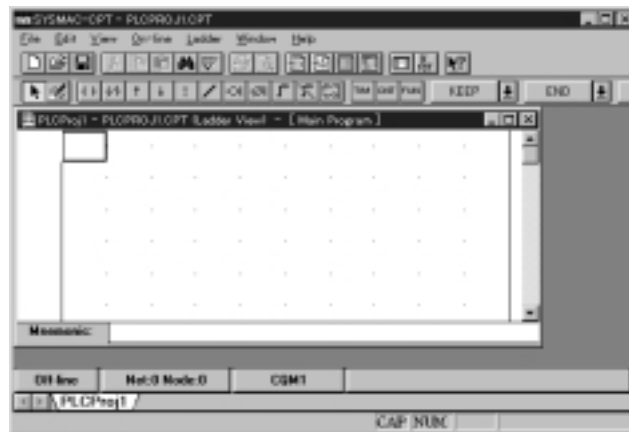

**Writing and Editing the Ladder Program**

The SYSMAC-CPT Support Software can display programs in ladder-diagram format or mnemonic format. To switch the display/editing format, select “View (V)” from the menu bar, “Program editor (P),” and then “Ladder (L)” or “Mnemonic (M).”

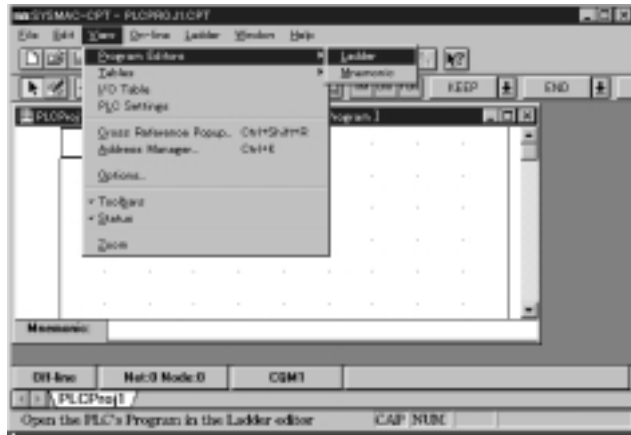

Ladder-diagram format



Mnemonic format



**Transferring the Program**

There are three steps involved in transferring the program.

- Connect the CPM2A with the computer in which the SYSMAC-CPT Support Software has been installed.
- Switch the SYSMAC-CPT Support Software to online operation.
- Transfer the program.

### Connecting the CPM2A with the Computer

Securely insert the computer Connecting Cable to the CPM2A's peripheral port and then turn on the CPM2A's power supply.

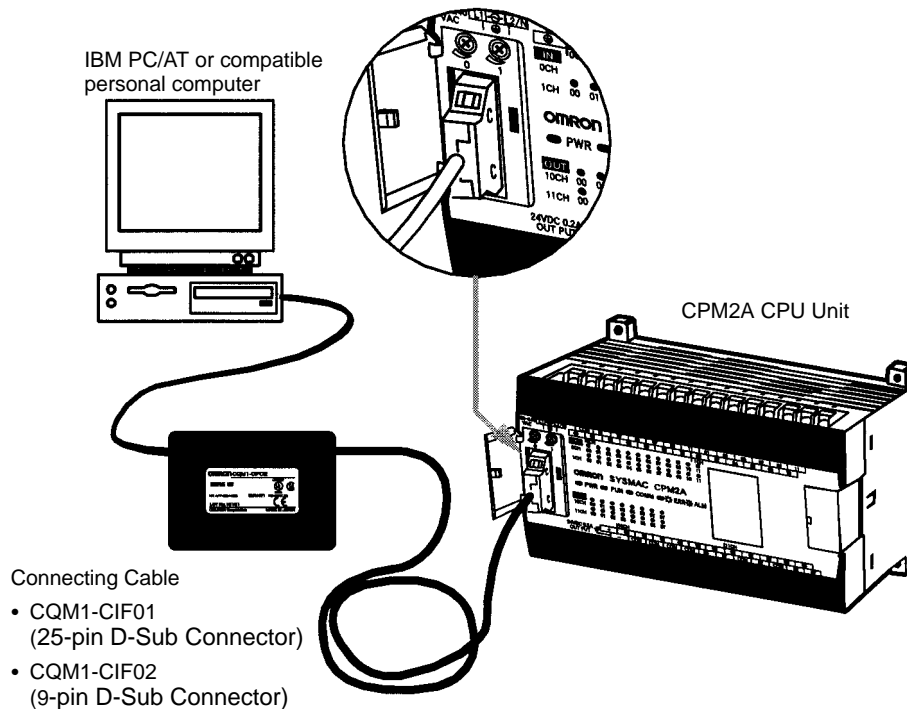

### Operating Modes

If power is turned ON to the CPM2A without anything connected to the peripheral port, the CPM2A will start operation in RUN mode. If operation starts in RUN mode when power is turned ON even though a Connecting Cable is correctly connected to the peripheral port, check the settings in the PC Setup in the CPM2A.

The CPM2A has three operating modes: PROGRAM, MONITOR, and RUN. When the CPT is offline, the CPM2A will operate in PROGRAM mode. When the CPT is online, the CPM2A operating mode can be controlled from the CPT.

#### **PROGRAM Mode**

The CPM2A program isn't executed in PROGRAM mode. Use PROGRAM mode to create and edit the program, clear memory, or check the program for errors.

#### **MONITOR Mode**

The CPM2A program is executed in MONITOR mode and I/O is processed just as it is in RUN mode. Use MONITOR mode to test system operations, such as monitoring CPM2A operating status, force-setting and resetting I/O bits, changing the SV/PV of timers and counters, changing word data, and online editing.

#### **RUN Mode**

This is the CPM2A's normal operating mode. The CPM2A's operating status can be monitored from a Programming Device, but bits can't be force-set/force-reset and the SV/PV of timers and counters can't be changed.

**Switching to Online Operation**

The SYSMAC-CPT Support Software must make an online connection in order to communicate with the CPM2A, transfer the program, or change the CPM2A's operating mode.

- 1, 2, 3... 1. Select "Online (O)" from the menu bar and "Go online (G)" from the Online menu.

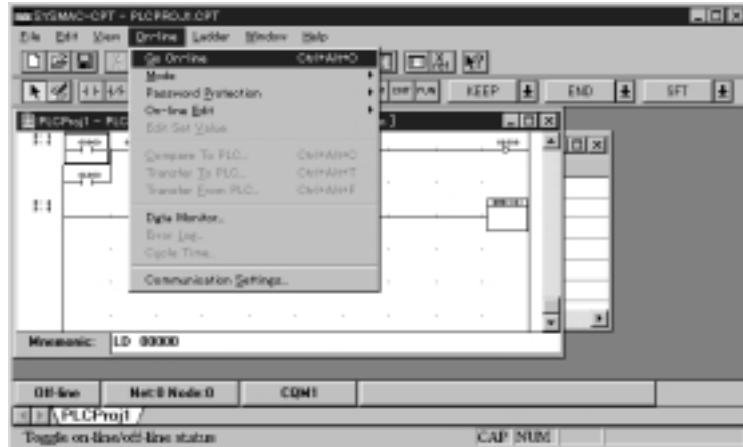

2. A confirmation message will be displayed. Click "OK" to go online.



3. The ladder-diagram display will change to indicate the online connection.

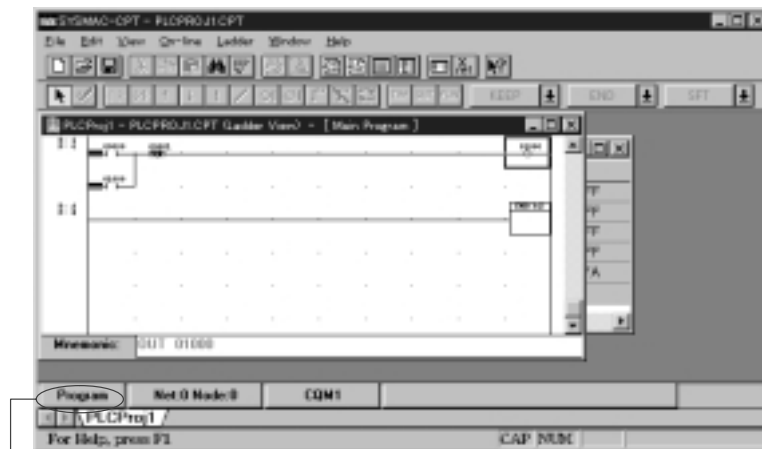

Changes to "Program," showing the PC's operating mode.

**Transferring the Program**

Use the following procedure to transfer a program to the PC.

Before attempting to transfer the program, make sure that the SYSMAC-CPT Support Software is online and that the CPM2A is in PROGRAM mode. The program cannot be transferred unless the PC is in PROGRAM mode.

- 1, 2, 3... 1. Check that the PC is in PROGRAM mode, select “Online (O)” from the menu bar, and “Transfer (Computer → PC (I))” from the Online menu.

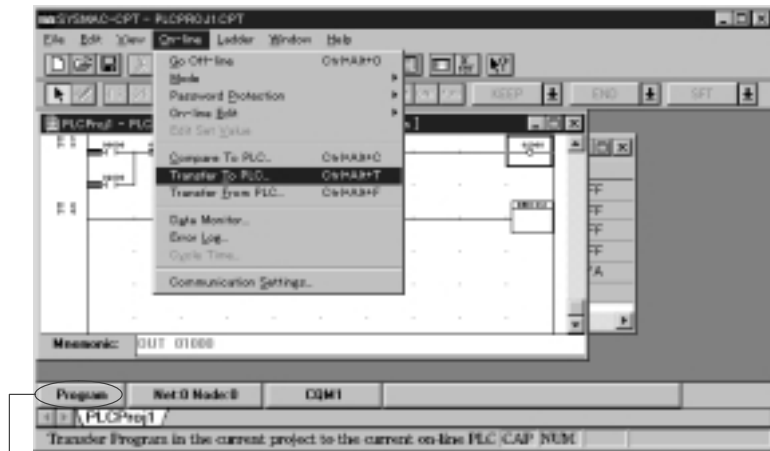

Make sure that the CPM2A is in PROGRAM mode before attempting to transfer the program.

2. Select “Program” and click “Transfer (Computer → PC)” to begin transfer the program.



**Checking Operation in MONITOR Mode**

Use the following procedure to switch the CPM2A to MONITOR mode.

- 1, 2, 3... 1. Make sure that the SYSMAC-CPT Support Software is online. Select “Online (O)” from the menu bar, select “Mode (M),” and then “MONITOR (M).”



2. A confirmation message will be displayed. Click “OK” to switch to MONITOR mode.

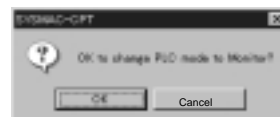

**Starting Operation in RUN Mode**

Use the following procedure to switch the CPM2A to RUN mode.

- 1, 2, 3... 1. Make sure that the SYSMAC-CPT Support Software is online. Select “On-line (O)” from the menu bar, select “Mode (M),” and then “RUN (R).”

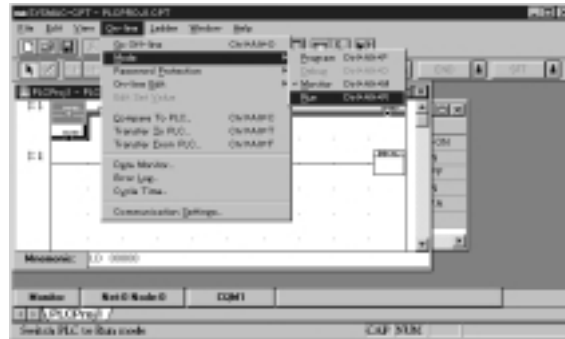

2. A confirmation message will be displayed. Click “OK” to switch to RUN mode.

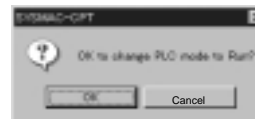

## 4-2 SYSMAC Support Software (SSS)

### 4-2-1 Introduction

The SSS is a complete programming and control package designed for C-series and CVM1 PCs. It provides not only programming capabilities, but also advanced debugging, monitoring, and program/data management. For further information and actual operating procedures, please refer to the *SYSMAC Support Software Operation Manuals: Basics and C-series*.

CPM2A programming can be performed with any version of the SSS.

Refer to *3-4-7 Programming Device Connections* for details on connecting a personal computer to the CPM2A.

### 4-2-2 Limitations and Precautions

When programming a CPM2A PC with the SSS, set the PC model to “CQM1.” There are some software limitations because of differences between the CPM2A and CQM1 CPUs.

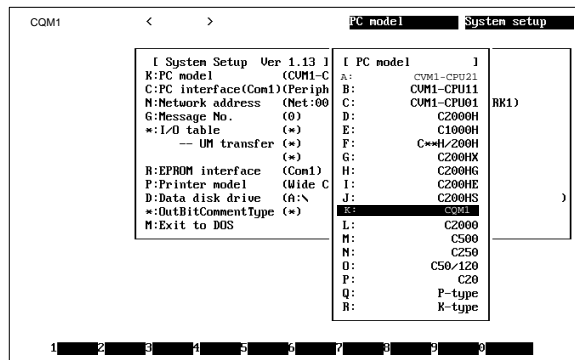

### Program Input and Program Check

CQM1 data areas are larger than the corresponding CPM2A data areas, so the data area addresses that don't actually exist in the CPM2A or instructions not supported by the CPM2A can be input and won't be detected in the program check. Be sure that the word and bit addresses are within the specified ranges and that all instructions are supported.



If a program contains a data area address that exceeds the range of a CPM2A data area, a memory error will be generated when the program is executed and the Memory Area Specification Error Flag (AR 1308) will be turned ON.

Data area		CQM1 range	CPM2A range
Input words		IR 000 to IR 011	IR 000 to IR 009
Output words		IR 100 to IR 111	IR 010 to IR 019
Work words		IR 012 to IR 099	IR 020 to IR 049/IR 200 to IR 227 (IR 050 to IR 199 cannot be used.)
SR area		SR 244 to SR 255	SR 228 to SR 255
HR area		HR 00 to HR 99	HR 00 to HR 19 (HR 20 to HR 99 cannot be used.)
AR area		AR 00 to AR 27	AR 00 to AR 23 (AR 24 to AR 27 cannot be used.)
LR area		LR 00 to LR 63	LR 00 to LR 15 (LR 16 to LR 63 cannot be used.)
Timer/Counter area		TIM/CNT 000 to 511	TIM/CNT 000 to 255 (TIM/CNT 256 to 511 cannot be used.)
DM area	Read/write	DM 0000 to DM 6143	DM 0000 to DM 1999, DM 2022 to DM 2047 (DM 2048 to DM 6143 cannot be used.)
	Read-only	DM 6144 to DM 6568	DM 6144 to DM 6599
	Error Log	DM 6569 to DM 6599	DM 2000 to DM 2021
	PC Setup	DM 6600 to DM 6655	DM 6600 to DM 6655

**Monitoring, Online Editing, and Set Values**

An error message will be displayed and the values will not be accepted if a data area address that exceeds the range of a CPM2A data area is entered for monitoring, time charts, an instruction operand, or a timer/counter SV.

**Transferring and Verifying DM Area Data**

DM Area addresses not supported by the CPM2A cannot be transferred or monitored. DM 1024 to DM 6143 are not checked for DM Area verification.

**Available Program Memory**

Since the program capacity of the CQM1 (7,200 words) is greater than that of the CPM2A (4,096 words), the display will show more free space than is actually available. Be sure to keep the actual program capacity in mind while programming.

**Program Transfer**

When the program is transferred from the PC to the SSS with the default function code assignments, FUN18, FUN19, FUN87, and FUN88 will be displayed as TKY, MCMP, DSW, and 7SEG. The instructions, however, will be transferred correctly.

“???” will be displayed if any instructions not supported by the SSS are transferred from the CPM2A. Mnemonics will be displayed, however, if any have been defined for the specified function code.

When the program is transferred from the SSS to the PC, TKY, MCMP, DSW, and 7SEG will be displayed on the SSS, but will not be executed in the CPU Unit. They will be treated as NOP.

If expansion instructions are transferred to the PC with DM 6602 is set to the “default settings,” a message saying that expansion instructions cannot be written because DIP switch pin 4 is OFF will be displayed. Change the setting of DM 6602 to enable user settings to use expansion instructions. If instructions not supported by the CPM2A are transferred to the PC, a message saying to set expansion instructions will be displayed, and transfer will not be possible.

**Expansion Instructions**

It will not be possible to transfer the program if the function codes assigned to expansion instructions have been changed from their default settings. A message to turn ON the DIP switch of the PC and execute again will be displayed. Change the function code assignments to the CQM1 defaults shown in the following table before programming.

Function code	Default CPM2A Assignments	Default CQM1 Assignments
17	ASFT	ASFT
18	---	TKY
19	---	MCMP
47	RXD	RXD
48	TXD	TXD
60	CMPL	CMPL
61	INI	INI
62	PRV	PRV
63	CTBL	CTBL
64	SPED	SPED
65	PULS	PULS
66	SCL	SCL
67	BCNT	BCNT
68	BCMP	BCMP
69	STIM	STIM
87	---	DSW
88	---	7SEG
89	INT	INT

If a CQM1 instruction that is not supported by the CPM2A is used in the program, an error will occur when the program is transferred from the computer to the PC. There are four CPM2A instructions (STUP(—), SYNC(—), TIML(—), and TMHH(—)) that are not supported by the CQM1. These instructions can be used by transferring the expansion instructions from the CPM2A to the SSS. This procedure is outlined below.

- 1, 2, 3...** 1. Select “Transfer Instr” from the “Utility” menu.



2. Confirm the transfer by pressing “Y” when the confirmation pop-up is displayed.  
 3. The “Utility” menu will be displayed again when the transfer is completed.

**PC Setup**

Since some of the CPM2A’s PC Setup settings are different from those in the CQM1, not all settings can be made from the menus. These settings have to be made by writing data directly to the word containing the setting.

### 4-3 Using a Programming Console

This section provides information on connecting and using a Programming Console. Refer to 5-3 *Programming Console Operation Errors* for details on errors that might occur during Programming Console operations.

#### 4-3-1 Compatible Programming Consoles

There are two Programming Consoles that can be used with the CPM2A: The CQM1-PRO01-E and the C200H-PRO27-E. The key functions for these Programming Consoles are identical.

Press and hold the Shift Key to input a letter shown in the upper-left corner of the key or the upper function of a key that has two functions. For example, the CQM1-PRO01-E's AR/HR Key can specify either the AR or HR Area; press and release the Shift Key and then press the AR/HR Key to specify the AR Area.

##### CQM1-PRO01-E

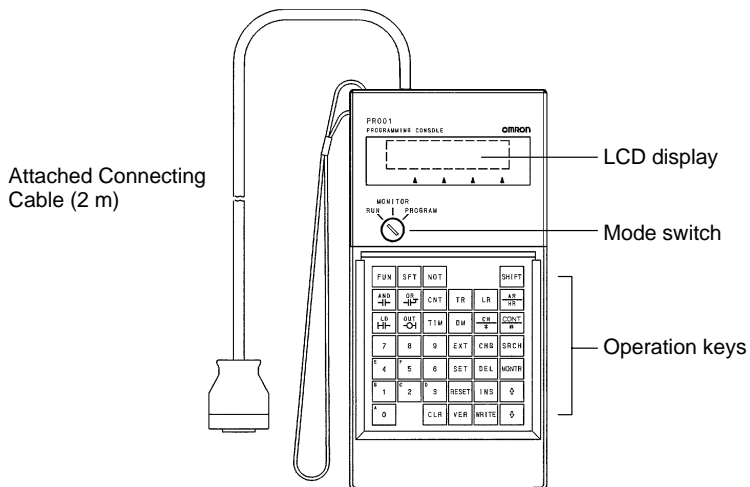



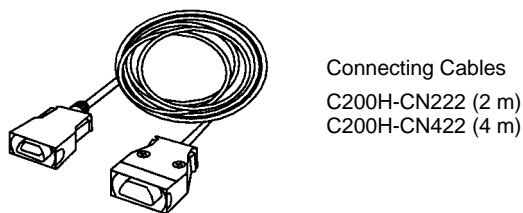
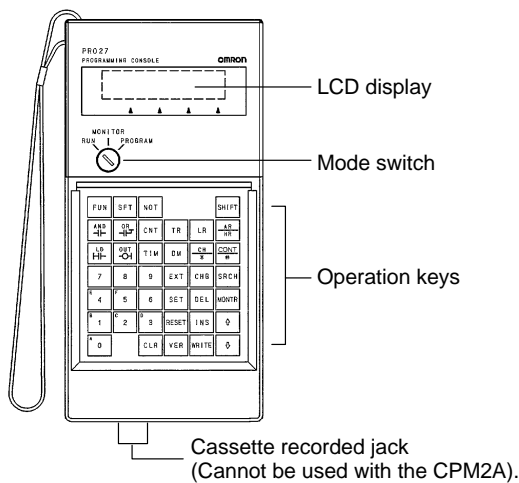



##### C200H-PRO27-E



**Different Keys**

The following keys are labeled differently on the CQM1-PRO01-E and the C200H-PRO27-E, but the operation of the keys in each pair is identical.

CQM1-PRO01-E Keys	C200H-PRO27-E Keys
	
	
	

**Note** To specify the AR area, use SHIFT and HR Keys for the C200H-PRO27-E and use SHIFT and AR/HR Keys for the CQM1-PRO01-E.

A shift symbol will be displayed in the upper-right corner of the screen when the Shift Key is pressed. The shift input can be cleared by pressing the Shift Key again.



**Mode Switch**

The mode switch controls the CPM2A's operating mode. The key can be removed when the switch is set to RUN or MONITOR but it cannot be removed when the switch is set to PROGRAM.

**Contrast Control**

The display contrast can be adjusted with the control on the right side of the Programming Console.

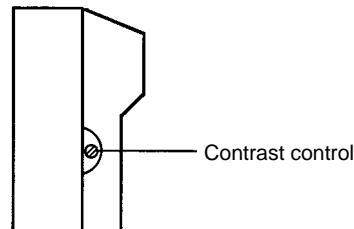

**Buzzer Volume**

The C200H-PRO27-E's buzzer volume can be adjusted with the lever on the right side of the Programming Console. The CQM1-PRO01-E's buzzer volume cannot be adjusted.

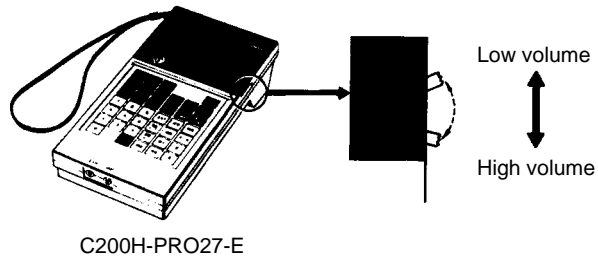

**Note** The buzzer volume can be turned on and off with a key operation. See 4-4-4 Buzzer Operation for details.

### 4-3-2 Changing the CPM2A's Mode with the Mode Switch

Once the Programming Console has been connected, its mode switch can be used to change the CPM2A's operating mode. The mode display (<PROGRAM>, <MONITOR>, or <RUN>) will appear on the Programming Console screen.

- No key operations can be performed while the mode display is displayed on the Programming Console screen. Press CLR to clear the display so that key operations can be performed.
- If the SHIFT Key is pressed while the mode switch is turned, the original display will remain on the Programming Console's screen and the mode display won't appear.
- The CPM2A will enter RUN mode automatically if a Programming Console isn't connected when the CPM2A is turned on.

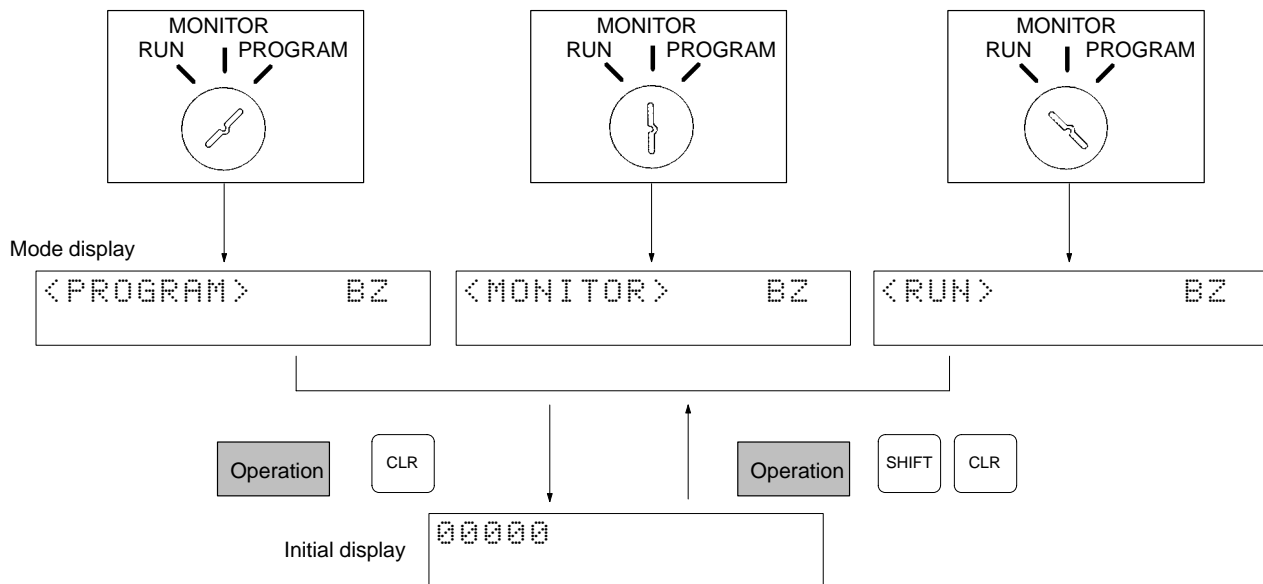

#### Operating Modes

##### PROGRAM Mode

The CPM2A program isn't executed in PROGRAM mode. Use PROGRAM mode to create and edit the program, clear memory, or check the program for errors.

##### MONITOR Mode

The CPM2A program is executed in MONITOR mode and I/O is processed just as it is in RUN mode. Use MONITOR mode to test system operations, such as monitoring CPM2A operating status, force-setting and resetting I/O bits, changing the SV/PV of timers and counters, changing word data, and online editing.

##### RUN Mode

This is the CPM2A's normal operating mode. The CPM2A's operating status can be monitored from a Programming Device, but bits can't be force-set/force-reset and the SV/PV of timers and counters can't be changed.

**Caution** Check the system thoroughly before changing the operating mode of the PC to prevent any accidents that might occur when the program is first started.

**Caution** Never change the mode while pressing any of the keys.

**Startup Operating Mode**

The operating mode of the CPM2A when the power is turned ON depends upon the PC Setup setting in DM 6600 and the Programming Console's mode switch setting if the Programming Console is connected.

PC Setup setting (DM 6600)	Programming Console connected	Programming Console not connected
0000	The startup mode determined by the mode switch setting.	RUN mode if no Programming Device is connected. PROGRAM mode if another Programming Device is connected.
0100	The startup mode is the same as the operating mode before power was interrupted.	
0200	PROGRAM mode	
0201	MONITOR mode	
0202	RUN mode	

**Note** The default setting is 0000. If a Programming Console is not connected, the PC will automatically enter RUN mode. Be sure that it is safe for the PC to operate before turning on the PC without a Programming Console connected.

**4-3-3 Connecting the Programming Console**

Connect the Programming Console's connecting cable to the CPM2A's peripheral port, as shown below.

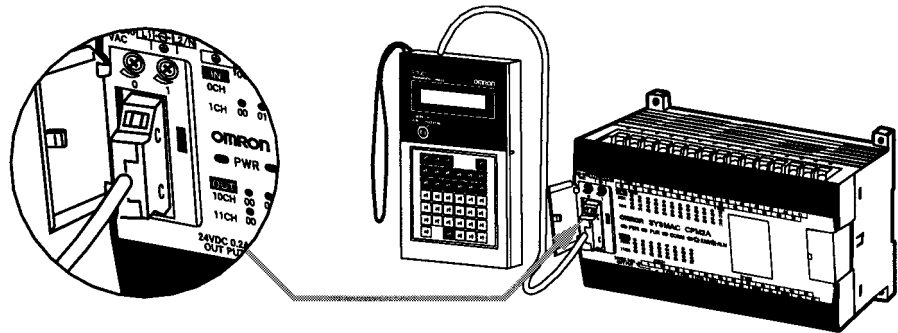

**Panel Installation**

The C200H-PRO27-E Programming Console can be installed in a control panel as shown in the following diagram. (The C200H-ATT01 Mounting Bracket is sold separately.)

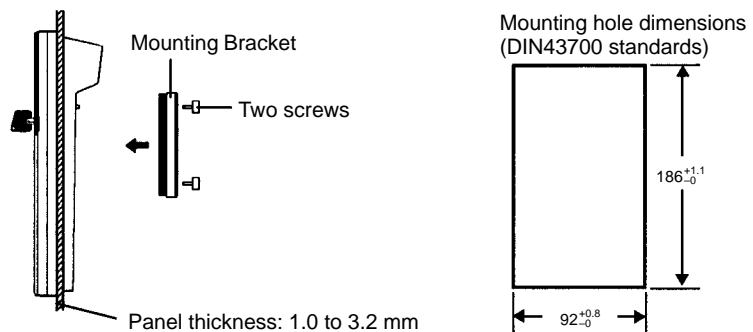

Allow at least 80 mm for the cable connector above the Programming Console.

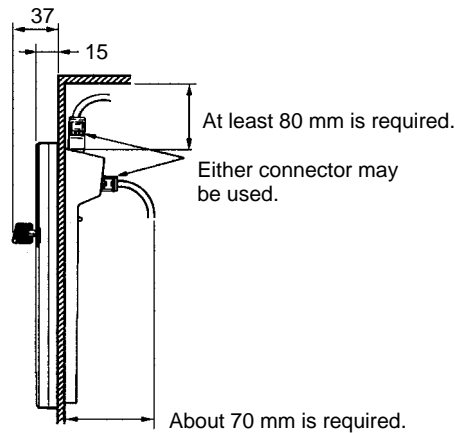

#### 4-3-4 Preparation for Operation

This section describes the procedures required to begin Programming Console operation when using the Programming Console for the first time.

**! Caution** Always confirm that the Programming Console is in PROGRAM mode when turning ON the PC with a Programming Console connected unless another mode is desired for a specific purpose. If the Programming Console is in RUN mode when PC power is turned ON, any program in Program Memory will be executed, possibly causing a PC-controlled system to begin operation.

The following sequence of operations must be performed before beginning initial program input.

- 1, 2, 3...**
1. Be sure that the PC is OFF.
  2. Connect the Programming Console to the CPU Unit's peripheral port. See *4-3-3 Connecting the Programming Console* for details. (The CPU Unit's Communications Switch setting has no effect on communications with the Programming Console.)
  3. Set the mode switch to PROGRAM mode.
  4. Turn ON the PC.
  5. Enter the password. See *4-3-5 Entering the Password* for details.
  6. Clear (All Clear) the PC's memory. See *4-4-2 Clearing Memory* for details.
  7. Read and clear all errors and messages. See *4-4-3 Reading/Clearing Error Messages* for details.
  8. Start programming.

#### 4-3-5 Entering the Password

To gain access to the PC's programming functions, you must first enter the password. The password prevents unauthorized access to the program.

The PC prompts you for a password when PC power is turned on or, if PC power is already on, after the Programming Console has been connected to the PC. To gain access to the system when the "Password!" message appears, press CLR and then MONTR. Then press CLR to clear the display.

If the Programming Console is connected to the PC when PC power is already on, the first display below will indicate the mode the PC was in before the Programming Console was connected. **Ensure that the PC is in PROGRAM mode before you enter the password.** When the password is entered, the PC will shift to the mode set on the mode switch, causing PC operation to begin if the mode is set to RUN or MONITOR with the mode switch after entering the password.

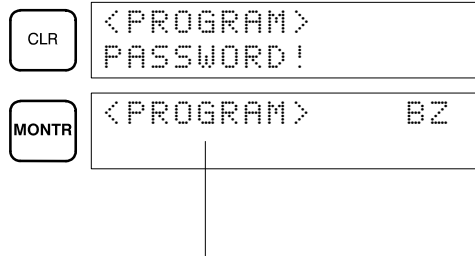

Indicates the mode set by the mode selector switch.



## 4-4 Programming Console Operations

### 4-4-1 Overview

The following table lists the programming and monitoring operations that can be performed from a Programming Console. Refer to the rest of this section for details on operational procedures.

Name	Function	Page
<b>Clearing memory</b>	Clears all or part of the Program Memory and any data areas that are not read-only, as well as the contents of the Programming Console's memory.	102
<b>Reading/clearing error messages</b>	Displays and clears error messages and displays MESSAGE instruction messages.	103
<b>Buzzer operation</b>	Turns on and off the buzzer that sounds when Programming Console keys are pressed.	103
<b>Assigning expansion instruction function codes</b>	Reads or changes the function codes assigned to expansion instructions	104
<b>Setting a program memory address</b>	Sets the specified program memory address when reading, writing, inserting and deleting programs.	105
<b>Reading a program memory address</b>	Reads the contents of the Program Memory. Displays the status of the currently displayed bit in PROGRAM and MONITOR modes.	105
<b>Instruction search</b>	Finds occurrences of the specified instruction in the program.	108
<b>Bit operand search</b>	Finds occurrences of the specified operand bit in the program.	109
<b>Inserting and deleting instructions</b>	Inserts or deletes instructions from the program.	110
<b>Entering or editing programs</b>	Overwrites the contents of the current Program Memory to either input a program for the first time or to change a program that already exists.	105
<b>Checking the program</b>	Checks for programming errors and displays the program address and error when errors are found.	111
<b>Bit, digit, word monitor</b>	Monitors the status of up to 16 bits and words, although only 3 can be shown on the display at one time.	111
<b>Multiple address monitor</b>	Monitors the status of up to 6 bits and words simultaneously.	113
<b>Differentiation monitor</b>	Monitors the up or down differentiation status of a particular bit.	113
<b>Binary monitor</b>	Monitors the ON/OFF status of any word's 16 bits.	114
<b>3-word monitor</b>	Monitors the status of three consecutive words.	115
<b>Signed decimal monitor</b>	Converts the contents of the specified word from signed hexadecimal (two's complement format) to signed decimal for display.	115
<b>Unsigned decimal monitor</b>	Converts hexadecimal data in a word to unsigned decimal for display.	116
<b>3-word data modification</b>	Changes the contents of one or more of the 3 consecutive words displayed in the 3-Word Monitor operation.	116
<b>Changing timer, counter SV 1</b>	Changes the SV of a timer or counter.	117
<b>Changing timer, counter SV 2</b>	Makes fine adjustment changes to the SV of the timer or counter.	118
<b>Hexadecimal, BCD data modification</b>	Changes the BCD or hexadecimal value of a word being monitored.	118
<b>Binary data modification</b>	Changes the status of a word's bits when the word is being monitored.	119
<b>Signed decimal data modification</b>	Changes the decimal value of a word being monitored as signed decimal data, within a range of -32,768 to 32,767. The contents of the specified word are converted automatically to signed hexadecimal (two's complement format.)	119
<b>Unsigned decimal data modification</b>	Changes the decimal value of a word being monitored as unsigned decimal data, within a range of 0 to 65,535. A change into hexadecimal data is made automatically.	120
<b>Force set/reset</b>	Forces bits ON (force set) or OFF (force reset.)	121
<b>Clear force set/reset</b>	Restores the status of all bits which have been force set of reset.	122
<b>Hex-ASCII display change</b>	Converts word data displays back and forth between 4-digit hexadecimal data and ASCII.	122

Name	Function	Page
Displaying the cycle time	Displays the current average cycle time (scan time.)	123
Reading and setting the clock	Reads or sets the internal clock.	123

### 4-4-2 Clearing Memory

This operation is used to clear all or part of the Program Memory and data areas, as well as the contents of the Programming Console's memory. This operation is possible in PROGRAM mode only.

RUN	MONITOR	PROGRAM
No	No	OK

Before beginning to program for the first time or when installing a new program, clear all areas.

#### All Clear

The following procedure is used to clear memory completely, including the program, all data areas, counter PVs, Data Memory, and the PC Setup (DM 6600 to DM 6655).

- 1, 2, 3... 1. Bring up the initial display by pressing the CLR Key repeatedly.
2. Press the SET, NOT, and then the RESET Key to begin the operation.

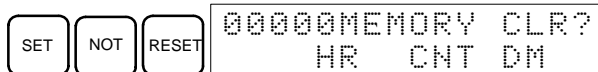

3. Press the MONTR Key to clear memory completely.

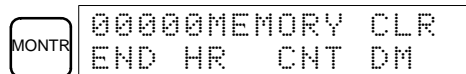

**Caution** The PC Setup (DM 6600 through DM 6655) will be cleared when this operation is performed.

#### Partial Clear

It is possible to retain the data in specified areas or part of the Program Memory. To retain the data in the HR, TC, or DM Areas, press the appropriate key after pressing SET, NOT, and RESET. Any data area that still appears on the display will be cleared when the MONTR Key is pressed.

The HR Key is used to specify both the AR and HR Areas, the CNT Key is used to specify the entire timer/counter area, and the DM Key is used to specify the DM Area.

It is also possible to retain a portion of the Program Memory from the first memory address to a specified address. After designating the data areas to be retained, specify the first Program Memory address to be cleared. For example, input 030 to leave addresses 000 to 029 untouched, but to clear addresses from 030 to the end of Program Memory.

As an example, follow the procedure below to retain the timer/counter area and Program Memory addresses 000 through 122:

- 1, 2, 3... 1. Press the CLR Key to bring up the initial display.
2. Press the SET, NOT, and then the RESET Key to begin the operation.
3. Press the CNT Key to remove the timer/counter area from the data areas shown on the display. (Counter PVs will not be cleared.)

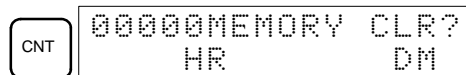

4. Press 123 to specify 123 as the starting program address.

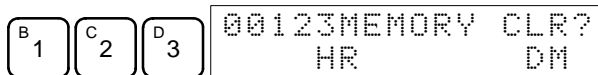

5. Press the MONTR Key to clear the specified regions of memory.

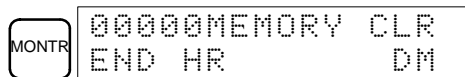

### 4-4-3 Reading/Clearing Error Messages

This operation is used to display and clear error messages. It is possible to display and clear non-fatal errors and MESSAGE instruction messages in any mode, but fatal errors can be cleared in PROGRAM mode only.

RUN	MONITOR	PROGRAM
OK	OK	OK

Before inputting a new program, any error messages recorded in memory should be cleared. It is assumed here that the causes of any of the errors for which error messages appear have already been taken care of. If the buzzer sounds when an attempt is made to clear an error message, eliminate the cause of the error, and then clear the error message. (Refer to *Section 5 Test Runs and Error Processing* for troubleshooting information.)

#### Key Sequence

Follow the procedure below to display and clear messages.

- 1, 2, 3... 1. Press the CLR Key to bring up the initial display.
2. Press the FUN and then the MONTR Key to begin the operation. If there are no messages, the following display will appear:

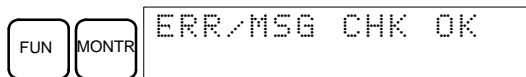

If there are messages, the most serious message will be displayed when the MONTR Key is pressed. Pressing MONTR again will clear the present message and display the next most serious error message. Continue pressing MONTR until all messages have been cleared. These are some examples of error messages:

A memory error:

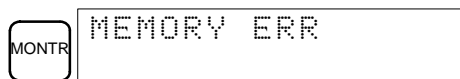

A system error:

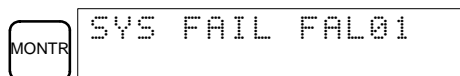

A message (displayed with MSG(46)):

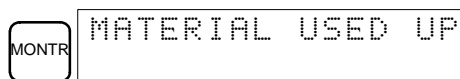

All messages cleared:

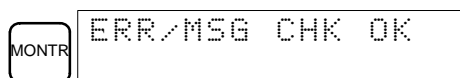

### 4-4-4 Buzzer Operation

This operation is used to turn on and off the buzzer that sounds when Programming Console keys are pressed. This buzzer will also sound whenever an error occurs during PC operation. Buzzer operation for errors is not affected by this setting.

This operation is possible in any mode.

RUN	MONITOR	PROGRAM
OK	OK	OK

**Key Sequence**

Follow the procedure below to turn the key-input buzzer on and off.

- 1, 2, 3...** 1. Press the CLR, SHIFT, and then the CLR Key to bring up the mode display. In this case the PC is in PROGRAM mode and the buzzer is ON.

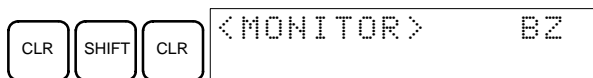

2. Press the SHIFT and then the 1 Key to turn off the buzzer.

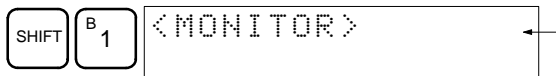

The buzzer will not sound when "BZ" is not displayed.

3. Press the SHIFT and then the 1 Key again to turn the buzzer back ON.

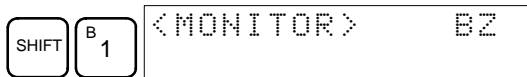

### 4-4-5 Assigning Expansion Instruction Function Codes

This operation is used to display or change the expansion instructions assigned to expansion instruction function codes. The assignments can be displayed in any mode, but can be changed in PROGRAM mode only.

Operation	RUN	MONITOR	PROGRAM
Read assignment	OK	OK	OK
Change assignment	No	No	OK

Assign expansion instruction function codes before inputting the program. The CPM2A will not operate properly if expansion instructions aren't assigned correctly. An expansion instruction can be assigned to one function code only.

The PC Setup must be set for user-defined expansion instruction assignments. Set bits 8 to 11 of DM 6602 to 1 and turn the PC's power off and then on again to enable the new setting.

There is a table on page 85 showing the default function code assignments in the CPM2A.

- 1, 2, 3...** 1. Press the CLR Key to bring up the initial display.  
2. Press the EXT Key to display the assignment for the first function code (17).

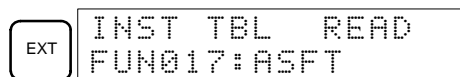

3. Press the Up and Down Arrow Keys to scroll through the expansion instruction function codes.

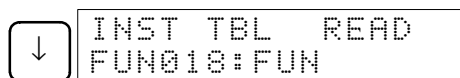

4. Press the CHG Key to assign a different expansion instruction to the selected function code.

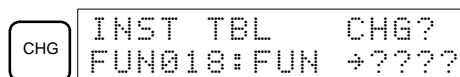

5. Press the Up and Down Arrow Keys to scroll through the expansion instructions that can be assigned to the selected function code.

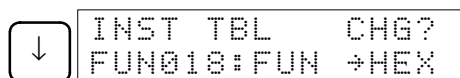

- Press the WRITE Key to assign the displayed instruction to the function code.

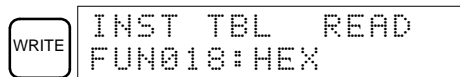

### 4-4-6 Setting and Reading a Program Memory Address and Monitoring I/O Bit Status

This operation is used to display the specified program memory address and is possible in any mode. In the RUN or MONITOR mode, the I/O bit status of bits in the program will be displayed.

RUN	MONITOR	PROGRAM
OK	OK	OK

When inputting a program for the first time, it is generally written to Program Memory starting from address 000. Because this address appears when the display is cleared, it is not necessary to specify it.

When inputting a program starting from other than 000 or to read or modify a program that already exists in memory, the desired address must be designated.

- 1, 2, 3... 1. Press the CLR Key to bring up the initial display.
2. Input the desired address. It is not necessary to input leading zeroes.

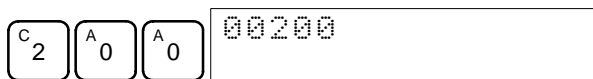

3. Press the Down Arrow Key.

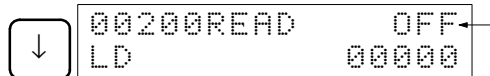

In the RUN or MONITOR mode, ON/OFF status of the bit will be displayed.

Pressing the MONTR Key will change to the I/O monitor display. Bits can be force-set or force-reset from the I/O monitor display. Press the CLR Key to return to I/O bit status monitoring of the initial address.

**Note** The ON/OFF status of any displayed bit will be shown if the PC is in RUN or MONITOR mode.

4. Press the Up and Down Arrow Keys to scroll through the program.

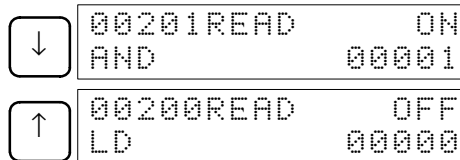

### 4-4-7 Entering or Editing Programs

This operation is used enter or edit programs. It is possible in PROGRAM mode only.

RUN	MONITOR	PROGRAM
No	No	OK

The same procedure is used to either input a program for the first time or to change a program that already exists. In either case, the current contents of Program Memory is overwritten.

The program shown in the following diagram will be entered to demonstrate this operation.

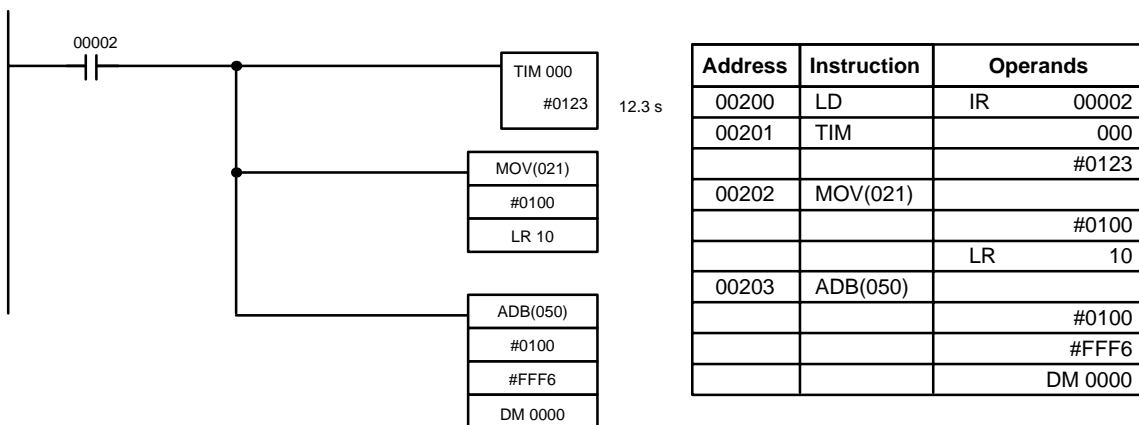

- 1, 2, 3...**
1. Press the CLR Key to bring up the initial display.
  2. Specify the address where the program will begin.
  3. Input the address where the program will begin and press the Down Arrow Key. It is not necessary to input leading zeroes.

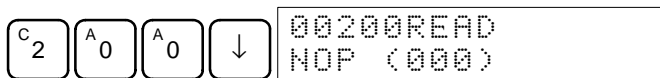

4. Input the first instruction and operand.

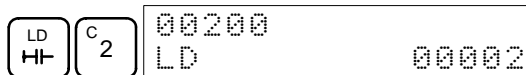

5. Press the WRITE Key to write the instruction to Program Memory. The next program address will be displayed.

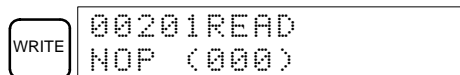

If a mistake was made inputting the instruction, press the Up Arrow Key to return to the previous program address and input the instruction again. The mistaken instruction will be overwritten

To specify the Completion Flag for a timer or counter, press the LD, AND, OR, or NOT Key followed by the TIM or CNT Key, and then input the timer/counter number last.

6. Input the second instruction and operand. (In this case it isn't necessary to enter the timer number, because it's 000.) Press the WRITE Key to write the instruction to Program Memory.

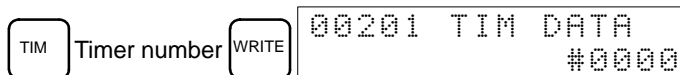

7. Input the second operand (123 to specify 12.3 seconds) and press the WRITE Key. The next program address will be displayed.

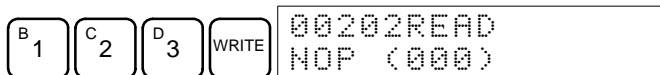

If a mistake was made inputting the operand, press the Up Arrow Key to return to display the mistaken operand and input the operand again.

- Note**
- a) Counters are input in the same basic way as timers except the CNT Key is pressed instead of the TIM Key.
  - b) Timer and counter SVs are input in BCD, so it isn't necessary to press the CONT/# Key.

- Input the third instruction and its operands. First input the instruction by pressing the FUN Key and then the function code (21 in this case).

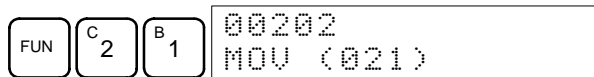

To input the differentiated version of an instruction, press the NOT Key after the function code (FUN 2 1 NOT). The “@” symbol will be displayed next to differentiated instructions. Press the NOT Key again to change back the instruction back to a non-differentiated instruction. The “@” symbol will disappear.

To change an instruction after it has been entered, simply scroll through the program until the desired instruction is displayed and press the NOT Key. The “@” symbol should be displayed next to the instruction.

- Press the WRITE Key to write the instruction to Program Memory. The input display for the first operand will be displayed.

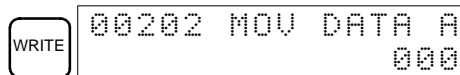

**• Writing Hexadecimal, BCD Constant**

- Input the first operand.

The operands of MOV (21) are normally word addresses, but a constant can be input by pressing the CONT/# Key first. When the CONT/# Key is pressed, the display will change to “#0000,” indicating that a constant can be entered.

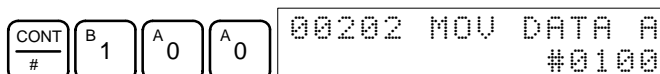

Press the WRITE Key to write the instruction to Program Memory. The input display for the second operand will appear.

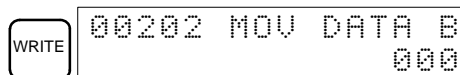

**Note** The operands of MOV(21) can be word addresses, so the CONT/# Key must be pressed to input a constant.

**• Writing a Word Address**

- Input the second operand.

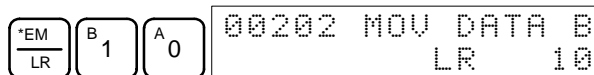

Press the WRITE Key to write the instruction to Program Memory. The next program address will be displayed.

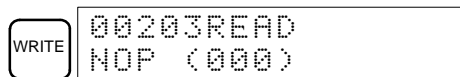

**Note** When the default display value is “000”, a word address can be input immediately without pressing the Shift and CH/# Keys.

- Input the next instruction.

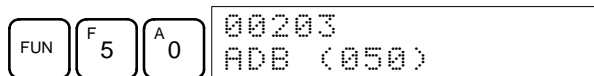

Press the WRITE Key to write the instruction to Program Memory.

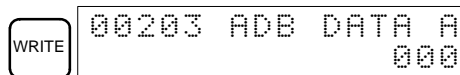

**• Writing an Unsigned Decimal Number**

13. The first operand is input as an unsigned integer.

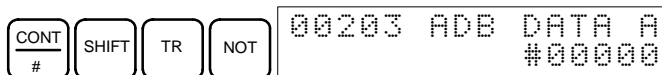

Input the value of the operand from 0 to 65535.

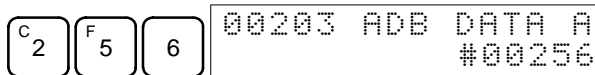

**Note** If an erroneous input is made, press the CLR Key to restore the status prior to the input. Then enter the correct input.

14. Restore the hexadecimal display.

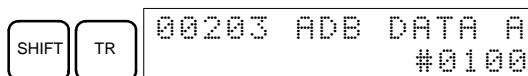

**Note** If an input is made outside of the permissible range, a buzzer will sound and the hexadecimal display will not be displayed.

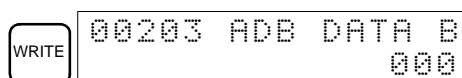

15. The second operand is input as a signed integer.

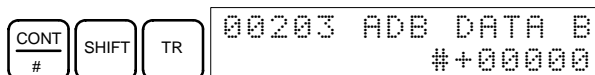

Input the value of the operand from -32,768 to 32,767. Use the SET Key to input a positive number, and use the RESET Key to input a negative number.

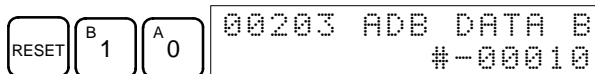

**Note** If an erroneous input is made, press the CLR Key to restore the status prior to the input. Then enter the correct input.

16. Restore the hexadecimal display.

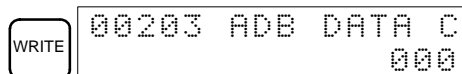
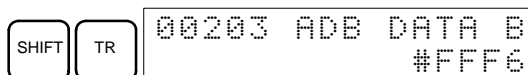

• **Writing a Word Address (DM 0000)**

17. Input the final operand and then press the WRITE Key. (It isn't necessary to input leading zeroes.)

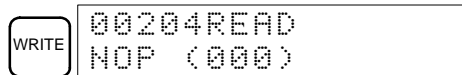
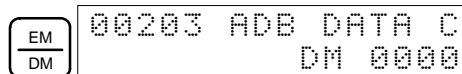

### 4-4-8 Instruction Search

This operation is used to find occurrences of the specified instruction in the program and is possible in any mode.

RUN	MONITOR	PROGRAM
OK	OK	OK

The ON/OFF status of any displayed bit will be shown if the PC is in RUN or MONITOR mode.

- 1, 2, 3... 1. Press the CLR Key to bring up the initial display.



- Input the address from which the search will begin and press the Down Arrow Key. It is not necessary to input leading zeroes.

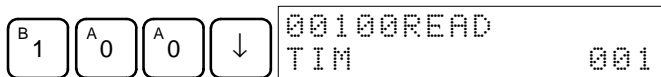

- Input the instruction to be found and press the SRCH Key. In this case, the search is for OUT 01000.

In this case, the next OUT 01000 instruction is at address 200, as shown below.



- Press the Down Arrow Key to display the instruction's operands or press the SRCH Key to search for the next occurrence of the instruction.
- The search will continue until an END instruction or the end of Program Memory is reached. In this case, an END instruction was reached at address 397.

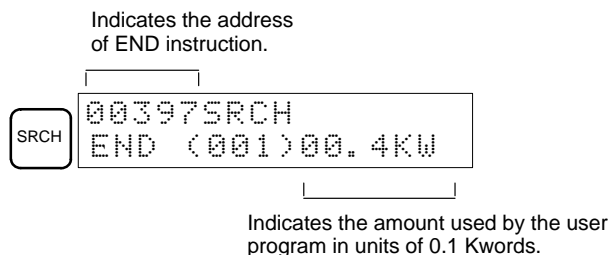

### 4-4-9 Bit Operand Search

This operation is used to find occurrences of the specified operand bit in the program and is possible in any mode.

RUN	MONITOR	PROGRAM
OK	OK	OK

The ON/OFF status of any displayed bit will be shown if the PC is in RUN or MONITOR mode.

- 1, 2, 3... Press the CLR Key to bring up the initial display.
- Input the operand address. It is not necessary to input leading zeroes.

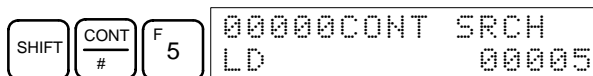

- Press the SRCH Key to begin the search.

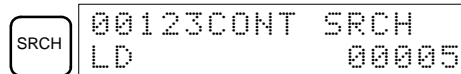

- Press the SRCH Key to search for the next occurrence of the operand bit.



- The search will continue until an END instruction or the end of Program Memory is reached. In this case, an END instruction was reached.

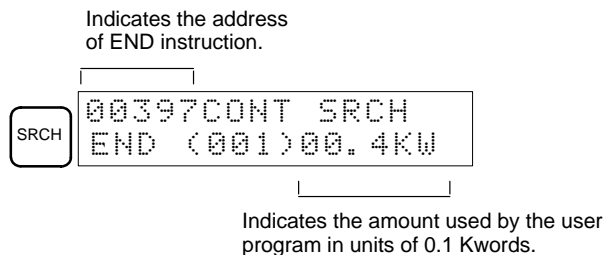

### 4-4-10 Inserting and Deleting Instructions

This operation is used to insert or delete instructions from the program. It is possible in PROGRAM mode only.

RUN	MONITOR	PROGRAM
No	No	OK

To demonstrate this operation, an IR 00105 NO condition will be inserted at program address 00206 and an IR 00103 NO condition deleted from address 00205, as shown in the following diagram.

Original Program

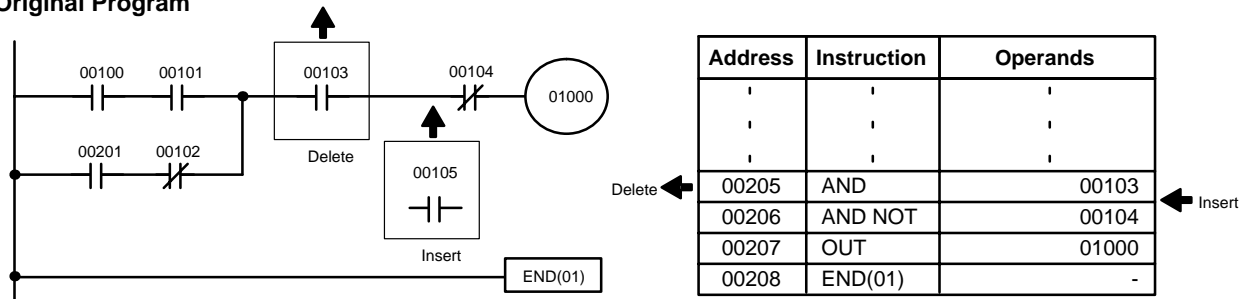

#### Insertion

Follow the procedure below to insert the IR 00105 NO condition at address 00206.

1, 2, 3...

1. Press the CLR Key to bring up the initial display.
2. Input the address where the NO condition will be inserted and press the Down Arrow Key. It is not necessary to input leading zeroes.

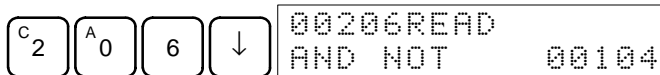

3. Input the new instruction and press the INS Key.



4. Press the Down Arrow Key to insert the new instruction.

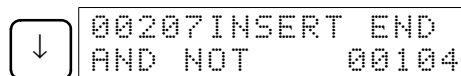

**Note** For instructions that require more operands (such as set values), input the operands and then press the WRITE Key.

#### Deletion

Follow the procedure below to delete the IR 00103 NO condition at address 00205.

1, 2, 3...

1. Press the CLR Key to bring up the initial display.
2. Input the address where the NO condition will be deleted and press the Down Arrow Key. It is not necessary to input leading zeroes.

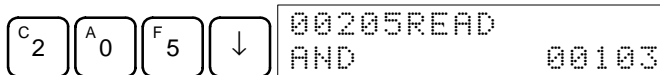

3. Press the DEL Key.

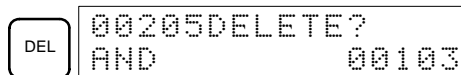

4. Press the Up Arrow Key to delete the specified instruction.

If the instruction has more operands, the operands will be deleted automatically with the instruction.

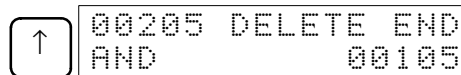

After completing the insertion and deletion procedures, use the Up and Down Arrow Keys to scroll through the program and verify that it has been changed correctly, as shown in the following diagram.

**Corrected Program**

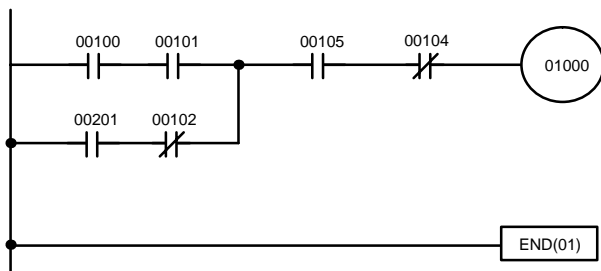

Address	Instruction	Operands
00205	AND	00105
00206	AND NOT	00104
00207	OUT	01000
00208	END(01)	-

### 4-4-11 Checking the Program

This operation checks for programming errors and displays the program address and error when errors are found. It is possible in PROGRAM mode only.

RUN	MONITOR	PROGRAM
No	No	OK

- 1, 2, 3...**
1. Press the CLR Key to bring up the initial display.
  2. Press the SRCH Key. An input prompt will appear requesting the desired check level.

SRCH 000000PROG CHK  
CHK LBL (0-2)?

3. Input the desired check level (0, 1, or 2). The program check will begin when the check level is input, and the first error found will be displayed.

A 0 00178CIRCUIT ERR  
OUT 00200

**Note** Refer to 5-4 *Programming Errors* for details on check levels and the errors that may be detected when the program is checked.

4. Press the SRCH Key to continue the search. The next error will be displayed. Continue pressing the SRCH Key to continue the search. The search will continue until an END instruction or the end of Program Memory is reached. A display like this will appear if the end of Program Memory is reached:

SRCH 00300NO END INST  
END

A display like this will appear if an END instruction is reached:

SRCH 00310PROG CHK  
END (001)00.3KW

No more errors exist if the END instruction is displayed.

If errors are displayed, edit the program to correct the errors and check the program again. Continue checking the program by pressing the SRCH Key again until all errors have been corrected.

### 4-4-12 Bit, Digit, Word Monitor

This operation is used to monitor the status of up to 16 bits and words, although only 3 can be shown on the display at any one time. Operation is possible in any mode.

RUN	MONITOR	PROGRAM
OK	OK	OK

**Program Read then Monitor**

When a program address is being displayed, the status of the bit or word in that address can be monitored by pressing the MONTR Key.

1, 2, 3...

1. Press the CLR Key to bring up the initial display.
2. Input the desired program address and press the Down Arrow Key.

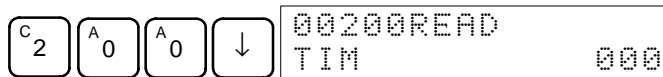

3. Press the MONTR Key to begin monitoring.

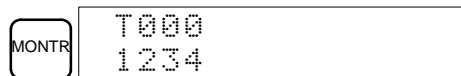

If the status of a bit is being monitored, that bit's status can be changed using the Force Set/Reset operation. Refer to 4-4-24 Force Set, Reset for details.

If the status of a word is being monitored, that word's value can be changed using the Hexadecimal/BCD Data Modification operation. Refer to 4-3-19 Hexadecimal, BCD Data Modification, 4-3-20 Binary Data Modification, 4-3-21 Signed Decimal Data Modification, and 4-3-22 Unsigned Decimal Data Modification for details.

4. Press the CLR Key to end monitoring.

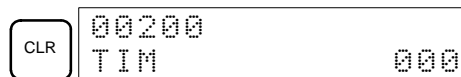

**Bit Monitor**

Follow the procedure below to monitor the status of a particular bit.

1, 2, 3...

1. Press the CLR Key to bring up the initial display.
2. Input the bit address of the desired bit and press the MONTR Key.

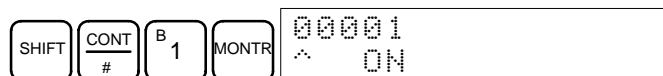

The Up or Down Arrow Key can be pressed to display the status of the previous or next bit.

The displayed bit's status can be changed using the Force Set/Reset operation. Refer to 4-4-24 Force Set, Reset for details.

3. Press the CLR Key to end monitoring.

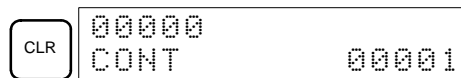

**Word Monitor**

Follow the procedure below to monitor the status of a particular word.

1, 2, 3...

1. Press the CLR Key to bring up the initial display.
2. Input the word address of the desired word.

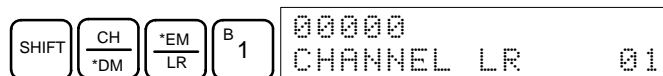

3. Press the MONTR Key to begin monitoring.

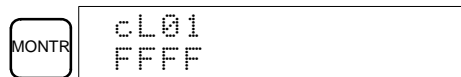

The Up or Down Arrow Key can be pressed to display the status of the previous or next word.

The displayed word's status can be changed using the Hexadecimal/BCD Data Modification operation. Refer to Refer to 4-3-19 Hexadecimal, BCD Data Modification, 4-3-20 Binary Data Modification, 4-3-21 Singed Decimal

Data Modification, and 4-3-22 Unsigned Decimal Data Modification for details.

4. Press the CLR Key to end monitoring.

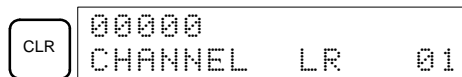

**Note** The operating mode can be changed without altering the current monitor display by holding down the SHIFT Key and then changing the operating mode.

**Multiple Address Monitoring**

The status of up to six bits and words can be monitored simultaneously, although only three can be shown on the display at any one time.

- 1, 2, 3... 1. Press the CLR Key to bring up the initial display.

2. Input the address of the first bit or word and press the MONTR Key.

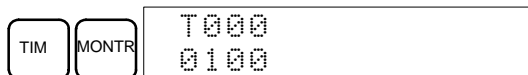

3. Repeat step 2 up to 6 times to display the next addresses to be monitored.

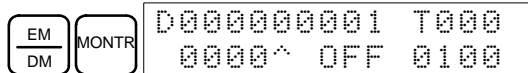
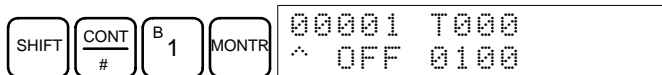

If 4 or more bits and words are being monitored, the bits and words that do not appear on the display can be displayed by pressing the MONTR Key. If the MONTR Key is pressed alone, the display will shift to the right.

If more than six bits and words are input, monitoring of the bit or word input first will be canceled.

4. Press the CLR Key to stop monitoring the leftmost bit or word and clear it from the display.

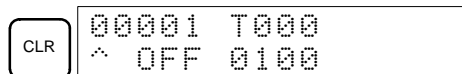

5. Press the SHIFT and CLR Keys to end monitoring altogether.

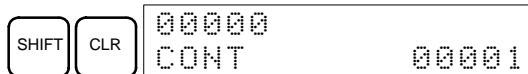

**Note** Press the SHIFT Key, CLR Key, and then CLR Key again to return to the initial Programming Console display with the multiple address monitoring state unchanged. Press the SHIFT Key and then the MONTR Key from the initial display to return to the multiple address monitoring state. The monitoring states can be retained for 6 bits and words.

The operating mode can be changed without altering the current monitor display by holding down the SHIFT Key and then changing the operating mode.

**4-4-13 Differentiation Monitor**

This operation is used to monitor the up or down differentiation status of a particular bit. When detected, the up or down differentiation will be displayed and the buzzer will sound. It is possible in any mode.

RUN	MONITOR	PROGRAM
OK	OK	OK

- 1, 2, 3... 1. Monitor the status of the desired bit according to the procedure described in 4-4-12 Bit, Digit, Word Monitor. If 2 or more bits are being monitored, the desired bit should be leftmost on the display.

In this case the differentiation status of LR 00 will be monitored.

```
L0000000001H0000
^ OFF^ OFF^ OFF
```

- To specify up-differentiation monitoring, press the SHIFT and then the Up Arrow Key. The symbols "U@" will appear.

SHIFT ↑

```
L0000000001H0000
U@OFF^ OFF^ OFF
```

Indicates waiting for the bit to turn ON.

To specify down-differentiation monitoring, press the SHIFT and then the Down Arrow Key. The symbols "D@" will appear.

SHIFT ↓

```
L0000000001H0000
D@OFF^ OFF^ OFF
```

- The buzzer will sound when the specified bit goes from off to on (for up-differentiation) or from on to off (for down-differentiation).

```
L0000000001H0000
^ ON^ OFF^ OFF
```

**Note** The buzzer will not sound if it has been turned off.

- Press the CLR Key to end differentiation monitoring and return to the normal monitoring display.

CLR

```
L0000000001H0000
^ OFF^ OFF^ OFF
```

### 4-4-14 Binary Monitor

This operation is used to monitor the ON/OFF status of any word's 16 bits. It is possible in any mode.

RUN	MONITOR	PROGRAM
OK	OK	OK

- 1, 2, 3... Monitor the status of the desired word according to the procedure described in 4-4-12 *Bit, Digit, Word Monitor*. The desired word should be leftmost on the display if 2 or more words are being monitored.

```
c010
0000
```

(Word monitor)

- Press the SHIFT and then the MONTR Key to begin binary monitoring. The ON/OFF status of the selected word's 16 bits will be shown along the bottom of the display. A 1 indicates a bit is on, and a 0 indicates it is off.

SHIFT MONTR

```
c010 MONTR
0000000000000000
```

↑ Bit 15 ↑ Bit 00

The status of force-set bits is indicated by "S," and the status of a force-reset bits is indicated by "R," as shown below.

```
c010 MONTR
000S0000000R0000
```

↑ Force-set bit ↑ Force-reset bit

**Note** a) The status of displayed bits can be changed at this point. Refer to 4-4-21 *Binary Data Modification* for details.

- b) The Up or Down Arrow Key can be pressed to display the status of the previous or next word's bits.
- 3. Press the CLR Key to end binary monitoring and return to the normal monitoring display.

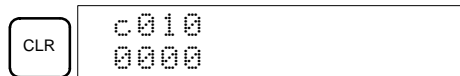

### 4-4-15 Three-Word Monitor

This operation is used to monitor the status of three consecutive words. It is possible in any mode.

RUN	MONITOR	PROGRAM
OK	OK	OK

- 1, 2, 3...
1. Monitor the status of the first of the three words according to the procedure described in 4-4-12 *Bit, Digit, Word Monitor*.  
If 2 or more words are being monitored, the desired first word should be leftmost on the display.



(Word monitor)

2. Press the EXT Key to begin 3-word monitoring. The status of the selected word and the next two words will be displayed, as shown below. In this case, DM 0000 was selected.

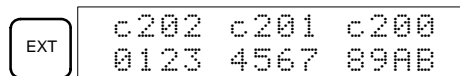

The Up and Down Arrow Keys can be used to shift one address up or down. The status of the displayed words can be changed at this point. Refer to 4-4-18 *Three-word Data Modification*.

The display can be changed to display ASCII text, which is useful when three consecutive words containing an ASCII message are displayed. Refer to 4-4-26 *Hex-ASCII Display Change*.

3. Press the CLR Key to end 3-word monitoring and return to the normal monitoring display. The rightmost word on the 3-word monitor display will be monitored.

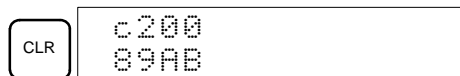

**Note** The operating mode can be changed without altering the current monitor display by holding down the SHIFT Key and then changing the operating mode.

### 4-4-16 Signed Decimal Monitor

This operation converts the contents of the specified word from signed hexadecimal (two's complement format) to signed decimal for display. The operation can be executed while using I/O monitoring, multiple address monitoring or 3-word monitoring.

RUN	MONITOR	PROGRAM
OK	OK	OK

- 1, 2, 3...
1. Monitor the word that is to be used for decimal monitor with sign. During multiple address monitoring, the leftmost word will be converted.

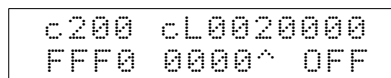

(Multiple address monitor)

2. Press the SHIFT+TR Keys to display the leftmost word as signed decimal.

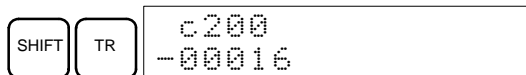

At this point, the contents of the displayed word can be changed with a signed-decimal input. Refer to 4-4-22 Signed Decimal Data Modification.

3. Press the CLR Key or the SHIFT+TR Keys to end the unsigned decimal display and return to normal monitoring.

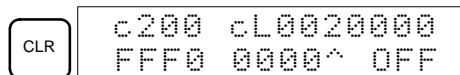

### 4-4-17 Unsigned Decimal Monitor

This operation is used to convert hexadecimal data in a word to unsigned decimal for display. The operation can be executed while using I/O monitoring, multiple address monitoring or 3-word monitoring.

RUN	MONITOR	PROGRAM
OK	OK	OK

- 1, 2, 3... 1. Monitor the word that is to be used for decimal monitor without sign. During multiple address monitoring, the leftmost word will be converted.

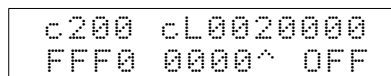

Multiple address monitoring

2. Press the SHIFT+TR+NOT Keys to display the leftmost word as unsigned decimal.

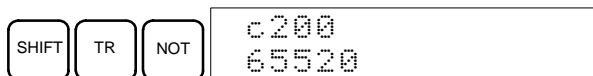

At this point, the contents of the displayed word can be changed with an unsigned-decimal input. Refer to 4-4-23 Unsigned Decimal Data Modification.

3. Press the CLR Key or the SHIFT+TR Keys to end the unsigned decimal display and return to normal monitoring.

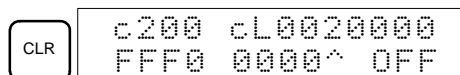

### 4-4-18 Three-Word Data Modification

This operation is used to change the contents of one or more of the 3 consecutive words displayed in the Three-Word Monitor operation. It is possible in MONITOR or PROGRAM mode only.

RUN	MONITOR	PROGRAM
No	OK	OK

**Caution** Before changing the contents of I/O memory, be sure that the changes will not cause equipment to operate unexpectedly or dangerously. In particular, take care when changing the status of output bits. The PC continues to refresh I/O bits even if the PC is in PROGRAM mode, so devices connected to output points on the CPU Unit, Expansion Units, or Expansion I/O Units may operate unexpectedly.

- 1, 2, 3... 1. Monitor the status of the desired words according to the procedure described 4-4-15 Three-Word Monitor.

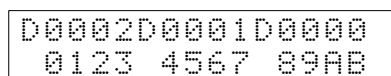

(Three-word monitor)



- Press the CHG Key to begin 3-word data modification. The cursor will appear next to the contents of the leftmost word.

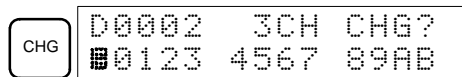

- Input the new value for the leftmost word on the display and press the CHG Key if more changes will be made. (Input the new value and press the WRITE Key to write the changes in memory if no more changes will be made.)

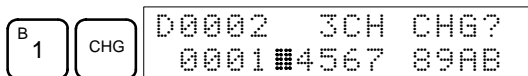

- Input the new value for the middle word on the display and press the CHG Key if the rightmost word will be changed. Input the new value and press the WRITE Key to write the changes in memory if the rightmost word will not be changed. (In this case, it will not.)

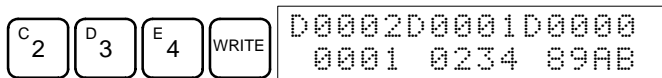

**Note** If the CLR Key is pressed before the WRITE Key, the operation will be cancelled and the 3-word monitor display will return without any changes in data memory.

### 4-4-19 Changing Timer, Counter SV

There are two operations that can be used to change the SV of a timer or counter. They are possible in MONITOR or PROGRAM mode only. In MONITOR mode, the SV can be changed while the program is being executed.

RUN	MONITOR	PROGRAM
No	OK	OK

The timer or counter SV can be changed either by inputting a new value or by incrementing or decrementing the current SV.

#### Inputting a New SV Constant

This operation can be used to input a new SV constant, as well as to change an SV from a constant to a word address designation and vice versa. The following examples show how to input a new SV constant and how to change the SV from a constant to an address.

- 1, 2, 3... Press the CLR Key to bring up the initial display.
- Display the desired timer or counter.

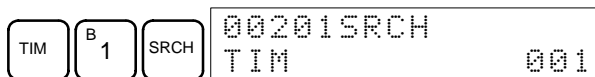

- Press the Down Arrow Key and then the CHG Key.

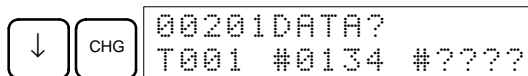

- At this point a new SV constant can be input or the SV constant can be changed to a word address designation
  - To input a new SV constant, input the constant and press the WRITE Key.

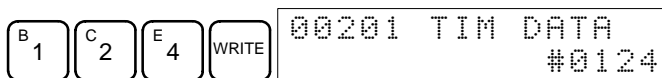

- To change to a word address designation, input the word address and press the WRITE Key.



**Incrementing and Decrementing a Constant**

This operation can be used to increment and decrement an SV constant. It is possible only when the SV has been entered as a constant.

- 1, 2, 3... 1. Press the CLR Key to bring up the initial display.  
2. Display the desired timer or counter.

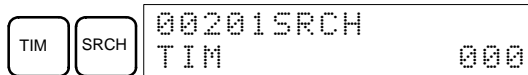

3. Press the Down Arrow, CHG, and then the EXT Key.

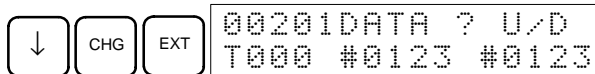

The constant on the left is the old SV and the constant on the right will become the new SV constant in step 5.

4. Press the Up and Down Arrow Keys to increment and decrement the constant on the right. (In this case the SV is incremented once.)

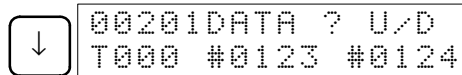

5. Press the CLR Key twice to change the timer's SV to the new value.

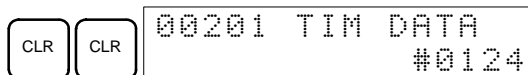

**4-4-20 Hexadecimal, BCD Data Modification**

This operation is used to change the BCD or hexadecimal value of a word being monitored using the procedure described in 4-4-12 Bit, Digit, Word Monitor. It is possible in MONITOR or PROGRAM mode only.

RUN	MONITOR	PROGRAM
No	OK	OK

Words SR 253 to SR 255 cannot be changed.

**Caution** Before changing the contents of I/O memory, be sure that the changes will not cause equipment to operate unexpectedly or dangerously. In particular, take care when changing the status of output bits. The PC continues to refresh I/O bits even if the PC is in PROGRAM mode, so devices connected to output points on the CPU Unit, Expansion Units, or Expansion I/O Units may operate unexpectedly.

- 1, 2, 3... 1. Monitor the status of the desired word according to the procedure described in 4-4-12 Bit, Digit, Word Monitor. If two or more words are being monitored, the desired word should be leftmost on the display.



(Word monitor)

2. Press the CHG Key to begin hexadecimal, BCD data modification.

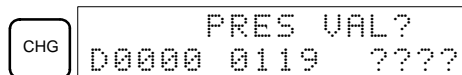

3. Input the new PV and press the WRITE Key to change the PV.

The operation will end and the normal monitoring display will return when the WRITE Key is pressed.

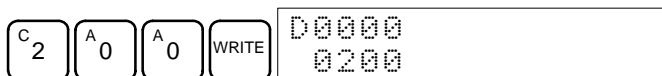



Words SR 253 to SR 255 cannot be changed.

RUN	MONITOR	PROGRAM
No	OK	OK

**Caution** Before changing the contents of I/O memory, be sure that the changes will not cause equipment to operate unexpectedly or dangerously. In particular, take care when changing the status of output bits. The PC continues to refresh I/O bits even if the PC is in PROGRAM mode, so devices connected to output points on the CPU Unit, Expansion Units, or Expansion I/O Units may operate unexpectedly.

- 1, 2, 3...** 1. Monitor (signed decimal) the status of the word for which the present value is to be changed.

```
D0200
-00016
```

(Signed decimal monitor)

2. Press the CHG Key to begin decimal data modification.

```
CHG  PRES VAL?
D0200-00016
```

3. Input the new PV and press the WRITE Key to change the PV. The operation will end and the signed-decimal monitoring display will return when the WRITE Key is pressed.

The PV can be set within a range of -32,768 and 32,767. Use the SET Key to input a positive number, and use the RESET Key to input a negative number.

```
RESET  D 3  C 2  7  6  8  WRITE  D0200
-32768
```

If an erroneous input has been made, press the CLR Key to restore the status prior to the input. Then enter the correct input.

The buzzer will sound if a value outside the specified range is input, allowing no writing.

### 4-4-23 Unsigned Decimal Data Modification

This operation is used to change the decimal value of a word being monitored as unsigned decimal data, within a range of 0 to 65,535. A change into hexadecimal data is made automatically.

Words SR 253 to SR 255 cannot be changed.

RUN	MONITOR	PROGRAM
No	OK	OK

**Caution** Before changing the contents of I/O memory, be sure that the changes will not cause equipment to operate unexpectedly or dangerously. In particular, take care when changing the status of output bits. The PC continues to refresh I/O bits even if the PC is in PROGRAM mode, so devices connected to output points on the CPU Unit, Expansion Units, or Expansion I/O Units may operate unexpectedly.

- 1, 2, 3...** 1. Monitor (unsigned decimal) the status of the word for which the present value is to be changed.

```
c200
65520
```

(Unsigned decimal monitor)

2. Press the CHG Key to begin decimal data modification.

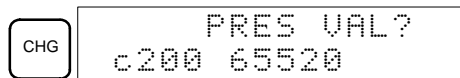

- Input the new PV and press the WRITE Key to change the PV. The operation will end and the decimal-without-sign monitoring display will return when the WRITE Key is pressed.

The PV can be set within a range of 0 to 65,535.



If an erroneous input has been made, press the CLR Key to restore the status prior to the input. Then enter the correct input.

The buzzer will sound if a value outside the specified range is input, allowing no writing.

### 4-4-24 Force Set, Reset

This operation is used to force bits ON (force set) or OFF (force reset) and is useful when debugging the program or checking output wiring. It is possible in MONITOR or PROGRAM mode only.

RUN	MONITOR	PROGRAM
No	OK	OK

**Caution** Before changing the contents of I/O memory, be sure that the changes will not cause equipment to operate unexpectedly or dangerously. In particular, take care when changing the status of output bits. The PC continues to refresh I/O bits even if the PC is in PROGRAM mode, so devices connected to output points on the CPU Unit, Expansion Units, or Expansion I/O Units may operate unexpectedly.

- 1, 2, 3... 1. Monitor the status of the desired bit according to the procedure described in 4-4-12 Bit, Digit, Word Monitor. If two or more words are being monitored, the desired bit should be leftmost on the display.



2. Press the SET Key to force the bit ON or press the RESET Key to force the bit OFF.

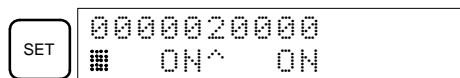

The cursor in the lower left corner of the display indicates that the force set/reset is in progress. Bit status will remain ON or OFF only as long as the key is held down; the original status will return one cycle after the key is released.

3. Press the SHIFT and SET Keys or SHIFT and RESET Keys to maintain the status of the bit after the key is released. In this case, the force-set status is indicated by an "S" and the force-reset status is indicated by an "R."

To return the bit to its original status, press the NOT Key or perform the Clear Force Set/Reset operation. Refer to 4-4-25 Clear Force Set/Reset for details.

Forced status will also be cleared in the following cases:

- When the PC's operating mode is changed (although the forced status will not be cleared when the mode is changed from PROGRAM to MONITOR if SR 25211 is ON)
- When the PC stops because a fatal error occurred

- c) When the PC stops because of a power interruption
- d) When the Clear Force Set/Reset Operation is performed

### 4-4-25 Clear Force Set/Reset

This operation is used to restore the status of all bits which have been force set or reset. It is possible in MONITOR or PROGRAM mode only.

RUN	MONITOR	PROGRAM
No	OK	OK

**Caution** Before changing the contents of I/O memory, be sure that the changes will not cause equipment to operate unexpectedly or dangerously. In particular, take care when changing the status of output bits. The PC continues to refresh I/O bits even if the PC is in PROGRAM mode, so devices connected to output points on the CPU Unit, Expansion Units, or Expansion I/O Units may operate unexpectedly.

- 1, 2, 3...
1. Press the CLR Key to bring up the initial display.
  2. Press the SET and then the RESET Key. A confirmation message will appear.

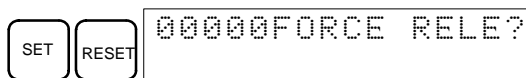

**Note** If you mistakenly press the wrong key, press CLR and start again from the beginning.

3. Press the NOT Key to clear the force-set/reset status of bits in all data areas.

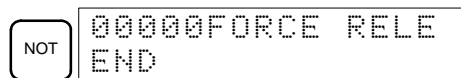

### 4-4-26 Hex-ASCII Display Change

This operation is used to convert word data displays back and forth between 4-digit hexadecimal data and ASCII. It is possible in any mode.

The displayed PV of the timer or counter cannot be changed.

RUN	MONITOR	PROGRAM
OK	OK	OK

- 1, 2, 3...
1. Monitor the status of the desired word(s) according to the procedure described in 4-4-12 Bit, Digit, Word Monitor. While the multiple addresses are being monitored, the leftmost word is subject to change.

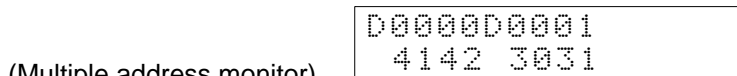

2. Press the TR Key to switch to ASCII display. The display will toggle between hexadecimal and ASCII displays each time the TR Key is pressed.

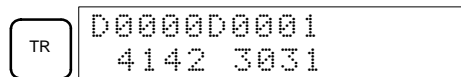
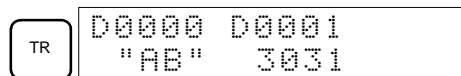

- Note**
1. A message contained in three words can be displayed by using ASCII display in combination with the Three-word monitor operation.
  2. The Hexadecimal, BCD Data Modification Operation can be used while displaying ASCII data. Input values in 4-digit hexadecimal.

### 4-4-27 Displaying the Cycle Time

This operation is used to display the current average cycle time (scan time). It is possible only in RUN or MONITOR mode while the program is being executed.

RUN	MONITOR	PROGRAM
OK	OK	No

- 1, 2, 3... 1. Press the CLR Key to bring up the initial display.  
2. Press the MONTR Key to display the cycle time.

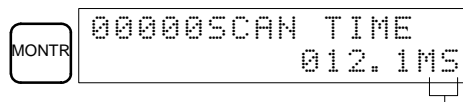

"MS" in the display indicates the unit "ms" for the cycle time.

There might be differences in displayed values when the MONTR Key is pressed repeatedly. These differences are caused by changing execution conditions.

### 4-4-28 Reading and Setting the Clock

This operation is used to read or set the CPU's clock. The clock can be read in any mode, but can be set in MONITOR or PROGRAM mode only.

Operation	RUN	MONITOR	PROGRAM
Read clock	OK	OK	OK
Set clock	No	OK	OK

- 1, 2, 3... 1. Press the CLR Key to bring up the initial display.  
2. Press the FUN Key, SHIFT Key, and then the MONTR Key to display the date and time.

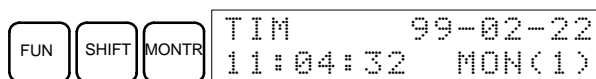

3. Press the CHG Key to change the date and/or time.

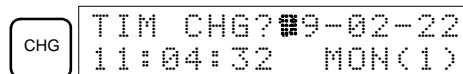

The digit that can be changed will flash. If necessary, input a new value with the Up and Down Arrow Keys or Numeric Keys. Press the CHG Key to move the cursor to the next digit. The following table shows the setting ranges for each value.

Year	Month	Day	Hour	Minute	Second	Day-of-week
00 to 99	01 to 12	01 to 31	00 to 23	00 to 59	00 to 59	0 to 6 (SUN to SAT)

4. Press the WRITE Key to write the new value.

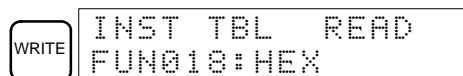

Press the CLR Key to return to the initial display.

## 4-5 Programming Example

This section demonstrates all of the steps needed to write a program with the Programming Console.

### 4-5-1 Preparatory Operations

Use the following procedure when writing a program to the CPM2A for the first time.

- 1, 2, 3... 1. Set the Programming Console's mode switch to PROGRAM mode and turn on the CPM2A's power supply. The password input display will appear on the Programming Console.

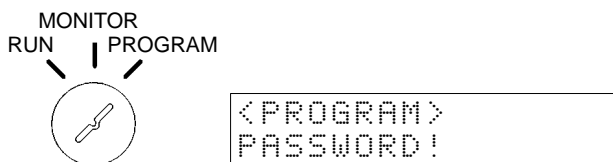

2. Enter the password by pressing the CLR and then the MONTR Key.

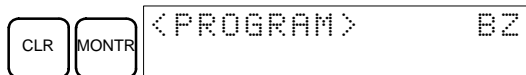

3. Clear the CPM2A's memory by pressing the CLR, SET, NOT, RESET, and then the MONTR Key. Press the CLR Key several times if memory errors are displayed.

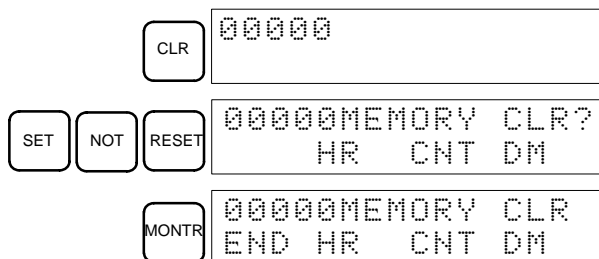

4. Display and clear error messages by pressing the CLR, FUN, and then the MONTR Key. Continue pressing the MONTR Key until all error messages have been cleared.

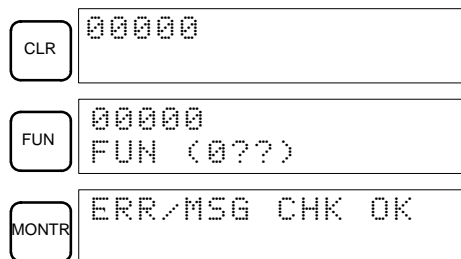

5. Press the CLR Key to bring up the initial programming display (program address 00000). The new program can be written at this point.

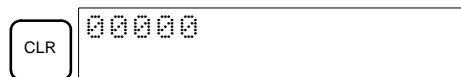

**Caution** Check the system thoroughly before starting or stopping the CPM2A to prevent any accidents that might occur when the program is first started.



### 4-5-2 Example Program

The following ladder program will be used to demonstrate how to write a program with the Programming Console. This program makes output IR 01000 flicker ON/OFF (one second ON, one second OFF) ten times after input IR 00000 is turned ON.

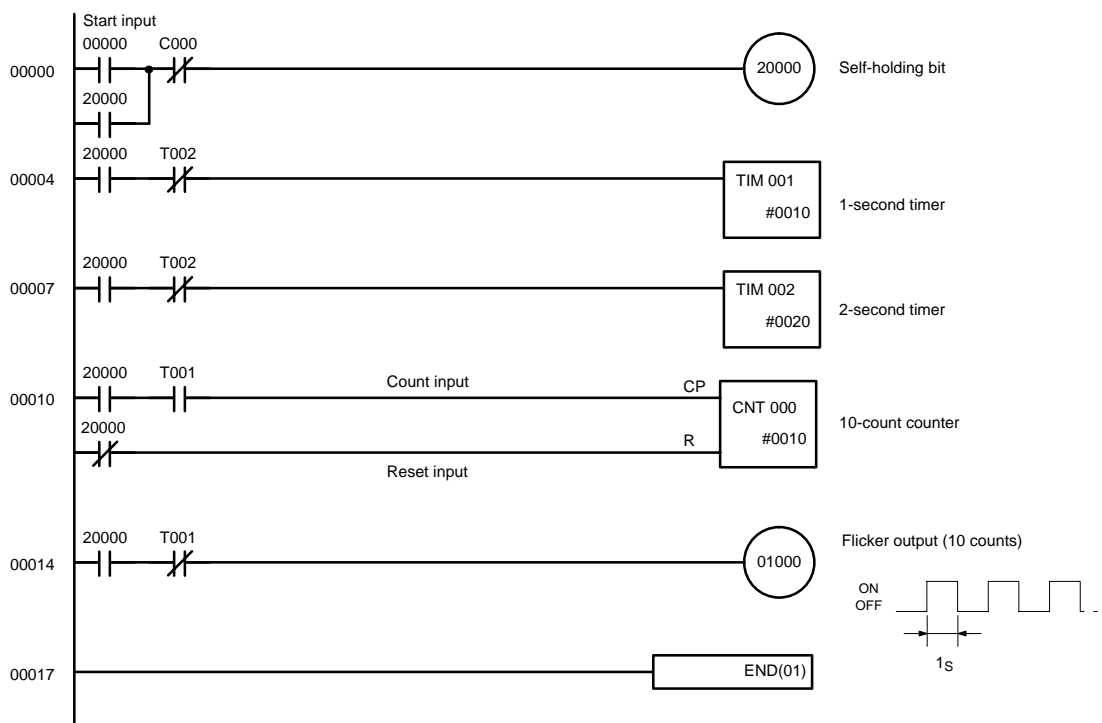

The mnemonic list for the example program is shown in the following table. The steps required to enter this program from a Programming Console are described in 4-5-3 Programming Procedures.

Address	Instruction	Data	Programming example procedures in 4-5-3 Programming Procedures
00000	LD	00000	(1) Self-holding bit
00001	OR	20000	
00002	AND NOT	C 000	
00003	OUT	20000	
00004	LD	20000	(2) 1-second timer
00005	AND NOT	T 002	
00006	TIM	001 # 0010	
00007	LD	20000	(3) 2-second timer
00008	AND NOT	T 002	
00009	TIM	002 # 0020	
00010	LD	20000	(4) 10-count counter
00011	AND	T 001	
00012	LD NOT	20000	
00013	CNT	000 # 0010	
00014	LD	20000	(5) Flicker output (10 counts)
00015	AND NOT	T 001	
00016	OUT	01000	
00017	END (01)	---	(6) END(01) instruction

### 4-5-3 Programming Procedures

The example program will be written to the CPM2A according to the mnemonic list in 4-5-2 Example Program. The procedure is performed beginning with the initial display. (Clear the memory before entering a new program.)

**Note** If an error occurs while inputting the program, refer to 5-3 Programming Console Operation Errors for details on correcting the error. Refer to the relevant Support Software Operation Manual for details on errors that appear when operating the SSS or SYSMAC-CPT Support Software.

#### (1) Inputting the Self-holding Bit

- 1, 2, 3... 1. Input the normally open condition IR 00000.  
(It isn't necessary to input leading zeroes.)

LD H	00000 LD	00000
WRITE	00001READ NOP (000)	

2. Input the OR condition IR 20000.

OR H	C 2	A 0	A 0	A 0	A 0	00001 OR	20000
WRITE	00002READ NOP (000)						

3. Input the normally closed AND condition C000.  
(It isn't necessary to input leading zeroes.)

AND H	NOT	CNT	00002 AND NOT CNT	000
WRITE	00003READ NOP (000)			

4. Input the OUT instruction IR 20000.

OUT	C 2	A 0	A 0	A 0	A 0	00003 OUT	20000
WRITE	00004READ NOP (000)						

#### (2) Inputting the One-second Timer

- 1, 2, 3... 1. Input the normally open condition IR 20000.

LD H	C 2	A 0	A 0	A 0	A 0	00004 LD	20000
WRITE	00005READ NOP (000)						

2. Input the normally closed AND condition T002.  
(It isn't necessary to input leading zeroes.)

AND H	NOT	TIM	C 2	00005 AND NOT TIM	002
WRITE	00006READ NOP (000)				

3. Input the 1-second timer T001.

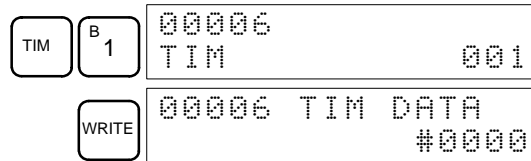

4. Input the SV for T001 (#0010 = 1.0 s).

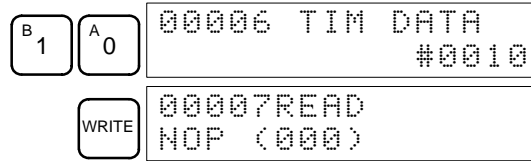

**(3) Inputting the Two-second Timer**

The following key operations are used to input the 2-second timer.

1, 2, 3...

1. Input the normally open condition IR 20000.

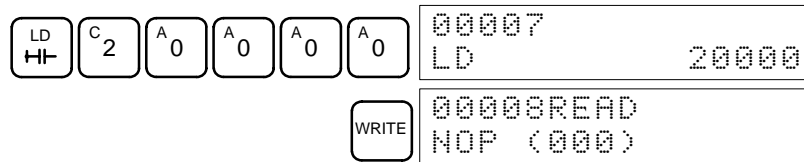

2. Input the normally closed AND condition T002.  
(It isn't necessary to input leading zeroes.)

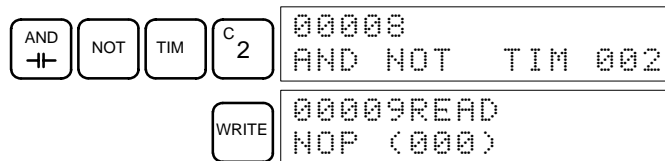

3. Input the 2-second timer T002.

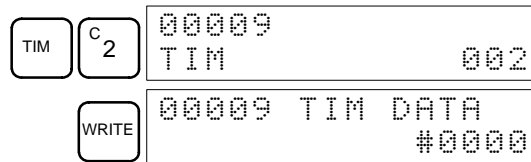

4. Input the SV for T002 (#0020 = 2.0 s).

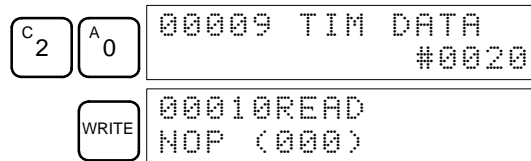

**(4) Inputting the 10-count Counter**

The following key operations are used to input the 10-count counter.

1, 2, 3...

1. Input the normally open condition IR 20000.

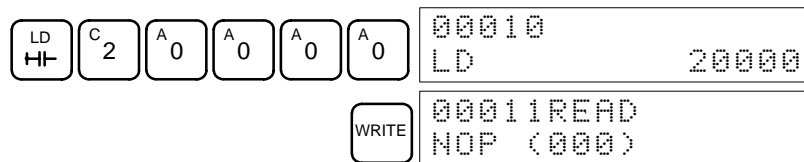

2. Input the normally open AND condition T001.  
(It isn't necessary to input leading zeroes.)

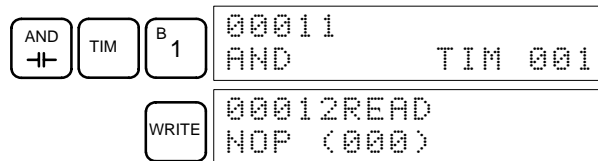

3. Input the normally closed condition IR 20000.

LD		NOT	C 2	A 0	A 0	A 0	A 0	00012	LD NOT	20000
WRITE										
00013READ										
NOP (000)										

4. Input the counter 000.

CNT	A 0	00013	CNT	000
WRITE				
00013 CNT DATA				
#0000				

5. Input the SV for counter 000 (#0010 = 10 counts).

B 1	A 0	00013 CNT DATA	#0010
WRITE			
00014READ			
NOP (000)			

**(5) Inputting the Flicker Output**

1, 2, 3... 1. Input the normally open condition IR 20000.

LD		C 2	A 0	A 0	A 0	A 0	000014	LD	20000	
WRITE										
00015READ										
NOP (000)										

2. Input the normally closed AND condition T001.  
(It isn't necessary to input leading zeroes.)

AND		NOT	TIM	B 1	00015	AND NOT TIM 001
WRITE						
00016READ						
NOP (000)						

3. Input the OUT instruction IR 01000.  
(It isn't necessary to input leading zeroes.)

OUT	B 1	A 0	A 0	A 0	00016	OUT	01000
WRITE							
00017READ							
NOP (000)							

**(6) Inputting the END(001) Instruction**

Input END(01). (The display shows three digits in the function code, but only the last two digits are input for CPM2A PCs.)

FUN	00017	FUN (0??)	
WRITE			
A 0	B 1	00017	END (001)
WRITE			
00018READ			
NOP (000)			

### 4-5-4 Checking the Program

Check the program syntax in PROGRAM mode to make sure that the program has been input correctly.

- 1, 2, 3... 1. Press the CLR Key to bring up the initial display.

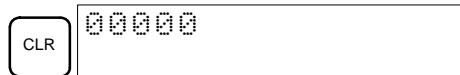

2. Press the SRCH Key. An input prompt will appear requesting the desired check level.



3. Input the desired check level (0, 1, or 2). The program check will begin when the check level is input, and the first error found will be displayed. If no errors are found, the following display will appear.

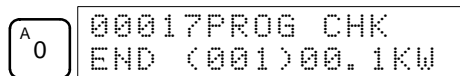

**Note** Refer to 5-4 Programming Errors for details on check levels and the programming errors that may be displayed during a program check.

4. Press the SRCH Key to continue the search. The next error will be displayed. Continue pressing the SRCH Key to continue the search. The search will continue until an END(01) instruction or the end of Program Memory is reached.

If errors are displayed, edit the program to correct the errors and check the program again. Continue checking the program until all errors have been corrected.

### 4-5-5 Test Run in MONITOR Mode

Switch the CPM2A in MONITOR mode and check the operation of the program.

- 1, 2, 3... 1. Set the Programming Console's mode switch to MONITOR mode.

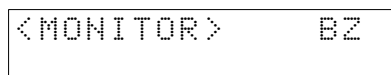
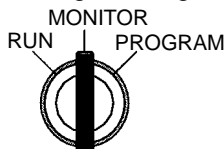

2. Press the CLR Key to bring up the initial display.

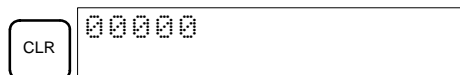

3. Force-set the start input bit (IR 00000) from the Programming Console to start the program.

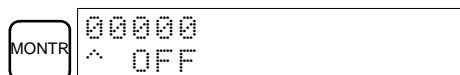
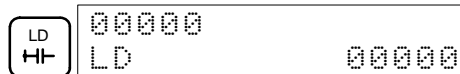

The cursor in the lower left corner of the display indicates that the force set is in progress. The bit will remain ON as long as the Set Key is held down.

4. The output indicator for output IR 01000 will flash ten times if the program is operating correctly. The indicator should go OFF after ten one-second flashes.

There is a mistake in the program if the output indicator doesn't flash. In this case, check the program and force set/reset bits to check operation.

# SECTION 5

## Test Runs and Error Processing

This section describes procedures for test runs of CPM2A operation, self-diagnosis functions, and error processing to identify and correct the hardware and software errors that can occur during PC operation.

5-1	Initial System Checks and Test Run Procedure .....	132
5-1-1	Initial System Checks .....	132
5-1-2	Flash Memory Precautions .....	132
5-1-3	CPM2A Test Run Procedure .....	132
5-2	Self-diagnostic Functions .....	133
5-2-1	Identifying Errors .....	133
5-2-2	User-defined Errors .....	134
5-2-3	Non-fatal Errors .....	134
5-2-4	Fatal Errors .....	135
5-2-5	Communications Errors .....	135
5-3	Programming Console Operation Errors .....	136
5-4	Programming Errors .....	136
5-5	Troubleshooting Flowcharts .....	137
5-6	Maintenance Inspections .....	145
5-7	Battery Replacement .....	146

## 5-1 Initial System Checks and Test Run Procedure

### 5-1-1 Initial System Checks

Check the following items after setting up and wiring the CPM2A, but before performing a test run.

Item	Points to check
Power supply and I/O connections	Is the wiring correct? Are the terminals securely tightened? Are there any shorts between crimp terminals or wires? Refer to 3-4 <i>Wiring and Connections</i> for details.
Connecting cables	Are the cables all connected correctly and locked? Refer to 3-4 <i>Wiring and Connections</i> for details.
Protective label	Has the protective label been removed?

- Note**
1. Always clear memory before beginning to program the CPM2A. Although memory is cleared before the CPU Unit is shipped, the contents of the DM, HR, AR, and counter areas may change in transit. See 4-4-2 *Clearing Memory* for details on the All Clear operation.
  2. See 1-3-3 *Operating Mode at Startup* to determine what mode the CPM2A will enter when the power is turned on.

### 5-1-2 Flash Memory Precautions

Observe the following precautions to protect the flash memory and ensure proper operation.

- 1, 2, 3...
1. If changes are made in the read-only DM area (DM 6144 through DM 6599) or PC Setup (DM 6600 through DM 6655), the PC's operating mode must be changed to write the new contents to flash memory. If backup battery is changed before the changes are written to flash memory, the changes will be lost.  
The changes can be saved by switching the CPM2A to RUN or MONITOR mode or turning the CPM2A off and then on again.
  2. When contents of the program, read-only DM (DM 6144 through DM 6599), or PC Setup (DM 6600 through DM 6655) have been changed, startup processing will take up to 1,200 ms longer than usual. Be sure to take this one-time startup delay into account if it may affect operations.
  3. If one of the following three operations is performed in MONITOR or RUN mode, the CPM2A's cycle time will be extended by up to 1,200 ms and interrupts will be disabled while the program or PC Setup is being overwritten.
    - Program changes with the online edit operation
    - Changes to the read-only DM area (DM 6144 through DM 6599)
    - Changes to the PC Setup (DM 6600 through DM 6655)
 A "SCAN TIME OVER" error won't occur during these operations. Be sure to take this delay in the CPM2A's I/O response times into account when performing online editing.

### 5-1-3 CPM2A Test Run Procedure

- 1, 2, 3...
1. Power Supply Application
    - a) Check the CPM2A's power supply voltage and terminal connections.
    - b) Check the I/O devices' power supply voltage and terminal connections.
    - c) Turn on the power supply and check that the "PWR" indicator lights.
    - d) Use a Programming Device to set the CPM2A to PROGRAM mode.

2. I/O Wiring Checks
  - a) With the CPM2A in PROGRAM mode, check the output wiring by turning on the output bits with the force set and force reset operations. Refer to 4-4-24 *Force Set, Reset* for details.
  - b) Check the input wiring with the CPM2A's input indicators or a Programming Device's monitor operations.
3. Test Run
  - a) Use a Programming Device to set the CPM2A to RUN or MONITOR mode and check that the "RUN" indicator lights.
  - b) Check the sequence of operation with the force set/reset operations, etc.
4. Debugging
 

Correct any programming errors that are detected.
5. Saving the Program
  - a) Use a Programming Device to write the program to a backup floppy disk.
  - b) Print out a hard copy of the program with a printer.

**Note** Refer to *Section 4 Using Programming Devices* for details on the Support Software and Programming Console operations.

## 5-2 Self-diagnostic Functions

The CPM2A is equipped with a variety of self-diagnostic functions to help identify and correct errors and reduce down time.

### 5-2-1 Identifying Errors

An error can be identified by the error message displayed on a Programming Device, error flags in the AR and SR areas, and the error code output to SR 253.

#### Fatal and Non-fatal Errors

PC errors are divided into 2 categories based on the severity of the errors. The status of the ERR/ALM indicator (lit or flashing) shows which type of error has occurred.

#### **ERR/ALM Lit (Fatal Error)**

Fatal errors are serious errors which stop CPM2A operation. There are two ways to restart operation:

- Turn the PC off and then on again.
- Use a Programming Device to switch the PC to PROGRAM mode, and read/clear the error.

#### **ERR/ALM Flashing (Non-fatal Error)**

Non-fatal errors are less serious errors which don't stop CPM2A operation.

#### Error Messages

When an error is detected, a corresponding error message will be displayed on the Programming Console or other Programming Device connected to the PC.

#### Error Flags

When a hardware error is detected, the corresponding error flag in the AR or SR area will be turned ON.

#### Error Code

When an error is detected, a specific 2-digit hexadecimal error code is output to SR 25300 to SR 25307. The error code and time of occurrence are also output to the Error Log Area (DM 2000 to DM 2021).

 **WARNING** The PC will turn OFF all outputs when its self-diagnosis function detects any error or when a severe failure alarm (FALS) instruction is executed. External safety measures must be provided to ensure safety in the system. Not providing proper safety measures may result in serious accidents.



## 5-2-2 User-defined Errors

There are three instructions that can be used to define errors or messages. FAL(06) causes a non-fatal error, FAL(07) causes a fatal error, and MSG(46) sends a message to the Programming Console or host computer connected to the PC.

**FAILURE ALARM – FAL(06)** FAL(06) is an instruction that causes a non-fatal error. The following will occur when an FAL(06) instruction is executed:

- 1, 2, 3... 1. The ERR/ALM indicator on the CPU Unit will flash. PC operation will continue.
2. The instruction's 2-digit BCD FAL number (01 to 99) will be written to SR 25300 to SR 25307.

The FAL numbers can be set arbitrarily to indicate particular conditions, but the same number should not be used as both an FAL number and an FALS number.

To clear an FAL error, correct the cause of the error and then execute FAL 00 or use a Programming Device to clear the error.

**SEVERE FAILURE ALARM – FALS(07)** FALS(07) is an instruction that causes a fatal error. The following will occur when an FALS(07) instruction is executed:

- 1, 2, 3... 1. Program execution will be stopped and all outputs will be turned OFF.
2. The ERR/ALM indicator on the CPU Unit will be lit.
3. The instruction's 2-digit BCD FALS number (01 to 99) will be written to SR 25300 to SR 25307.

The FALS numbers can be set arbitrarily to indicate particular conditions, but the same number should not be used as both an FAL number and an FALS number.

To clear an FALS error, use a Programming Device to switch the PC to PROGRAM Mode, correct the cause of the error, and then clear the error.

**MESSAGE – MSG(46)** MSG(46) is used to display a message on a Programming Device connected to the CPM2A. The message, which can be up to 16 characters long, is displayed when the instruction's execution condition is ON.

## 5-2-3 Non-fatal Errors

PC operation and program execution will continue after one or more of these errors have occurred. Although PC operation will continue, the cause of the error should be corrected and the error cleared as soon as possible.

When one of these errors occurs, the POWER and RUN indicators will remain lit and the ERR/ALM indicator will flash.

Message	FAL No.	Meaning and appropriate response
SYS FAIL FAL** (** is 01 to 99 or 9B.)	01 to 99	An FAL(06) instruction has been executed in the program. Check the FAL number to determine conditions that would cause execution, correct the cause, and clear the error.
	9B	An error has been detected in the PC Setup. Check flags AR 1300 to AR 1302, and correct as directed.  AR 1300 ON: An incorrect setting was detected in the PC Setup (DM 6600 to DM 6614) when power was turned on. Correct the settings in PROGRAM Mode and turn on the power again.  AR 1301 ON: An incorrect setting was detected in the PC Setup (DM 6615 to DM 6644) when switching to RUN or MONITOR mode. Correct the settings in PROGRAM Mode and switch to RUN or MONITOR mode again.  AR 1302 ON: An incorrect setting was detected in the PC Setup (DM 6645 to DM 6655) during operation. Correct the settings and clear the error.

Message	FAL No.	Meaning and appropriate response
SCAN TIME OVER	F8	The cycle time has exceeded 100 ms. (SR 25309 will be ON.) This indicates that the program cycle time is longer than recommended. Reduce cycle time if possible. (The CPM2A can be set so that this error won't be detected.)
Battery error (no message)	F7	If the voltage of the CPM2A-BAT01 backup battery is below the minimum level, the ERR/ALM indicator will flash and SR 25308 will be turned ON. Replace the battery. (See 5-7 <i>Battery Replacement</i> for details.)

### 5-2-4 Fatal Errors

PC operation and program execution will stop and all outputs from the PC will be turned OFF when any of these errors have occurred. CPM2A operation can't be restarted until the PC is turned off and then on again or a Programming Device is used to switch the PC to PROGRAM mode and clear the fatal error.

All CPU Unit indicators will be OFF for the power interruption error. For all other fatal operating errors, the POWER and ERR/ALM indicators will be lit. The RUN indicator will be OFF.

Message	FALS No.	Meaning and appropriate response
Power interruption (no message)	None	Power has been interrupted for more than 10 ms (2 ms for DC power types.) Check power supply voltage and power lines. Try to power-up again.
MEMORY ERR	F1	AR 1308 ON: There is a non-existent bit or word address in the user program. Check the program and correct errors.
		AR 1309 ON: An error has occurred in flash memory. Replace the CPU Unit.
		AR 1310 ON: A checksum error has occurred in read-only DM (DM 6144 to DM 6599). Check and correct the settings in the read-only DM area.
		AR 1311 ON: A checksum error has occurred in the PC Setup. Initialize the PC Setup and input the settings again.
		AR 1312 ON: A checksum error has occurred in the program. Check the program and correct any errors detected.
		AR 1313 ON: A checksum error has occurred in the expansion instructions data and all function codes have been set the their default values. Reset the expansion instructions.
		AR 1314 ON: Data was not maintained in an area specified for holding. Clear the error, check the data in the areas specified for holding, and try again.
NO END INST	F0	END(01) is not written in the program. Write END(01) at the end of the program.
I/O BUS ERR	C0	An error has occurred during data transfer between the CPU Unit and an Expansion Unit or an Expansion I/O Unit. Check the Unit's connecting cable.
I/O UNIT OVER	E1	Too many Expansion Units or Expansion I/O Units have been connected. Check the Unit configuration.
SYS FAIL FALS** (** is 01 to 99 or 9F.)	01 to 99	A FALS(07) instruction has been executed in the program. Check the FALS number to determine the conditions that caused execution, correct the cause, and clear the error.
	9F	The cycle time has exceeded the Maximum (Watch) Cycle Time setting (DM 6618). Check the cycle time and adjust the Maximum Cycle Time setting if necessary.

### 5-2-5 Communications Errors

The COMM indicator will be turned OFF and AR 0812 will be turned ON if an error occurs in communications through the peripheral port or AR 0804 will be turned ON if an error occurs in communications through the RS-232C port. Check the connecting cables and restart.

There are no error messages or error codes generated by this error and the ERR/ALM indicator is not affected.

## 5-3 Programming Console Operation Errors

The following error messages may appear when performing operations on the Programming Console. Correct the error as indicated and continue operation.

Message	Meaning and appropriate response
REPL ROM	An attempt was made to write to write-protected memory. Set bits 00 to 03 of DM 6602 to "0."
PROG OVER	The instruction at the last address in memory is not NOP(00). Erase all unnecessary instructions after END(01).
ADDR OVER	An address was set that is larger than the highest memory address in Program Memory. Input a smaller address.
SETDATA ERR	FALS 00 has been input, and "00" cannot be input. Reinput the data.
I/O NO. ERR	A data area address has been designated that exceeds the limit of the data area, e.g., an address is too large. Confirm the requirements for the instruction and re-enter the address.

**Note** Refer to the relevant Support Software Operation Manual for details on errors that may appear when operating the SSS or SYSMAC-CPT Support Software.

## 5-4 Programming Errors

These errors in program syntax will be detected when the program is checked using the Program Check operation.

Three levels of program checking are available. The desired level must be designated to indicate the type of errors that are to be detected. The following table provides the error types, displays, and explanations of all syntax errors. Check level 0 checks for type A, B, and C errors; check level 1, for type A and B errors; and check level 2, for type A errors only.

Type	Message	Meaning and appropriate response
A	?????	The program has been damaged, creating a non-existent function code. Re-enter the program.
	CIRCUIT ERR	The number of LD instructions (LD or LD NOT) does not match the number of logic block instructions (OR LD or AND LD). Check your program.
	OPERAND ERR	A constant entered for the instruction is not within defined values. Change the constant so that it lies within the proper range.
	NO END INSTR	There is no END(01) in the program. Write END(01) at the end of the program.
	LOCN ERR	An instruction is in the wrong place in the program. Check instruction requirements and correct the program.
	JME UNDEFD	A JME(05) instruction is missing for a JMP(04) instruction. Correct the jump number or insert the proper JME(05) instruction.
	DUPL	The same jump number or subroutine number has been used twice. Correct the program so that the same number is only used once for each.
	SBN UNDEFD	An SBN(92) has not been programmed with the same subroutine number as an SBS(91) instruction in the program. Correct the program.
STEP ERR	STEP(08) with a section number and STEP(08) without a section number have been used incorrectly. Check STEP(08) programming requirements and correct the program.	

Type	Message	Meaning and appropriate response
B	IL-ILC ERR	IL(02) and ILC(03) are not used in pairs. Check the program before processing.
	JMP-JME ERR	JMP(04) and JME(05) are not used in pairs. Check the program before processing.
	SBN-RET ERR	RET(93) has not been used properly or the relationship between SBN(92) and RET(93) is not correct. Correct the program.
C	COIL DUPL	The same bit is being controlled (i.e., turned ON and/or OFF) by more than one instruction (e.g., OUT, OUT NOT, DIFU(13), DIFD(14), KEEP(11), SFT(10)). This error occurs when the same number is used for the timer and counter instructions. Although this is allowed for certain instructions, check instruction requirements to confirm that the program is correct or rewrite the program so that each bit is controlled by only one instruction.
	JMP UNDEFD	JME(05) has been used with no JMP(04) with the same jump number. Add a JMP(04) with the same number or delete the JME(05) that is not being used.
	SBS UNDEFD	A subroutine exists that is not called by SBS(91). Program a subroutine call in the proper place, or delete the subroutine if it is not required.

## 5-5 Troubleshooting Flowcharts

Use the following flowcharts to troubleshoot errors that occur during operation.

### Main Check

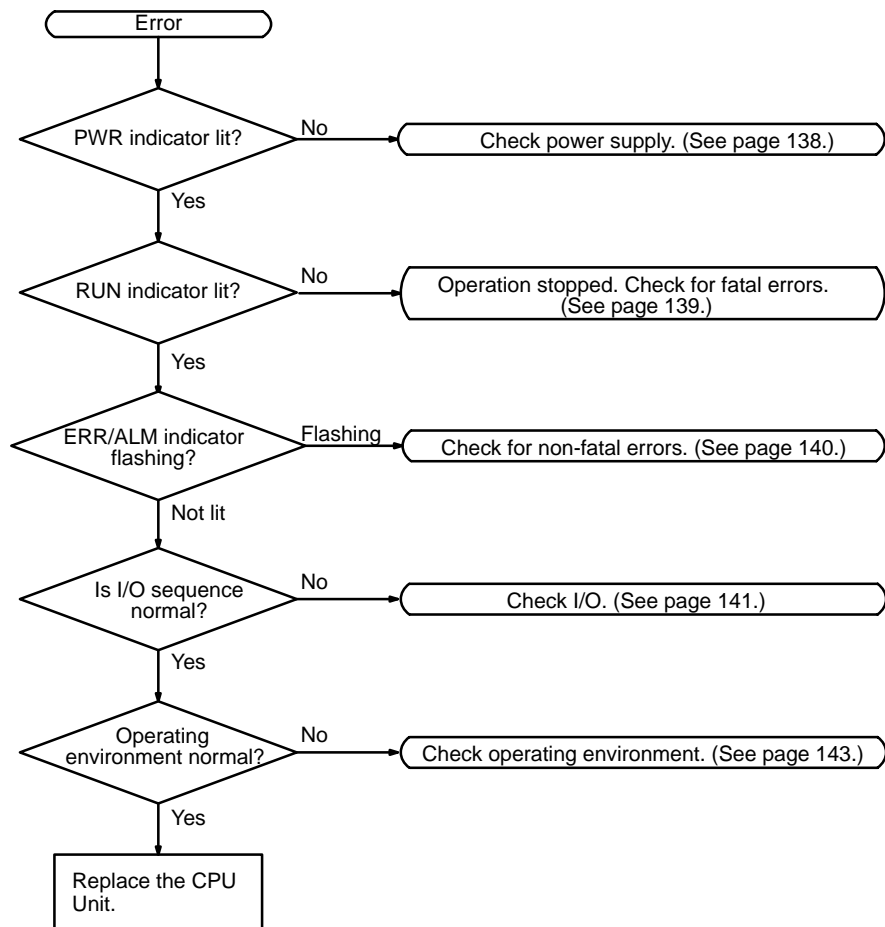

Power Supply Check

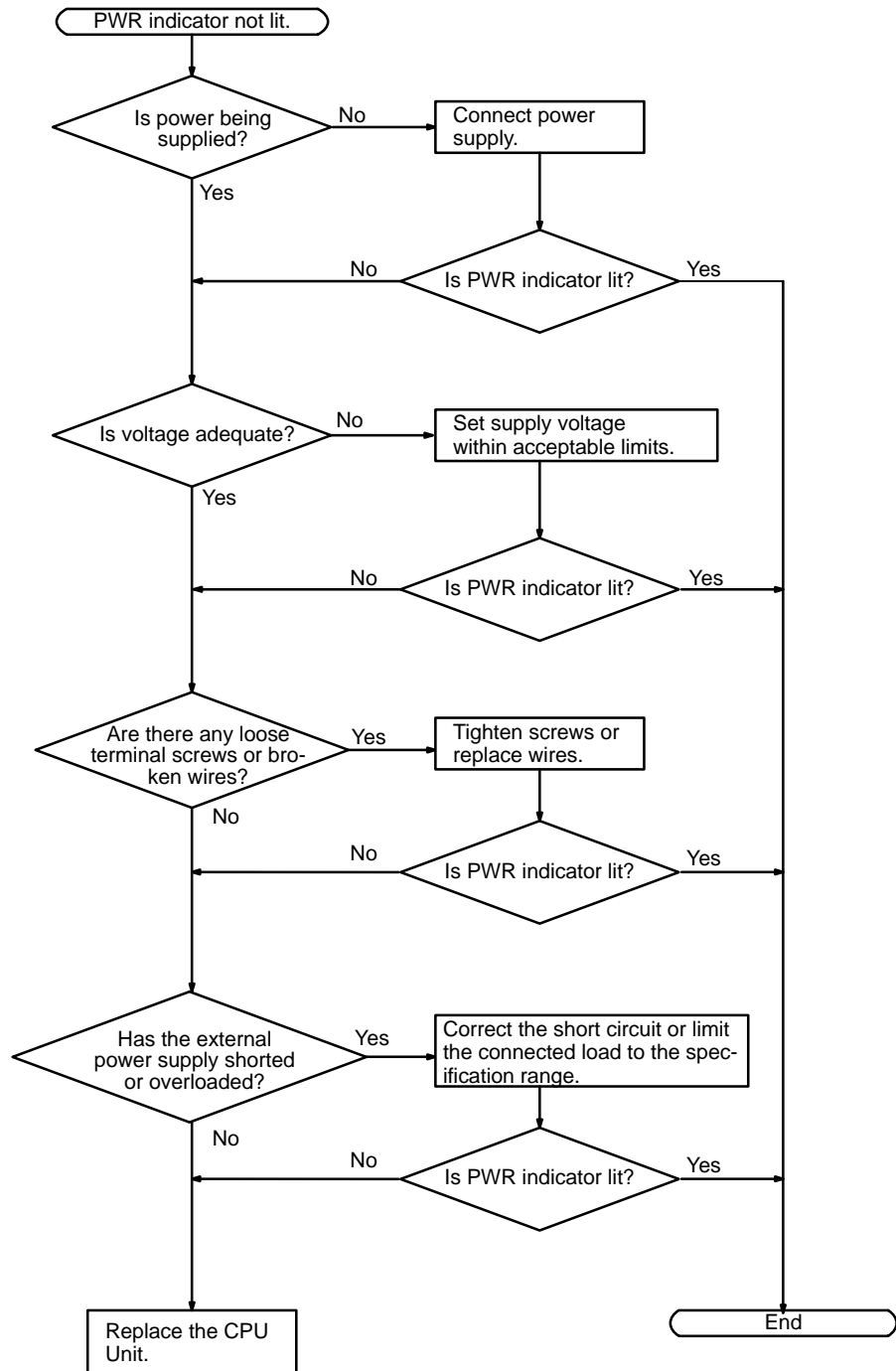

Fatal Error Check

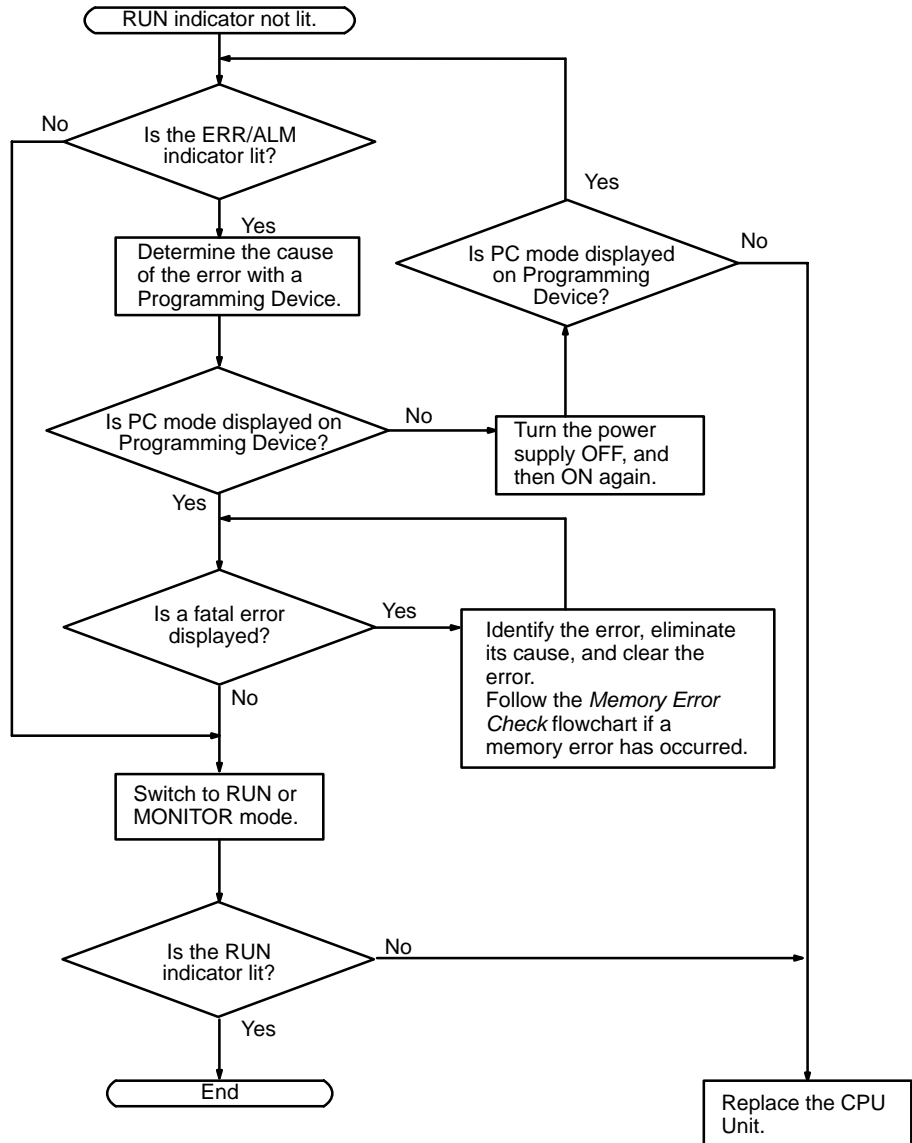

Non-fatal Error Check

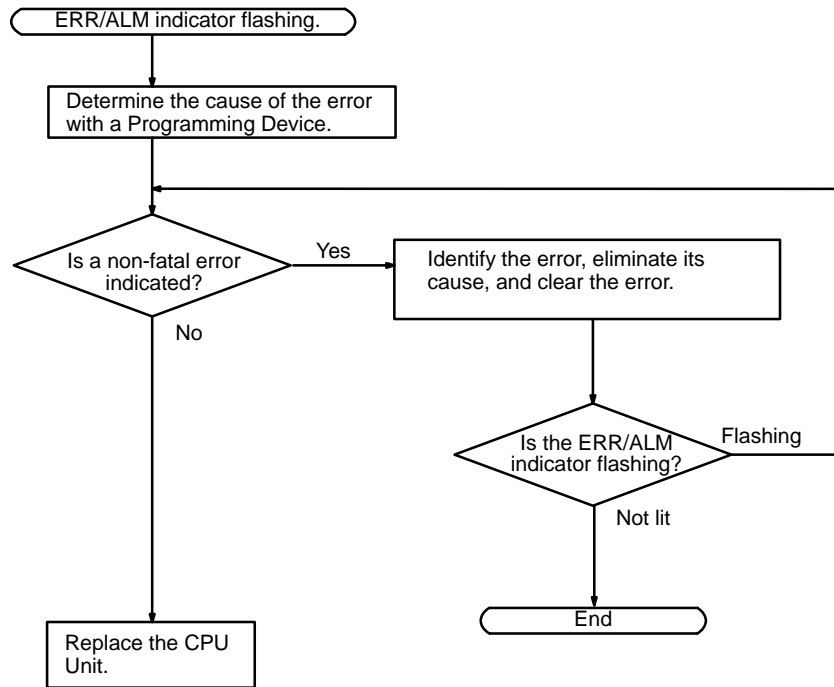

I/O Check

The I/O check flowchart is based on the following ladder diagram section.

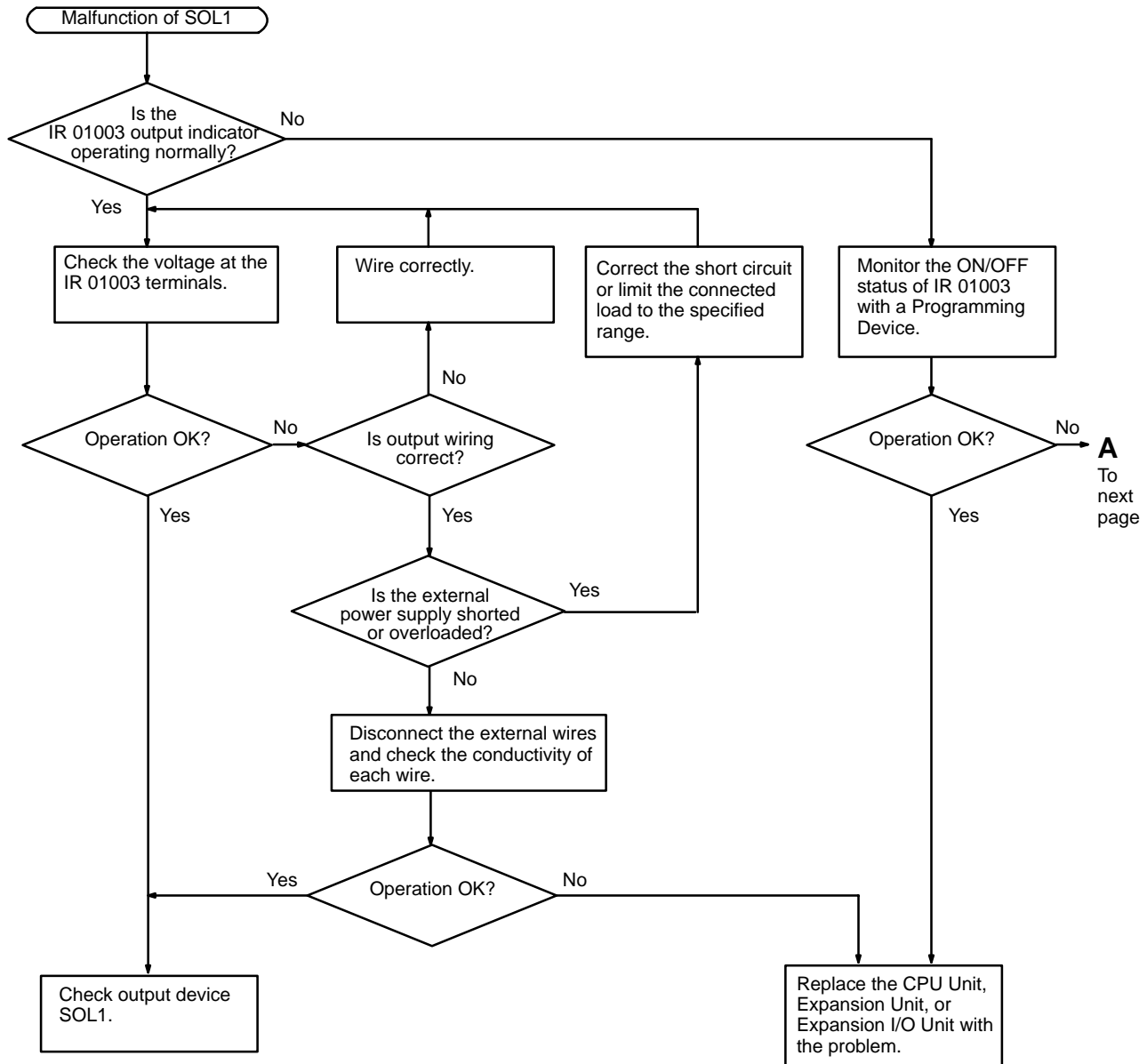
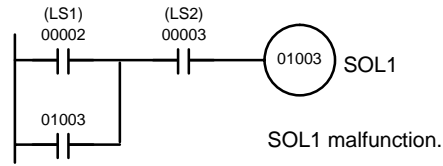



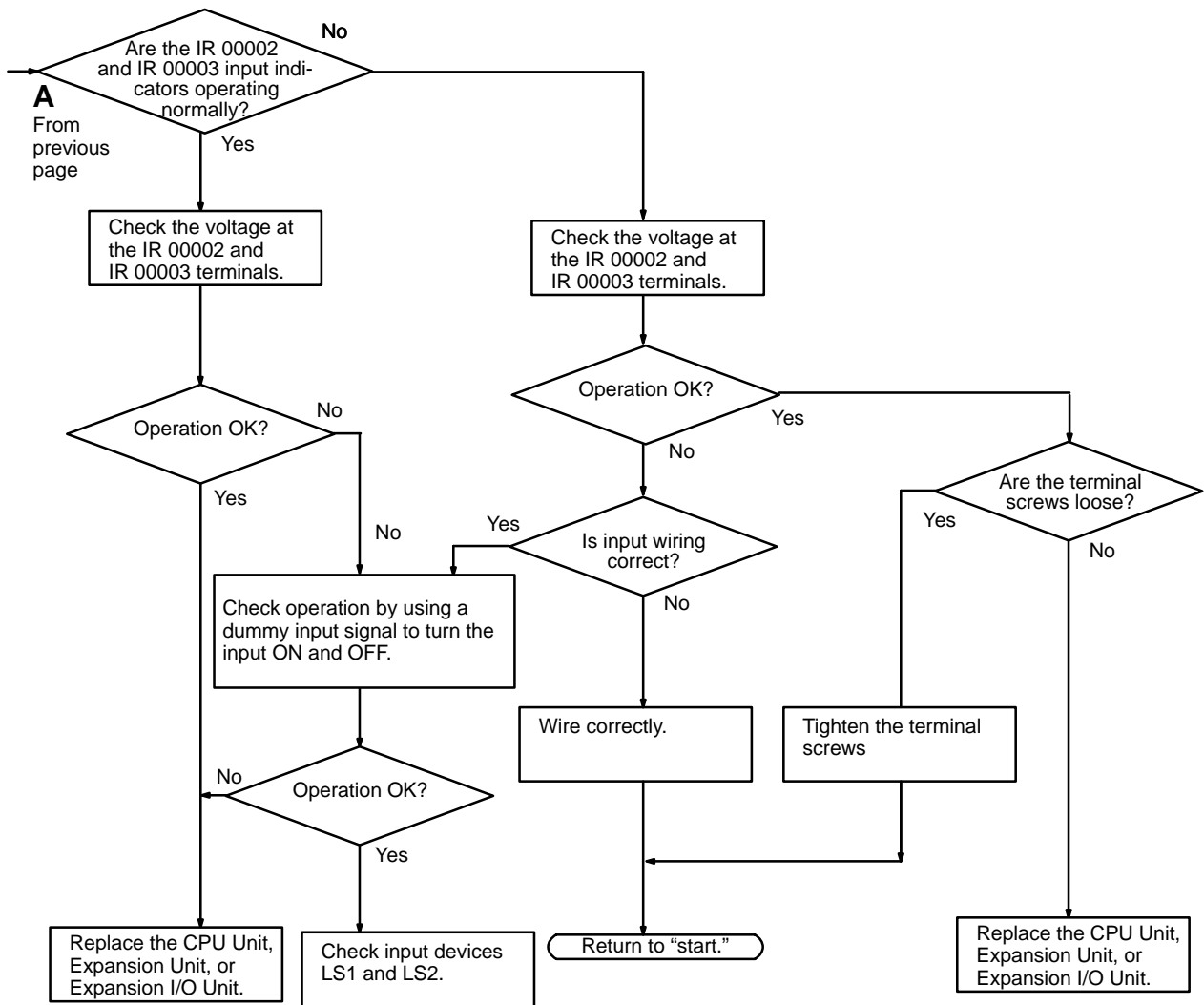

Environmental Conditions Check

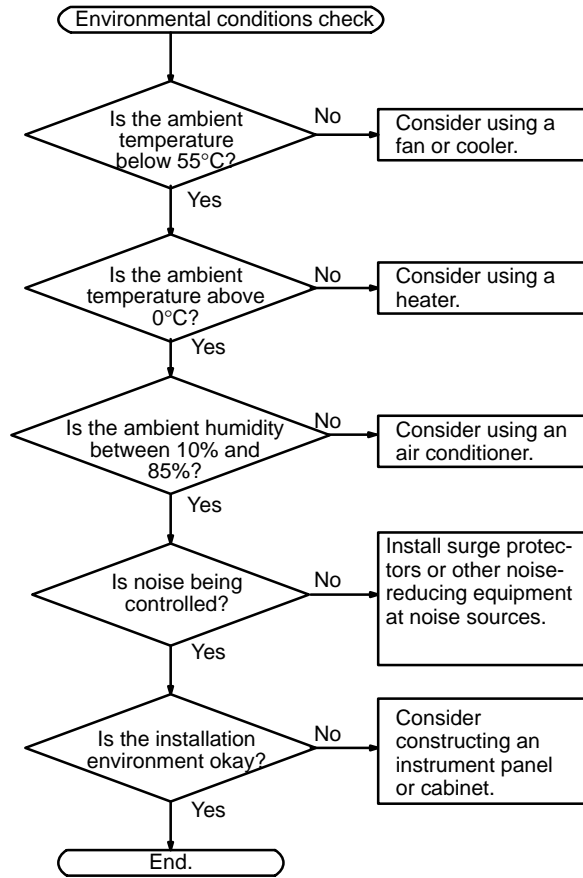

Memory Error Check

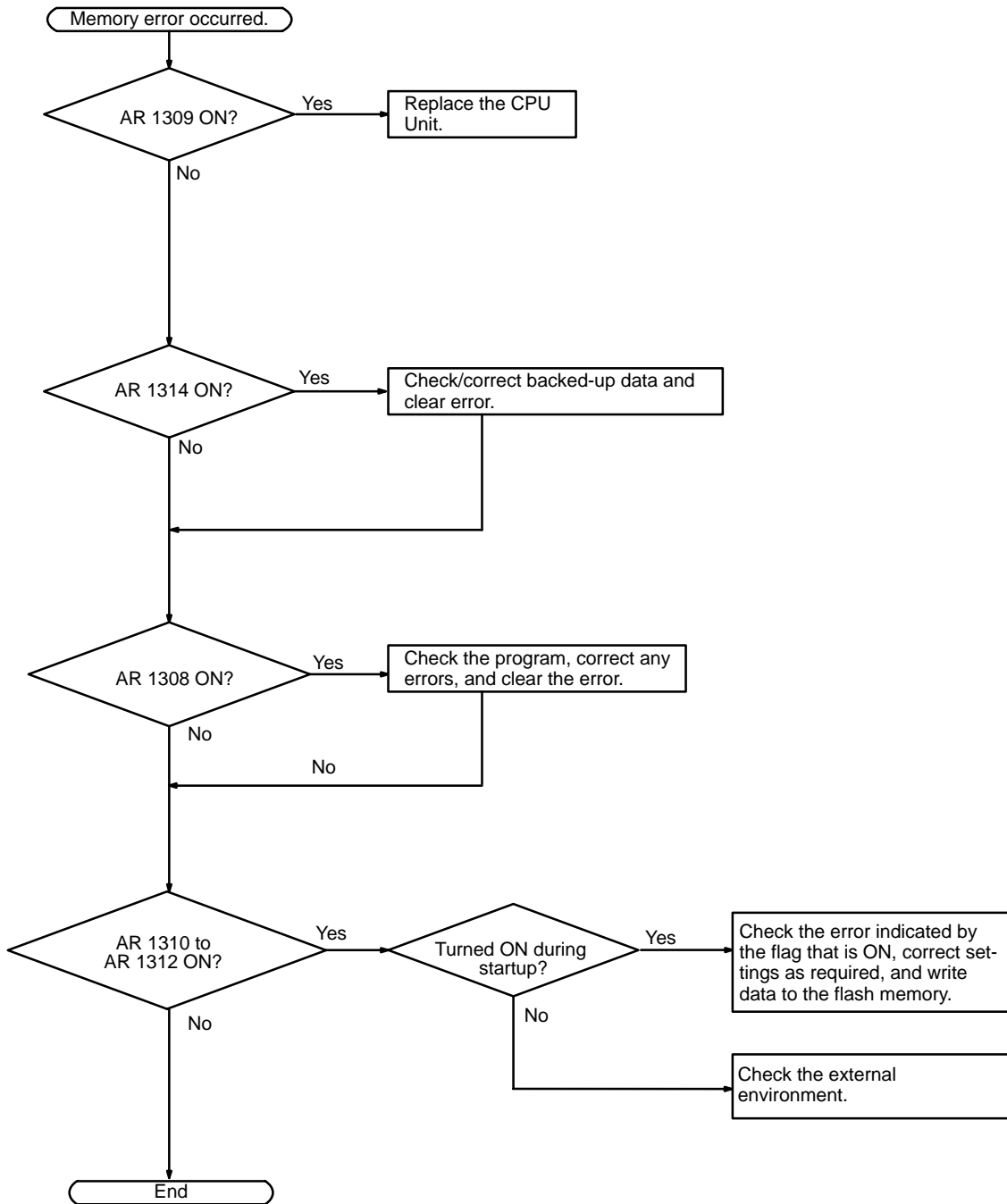

## 5-6 Maintenance Inspections

In order for your SYSMAC system to operate in optimum condition, be sure to carry out daily or periodical inspections.

### Inspection Items

The main system components of a SYSMAC system are semiconductors, and it contains few components with limited lifetimes. Poor environmental conditions, however, can lead to deterioration of the electrical components, making regular maintenance necessary.

The standard period for maintenance checks is 6 months to 1 year, but more frequent checks are required if the PC is operated in more demanding conditions.

If the criteria are not met, adjust to within the specified ranges.

Inspection items	Details	Criteria	Remarks
Power supply	Determine whether the voltage fluctuation at the power supply terminals is within specifications.	Within the voltage variation range (see note)	Tester
Environmental conditions	Is the ambient temperature inside the panel appropriate?	0 to 55°C	Thermometer
	Is the ambient humidity inside the panel appropriate?	10% to 85% RH with no condensation	Hygrometer
	Has dirt or dust collected?	None	Visual inspection
I/O power supply	Is the voltage fluctuation measured at the I/O terminals within the standard range?	Each I/O terminal must conform to the specifications	Tester
Installation status	Are all units securely installed?	Nothing is loose	Phillips screwdriver
	Are all connection cables and connectors inserted completely and locked?	Nothing is loose	Visual inspection
	Are any of the external wiring screws loose?	Nothing is loose	Phillips screwdriver
	Are any of the external wiring cables frayed?	No external abnormalities	Visual inspection
Product service life	Contact output relay	Electrical: Resistance load: 300,000 operations Inductive load: 100,000 operations  Mechanical: 10,000,000 operations	---
	Battery (CPM2A-BAT01)	5 years	---

**Note** Power supply voltage variation range.

Power supply	Allowable voltage fluctuation range
100 to 240 VAC	85 to 264 VAC
24 VDC	20.4 to 26.4 VDC

### Required Tools

#### Standard Tools (Required)

- Screwdrivers (Phillips and flat-blade)
- Voltage tester or digital voltage meter
- Industrial alcohol and a cotton cloth

#### Measurement Devices (May be Needed)

- Synchroscope
- Cathode-ray oscilloscope
- Thermometer, hygrometer

**Note** Do not attempt to disassemble, repair, or modify the PC in any way.

## 5-7 Battery Replacement

If power has not been supplied to the PC for an extended period of time, turn ON the power supply for at least 5 minutes before replacing the battery.

Turn OFF the power supply to the PC before replacing the battery.

Use the procedure below when replacing the battery. This procedure must be completed within 5 minutes.

- 1, 2, 3... 1. Remove the battery cover with a flat-blade screwdriver.

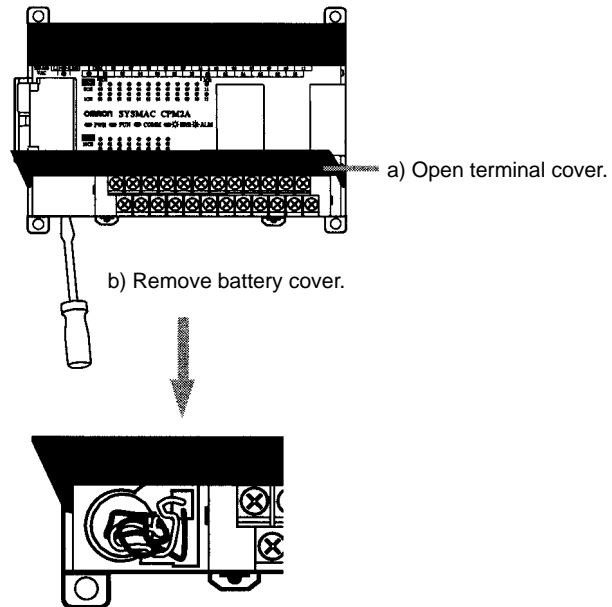

2. Remove the battery.

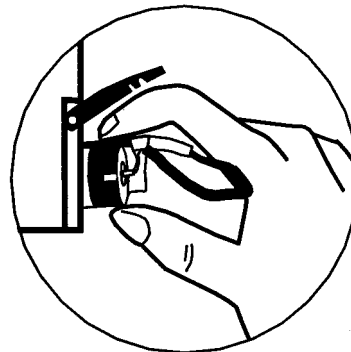

3. Disconnect the battery connector.

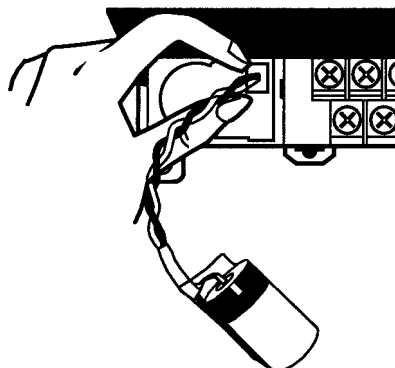

4. Check the replacement battery's connector.

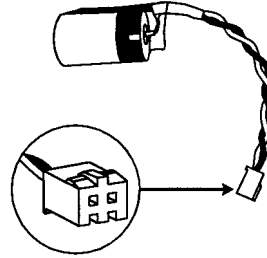

5. Check the alignment of the connector tab and fully insert the connector.

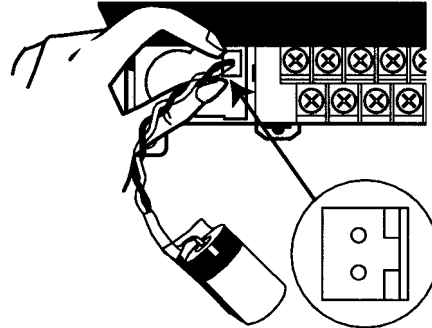

6. Insert the battery into the compartment, making sure that the cord on the battery is facing the connector on the right side inside the compartment.

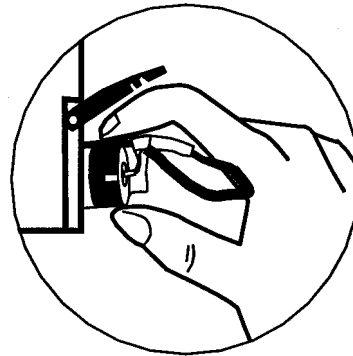

7. Close the battery cover.

# SECTION 6

## Expansion Memory Unit

This section describes how to use the CPM1-EMU01-V1 Expansion Memory Unit. Follow the handling precautions and procedures to properly use the Unit.

6-1	Overview .....	150
6-1-1	Memory Areas .....	150
6-1-2	Precautions .....	150
6-2	Specifications and Nomenclature .....	151
6-2-1	Specifications .....	151
6-2-2	Nomenclature .....	151
6-3	Handling .....	152
6-3-1	Mounting/Removing EEPROM .....	152
6-3-2	PC Connections .....	153
6-3-3	Uploading Programs .....	154
6-3-4	Downloading Programs .....	155

## 6-1 Overview

The CPM1-EMU01-V1 Expansion Memory Unit is a program loader for small-size or micro PCs. Using the CPM1-EMU01-V1, simple on-site transfer of user programs and data memory between PCs is possible.

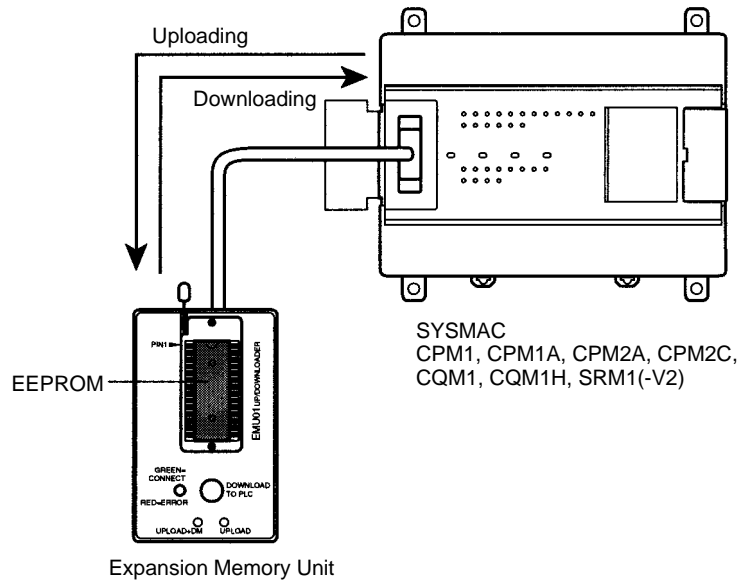

**Note** The “PLC” in the “DOWNLOAD TO PLC” Button indicates PCs (Programmable Controllers).

### 6-1-1 Memory Areas

The memory areas that are uploaded or downloaded vary with the button used as shown in the following table.

Button	UPLOAD + DM	UPLOAD	DOWNLOAD TO PLC
Ladder program and expansion instructions	Read from PC to EEPROM.	Read from PC to EEPROM.	All contents of EEPROM written to PC.
DM 6144 to 6655		Not affected.	

**Note** For details on program size, DM area, and the availability of expansion instructions, refer to the relevant PC manual.

### 6-1-2 Precautions

- Do not attempt to use the CPM1-EMU01-V1 for any applications other than those described here. Doing so may result in malfunction.
- Do not attempt to upload or download data between different types of PC. Doing so may result in malfunction.
- Do not download when the PC is in RUN or MONITOR mode. If downloading is performed when the PC is running, it will automatically switch to PROGRAM mode and operation will stop.
- Do not attempt to disassemble, repair, or modify the CPM1-EMU01-V1. Any attempt to do so may result in malfunction, fire, or electric shock.
- After downloading has been completed, be sure to confirm the user program, data, and expansion instruction information. Not doing so may result in faulty operation.



- Before touching the EEPROM or the CPM1-EMU01-V1, first touch a grounded metallic object to discharge any static build-up. Not doing so may result in malfunction or damage.

## 6-2 Specifications and Nomenclature

### 6-2-1 Specifications

Item	Specifications
Supported PCs	CPM1, CPM1A, CPM2A, CPM2C, SRM1 (-V2), CQM1, CQM1H
Read/Write memory areas	User program: 15.2 Kwords max. Data memory: DM 6144 to DM 6655 (Read-only DM and PC Setup) Expansion instructions: 18 instructions
Connector	Connector compatible with CPM1, CPM1A, CPM2A, SRM1 (-V2), and CQM1 PCs. For CPM2C and CQM1H PCs, connect via CS1W-CN114 or CPM2C-CN111 Connecting Cable.
Communications setting	1 start bit, 7 data bits, even parity, 2 stop bits, 9,600 bps
EEPROM (See note 1.)	256-Kbit EEPROM ATMEL: AT28C256 OMRON: EEROM-JD
Current consumption	129 mA max.
Dimensions	Main body (not including cables or connectors): 57 × 92 × 38 mm (W × H × D)
Weight	200 g max. (not including EEPROM)

- Note**
1. The EEPROM must be purchased separately.
  2. For general specifications, refer to the relevant PC manual.

### 6-2-2 Nomenclature

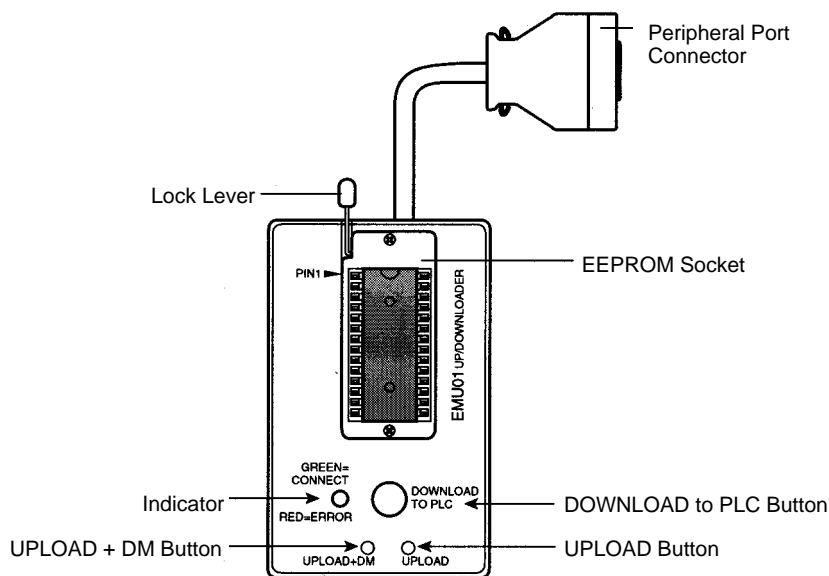

**Lock Lever**

For mounting and removing EEPROM.

**DOWNLOAD TO PLC Button**

Writes all EEPROM data (ladder programs, data memory etc.) to the PC.

**UPLOADED + DM Button**

Reads PC user program and contents of DM 6144 to DM 6655 to EEPROM.

**UPLOADED Button**

Reads only PC user program to EEPROM.

- Note** The "PLC" in the "DOWNLOAD TO PLC" Button indicates PCs (Programmable Controllers).

LED Indicator

CONNECT (green)	ERR (red)	Meaning
OFF	OFF	Not connected to PC (power supply OFF).
ON	OFF	Connected to a recognized PC.
Blinking	OFF	Uploading/downloading data.
ON	Blinking	Host link communications error, retry by user.
OFF	ON	PC model and EEPROM data not compatible.
OFF	Blinking	One of the following errors has occurred: An unrecognized PC is connected. An EEPROM error (EEPROM not present, EEPROM defect, or no program to download) or checksum error.

## 6-3 Handling

### 6-3-1 Mounting/Removing EEPROM

 **Caution** Do not mount or remove the EEPROM with the CPM1-EMU01-V1 connected to the PC. Doing so may damage the EEPROM.

#### Mounting EEPROM

- 1, 2, 3... 1. Lift up the lock lever.
2. Straighten the pins on the EEPROM, line up with the socket and lower into the socket, as shown in the following diagram. If the EEPROM is loose, place it in the center of the socket.

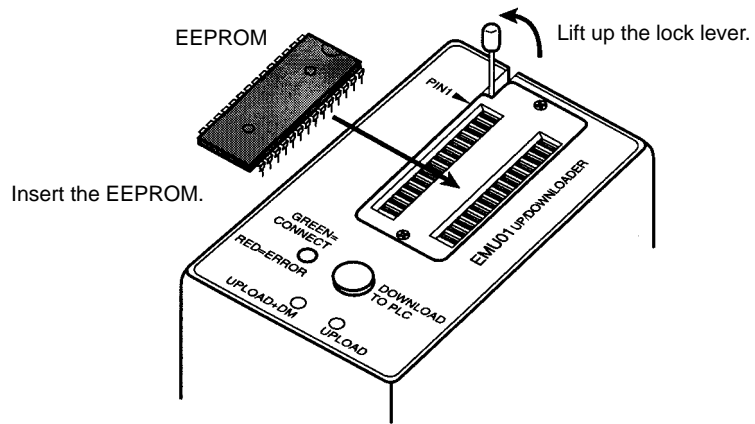

3. Gently hold down the EEPROM and pull down the lock lever.

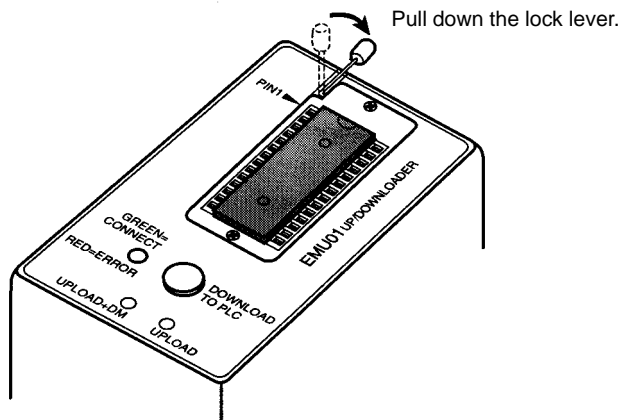

Removing EEPROM

Lift up the lock lever and detach the EEPROM.

### 6-3-2 PC Connections

**Caution** Mount the EEPROM to the CPM1-EMU01-V1 before connecting the CPM1-EMU01-V1 to the PC.

**Caution** Do not disconnect the CPM1-EMU01-V1 from the PC when the indicator is blinking green.

**CPM1, CPM1A, CPM2A, CQM1, and SRM1 (-V2) PCs**

When connecting to the CPM1, CPM1A, CPM2A, CQM1 or SRM1 (-V2), insert the connector into the peripheral port making sure that the connector is oriented correctly.

- Insert the connector until it securely locks into place.
- Connections are not possible to the RS-232C port or any other port.

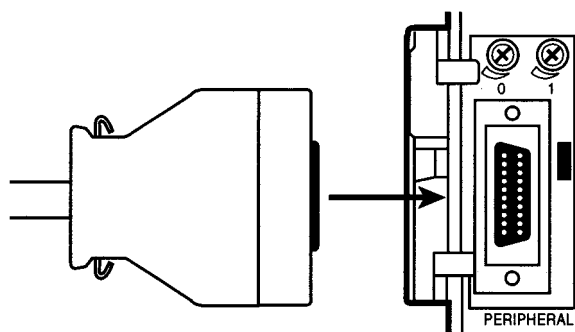

Connection to CPM2A

**CPM2C and CQM1H PCs**

When connecting to the CPM2C or CQM1H, connect to the peripheral port via the CPM2C-CN111 or CS1W-CN114 Connecting Cable. Also, set the pins on the CPU Unit's DIP switch as follows:

CPM2C	Pin 1: ON (see note)
	Pin 2: ON
CQM1H	Pin 5: ON (see note)
	Pin 7: ON

**Note** If pin 1 on the CPM2C or pin 5 on the CQM1H is OFF, connection is still possible if the peripheral port is set to the defaults.

**Peripheral Port Communications Settings**

The peripheral port must be set to the default communications settings shown below.

- Start bit: 1
- Data bits: 7
- Stop bits: 2
- Parity: Even
- Baud rate: 9,600 bps

**Disconnecting**

Press the levers on the top and bottom of the connector inwards to unlock the connector and pull out as shown in the following diagram.

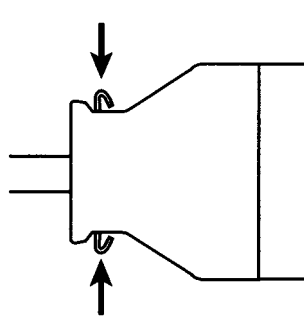

**Note** Do not attempt to remove the connector by pulling the cable.

**6-3-3 Uploading Programs**

Ladder programs and the contents of data memory can be uploaded to the EEPROM using the following procedure. The buttons used will determine whether the contents of data memory are uploaded or not.

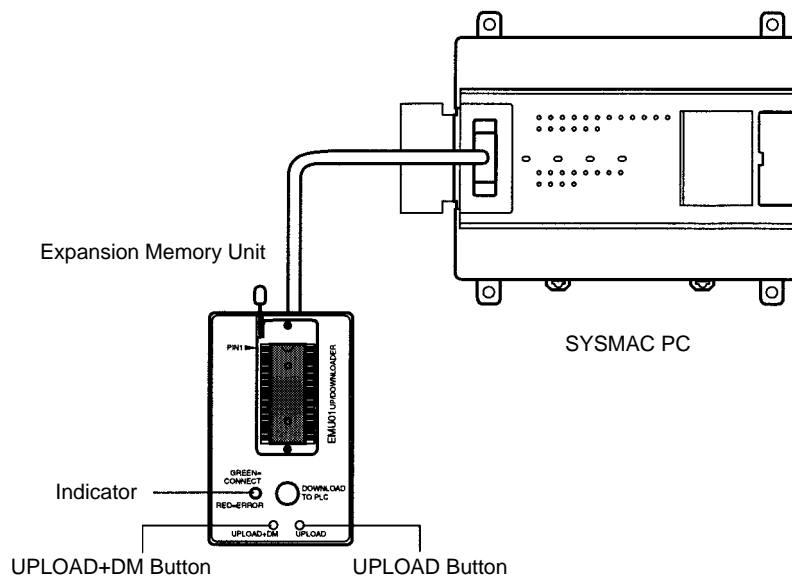

Button	UPLOAD + DM	UPLOAD
Ladder program and expansion instructions	Read from PC to EEPROM.	Read from PC to EEPROM.
DM6144 to 6655		Not affected.

**Note** Use a Phillips screwdriver or other tool with a diameter of 3.0 mm max. and a blade length of 10 mm min. to press the upload button.

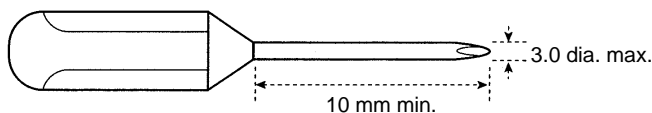

Uploading is possible even if the PC is in RUN or MONITOR mode.

**Operation Procedure**

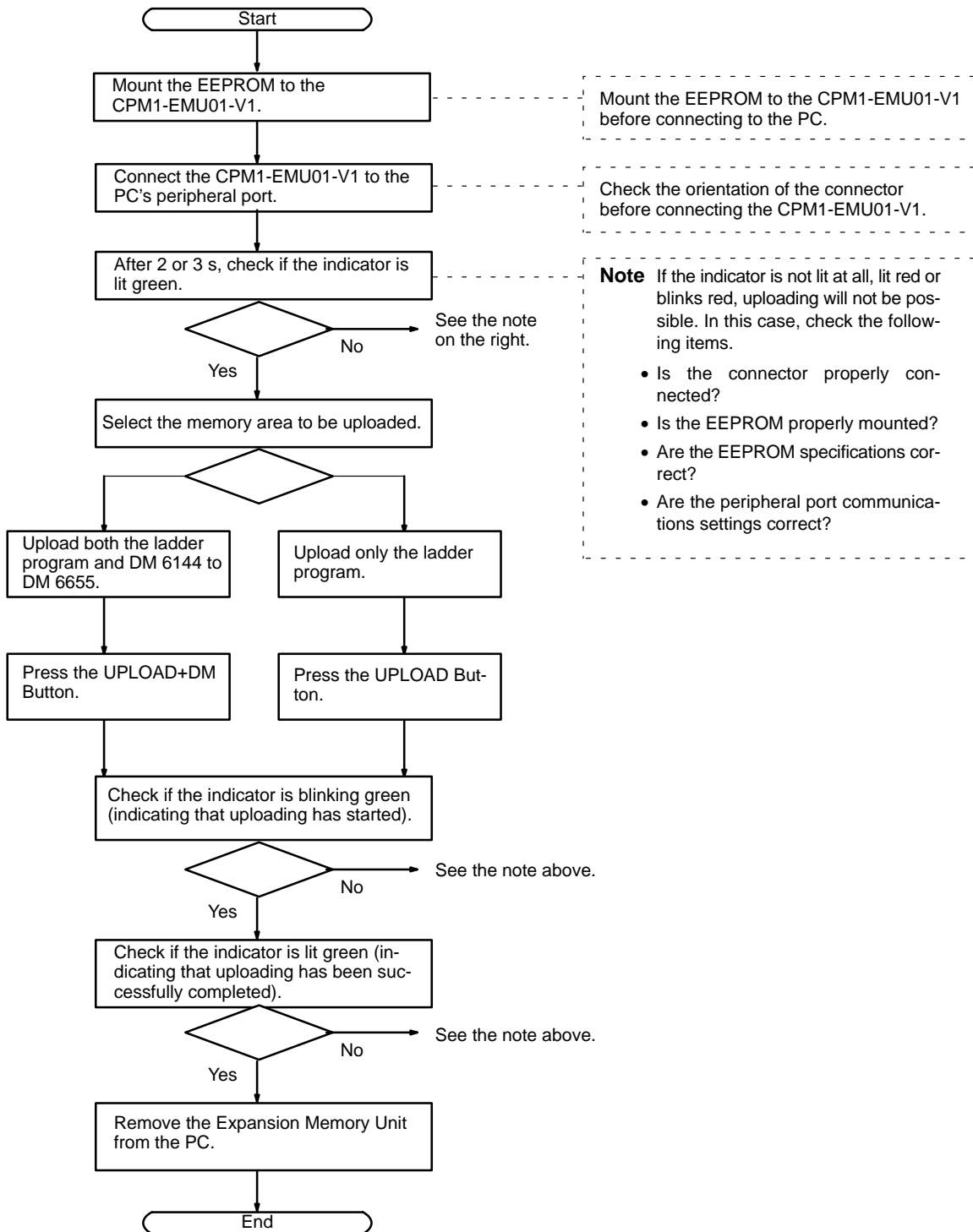

**6-3-4 Downloading Programs**

Ladder programs and the contents of data memory can be downloaded from the EEPROM to the PC using the procedure given below. When downloading, note the following points.

**Caution**  If the PC is in RUN or MONITOR mode when downloading is started, it will automatically switch to PROGRAM mode and operation will stop. Confirm that no adverse effects will occur to the system before downloading. Not doing so may result in unexpected operation.

- Note**
1. If the PC is in RUN or MONITOR mode, switch the PC mode to PROGRAM mode.
  2. Confirm that the program or other data to be downloaded to the PC is compatible with the PC before downloading.
  3. For the CQM1 or CQM1H, when downloading programs that use user-assigned function codes for expansion instructions, be sure that pin 4 on the CPU Unit's DIP switch is ON. If these programs are downloaded while the pin is OFF, the assignments for the expansion instructions will return to their default settings.
  4. After downloading has been completed, be sure to confirm the user program, data, and expansion instructions.
  5. When the DOWNLOAD TO PLC Button is pressed, all EEPROM data (ladder programs, data memory etc.) is written to the PC.

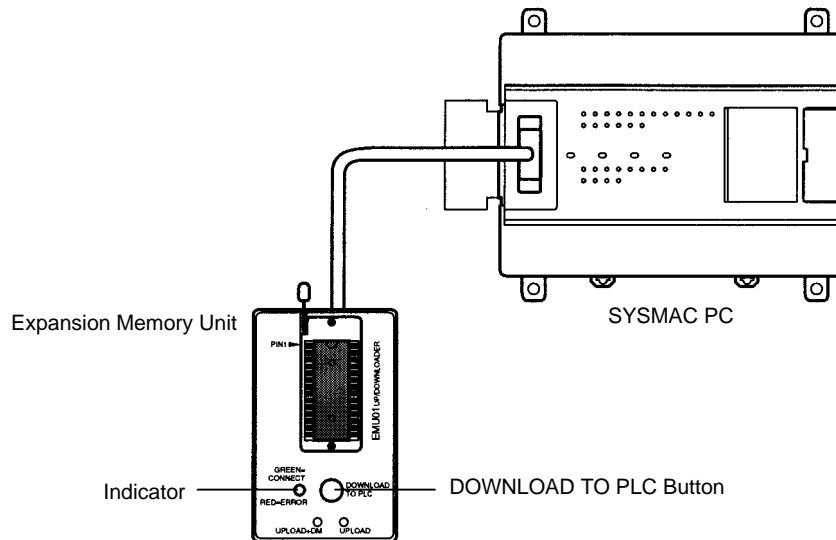

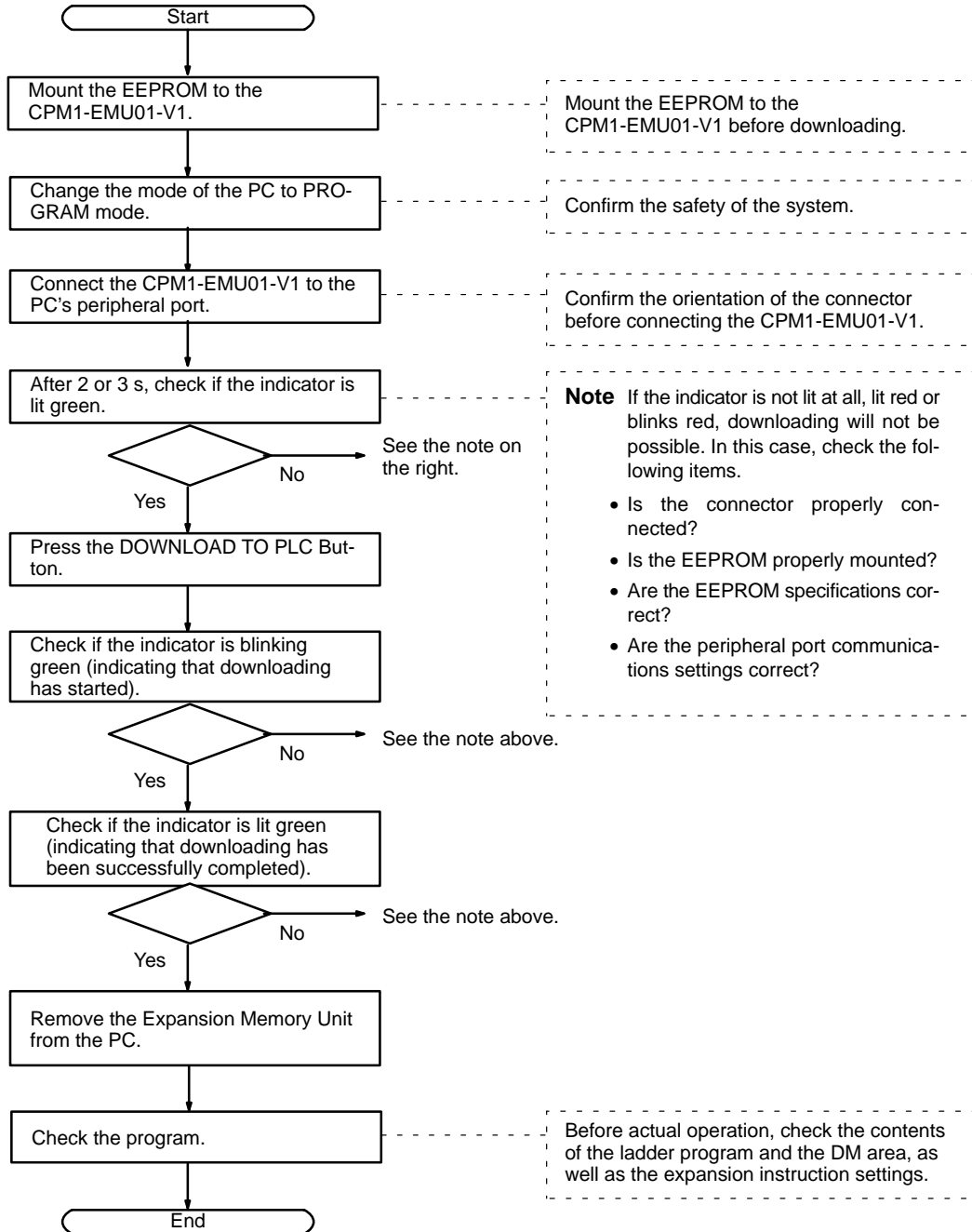

**Operation Procedure**



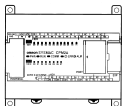
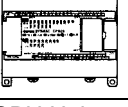
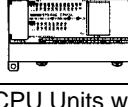

# Appendix A

## Standard Models

### CPU Units

Description	Input points	Output points	Power supply	Model number		
				Relay outputs	Transistor outputs	
					Sinking	Sourcing
CPU Units with 20 I/O points 	12 points	8 points	AC	CPM2A-20CDR-A	---	---
			DC	CPM2A-20CDR-D	CPM2A-20CDT-D	CPM2A-20CDT1-D
CPU Units with 30 I/O points 	18 points	12 points	AC	CPM2A-30CDR-A	---	---
			DC	CPM2A-30CDR-D	CPM2A-30CDT-D	CPM2A-30CDT1-D
CPU Units with 40 I/O points 	24 points	16 points	AC	CPM2A-40CDR-A	---	---
			DC	CPM2A-40CDR-D	CPM2A-40CDT-D	CPM2A-40CDT1-D
CPU Units with 60 I/O points 	36 points	24 points	AC	CPM2A-60CDR-A	---	---
			DC	CPM2A-60CDR-D	CPM2A-60CDT-D	CPM2A-60CDT1-D

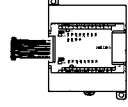
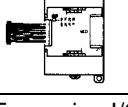
### Expansion I/O Units

Description	Input points	Output points	Model number		
			Relay output	Transistor output	
				Sinking	Sourcing
Expansion I/O Unit with 20 I/O points 	12 points	8 points	CPM1A-20EDR1	CPM1A-20EDT	CPM1A-20EDT1
Expansion I/O Unit with 8 input points 	8 points	---	CPM1A-8ED (no outputs)		
Expansion I/O Unit with 8 output points 	---	8 points	CPM1A-8ER	CPM1A-8ET	CPM1A-8ET1



## Expansion Units

### Analog I/O Unit

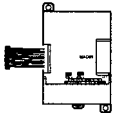
Description	Specifications	Model number
Analog I/O Unit 	2 analog inputs and 1 analog output	CPM1A-MAD01

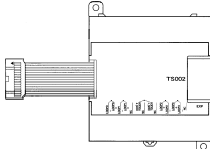

### Temperature Sensor Units

Description	Specifications	Model number
Temperature Sensor Unit 	2 thermocouple inputs: K, J	CPM1A-TS001
	4 thermocouple inputs: K, J	CPM1A-TS002
	2 platinum resistance thermometer inputs: Pt100 (100 Ω), JPt100 (100 Ω)	CPM1A-TS101
	4 platinum resistance thermometer inputs: Pt100 (100 Ω), JPt100 (100 Ω)	CPM1A-TS102

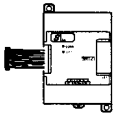

### CompoBus/S I/O Link Unit

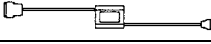
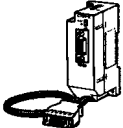
Description	Specifications	Model number
CompoBus/S I/O Link Unit 	Operates as a CompoBus/S Slave and provides 8 inputs and 8 outputs to the CPM1A or CPM2A PC.	CPM1A-SRT21

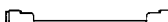



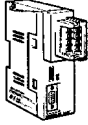
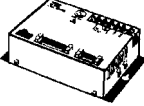

## Adapters and Connecting Cables (1:1 Connection)

CPM2A port	Name	Appearance	Model number	Comments	Cable length
Peripheral	RS-232C Adapter		CQM1-CIF01	For a 25-pin computer serial port	3.3 m
			CQM1-CIF02	For a 9-pin computer serial port	3.3 m
			CPM1-CIF01 (+ XW2Z-□00S)	For a 25-pin computer serial port	3.3 m (+ □ m)
RS-232C	RS-232C Cable		XW2Z-200S	For a 25-pin computer serial port	2 m
			XW2Z-500S		5 m
			XW2Z-200S-V	For a 9-pin computer serial port	2 m
			XW2Z-500S-V		5 m

## Adapters and Connecting Cables (1:N Connections)

Name	Appearance	Model number	Specifications
RS-422 Adapter		NT-AL001	Use for CPM2A RS-232C port to RS-422A conversion. Requires a 5-VDC, 150 mA power supply which is supplied through the CPM2A connection. (Can also be connected to a personal computer, but this connection requires an external 5-VDC power supply.)
Link Adapter		B500-AL004	Use for personal computer RS-232C port to RS-422A. (Can also be connected to a CPM2A.)
RS-422 Adapter		CPM1-CIF11	Use for CPM2A peripheral port to RS-422A conversion.
RS-232C Cables (For use with the NT-AL001.)		XW2Z-070T-1	Use for CPM2A RS-232C port to NT-AL001 connection. (70-cm cable)
		XW2Z-070T-1	Use for CPM2A RS-232C port to NT-AL001 connection. (2-m cable)

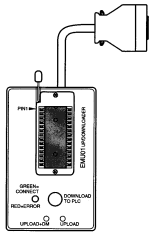
## Peripheral Devices

Name	Appearance	Model Number	Specifications
Programming Console		CQM1-PRO01-E	2-m Connecting Cable attached
		C200H-PRO27-E	Hand-held, w/backlight; requires a C200H-CN222 or C200H-CN422 Connecting Cable, see below.
	C200H-CN222	Connects the C200H-PRO27-E to a peripheral port.	2-m cable
	C200H-CN422		4-m cable
CX-Programmer		WS02-CXPC1-E	For MS-Windows 95/98 (CD-ROM)
SYSMAC Support Software		C500-ZL3AT1-E	3.5", 2HD for IBM PC/AT compatible
SYSMAC-CPT		WS01-CPTB1-E	For IBM PC/AT or compatible computers (3.5" disks (2HD) and CDROM)
Connecting Cable		C200H-CN222	Connects C200H Programming Console to Peripheral Port (2 m)
		C200H-CN422	Connects C200H Programming Console to Peripheral Port (4 m)
Expansion Memory Unit		CPM1-EMU01-V1	Uploads the ladder program and DM 6144 to DM 6655 from the PC to the EEPROM and downloads the ladder program and DM 6144 to DM 6655 from the EEPROM to the PC.
EEPROM		EEROM-JD	256 K bit

## Maintenance Accessories

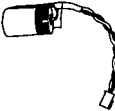
Name	Appearance	Model Number	Specifications
Backup Battery		CPM2A-BAT01	---

# Appendix B Dimensions

All dimensions are in millimeters.

## CPM2A-20CD□-□ CPU Units

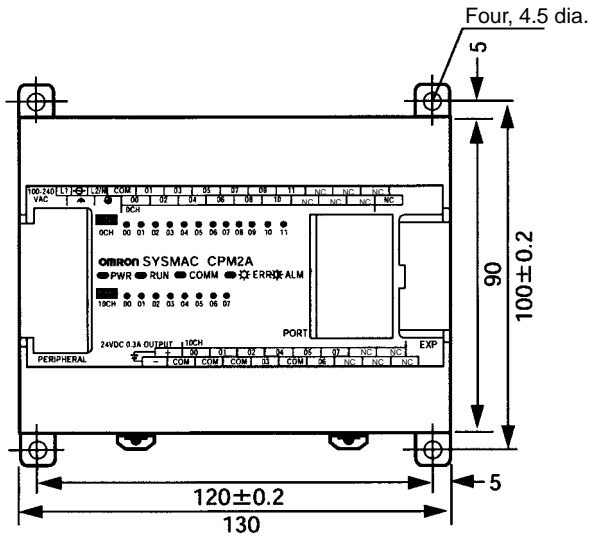

CPU Units with DC Power

CPU Units with AC Power

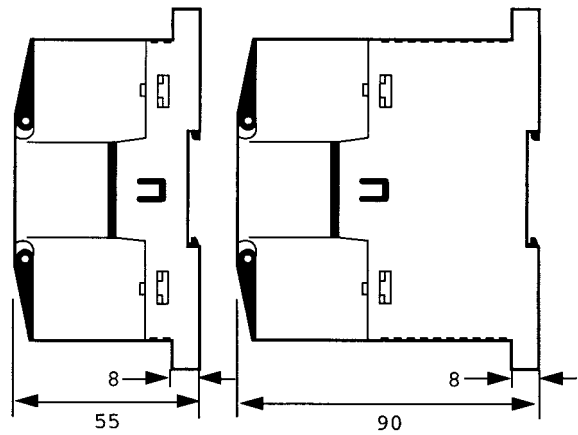

## CPM2A-30CD□-□ CPU Units

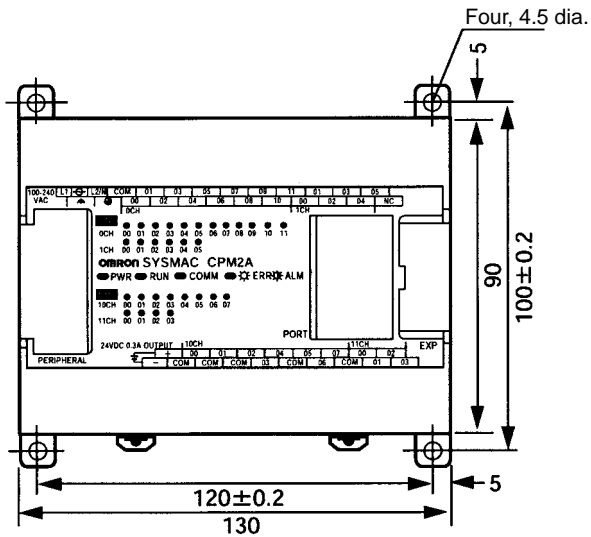

CPU Units with DC Power

CPU Units with AC Power

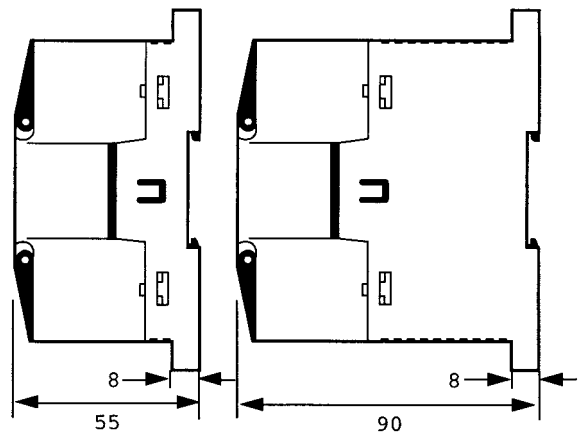

### CPM2A-40CD□-□ CPU Units

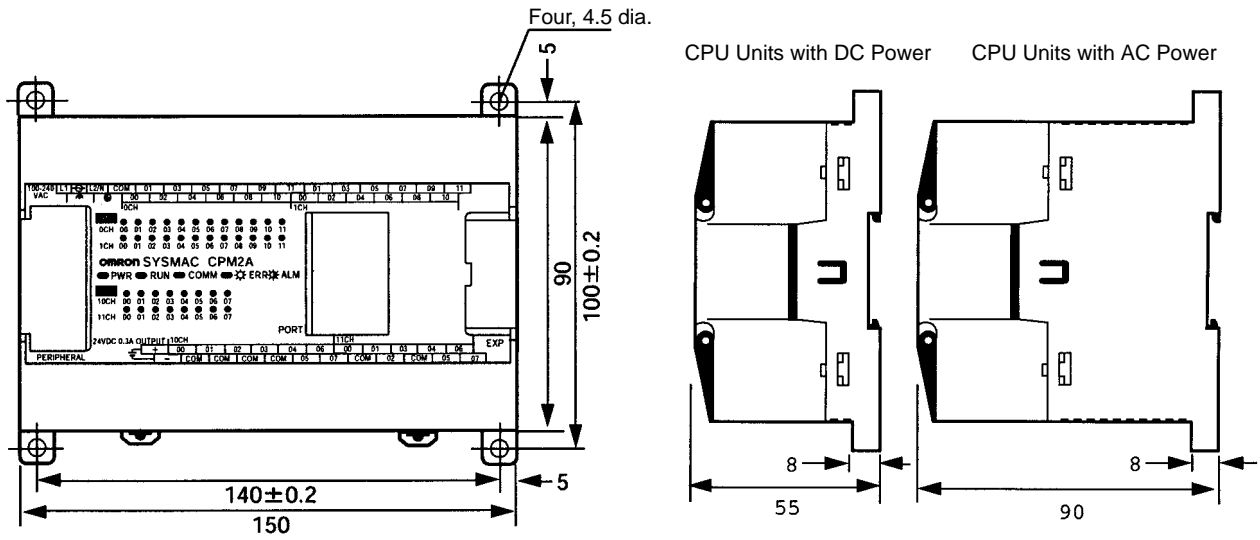

### CPM2A-60CD□-□ CPU Units

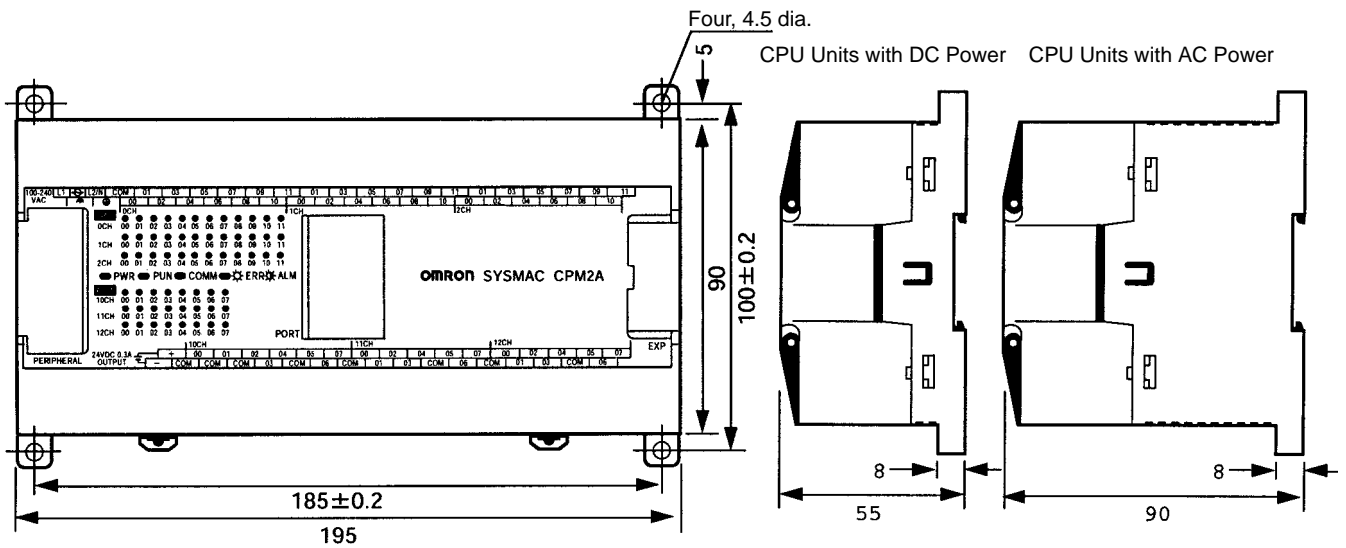

**CPM1A-20ED Expansion I/O Units**

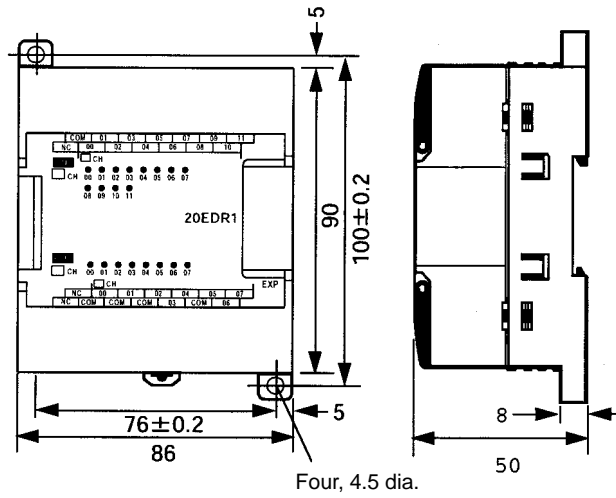

**CPM1A-8 Expansion I/O Units**

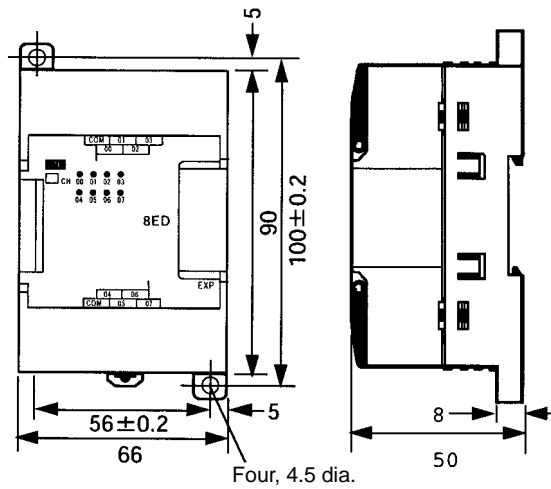

**CPM1A-MAD01 Analog I/O Unit**

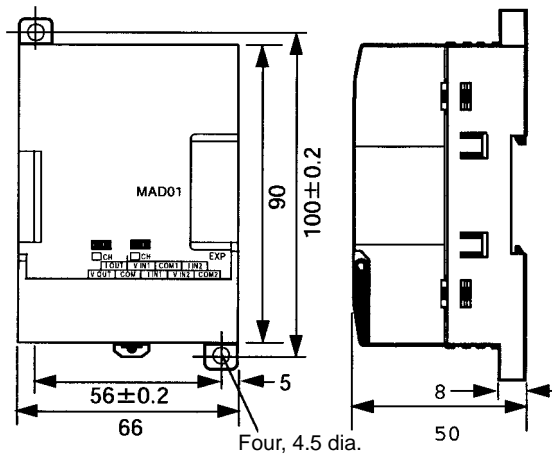

CPM1A-TS□□□ Temperature Sensor Units

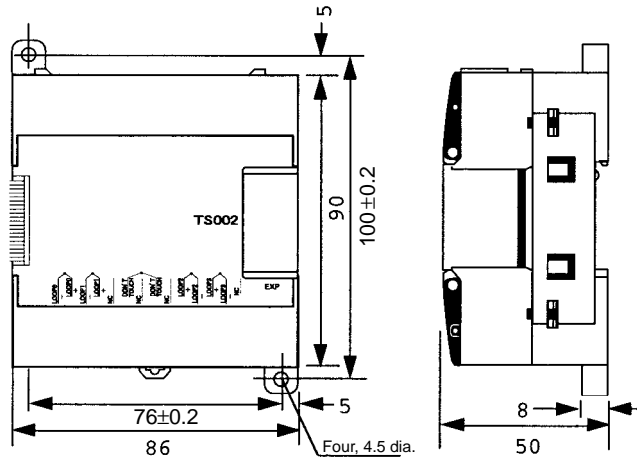

CPM1A-SRT21 CompoBus/S I/O Link Unit

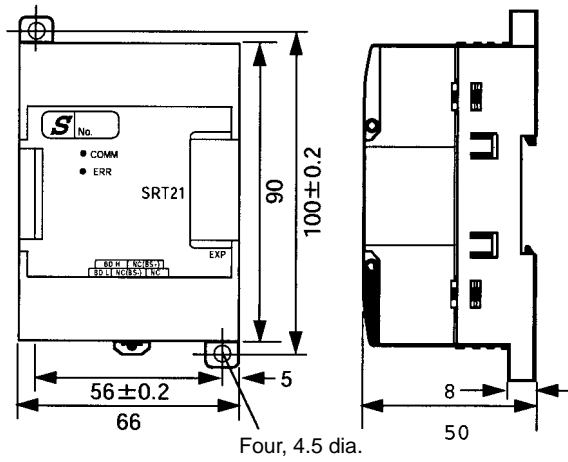

### CPM1-CIF01 (RS-232C Adapter)

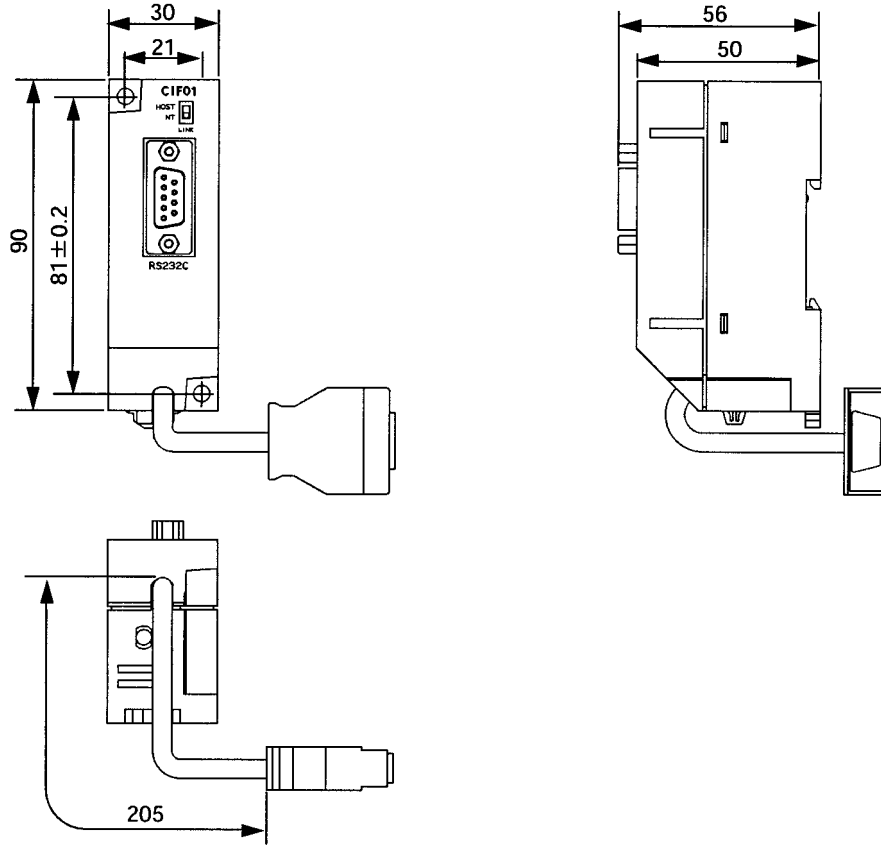



### CPM1-CIF11 (RS-422 Adapter)

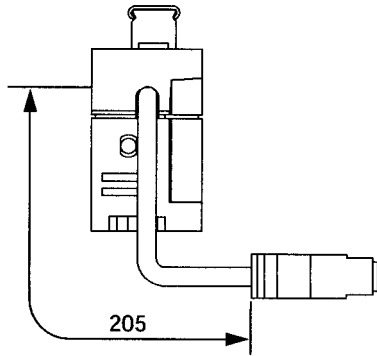
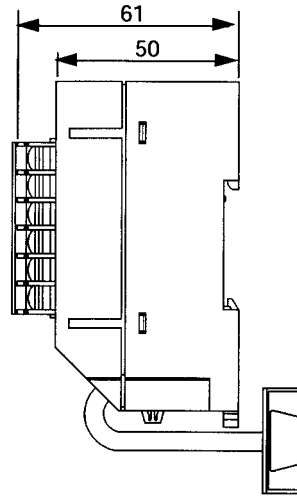
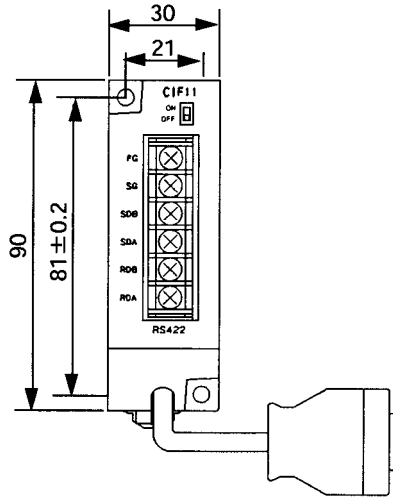

### Dimensions with Programming Devices Attached

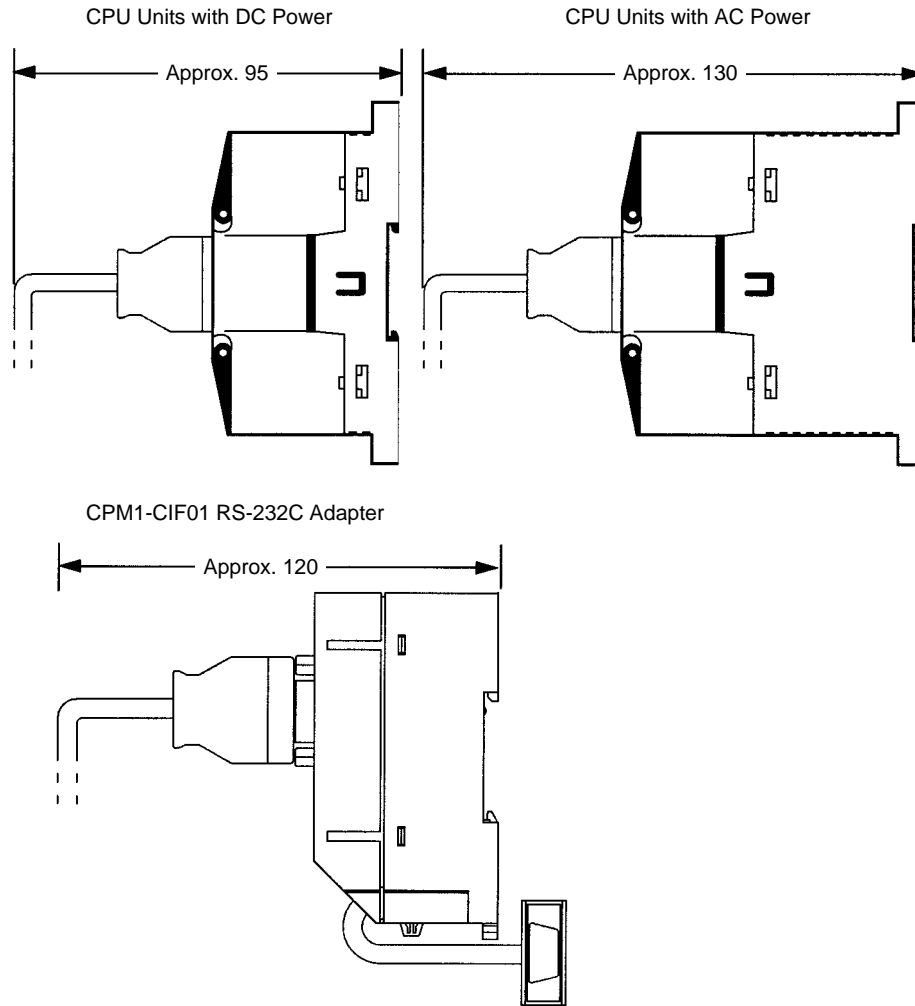

# Index

## Numbers

- 1:1 communications, 77
- 1:N communications, 79

## A

- Analog I/O Unit, standard model, 160
- analog volume controls, location, 37
- arc killer, examples, xvii
- ASCII, converting displays, Programming Console, 122
- atmosphere, 28

## B

- battery, replacing, 146
- binary data, modifying, Programming Console, 119
- bit status, force-set/reset, Programming Console, 121
- bits, searching, Programming Console, 109
- buzzer operation, Programming Console, 103

## C

- cabinet
  - installation, precautions, 45
  - Programming Console installation, 98
- cables, available models, 160
- characteristics, 29
- check levels, program checks, 136
- checking, program syntax, Programming Console, 111
- circuit configuration
  - inputs, 31
  - outputs, relay, 33
- clearing, memory areas, Programming Console, 102
- clock, reading and setting the clock, 123
- communication errors, 135
- communications capabilities, 18
  - overview, 4
- CompoBus/S I/O Link, 81
- CompoBus/S I/O Unit, standard model, 160
- components
  - Analog I/O Unit, 39
  - CompoBus/S I/O Link Unit, 41
  - CPU Unit, 35
  - Expansion I/O Unit, 38
  - Temperature Sensor Unit, 39

- computer, connecting, 77
- conduit installation, 50
- counters
  - changing SV, Programming Console, 117
  - example of inputting, 127
- CPM1A, function comparison, 18
- CPU Units
  - available models, 8, 159
  - cyclic operation, 13
  - internal structure, 10
  - standard models, 159
- cycle time, displaying, Programming Console, 123
- cyclic operation, 13

## D

- data, modifying, Programming Console, 116–117, 118, 119, 120
- data link, 5, 81
- date. *See* clock
- decimal data with sign. *See* signed decimal data
- decimal data without sign. *See* unsigned decimal data
- dielectric strength, 28
- differentiated instructions, entering, 107
- dimensions, 163
- DIN Track installation, 47
- displays
  - converting between hex and ASCII, Programming Console, 122
  - cycle time, Programming Console, 123
- downloading, programs, 155
- duct installation, 49

## E

- EC Directives, precautions, xv
- EEPROM
  - mounting/removing, 152
  - specifications, 151
- electrical noise, preventing, 45, 49
- ERR/ALM indicator
  - flashing, 134
  - lit, 135
- errors
  - communications, 135
  - error processing, 131
  - fatal, 135
  - identifying, 133
  - non-fatal, 134

- programming, 136
- Programming Console operations, 136
- reading/clearing messages, Programming Console, 103
- user-defined errors, 134

- Expansion I/O Units
  - available models, 9, 159
  - components, 38
  - connection, 48
  - standard models, 159

- expansion instructions, reading and changing function code assignments, 104

- Expansion Memory Unit, 149
  - connections, 153

- Expansion Units
  - available models, 9, 160
  - connection, 48

## **F**

- FAL numbers, 134

- FAL(06), 134

- FALS numbers, 135

- FALS(07), 134

- false inputs, 61

- fatal errors, troubleshooting, 139

- features, 2

- flash memory, precautions, 132

- flicker output, example, 128

- force-set/reset
  - clearing, Programming Console, 122
  - Programming Console, 121

- function codes, reading and changing expansion instruction assignments, 104

- functions, 7

## **G–H**

- grounding, 36, 51

- hexadecimal data, converting displays, Programming Console, 122

- Host Link, connections, 77

## **I**

- I/O capacity, 29

- I/O errors, troubleshooting, 141

- I/O line noise, preventing, 49

- indicators
  - CompoBus/S LED indicators, 41
  - flashing ERR/ALM indicator, 134
  - lit ERR/ALM indicator, 135

- PC status indicators, 36

- inductive loads, 61, 75

- initialization, time required, 12

- input devices, connecting, 59

- input specifications, 31, 32

- inputs, wiring, 54
  - configuration, 54

- inrush current, suppressing, 75

- inspections, 145

- installation, 46
  - site, selecting, 44

- instructions
  - inserting and deleting, Programming Console, 110
  - searching, Programming Console, 108

- insulation resistance, 28

- interlocks, 44

- interrupt program execution, in cyclic operation, 15

## **L–M**

- leakage current, 61

- limit switches, preventing false inputs, 61

- machine control functions, list, 16

- maintenance, 145

- memory
  - backup, 30
  - Expansion Memory Unit, 149
  - protection, 30

- memory areas
  - clearing, Programming Console, 102
  - partial clear, 102
  - uploading/downloading, 150

- messages, reading/clearing, 103

- mode, changing the PC mode, 97

- model numbers, 159

- modes, operating modes, 11

- modifying
  - binary data, Programming Console, 119
  - data, Programming Console, 116
  - hexadecimal/BCD data, Programming Console, 118
  - signed decimal data, Programming Console, 119
  - SV, Programming Console, 117
  - unsigned decimal data, Programming Console, 120

- MONITOR mode
  - description, 89, 97
  - example test run, 129

- monitoring
  - 3-word monitor, Programming Console, 115
  - binary monitor, Programming Console, 114–115
  - differentiation monitor, Programming Console, 113–114
  - signed decimal monitor, Programming Console, 115–116
  - status, Programming Console, 111
  - unsigned decimal monitor, Programming Console, 116

- motor control, capabilities, 3

- MSG(46), 134

## N

no-protocol communications, 80  
noise, preventing electrical noise, 45, 49  
noise immunity, 28  
non-fatal errors, troubleshooting, 140  
NPN current output, connecting, 59  
NPN open collector, connecting, 59  
NT Link, connections, 80

## O

operating conditions, troubleshooting, 143  
operating modes, 11  
    operating mode at startup, 11  
operation, preparations, 99  
output short protection, 74  
output specifications  
    relay output, 33  
    transistor output, sink type, 34  
output wiring  
    configuration, 63, 66, 70  
    relay output, 62  
    transistor output  
        sink type, 66  
        source type, 70

## P

panel, Programming Console installation, 98  
panel installation, precautions, 45  
password, entering on Programming Console, 99  
PC mode, changing, 97  
PC Status, indicators, 36  
Peripheral Devices, 162  
    available models, 162  
photoelectric switches, preventing false inputs, 61  
PNP current output, connecting, 59  
position control, 3  
power, consumption, 28  
power cables, 49  
power interruption, detection, 12  
power supply  
    capacity, 28  
    interrupt time, 28  
    precautions, 44  
    troubleshooting, 138, 144  
    wiring, 52  
precautions  
    design precautions, 44

    general, xi  
    uploading/downloading, 150  
program, programming example, 124  
program capacity, 29  
program execution, in cyclic operation, 14  
program memory, setting address and reading content, Programming Console, 105  
PROGRAM mode, description, 89, 97  
programming  
    checking the program, 129  
    checks for syntax, Programming Console, 111  
    errors, 136  
    inserting and deleting instructions, Programming Console, 110–111  
    preparation for, 124  
    searching, Programming Console, 108–109  
    setting and reading a memory address, Programming Console, 105  
Programming Console  
    connecting, 76, 98  
    keys, 95  
    models, 95  
    operations, 101  
Programming Devices  
    connecting, 76  
    using, 83  
programming example, 124  
programs  
    checking, check levels, 136  
    downloading, 155  
    entering and editing, Programming Console, 105  
    uploading, 154  
proximity switches, preventing false inputs, 61  
pulse control, 3  
pulse outputs, 3  
    wiring, 74

## Q–R

quick-response inputs, 4  
relay outputs, connecting, 59  
RUN mode, description, 89, 97

## S

search  
    instruction, Programming Console, 108–109  
    operands, Programming Console, 109  
self-diagnosis functions, 30  
self-holding bit, example, 126  
self-diagnostic functions, 133  
serial communications, 80  
shock resistance, 28  
signed decimal data

- modifying, Programming Console, 119
- monitoring, 115–116
- specifications
  - characteristics, 29
  - Expansion Memory Unit, 151
  - general specifications, 28
  - input specifications, 31, 32
  - output specifications
    - relay output, 33
    - transistor output, sink type, 34
- SSS, 92
- status, monitoring, Programming Console, 111
- Support Software, 76, 84
- SV, modifying, Programming Console, 117
- syntax, checking the program, Programming Console, 111
- SYSMAC Support Software, 76
  - See also* SSS
  - precautions, 92
- SYSMAC-CPT Support Software, 76, 84
  - precautions, 84
- system, checks, 132
- system configuration, 8

## T

- temperature, operating, storage, 28
- Temperature Sensor Units
  - precautions, xv
  - standard models, 160
- temperature, ambient, 28
- terminal block, removing, 50

- terminals, screw size, 28
- test run
  - example, 129
  - procedure, 132
- time. *See* clock
- timers
  - changing SV, Programming Console, 117
  - example of inputting, 127
- troubleshooting, 137
  - fatal errors, 139
  - I/O errors, 141
  - non-fatal errors, 140
  - operating conditions, 143
  - power supply, 138, 144

## U–W

- unsigned decimal data
  - modifying, Programming Console, 120
  - monitoring, 116
- uploading, programs, 154
- vibration resistance, 28
- voltage
  - operating voltage range, 28
  - supply voltage, 28
- voltage output, connecting, 59
- weight
  - CPU Unit, 28
  - Expansion I/O Unit, 28
  - Expansion Unit, 28
- wiring, 49
  - power supply, 52

## Revision History

A manual revision code appears as a suffix to the catalog number on the front cover of the manual.

Cat. No. W352-E1-3

↑  
Revision code

The following table outlines the changes made to the manual during each revision. Page numbers refer to the previous version.

Revision code	Date	Revised content
1	April 1999	Original production
2	September 1999	Information relating to 20-point CPU Units added throughout the manual. Information relating to the CPM1-EMU01-V1 Expansion Memory Unit added throughout the manual.
3	December 1999	Information relating to Temperature Sensor Units added throughout the manual.